

FCC TEST REPORT

FCC ID: 2AL8Y-X4Q

Report Number..... : ZKT-221125L8872-03

Date of Test..... : Nov. 16, 2022 – Nov. 30, 2022

Date of issue : Nov. 30, 2022

Total number of pages : 75

Test Result : PASS

Testing Laboratory..... : **Shenzhen ZKT Technology Co., Ltd.**

Address : 1/F, No. 101, Building B, No. 6, Tangwei Community Industrial Avenue, Fuhai Street, Bao'an District, Shenzhen, China

Applicant's name : Shenzhen Ugoos Technology Co., Ltd

Address : Room 6A, 6th Floor, Building A, Bao'an Square, Sun'gang Road, Luohu District, Shenzhen 518020, China

Manufacturer's name : Shenzhen Ugoos Technology Co., Ltd

Address : Room 6A, 6th Floor, Building A, Bao'an Square, Sun'gang Road, Luohu District, Shenzhen 518020, China

Test specification:

Standard : FCC CFR Title 47 Part 15 Subpart C Section 15.247
ANSI C63.10:2013

Test procedure..... : KDB558074 D0115.247 Meas Guidance v 05r02

Non-standard test method : N/A

Test Report Form No. : TRF-EL-110_V0

Test Report Form(s) Originator : ZKT Testing

Master TRF : Dated: 2020-01-06

This device described above has been tested by ZKT, and the test results show that the equipment under test (EUT) is in compliance with the FCC requirements. And it is applicable only to the tested sample identified in the report.

This report shall not be reproduced except in full, without the written approval of ZKT, this document may be altered or revised by ZKT, personal only, and shall be noted in the revision of the document.

Product name..... : Android TV Box

Trademark : UGOOS

Model/Type reference : X4Q Pro, X4Q Cube, X4Q Plus, X4Q Max

Ratings..... : DC5.0V 2.5A from adapter

Testing procedure and testing location:

Testing Laboratory.....: **Shenzhen ZKT Technology Co., Ltd.**

Address.....: 1/F, No. 101, Building B, No. 6, Tangwei Community
Industrial Avenue, Fuhai Street, Bao'an District,
Shenzhen, China

Tested by (name + signature).....: Alen He

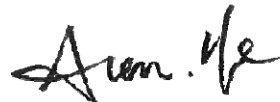

Reviewer (name + signature).....: Joe Liu

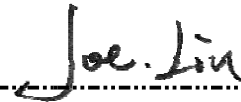

Approved (name + signature).....: Lake Xie



Table of Contents

	Page
1. VERSION	5
2. SUMMARY OF TEST RESULTS	6
2.1 TEST FACILITY	6
2.2 MEASUREMENT UNCERTAINTY	6
3. GENERAL INFORMATION	7
3.1 GENERAL DESCRIPTION OF EUT	7
3.2 DESCRIPTION OF TEST MODES	8
3.3 BLOCK DIGRAM SHOWING THE CONFIGURATION OF SYSTEM TESTED	8
3.4 DESCRIPTION OF SUPPORT UNITS(CONDUCTED MODE)	9
3.5EQUIPMENTS LIST FOR ALL TEST ITEMS	10
4. EMC EMISSION TEST	11
4.1 CONDUCTED EMISSION MEASUREMENT	11
4.1.1 POWER LINE CONDUCTED EMISSION LIMITS	11
4.1.2 TEST PROCEDURE	11
4.1.3 DEVIATION FROM TEST STANDARD	11
4.1.4 TEST SETUP	12
4.1.5 EUT OPERATING CONDITIONS	12
4.1.6 TEST RESULT	13
4.2 RADIATED EMISSION MEASUREMENT	15
4.2.1 RADIATED EMISSION LIMITS	15
4.2.2 TEST PROCEDURE	15
4.2.3 DEVIATION FROM TEST STANDARD	16
4.2.4 TEST SETUP	16
4.2.5 EUT OPERATING CONDITIONS	17
4.2.6 TEST RESULTS	17
5.RADIATED BAND EMISSIONMEASUREMENT	28
5.1 TEST REQUIREMENT:	28
5.2 TEST PROCEDURE	28
5.3 DEVIATION FROM TEST STANDARD	28
5.4 TEST SETUP	29
5.5 EUT OPERATING CONDITIONS	29
5.6 TEST RESULT	30
6.POWER SPECTRAL DENSITY TEST	33
6.1 APPLIED PROCEDURES / LIMIT	33
6.2 TEST PROCEDURE	33
6.3 DEVIATION FROM STANDARD	33
6.4 TEST SETUP	33
6.5 EUT OPERATION CONDITIONS	33

6.6 TEST RESULT	33
7. CHANNEL BANDWIDTH	34
7.1 APPLIED PROCEDURES / LIMIT	34
7.2 TEST PROCEDURE	34
7.3 DEVIATION FROM STANDARD	34
7.4 TEST SETUP	34
7.5 EUT OPERATION CONDITIONS	34
7.6 TEST RESULT	34
8. OUTPUT POWER TEST	35
8.1 APPLIED PROCEDURES/LIMIT	35
8.2 TEST PROCEDURE	35
8.3 DEVIATION FROM STANDARD	35
8.4 TEST SETUP	35
8.5 EUT OPERATION CONDITIONS	35
8.6 TEST RESULT	35
9. CONDUCTED BAND EDGE AND SPURIOUS EMISSION	36
9.1 APPLICABLE STANDARD	36
9.2 TEST PROCEDURE	36
9.3 DEVIATION FROM STANDARD	36
9.4 TEST SETUP	36
9.5 EUT OPERATION CONDITIONS	36
9.6 TEST RESULTS	36
10. ANTENNA REQUIREMENT	37
11.1. -6DB BANDWIDTH	38
11.3. BANDEDGE	45
11.4. MAX. OUTPUT POWER	54
11.5. POWER SPECTRAL DENSITY	55
11.6. SPURIOUS EMISSION	62
12. TEST SETUP PHOTO	75
13. EUT CONSTRUCTIONAL DETAILS	75

1. VERSION

Report No.	Version	Description	Approved
ZKT-221125L8872-03	Rev.01	Initial issue of report	Nov. 30, 2022

2. SUMMARY OF TEST RESULTS

Test procedures according to the technical standards:

FCC Part15 (15.247) , Subpart C			
Standard Section	Test Item	Result	Remark
FCC part 15.203/15.247 (c)	Antenna requirement	PASS	
FCC part 15.207	AC Power Line Conducted Emission	PASS	
FCC part 15.247 (b)(3)	Conducted Peak Output Power	PASS	
FCC part 15.247 (a)(2)	Channel Bandwidth& 99% OCB	PASS	
FCC part 15.247 (e)	Power Spectral Density	PASS	
FCC part 15.247(d)	Band Edge	PASS	
FCC part 15.205/15.209	Spurious Emission	PASS	

NOTE:

(1)" N/A" denotes test is not applicable in this Test Report

2.1 TEST FACILITY

Shenzhen ZKT Technology Co., Ltd.

Add. : 1/F, No. 101, Building B, No. 6, Tangwei Community Industrial Avenue, Fuhai Street, Bao'an District, Shenzhen, China

FCC Test Firm Registration Number: 692225

Designation Number: CN1299

IC Registered No.: 27033

2.2 MEASUREMENT UNCERTAINTY

The reported uncertainty of measurement $y \pm U$, where expanded uncertainty U is based on a standard uncertainty multiplied by a coverage factor of $k=2$, providing a level of confidence of approximately 95 %.

No.	Item	Uncertainty
1	Conducted Emission Test	$\pm 1.38\text{dB}$
2	RF power conducted	$\pm 0.16\text{dB}$
3	Spurious emissions conducted	$\pm 0.21\text{dB}$
4	All emissions radiated(<1G)	$\pm 4.68\text{dB}$
5	All emissions radiated(>1G)	$\pm 4.89\text{dB}$
6	Temperature	$\pm 0.5\text{C}$
7	Humidity	$\pm 2\%$

3. GENERAL INFORMATION

3.1 GENERAL DESCRIPTION OF EUT

Product Name:	Android TV Box
Model No.:	X4Q Pro
Serial No.:	X4Q Cube, X4Q Plus, X4Q Max
Model difference:	All models are consistent in design, circuit layout, wiring and bom, but the internal running software will be different due to the needs of different customers, but these differences will not affect any electrical performance and RF parameters, so the test model is: X4Q Pro
Hardware Version:	V1.0
Software Version:	V1.0
Sample(s) Status:	Engineer sample
Frequency range:	802.11b/802.11g /802.11n(HT20): 2412MHz -2462MHz
Channel numbers:	802.11b/802.11g /802.11n(HT20):11
Channel separation:	5MHz
Modulation technology:	802.11b: Direct Sequence Spread Spectrum(DSSS) 802.11g/802.11n(H20): Orthogonal Frequency Division Multiplexing(OFDM)
Antenna Type:	PCB antenna
Antenna gain:	ANT1:3.39dBi; ANT2:1.26dBi; MIMO:5.4dBi
Power supply:	DC5.0V 2.5A from adapter

Note: MIMO Gain= $10 \cdot \log[(10^{G1/20} + 10^{G2/20} + \dots)^2 / N_{ant}]$ dBi

Operation Frequency each of channel							
Channel	Frequency	Channel	Frequency	Channel	Frequency	Channel	Frequency
1	2412MHz	4	2427MHz	7	2442MHz	10	2457MHz
2	2417MHz	5	2432MHz	8	2447MHz	11	2462MHz
3	2422MHz	6	2437MHz	9	2452MHz	X	

Note:

In section 15.31(m), regards to the operating frequency range over 10 MHz, the Lowest frequency, the middle frequency, and the highest frequency of channel were selected to perform the test, and the selected channel see below:

Test channel	Frequency (MHz)
	802.11b/802.11g /802.11n(HT20)
Lowest channel	2412MHz
Middle channel	2437MHz
Highest channel	2462MHz

Worst Case Configuration

Description	MIMO (802.11N-HT20)
Antenna	MIMO
Channel	1

Data Rate (Mbps)	MCS7
------------------	------

3.2 DESCRIPTION OF TEST MODES

Transmitting mode	Keep the EUT in continuously transmitting mode
<p>Remark: During the test, the duty cycle >98%, the test voltage was tuned from 85% to 115% of the nominal rated supply voltage, and found that the worst case was under the nominal rated supply condition. So the report just shows that condition's data.</p>	

<p>We have verified the construction and function in typical operation. All the test modes were carried out with the EUT in transmitting operation, which was shown in this test report and defined as follows:</p>				
<p>Pre-scan all kind of data rate in lowest channel, and found the follow list which it was worst case.</p>				
Mode	802.11b	802.11g	802.11n (HT20)	802.11n (HT40)
Data rate	11Mbps	54Mbps	MCS7	MCS7

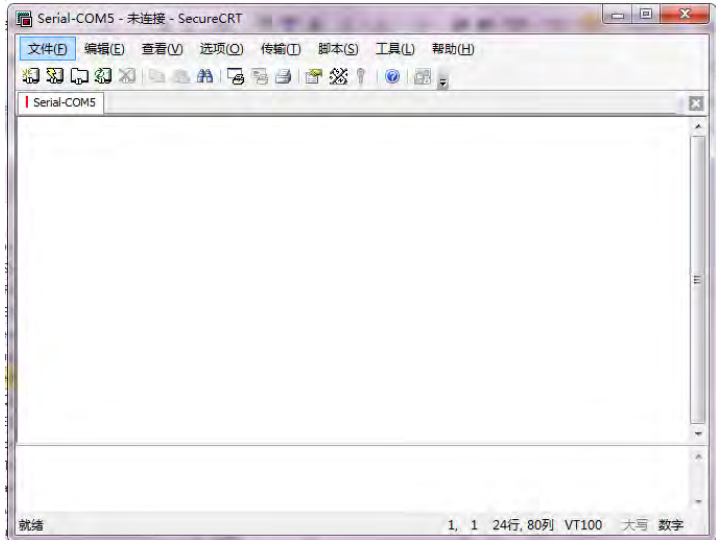
Test Software	<p>BT Test Tool</p> 
Power level setup	<10dBm

3.3 BLOCK DIGRAM SHOWING THE CONFIGURATION OF SYSTEM TESTED

Conducted Emission



Radiated Emission

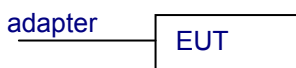

Conducted Spurious

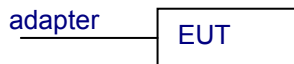

3.4 DESCRIPTION OF SUPPORT UNITS(CONDUCTED MODE)

The EUT has been tested as an independent unit together with other necessary accessories or support units. The following support units or accessories were used to form a representative test configuration during the tests.

Item	Equipment	Mfr/Brand	Model/Type No.	Series No.	Note
1	adapter	Shenzhen Rongweixin Electronics Co.,Ltd.	R122-0502500UD	/	SDOC
2					

Item	Shielded Type	Ferrite Core	Length	Note

Note:

- (1) The support equipment was authorized by Declaration of Confirmation.
- (2) For detachable type I/O cable should be specified the length in cm in 『Length』 column.

3.5EQUIPMENTS LIST FOR ALL TEST ITEMS

Radiation Test equipment

Item	Equipment	Manufacturer	Type No.	Serial No.	Last calibration	Calibrated until
1	Spectrum Analyzer (9kHz-26.5GHz)	KEYSIGHT	9020A	MY55370835	Oct. 18, 2022	Oct. 17, 2023
2	Spectrum Analyzer (1GHz-40GHz)	R&S	FSQ	100363	Oct. 17, 2022	Oct. 16, 2023
3	EMI Test Receiver (9kHz-7GHz)	R&S	ESCI7	101169	Oct. 18, 2022	Oct. 17, 2023
4	Bilog Antenna (30MHz-1500MHz)	Schwarzbeck	VULB9168	N/A	Oct. 17, 2022	Oct. 16, 2023
5	Horn Antenna (1GHz-18GHz)	Agilent	AH-118	071145	Oct. 17, 2022	Oct. 16, 2023
6	Loop Antenna	TESEQ	HLA6121	58357	Oct. 17, 2022	Oct. 16, 2023
7	Amplifier (30-1000MHz)	EM Electronics	EM330 Amplifier	060747	Oct. 17, 2022	Oct. 16, 2023
8	Amplifier (1GHz-26.5GHz)	Agilent	8449B	3008A00315	Oct. 18, 2022	Oct. 17, 2023
9	RF cables1 (9kHz-30MHz)	N/A	9kHz-30MHz	N/A	Oct. 18, 2022	Oct. 17, 2023
10	RF cables2 (30MHz-1GHz)	N/A	30MHz-1GHz	N/A	Oct. 18, 2022	Oct. 17, 2023
11	RF cables3 (1GHz-40GHz)	N/A	1GHz-40GHz	N/A	Oct. 18, 2022	Oct. 17, 2023
12	ESG Signal Generator	Agilent	E4421B	N/A	Oct. 18, 2022	Oct. 17, 2023
13	Signal Generator	Agilent	N5182A	N/A	Oct. 22, 2022	Oct. 21, 2023
14	Magnetic Field Probe Tester	Narda	ELT-400	0-0344	Oct. 17, 2022	Oct. 16, 2023
15	MWRF Power Meter Test system	MW	MW100-RPC B	N/A	Oct. 22, 2022	Oct. 21, 2023
16	Power sensor	KEYSIGHT	U200H	MY51190005	Oct. 22, 2022	Oct. 21, 2023
17	D.C. Power Supply	LongWei	TPR-6405D	N/A	\	\
18	EMC Software	Frad	EZ-EMC	Ver.EMC-CON 3A1.1	\	\
19	RF Software	MW	MTS8310	V2.0.0.0	\	\
20	Turntable	MF	MF-7802BS	N/A	\	\
21	Antenna tower	MF	MF-7802BS	N/A	\	\

Conduction Test equipment

Item	Kind of Equipment	Manufacturer	Type No.	Serial No.	Last calibration	Calibrated until
1	LISN	R&S	ENV216	101471	Oct. 22, 2022	Oct. 21, 2023
2	LISN	CYBERTEK	EM5040A	E1850400149	Oct. 22, 2022	Oct. 21, 2023
3	Test Cable	N/A	C01	N/A	Oct. 18, 2022	Oct. 17, 2023
4	Test Cable	N/A	C02	N/A	Oct. 18, 2022	Oct. 17, 2023
5	EMI Test Receiver	R&S	ESCI3	101393	Oct. 17, 2022	Oct. 16, 2023
6	EMC Software	Frad	EZ-EMC	Ver.EMC-CON 3A1.1	\	\

4. EMC EMISSION TEST

4.1 CONDUCTED EMISSION MEASUREMENT

Test Requirement:	FCC Part15 C Section 15.207
Test Method:	ANSI C63.10:2013
Test Frequency Range:	150KHz to 30MHz
Receiver setup:	RBW=9KHz, VBW=30KHz, Sweep time=auto

4.1.1 POWER LINE CONDUCTED EMISSION LIMITS

FREQUENCY (MHz)	Limit (dBuV)		Standard
	Quasi-peak	Average	
0.15 -0.5	66 - 56 *	56 - 46 *	FCC
0.50 -5.0	56.00	46.00	FCC
5.0 -30.0	60.00	50.00	FCC

Note:

(1) *Decreases with the logarithm of the frequency.

4.1.2 TEST PROCEDURE

1. The equipment was set up as per the test configuration to simulate typical actual usage per the user's manual. The EUT is a tabletop system; a wooden table with a height of 0.8 meters is used and is placed on the ground plane as per ANSI C63.10:2013.
2. Support equipment, if needed, was placed as per ANSI C63.10:2013
3. All I/O cables were positioned to simulate typical actual usage as per ANSI C63.10:2013.
4. The adapter received AC120V/60Hz power through a Line Impedance Stabilization Network (LISN) which supplied power source and was grounded to the ground plane.
5. All support equipments received AC power from a second LISN, if any.
6. The EUT test program was started. Emissions were measured on each current carrying line of the EUT using a spectrum Analyzer / Receiver connected to the LISN powering the EUT. The LISN has two monitoring points: Line 1 (Hot Side) and Line 2 (Neutral Side). Two scans were taken: one with Line 1 connected to Analyzer / Receiver and Line 2 connected to a 50 ohm load; the second scan had Line 1 connected to a 50 ohm load and Line 2 connected to the Analyzer / Receiver.
7. Analyzer / Receiver scanned from 150 KHz to 30MHz for emissions in each of the test modes.e.
- 8 For the actual test configuration, please refer to the related Item –EUT Test Photos.

4.1.3 DEVIATION FROM TEST STANDARD

No deviation

4.1.4 TEST SETUP

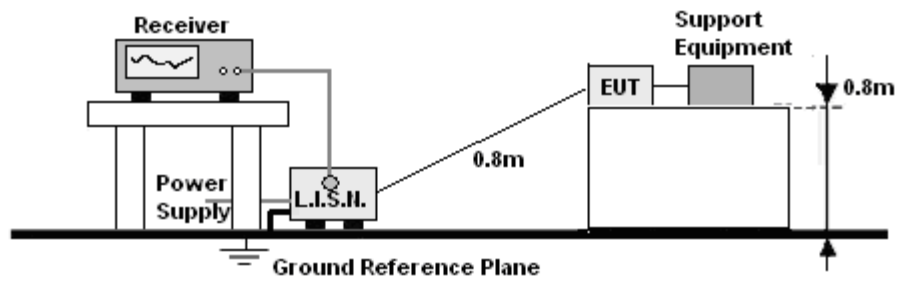

4.1.5 EUT OPERATING CONDITIONS

The EUT was configured for testing in a typical fashion (as a customer would normally use it). The EUT has been programmed to continuously transmit during test. This operating condition was tested and used to collect the included data.

We pretest AC 120V and AC 240V, the worst voltage was AC 120V and the data recording in the report.

4.1.6 TEST RESULT

Temperature :	26°C	Relative Humidity:	54%
Pressure :	101kPa	Phase	L
Test Voltage :	AC 120V/60Hz		

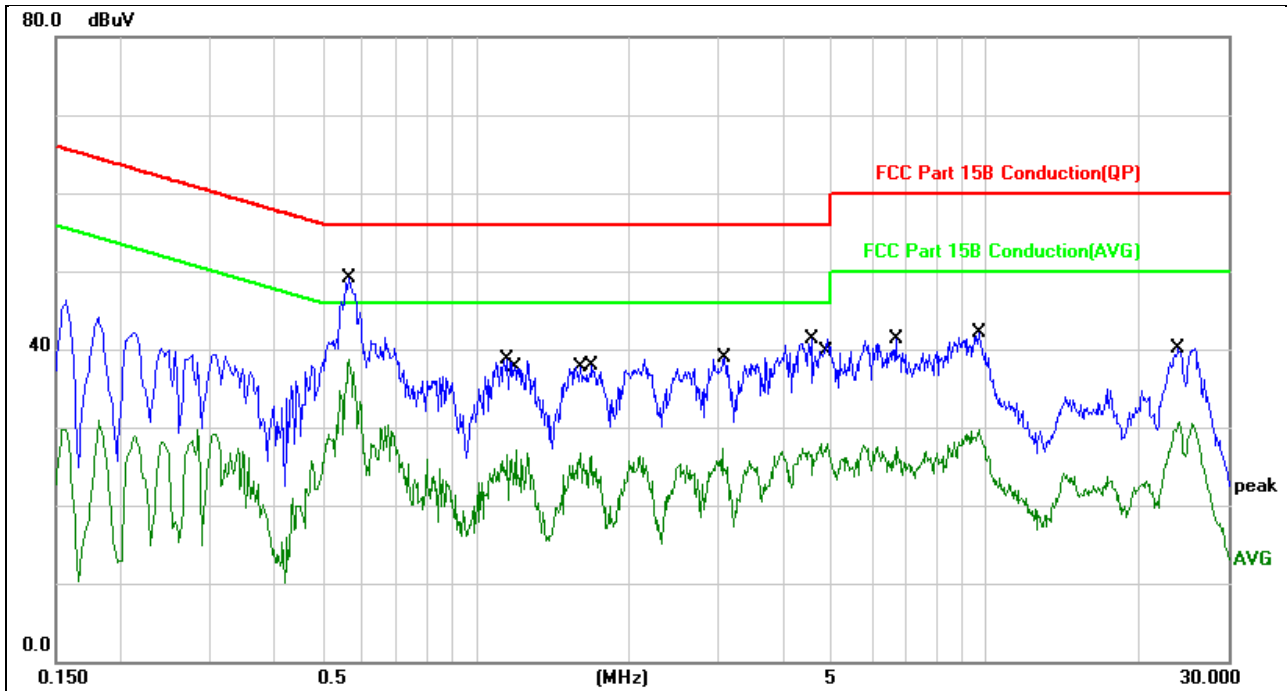

No.	Mk.	Freq. MHz	Reading Level dBuV	Correct Factor dB	Measure- ment dBuV	Limit dBuV	Over dB	Detector	Comment
1	*	0.5660	38.80	10.21	49.01	56.00	-6.99	QP	
2		0.5660	28.50	10.21	38.71	46.00	-7.29	AVG	
3		1.1500	28.62	10.15	38.77	56.00	-17.23	QP	
4		1.2020	16.92	10.15	27.07	46.00	-18.93	AVG	
5		1.6100	16.68	10.09	26.77	46.00	-19.23	AVG	
6		1.6940	27.78	10.08	37.86	56.00	-18.14	QP	
7		3.0420	17.50	9.86	27.36	46.00	-18.64	AVG	
8		4.5580	31.46	9.90	41.36	56.00	-14.64	QP	
9		4.7500	18.05	9.93	27.98	46.00	-18.02	AVG	
10		6.6780	31.35	9.89	41.24	60.00	-18.76	QP	
11		9.7060	32.15	9.92	42.07	60.00	-17.93	QP	
12		24.0700	20.91	9.74	30.65	50.00	-19.35	AVG	

Notes:

1. An initial pre-scan was performed on the line and neutral lines with peak detector.
2. Quasi-Peak and Average measurement were performed at the frequencies with maximized peak emission.
3. Measurement Level = Reading level + Correct Factor

Temperature :	26°C	Relative Humidity:	54%
Pressure :	101kPa	Phase :	N
Test Voltage :	AC 120V/60Hz		

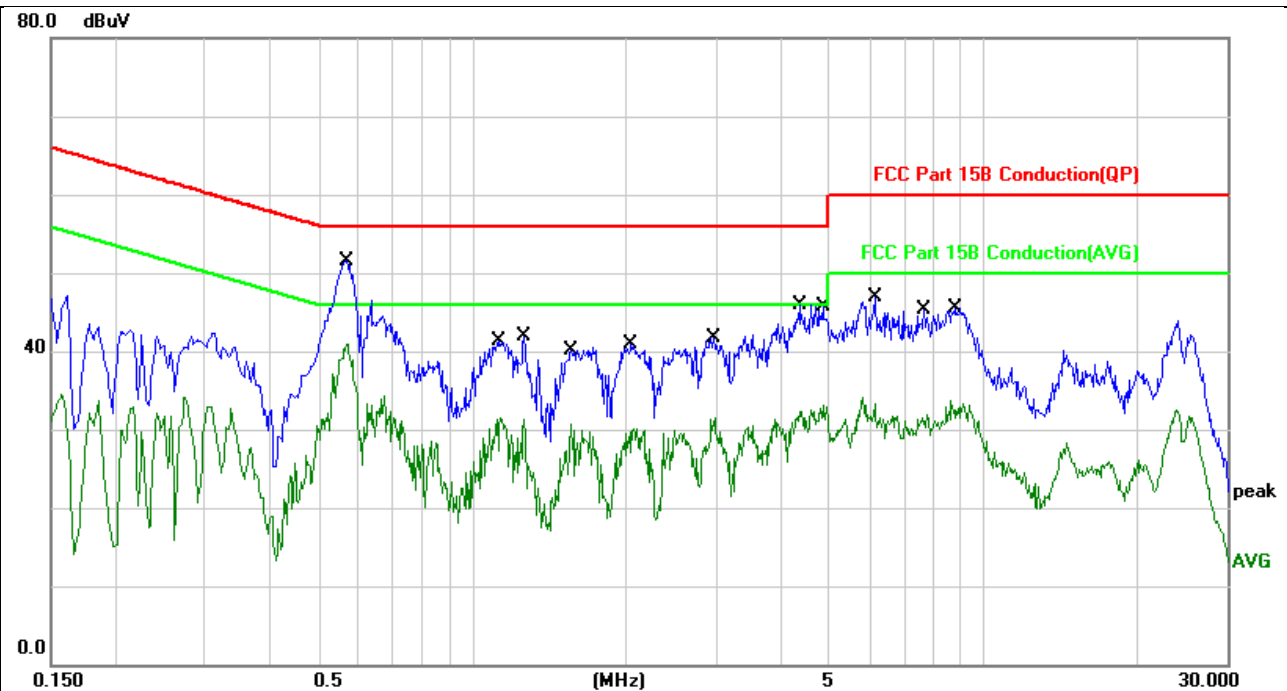

No.	Mk.	Freq. MHz	Reading Level dBuV	Correct Factor dB	Measure- ment dBuV	Limit dBuV	Over dB	Detector	Comment
1	*	0.5700	41.39	10.21	51.60	56.00	-4.40	QP	
2		0.5700	30.72	10.21	40.93	46.00	-5.07	AVG	
3		1.1380	21.33	10.16	31.49	46.00	-14.51	AVG	
4		1.2660	31.80	10.14	41.94	56.00	-14.06	QP	
5		1.5620	20.59	10.09	30.68	46.00	-15.32	AVG	
6		2.0660	20.05	10.03	30.08	46.00	-15.92	AVG	
7		2.9860	21.61	9.87	31.48	46.00	-14.52	AVG	
8		4.3620	36.07	9.87	45.94	56.00	-10.06	QP	
9		4.8620	23.07	9.95	33.02	46.00	-12.98	AVG	
10		6.1260	37.04	9.92	46.96	60.00	-13.04	QP	
11		7.6500	35.44	9.86	45.30	60.00	-14.70	QP	
12		8.8260	35.59	9.94	45.53	60.00	-14.47	QP	

Notes:

1. An initial pre-scan was performed on the line and neutral lines with peak detector.
2. Quasi-Peak and Average measurement were performed at the frequencies with maximized peak emission.
3. Measurement Level = Reading level + Correct Factor
4. The test data shows only the worst case- MIMO (802.11N-HT20 low channel)

4.2 RADIATED EMISSION MEASUREMENT

Test Requirement:	FCC Part15 C Section 15.209				
Test Method:	ANSI C63.10:2013				
Test Frequency Range:	9kHz to 25GHz				
Test site:	Measurement Distance: 3m				
Receiver setup:	Frequency	Detector	RBW	VBW	Value
	9KHz-150KHz	Quasi-peak	200Hz	600Hz	Quasi-peak
	150KHz-30MHz	Quasi-peak	9KHz	30KHz	Quasi-peak
	30MHz-1GHz	Quasi-peak	120KHz	300KHz	Quasi-peak
	Above 1GHz	Peak	1MHz	3MHz	Peak
		Peak	1MHz	10Hz	Average

4.2.1 RADIATED EMISSION LIMITS

Frequencies (MHz)	Field Strength (micorvolts/meter)	Measurement Distance (meters)
0.009~0.490	2400/F(KHz)	300
0.490~1.705	24000/F(KHz)	30
1.705~30.0	30	30
30~88	100	3
88~216	150	3
216~960	200	3
Above 960	500	3

LIMITS OF RADIATED EMISSION MEASUREMENT

FREQUENCY (MHz)	Limit (dBuV/m) (at 3M)	
	PEAK	AVERAGE
Above 1000	74	54

Notes:

- (1) The limit for radiated test was performed according to FCC PART 15C.
- (2) The tighter limit applies at the band edges.
- (3) Emission level (dBuV/m)=20log Emission level (uV/m).

4.2.2 TEST PROCEDURE

Below 1GHz test procedure as below:

- a. The EUT was placed on the top of a rotating table 0.1 meters above the ground at a 3 meter semi-anechoiccamber. The table was rotated 360 degrees to determine the position of the highest radiation.
- b. The EUT was set 3 meters away from the interference-receiving antenna, which was mounted on the top of variable-height antenna tower.

- c. The antenna height is varied from one meter to four meters above the ground to determine the maximum value of the field strength. Both horizontal and vertical polarizations of the antenna are set to make the measurement.
- d. For each suspected emission, the EUT was arranged to its worst case and then the antenna was tuned to heights from 1 meter to 4 meters (for the test frequency of below 30MHz, the antenna was tuned to heights 1meter) and the rotatable table was turned from 0 degrees to 360 degrees to find the maximum reading.
- e. The test-receiver system was set to Peak Detect Function and Specified Bandwidth with Maximum Hold Mode.
- f. If the emission level of the EUT in peak mode was 10dB lower than the limit specified, then testing could be stopped and the peak values of the EUT would be reported. Otherwise the emissions that did not have 10dB margin would be re-tested one by one using peak, quasi-peak or average method as specified and then reported in a data sheet.

Above 1GHz test procedure as below:

- g. Different between above is the test site, change from Semi- Anechoic Chamber to fully Anechoic Chamber and change form table 0.8 metre to 1.5 metre (Above 18GHz the distance is 1 meter and table is 1.5 metre).
- h. Test the EUT in the lowest channel ,the middle channel ,the Highest channel

Note:

Both horizontal and vertical antenna polarities were tested and performed pretest to three orthogonal axis. The worst case emissions were reported

4.2.3 DEVIATION FROM TEST STANDARD

No deviation

4.2.4 TEST SETUP

(A) Radiated Emission Test-Up Frequency Below 30MHz

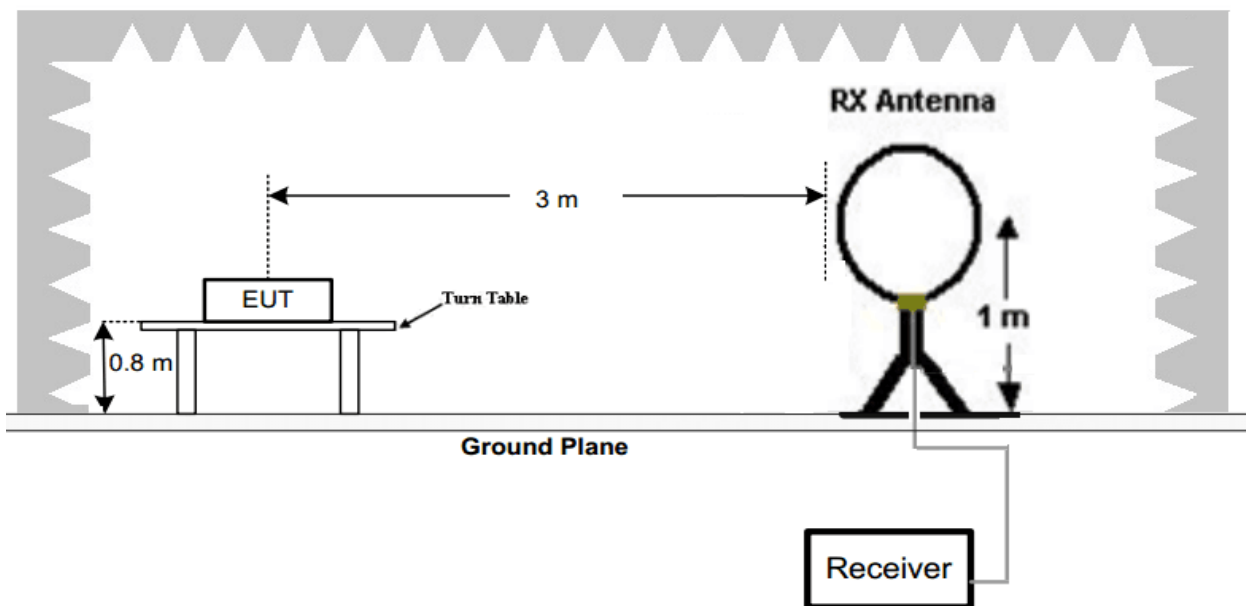

(B) Radiated Emission Test-Up Frequency 30MHz~1GHz

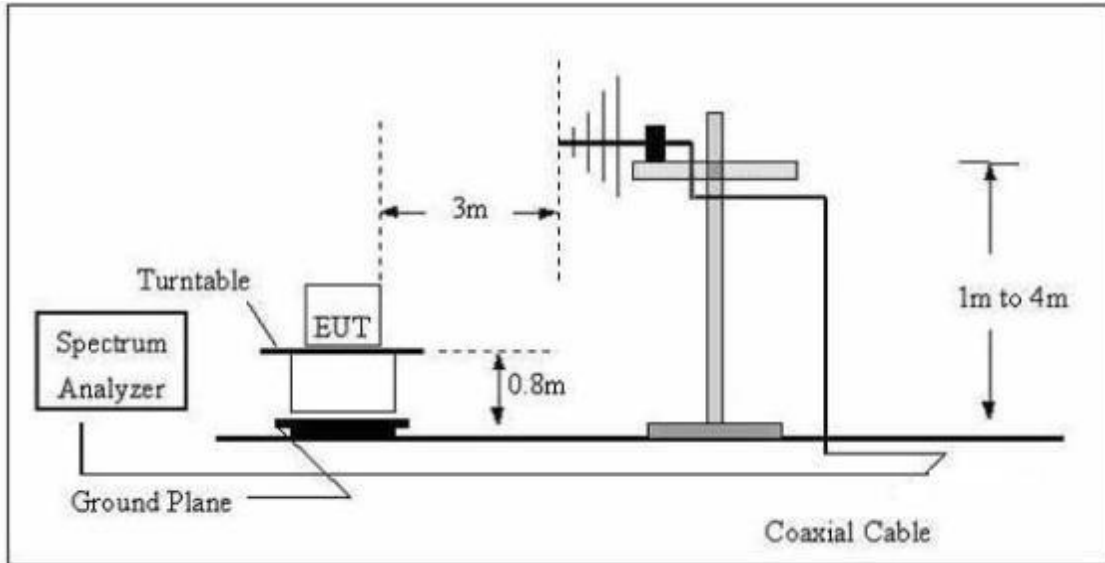

(C) Radiated Emission Test-Up Frequency Above 1GHz

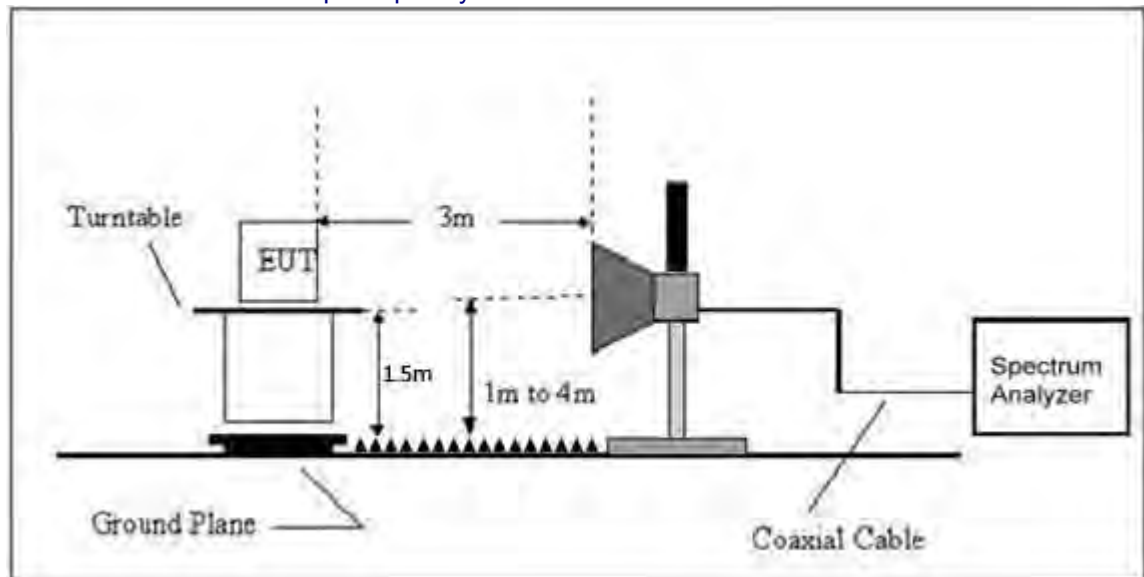

4.2.5 EUT OPERATING CONDITIONS

The EUT tested system was configured as the statements of 2.4 Unless otherwise a special operating condition is specified in the follows during the testing.

4.2.6 TEST RESULTS

Between 9KHz – 30MHz

The emission from 9 kHz to 30MHz was pre-tested and found the result was 20dB lower than the limit, and according to 15.31(o) & RSS-Gen 6.13, the test result no need to reported.

Between 30MHz – 1GHz

Temperature:	26°C	Relative Humidity:	54%
Pressure:	101 kPa	Polarization:	Horizontal
Test Voltage:	AC 120V/60Hz		

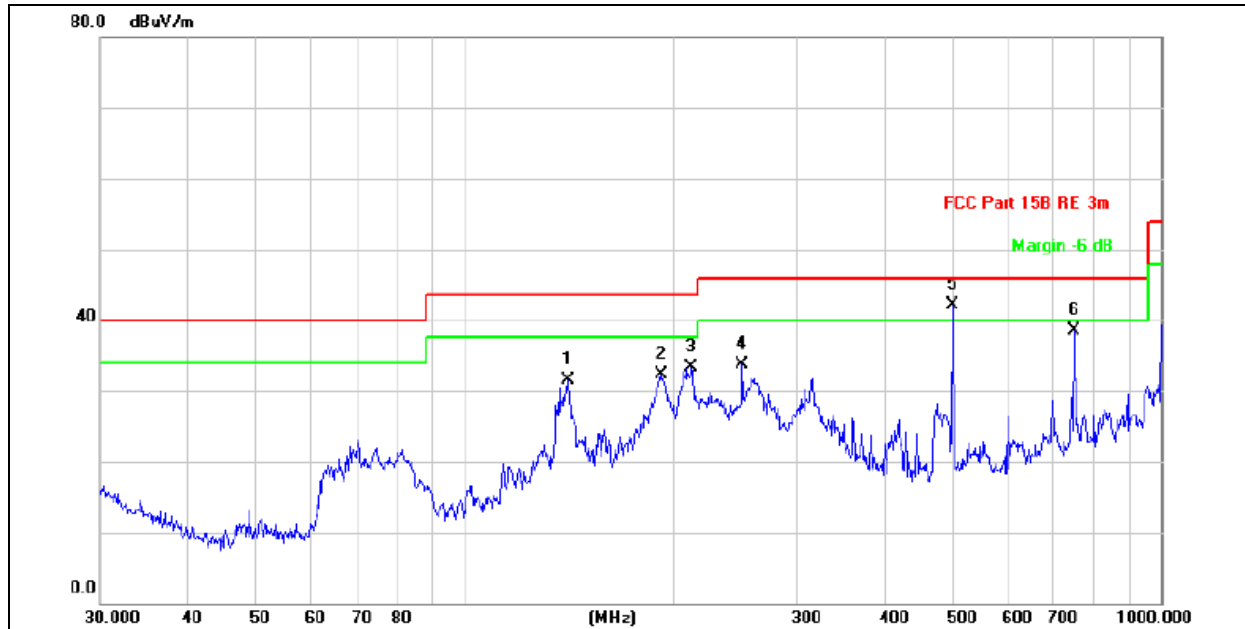

No.	Mk.	Freq.	Reading Level	Correct Factor	Measurement	Limit	Over	Antenna Height	Table Degree	
		MHz	dBuV	dB/m	dBuV/m	dBuV/m	dB	cm	degree	Comment
1		140.3420	41.45	-9.89	31.56	43.50	-11.94	QP	100	32
2		191.0738	42.64	-10.38	32.26	43.50	-11.24	QP	100	54
3		211.5264	43.46	-10.17	33.29	43.50	-10.21	QP	100	208
4		250.3011	44.38	-10.72	33.66	46.00	-12.34	QP	100	189
5	*	501.1789	45.29	-3.18	42.11	46.00	-3.89	QP	100	280
6		750.1082	37.48	1.06	38.54	46.00	-7.46	QP	100	106

Temperature:	26°C	Relative Humidity:	54%
Pressure:	101kPa	Polarization:	Vertical
Test Voltage:	AC 120V/60Hz		

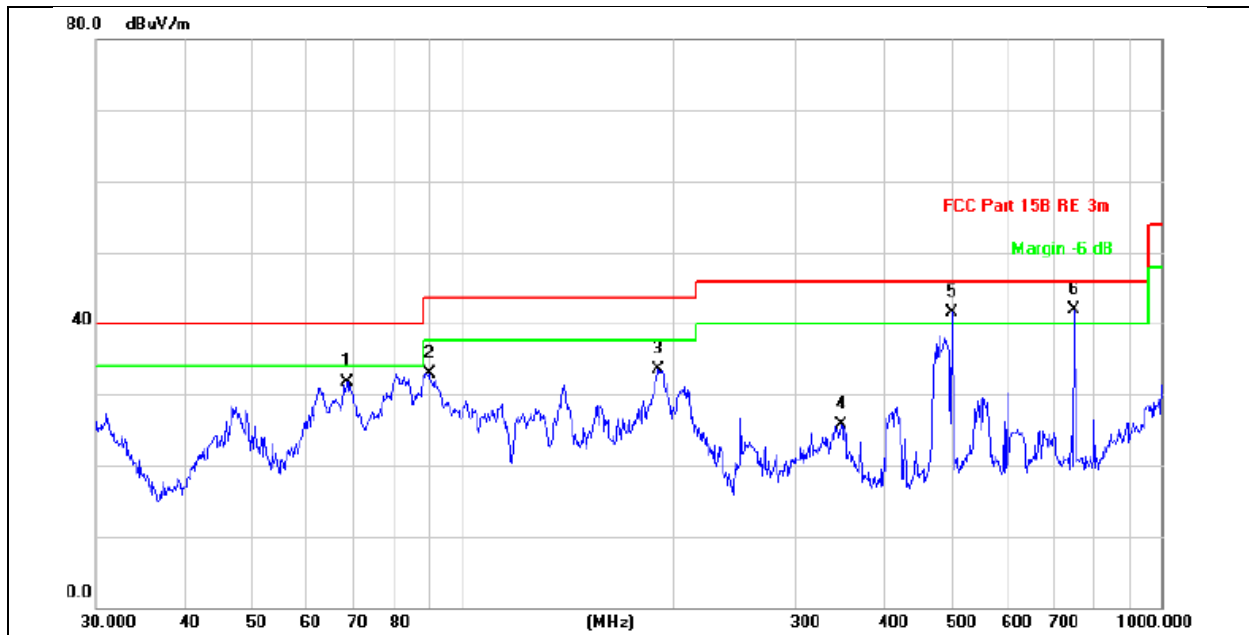

No. Mk.	Freq. MHz	Reading Level dBuV	Correct Factor dB/m	Measurement dBuV/m	Limit dBuV/m	Over dB	Detector	Antenna Height cm	Table Degree	Comment
1	68.3907	46.80	-15.18	31.62	40.00	-8.38	QP	100	10	
2	89.5899	48.35	-15.37	32.98	43.50	-10.52	QP	100	35	
3	190.4050	43.88	-10.41	33.47	43.50	-10.03	QP	100	97	
4	348.0274	32.59	-6.95	25.64	46.00	-20.36	QP	100	344	
5	! 501.1789	44.69	-3.18	41.51	46.00	-4.49	QP	100	93	
6	* 750.1082	40.76	1.06	41.82	46.00	-4.18	QP	100	27	

Remarks:

1. Final Level = Receiver Read level + Antenna Factor + Cable Loss – Preamplifier Factor
2. The emission levels of other frequencies are very lower than the limit and not show in test report.
3. The test data shows only the worst case- MIMO (802.11N-HT20 low channel)

1GHz~25GHz

802.11b-ANT1

Polar (H/V)	Frequency	Meter Reading	Pre-amplif ier	Cable Loss	Antenna Factor	Emission Level	Limits	Margin	Detect or Type
	(MHz)	(dBuV)	(dB)	(dB)	(dB)	(dBuV/m)	(dBuV/m)	(dB)	
Low Channel:2412MHz									
V	4824	55.92	30.55	5.77	24.66	55.80	74.00	-18.20	PK
V	4824	40.40	30.55	5.77	24.66	40.28	54.00	-13.72	AV
V	7236	54.40	30.33	6.32	24.55	54.94	74.00	-19.06	PK
V	7236	41.03	30.33	6.32	24.55	41.57	54.00	-12.43	AV
V	9648	51.02	30.85	7.45	24.69	52.31	74.00	-21.69	PK
V	9648	37.11	30.85	7.45	24.69	38.40	54.00	-15.60	AV
H	4824	54.77	30.55	5.77	24.66	54.65	74.00	-19.35	PK
H	4824	41.15	30.55	5.77	24.66	41.03	54.00	-12.97	AV
H	7236	53.17	30.33	6.32	24.55	53.71	74.00	-20.29	PK
H	7236	40.32	30.33	6.32	24.55	40.86	54.00	-13.14	AV
H	9648	51.97	30.85	7.45	24.69	53.26	74.00	-20.74	PK
H	9648	36.41	30.85	7.45	24.69	37.70	54.00	-16.30	AV

Polar (H/V)	Frequency	Meter Reading	Pre-amplif ier	Cable Loss	Antenna Factor	Emission Level	Limits	Margin	Detect or Type
	(MHz)	(dBuV)	(dB)	(dB)	(dB)	(dBuV/m)	(dBuV/m)	(dB)	
Middle Channel:2437MHz									
V	4874	56.51	30.55	5.77	24.66	56.39	74.00	-17.61	PK
V	4874	41.09	30.55	5.77	24.66	40.97	54.00	-13.03	AV
V	7311	54.16	30.33	6.32	24.55	54.70	74.00	-19.30	PK
V	7311	41.68	30.33	6.32	24.55	42.22	54.00	-11.78	AV
V	9748	50.27	30.85	7.45	24.69	51.56	74.00	-22.44	PK
V	9748	37.61	30.85	7.45	24.69	38.90	54.00	-15.10	AV
H	4874	55.95	30.55	5.77	24.66	55.83	74.00	-18.17	PK
H	4874	40.45	30.55	5.77	24.66	40.33	54.00	-13.67	AV
H	7311	52.99	30.33	6.32	24.55	53.53	74.00	-20.47	PK
H	7311	41.72	30.33	6.32	24.55	42.26	54.00	-11.74	AV
H	9748	51.06	30.85	7.45	24.69	52.35	74.00	-21.65	PK
H	9748	37.15	30.85	7.45	24.69	38.44	54.00	-15.56	AV

Polar (H/V)	Frequency	Meter Reading	Pre-amplifi er	Cable Loss	Antenna Factor	Emission Level	Limits	Margin	Detect or Type
	(MHz)	(dBuV)	(dB)	(dB)	(dB)	(dBuV/m)	(dBuV/m)	(dB)	
High Channel:2462MHz									
V	4924	55.37	30.55	5.77	24.66	55.25	74.00	-18.75	PK
V	4924	39.84	30.55	5.77	24.66	39.72	54.00	-14.28	AV
V	7386	53.54	30.33	6.32	24.55	54.08	74.00	-19.92	PK
V	7386	41.49	30.33	6.32	24.55	42.03	54.00	-11.97	AV
V	9848	51.90	30.85	7.45	24.69	53.19	74.00	-20.81	PK
V	9848	37.57	30.85	7.45	24.69	38.86	54.00	-15.14	AV
H	4924	54.92	30.55	5.77	24.66	54.80	74.00	-19.20	PK
H	4924	39.59	30.55	5.77	24.66	39.47	54.00	-14.53	AV
H	7386	52.86	30.33	6.32	24.55	53.40	74.00	-20.60	PK
H	7386	41.02	30.33	6.32	24.55	41.56	54.00	-12.44	AV
H	9848	51.97	30.85	7.45	24.69	53.26	74.00	-20.74	PK
H	9848	37.48	30.85	7.45	24.69	38.77	54.00	-15.23	AV

802.11g-ANT1

Polar (H/V)	Frequency	Meter Reading	Pre-ampli fier	Cable Loss	Antenna Factor	Emission Level	Limits	Margin	Detect or Type
	(MHz)	(dBuV)	(dB)	(dB)	(dB)	(dBuV/m)	(dBuV/m)	(dB)	
Low Channel:2412MHz									
V	4824	54.23	30.55	5.77	24.66	54.11	74.00	-19.89	PK
V	4824	39.96	30.55	5.77	24.66	39.84	54.00	-14.16	AV
V	7236	53.59	30.33	6.32	24.55	54.13	74.00	-19.87	PK
V	7236	40.52	30.33	6.32	24.55	41.06	54.00	-12.94	AV
V	9648	50.45	30.85	7.45	24.69	51.74	74.00	-22.26	PK
V	9648	38.58	30.85	7.45	24.69	39.87	54.00	-14.13	AV
H	4824	56.35	30.55	5.77	24.66	56.23	74.00	-17.77	PK
H	4824	41.21	30.55	5.77	24.66	41.09	54.00	-12.91	AV
H	7236	53.67	30.33	6.32	24.55	54.21	74.00	-19.79	PK
H	7236	39.86	30.33	6.32	24.55	40.40	54.00	-13.60	AV
H	9648	51.30	30.85	7.45	24.69	52.59	74.00	-21.41	PK
H	9648	39.00	30.85	7.45	24.69	40.29	54.00	-13.71	AV

Polar (H/V)	Frequency	Meter Reading	Pre-ampli fier	Cable Loss	Antenna Factor	Emission Level	Limits	Margin	Detect or Type
	(MHz)	(dBuV)	(dB)	(dB)	(dB)	(dBuV/m)	(dBuV/m)	(dB)	
Middle Channel:2437MHz									
V	4874	56.36	30.55	5.77	24.66	56.24	74.00	-17.76	PK
V	4874	40.32	30.55	5.77	24.66	40.20	54.00	-13.80	AV
V	7311	53.74	30.33	6.32	24.55	54.28	74.00	-19.72	PK
V	7311	39.78	30.33	6.32	24.55	40.32	54.00	-13.68	AV
V	9748	50.99	30.85	7.45	24.69	52.28	74.00	-21.72	PK
V	9748	37.62	30.85	7.45	24.69	38.91	54.00	-15.09	AV
H	4874	55.75	30.55	5.77	24.66	55.63	74.00	-18.37	PK
H	4874	41.84	30.55	5.77	24.66	41.72	54.00	-12.28	AV
H	7311	54.43	30.33	6.32	24.55	54.97	74.00	-19.03	PK
H	7311	39.71	30.33	6.32	24.55	40.25	54.00	-13.75	AV
H	9748	50.45	30.85	7.45	24.69	51.74	74.00	-22.26	PK
H	9748	39.10	30.85	7.45	24.69	40.39	54.00	-13.61	AV

Polar (H/V)	Frequency	Meter Reading	Pre-amplif ier	Cable Loss	Antenna Factor	Emission Level	Limits	Margin	Detect or Type
	(MHz)	(dBuV)	(dB)	(dB)	(dB)	(dBuV/m)	(dBuV/m)	(dB)	
High Channel:2462MHz									
V	4924	56.14	30.55	5.77	24.66	56.02	74.00	-17.98	PK
V	4924	41.92	30.55	5.77	24.66	41.80	54.00	-12.20	AV
V	7386	53.06	30.33	6.32	24.55	53.60	74.00	-20.40	PK
V	7386	40.66	30.33	6.32	24.55	41.20	54.00	-12.80	AV
V	9848	50.53	30.85	7.45	24.69	51.82	74.00	-22.18	PK
V	9848	36.25	30.85	7.45	24.69	37.54	54.00	-16.46	AV
H	4924	53.78	30.55	5.77	24.66	53.66	74.00	-20.34	PK
H	4924	41.11	30.55	5.77	24.66	40.99	54.00	-13.01	AV
H	7386	53.15	30.33	6.32	24.55	53.69	74.00	-20.31	PK
H	7386	40.58	30.33	6.32	24.55	41.12	54.00	-12.88	AV
H	9848	52.39	30.85	7.45	24.69	53.68	74.00	-20.32	PK
H	9848	37.99	30.85	7.45	24.69	39.28	54.00	-14.72	AV

802.11n20-ANT1

Polar (H/V)	Frequency	Meter Reading	Pre-ampl ifier	Cable Loss	Antenna Factor	Emission Level	Limits	Margin	Detect or Type
	(MHz)	(dBuV)	(dB)	(dB)	(dB)	(dBuV/m)	(dBuV/ m)	(dB)	
Low Channel:2412MHz									
V	4824	54.51	30.55	5.77	24.66	54.39	74.00	-19.61	PK
V	4824	40.18	30.55	5.77	24.66	40.06	54.00	-13.94	AV
V	7236	52.89	30.33	6.32	24.55	53.43	74.00	-20.57	PK
V	7236	40.01	30.33	6.32	24.55	40.55	54.00	-13.45	AV
V	9648	50.11	30.85	7.45	24.69	51.40	74.00	-22.60	PK
V	9648	38.33	30.85	7.45	24.69	39.62	54.00	-14.38	AV
H	4824	56.11	30.55	5.77	24.66	55.99	74.00	-18.01	PK
H	4824	41.37	30.55	5.77	24.66	41.25	54.00	-12.75	AV
H	7236	54.09	30.33	6.32	24.55	54.63	74.00	-19.37	PK
H	7236	41.48	30.33	6.32	24.55	42.02	54.00	-11.98	AV
H	9648	49.99	30.85	7.45	24.69	51.28	74.00	-22.72	PK
H	9648	37.00	30.85	7.45	24.69	38.29	54.00	-15.71	AV

Polar (H/V)	Frequency	Meter Reading	Pre-ampl ifier	Cable Loss	Antenna Factor	Emission Level	Limits	Margin	Detect or Type
	(MHz)	(dBuV)	(dB)	(dB)	(dB)	(dBuV/m)	(dBuV/ m)	(dB)	
Middle Channel:2437MHz									
V	4874	53.89	30.55	5.77	24.66	53.77	74.00	-20.23	PK
V	4874	40.80	30.55	5.77	24.66	40.68	54.00	-13.32	AV
V	7311	53.22	30.33	6.32	24.55	53.76	74.00	-20.24	PK
V	7311	40.56	30.33	6.32	24.55	41.10	54.00	-12.90	AV
V	9748	52.67	30.85	7.45	24.69	53.96	74.00	-20.04	PK
V	9748	39.15	30.85	7.45	24.69	40.44	54.00	-13.56	AV
H	4874	54.70	30.55	5.77	24.66	54.58	74.00	-19.42	PK
H	4874	42.18	30.55	5.77	24.66	42.06	54.00	-11.94	AV
H	7311	53.49	30.33	6.32	24.55	54.03	74.00	-19.97	PK
H	7311	41.71	30.33	6.32	24.55	42.25	54.00	-11.75	AV
H	9748	52.66	30.85	7.45	24.69	53.95	74.00	-20.05	PK
H	9748	38.90	30.85	7.45	24.69	40.19	54.00	-13.81	AV

Polar (H/V)	Frequency	Meter Reading	Pre-ampl ifier	Cable Loss	Antenna Factor	Emission Level	Limits	Margin	Detect or Type
	(MHz)	(dBuV)	(dB)	(dB)	(dB)	(dBuV/m)	(dBuV/ m)	(dB)	
High Channel:2462MHz									
V	4924	55.47	30.55	5.77	24.66	55.35	74.00	-18.65	PK
V	4924	41.83	30.55	5.77	24.66	41.71	54.00	-12.29	AV
V	7386	52.77	30.33	6.32	24.55	53.31	74.00	-20.69	PK
V	7386	39.56	30.33	6.32	24.55	40.10	54.00	-13.90	AV
V	9848	50.62	30.85	7.45	24.69	51.91	74.00	-22.09	PK
V	9848	38.90	30.85	7.45	24.69	40.19	54.00	-13.81	AV
H	4924	55.18	30.55	5.77	24.66	55.06	74.00	-18.94	PK
H	4924	40.71	30.55	5.77	24.66	40.59	54.00	-13.41	AV
H	7386	54.22	30.33	6.32	24.55	54.76	74.00	-19.24	PK
H	7386	38.98	30.33	6.32	24.55	39.52	54.00	-14.48	AV
H	9848	50.78	30.85	7.45	24.69	52.07	74.00	-21.93	PK
H	9848	38.00	30.85	7.45	24.69	39.29	54.00	-14.71	AV

802.11b-ANT2

Polar (H/V)	Frequency	Meter Reading	Pre-ampl ifier	Cable Loss	Antenna Factor	Emission Level	Limits	Margin	Detect or Type
	(MHz)	(dBuV)	(dB)	(dB)	(dB)	(dBuV/m)	(dBuV/ m)	(dB)	
Low Channel:2412MHz									
V	4824	54.92	30.55	5.77	24.66	54.80	74.00	-19.20	PK
V	4824	41.32	30.55	5.77	24.66	41.20	54.00	-12.80	AV
V	7236	54.27	30.33	6.32	24.55	54.81	74.00	-19.19	PK
V	7236	41.32	30.33	6.32	24.55	41.86	54.00	-12.14	AV
V	9648	51.05	30.85	7.45	24.69	52.34	74.00	-21.66	PK
V	9648	36.97	30.85	7.45	24.69	38.26	54.00	-15.74	AV
H	4824	53.79	30.55	5.77	24.66	53.67	74.00	-20.33	PK
H	4824	41.86	30.55	5.77	24.66	41.74	54.00	-12.26	AV
H	7236	53.37	30.33	6.32	24.55	53.91	74.00	-20.09	PK
H	7236	38.82	30.33	6.32	24.55	39.36	54.00	-14.64	AV
H	9648	52.16	30.85	7.45	24.69	53.45	74.00	-20.55	PK
H	9648	36.27	30.85	7.45	24.69	37.56	54.00	-16.44	AV

Polar (H/V)	Frequency	Meter Reading	Pre-ampl ifier	Cable Loss	Antenna Factor	Emission Level	Limits	Margin	Detect or Type
	(MHz)	(dBuV)	(dB)	(dB)	(dB)	(dBuV/m)	(dBuV/ m)	(dB)	
Middle Channel:2437MHz									
V	4874	56.19	30.55	5.77	24.66	56.07	74.00	-17.93	PK
V	4874	41.66	30.55	5.77	24.66	41.54	54.00	-12.46	AV
V	7311	54.39	30.33	6.32	24.55	54.93	74.00	-19.07	PK
V	7311	39.53	30.33	6.32	24.55	40.07	54.00	-13.93	AV
V	9748	52.36	30.85	7.45	24.69	53.65	74.00	-20.35	PK
V	9748	37.38	30.85	7.45	24.69	38.67	54.00	-15.33	AV
H	4874	55.76	30.55	5.77	24.66	55.64	74.00	-18.36	PK
H	4874	39.43	30.55	5.77	24.66	39.31	54.00	-14.69	AV
H	7311	53.50	30.33	6.32	24.55	54.04	74.00	-19.96	PK
H	7311	40.46	30.33	6.32	24.55	41.00	54.00	-13.00	AV
H	9748	51.24	30.85	7.45	24.69	52.53	74.00	-21.47	PK
H	9748	36.76	30.85	7.45	24.69	38.05	54.00	-15.95	AV

Polar (H/V)	Frequency	Meter Reading	Pre-ampl ifier	Cable Loss	Antenna Factor	Emission Level	Limits	Margin	Detect or Type
	(MHz)	(dBuV)	(dB)	(dB)	(dB)	(dBuV/m)	(dBuV/ m)	(dB)	
High Channel:2462MHz									
V	4924	54.16	30.55	5.77	24.66	54.04	74.00	-19.96	PK
V	4924	41.62	30.55	5.77	24.66	41.50	54.00	-12.50	AV
V	7386	54.68	30.33	6.32	24.55	55.22	74.00	-18.78	PK
V	7386	41.38	30.33	6.32	24.55	41.92	54.00	-12.08	AV
V	9848	50.28	30.85	7.45	24.69	51.57	74.00	-22.43	PK
V	9848	37.57	30.85	7.45	24.69	38.86	54.00	-15.14	AV
H	4924	54.96	30.55	5.77	24.66	54.84	74.00	-19.16	PK
H	4924	40.46	30.55	5.77	24.66	40.34	54.00	-13.66	AV
H	7386	53.52	30.33	6.32	24.55	54.06	74.00	-19.94	PK
H	7386	41.17	30.33	6.32	24.55	41.71	54.00	-12.29	AV

H	9848	51.54	30.85	7.45	24.69	52.83	74.00	-21.17	PK
H	9848	37.59	30.85	7.45	24.69	38.88	54.00	-15.12	AV

802.11g-ANT2

Polar (H/V)	Frequency	Meter Reading	Pre-ampl ifier	Cable Loss	Antenna Factor	Emission Level	Limits	Margin	Detect or Type
	(MHz)	(dBuV)	(dB)	(dB)	(dB)	(dBuV/m)	(dBuV/ m)	(dB)	
Low Channel:2412MHz									
V	4824	54.00	30.55	5.77	24.66	53.88	74.00	-20.12	PK
V	4824	41.47	30.55	5.77	24.66	41.35	54.00	-12.65	AV
V	7236	53.66	30.33	6.32	24.55	54.20	74.00	-19.80	PK
V	7236	39.13	30.33	6.32	24.55	39.67	54.00	-14.33	AV
V	9648	50.48	30.85	7.45	24.69	51.77	74.00	-22.23	PK
V	9648	38.74	30.85	7.45	24.69	40.03	54.00	-13.97	AV
H	4824	54.61	30.55	5.77	24.66	54.49	74.00	-19.51	PK
H	4824	40.86	30.55	5.77	24.66	40.74	54.00	-13.26	AV
H	7236	54.55	30.33	6.32	24.55	55.09	74.00	-18.91	PK
H	7236	41.28	30.33	6.32	24.55	41.82	54.00	-12.18	AV
H	9648	51.64	30.85	7.45	24.69	52.93	74.00	-21.07	PK
H	9648	37.60	30.85	7.45	24.69	38.89	54.00	-15.11	AV

Polar (H/V)	Frequency	Meter Reading	Pre-ampl ifier	Cable Loss	Antenna Factor	Emission Level	Limits	Margin	Detect or Type
	(MHz)	(dBuV)	(dB)	(dB)	(dB)	(dBuV/m)	(dBuV/ m)	(dB)	
Middle Channel:2437MHz									
V	4874	54.37	30.55	5.77	24.66	54.25	74.00	-19.75	PK
V	4874	41.93	30.55	5.77	24.66	41.81	54.00	-12.19	AV
V	7311	52.86	30.33	6.32	24.55	53.40	74.00	-20.60	PK
V	7311	38.88	30.33	6.32	24.55	39.42	54.00	-14.58	AV
V	9748	51.18	30.85	7.45	24.69	52.47	74.00	-21.53	PK
V	9748	36.85	30.85	7.45	24.69	38.14	54.00	-15.86	AV
H	4874	55.57	30.55	5.77	24.66	55.45	74.00	-18.55	PK
H	4874	39.99	30.55	5.77	24.66	39.87	54.00	-14.13	AV
H	7311	53.75	30.33	6.32	24.55	54.29	74.00	-19.71	PK
H	7311	39.28	30.33	6.32	24.55	39.82	54.00	-14.18	AV
H	9748	51.46	30.85	7.45	24.69	52.75	74.00	-21.25	PK
H	9748	37.76	30.85	7.45	24.69	39.05	54.00	-14.95	AV

Polar (H/V)	Frequency	Meter Reading	Pre-ampl ifier	Cable Loss	Antenna Factor	Emission Level	Limits	Margin	Detect or Type
	(MHz)	(dBuV)	(dB)	(dB)	(dB)	(dBuV/m)	(dBuV/ m)	(dB)	
High Channel:2462MHz									
V	4924	56.05	30.55	5.77	24.66	55.93	74.00	-18.07	PK
V	4924	41.02	30.55	5.77	24.66	40.90	54.00	-13.10	AV
V	7386	52.92	30.33	6.32	24.55	53.46	74.00	-20.54	PK
V	7386	41.49	30.33	6.32	24.55	42.03	54.00	-11.97	AV
V	9848	52.41	30.85	7.45	24.69	53.70	74.00	-20.30	PK
V	9848	37.18	30.85	7.45	24.69	38.47	54.00	-15.53	AV
H	4924	55.57	30.55	5.77	24.66	55.45	74.00	-18.55	PK
H	4924	42.07	30.55	5.77	24.66	41.95	54.00	-12.05	AV
H	7386	54.73	30.33	6.32	24.55	55.27	74.00	-18.73	PK
H	7386	40.23	30.33	6.32	24.55	40.77	54.00	-13.23	AV

H	9848	50.33	30.85	7.45	24.69	51.62	74.00	-22.38	PK
H	9848	37.31	30.85	7.45	24.69	38.60	54.00	-15.40	AV

802.11n-ANT2

Polar (H/V)	Frequency	Meter Reading	Pre-ampl ifier	Cable Loss	Antenna Factor	Emission Level	Limits	Margin	Detect or Type
	(MHz)	(dBuV)	(dB)	(dB)	(dB)	(dBuV/m)	(dBuV/ m)	(dB)	
Low Channel:2412MHz									
V	4824	53.86	30.55	5.77	24.66	53.74	74.00	-20.26	PK
V	4824	39.34	30.55	5.77	24.66	39.22	54.00	-14.78	AV
V	7236	52.99	30.33	6.32	24.55	53.53	74.00	-20.47	PK
V	7236	39.79	30.33	6.32	24.55	40.33	54.00	-13.67	AV
V	9648	50.85	30.85	7.45	24.69	52.14	74.00	-21.86	PK
V	9648	37.18	30.85	7.45	24.69	38.47	54.00	-15.53	AV
H	4824	53.95	30.55	5.77	24.66	53.83	74.00	-20.17	PK
H	4824	40.48	30.55	5.77	24.66	40.36	54.00	-13.64	AV
H	7236	54.36	30.33	6.32	24.55	54.90	74.00	-19.10	PK
H	7236	39.30	30.33	6.32	24.55	39.84	54.00	-14.16	AV
H	9648	52.49	30.85	7.45	24.69	53.78	74.00	-20.22	PK
H	9648	36.65	30.85	7.45	24.69	37.94	54.00	-16.06	AV

Polar (H/V)	Frequency	Meter Reading	Pre-ampl ifier	Cable Loss	Antenna Factor	Emission Level	Limits	Margin	Detect or Type
	(MHz)	(dBuV)	(dB)	(dB)	(dB)	(dBuV/m)	(dBuV/ m)	(dB)	
Middle Channel:2437MHz									
V	4874	55.42	30.55	5.77	24.66	55.30	74.00	-18.70	PK
V	4874	40.23	30.55	5.77	24.66	40.11	54.00	-13.89	AV
V	7311	53.61	30.33	6.32	24.55	54.15	74.00	-19.85	PK
V	7311	39.72	30.33	6.32	24.55	40.26	54.00	-13.74	AV
V	9748	52.32	30.85	7.45	24.69	53.61	74.00	-20.39	PK
V	9748	37.57	30.85	7.45	24.69	38.86	54.00	-15.14	AV
H	4874	54.46	30.55	5.77	24.66	54.34	74.00	-19.66	PK
H	4874	40.90	30.55	5.77	24.66	40.78	54.00	-13.22	AV
H	7311	53.64	30.33	6.32	24.55	54.18	74.00	-19.82	PK
H	7311	38.81	30.33	6.32	24.55	39.35	54.00	-14.65	AV
H	9748	51.84	30.85	7.45	24.69	53.13	74.00	-20.87	PK
H	9748	37.00	30.85	7.45	24.69	38.29	54.00	-15.71	AV

Polar (H/V)	Frequency	Meter Reading	Pre-ampl ifier	Cable Loss	Antenna Factor	Emission Level	Limits	Margin	Detect or Type
	(MHz)	(dBuV)	(dB)	(dB)	(dB)	(dBuV/m)	(dBuV/ m)	(dB)	
High Channel:2462MHz									
V	4924	54.32	30.55	5.77	24.66	54.20	74.00	-19.80	PK
V	4924	41.76	30.55	5.77	24.66	41.64	54.00	-12.36	AV
V	7386	53.92	30.33	6.32	24.55	54.46	74.00	-19.54	PK
V	7386	38.93	30.33	6.32	24.55	39.47	54.00	-14.53	AV
V	9848	52.24	30.85	7.45	24.69	53.53	74.00	-20.47	PK
V	9848	38.70	30.85	7.45	24.69	39.99	54.00	-14.01	AV
H	4924	56.70	30.55	5.77	24.66	56.58	74.00	-17.42	PK
H	4924	39.99	30.55	5.77	24.66	39.87	54.00	-14.13	AV
H	7386	53.06	30.33	6.32	24.55	53.60	74.00	-20.40	PK
H	7386	39.76	30.33	6.32	24.55	40.30	54.00	-13.70	AV

H	9848	50.68	30.85	7.45	24.69	51.97	74.00	-22.03	PK
H	9848	38.28	30.85	7.45	24.69	39.57	54.00	-14.43	AV

MIMO-802.11n

Polar (H/V)	Frequency	Meter Reading	Pre-ampl ifier	Cable Loss	Antenna Factor	Emission Level	Limits	Margin	Detect or Type
	(MHz)	(dBuV)	(dB)	(dB)	(dB)	(dBuV/m)	(dBuV/ m)	(dB)	
Low Channel:2412MHz									
V	4824	55.22	30.55	5.77	24.66	55.10	74.00	-18.90	PK
V	4824	40.11	30.55	5.77	24.66	39.99	54.00	-14.01	AV
V	7236	54.36	30.33	6.32	24.55	54.90	74.00	-19.10	PK
V	7236	40.43	30.33	6.32	24.55	40.97	54.00	-13.03	AV
V	9648	49.94	30.85	7.45	24.69	51.23	74.00	-22.77	PK
V	9648	39.13	30.85	7.45	24.69	40.42	54.00	-13.58	AV
H	4824	56.08	30.55	5.77	24.66	55.96	74.00	-18.04	PK
H	4824	40.55	30.55	5.77	24.66	40.43	54.00	-13.57	AV
H	7236	53.34	30.33	6.32	24.55	53.88	74.00	-20.12	PK
H	7236	41.04	30.33	6.32	24.55	41.58	54.00	-12.42	AV
H	9648	52.30	30.85	7.45	24.69	53.59	74.00	-20.41	PK
H	9648	37.02	30.85	7.45	24.69	38.31	54.00	-15.69	AV

Polar (H/V)	Frequency	Meter Reading	Pre-ampl ifier	Cable Loss	Antenna Factor	Emission Level	Limits	Margin	Detect or Type
	(MHz)	(dBuV)	(dB)	(dB)	(dB)	(dBuV/m)	(dBuV/ m)	(dB)	
Middle Channel:2437MHz									
V	4874	55.46	30.55	5.77	24.66	55.34	74.00	-18.66	PK
V	4874	41.20	30.55	5.77	24.66	41.08	54.00	-12.92	AV
V	7311	53.24	30.33	6.32	24.55	53.78	74.00	-20.22	PK
V	7311	40.57	30.33	6.32	24.55	41.11	54.00	-12.89	AV
V	9748	51.77	30.85	7.45	24.69	53.06	74.00	-20.94	PK
V	9748	37.11	30.85	7.45	24.69	38.40	54.00	-15.60	AV
H	4874	54.07	30.55	5.77	24.66	53.95	74.00	-20.05	PK
H	4874	39.43	30.55	5.77	24.66	39.31	54.00	-14.69	AV
H	7311	53.70	30.33	6.32	24.55	54.24	74.00	-19.76	PK
H	7311	39.31	30.33	6.32	24.55	39.85	54.00	-14.15	AV
H	9748	50.64	30.85	7.45	24.69	51.93	74.00	-22.07	PK
H	9748	36.69	30.85	7.45	24.69	37.98	54.00	-16.02	AV

Polar (H/V)	Frequency	Meter Reading	Pre-ampl ifier	Cable Loss	Antenna Factor	Emission Level	Limits	Margin	Detect or Type
	(MHz)	(dBuV)	(dB)	(dB)	(dB)	(dBuV/m)	(dBuV/ m)	(dB)	
High Channel:2462MHz									
V	4924	56.10	30.55	5.77	24.66	55.98	74.00	-18.02	PK
V	4924	41.54	30.55	5.77	24.66	41.42	54.00	-12.58	AV
V	7386	53.23	30.33	6.32	24.55	53.77	74.00	-20.23	PK
V	7386	41.20	30.33	6.32	24.55	41.74	54.00	-12.26	AV
V	9848	51.90	30.85	7.45	24.69	53.19	74.00	-20.81	PK
V	9848	36.28	30.85	7.45	24.69	37.57	54.00	-16.43	AV
H	4924	55.54	30.55	5.77	24.66	55.42	74.00	-18.58	PK
H	4924	39.51	30.55	5.77	24.66	39.39	54.00	-14.61	AV
H	7386	54.07	30.33	6.32	24.55	54.61	74.00	-19.39	PK
H	7386	39.64	30.33	6.32	24.55	40.18	54.00	-13.82	AV

H	9848	52.66	30.85	7.45	24.69	53.95	74.00	-20.05	PK
H	9848	36.29	30.85	7.45	24.69	37.58	54.00	-16.42	AV

Remark:

1. Emission Level = Meter Reading + Antenna Factor + Cable Loss – Pre-amplifier,
Margin= Emission Level - Limit
2. If peak below the average limit, the average emission was no test.
3. The amplitude of spurious emissions which are attenuated by more than 20dB below the permissible value has no need to be reported.

5.RADIATED BAND EMISSIONMEASUREMENT**5.1 TEST REQUIREMENT:**

Test Requirement:	FCC Part15 C Section 15.209 and 15.205				
Test Method:	ANSI C63.10: 2013				
Test Frequency Range:	All of the restrict bands were tested, only the worst band's (2310MHz to 2500MHz) data was showed.				
Test site:	Measurement Distance: 3m				
Receiver setup:	Frequency	Detector	RBW	VBW	Value
	Above 1GHz	Peak	1MHz	3MHz	Peak
		Average	1MHz	3MHz	Average

LIMITS OF RADIATED EMISSION MEASUREMENT (Above 1000MHz)

FREQUENCY (MHz)	Class B (dBuV/m) (at 3M)	
	PEAK	AVERAGE
Above 1000	74	54

Notes:

- (1) The limit for radiated test was performed according to FCC PART 15C.
- (2) The tighter limit applies at the band edges.
- (3) Emission level (dBuV/m)=20log Emission level (uV/m).

5.2 TEST PROCEDURE

Above 1GHz test procedure as below:

- a. 1. The EUT was placed on the top of a rotating table 1.5 meters above the ground at a 3 meter camber. The table was rotated 360 degrees to determine the position of the highest radiation.
- b. The EUT was set 3 meters away from the interference-receiving antenna, which was mounted on the top of a variable-height antenna tower.
- c. The antenna height is varied from one meter to four meters above the ground to determine the maximum value of the field strength. Both horizontal and vertical polarizations of the antenna are set to make the measurement.
- d. For each suspected emission, the EUT was arranged to its worst case and then the antenna was tuned to heights from 1 meter to 4 meters and the rota table was turned from 0 degrees to 360 degrees to find the maximum reading.
- e. The test-receiver system was set to Peak Detect Function and Specified Bandwidth with Maximum Hold Mode.
- f. If the emission level of the EUT in peak mode was 10dB lower than the limit specified, then testing could bestopped and the peak values of the EUT would be reported. Otherwise the emissions that did not have 10dBmargin would be re-tested one by one using peak, quasi-peak or average method as specified and then reportedin a data sheet.
- g. Test the EUT in the lowest channel,the Highest channel

Note:

Both horizontal and vertical antenna polarities were tested and performed pretest to three orthogonal axis. The worst case emissions were reported

5.3 DEVIATION FROM TEST STANDARD

No deviation

5.4 TEST SETUP

Radiated Emission Test-Up Frequency Above 1GHz

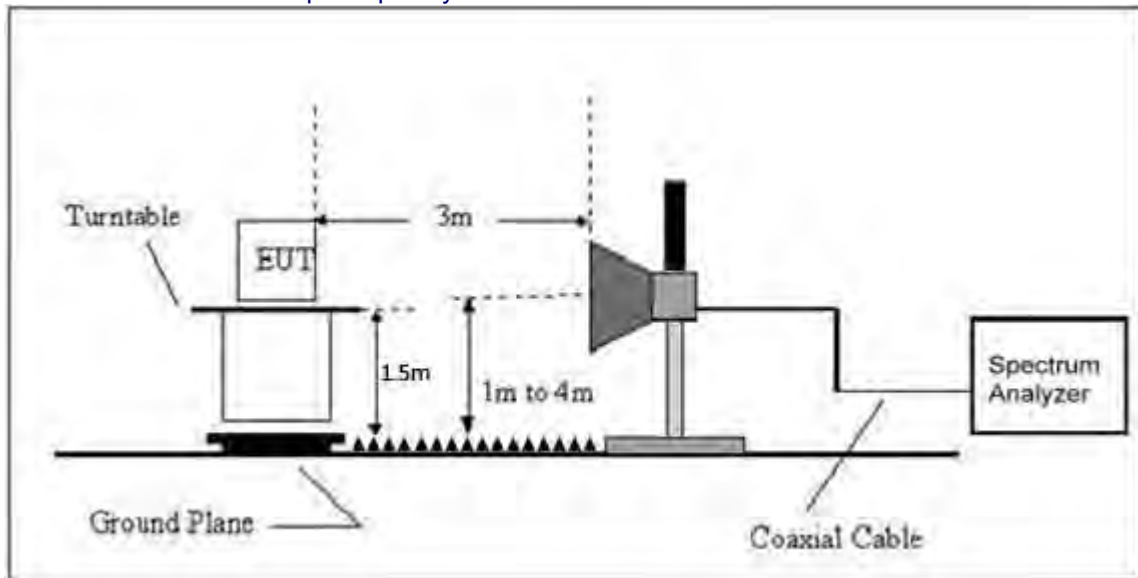

5.5 EUT OPERATING CONDITIONS

The EUT tested system was configured as the statements of 2.3 Unless otherwise a special operating condition is specified in the follows during the testing.

5.6 TEST RESULT

ANT1-802.11b

Polar (H/V)	Frequency (MHz)	Meter Reading (dBuV)	Pre-amplifier (dB)	Cable Loss (dB)	Antenna Factor (dB/m)	Emission level (dBuV/m)	Limit (dBuV/m)	Margin (dBuV/m)	Detect or Type	Result
Low Channel 2412MHz										
H	2390.00	52.90	30.22	4.85	23.98	51.51	74	-22.49	PK	PASS
H	2390.00	38.49	30.22	4.85	23.98	37.10	54	-16.90	AV	PASS
H	2400.00	53.91	30.22	4.85	23.98	52.52	74	-21.48	PK	PASS
H	2400.00	38.32	30.22	4.85	23.98	36.93	54	-17.07	AV	PASS
V	2390.00	53.63	30.22	4.85	23.98	52.24	74	-21.76	PK	PASS
V	2390.00	38.86	30.22	4.85	23.98	37.47	54	-16.53	AV	PASS
V	2400.00	51.89	30.22	4.85	23.98	50.50	74	-23.50	PK	PASS
V	2400.00	37.98	30.22	4.85	23.98	36.59	54	-17.41	AV	PASS
High Channel 2462MHz										
H	2483.50	52.32	30.22	4.85	23.98	50.93	74	-23.07	PK	PASS
H	2483.50	39.56	30.22	4.85	23.98	38.17	54	-15.83	AV	PASS
H	2500.00	52.85	30.22	4.85	23.98	51.46	74	-22.54	PK	PASS
H	2500.00	38.63	30.22	4.85	23.98	37.24	54	-16.76	AV	PASS
V	2483.50	51.33	30.22	4.85	23.98	49.94	74	-24.06	PK	PASS
V	2483.50	39.38	30.22	4.85	23.98	37.99	54	-16.01	AV	PASS
V	2500.00	54.22	30.22	4.85	23.98	52.83	74	-21.17	PK	PASS
V	2500.00	36.52	30.22	4.85	23.98	35.13	54	-18.87	AV	PASS

ANT1-802.11g

Polar (H/V)	Frequency (MHz)	Meter Reading (dBuV)	Pre-amplifier (dB)	Cable Loss (dB)	Antenna Factor (dB/m)	Emission level (dBuV/m)	Limit (dBuV/m)	Margin (dBuV/m)	Detect or Type	Result
Low Channel 2412MHz										
H	2390.00	50.97	30.22	4.85	23.98	49.58	74	-24.42	PK	PASS
H	2390.00	39.81	30.22	4.85	23.98	38.42	54	-15.58	AV	PASS
H	2400.00	52.65	30.22	4.85	23.98	51.26	74	-22.74	PK	PASS
H	2400.00	36.58	30.22	4.85	23.98	35.19	54	-18.81	AV	PASS
V	2390.00	51.94	30.22	4.85	23.98	50.55	74	-23.45	PK	PASS
V	2390.00	37.34	30.22	4.85	23.98	35.95	54	-18.05	AV	PASS
V	2400.00	54.44	30.22	4.85	23.98	53.05	74	-20.95	PK	PASS
V	2400.00	36.66	30.22	4.85	23.98	35.27	54	-18.73	AV	PASS
High Channel 2462MHz										
H	2483.50	52.12	30.22	4.85	23.98	50.73	74	-23.27	PK	PASS
H	2483.50	37.43	30.22	4.85	23.98	36.04	54	-17.96	AV	PASS
H	2500.00	54.61	30.22	4.85	23.98	53.22	74	-20.78	PK	PASS
H	2500.00	36.37	30.22	4.85	23.98	34.98	54	-19.02	AV	PASS
V	2483.50	51.71	30.22	4.85	23.98	50.32	74	-23.68	PK	PASS
V	2483.50	39.73	30.22	4.85	23.98	38.34	54	-15.66	AV	PASS
V	2500.00	52.23	30.22	4.85	23.98	50.84	74	-23.16	PK	PASS
V	2500.00	36.61	30.22	4.85	23.98	35.22	54	-18.78	AV	PASS

ANT1-802.11n20

Polar (H/V)	Frequency (MHz)	Meter Reading (dBuV)	Pre-amplifier (dB)	Cable Loss (dB)	Antenna Factor (dB/m)	Emission level (dBuV/m)	Limit (dBuV/m)	Margin (dBuV/m)	Detect or Type	Result
Low Channel 2412MHz										
H	2390.00	53.36	30.22	4.85	23.98	51.97	74	-22.03	PK	PASS
H	2390.00	39.67	30.22	4.85	23.98	38.28	54	-15.72	AV	PASS
H	2400.00	54.75	30.22	4.85	23.98	53.36	74	-20.64	PK	PASS
H	2400.00	37.20	30.22	4.85	23.98	35.81	54	-18.19	AV	PASS
V	2390.00	53.10	30.22	4.85	23.98	51.71	74	-22.29	PK	PASS
V	2390.00	39.41	30.22	4.85	23.98	38.02	54	-15.98	AV	PASS

V	2400.00	52.50	30.22	4.85	23.98	51.11	74	-22.89	PK	PASS
V	2400.00	36.88	30.22	4.85	23.98	35.49	54	-18.51	AV	PASS
High Channel 2462MHz										
H	2483.50	52.85	30.22	4.85	23.98	51.46	74	-22.54	PK	PASS
H	2483.50	37.24	30.22	4.85	23.98	35.85	54	-18.15	AV	PASS
H	2500.00	53.58	30.22	4.85	23.98	52.19	74	-21.81	PK	PASS
H	2500.00	37.55	30.22	4.85	23.98	36.16	54	-17.84	AV	PASS
V	2483.50	52.31	30.22	4.85	23.98	50.92	74	-23.08	PK	PASS
V	2483.50	39.40	30.22	4.85	23.98	38.01	54	-15.99	AV	PASS
V	2500.00	53.05	30.22	4.85	23.98	51.66	74	-22.34	PK	PASS
V	2500.00	38.45	30.22	4.85	23.98	37.06	54	-16.94	AV	PASS

ANT2-802.11b

Polar (H/V)	Frequency (MHz)	Meter Reading (dBuV)	Pre-amplifier (dB)	Cable Loss (dB)	Antenna Factor (dB/m)	Emission level (dBuV/m)	Limit (dBuV/m)	Margin (dBuV/m)	Detect or Type	Result
Low Channel 2412MHz										
H	2390.00	53.47	30.22	4.85	23.98	52.08	74	-21.92	PK	PASS
H	2390.00	37.47	30.22	4.85	23.98	36.08	54	-17.92	AV	PASS
H	2400.00	52.91	30.22	4.85	23.98	51.52	74	-22.48	PK	PASS
H	2400.00	36.93	30.22	4.85	23.98	35.54	54	-18.46	AV	PASS
V	2390.00	52.20	30.22	4.85	23.98	50.81	74	-23.19	PK	PASS
V	2390.00	39.77	30.22	4.85	23.98	38.38	54	-15.62	AV	PASS
V	2400.00	52.41	30.22	4.85	23.98	51.02	74	-22.98	PK	PASS
V	2400.00	38.77	30.22	4.85	23.98	37.38	54	-16.62	AV	PASS
High Channel 2462MHz										
H	2483.50	52.74	30.22	4.85	23.98	51.35	74	-22.65	PK	PASS
H	2483.50	38.99	30.22	4.85	23.98	37.60	54	-16.40	AV	PASS
H	2500.00	53.94	30.22	4.85	23.98	52.55	74	-21.45	PK	PASS
H	2500.00	38.98	30.22	4.85	23.98	37.59	54	-16.41	AV	PASS
V	2483.50	52.57	30.22	4.85	23.98	51.18	74	-22.82	PK	PASS
V	2483.50	39.84	30.22	4.85	23.98	38.45	54	-15.55	AV	PASS
V	2500.00	53.87	30.22	4.85	23.98	52.48	74	-21.52	PK	PASS
V	2500.00	39.11	30.22	4.85	23.98	37.72	54	-16.28	AV	PASS

ANT2-802.11g

Polar (H/V)	Frequency (MHz)	Meter Reading (dBuV)	Pre-amplifier (dB)	Cable Loss (dB)	Antenna Factor (dB/m)	Emission level (dBuV/m)	Limit (dBuV/m)	Margin (dBuV/m)	Detect or Type	Result
Low Channel 2412MHz										
H	2390.00	53.08	30.22	4.85	23.98	51.69	74	-22.31	PK	PASS
H	2390.00	37.52	30.22	4.85	23.98	36.13	54	-17.87	AV	PASS
H	2400.00	54.38	30.22	4.85	23.98	52.99	74	-21.01	PK	PASS
H	2400.00	36.74	30.22	4.85	23.98	35.35	54	-18.65	AV	PASS
V	2390.00	51.28	30.22	4.85	23.98	49.89	74	-24.11	PK	PASS
V	2390.00	39.18	30.22	4.85	23.98	37.79	54	-16.21	AV	PASS
V	2400.00	52.02	30.22	4.85	23.98	50.63	74	-23.37	PK	PASS
V	2400.00	37.98	30.22	4.85	23.98	36.59	54	-17.41	AV	PASS
High Channel 2462MHz										
H	2483.50	52.12	30.22	4.85	23.98	50.73	74	-23.27	PK	PASS
H	2483.50	37.33	30.22	4.85	23.98	35.94	54	-18.06	AV	PASS
H	2500.00	54.00	30.22	4.85	23.98	52.61	74	-21.39	PK	PASS
H	2500.00	36.41	30.22	4.85	23.98	35.02	54	-18.98	AV	PASS
V	2483.50	51.14	30.22	4.85	23.98	49.75	74	-24.25	PK	PASS
V	2483.50	37.47	30.22	4.85	23.98	36.08	54	-17.92	AV	PASS
V	2500.00	54.27	30.22	4.85	23.98	52.88	74	-21.12	PK	PASS
V	2500.00	36.30	30.22	4.85	23.98	34.91	54	-19.09	AV	PASS

ANT2-802.11n20

Polar (H/V)	Frequency (MHz)	Meter Reading (dBuV)	Pre-amplifier (dB)	Cable Loss (dB)	Antenna Factor (dB/m)	Emission level (dBuV/m)	Limit (dBuV /m)	Margin (dBuV/ m)	Detect or Type	Result
Low Channel 2412MHz										
H	2390.00	53.38	30.22	4.85	23.98	51.99	74	-22.01	PK	PASS
H	2390.00	39.15	30.22	4.85	23.98	37.76	54	-16.24	AV	PASS
H	2400.00	53.13	30.22	4.85	23.98	51.74	74	-22.26	PK	PASS
H	2400.00	37.11	30.22	4.85	23.98	35.72	54	-18.28	AV	PASS
V	2390.00	52.16	30.22	4.85	23.98	50.77	74	-23.23	PK	PASS
V	2390.00	37.44	30.22	4.85	23.98	36.05	54	-17.95	AV	PASS
V	2400.00	52.10	30.22	4.85	23.98	50.71	74	-23.29	PK	PASS
V	2400.00	37.49	30.22	4.85	23.98	36.10	54	-17.90	AV	PASS
High Channel 2462MHz										
H	2483.50	52.71	30.22	4.85	23.98	51.32	74	-22.68	PK	PASS
H	2483.50	39.67	30.22	4.85	23.98	38.28	54	-15.72	AV	PASS
H	2500.00	54.33	30.22	4.85	23.98	52.94	74	-21.06	PK	PASS
H	2500.00	37.20	30.22	4.85	23.98	35.81	54	-18.19	AV	PASS
V	2483.50	52.73	30.22	4.85	23.98	51.34	74	-22.66	PK	PASS
V	2483.50	40.23	30.22	4.85	23.98	38.84	54	-15.16	AV	PASS
V	2500.00	54.32	30.22	4.85	23.98	52.93	74	-21.07	PK	PASS
V	2500.00	36.31	30.22	4.85	23.98	34.92	54	-19.08	AV	PASS

MIMO-802.11n20

Polar (H/V)	Frequency (MHz)	Meter Reading (dBuV)	Pre-amplifier (dB)	Cable Loss (dB)	Antenna Factor (dB/m)	Emission level (dBuV/m)	Limit (dBuV /m)	Margin (dBuV/ m)	Detect or Type	Result
Low Channel 2412MHz										
H	2390.00	50.94	30.22	4.85	23.98	49.55	74	-24.45	PK	PASS
H	2390.00	40.20	30.22	4.85	23.98	38.81	54	-15.19	AV	PASS
H	2400.00	53.02	30.22	4.85	23.98	51.63	74	-22.37	PK	PASS
H	2400.00	38.99	30.22	4.85	23.98	37.60	54	-16.40	AV	PASS
V	2390.00	51.18	30.22	4.85	23.98	49.79	74	-24.21	PK	PASS
V	2390.00	38.84	30.22	4.85	23.98	37.45	54	-16.55	AV	PASS
V	2400.00	54.71	30.22	4.85	23.98	53.32	74	-20.68	PK	PASS
V	2400.00	37.03	30.22	4.85	23.98	35.64	54	-18.36	AV	PASS
High Channel 2462MHz										
H	2483.50	53.38	30.22	4.85	23.98	51.99	74	-22.01	PK	PASS
H	2483.50	37.66	30.22	4.85	23.98	36.27	54	-17.73	AV	PASS
H	2500.00	51.82	30.22	4.85	23.98	50.43	74	-23.57	PK	PASS
H	2500.00	38.29	30.22	4.85	23.98	36.90	54	-17.10	AV	PASS
V	2483.50	52.75	30.22	4.85	23.98	51.36	74	-22.64	PK	PASS
V	2483.50	38.28	30.22	4.85	23.98	36.89	54	-17.11	AV	PASS
V	2500.00	53.63	30.22	4.85	23.98	52.24	74	-21.76	PK	PASS
V	2500.00	37.88	30.22	4.85	23.98	36.49	54	-17.51	AV	PASS

Remark:

1. Emission Level = Meter Reading + Antenna Factor + Cable Loss – Pre-amplifier, Margin= Emission Level - Limit

6.POWER SPECTRAL DENSITY TEST

Test Requirement:	FCC Part15 C Section 15.247 (e)
Test Method:	KDB558074 D0115.247 Meas Guidance v 05r02

6.1 APPLIED PROCEDURES / LIMIT

FCC Part15 (15.247) , Subpart C				
Section	Test Item	Limit	Frequency Range (MHz)	Result
15.247	Power Spectral Density	8dBm/3kHz	2400-2483.5	PASS

6.2 TEST PROCEDURE

1. Set analyzer center frequency to DTS channel center frequency.
2. Set the span to 1.5 times the DTS bandwidth.
3. Set the RBW to: $3 \text{ kHz} \leq \text{RBW} \leq 100 \text{ kHz}$.
4. Set the VBW $\geq 3 \times \text{RBW}$.
5. Detector = peak.
6. Sweep time = auto couple.
7. Trace mode = max hold.
8. Allow trace to fully stabilize.
9. Use the peak marker function to determine the maximum amplitude level within the RBW.
10. If measured value exceeds limit, reduce RBW (no less than 3 kHz) and repeat.

6.3 DEVIATION FROM STANDARD

No deviation.

6.4 TEST SETUP**6.5 EUT OPERATION CONDITIONS**

The EUT tested system was configured as the statements of 2.1 Unless otherwise a special operating condition is specified in the follows during the testing.

6.6 TEST RESULT

PASS: PLEASE REFER TO APPENDIX: APPENDIX1 FOR DETAILS

7. CHANNEL BANDWIDTH

Test Requirement:	FCC Part15 C Section 15.247 (a)(2)
Test Method:	KDB558074 D0115.247 Meas Guidance v05r02

7.1 APPLIED PROCEDURES / LIMIT

FCC Part15 (15.247) , Subpart C				
Section	Test Item	Limit	Frequency Range (MHz)	Result
15.247(a)(2)	Bandwidth	$\geq 500\text{KHz}$ (6dB bandwidth)	2400-2483.5	PASS

7.2 TEST PROCEDURE

1. Set RBW = 100 kHz.
2. Set the video bandwidth (VBW) $\geq 3 \times \text{RBW}$.
3. Detector = Peak.
4. Trace mode = max hold.
5. Sweep = auto couple.
6. Allow the trace to stabilize.
7. Measure the maximum width of the emission that is constrained by the frequencies associated with the two outermost amplitude points (upper and lower frequencies) that are attenuated by 6 dB relative to the maximum level measured in the fundamental emission.

7.3 DEVIATION FROM STANDARD

No deviation.

7.4 TEST SETUP



7.5 EUT OPERATION CONDITIONS

The EUT tested system was configured as the statements of 2.4 Unless otherwise a special operating condition is specified in the follows during the testing.

7.6 TEST RESULT

PASS: PLEASE REFER TO APPENDIX: APPENDIX1 FOR DETAILS

8. OUTPUT POWER TEST

Test Requirement:	FCC Part15 C Section 15.247 (b)(3)
Test Method:	KDB558074 D0115.247 Meas Guidance v05r02

8.1 APPLIED PROCEDURES/LIMIT

FCC Part15 (15.247) , Subpart C				
Section	Test Item	Limit	Frequency Range (MHz)	Result
15.247(b)(3)	Peak Output Power	1 watt or 30dBm	2400-2483.5	PASS

8.2 TEST PROCEDURE

- a. The EUT was directly connected to the Power meter

8.3 DEVIATION FROM STANDARD

No deviation.

8.4 TEST SETUP**8.5 EUT OPERATION CONDITIONS**

The EUT tested system was configured as the statements of 2.4 Unless otherwise a special operating condition is specified in the follows during the testing.

8.6 TEST RESULT

PASS: PLEASE REFER TO APPENDIX: APPENDIX1 FOR DETAILS

9. CONDUCTED BAND EDGE AND SPURIOUS EMISSION

Test Requirement:	FCC Part15 C Section 15.247 (d)
Test Method:	KDB558074 D0115.247 Meas Guidance v05r02

9.1 APPLICABLE STANDARD

in any 100 kHz bandwidth outside the frequency bands in which the spread spectrum intentional radiator is operating, the radio frequency power that is produced by the intentional radiator shall be at least 20dB below that in the 100kHz bandwidth within the band that contains the highest level of the desired power, In addition, radiated emissions which fall in the restricted bands, as defined in§15.205(a), must also comply with the radiated emission limits specified in15.209(a).

9.2 TEST PROCEDURE

Using the following spectrum analyzer setting:

- A) Set the RBW = 100KHz.
- B) Set the VBW = 300KHz.
- C) Sweep time = auto couple.
- D) Detector function = peak.
- E) Trace mode = max hold.
- F) Allow trace to fully stabilize.

9.3 DEVIATION FROM STANDARD

No deviation.

9.4 TEST SETUP



9.5 EUT OPERATION CONDITIONS

The EUT tested system was configured as the statements of 2.4 Unless otherwise a special operating condition is specified in the follows during the testing.

9.6 TEST RESULTS

PASS: PLEASE REFER TO APPENDIX: APPENDIX1 FOR DETAILS

10. ANTENNA REQUIREMENT

Standard requirement:	FCC Part15 C Section 15.203 /247(c)
<p>For intentional device, according to FCC 47 CFR Section 15.203, an intentional radiator shall be designed to ensure that no antenna other than that furnished by the responsible party shall be used with the device. And according to FCC 47 CFR Section 15.247, if transmitting antennas of directional gain greater than 6dBi are used, the power shall be reduced by the amount in dB that the directional gain of the antenna exceeds 6dBi.</p> <p>Refer to statement below for compliance.</p> <p>The manufacturer may design the unit so that the user can replace a broken antenna, but the use of a standard antenna jack or electrical connector is prohibited. Further, this requirement does not apply to intentional radiators that must be professionally installed.</p> <p>Antenna Connected Construction</p> <p>The antenna is Internal antenna, the best case gain of the A ANT1:3.39dBi; ANT2:1.26dBi, reference to the below photo for details</p>	
<div style="display: flex; justify-content: space-around; margin-bottom: 5px;"> 2.4G WIFI ant2 2.4G WIFI ant1 </div> 	

11. Appendix1

11.1. -6DB BANDWIDTH

Condition	Antenna	Modulation	Frequency (MHz)	-6dB BW(MHz)	limit(kHz)	Result
NVNT	ANT1	802.11b	2412.00	10.13	500	Pass
NVNT	ANT1	802.11b	2437.00	10.13	500	Pass
NVNT	ANT1	802.11b	2462.00	10.13	500	Pass
NVNT	ANT1	802.11g	2412.00	15.69	500	Pass
NVNT	ANT1	802.11g	2437.00	15.74	500	Pass
NVNT	ANT1	802.11g	2462.00	15.65	500	Pass
NVNT	ANT1	802.11n(HT20)	2412.00	16.04	500	Pass
NVNT	ANT1	802.11n(HT20)	2437.00	15.75	500	Pass
NVNT	ANT1	802.11n(HT20)	2462.00	15.59	500	Pass

Condition	Antenna	Modulation	Frequency (MHz)	-6dB BW(MHz)	limit(kHz)	Result
NVNT	ANT2	802.11b	2412.00	10.14	500	Pass
NVNT	ANT2	802.11b	2437.00	10.14	500	Pass
NVNT	ANT2	802.11b	2462.00	10.13	500	Pass
NVNT	ANT2	802.11g	2412.00	15.35	500	Pass
NVNT	ANT2	802.11g	2437.00	15.67	500	Pass
NVNT	ANT2	802.11g	2462.00	15.81	500	Pass
NVNT	ANT2	802.11n(HT20)	2412.00	15.70	500	Pass
NVNT	ANT2	802.11n(HT20)	2437.00	16.90	500	Pass
NVNT	ANT2	802.11n(HT20)	2462.00	15.63	500	Pass

ANT1

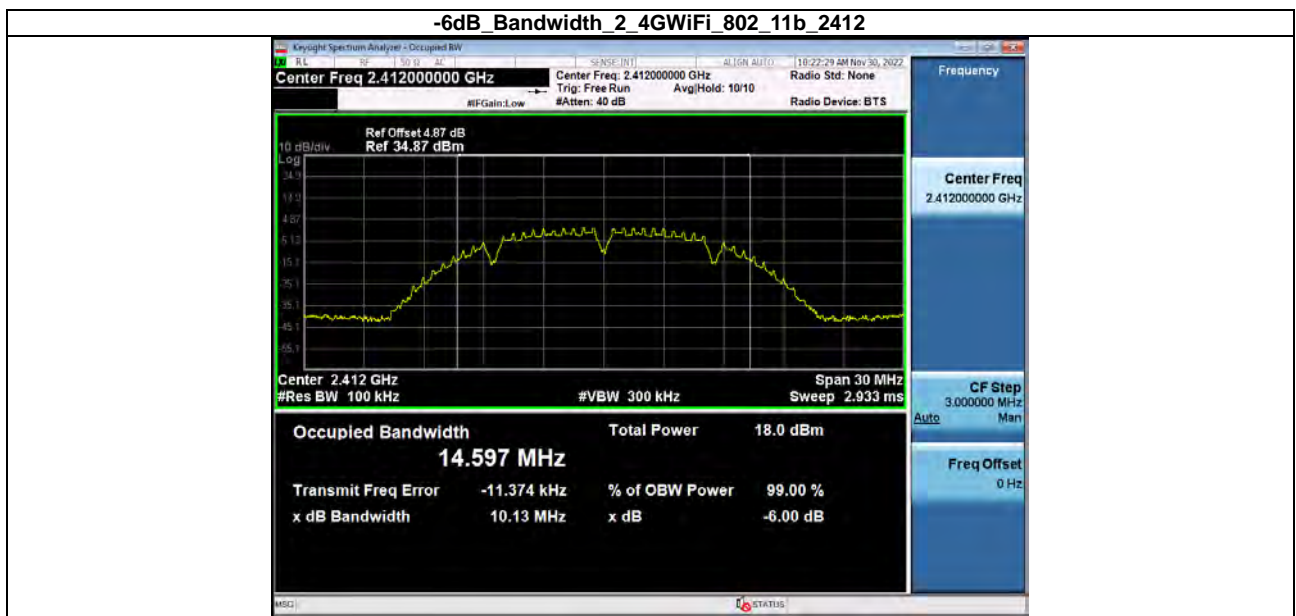

-6dB_Bandwidth_2_4WiFi_802_11b_2437



-6dB Bandwidth 2_4WiFi_802_11b_2462



-6dB Bandwidth 2_4WiFi_802_11g_2412

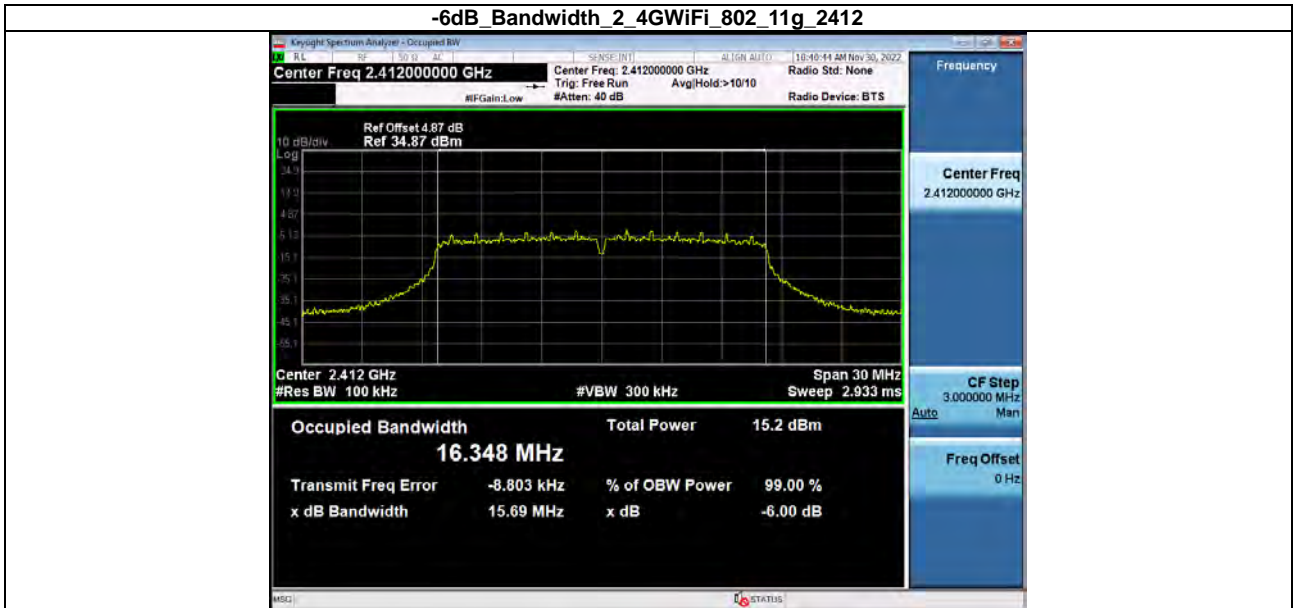

-6dB Bandwidth 2_4GWiFi_802_11g_2437

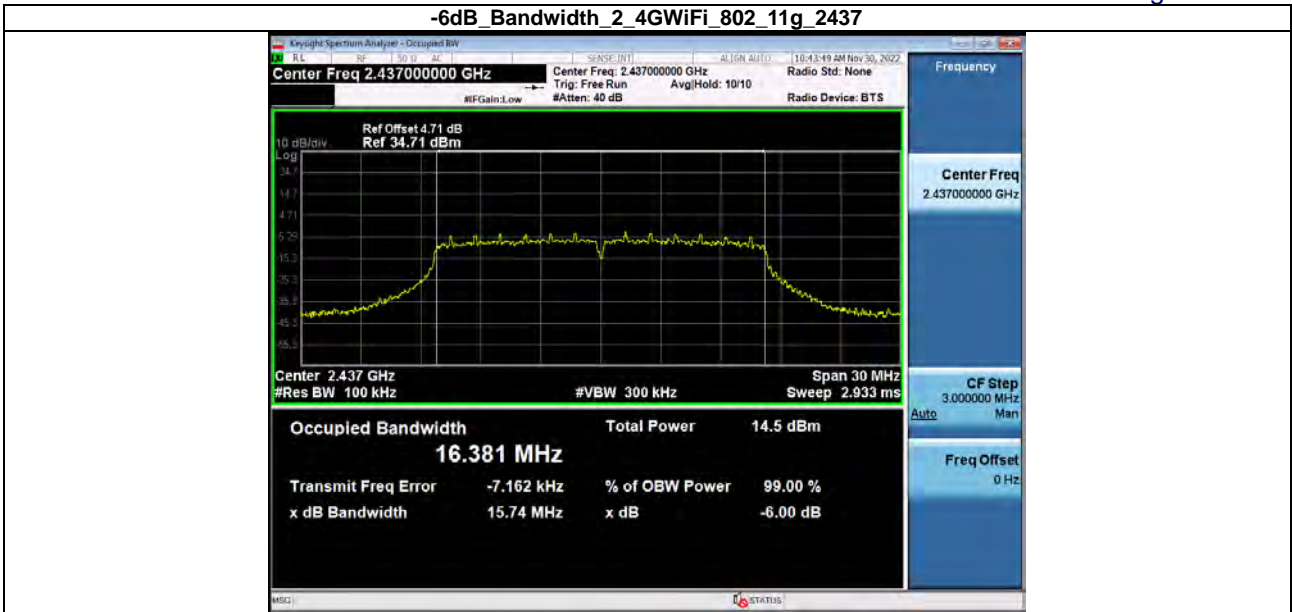

-6dB Bandwidth 2_4GWiFi_802_11g_2462

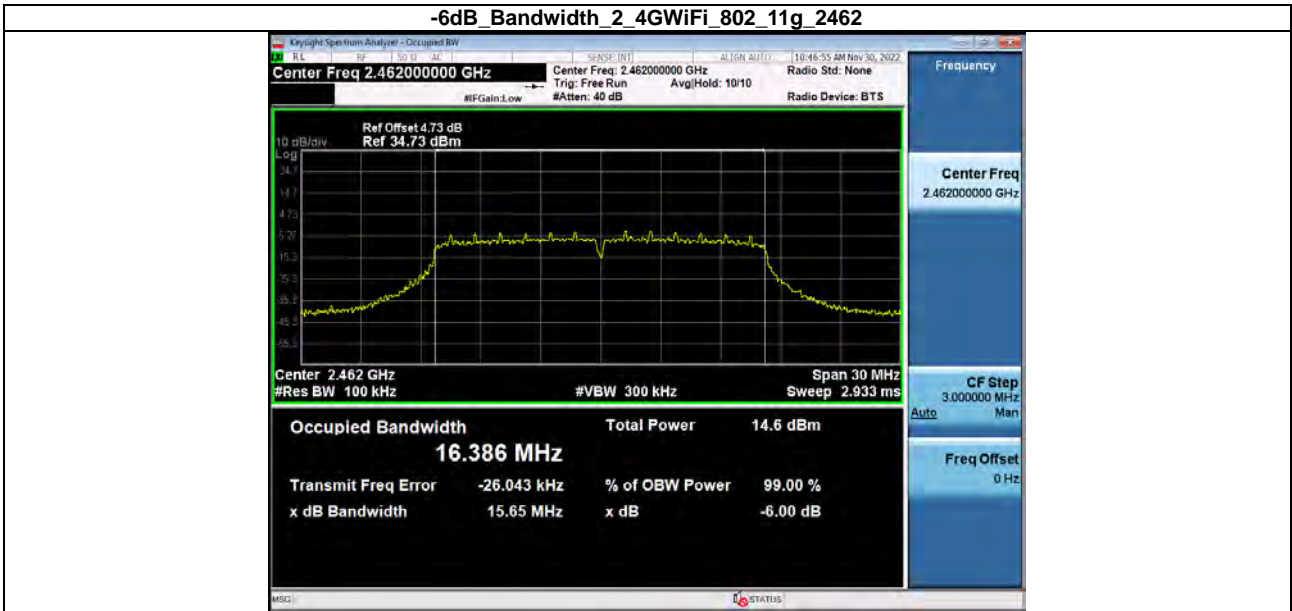

-6dB Bandwidth 2_4GWiFi_802_11n(HT20)_2412

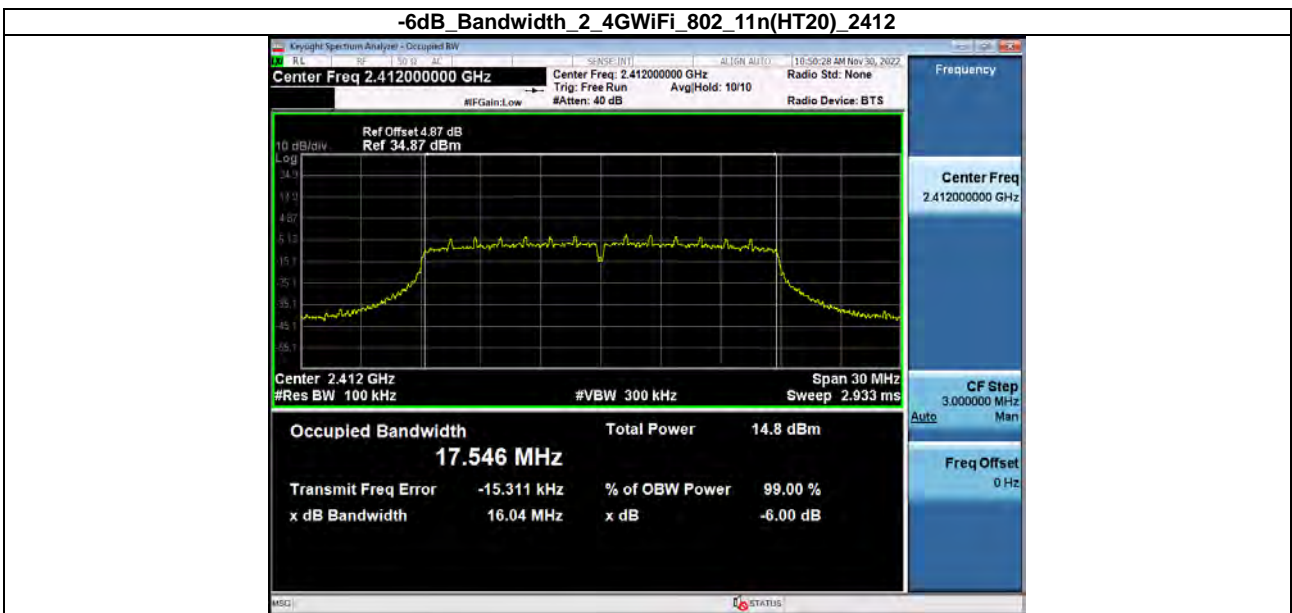

-6dB_Bandwidth_2_4WiFi_802_11n(HT20)_2437



-6dB_Bandwidth_2_4WiFi_802_11n(HT20)_2462

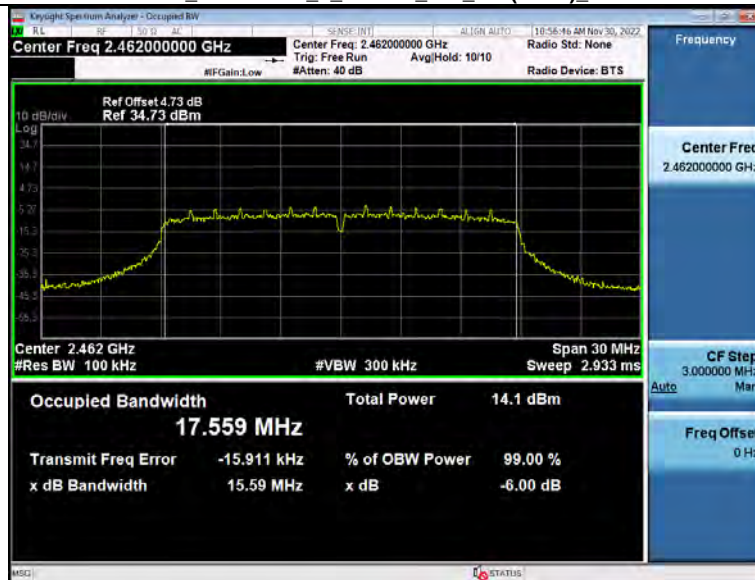

ANT2

-6dB_Bandwidth_2_4WiFi_802_11b_2412



-6dB_Bandwidth_2_4WiFi_802_11b_2437

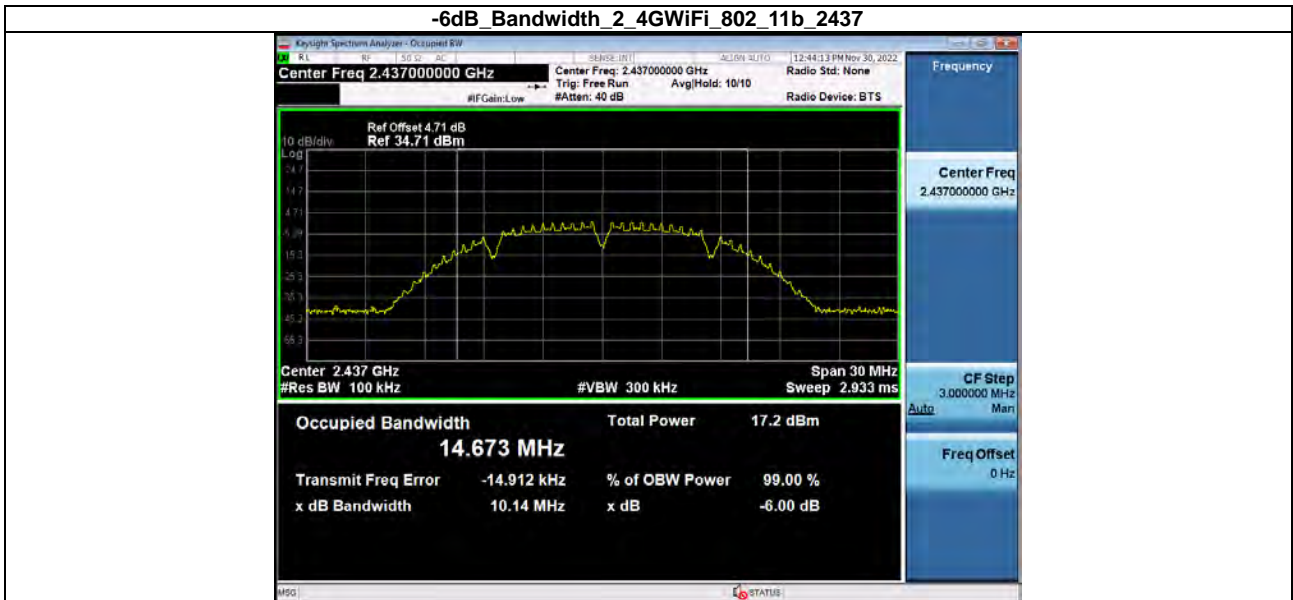

-6dB_Bandwidth_2_4WiFi_802_11b_2462

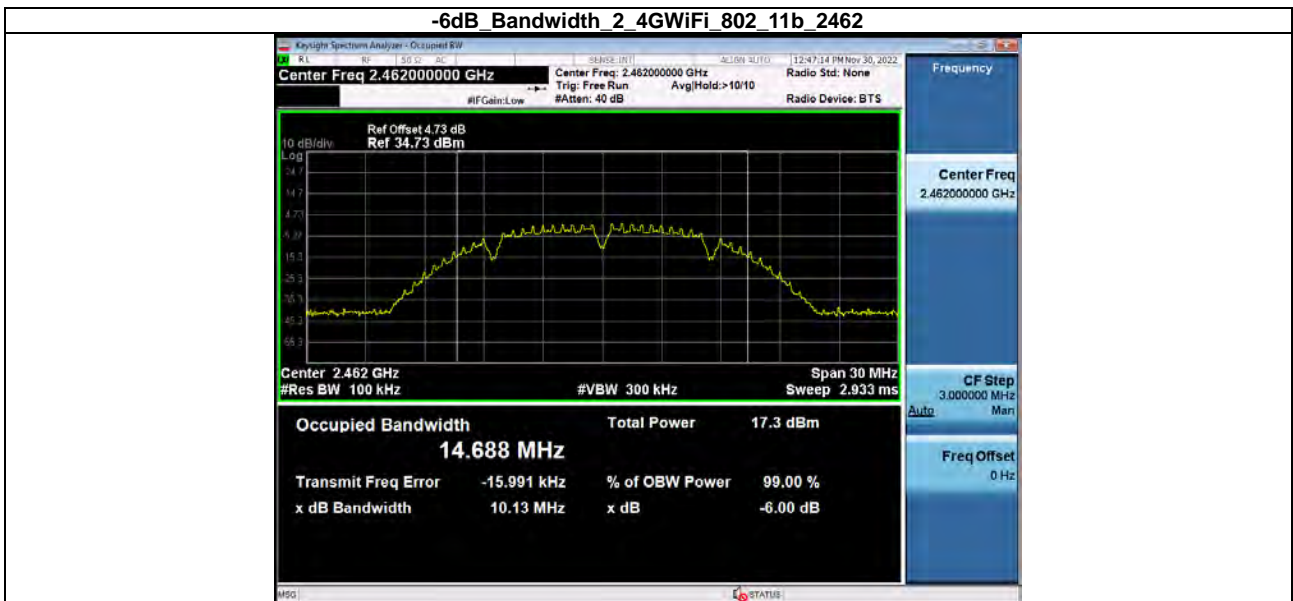

-6dB_Bandwidth_2_4WiFi_802_11g_2412

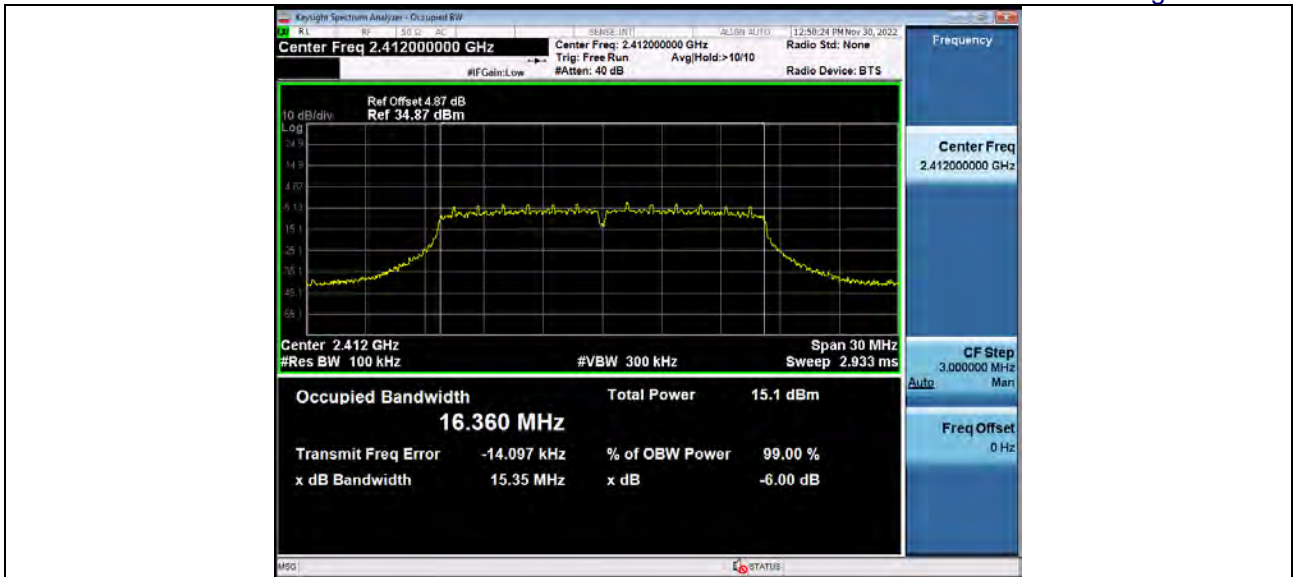

-6dB_Bandwidth_2_4WiFi_802_11g_2437

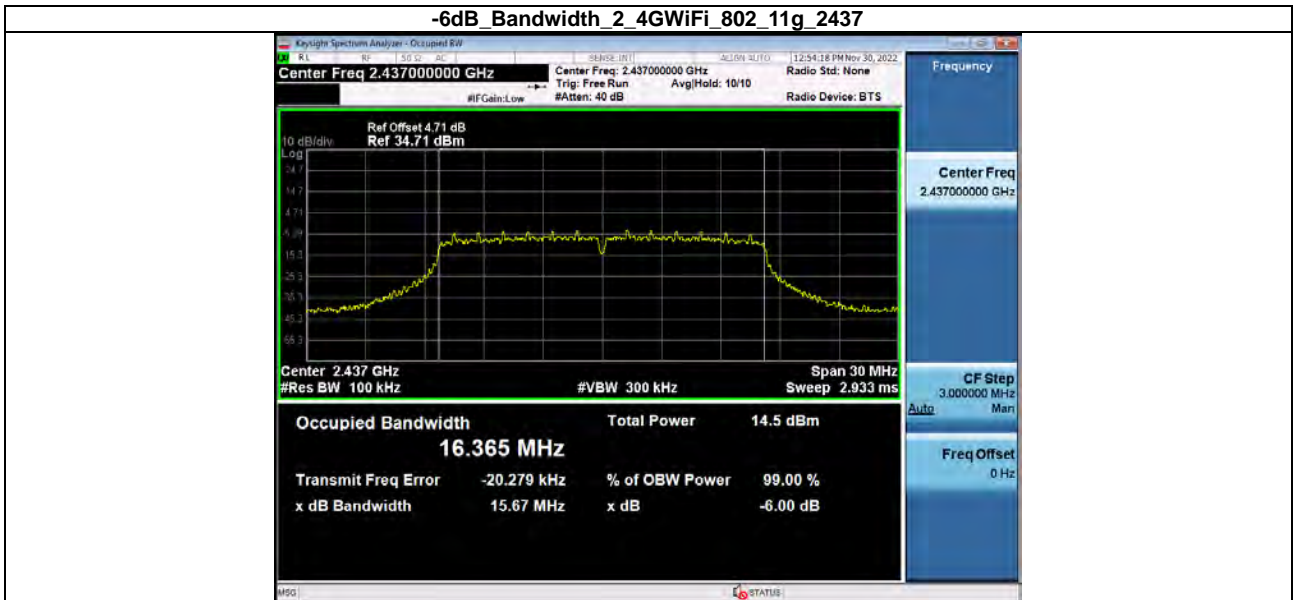

-6dB_Bandwidth_2_4WiFi_802_11g_2462

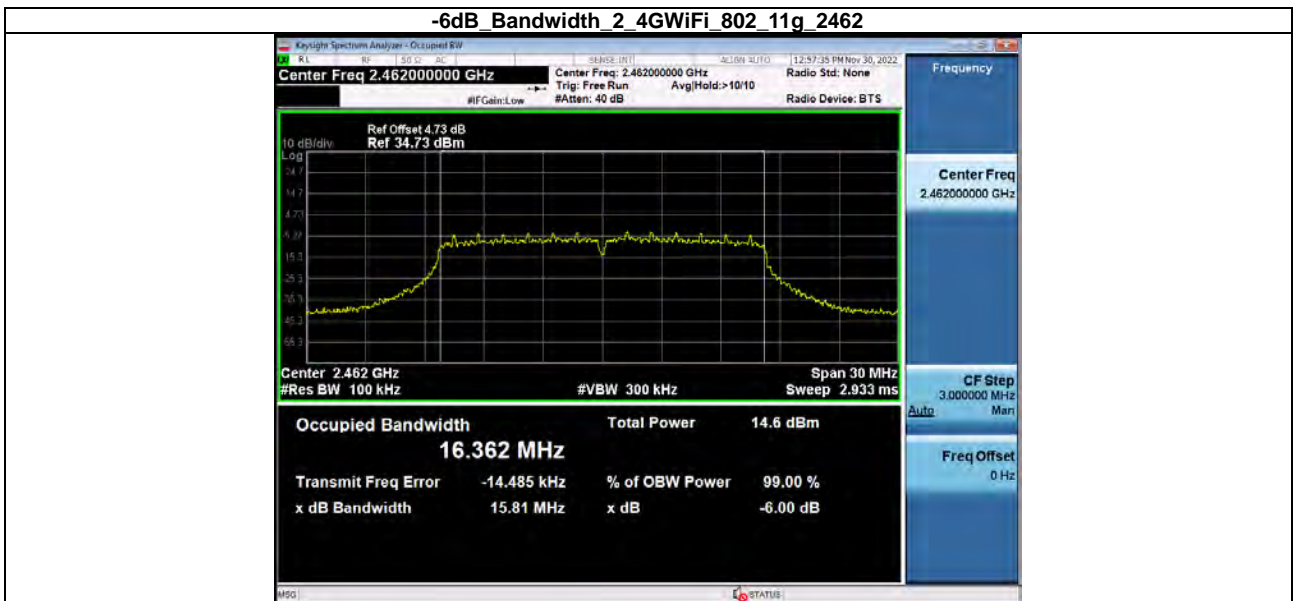

-6dB_Bandwidth_2_4WiFi_802_11n(HT20)_2412

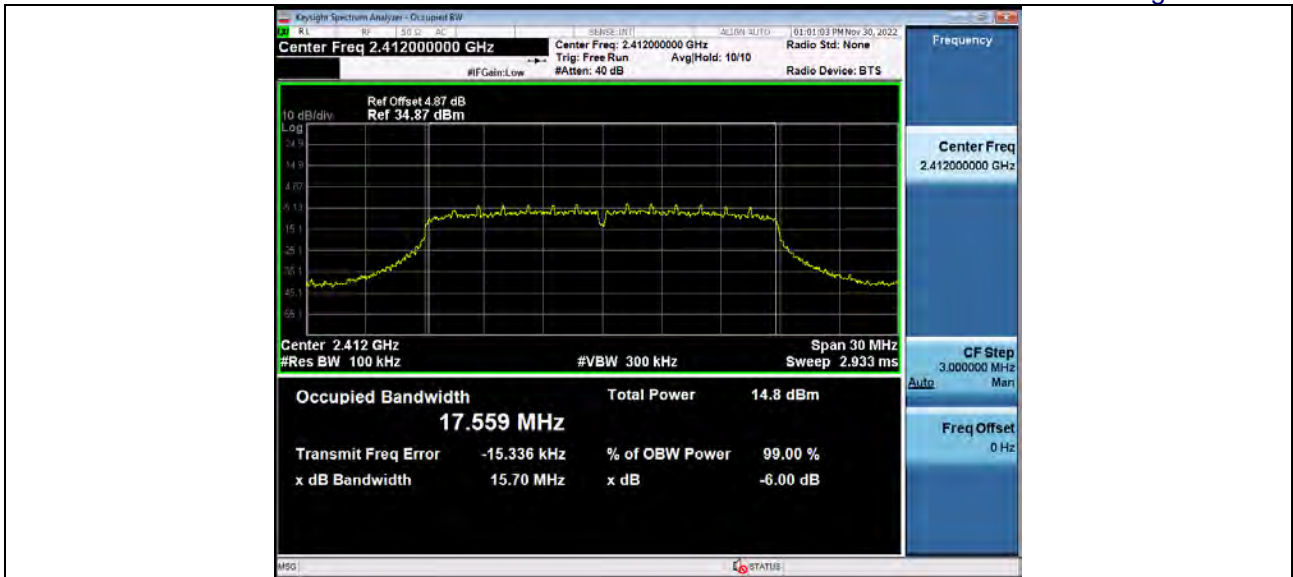

-6dB_Bandwidth_2_4WiFi_802_11n(HT20)_2437



-6dB_Bandwidth_2_4WiFi_802_11n(HT20)_2462

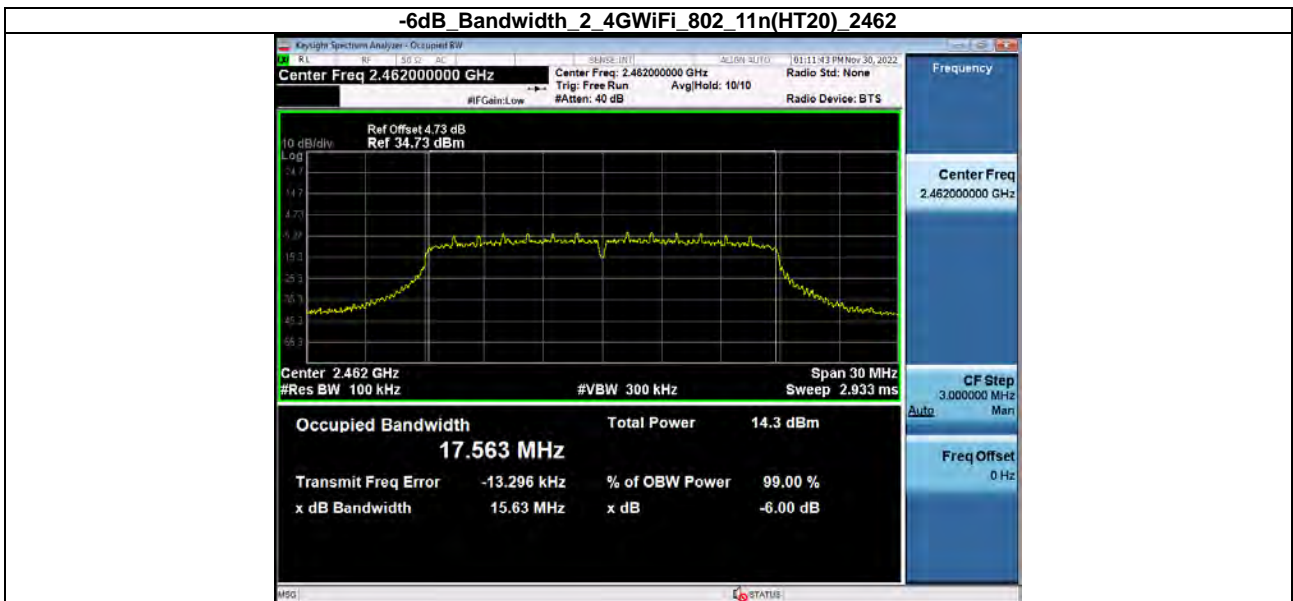

11.3. BANDEDGE

Condition	Antenna	Modulation	TX_Frequency (MHz)	Max. Mark_frequency(MHz)	Spurious level(dBm)	limit(dBm)	Result
NVNT	ANT1	802.11b	2412.00	2397.47	-37.73	-18.81	Pass
NVNT	ANT1	802.11b	2462.00	2491.22	-38.88	-19.37	Pass
NVNT	ANT1	802.11g	2412.00	2399.71	-37.13	-22.41	Pass
NVNT	ANT1	802.11g	2462.00	2493.47	-39.15	-23.04	Pass
NVNT	ANT1	802.11n(HT20)	2412.00	2399.94	-37.52	-22.65	Pass
NVNT	ANT1	802.11n(HT20)	2462.00	2498.61	-39.31	-23.34	Pass
NVNT	ANT1	802.11n(HT40)	2422.00	2378.77	-39.13	-26.37	Pass
NVNT	ANT1	802.11n(HT40)	2452.00	2484.97	-39.68	-26.78	Pass

Condition	Antenna	Modulation	TX_Frequency (MHz)	Max. Mark_frequency(MHz)	Spurious level(dBm)	limit(dBm)	Result
NVNT	ANT2	802.11b	2412.00	2397.02	-37.61	-19.11	Pass
NVNT	ANT2	802.11b	2462.00	2494.91	-39.20	-19.38	Pass
NVNT	ANT2	802.11g	2412.00	2398.82	-37.50	-22.47	Pass
NVNT	ANT2	802.11g	2462.00	2495.06	-38.71	-23.00	Pass
NVNT	ANT2	802.11n(HT20)	2412.00	2399.82	-36.43	-22.70	Pass
NVNT	ANT2	802.11n(HT20)	2462.00	2489.58	-38.99	-23.33	Pass
NVNT	ANT2	802.11n(HT40)	2422.00	2387.62	-38.35	-26.36	Pass
NVNT	ANT2	802.11n(HT40)	2452.00	2494.63	-39.27	-27.04	Pass

ANT1

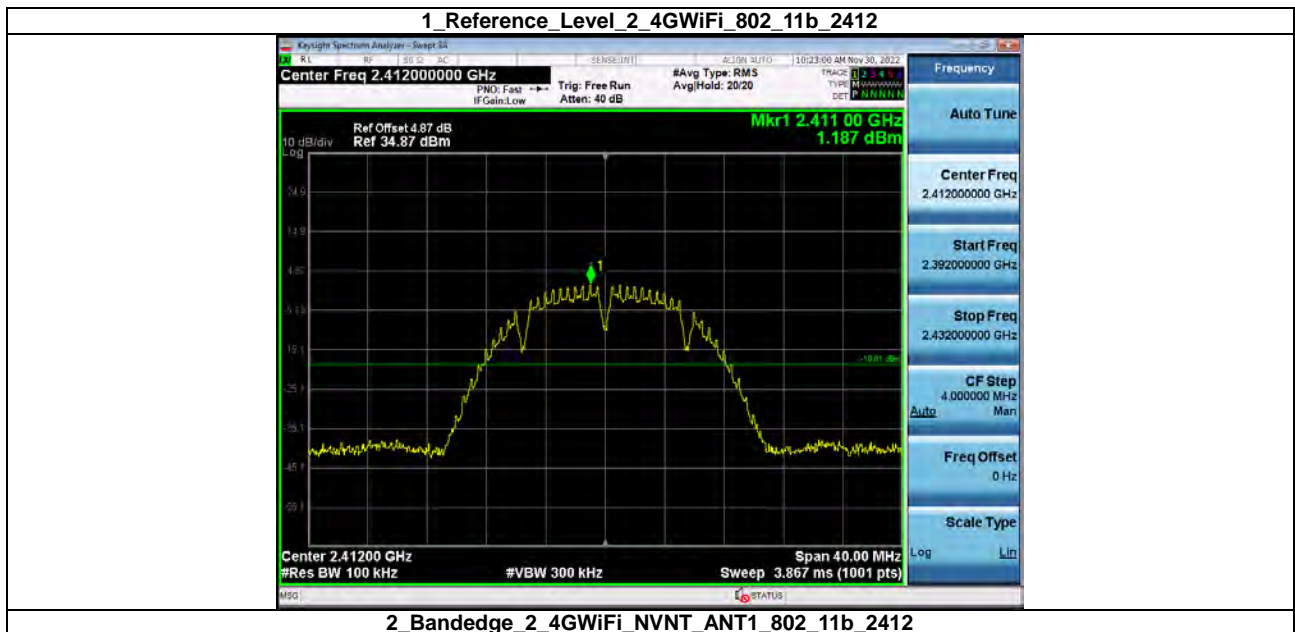

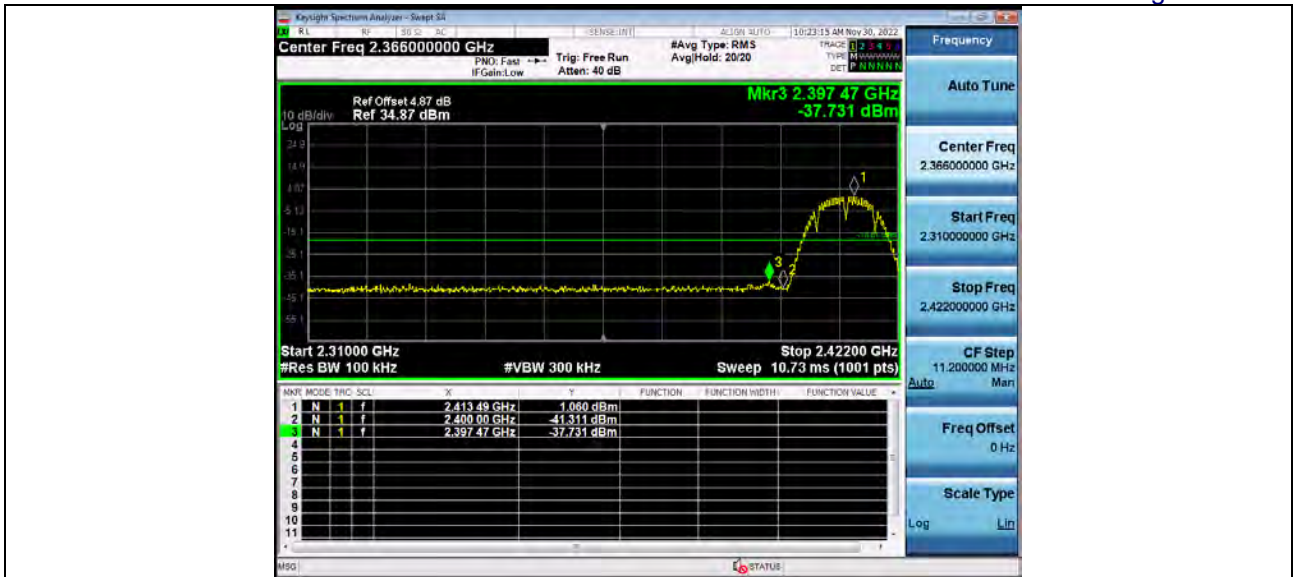

1 Reference Level 2_4GWiFi 802_11b_2462

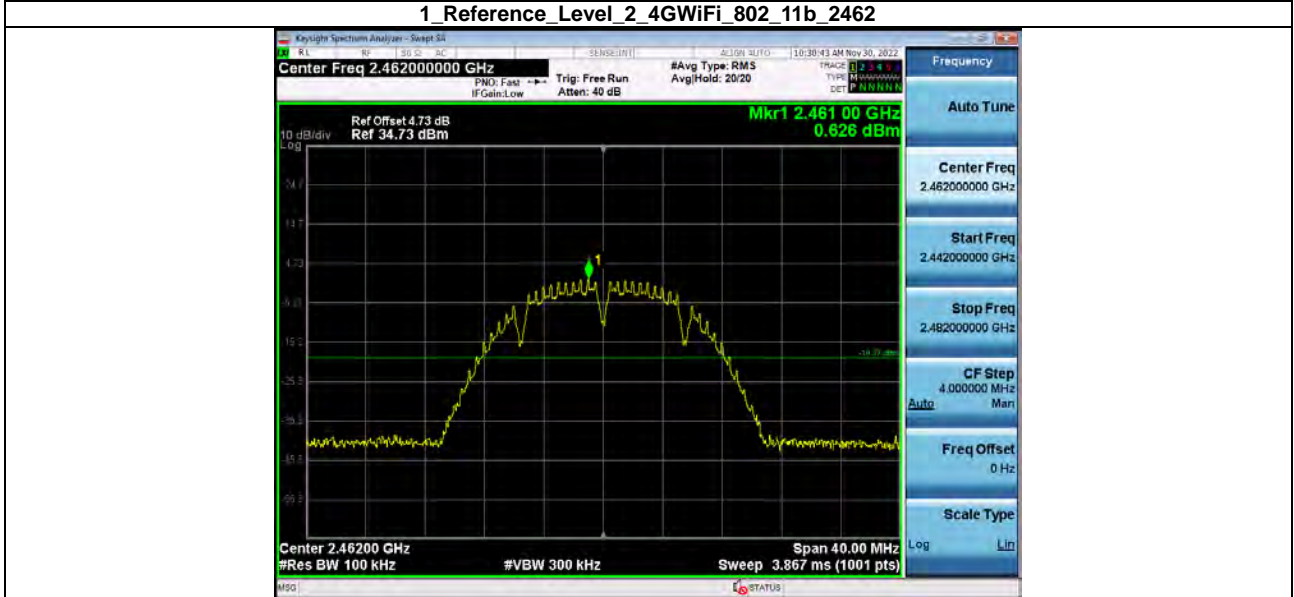

2 Bandedge 2_4GWiFi_NVNT_ANT1_802_11b_2462



1 Reference Level 2_4GWiFi 802_11g_2412



2_Bandedge 2_4GWiFi_NVNT_ANT1_802_11g_2412

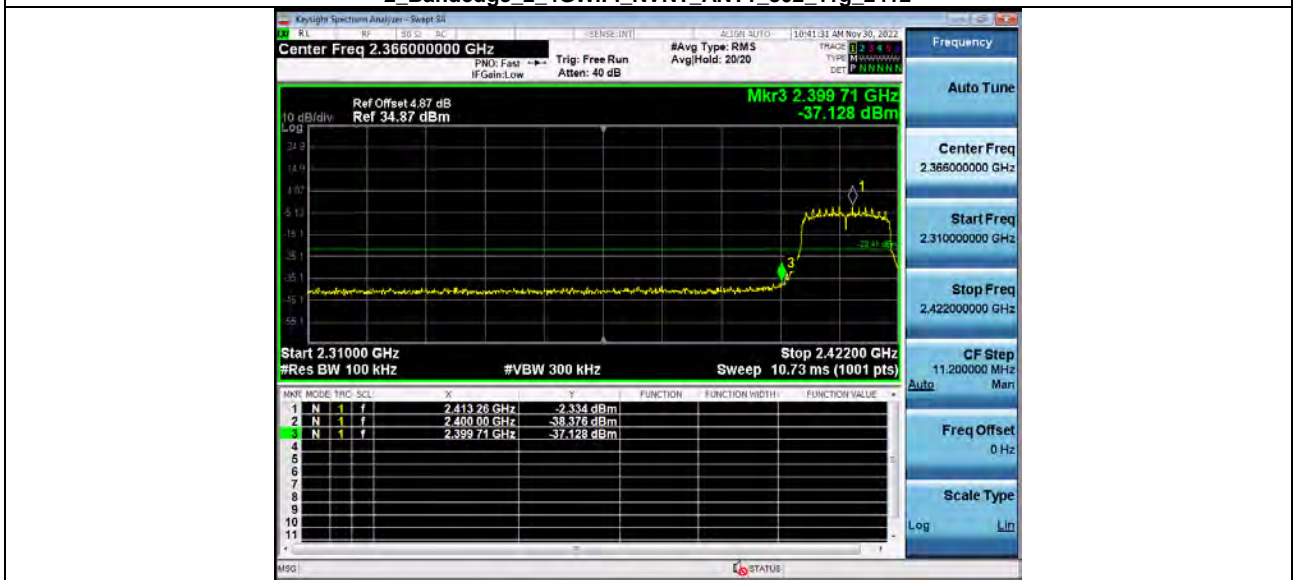

1_Reference Level 2_4GWiFi_802_11g_2462



2_Bandedge_2_4GWiFi_NVNT_ANT1_802_11g_2462



1_Reference_Level_2_4GWiFi_802_11n(HT20)_2412

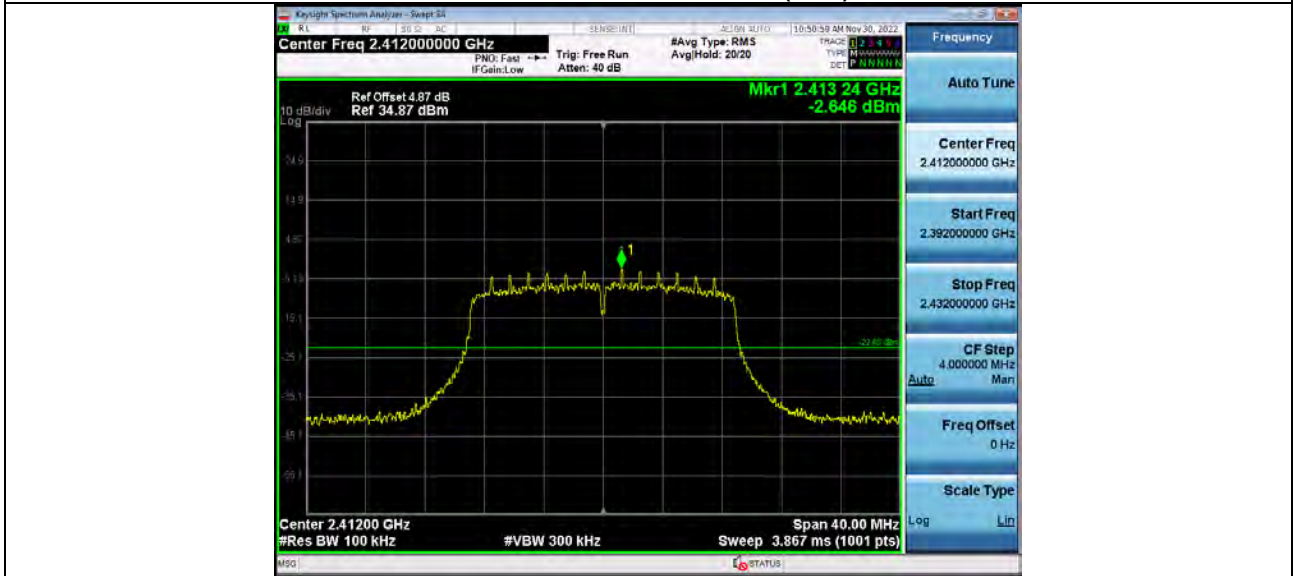

2_Bandedge_2_4GWiFi_NVNT_ANT1_802_11n(HT20)_2412

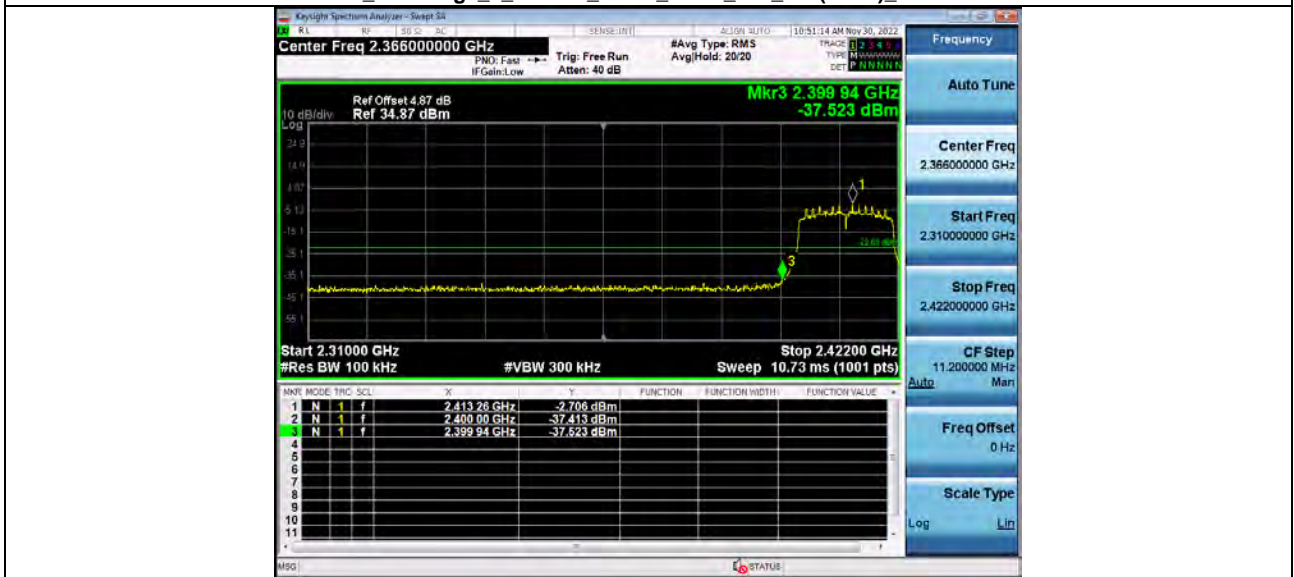

1_Reference_Level_2_4GWiFi_802_11n(HT20)_2462



2_Bandedge 2_4GWiFi_NVNT_ANT1_802_11n(HT20)_2462

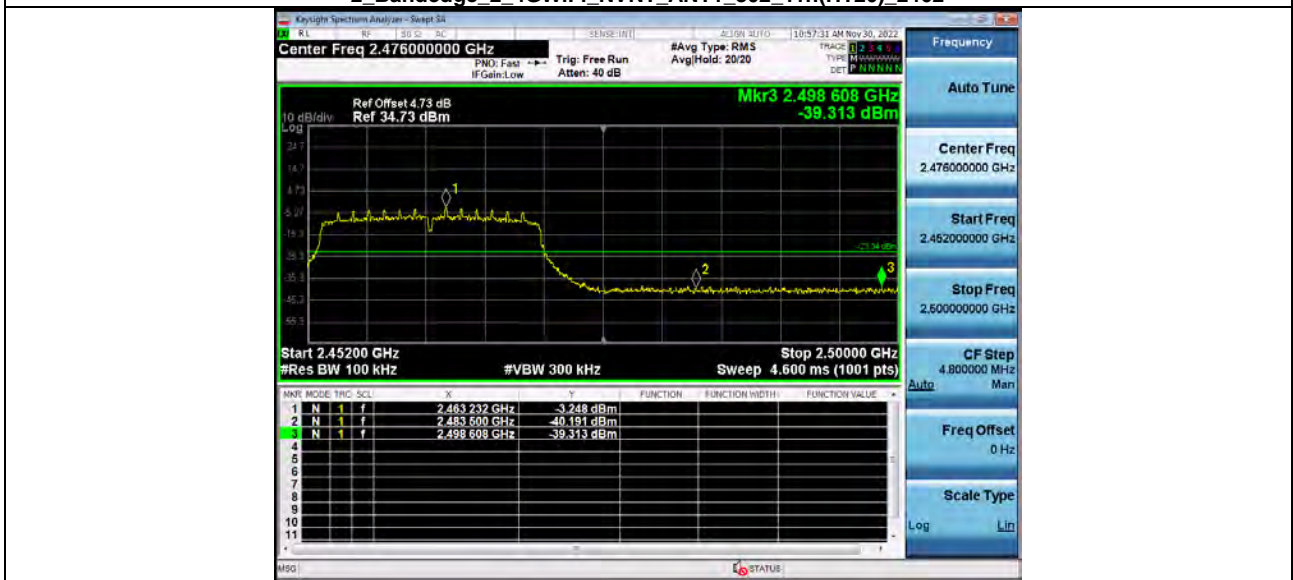

ANT2

1_Reference_Level 2_4GWiFi_802_11b_2412

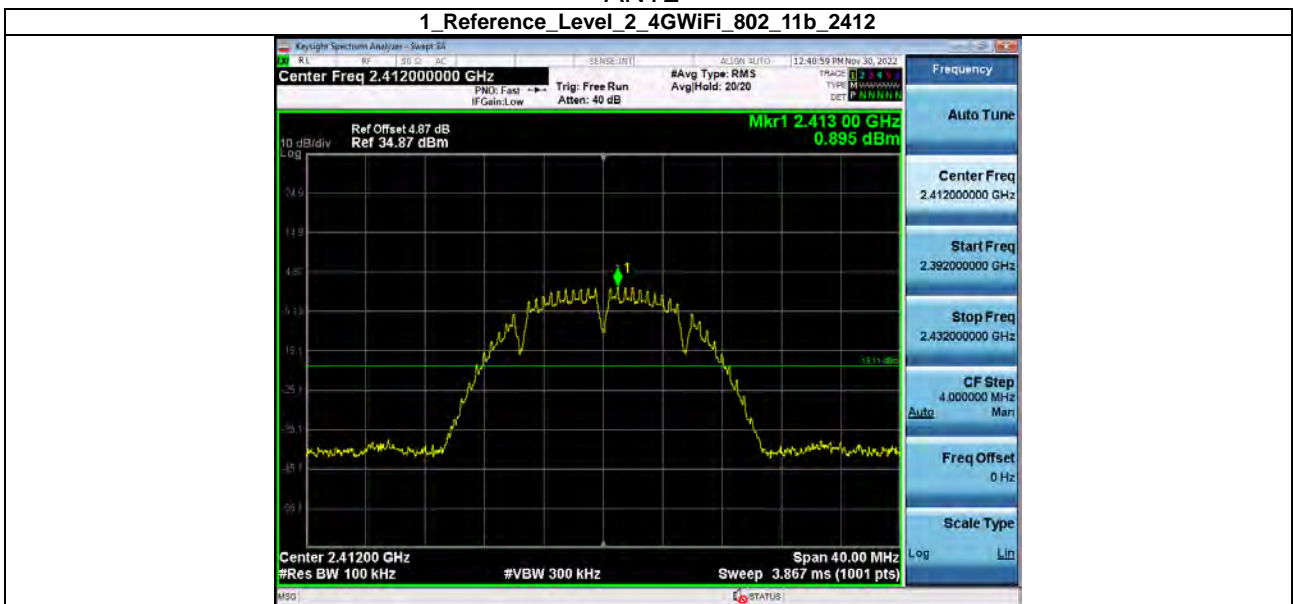

2_Bandedge 2_4GWiFi_NVNT_ANT1_802_11b_2412

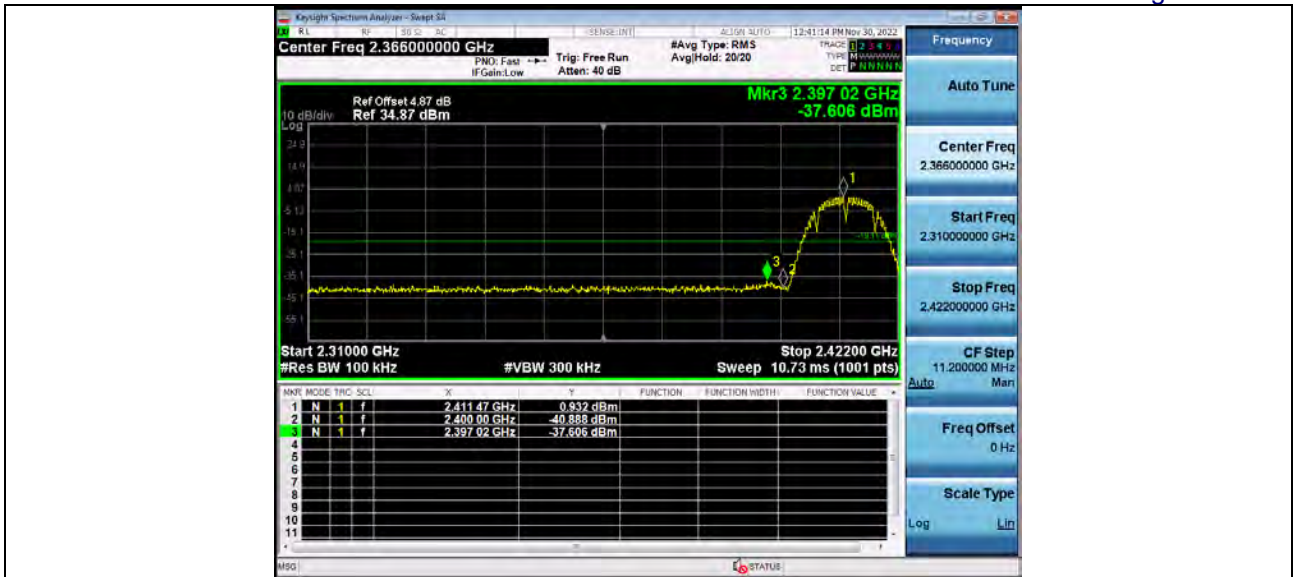

1 Reference Level 2_4GWiFi 802_11b_2462

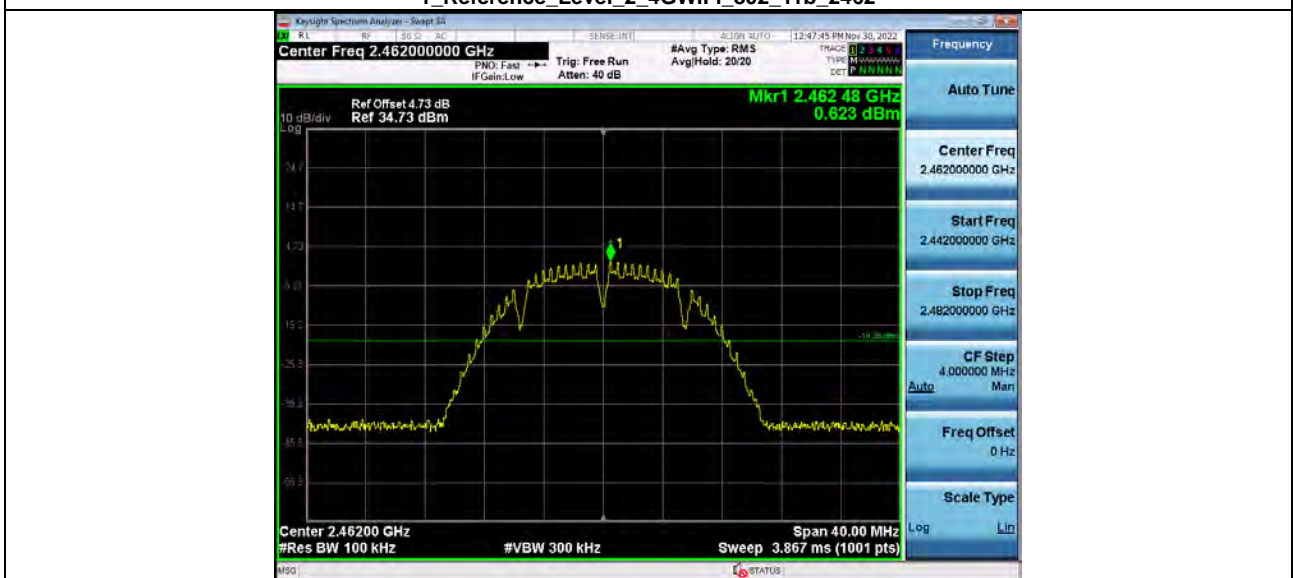

2 Bandedge 2_4GWiFi_NVNT_ANT1_802_11b_2462



1 Reference Level 2_4GWiFi 802_11g_2412



2_Bandedge 2_4GWiFi_NVNT_ANT1_802_11g_2412



1_Reference Level 2_4GWiFi_802_11g_2462

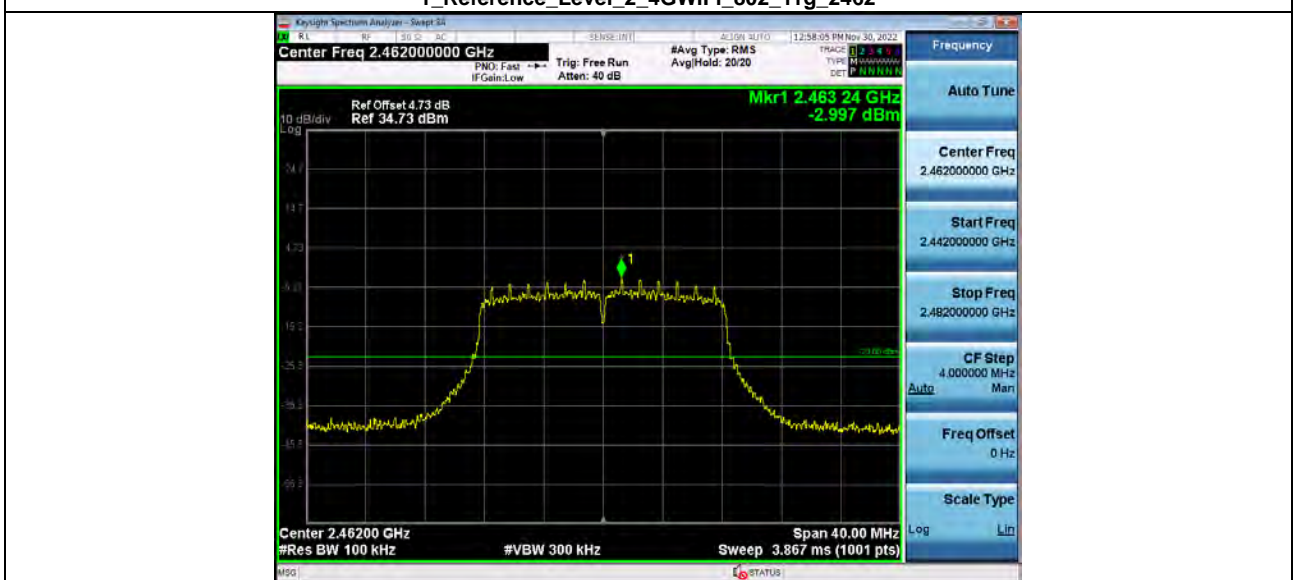

2_Bandedge_2_4GWiFi_NVNT_ANT1_802_11g_2462



1_Reference_Level_2_4GWiFi_802_11n(HT20)_2412



2_Bandedge_2_4GWiFi_NVNT_ANT1_802_11n(HT20)_2412

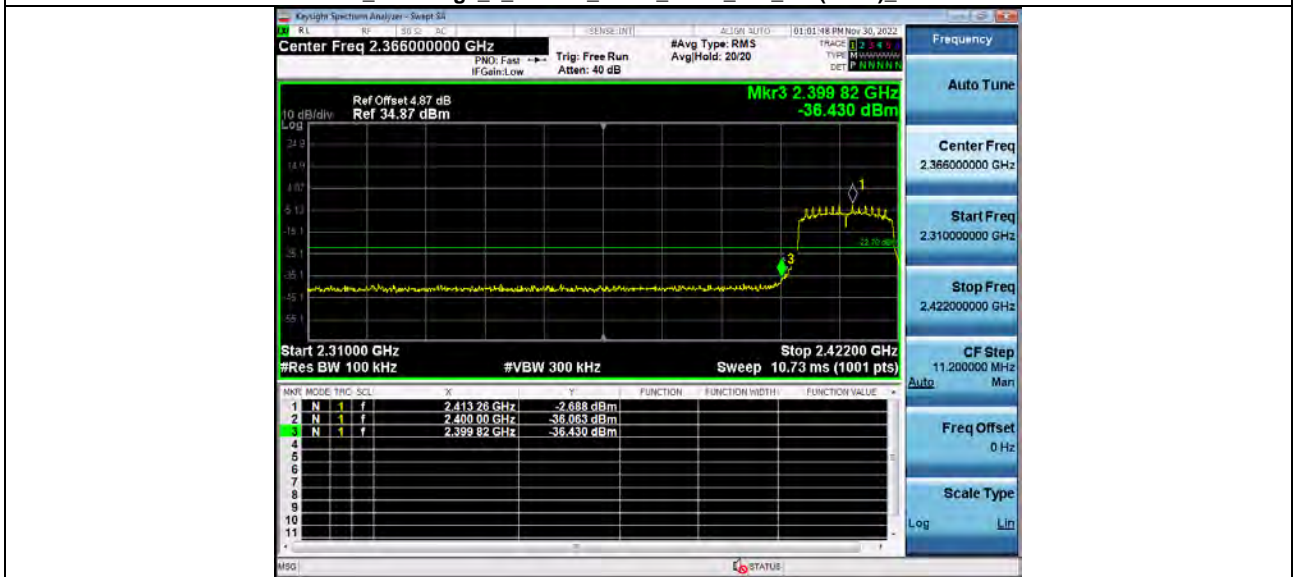

1_Reference_Level_2_4GWiFi_802_11n(HT20)_2462

11.4. MAX. OUTPUT POWER

Condition	Antenna	Modulation	Frequency (MHz)	Conducted Power(dBm)	limit(dBm)	Result
NVNT	ANT1	802.11b	2412.00	13.52	30	Pass
NVNT	ANT1	802.11b	2437.00	12.94	30	Pass
NVNT	ANT1	802.11b	2462.00	13.04	30	Pass
NVNT	ANT1	802.11g	2412.00	15.75	30	Pass
NVNT	ANT1	802.11g	2437.00	15.53	30	Pass
NVNT	ANT1	802.11g	2462.00	15.59	30	Pass
NVNT	ANT1	802.11n(HT20)	2412.00	15.73	30	Pass
NVNT	ANT1	802.11n(HT20)	2437.00	14.51	30	Pass
NVNT	ANT1	802.11n(HT20)	2462.00	15.18	30	Pass

Condition	Antenna	Modulation	Frequency (MHz)	Conducted Power(dBm)	limit(dBm)	Result
NVNT	ANT2	802.11b	2412.00	13.23	30	Pass
NVNT	ANT2	802.11b	2437.00	12.86	30	Pass
NVNT	ANT2	802.11b	2462.00	13.01	30	Pass
NVNT	ANT2	802.11g	2412.00	16.29	30	Pass
NVNT	ANT2	802.11g	2437.00	15.48	30	Pass
NVNT	ANT2	802.11g	2462.00	15.70	30	Pass
NVNT	ANT2	802.11n(HT20)	2412.00	15.83	30	Pass
NVNT	ANT2	802.11n(HT20)	2437.00	15.08	30	Pass
NVNT	ANT2	802.11n(HT20)	2462.00	15.19	30	Pass

Condition	Antenna	Modulation	Frequency (MHz)	Conducted Power(dBm)	limit(dBm)	Result
NVNT	MIMO	802.11n(HT20)	2412.00	18.79	30	Pass
NVNT	MIMO	802.11n(HT20)	2437.00	17.81	30	Pass
NVNT	MIMO	802.11n(HT20)	2462.00	18.20	30	Pass

11.5. POWER SPECTRAL DENSITY

Condition	Antenna	Modulation	Frequency (MHz)	PSD(dBm/3kHz)	limit(dBm/3kHz)	Result
NVNT	ANT1	802.11b	2412.00	-13.35	8	Pass
NVNT	ANT1	802.11b	2437.00	-13.48	8	Pass
NVNT	ANT1	802.11b	2462.00	-13.04	8	Pass
NVNT	ANT1	802.11g	2412.00	-16.53	8	Pass
NVNT	ANT1	802.11g	2437.00	-17.54	8	Pass
NVNT	ANT1	802.11g	2462.00	-17.08	8	Pass
NVNT	ANT1	802.11n(HT20)	2412.00	-16.22	8	Pass
NVNT	ANT1	802.11n(HT20)	2437.00	-18.34	8	Pass
NVNT	ANT1	802.11n(HT20)	2462.00	-17.44	8	Pass

Condition	Antenna	Modulation	Frequency (MHz)	PSD(dBm/3kHz)	limit(dBm/3kHz)	Result
NVNT	ANT2	802.11b	2412.00	-12.74	8	Pass
NVNT	ANT2	802.11b	2437.00	-14.07	8	Pass
NVNT	ANT2	802.11b	2462.00	-13.13	8	Pass
NVNT	ANT2	802.11g	2412.00	-16.62	8	Pass
NVNT	ANT2	802.11g	2437.00	-17.13	8	Pass
NVNT	ANT2	802.11g	2462.00	-17.50	8	Pass
NVNT	ANT2	802.11n(HT20)	2412.00	-17.67	8	Pass
NVNT	ANT2	802.11n(HT20)	2437.00	-18.13	8	Pass
NVNT	ANT2	802.11n(HT20)	2462.00	-18.10	8	Pass

Condition	Antenna	Modulation	Frequency (MHz)	PSD(dBm/3kHz)	limit(dBm/3kHz)	Result
NVNT	ANT2	802.11n(HT20)	2412.00	-13.87	8	Pass
NVNT	ANT2	802.11n(HT20)	2437.00	-15.22	8	Pass
NVNT	ANT2	802.11n(HT20)	2462.00	-14.75	8	Pass

ANT1



Power_Spectral_Density_2_4GWiFi_802_11b_2437



Power Spectral Density 2_4GWiFi_802_11b_2462



Power Spectral Density 2_4GWiFi_802_11g_2412

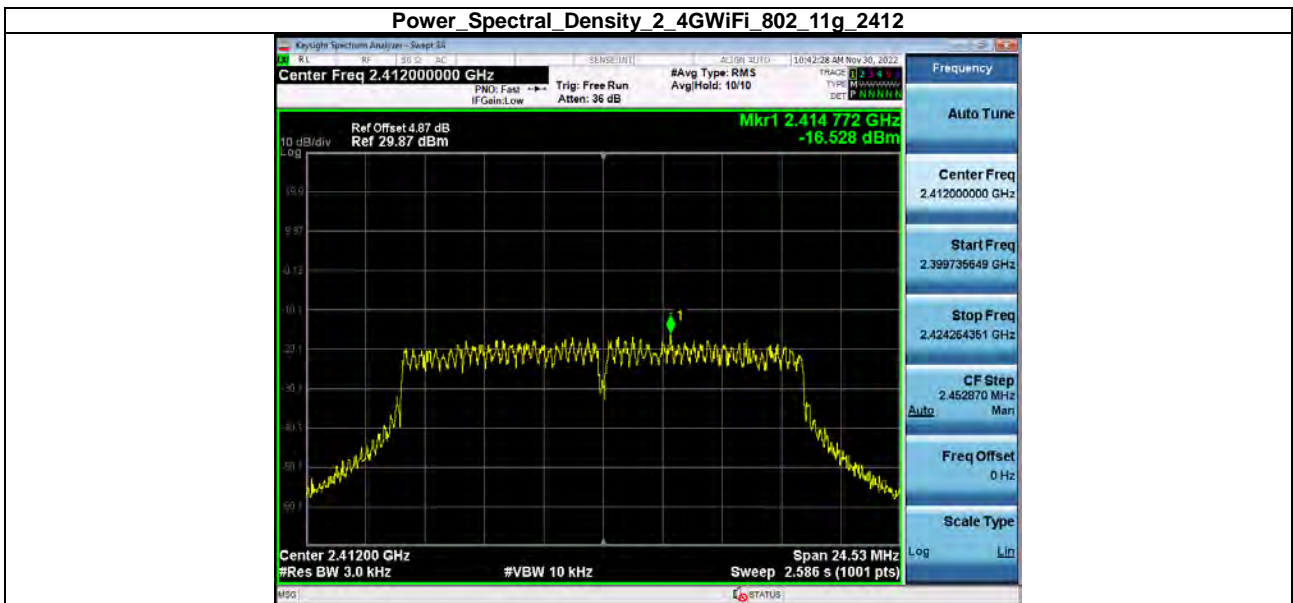

Power Spectral Density 2_4GWiFi_802_11g_2437

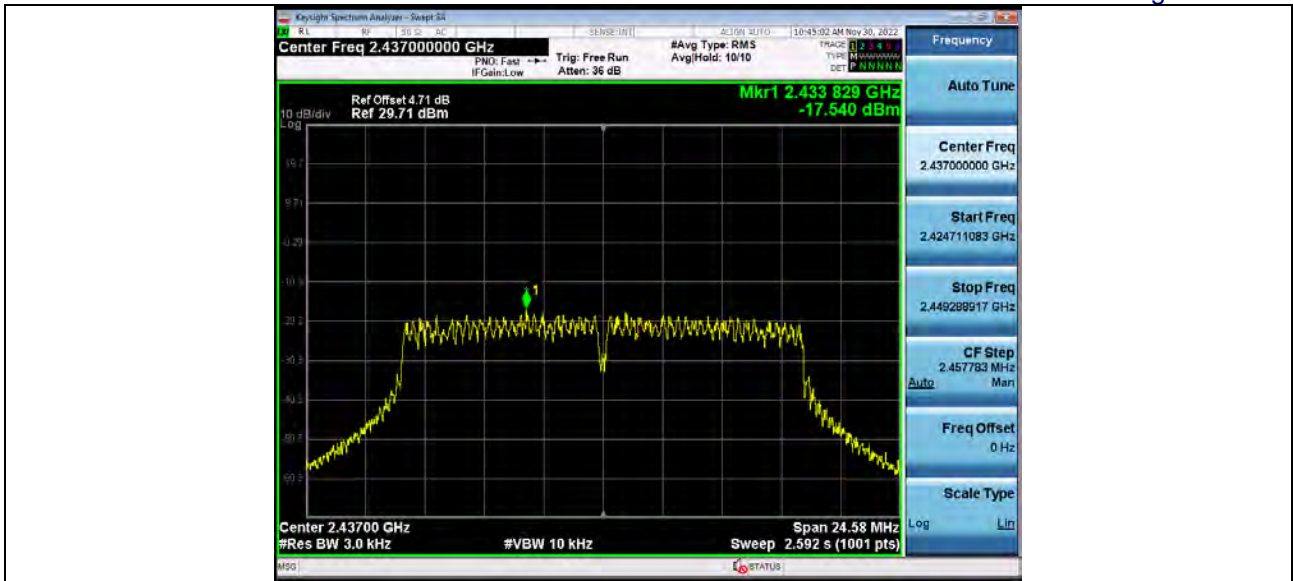

Power_Spectral_Density_2_4GWiFi_802_11g_2462

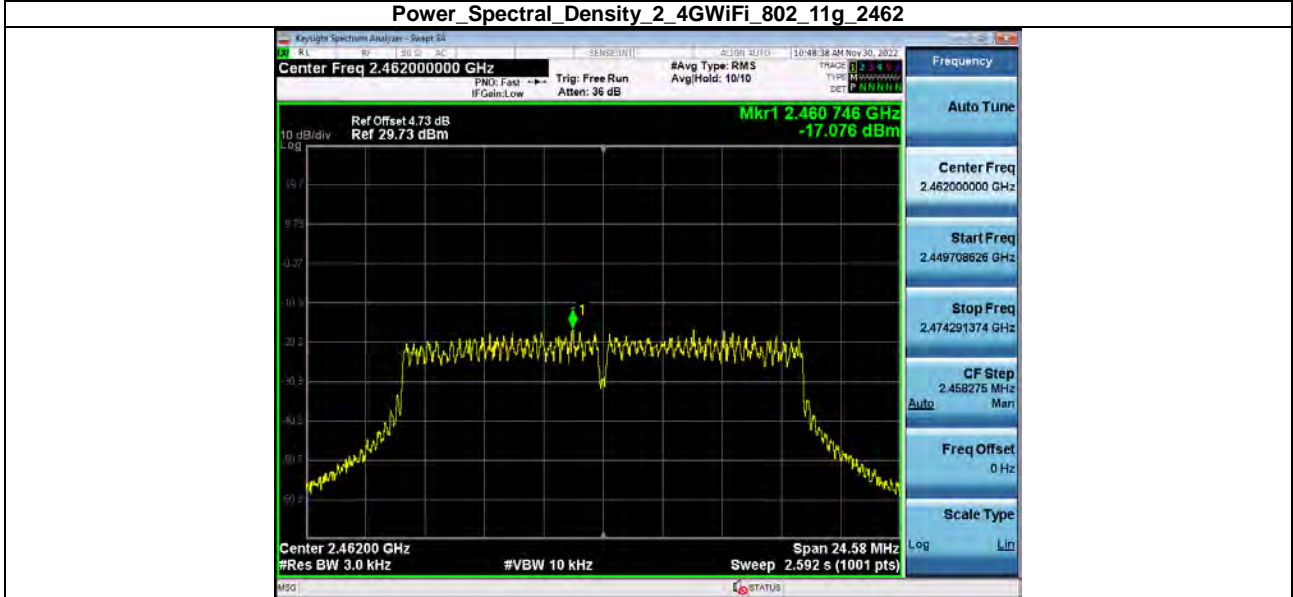

Power_Spectral_Density_2_4GWiFi_802_11n(HT20)_2412

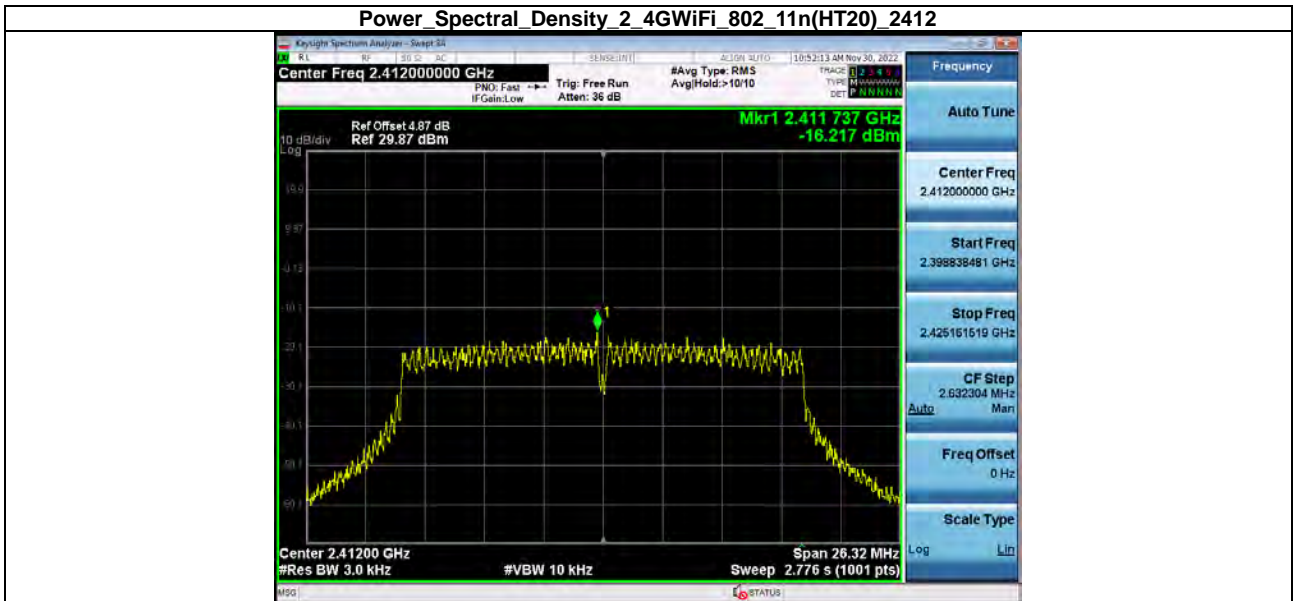

Power_Spectral_Density_2_4GWiFi_802_11n(HT20)_2437

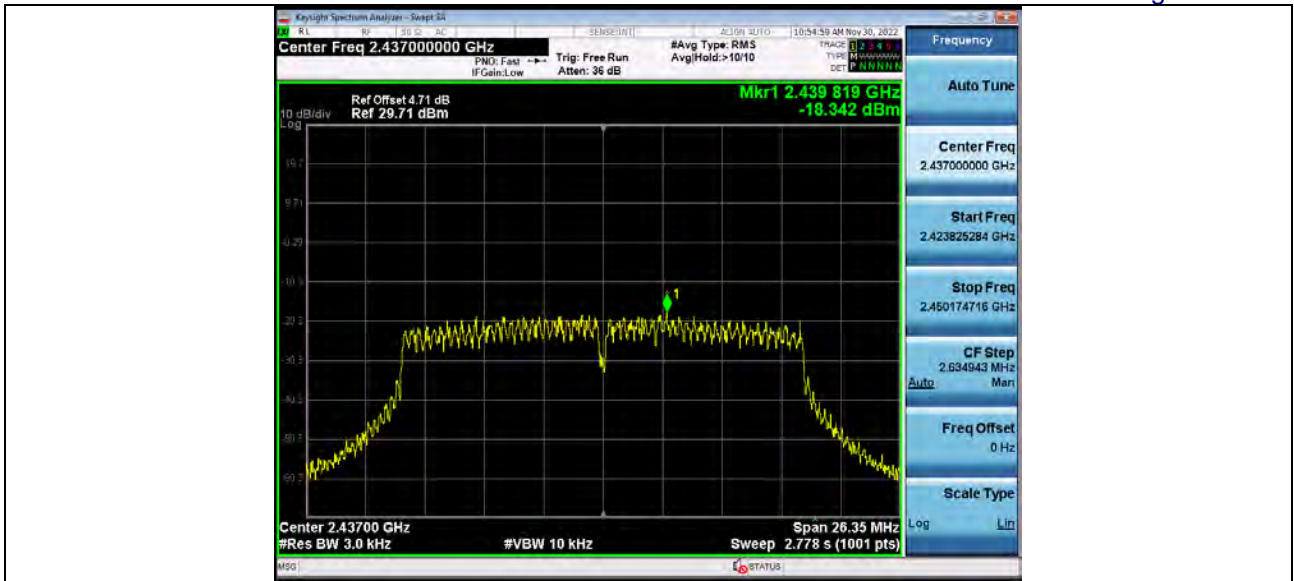

Power Spectral Density 2_4GWiFi_802_11n(HT20)_2462

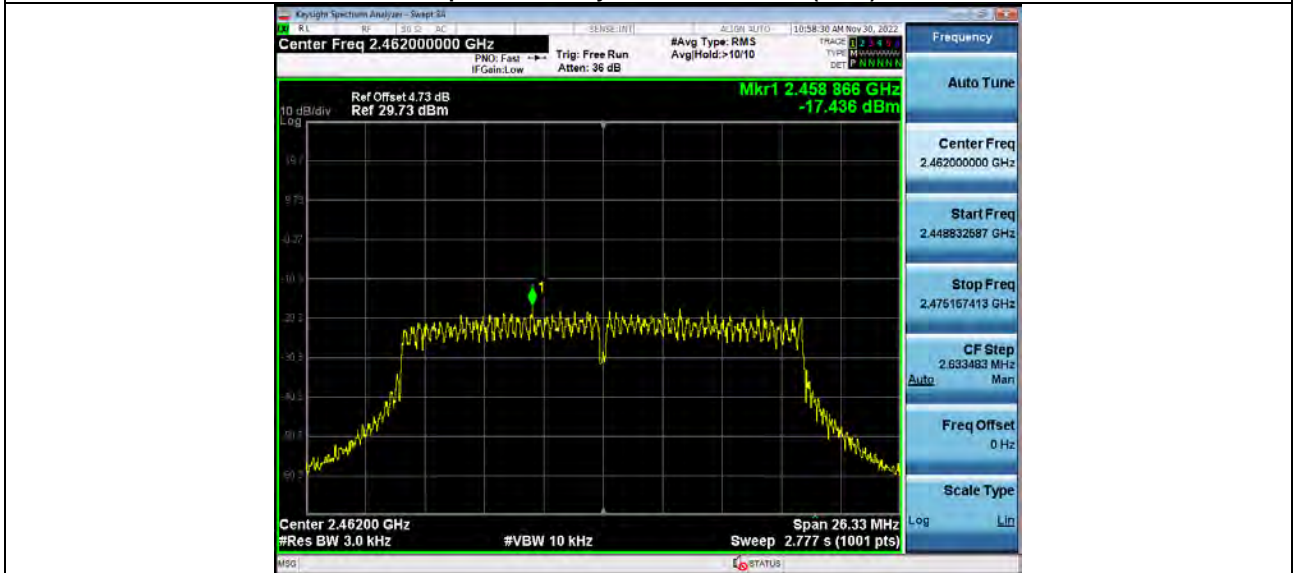

ANT2

Power Spectral Density 2_4GWiFi_802_11b_2412



Power Spectral Density 2_4GWiFi_802_11b_2437



Power Spectral Density 2_4GWiFi_802_11b_2462



Power Spectral Density 2_4GWiFi_802_11g_2412



Power Spectral Density 2_4GWiFi_802_11g_2437

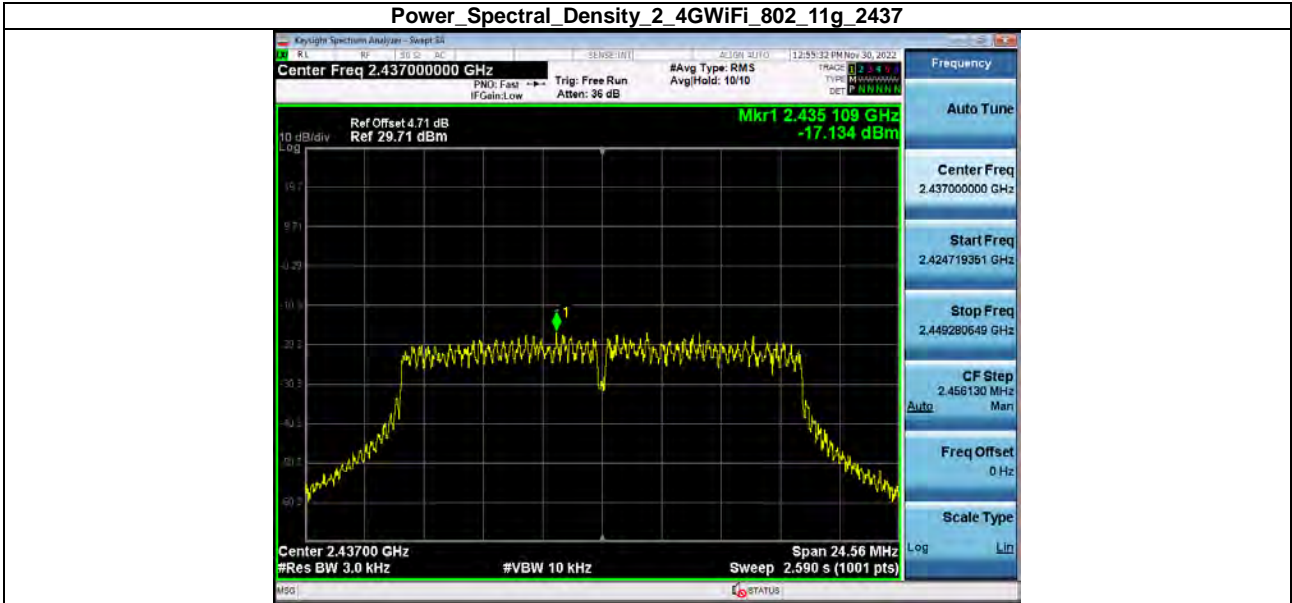

Power Spectral Density 2_4GWiFi_802_11g_2462

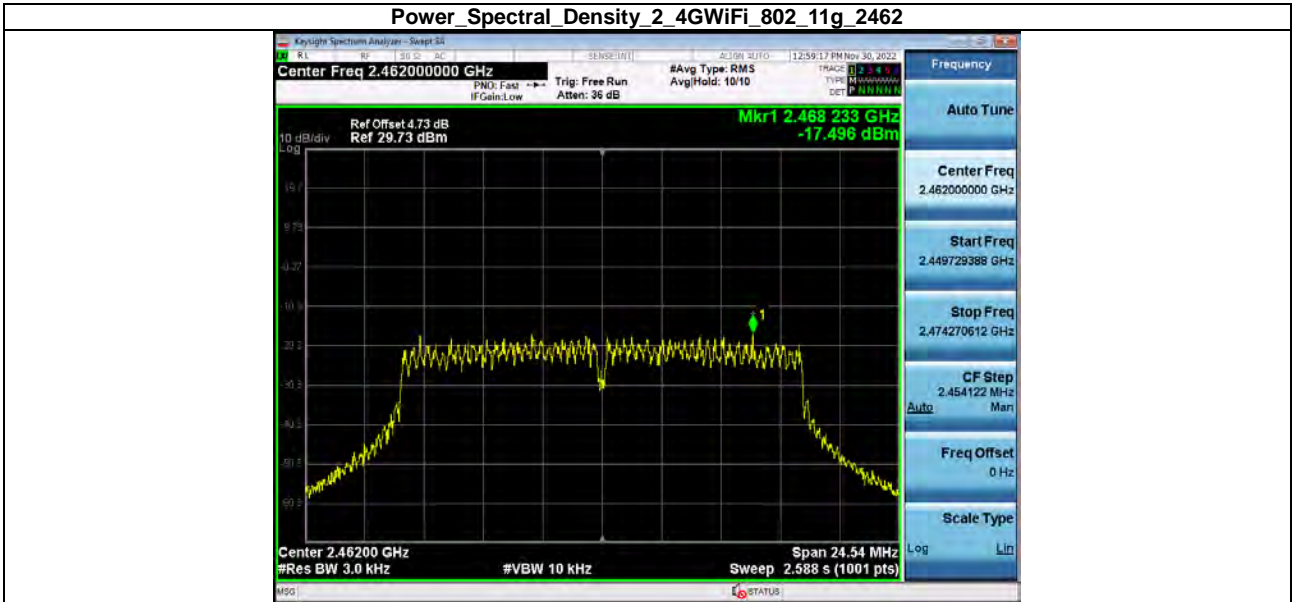

Power Spectral Density 2_4GWiFi_802_11n(HT20)_2412

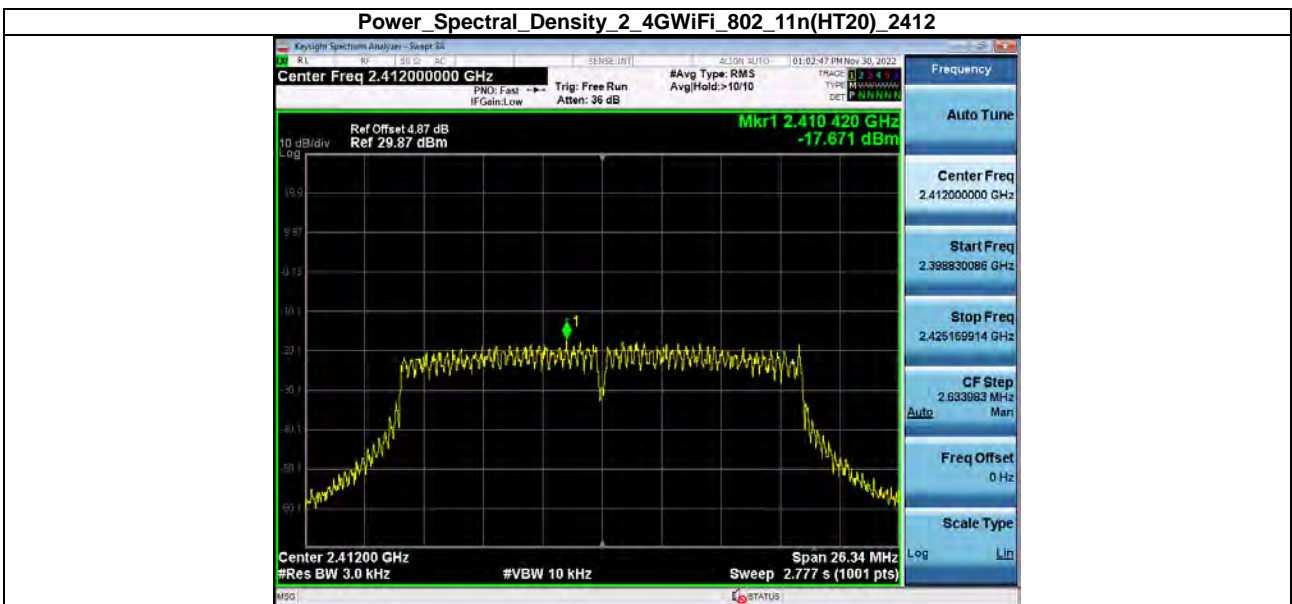

Power Spectral Density 2_4GWiFi_802_11n(HT20)_2437

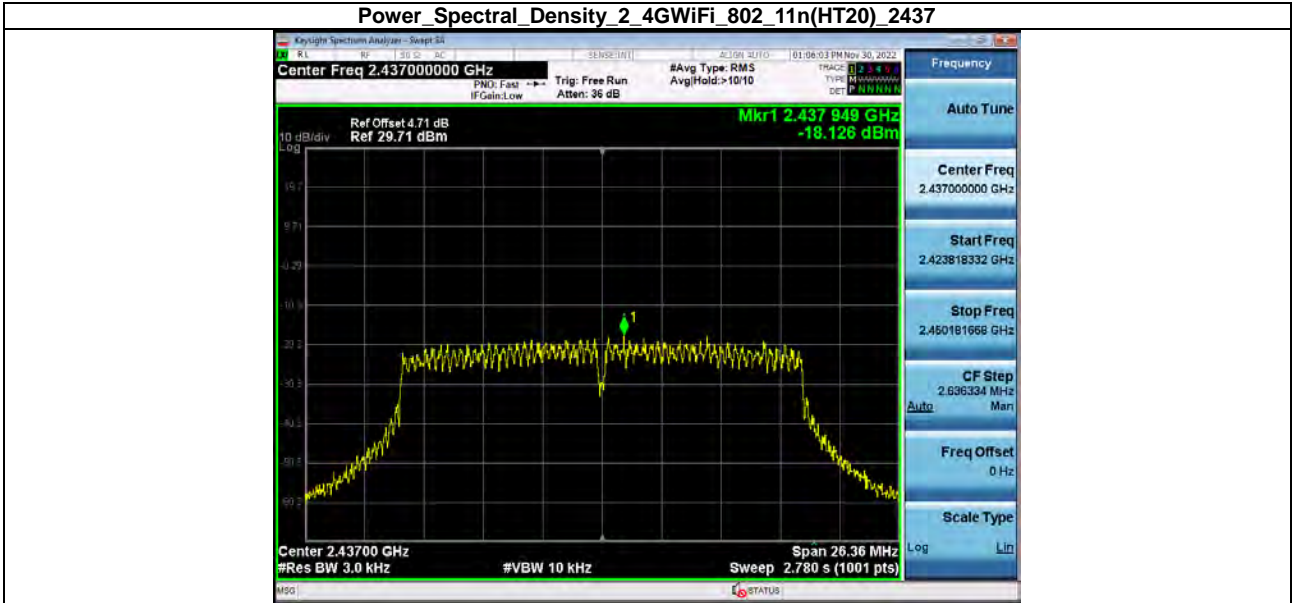

Power Spectral Density 2_4GWiFi_802_11n(HT20)_2462

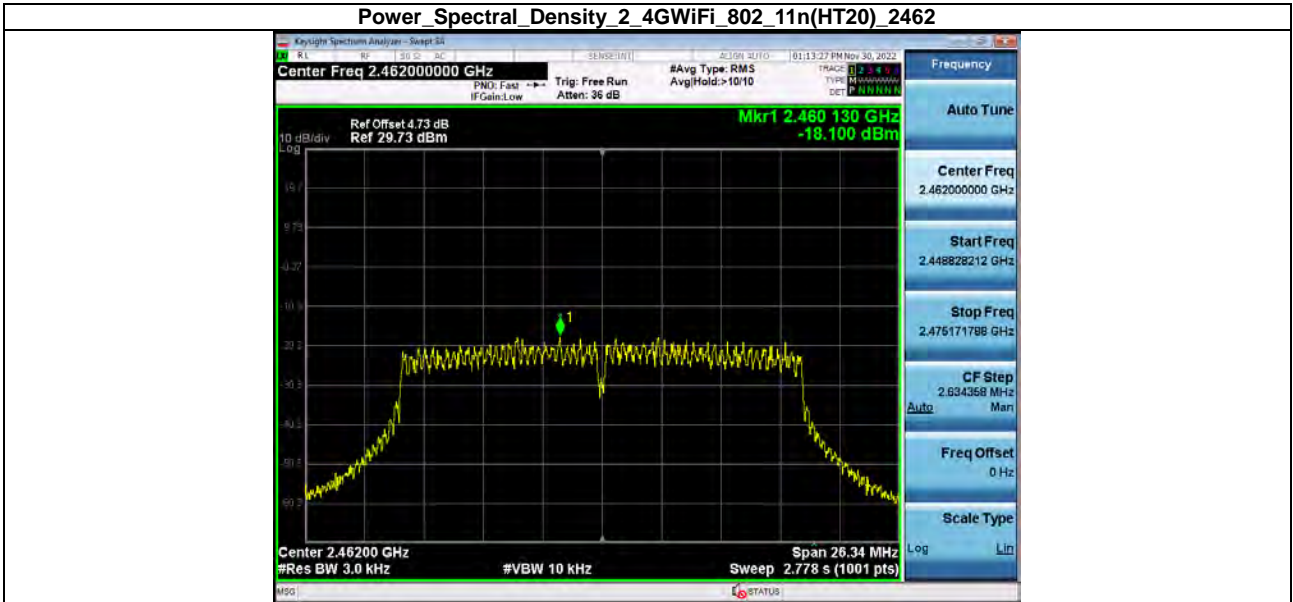

11.6. SPURIOUS EMISSION

ANT1

1 Reference Level 2_4WiFi 802_11b_2412



2 Spurious Emission 2_4WiFi_NVNT_ANT1_802_11b_2412

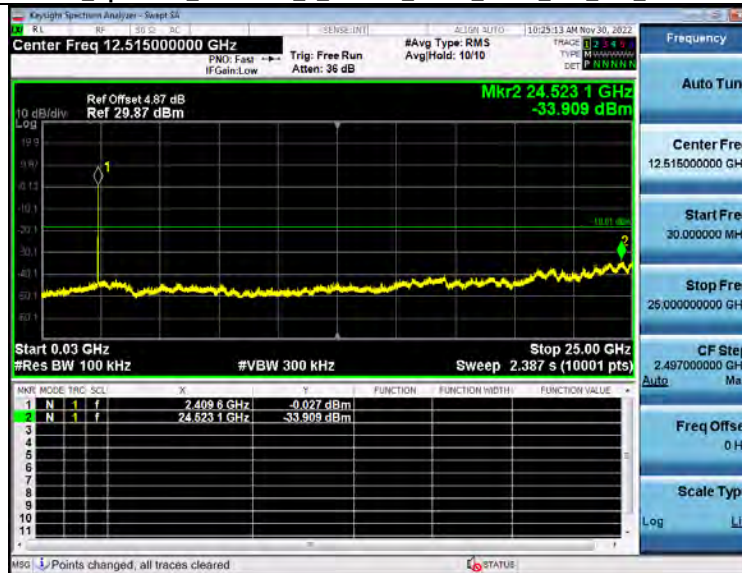

1 Reference Level 2_4WiFi 802_11b_2437

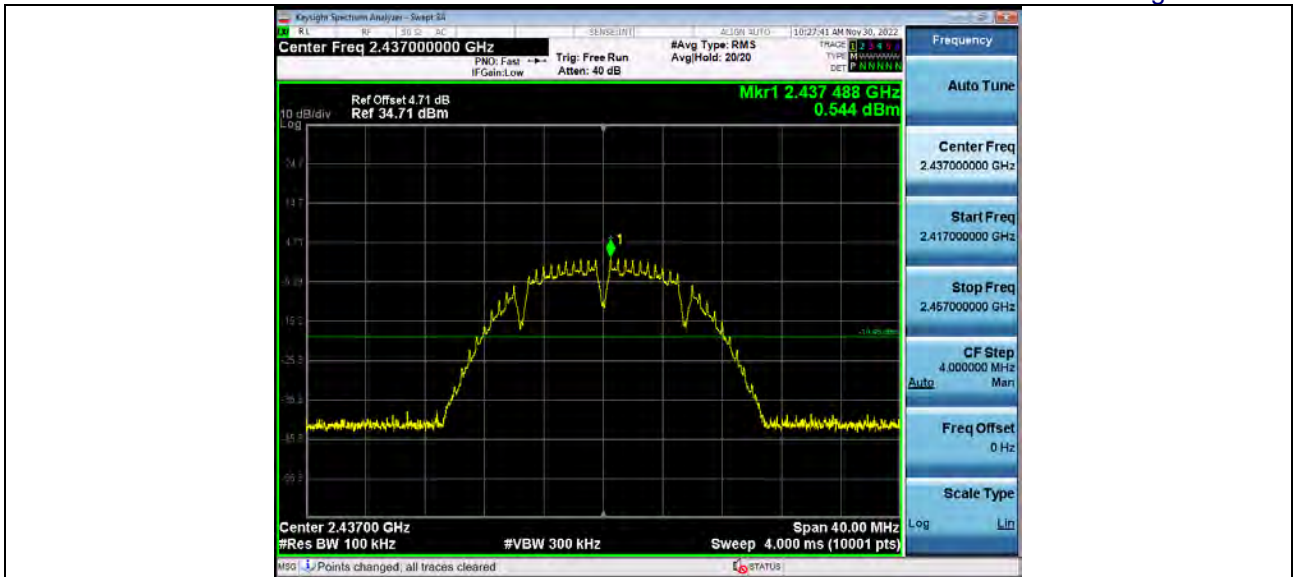

2_Spurious_Emission_2_4GWiFi_NVNT_ANT1_802_11b_2437

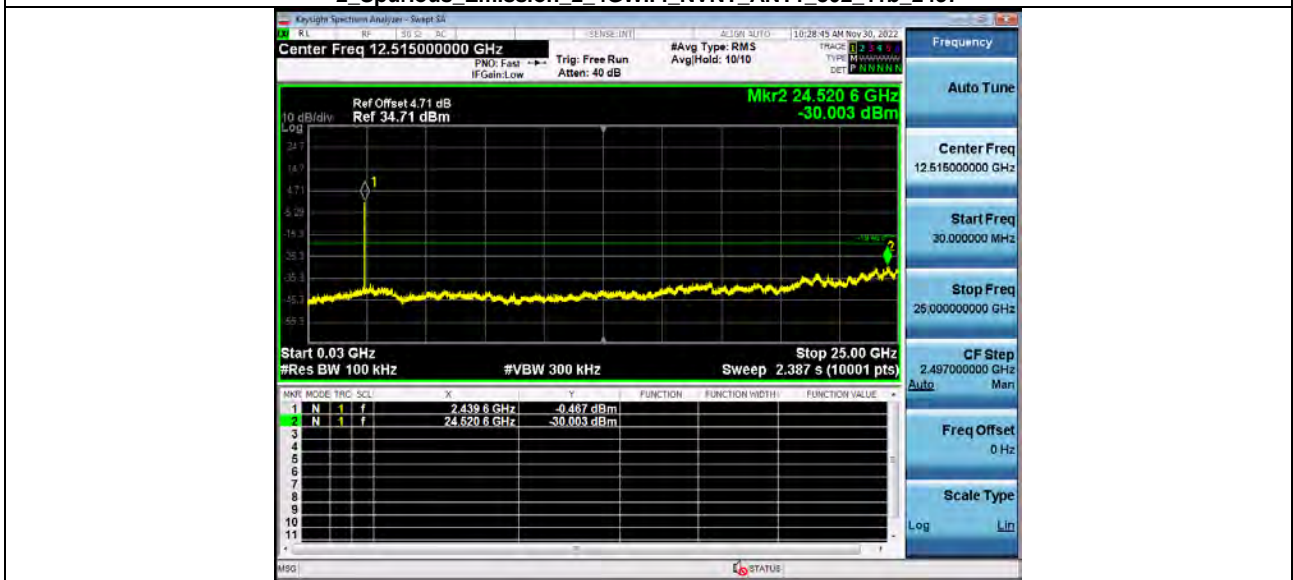

1_Reference_Level_2_4GWiFi_802_11b_2462

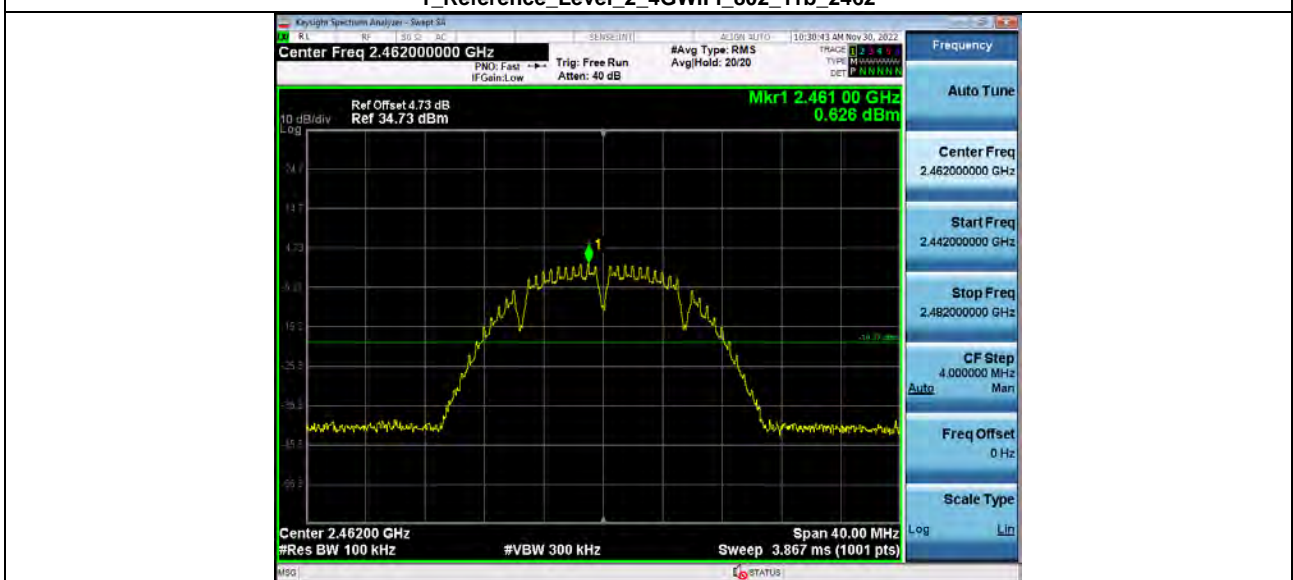

2_Spurious_Emission_2_4GWiFi_NVNT_ANT1_802_11b_2462

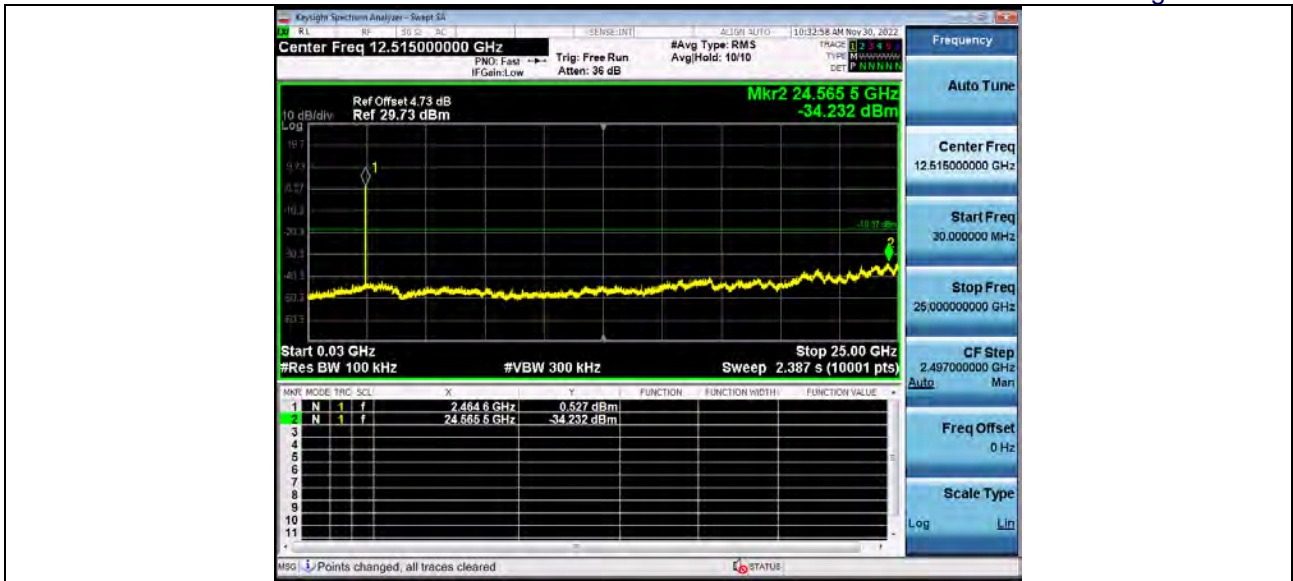

1 Reference Level 2_4WiFi 802_11g 2412

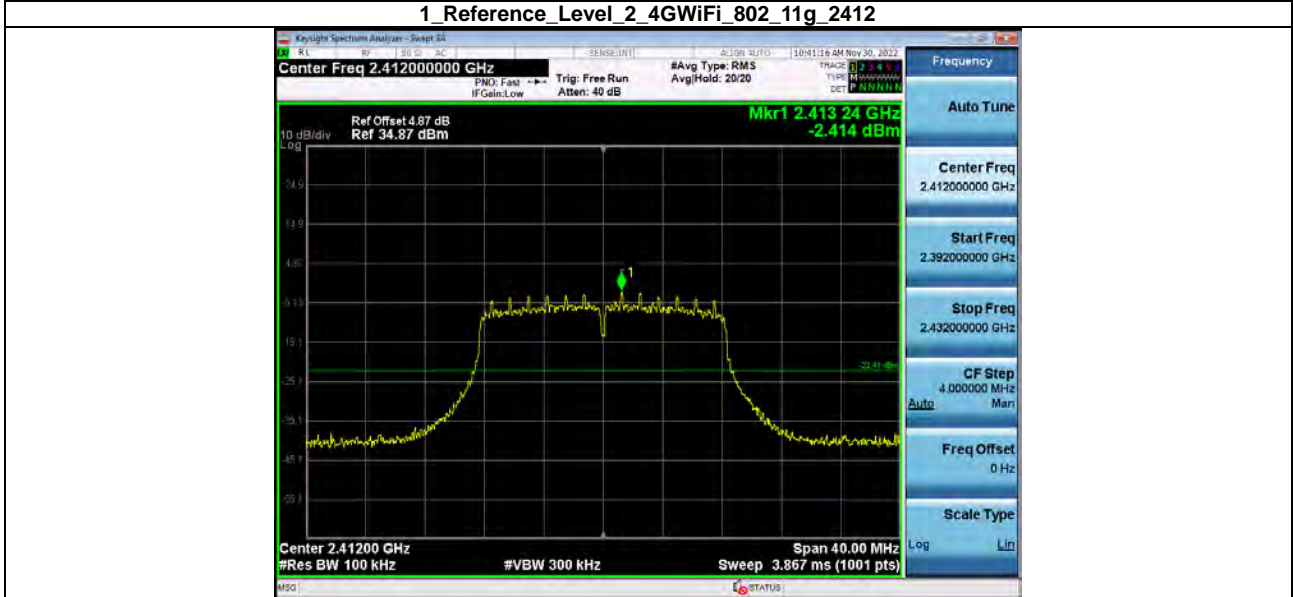

2 Spurious Emission 2_4WiFi_NVNT_ANT1_802_11g_2412



1 Reference Level 2_4WiFi 802_11g 2437



2_Spurious_Emission_2_4WiFi_NVNT_ANT1_802_11g_2437

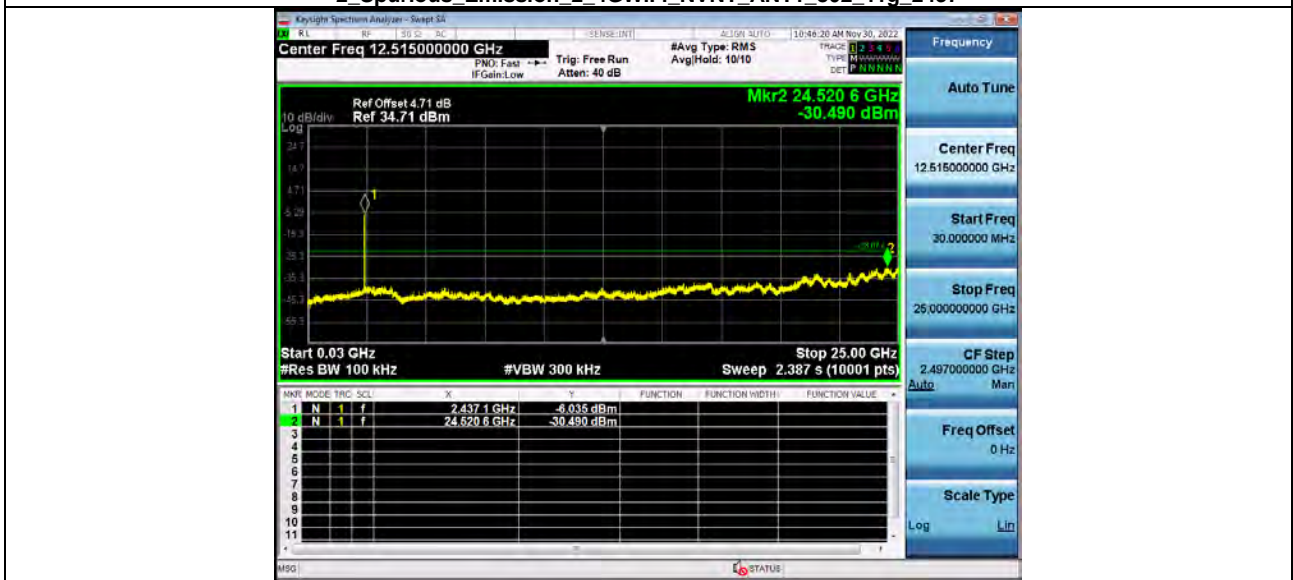

1_Reference_Level_2_4WiFi_802_11g_2462

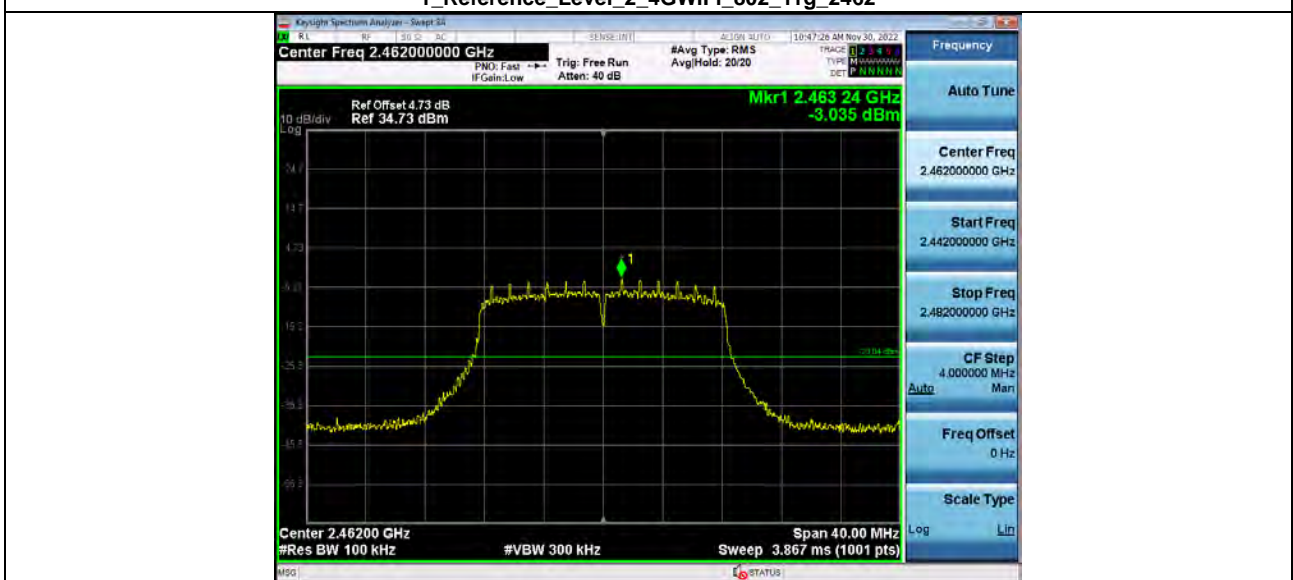

2_Spurious_Emission_2_4WiFi_NVNT_ANT1_802_11g_2462

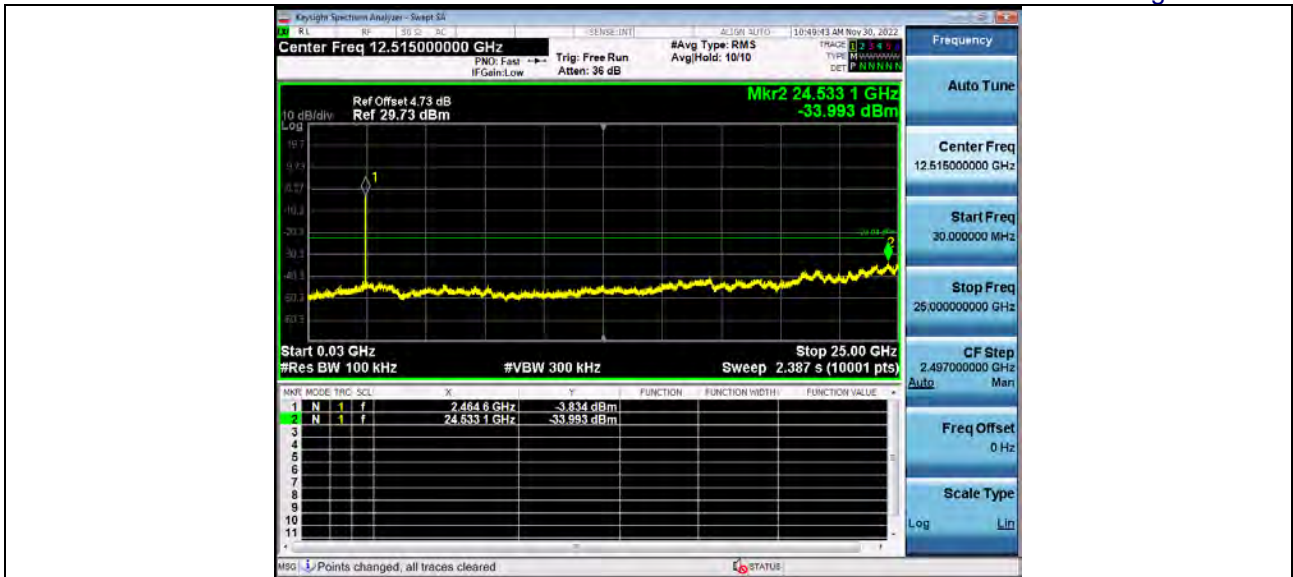

1_Reference_Level_2_4GWiFi_802_11n(HT20)_2412

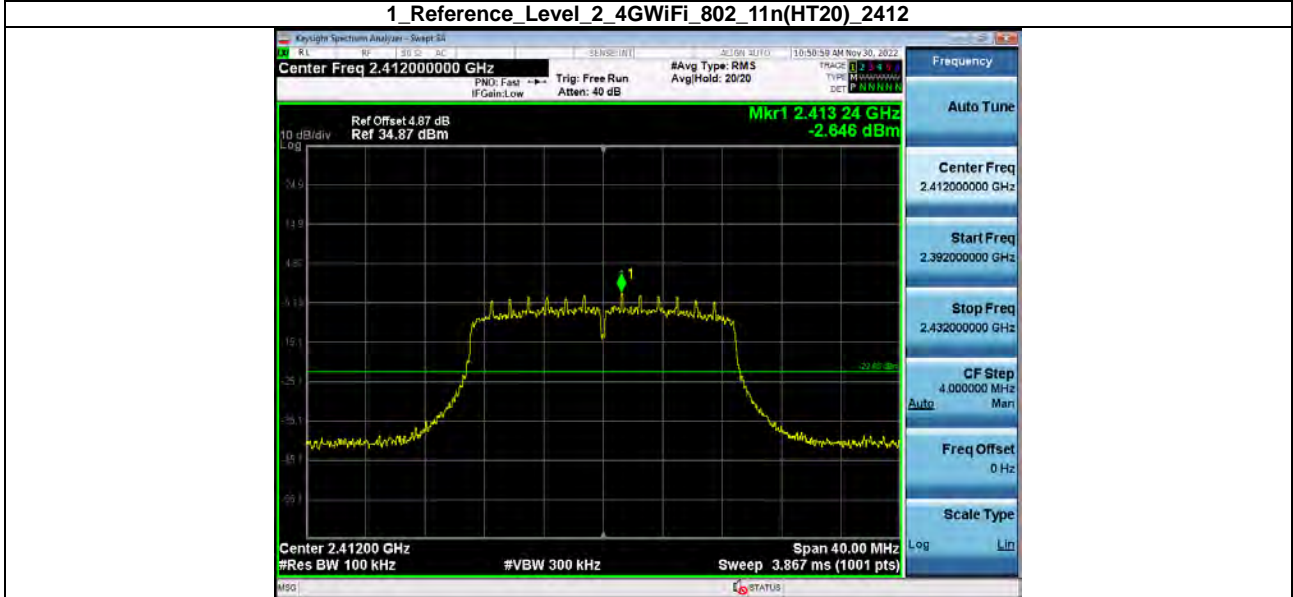

2_Spurious_Emission_2_4GWiFi_NVNT_ANT1_802_11n(HT20)_2412

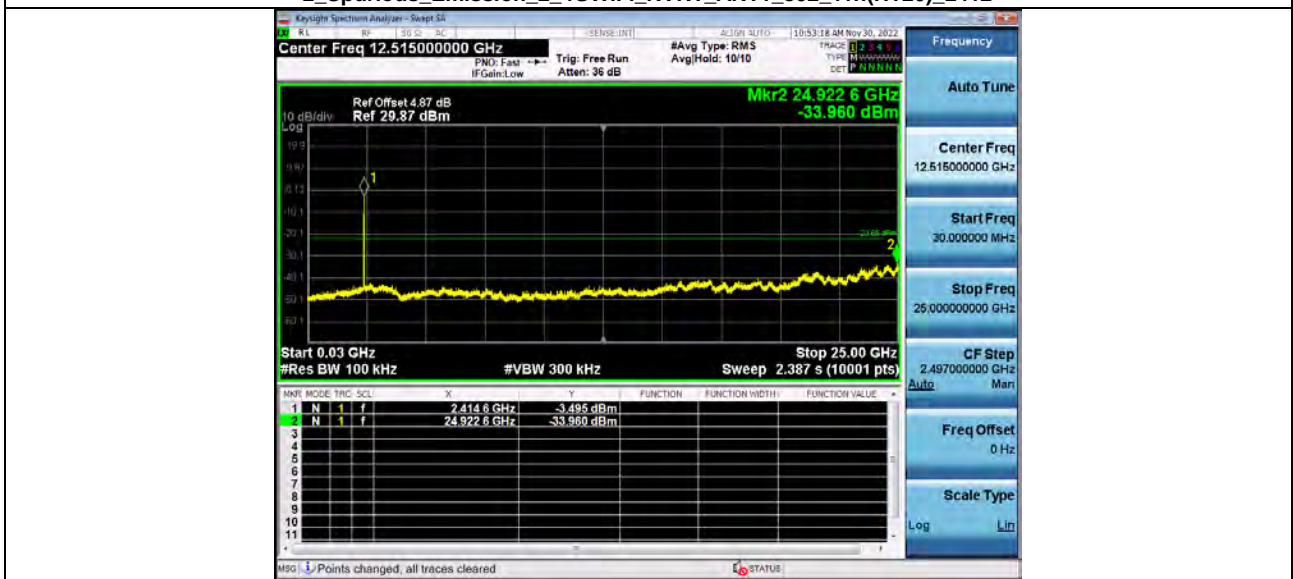

1_Reference_Level_2_4GWiFi_802_11n(HT20)_2437



2_Spurious Emission 2_4GWiFi_NVNT_ANT1_802_11n(HT20)_2437

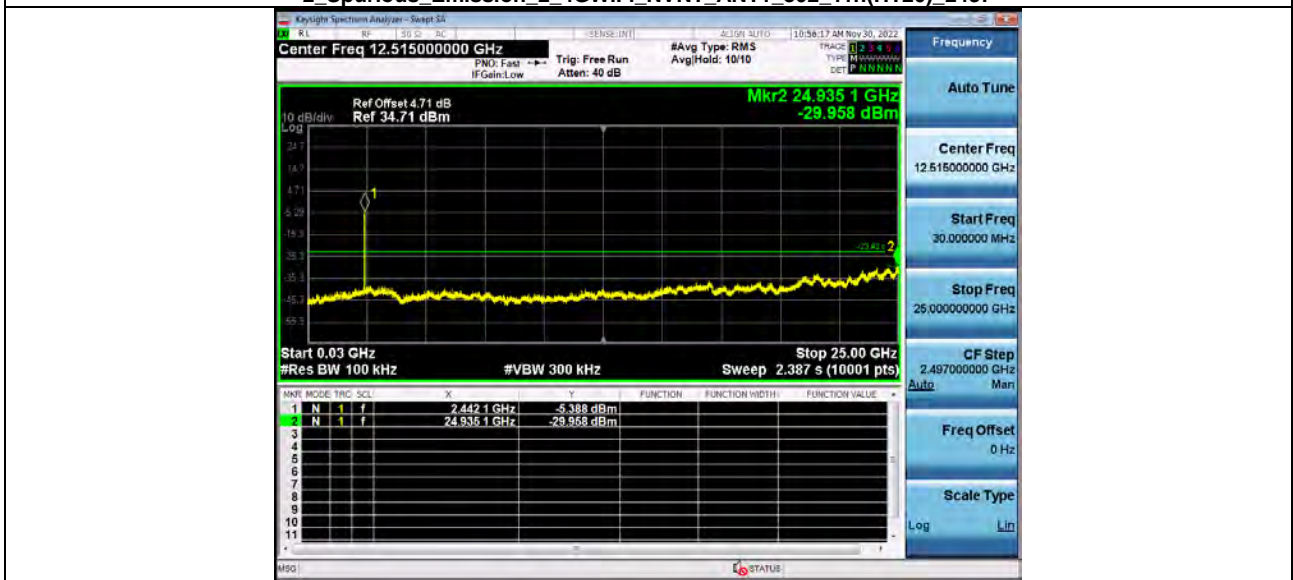

1_Reference Level 2_4GWiFi_802_11n(HT20)_2462



2_Spurious Emission_2_4GWiFi_NVNT_ANT1_802_11n(HT20)_2462

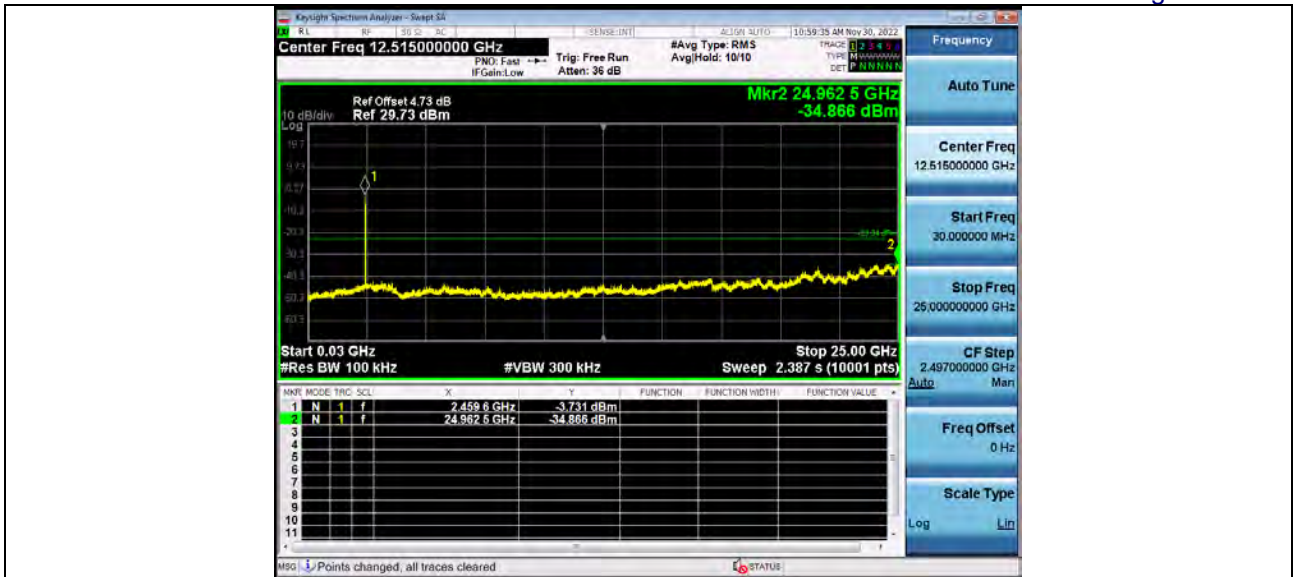

ANT2

1 Reference Level 2_4WiFi 802_11b_2412

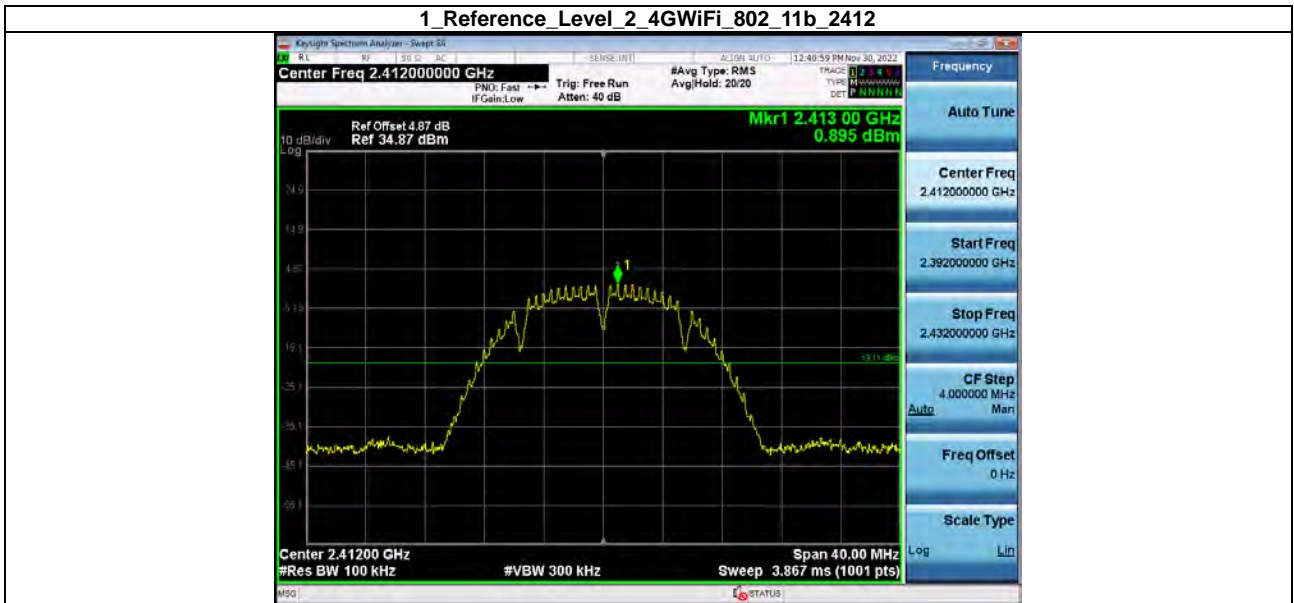

2 Spurious Emission 2_4WiFi_NVNT_ANT1_802_11b_2412

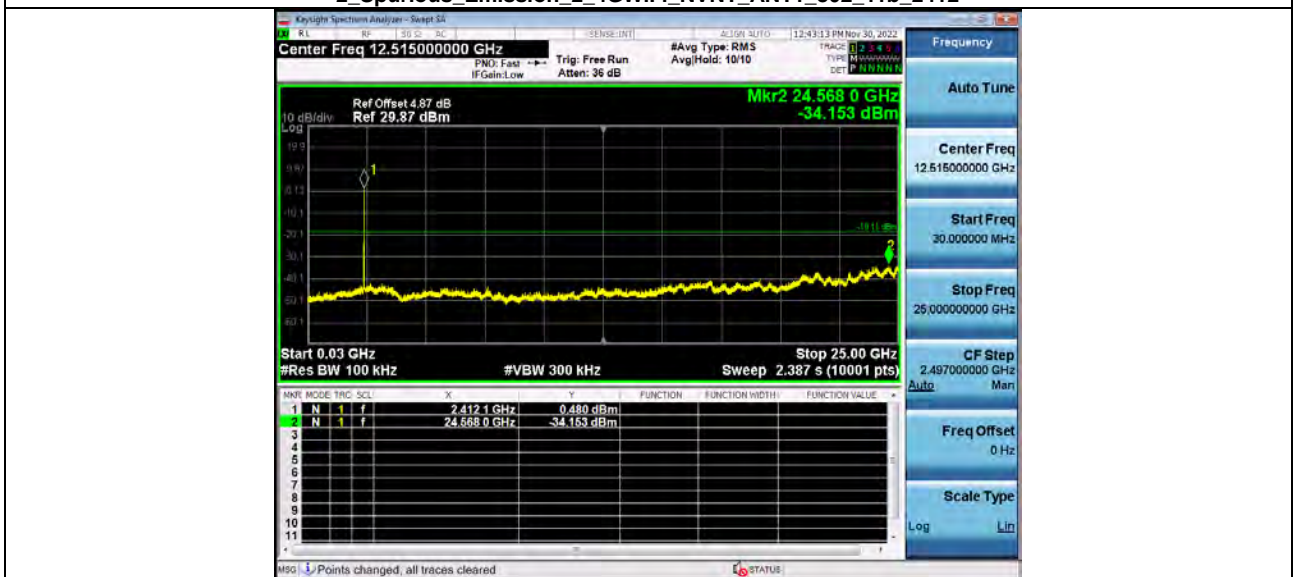

1 Reference Level 2_4GWiFi 802_11b 2437



2 Spurious Emission 2_4GWiFi_NVNT_ANT1_802_11b 2437

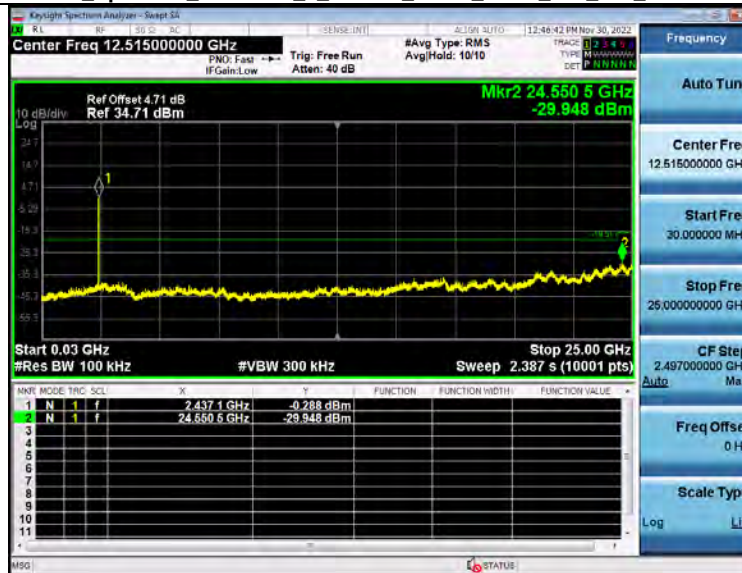

1 Reference Level 2_4GWiFi 802_11b 2462

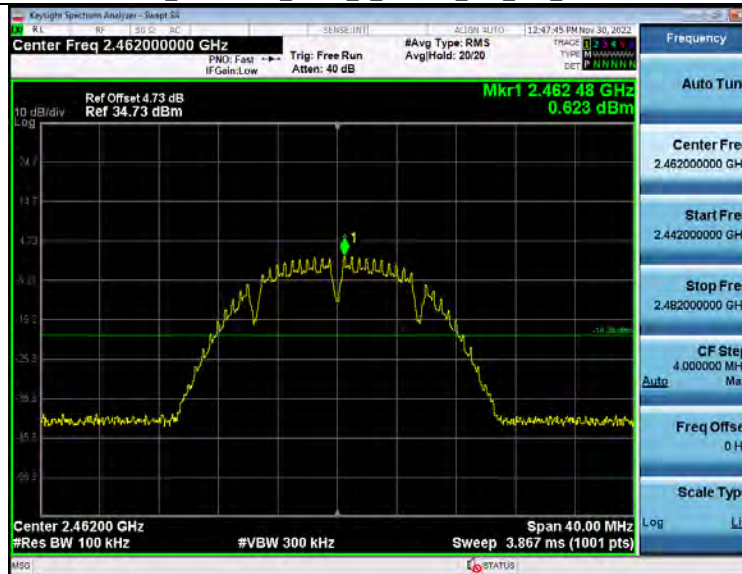

2 Spurious Emission 2_4GWiFi_NVNT_ANT1_802_11b 2462

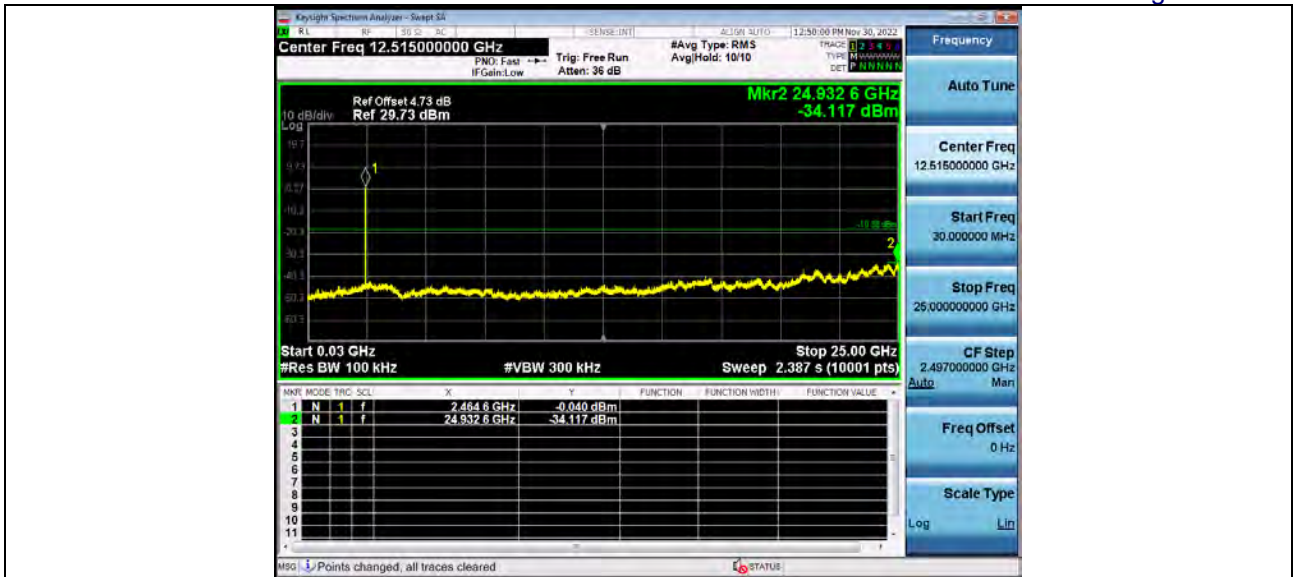

1 Reference Level 2_4WiFi 802_11g_2412



2 Spurious Emission 2_4WiFi_NVNT_ANT1_802_11g_2412

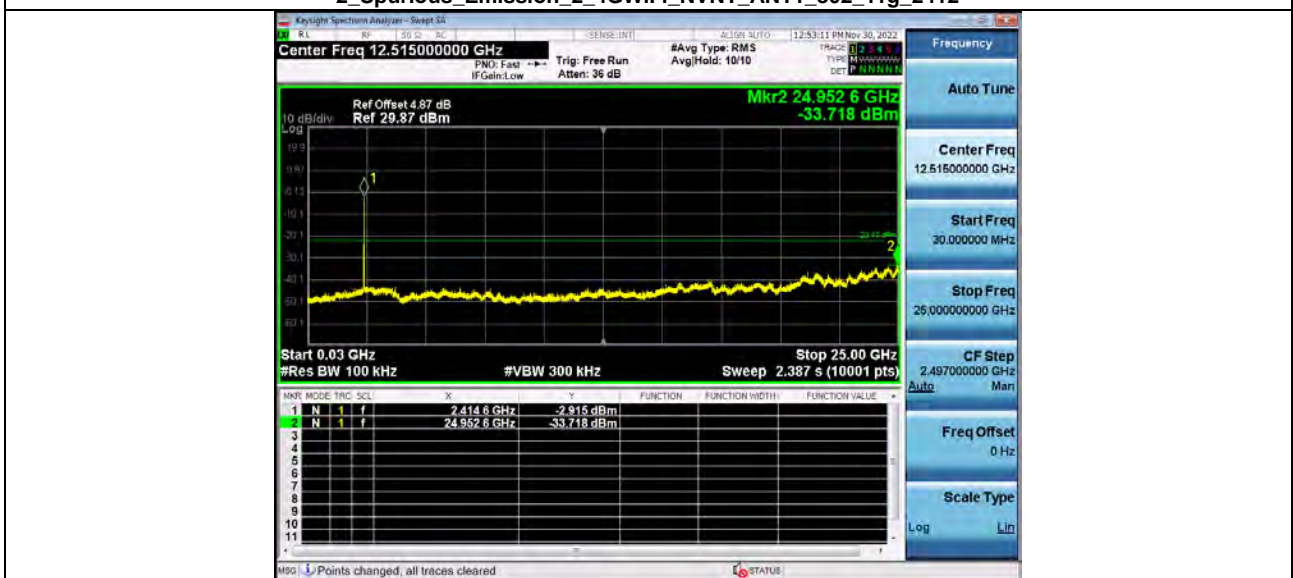

1 Reference Level 2_4WiFi 802_11g_2437



2_Spurious_Emission_2_4GWiFi_NVNT_ANT1_802_11g_2437

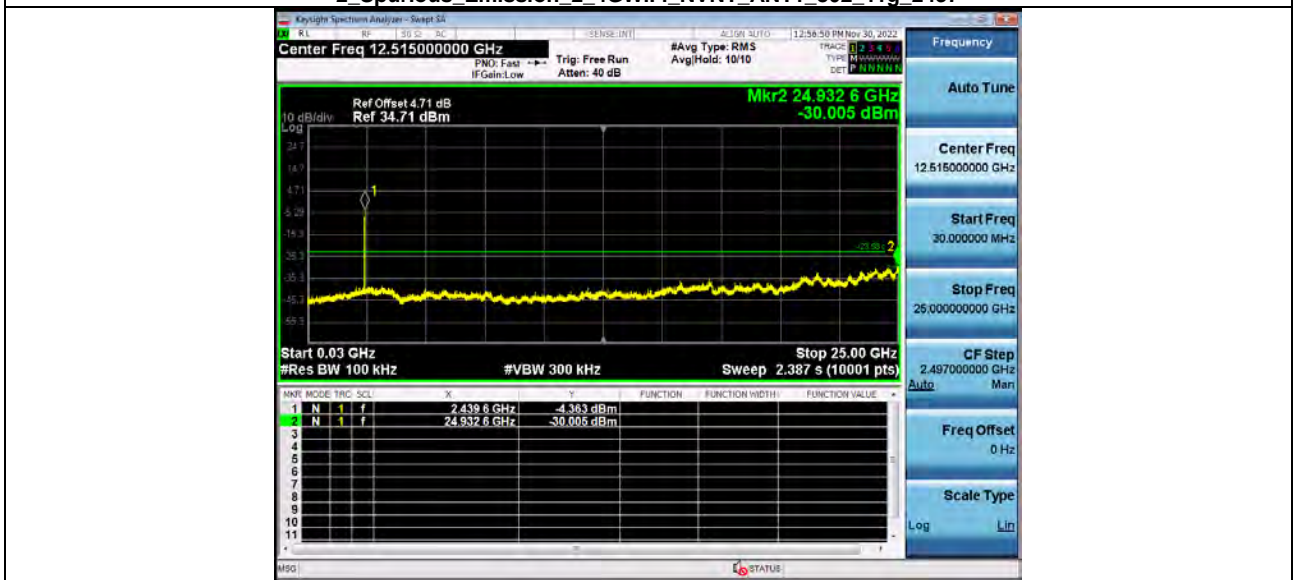

1_Reference_Level_2_4GWiFi_802_11g_2462

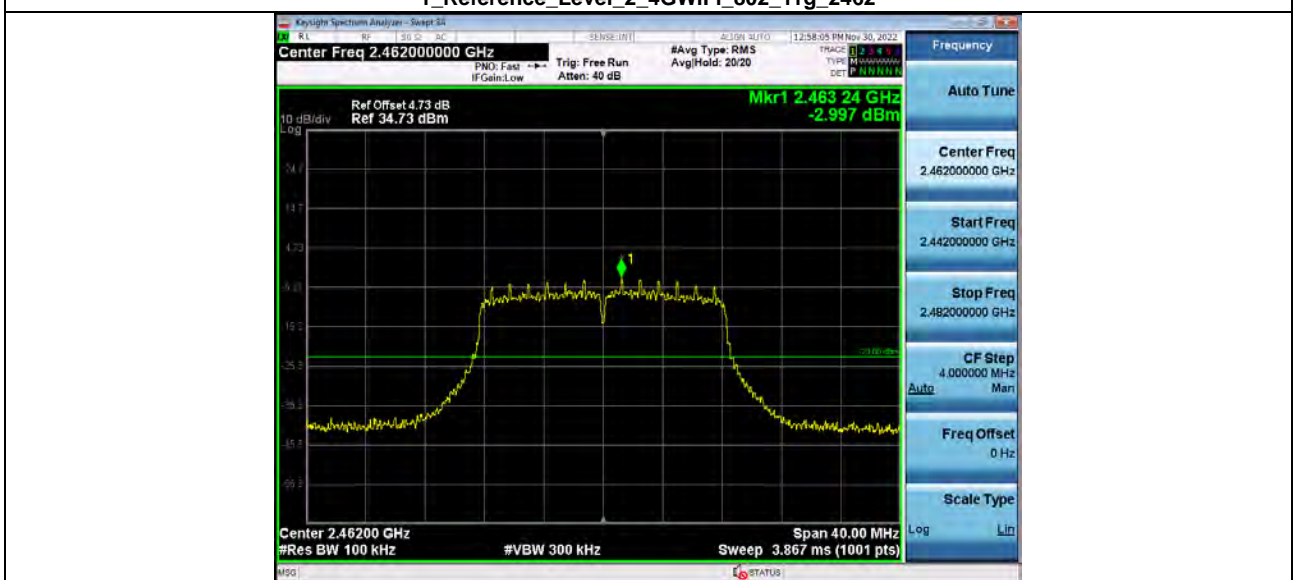

2_Spurious_Emission_2_4GWiFi_NVNT_ANT1_802_11g_2462

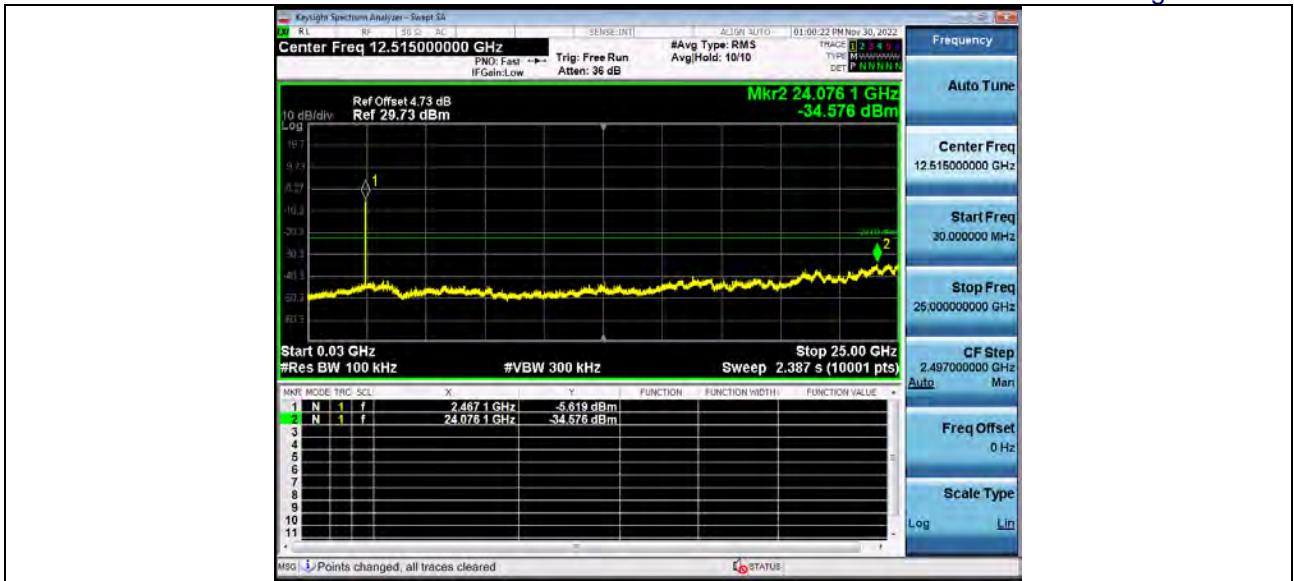

1_Reference_Level_2_4GWiFi_802_11n(HT20)_2412

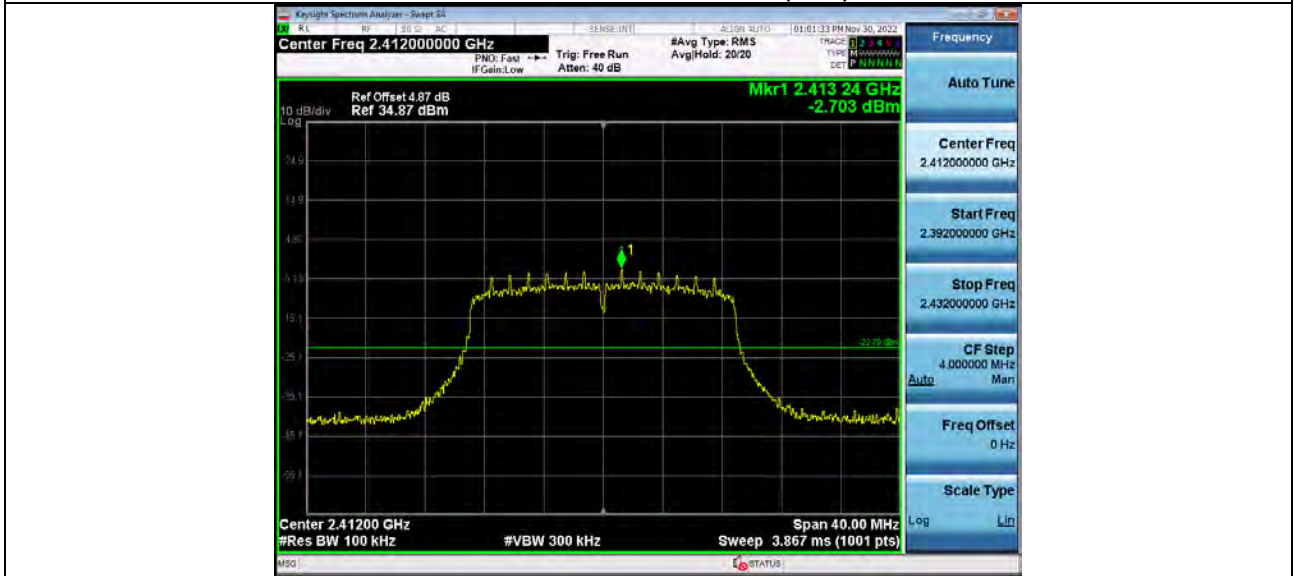

2_Spurious_Emission_2_4GWiFi_NVNT_ANT1_802_11n(HT20)_2412

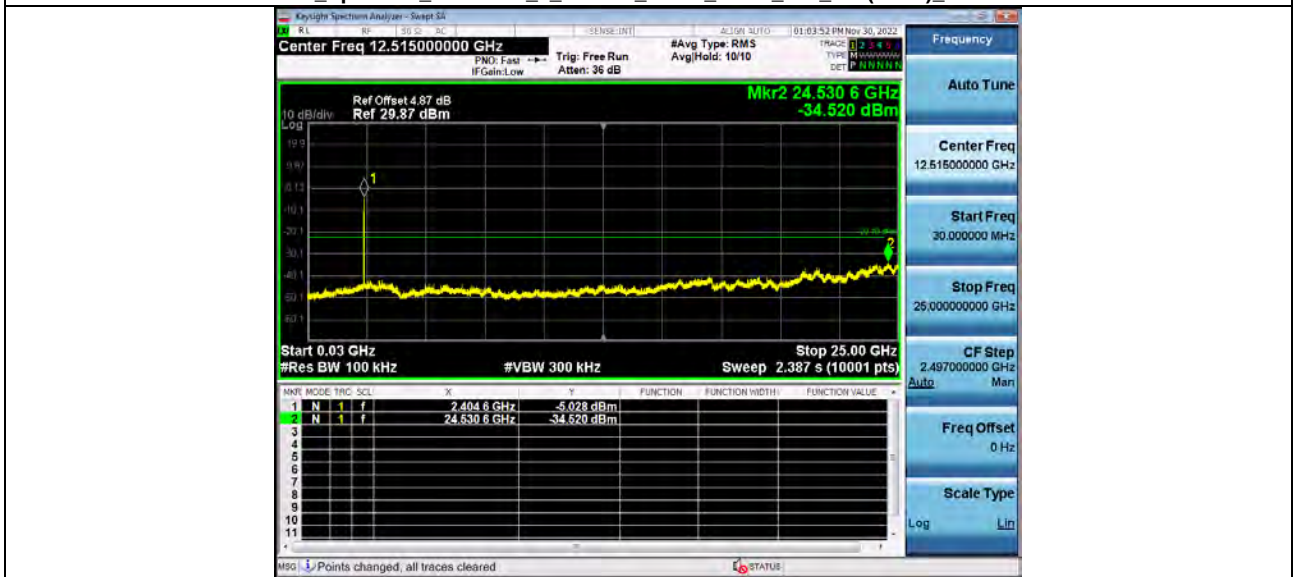

1_Reference_Level_2_4GWiFi_802_11n(HT20)_2437



2_Spurious Emission_2_4GWiFi_NVNT_ANT1_802_11n(HT20)_2437

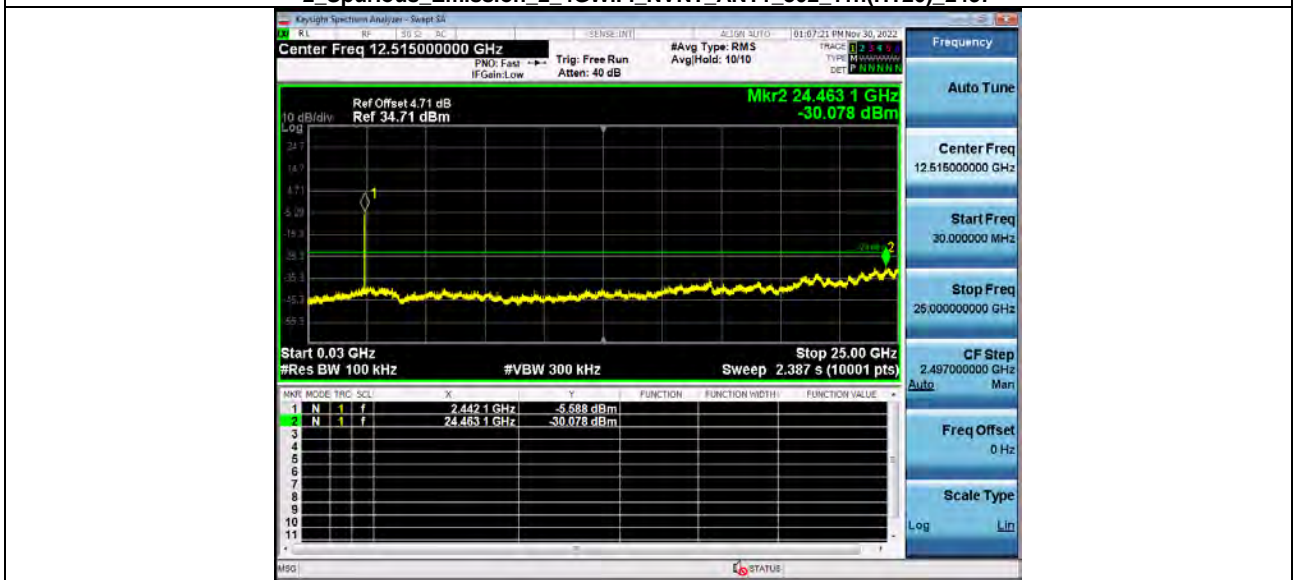

1_Reference_Level_2_4GWiFi_802_11n(HT20)_2462



2_Spurious Emission_2_4GWiFi_NVNT_ANT1_802_11n(HT20)_2462

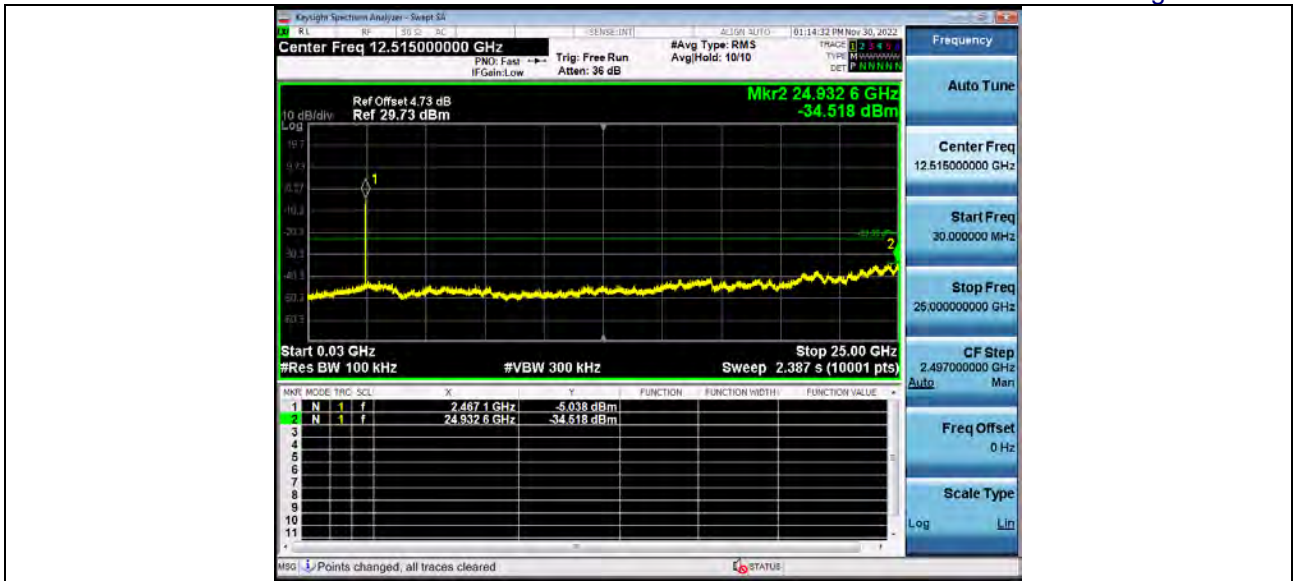

12. TEST SETUP PHOTO

Reference to the Test setup file for details.

13. EUT CONSTRUCTIONAL DETAILS

Reference to the external photos file and internal photos file for details.

******* END OF REPORT *******