

FCC TEST REPORT

FCC ID: 2AL8Y-X4Q

Report Number. : ZKT-221125L8872-01

Date of Test : Nov. 16, 2022 – Nov. 30, 2022

Date of issue : Nov. 30, 2022

Total number of pages : 70

Test Result : PASS

Testing Laboratory : Shenzhen ZKT Technology Co., Ltd.

Address : 1/F, No. 101, Building B, No. 6, Tangwei Community Industrial Avenue, Fuhai Street, Bao'an District, Shenzhen, China

Applicant's name : Shenzhen Ugoos Technology Co., Ltd

Address : Room 6A, 6th Floor, Building A, Bao'an Square, Sun'gang Road, Luohu District, Shenzhen 518020, China

Manufacturer's name : Shenzhen Ugoos Technology Co., Ltd

Address : Room 6A, 6th Floor, Building A, Bao'an Square, Sun'gang Road, Luohu District, Shenzhen 518020, China

Test specification:

Standard : FCC CFR Title 47 Part 15 Subpart C Section 15.247
ANSI C63.10:2013

Test procedure : KDB558074 D0115.247 Meas Guidance v 05r02

Non-standard test method : N/A

Test Report Form No. : TRF-EL-112_V0

Test Report Form(s) Originator : ZKT Testing

Master TRF : Dated: 2020-01-06

This device described above has been tested by ZKT, and the test results show that the equipment under test (EUT) is in compliance with the FCC requirements. And it is applicable only to the tested sample identified in the report.

This report shall not be reproduced except in full, without the written approval of ZKT, this document may be altered or revised by ZKT, personal only, and shall be noted in the revision of the document.

Product name : Android TV Box

Trademark : UGOOS

Model/Type reference : X4Q Pro, X4Q Cube, X4Q Plus, X4Q Max

Ratings : DC5.0V 2.5A from adapter

Testing procedure and testing location:

Testing Laboratory : **Shenzhen ZKT Technology Co., Ltd.**

Address : 1/F, No. 101, Building B, No. 6, Tangwei Community
Industrial Avenue, Fuhai Street, Bao'an District,
Shenzhen, China

Tested by (name + signature)..... : Alen He

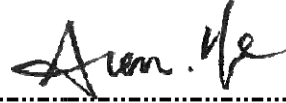

Reviewer (name + signature)..... : Joe Liu

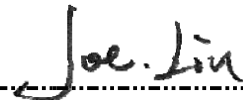

Approved (name + signature) : Lake Xie



Table of Contents

	Page
1. VERSION	5
2. TEST SUMMARY	6
2.1 TEST FACILITY	6
2.2 MEASUREMENT UNCERTAINTY	7
3. GENERAL INFORMATION	8
3.1 GENERAL DESCRIPTION OF EUT	8
3.2 Test Setup Configuration	9
3.3 Support Equipment	9
3.4 Test Mode	10
3.5 EQUIPMENTS LIST FOR ALL TEST ITEMS	11
4. EMC EMISSION TEST	12
4.1 Conducted emissions	12
4.1.1 POWER LINE CONDUCTED EMISSION Limits	12
4.1.2 TEST PROCEDURE	12
4.1.3 DEVIATION FROM TEST STANDARD	12
4.1.4 TEST SETUP	13
4.1.5 EUT OPERATING CONDITIONS	13
4.1.6 Test Result	14
4.2 Radiated emissions	16
4.2.1 Radiated Emission Limits	16
4.2.2 TEST PROCEDURE	16
4.2.3 DEVIATION FROM TEST STANDARD	17
4.2.4 TEST SETUP	17
4.2.5 EUT OPERATING CONDITIONS	18
4.2.6 TEST RESULTS	19
5. RADIATED BAND EMISSION MEASUREMENT	25
5.1 Test Requirement:	25
5.2 TEST PROCEDURE	25
5.3 DEVIATION FROM TEST STANDARD	26
5.4 TEST SETUP	26
5.5 EUT OPERATING CONDITIONS	26
6. CONDUCTED BAND EDGE AND SPURIOUS EMISSION	29
6.1 Limit	29
6.2 Test Setup	29
6.3 Test procedure	29
6.4 DEVIATION FROM STANDARD	29
6.5 Test Result	29
7. 20DB BANDWIDTH	30
7.1 Test Setup	30
7.2 Limit	30
7.3 Test procedure	30
7.4 DEVIATION FROM STANDARD	30

7.5 Test Result	30
8. MAXIMUM PEAK OUTPUT POWER	31
8.1 Block Diagram Of Test Setup	31
8.2 Limit	31
8.3 Test procedure	31
8.4 DEVIATION FROM STANDARD	31
8.5 Test Result	31
9. HOPPING CHANNEL SEPARATION	32
9.1 Test Setup	32
9.2 Test procedure	32
9.3 DEVIATION FROM STANDARD	32
9.4 Test Result	32
10.NUMBER OF HOPPING FREQUENCY	33
10.1 Test Setup	33
10.2 Test procedure	33
10.3 DEVIATION FROM STANDARD	33
10.4 Test Result	33
11. DWELL TIME	34
11.1 Test Setup	34
11.2 Test procedure	34
11.3 DEVIATION FROM STANDARD	34
11.4 Test Result	34
12. ANTENNA REQUIREMENT	35
13.APPENDIX1	36
13.1 -20dB Bandwidth	36
13.2 Peak Output Power	40
13.3 Spurious Emissions	44
13.4 Bandedge	51
13.5 Carrier Frequencies Separation (Hopping)	59
13.6 Number of Hopping Channel (Hopping)	61
13.7 Dwell Time (Hopping)	63
14. TEST SETUP PHOTO	65
15. EUT CONSTRUCTIONAL DETAILS	66

1. VERSION

Report No.	Version	Description	Approved
ZKT-221125L8872-01	Rev.01	Initial issue of report	Nov. 30, 2022

2. TEST SUMMARY

Test procedures according to the technical standards:

FCC Part15 (15.247) , Subpart C			
Standard Section	Test Item	Result	Remark
15.203/15.247 (c)	Antenna Requirement	PASS	
15.207	AC Power Line Conducted Emission	PASS	
15.247 (b)(1)	Conducted Peak Output Power	PASS	
15.247 (a)(1)	20dB Occupied Bandwidth	PASS	
15.247 (a)(1)	Carrier Frequencies Separation	PASS	
15.247 (a)(1)(iii)	Hopping Channel Number	PASS	
15.247 (a)(1)(iii)	Dwell Time	PASS	
15.205/15.209	Radiated Emission	PASS	
15.247(d)	Band Edge	PASS	

NOTE:

(1) "N/A" denotes test is not applicable in this Test Report

2.1 TEST FACILITY

Shenzhen ZKT Technology Co., Ltd.
Add. : 1/F, No. 101, Building B, No. 6, Tangwei Community Industrial Avenue, Fuhai Street,
Bao'an District, Shenzhen, China

FCC Test Firm Registration Number: 692225
Designation Number: CN1299
IC Registered No.: 27033

2.2 MEASUREMENT UNCERTAINTY

The reported uncertainty of measurement $y \pm U$, where expanded uncertainty U is based on a standard uncertainty multiplied by a coverage factor of $k=2$, providing a level of confidence of approximately 95 %.

No.	Item	Uncertainty
1	Conducted Emission Test	$\pm 1.38\text{dB}$
2	RF power conducted	$\pm 0.16\text{dB}$
3	Spurious emissions conducted	$\pm 0.21\text{dB}$
4	All emissions radiated(<1G)	$\pm 4.68\text{dB}$
5	All emissions radiated(>1G)	$\pm 4.89\text{dB}$
6	Temperature	$\pm 0.5\text{C}$
7	Humidity	$\pm 2\%$

3. GENERAL INFORMATION

3.1 GENERAL DESCRIPTION OF EUT

Product Name:	Android TV Box
Model No.:	X4Q Pro
Serial No.:	X4Q Cube, X4Q Plus, X4Q Max
Model difference:	All models are consistent in design, circuit layout, wiring and bom, but the internal running software will be different due to the needs of different customers, but these differences will not affect any electrical performance and RF parameters, so the test model is: X4Q Pro
Hardware Version:	V1.0
Software Version:	V1.0
Sample(s) Status:	Engineer sample
Channel numbers:	79
Channel separation:	2402MHz~2480MHz
Modulation technology:	GFSK, $\pi/4$ DQPSK, 8DPSK
Antenna Type:	PCB antenna
Antenna gain:	1.26dBi
Power supply:	DC5.0V 2.5A from adapter

Operation Frequency each of channel							
Channel	Frequency	Channel	Frequency	Channel	Frequency	Channel	Frequency
1	2402MHz	21	2422MHz	41	2442MHz	61	2462MHz
2	2403MHz	22	2423MHz	42	2443MHz	62	2463MHz
3	2404MHz	23	2424MHz	43	2444MHz	63	2464MHz
4	2405MHz	24	2425MHz	44	2445MHz	64	2465MHz
5	2406MHz	25	2426MHz	45	2446MHz	65	2466MHz
6	2407MHz	26	2427MHz	46	2447MHz	66	2467MHz
7	2408MHz	27	2428MHz	47	2448MHz	67	2468MHz
8	2409MHz	28	2429MHz	48	2449MHz	68	2469MHz
9	2410MHz	29	2430MHz	49	2450MHz	69	2470MHz
10	2411MHz	30	2431MHz	50	2451MHz	70	2471MHz
11	2412MHz	31	2432MHz	51	2452MHz	71	2472MHz
12	2413MHz	32	2433MHz	52	2453MHz	72	2473MHz
13	2414MHz	33	2434MHz	53	2454MHz	73	2474MHz
14	2415MHz	34	2435MHz	54	2455MHz	74	2475MHz
15	2416MHz	35	2436MHz	55	2456MHz	75	2476MHz
16	2417MHz	36	2437MHz	56	2457MHz	76	2477MHz
17	2418MHz	37	2438MHz	57	2458MHz	77	2478MHz
18	2419MHz	38	2439MHz	58	2459MHz	78	2479MHz
19	2420MHz	39	2440MHz	59	2460MHz	79	2480MHz
20	2421MHz	40	2441MHz	60	2461MHz		

Note:

In section 15.31(m), regards to the operating frequency range over 10 MHz, the Lowest frequency, the middle frequency, and the highest frequency of channel were selected to perform the test, and the selected channel

see below:

Test channel	Frequency
The lowest channel	2402MHz
The middle channel	2441MHz
The Highest channel	2480MHz

3.2 Test Setup Configuration

Conducted Emission



Radiated Emission

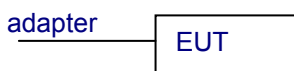

Conducted Spurious



3.3 Support Equipment

The EUT has been tested as an independent unit together with other necessary accessories or support units. The following support units or accessories were used to form a representative test configuration during the tests.

Item	Equipment	Mfr/Brand	Model/Type No.	Series No.	Note
1	adapter	Shenzhen Rongweixin Electronics Co.,Ltd.	R122-0502500UD	/	SDOC
2					

Item	Shielded Type	Ferrite Core	Length	Note
1.				

Note:

- (1) The support equipment was authorized by Declaration of Confirmation.
- (2) For detachable type I/O cable should be specified the length in cm in 『Length』 column.

3.4 Test Mode

Transmitting mode	Keep the EUT in continuously transmitting mode.
Remark: During the test, the test voltage was tuned from 85% to 115% of the nominal rated supply voltage, and found that the worst case was under the nominal rated supply condition. So the report just shows that condition's data.	

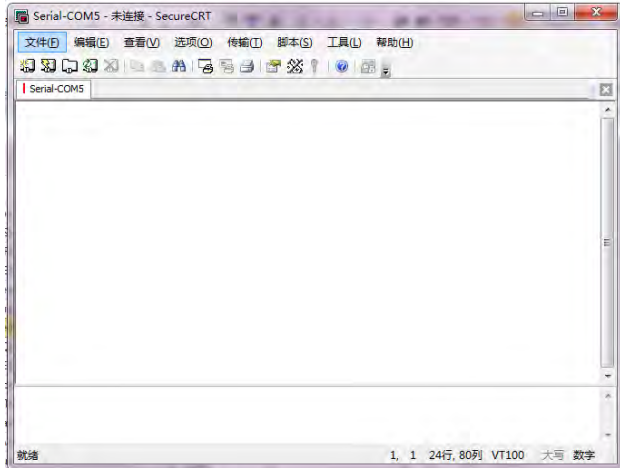
Test Software	Test Tool 
Power level setup	<10dBm

3.5 EQUIPMENTS LIST FOR ALL TEST ITEMS

Radiation Test equipment

Item	Equipment	Manufacturer	Type No.	Serial No.	Last calibration	Calibrated until
1	Spectrum Analyzer (9kHz-26.5GHz)	KEYSIGHT	9020A	MY55370835	Oct. 18, 2022	Oct. 17, 2023
2	Spectrum Analyzer (1GHz-40GHz)	R&S	FSQ	100363	Oct. 17, 2022	Oct. 16, 2023
3	EMI Test Receiver (9kHz-7GHz)	R&S	ESCI7	101169	Oct. 18, 2022	Oct. 17, 2023
4	Bilog Antenna (30MHz-1500MHz)	Schwarzbeck	VULB9168	N/A	Oct. 17, 2022	Oct. 16, 2023
5	Horn Antenna (1GHz-18GHz)	Agilent	AH-118	071145	Oct. 17, 2022	Oct. 16, 2023
6	Loop Antenna	TESEQ	HLA6121	58357	Oct. 17, 2022	Oct. 16, 2023
7	Amplifier (30-1000MHz)	EM Electronics	EM330 Amplifier	060747	Oct. 17, 2022	Oct. 16, 2023
8	Amplifier (1GHz-26.5GHz)	Agilent	8449B	3008A00315	Oct. 18, 2022	Oct. 17, 2023
9	RF cables1 (9kHz-30MHz)	N/A	9kHz-30MHz	N/A	Oct. 18, 2022	Oct. 17, 2023
10	RF cables2 (30MHz-1GHz)	N/A	30MHz-1GHz	N/A	Oct. 18, 2022	Oct. 17, 2023
11	RF cables3 (1GHz-40GHz)	N/A	1GHz-40GHz	N/A	Oct. 18, 2022	Oct. 17, 2023
12	ESG Signal Generator	Agilent	E4421B	N/A	Oct. 18, 2022	Oct. 17, 2023
13	Signal Generator	Agilent	N5182A	N/A	Oct. 22, 2022	Oct. 21, 2023
14	Magnetic Field Probe Tester	Narda	ELT-400	0-0344	Oct. 17, 2022	Oct. 16, 2023
15	MWRF Power Meter Test system	MW	MW100-RPC B	N/A	Oct. 22, 2022	Oct. 21, 2023
16	Power sensor	KEYSIGHT	U200H	MY51190005	Oct. 22, 2022	Oct. 21, 2023
17	D.C. Power Supply	LongWei	TPR-6405D	N/A	\	\
18	EMC Software	Frad	EZ-EMC	Ver.EMC-CON 3A1.1	\	\
19	RF Software	MW	MTS8310	V2.0.0.0	\	\
20	Turntable	MF	MF-7802BS	N/A	\	\
21	Antenna tower	MF	MF-7802BS	N/A	\	\

Conduction Test equipment

Item	Kind of Equipment	Manufacturer	Type No.	Serial No.	Last calibration	Calibrated until
1	LISN	R&S	ENV216	101471	Oct. 22, 2022	Oct. 21, 2023
2	LISN	CYBERTEK	EM5040A	E1850400149	Oct. 22, 2022	Oct. 21, 2023
3	Test Cable	N/A	C01	N/A	Oct. 18, 2022	Oct. 17, 2023
4	Test Cable	N/A	C02	N/A	Oct. 18, 2022	Oct. 17, 2023
5	EMI Test Receiver	R&S	ESCI3	101393	Oct. 17, 2022	Oct. 16, 2023
6	EMC Software	Frad	EZ-EMC	Ver.EMC-CON 3A1.1	\	\

4. EMC EMISSION TEST

4.1 Conducted emissions

Test Requirement:	FCC Part15 C Section 15.207
Test Method:	ANSI C63.10:2013
Test Frequency Range:	150KHz to 30MHz
Receiver setup:	RBW=9KHz, VBW=30KHz, Sweep time=auto

4.1.1 POWER LINE CONDUCTED EMISSION Limits

FREQUENCY (MHz)	Limit (dBuV)		Standard
	Quasi-peak	Average	
0.15 -0.5	66 - 56 *	56 - 46 *	FCC
0.50 -5.0	56.00	46.00	FCC
5.0 -30.0	60.00	50.00	FCC

Note:

(1) *Decreases with the logarithm of the frequency.

4.1.2 TEST PROCEDURE

- a. The EUT was placed 0.8 meters from the horizontal ground plane with EUT being connected to the power mains through a line impedance stabilization network (LISN). All other support equipments powered from additional LISN(s). The LISN provide 50 Ohm/ 50uH of coupling impedance for the measuring instrument.
- b. Interconnecting cables that hang closer than 40 cm to the ground plane shall be folded back and forth in the center forming a bundle 30 to 40 cm long.
- c. I/O cables that are not connected to a peripheral shall be bundled in the center. The end of the cable may be terminated, if required, using the correct terminating impedance. The overall length shall not exceed 1 m.
- d. LISN at least 80 cm from nearest part of EUT chassis.
- e. For the actual test configuration, please refer to the related Item –EUT Test Photos.

4.1.3 DEVIATION FROM TEST STANDARD

No deviation

4.1.4 TEST SETUP

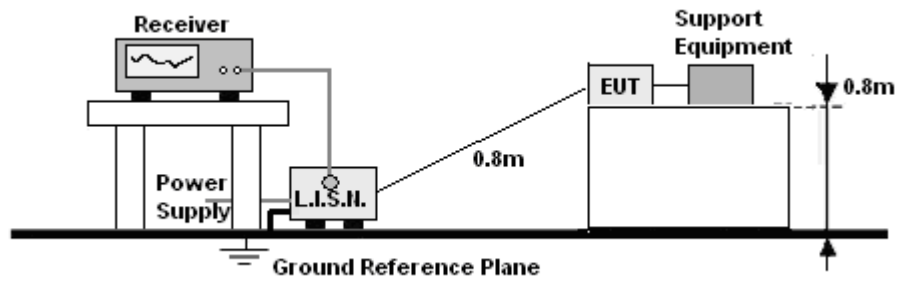

4.1.5 EUT OPERATING CONDITIONS

The EUT was configured for testing in a typical fashion (as a customer would normally use it). The EUT has been programmed to continuously transmit during test. This operating condition was tested and used to collect the included data.

4.1.6 Test Result

Temperature:	26°C	Relative Humidity:	54%
Pressure:	101kPa	Phase :	L
Test Voltage:	AC 120V/60Hz	Mode:	3-DH5 2480.00

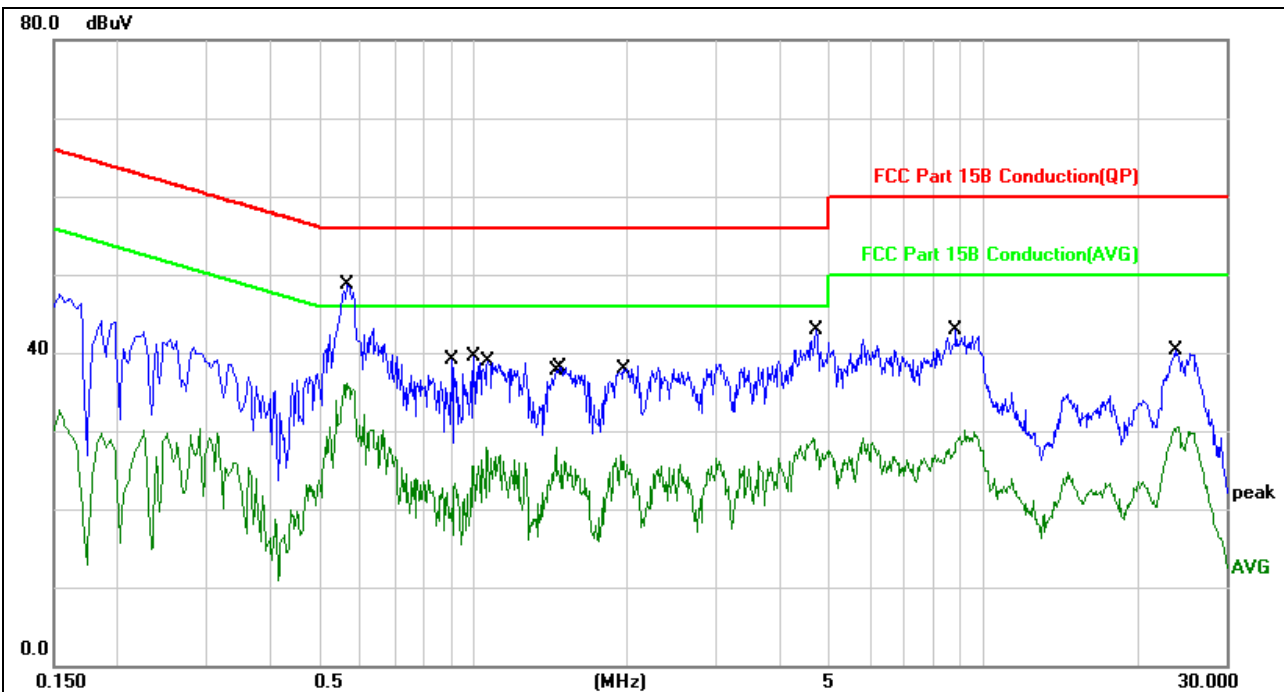

No.	Mk.	Freq.	Reading Level	Correct Factor	Measurement	Limit	Over	Detector	Comment
		MHz	dBuV	dB	dBuV	dBuV	dB		
1	*	0.5660	38.44	10.21	48.65	56.00	-7.35	QP	
2		0.5660	25.85	10.21	36.06	46.00	-9.94	AVG	
3		0.9060	28.94	10.18	39.12	56.00	-16.88	QP	
4		1.0020	29.41	10.17	39.58	56.00	-16.42	QP	
5		1.0620	17.71	10.16	27.87	46.00	-18.13	AVG	
6		1.4540	17.82	10.11	27.93	46.00	-18.07	AVG	
7		1.4780	28.07	10.10	38.17	56.00	-17.83	QP	
8		1.9460	16.85	10.05	26.90	46.00	-19.10	AVG	
9		4.6300	19.28	9.91	29.19	46.00	-16.81	AVG	
10		4.7140	32.90	9.92	42.82	56.00	-13.18	QP	
11		8.8340	32.91	9.94	42.85	60.00	-17.15	QP	
12		24.0540	20.84	9.74	30.58	50.00	-19.42	AVG	

Notes:

1. An initial pre-scan was performed on the line and neutral lines with peak detector.
2. Quasi-Peak and Average measurement were performed at the frequencies with maximized peak emission.
3. Measurement Level = Reading level + Correct Factor

Temperature:	26°C	Relative Humidity:	54%
Pressure:	101kPa	Phase :	N
Test Voltage:	AC 120V/60Hz	Mode:	3-DH5 2480.00

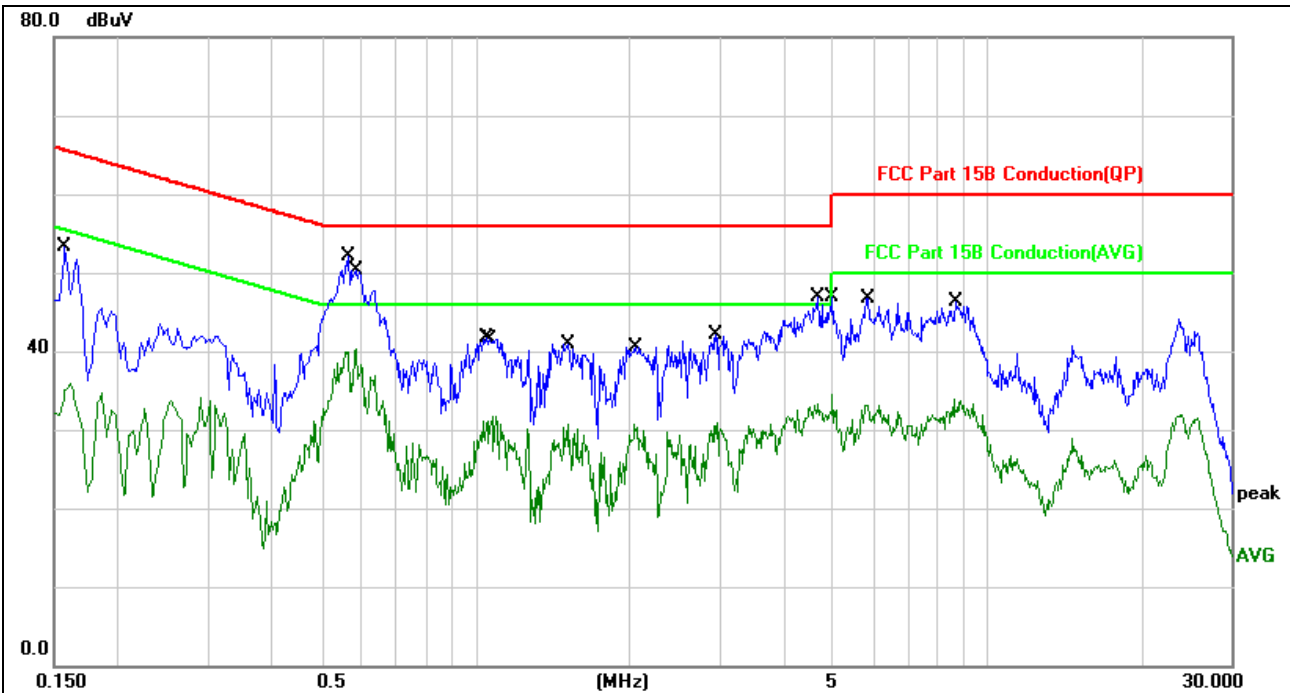

No. Mk.	Freq. MHz	Reading Level dBuV	Correct Factor dB	Measurement dBuV	Limit dBuV	Over dB	Detector	Comment
1	0.1580	43.26	10.06	53.32	65.56	-12.24	QP	
2 *	0.5660	41.96	10.21	52.17	56.00	-3.83	QP	
3	0.5823	30.14	10.21	40.35	46.00	-5.65	AVG	
4	1.0540	31.48	10.16	41.64	56.00	-14.36	QP	
5	1.0820	21.63	10.16	31.79	46.00	-14.21	AVG	
6	1.5140	20.58	10.10	30.68	46.00	-15.32	AVG	
7	2.0500	20.69	10.04	30.73	46.00	-15.27	AVG	
8	2.9739	20.99	9.87	30.86	46.00	-15.14	AVG	
9	4.6540	37.07	9.91	46.98	56.00	-9.02	QP	
10	5.0020	24.51	9.97	34.48	50.00	-15.52	AVG	
11	5.8580	36.74	9.93	46.67	60.00	-13.33	QP	
12	8.7220	36.39	9.94	46.33	60.00	-13.67	QP	

Notes:
 1. An initial pre-scan was performed on the line and neutral lines with peak detector.
 2. Quasi-Peak and Average measurement were performed at the frequencies with maximized peak emission.
 3. Measurement Level = Reading level + Correct Factor

4.2 Radiated emissions

Test Requirement:	FCC Part15 C Section 15.209				
Test Method:	ANSI C63.10:2013				
Test Frequency Range:	9kHz to 25GHz				
Test site:	Measurement Distance: 3m				
Receiver setup:	Frequency	Detector	RBW	VBW	Value
	9KHz-150KHz	Quasi-peak	200Hz	600Hz	Quasi-peak
	150KHz-30MHz	Quasi-peak	9KHz	30KHz	Quasi-peak
	30MHz-1GHz	Quasi-peak	120KHz	300KHz	Quasi-peak
	Above 1GHz	Peak	1MHz	3MHz	Peak
		Peak	1MHz	10Hz	Average

4.2.1 Radiated Emission Limits

Frequencies (MHz)	Field Strength (micorvolts/meter)	Measurement Distance (meters)
0.009~0.490	2400/F(KHz)	300
0.490~1.705	24000/F(KHz)	30
1.705~30.0	30	30
30~88	100	3
88~216	150	3
216~960	200	3
Above 960	500	3

LIMITS OF RADIATED EMISSION MEASUREMENT

FREQUENCY (MHz)	Limit (dBuV/m) (at 3M)	
	PEAK	AVERAGE
Above 1000	74	54

Notes:

- (1) The limit for radiated test was performed according to FCC PART 15C.
- (2) The tighter limit applies at the band edges.
- (3) Emission level (dBuV/m)=20log Emission level (uV/m).

4.2.2 TEST PROCEDURE

Below 1GHz test procedure as below:

- a. The EUT was placed on the top of a rotating table 0.8 meters above the ground at a 3 meter semi-anechoic chamber. The table was rotated 360 degrees to determine the position of the highest radiation.
- b. The EUT was set 3 meters away from the interference-receiving antenna, which was mounted on the top of a variable-height antenna tower.
- c. The antenna height is varied from one meter to four meters above the ground to determine the maximum value of the field strength. Both horizontal and vertical polarizations of the antenna are set to make the measurement.

- d. For each suspected emission, the EUT was arranged to its worst case and then the antenna was tuned to heights from 1 meter to 4 meters (for the test frequency of below 30MHz, the antenna was tuned to heights 1 meter) and the rotatable table was turned from 0 degrees to 360 degrees to find the maximum reading.
- e. The test-receiver system was set to Peak Detect Function and Specified Bandwidth with Maximum Hold Mode.
- f. If the emission level of the EUT in peak mode was 10dB lower than the limit specified, then testing could be stopped and the peak values of the EUT would be reported. Otherwise the emissions that did not have 10dB margin would be re-tested one by one using peak, quasi-peak or average method as specified and then reported in a data sheet.

Above 1GHz test procedure as below:

- g. Different between above is the test site, change from Semi- Anechoic Chamber to fully Anechoic Chamber and change form table 0.8 metre to 1.5 metre(Above 18GHz the distance is 1 meter and table is 1.5 metre).
- h. Test the EUT in the lowest channel ,the middle channel ,the Highest channel

Note:

Both horizontal and vertical antenna polarities were tested and performed pretest to three orthogonal axis. The worst case emissions were reported

4.2.3 DEVIATION FROM TEST STANDARD

No deviation

4.2.4 TEST SETUP

(A) Radiated Emission Test-Up Frequency Below 30MHz

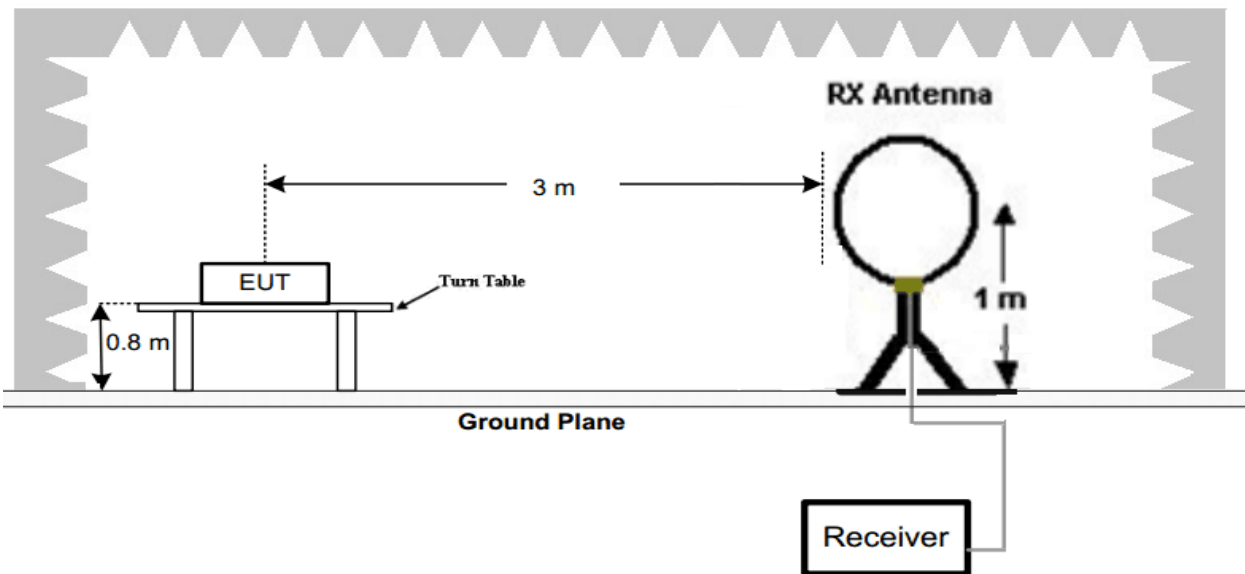

(B) Radiated Emission Test-Up Frequency 30MHz~1GHz

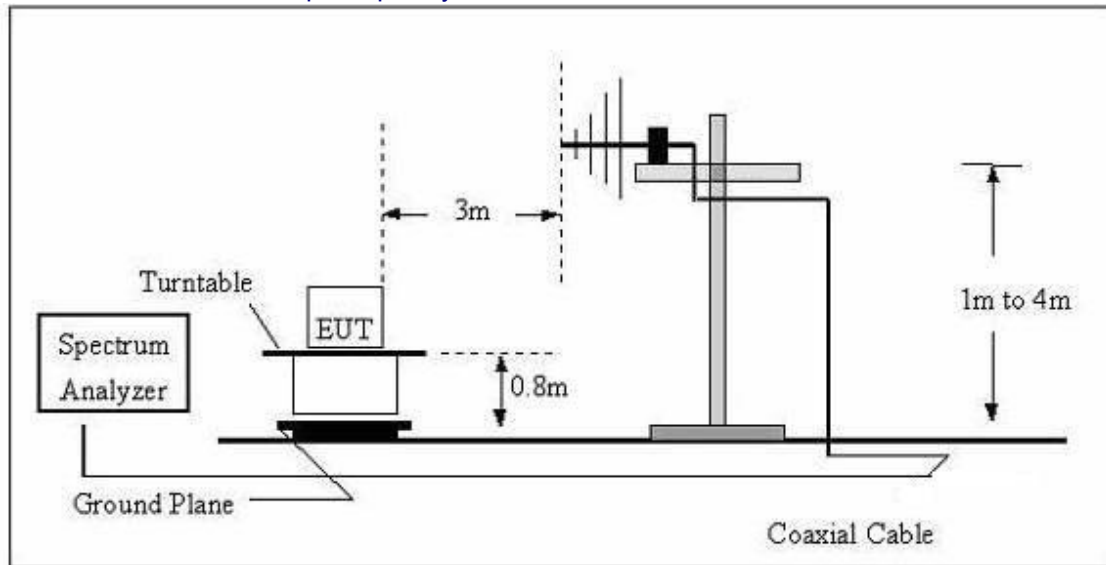

(C) Radiated Emission Test-Up Frequency Above 1GHz

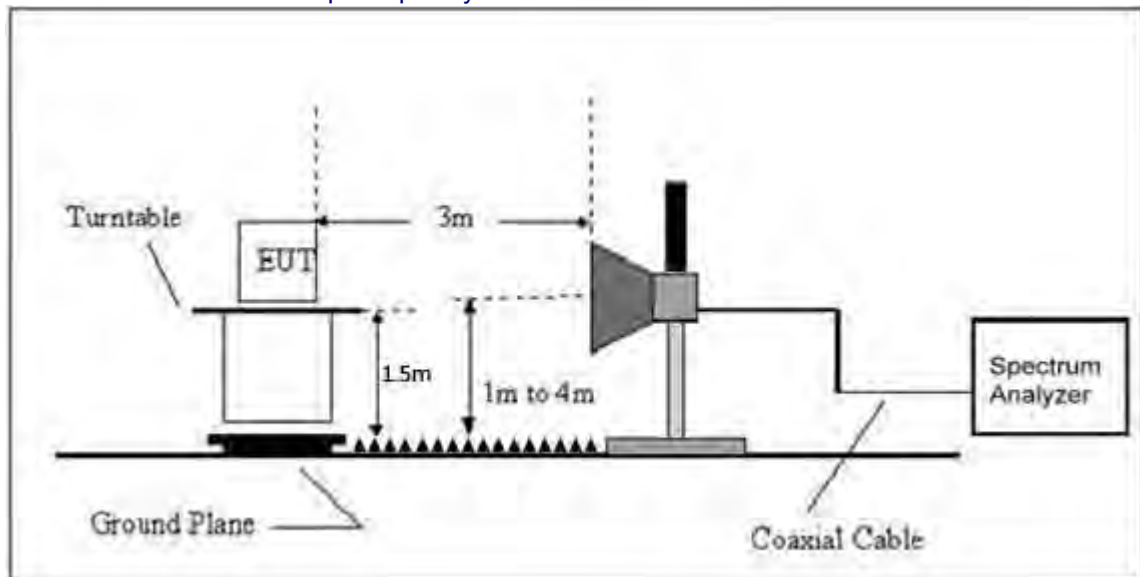

4.2.5 EUT OPERATING CONDITIONS

The EUT tested system was configured as the statements of 2.4 Unless otherwise a special operating condition is specified in the follows during the testing.

4.2.6 TEST RESULTS

Between 9KHz – 30MHz

The emission from 9 kHz to 30MHz was pre-tested and found the result was 20dB lower than the limit, and according to 15.31(o) & RSS-Gen 6.13, the test result no need to reported.

Between 30MHz – 1GHz

Temperature:	26°C	Relative Humidity:	54%
Pressure:	101kPa	Polarization:	Horizontal
Test Voltage:	AC 120V/60Hz	Test mode	3-DH5 2480.00



No.	Mk.	Freq.	Reading Level	Correct Factor	Measurement	Limit	Over	Antenna Height	Table Degree	
		MHz	dBuV	dB/m	dBuV/m	dBuV/m	dB	cm	degree	Comment
1		140.3421	40.96	-9.89	31.07	43.50	-12.43	QP 100	0	
2		181.2834	37.49	-10.79	26.70	43.50	-16.80	QP 100	38	
3		211.5265	42.96	-10.17	32.79	43.50	-10.71	QP 100	270	
4		250.3012	43.88	-10.72	33.16	46.00	-12.84	QP 100	360	
5		315.4808	39.32	-7.70	31.62	46.00	-14.38	QP 100	129	
6	*	501.1790	45.79	-3.18	42.61	46.00	-3.39	QP 100	0	

Temperature:	26°C	Relative Humidity:	54%
Pressure:	101kPa	Polarization:	Vertical
Test Voltage:	AC 120V/60Hz	Test mode	3-DH5 2480.00

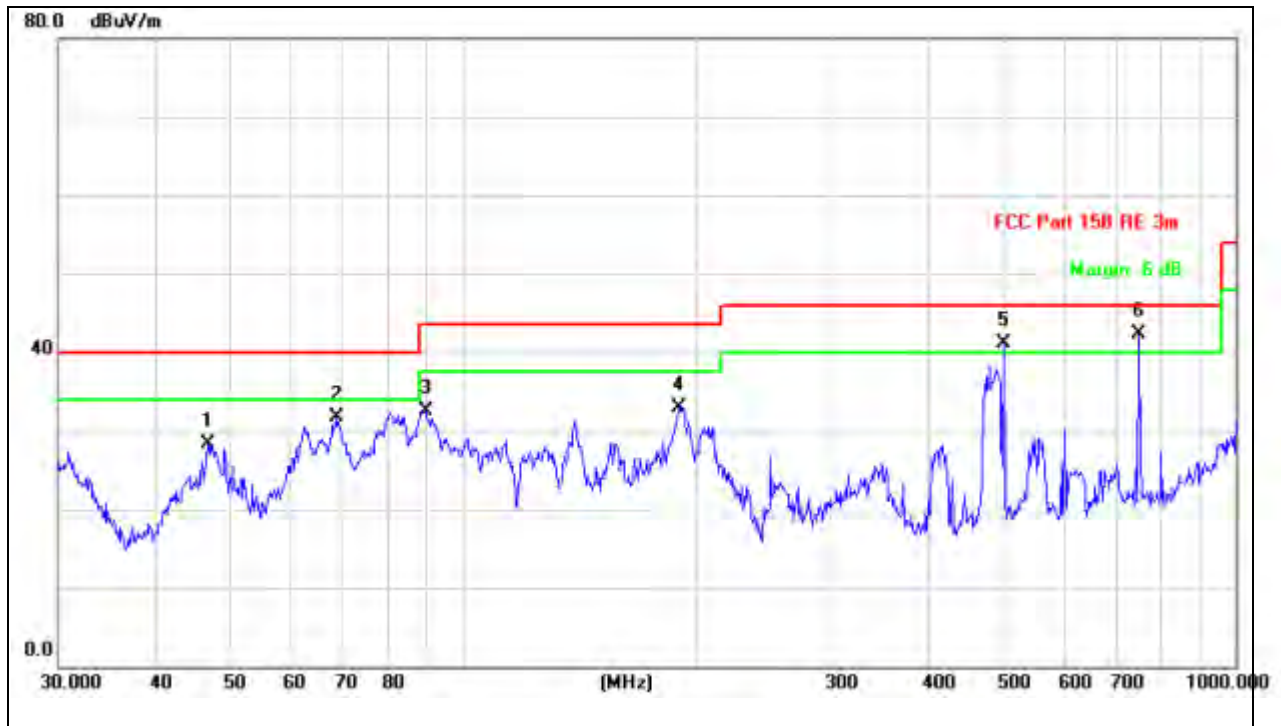

No.	Mk.	Freq.	Reading Level	Correct Factor	Measurement	Limit	Over	Antenna Height	Table Degree	
		MHz	dBuV	dB/m	dBuV/m	dBuV/m	dB	cm	degree	Comment
1		46.8303	42.10	-13.83	28.27	40.00	-11.73	QP	100	60
2		68.8721	46.87	-15.16	31.71	40.00	-8.29	QP	100	35
3		89.5899	47.85	-15.37	32.48	43.50	-11.02	QP	100	33
4		190.4050	43.38	-10.41	32.97	43.50	-10.53	QP	100	128
5	!	501.1790	44.19	-3.18	41.01	46.00	-4.99	QP	100	360
6	*	750.1083	41.26	1.06	42.32	46.00	-3.68	QP	100	334

Remarks:

1. Final Level = Receiver Read level + Antenna Factor + Cable Loss – Preamplifier Factor
2. The emission levels of other frequencies are very lower than the limit and not show in test report.

1GHz~25GHz

GFSK

Polar (H/V)	Frequency	Meter Reading	Pre-amplifier	Cable Loss	Antenna Factor	Emission Level	Limits	Margin	Detector Type
	(MHz)	(dBuV)	(dB)	(dB)	(dB)	(dBuV/m)	(dBuV/m)	(dB)	
Low Channel:2402MHz									
V	4804	54.57	30.55	5.77	24.66	54.45	74.00	-19.55	Pk
V	4804	42.10	30.55	5.77	24.66	41.98	54.00	-12.02	AV
V	7206	53.47	30.33	6.32	24.55	54.01	74.00	-19.99	Pk
V	7206	40.22	30.33	6.32	24.55	40.76	54.00	-13.24	AV
V	9608	51.93	30.85	7.45	24.69	53.22	74.00	-20.78	Pk
V	9608	36.94	30.85	7.45	24.69	38.23	54.00	-15.77	AV
H	4804	54.29	30.55	5.77	24.66	54.17	74.00	-19.83	Pk
H	4804	39.40	30.55	5.77	24.66	39.28	54.00	-14.72	AV
H	7206	53.60	30.33	6.32	24.55	54.14	74.00	-19.86	Pk
H	7206	39.19	30.33	6.32	24.55	39.73	54.00	-14.27	AV
H	9608	52.30	30.85	7.45	24.69	53.59	74.00	-20.41	Pk
H	9608	37.68	30.85	7.45	24.69	38.97	54.00	-15.03	AV

Polar (H/V)	Frequency	Meter Reading	Pre-amplifier	Cable Loss	Antenna Factor	Emission Level	Limits	Margin	Detector Type
	(MHz)	(dBuV)	(dB)	(dB)	(dB)	(dBuV/m)	(dBuV/m)	(dB)	
Middle Channel:2441MHz									
V	4882	55.11	30.55	5.77	24.66	54.99	74.00	-19.01	Pk
V	4882	40.81	30.55	5.77	24.66	40.69	54.00	-13.31	AV
V	7323	53.79	30.33	6.32	24.55	54.33	74.00	-19.67	Pk
V	7323	39.29	30.33	6.32	24.55	39.83	54.00	-14.17	AV
V	9764	51.21	30.85	7.45	24.69	52.50	74.00	-21.50	Pk
V	9764	37.00	30.85	7.45	24.69	38.29	54.00	-15.71	AV
H	4882	54.63	30.55	5.77	24.66	54.51	74.00	-19.49	Pk
H	4882	40.40	30.55	5.77	24.66	40.28	54.00	-13.72	AV
H	7323	52.78	30.33	6.32	24.55	53.32	74.00	-20.68	Pk
H	7323	40.82	30.33	6.32	24.55	41.36	54.00	-12.64	AV
H	9764	52.14	30.85	7.45	24.69	53.43	74.00	-20.57	Pk
H	9764	38.76	30.85	7.45	24.69	40.05	54.00	-13.95	AV

Polar (H/V)	Frequency	Meter Reading	Pre-amplifier	Cable Loss	Antenna Factor	Emission Level	Limits	Margin	Detector Type
	(MHz)	(dBuV)	(dB)	(dB)	(dB)	(dBuV/m)	(dBuV/m)	(dB)	
High Channel:2480MHz									
V	4960	56.12	30.55	5.77	24.66	56.00	74.00	-18.00	Pk
V	4960	40.81	30.55	5.77	24.66	40.69	54.00	-13.31	AV
V	7440	52.95	30.33	6.32	24.55	53.49	74.00	-20.51	Pk
V	7440	41.68	30.33	6.32	24.55	42.22	54.00	-11.78	AV
V	9920	50.43	30.85	7.45	24.69	51.72	74.00	-22.28	Pk
V	9920	36.43	30.85	7.45	24.69	37.72	54.00	-16.28	AV
H	4960	55.81	30.55	5.77	24.66	55.69	74.00	-18.31	Pk
H	4960	41.52	30.55	5.77	24.66	41.40	54.00	-12.60	AV
H	7440	53.57	30.33	6.32	24.55	54.11	74.00	-19.89	Pk
H	7440	40.16	30.33	6.32	24.55	40.70	54.00	-13.30	AV
H	9920	52.64	30.85	7.45	24.69	53.93	74.00	-20.07	Pk
H	9920	37.00	30.85	7.45	24.69	38.29	54.00	-15.71	AV

$\pi/4$ -DQPSK

Polar (H/V)	Frequency	Meter Reading	Pre-amplifier	Cable Loss	Antenna Factor	Emission Level	Limits	Margin	Detector Type
	(MHz)	(dBuV)	(dB)	(dB)	(dB)	(dBuV/m)	(dBuV/m)	(dB)	
Low Channel:2402MHz									
V	4804	55.75	30.55	5.77	24.66	55.63	74.00	-18.37	Pk
V	4804	41.06	30.55	5.77	24.66	40.94	54.00	-13.06	AV
V	7206	53.97	30.33	6.32	24.55	54.51	74.00	-19.49	Pk
V	7206	40.35	30.33	6.32	24.55	40.89	54.00	-13.11	AV
V	9608	51.23	30.85	7.45	24.69	52.52	74.00	-21.48	Pk
V	9608	37.46	30.85	7.45	24.69	38.75	54.00	-15.25	AV
H	4804	54.85	30.55	5.77	24.66	54.73	74.00	-19.27	Pk
H	4804	40.29	30.55	5.77	24.66	40.17	54.00	-13.83	AV
H	7206	53.90	30.33	6.32	24.55	54.44	74.00	-19.56	Pk
H	7206	40.49	30.33	6.32	24.55	41.03	54.00	-12.97	AV
H	9608	50.03	30.85	7.45	24.69	51.32	74.00	-22.68	Pk
H	9608	36.88	30.85	7.45	24.69	38.17	54.00	-15.83	AV

Polar (H/V)	Frequency	Meter Reading	Pre-amplifier	Cable Loss	Antenna Factor	Emission Level	Limits	Margin	Detector Type
	(MHz)	(dBuV)	(dB)	(dB)	(dB)	(dBuV/m)	(dBuV/m)	(dB)	
Middle Channel:2441MHz									
V	4882	55.12	30.55	5.77	24.66	55.00	74.00	-19.00	Pk
V	4882	42.18	30.55	5.77	24.66	42.06	54.00	-11.94	AV
V	7323	54.37	30.33	6.32	24.55	54.91	74.00	-19.09	Pk
V	7323	41.64	30.33	6.32	24.55	42.18	54.00	-11.82	AV
V	9764	50.31	30.85	7.45	24.69	51.60	74.00	-22.40	Pk
V	9764	39.02	30.85	7.45	24.69	40.31	54.00	-13.69	AV
H	4882	54.30	30.55	5.77	24.66	54.18	74.00	-19.82	Pk
H	4882	39.87	30.55	5.77	24.66	39.75	54.00	-14.25	AV
H	7323	53.01	30.33	6.32	24.55	53.55	74.00	-20.45	Pk
H	7323	40.45	30.33	6.32	24.55	40.99	54.00	-13.01	AV
H	9764	50.72	30.85	7.45	24.69	52.01	74.00	-21.99	Pk
H	9764	37.13	30.85	7.45	24.69	38.42	54.00	-15.58	AV

Polar (H/V)	Frequency	Meter Reading	Pre-amplifier	Cable Loss	Antenna Factor	Emission Level	Limits	Margin	Detector Type
	(MHz)	(dBuV)	(dB)	(dB)	(dB)	(dBuV/m)	(dBuV/m)	(dB)	
High Channel:2480MHz									
V	4960	54.93	30.55	5.77	24.66	54.81	74.00	-19.19	Pk
V	4960	39.90	30.55	5.77	24.66	39.78	54.00	-14.22	AV
V	7440	54.14	30.33	6.32	24.55	54.68	74.00	-19.32	Pk
V	7440	38.77	30.33	6.32	24.55	39.31	54.00	-14.69	AV
V	9920	52.11	30.85	7.45	24.69	53.40	74.00	-20.60	Pk
V	9920	38.23	30.85	7.45	24.69	39.52	54.00	-14.48	AV
H	4960	56.63	30.55	5.77	24.66	56.51	74.00	-17.49	Pk
H	4960	42.03	30.55	5.77	24.66	41.91	54.00	-12.09	AV
H	7440	54.18	30.33	6.32	24.55	54.72	74.00	-19.28	Pk
H	7440	38.97	30.33	6.32	24.55	39.51	54.00	-14.49	AV
H	9920	50.96	30.85	7.45	24.69	52.25	74.00	-21.75	Pk
H	9920	37.66	30.85	7.45	24.69	38.95	54.00	-15.05	AV

8-DPSK

Polar (H/V)	Frequency	Meter Reading	Pre-amplifier	Cable Loss	Antenna Factor	Emission Level	Limits	Margin	Detector Type
	(MHz)	(dBuV)	(dB)	(dB)	(dB)	(dBuV/m)	(dBuV/m)	(dB)	
Low Channel:2402MHz									
V	4804	56.69	30.55	5.77	24.66	56.57	74.00	-17.43	Pk
V	4804	42.06	30.55	5.77	24.66	41.94	54.00	-12.06	AV
V	7206	53.53	30.33	6.32	24.55	54.07	74.00	-19.93	Pk
V	7206	41.35	30.33	6.32	24.55	41.89	54.00	-12.11	AV
V	9608	52.37	30.85	7.45	24.69	53.66	74.00	-20.34	Pk
V	9608	37.75	30.85	7.45	24.69	39.04	54.00	-14.96	AV
H	4804	54.21	30.55	5.77	24.66	54.09	74.00	-19.91	Pk
H	4804	41.08	30.55	5.77	24.66	40.96	54.00	-13.04	AV
H	7206	52.97	30.33	6.32	24.55	53.51	74.00	-20.49	Pk
H	7206	40.46	30.33	6.32	24.55	41.00	54.00	-13.00	AV
H	9608	50.49	30.85	7.45	24.69	51.78	74.00	-22.22	Pk
H	9608	37.57	30.85	7.45	24.69	38.86	54.00	-15.14	AV

Polar (H/V)	Frequency	Meter Reading	Pre-amplifier	Cable Loss	Antenna Factor	Emission Level	Limits	Margin	Detector Type
	(MHz)	(dBuV)	(dB)	(dB)	(dB)	(dBuV/m)	(dBuV/m)	(dB)	
Middle Channel:2441MHz									
V	4882	54.09	30.55	5.77	24.66	53.97	74.00	-20.03	Pk
V	4882	40.43	30.55	5.77	24.66	40.31	54.00	-13.69	AV
V	7323	52.82	30.33	6.32	24.55	53.36	74.00	-20.64	Pk
V	7323	39.18	30.33	6.32	24.55	39.72	54.00	-14.28	AV
V	9764	52.26	30.85	7.45	24.69	53.55	74.00	-20.45	Pk
V	9764	38.36	30.85	7.45	24.69	39.65	54.00	-14.35	AV
H	4882	56.34	30.55	5.77	24.66	56.22	74.00	-17.78	Pk
H	4882	40.88	30.55	5.77	24.66	40.76	54.00	-13.24	AV
H	7323	53.17	30.33	6.32	24.55	53.71	74.00	-20.29	Pk
H	7323	40.18	30.33	6.32	24.55	40.72	54.00	-13.28	AV
H	9764	50.18	30.85	7.45	24.69	51.47	74.00	-22.53	Pk
H	9764	36.49	30.85	7.45	24.69	37.78	54.00	-16.22	AV

Polar (H/V)	Frequency	Meter Reading	Pre-amplifier	Cable Loss	Antenna Factor	Emission Level	Limits	Margin	Detector Type
	(MHz)	(dBuV)	(dB)	(dB)	(dB)	(dBuV/m)	(dBuV/m)	(dB)	
High Channel:2480MHz									
V	4960	56.03	30.55	5.77	24.66	55.91	74.00	-18.09	Pk
V	4960	40.25	30.55	5.77	24.66	40.13	54.00	-13.87	AV
V	7440	53.84	30.33	6.32	24.55	54.38	74.00	-19.62	Pk
V	7440	40.52	30.33	6.32	24.55	41.06	54.00	-12.94	AV
V	9920	49.83	30.85	7.45	24.69	51.12	74.00	-22.88	Pk
V	9920	37.16	30.85	7.45	24.69	38.45	54.00	-15.55	AV
H	4960	54.58	30.55	5.77	24.66	54.46	74.00	-19.54	Pk
H	4960	39.78	30.55	5.77	24.66	39.66	54.00	-14.34	AV
H	7440	53.30	30.33	6.32	24.55	53.84	74.00	-20.16	Pk
H	7440	39.65	30.33	6.32	24.55	40.19	54.00	-13.81	AV
H	9920	52.30	30.85	7.45	24.69	53.59	74.00	-20.41	Pk
H	9920	38.96	30.85	7.45	24.69	40.25	54.00	-13.75	AV

Remark:

1. Emission Level = Meter Reading + Antenna Factor + Cable Loss – Pre-amplifier,
Margin= Emission Level - Limit
2. If peak below the average limit, the average emission was no test.
3. The amplitude of spurious emissions which are attenuated by more than 20dB below the permissible value has no need to be reported.

5. RADIATED BAND EMISSION MEASUREMENT

5.1 Test Requirement:

Test Requirement:	FCC Part15 C Section 15.209 and 15.205				
Test Method:	ANSI C63.10: 2013				
Test Frequency Range:	All of the restrict bands were tested, only the worst band's (2310MHz to 2500MHz) data was showed.				
Test site:	Measurement Distance: 3m				
Receiver setup:	Frequency	Detector	RBW	VBW	Value
	Above 1GHz	Peak	1MHz	3MHz	Peak
		Average	1MHz	3MHz	Average

LIMITS OF RADIATED EMISSION MEASUREMENT (Above 1000MHz)

FREQUENCY (MHz)	Limit (dBuV/m) (at 3M)	
	PEAK	AVERAGE
Above 1000	74	54

Notes:

- (1) The limit for radiated test was performed according to FCC PART 15C.
- (2) The tighter limit applies at the band edges.
- (3) Emission level (dBuV/m)=20log Emission level (uV/m).

Spectrum Parameter	Setting
Attenuation	Auto
Start Frequency	2300MHz
Stop Frequency	2520
RB / VB (emission in restricted band)	1 MHz / 1 MHz for Peak, 1 MHz / 10Hz for Average

5.2 TEST PROCEDURE

Above 1GHz test procedure as below:

- a. 1. The EUT was placed on the top of a rotating table 1.5 meters above the ground at a 3 meter camber. The table was rotated 360 degrees to determine the position of the highest radiation.
- b. The EUT was set 3 meters away from the interference-receiving antenna, which was mounted on the top of a variable-height antenna tower.
- c. The antenna height is varied from one meter to four meters above the ground to determine the maximum value of the field strength. Both horizontal and vertical polarizations of the antenna are set to make the measurement.
- d. For each suspected emission, the EUT was arranged to its worst case and then the antenna was tuned to heights from 1 meter to 4 meters and the rota table was turned from 0 degrees to 360 degrees to find the maximum reading.
- e. The test-receiver system was set to Peak Detect Function and Specified Bandwidth with Maximum Hold Mode.
- f. If the emission level of the EUT in peak mode was 10dB lower than the limit specified, then testing could be stopped and the peak values of the EUT would be reported. Otherwise the emissions that did not have 10dB margin would be re-tested one by one using peak, quasi-peak or average method as specified and then reported in a data sheet.
- g. Test the EUT in the lowest channel,the Highest channel

Note:

Both horizontal and vertical antenna polarities were tested and performed pretest to three orthogonal axis. The worst case emissions were reported

5.3 DEVIATION FROM TEST STANDARD

No deviation

5.4 TEST SETUP

Radiated Emission Test-Up Frequency Above 1GHz

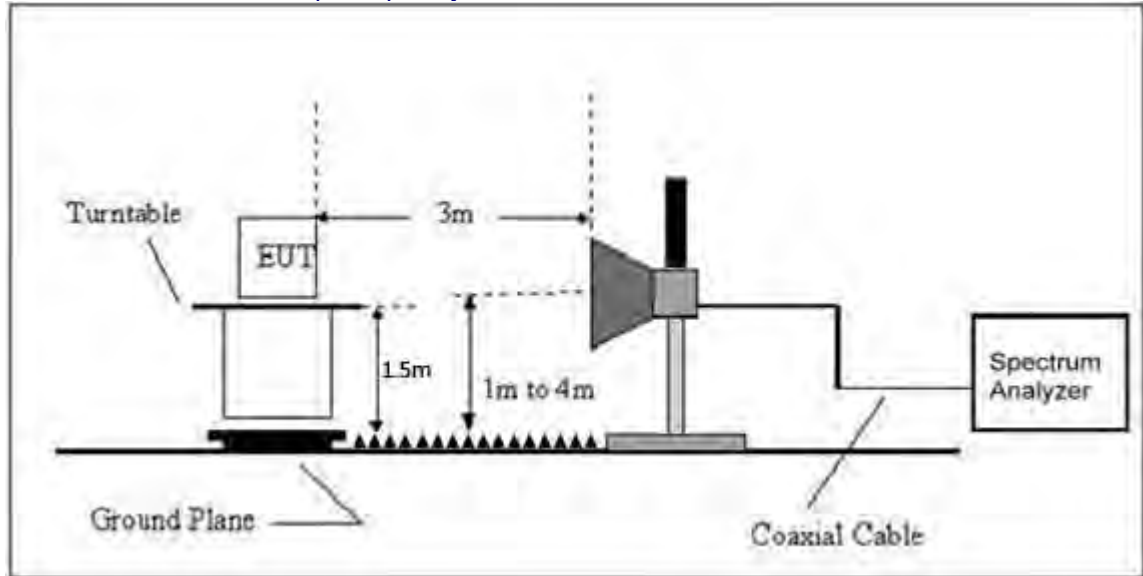

5.5 EUT OPERATING CONDITIONS

The EUT tested system was configured as the statements of 2.3 Unless otherwise a special operating condition is specified in the follows during the testing.

5.6 TEST RESULT

GFSK

Polar (H/V)	Frequency (MHz)	Meter Reading (dBuV)	Pre-amplifier (dB)	Cable Loss (dB)	Antenna Factor (dB/m)	Emission level (dBuV/m)	Limit (dBuV/m)	Margin (dBuV/m)	Detect or Type	Result
Low Channel: 2402MHz										
H	2390.00	52.80	30.22	4.85	23.98	51.41	74	-22.59	PK	PASS
H	2390.00	38.12	30.22	4.85	23.98	36.73	54	-17.27	AV	PASS
H	2400.00	53.09	30.22	4.85	23.98	51.70	74	-22.30	PK	PASS
H	2400.00	38.71	30.22	4.85	23.98	37.32	54	-16.68	AV	PASS
V	2390.00	53.37	30.22	4.85	23.98	51.98	74	-22.02	PK	PASS
V	2390.00	38.33	30.22	4.85	23.98	36.94	54	-17.06	AV	PASS
V	2400.00	54.64	30.22	4.85	23.98	53.25	74	-20.75	PK	PASS
V	2400.00	36.52	30.22	4.85	23.98	35.13	54	-18.87	AV	PASS
High Channel: 2480MHz										
H	2483.50	51.03	30.22	4.85	23.98	49.64	74	-24.36	PK	PASS
H	2485.50	37.54	30.22	4.85	23.98	36.15	54	-17.85	AV	PASS
H	2500.00	54.08	30.22	4.85	23.98	52.69	74	-21.31	PK	PASS
H	2500.00	38.50	30.22	4.85	23.98	37.11	54	-16.89	AV	PASS
V	2483.50	51.75	30.22	4.85	23.98	50.36	74	-23.64	PK	PASS
V	2485.50	37.72	30.22	4.85	23.98	36.33	54	-17.67	AV	PASS
V	2500.00	54.23	30.22	4.85	23.98	52.84	74	-21.16	PK	PASS
V	2500.00	37.73	30.22	4.85	23.98	36.34	54	-17.66	AV	PASS

$\pi/4$ -DQPSK

Polar (H/V)	Frequency (MHz)	Meter Reading (dBuV)	Pre-amplifier (dB)	Cable Loss (dB)	Antenna Factor (dB/m)	Emission level (dBuV/m)	Limit (dBuV/m)	Margin (dBuV/m)	Detect or Type	Result
Low Channel: 2402MHz										
H	2390.00	51.91	30.22	4.85	23.98	50.52	74	-23.48	PK	PASS
H	2390.00	39.94	30.22	4.85	23.98	38.55	54	-15.45	AV	PASS
H	2400.00	52.25	30.22	4.85	23.98	50.86	74	-23.14	PK	PASS
H	2400.00	36.87	30.22	4.85	23.98	35.48	54	-18.52	AV	PASS
V	2390.00	53.22	30.22	4.85	23.98	51.83	74	-22.17	PK	PASS
V	2390.00	39.40	30.22	4.85	23.98	38.01	54	-15.99	AV	PASS
V	2400.00	54.57	30.22	4.85	23.98	53.18	74	-20.82	PK	PASS
V	2400.00	36.67	30.22	4.85	23.98	35.28	54	-18.72	AV	PASS
High Channel: 2480MHz										
H	2483.50	50.92	30.22	4.85	23.98	49.53	74	-24.47	PK	PASS
H	2483.50	37.52	30.22	4.85	23.98	36.13	54	-17.87	AV	PASS
H	2500.00	53.17	30.22	4.85	23.98	51.78	74	-22.22	PK	PASS
H	2500.00	36.75	30.22	4.85	23.98	35.36	54	-18.64	AV	PASS
V	2483.50	52.06	30.22	4.85	23.98	50.67	74	-23.33	PK	PASS
V	2483.50	38.25	30.22	4.85	23.98	36.86	54	-17.14	AV	PASS
V	2500.00	54.00	30.22	4.85	23.98	52.61	74	-21.39	PK	PASS
V	2500.00	37.25	30.22	4.85	23.98	35.86	54	-18.14	AV	PASS

8DPSK

Polar (H/V)	Frequency (MHz)	Meter Reading (dBuV)	Pre-amplifier (dB)	Cable Loss (dB)	Antenna Factor (dB/m)	Emission level (dBuV/m)	Limit (dBuV/m)	Margin (dBuV/m)	Detect or Type	Result
Low Channel: 2402MHz										
H	2390.00	52.22	30.22	4.85	23.98	50.83	74	-23.17	PK	PASS
H	2390.00	37.91	30.22	4.85	23.98	36.52	54	-17.48	AV	PASS
H	2400.00	53.04	30.22	4.85	23.98	51.65	74	-22.35	PK	PASS
H	2400.00	37.56	30.22	4.85	23.98	36.17	54	-17.83	AV	PASS
V	2390.00	52.92	30.22	4.85	23.98	51.53	74	-22.47	PK	PASS

V	2390.00	39.59	30.22	4.85	23.98	38.20	54	-15.80	AV	PASS
V	2400.00	52.56	30.22	4.85	23.98	51.17	74	-22.83	PK	PASS
V	2400.00	38.05	30.22	4.85	23.98	36.66	54	-17.34	AV	PASS
High Channel: 2480MHz										
H	2483.50	52.71	30.22	4.85	23.98	51.32	74	-22.68	PK	PASS
H	2483.50	40.10	30.22	4.85	23.98	38.71	54	-15.29	AV	PASS
H	2500.00	54.30	30.22	4.85	23.98	52.91	74	-21.09	PK	PASS
H	2500.00	38.37	30.22	4.85	23.98	36.98	54	-17.02	AV	PASS
V	2483.50	51.09	30.22	4.85	23.98	49.70	74	-24.30	PK	PASS
V	2483.50	40.07	30.22	4.85	23.98	38.68	54	-15.32	AV	PASS
V	2500.00	52.05	30.22	4.85	23.98	50.66	74	-23.34	PK	PASS
V	2500.00	37.41	30.22	4.85	23.98	36.02	54	-17.98	AV	PASS

6. CONDUCTED BAND EDGE AND SPURIOUS EMISSION

Test Requirement:	FCC Part15 C Section 15.247 (d)
Test Method:	KDB558074 D0115.247 Meas Guidancev05r02

6.1 Limit

Regulation 15.247 (d), In any 100 kHz bandwidth outside the frequency band in which the spread spectrum or digitally modulated intentional radiator is operating, the radio frequency power that is produced by the intentional radiator shall be at least 20 dB below that in the 100 kHz bandwidth within the band that contains the highest level of the desired power, based on either an RF conducted or a radiated measurement, provided the transmitter demonstrates compliance with the peak conducted power limits. If the transmitter complies with the conducted power limits based on the use of RMS averaging over a time interval, as permitted under paragraph (b)(3) of this section, the attenuation required under this paragraph shall be 30 dB instead of 20 dB. Attenuation below the general limits specified in §15.209(a) is not required. In addition, radiated emissions which fall in the restricted bands, as defined in §15.205(a), must also comply with the radiated emission limits specified in §15.209(a) (see §15.205(c)).

6.2 Test Setup

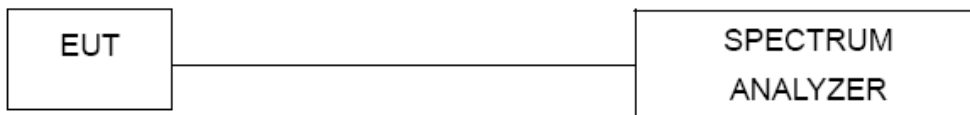

6.3 Test procedure

Using the following spectrum analyzer setting:

- A) Set the RBW = 100KHz.
- B) Set the VBW = 300KHz.
- C) Sweep time = auto couple.
- D) Detector function = peak.
- E) Trace mode = max hold.
- F) Allow trace to fully stabilize.

6.4 DEVIATION FROM STANDARD

No deviation.

6.5 Test Result

PASS: PLEASE REFER TO APPENDIX: APPENDIX1 FOR DETAILS

7. 20dB Bandwidth

Test Requirement:	FCC Part15 C Section 15.247 (a)(1)
Test Method:	ANSI C63.10:2013

7.1 Test Setup

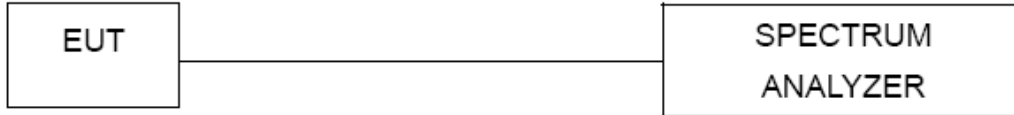

7.2 Limit

N/A

7.3 Test procedure

1. Set RBW = 30 kHz.
2. Set the video bandwidth (VBW) $\geq 3 \times$ RBW.
3. Detector = Peak.
4. Trace mode = max hold.
5. Sweep = auto couple.
6. Allow the trace to stabilize.
7. Measure the maximum width of the emission that is constrained by the frequencies associated with the two outermost amplitude points (upper and lower frequencies) that are attenuated by 6 dB relative to the maximum level measured in the fundamental emission.

7.4 DEVIATION FROM STANDARD

No deviation.

7.5 Test Result

PASS: PLEASE REFER TO APPENDIX: APPENDIX1 FOR DETAILS

8. Maximum Peak Output Power

Test Requirement:	FCC Part15 C Section 15.247 (b)(1)
Test Method:	ANSI C63.10:2013
Limit:	21

8.1 Block Diagram Of Test Setup



8.2 Limit

For frequency hopping systems operating in the 2400-2483.5 MHz band employing at least 75 non-overlapping hopping channels, and all frequency hopping systems in the 5725-5850 MHz band: 1 watt.
For all other frequency hopping systems in the 2400-2483.5 MHz band: 0.125 watts.

8.3 Test procedure

1. Remove the antenna from the EUT and then connect a low RF cable from the antenna port to the spectrum.
2. Set the spectrum analyzer: RBW >OBW. VBW >= RBW. Sweep = auto; Detector Function = Peak.
3. Keep the EUT in transmitting at lowest, medium and highest channel individually. Record the max value.

8.4 DEVIATION FROM STANDARD

No deviation.

8.5 Test Result

PASS: PLEASE REFER TO APPENDIX: APPENDIX1 FOR DETAILS

9. Hopping Channel Separation

Test Requirement:	FCC Part15 C Section 15.247 (a)(1)
Test Method:	ANSI C63.10:2013
Receiver setup:	RBW=100KHz, VBW=300KHz, detector=Peak
Limit:	0.025MHz or 2/3 of the 20dB bandwidth (whichever is greater)

9.1 Test Setup



9.2 Test procedure

1. Remove the antenna from the EUT and then connect a low RF cable from the antenna port to the spectrum.
2. Set the spectrum analyzer: RBW = 100kHz. VBW = 300kHz , Span = 3.0MHz. Sweep = auto; Detector Function = Peak. Trace = Max hold.
3. Allow the trace to stabilize. Use the marker-delta function to determine the separation between the peaks of the adjacent channels. The limit is specified in one of the subparagraphs of this Section Submit this plot.

9.3 DEVIATION FROM STANDARD

No deviation.

9.4 Test Result

PASS: PLEASE REFER TO APPENDIX: APPENDIX1 FOR DETAILS

10.NUMBER OF HOPPING FREQUENCY

Test Requirement:	FCC Part15 C Section 15.247 (a)(1)(iii)
Test Method:	ANSI C63.10:2013
Receiver setup:	RBW=100kHz, VBW=300kHz, Frequency range=2400MHz-2483.5MHz, Detector=Peak
Limit:	15 channels

10.1 Test Setup

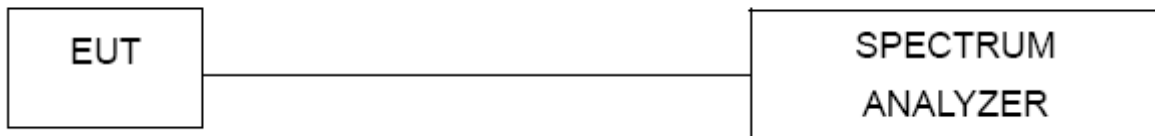

10.2 Test procedure

1. Remove the antenna from the EUT and then connect a low RF cable from the antenna port to the spectrum.
2. Set the spectrum analyzer: RBW = 100kHz. VBW = 300kHz. Sweep = auto; Detector Function = Peak. Trace = Max hold.
3. Allow the trace to stabilize. It may prove necessary to break the span up to sections. in order to clearly show all of the hopping frequencies. The limit is specified in one of the subparagraphs of this Section.
4. Set the spectrum analyzer: Start Frequency = 2.4GHz, Stop Frequency = 2.4835GHz. Sweep=auto;

10.3 DEVIATION FROM STANDARD

No deviation.

10.4 Test Result

PASS: PLEASE REFER TO APPENDIX: APPENDIX1 FOR DETAILS

11. DWELL TIME

Test Requirement:	FCC Part15 C Section 15.247 (a)(1)(iii)
Test Method:	ANSI C63.10:2013
Receiver setup:	RBW=1MHz, VBW=3MHz, Span=0Hz, Detector=Peak
Limit:	0.4 Second

11.1 Test Setup



11.2 Test procedure

1. Remove the antenna from the EUT and then connect a low RF cable from the antenna port to the spectrum.
2. Set spectrum analyzer span = 0Hz;
3. Set RBW = 1MHz and VBW = 3MHz. Sweep = as necessary to capture the entire dwell time per hopping channel. Set the EUT for DH5, DH3 and DH1 packet transmitting.
4. Use the marker-delta function to determine the dwell time. If this value varies with different modes of operation (e.g.. data rate. modulation format. etc.). repeat this test for each variation. The limit is specified in one of the subparagraphs of this Section. Submit this plot(s).

11.3 DEVIATION FROM STANDARD

No deviation.

11.4 Test Result

PASS: PLEASE REFER TO APPENDIX: APPENDIX1 FOR DETAILS

12. Antenna Requirement

Standard requirement:	FCC Part15 C Section 15.203 /247(c)
<p>15.203 requirement: An intentional radiator shall be designed to ensure that no antenna other than that furnished by the responsible party shall be used with the device. The use of a permanently attached antenna or of an antenna that uses a unique coupling to the intentional radiator, the manufacturer may design the unit so that a broken antenna can be replaced by the user, but the use of a standard antenna jack or electrical connector is prohibited.</p> <p>15.247(c) (1)(i) requirement: (i) Systems operating in the 2400-2483.5 MHz band that is used exclusively for fixed. Point-to-point operations may employ transmitting antennas with directional gain greater than 6dBi provided the maximum conducted output power of the intentional radiator is reduced by 1 dB for every 3 dB that the directional gain of the antenna exceeds 6dBi.</p>	
EUT Antenna:	
<p>The antenna is PCB antenna, the best case gain of the antenna is 1.26dBi, reference to the below photo for details ANT for BT</p> 	

13. Appendix 1

13.1 -20dB Bandwidth

Condition	Antenna	Modulation	Frequency (MHz)	-20dB BW(MHz)
NVNT	ANT1	1-DH5	2402.00	0.959
NVNT	ANT1	1-DH5	2441.00	0.957
NVNT	ANT1	1-DH5	2480.00	0.958
NVNT	ANT1	2-DH5	2402.00	1.275
NVNT	ANT1	2-DH5	2441.00	1.277
NVNT	ANT1	2-DH5	2480.00	1.282
NVNT	ANT1	3-DH5	2402.00	1.295
NVNT	ANT1	3-DH5	2441.00	1.296
NVNT	ANT1	3-DH5	2480.00	1.297

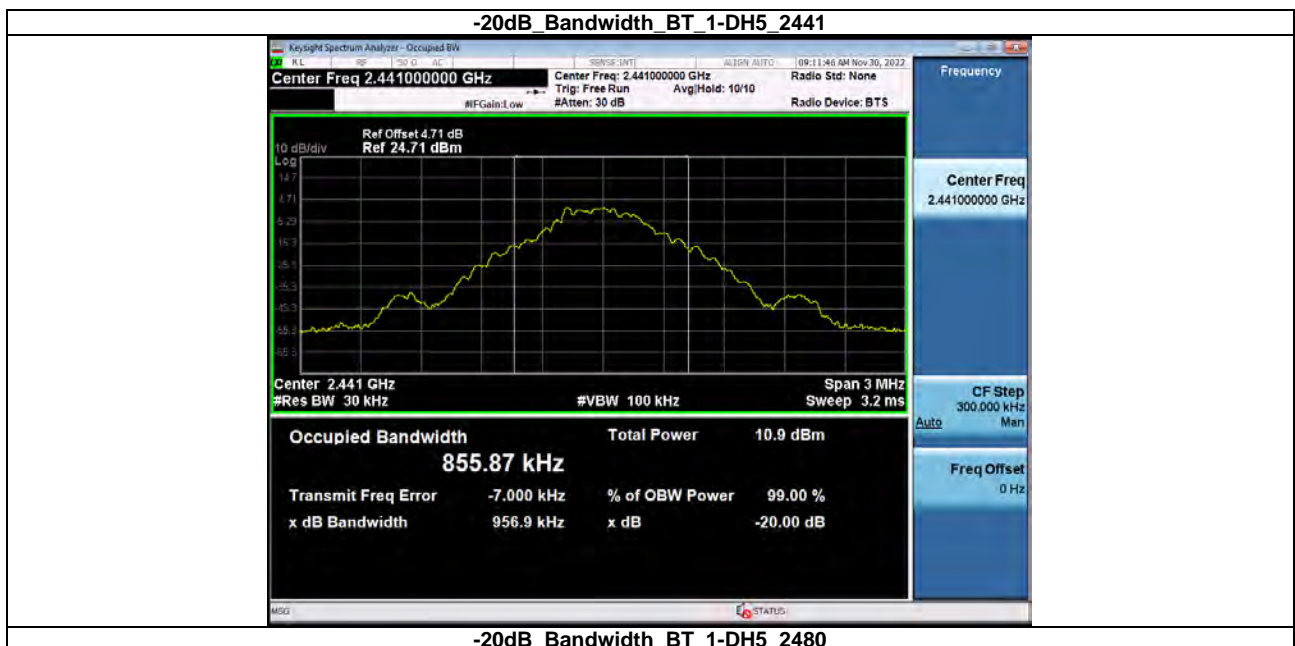
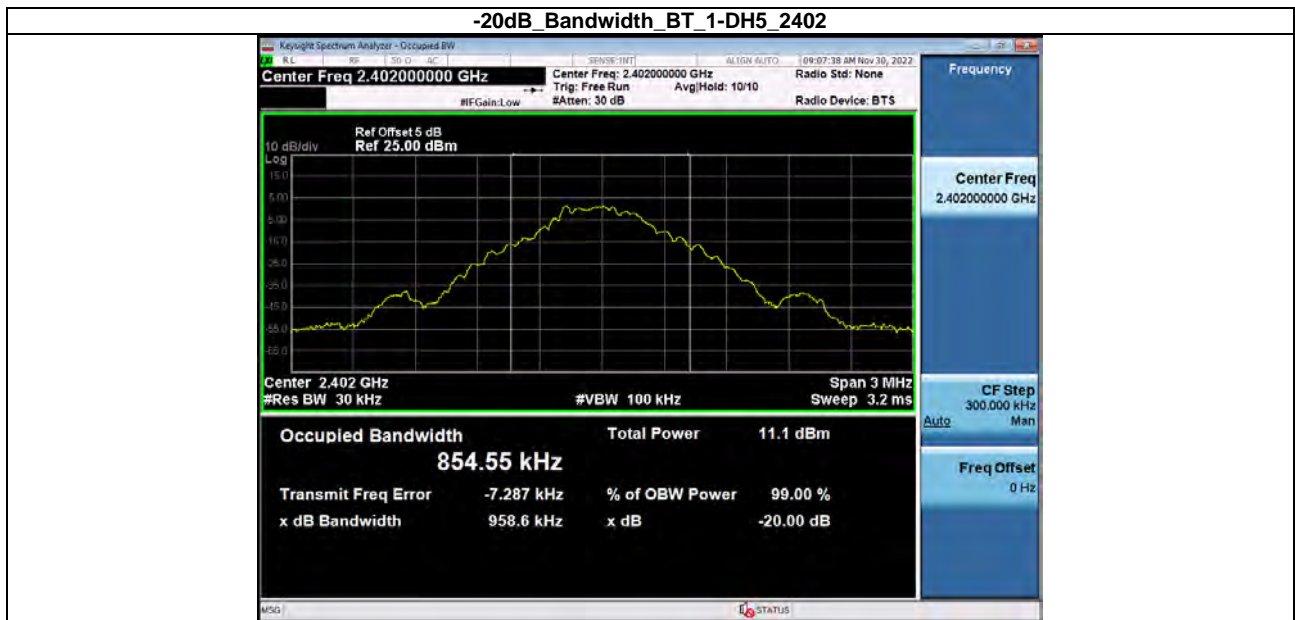

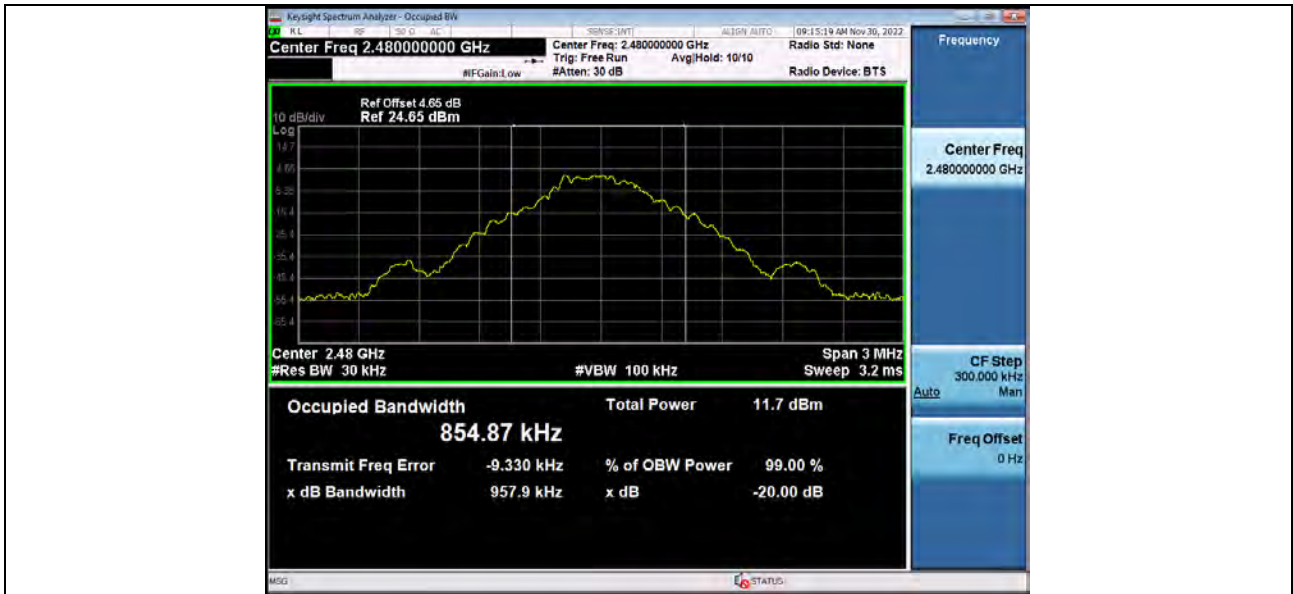

-20dB Bandwidth_BT_2-DH5_2402

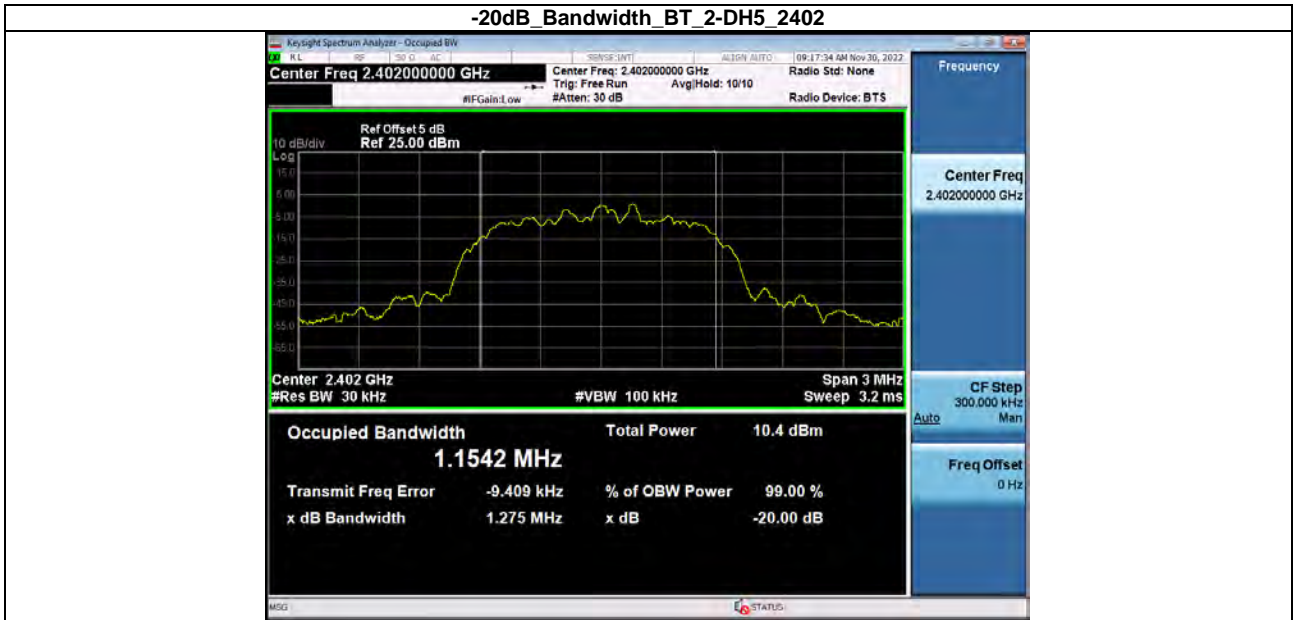

-20dB Bandwidth_BT_2-DH5_2441

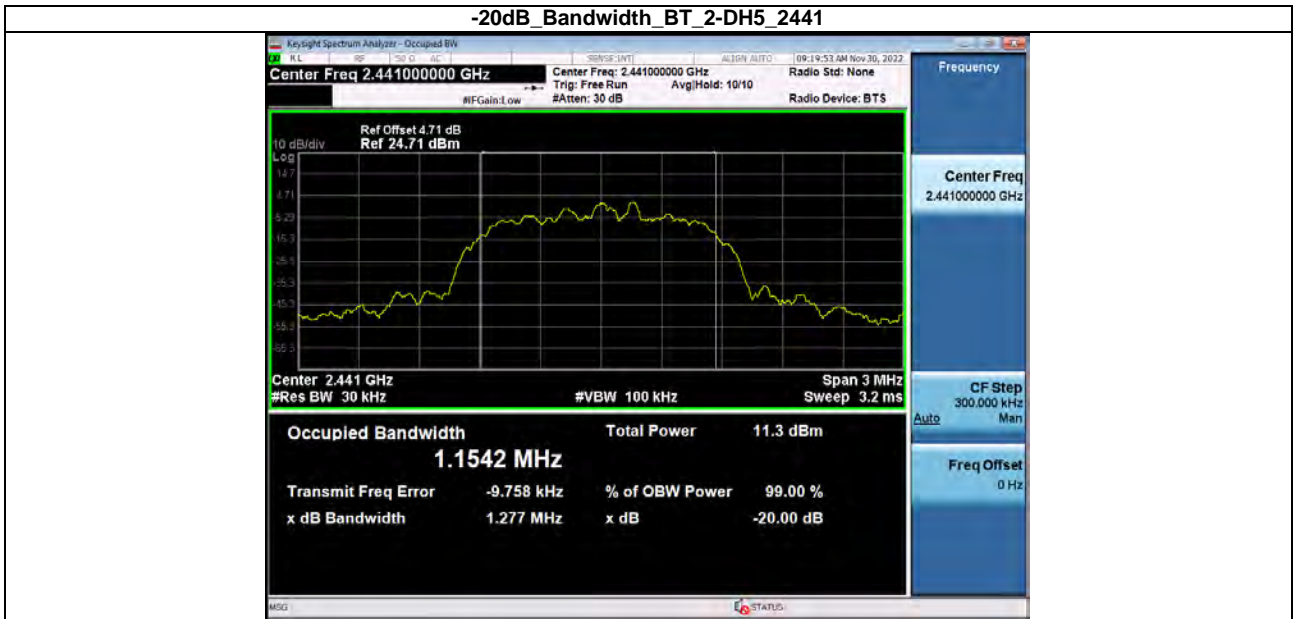

-20dB Bandwidth_BT_2-DH5_2480

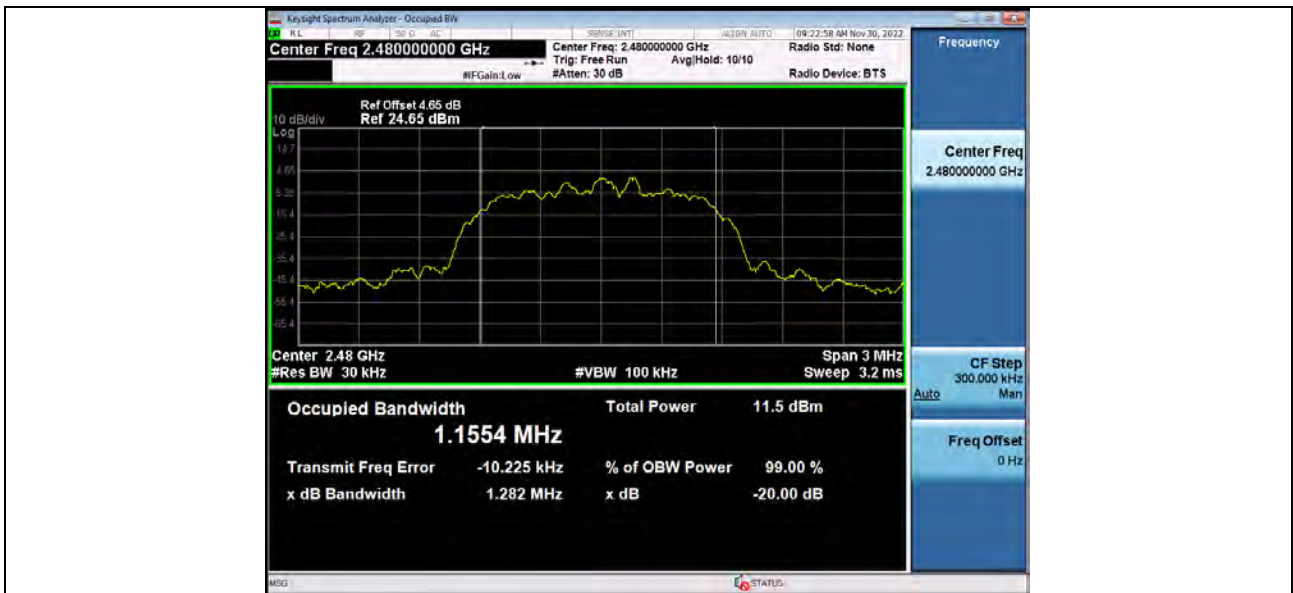

-20dB Bandwidth_BT_3-DH5_2402

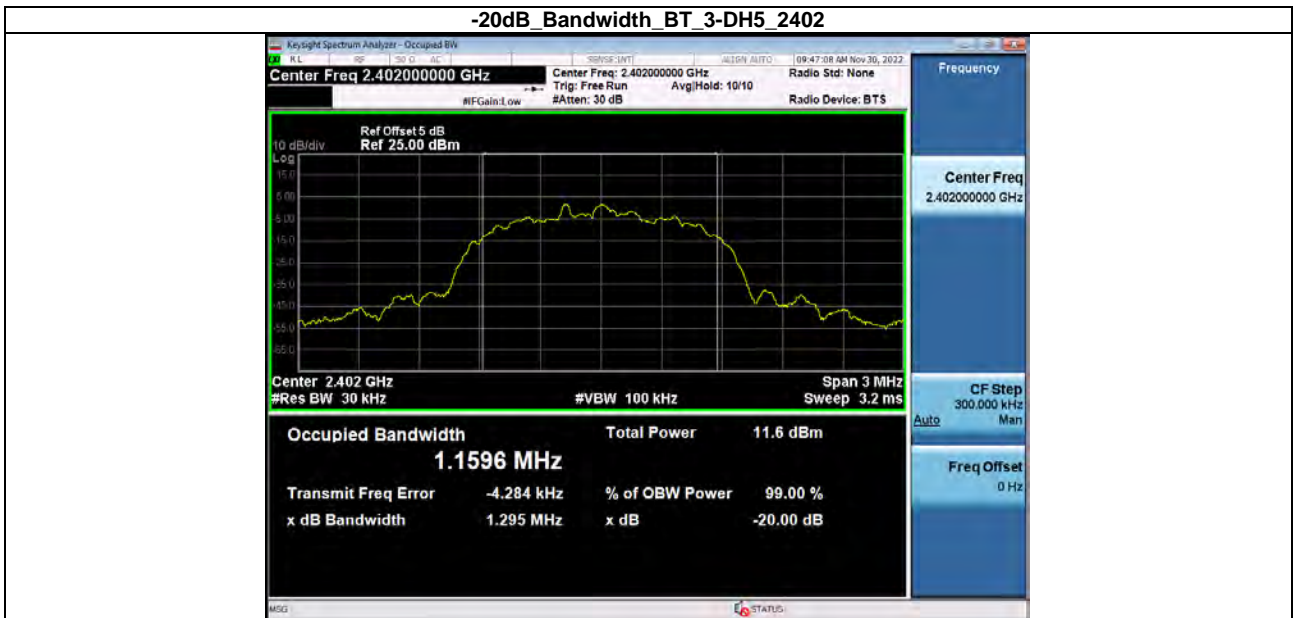

-20dB Bandwidth_BT_3-DH5_2441

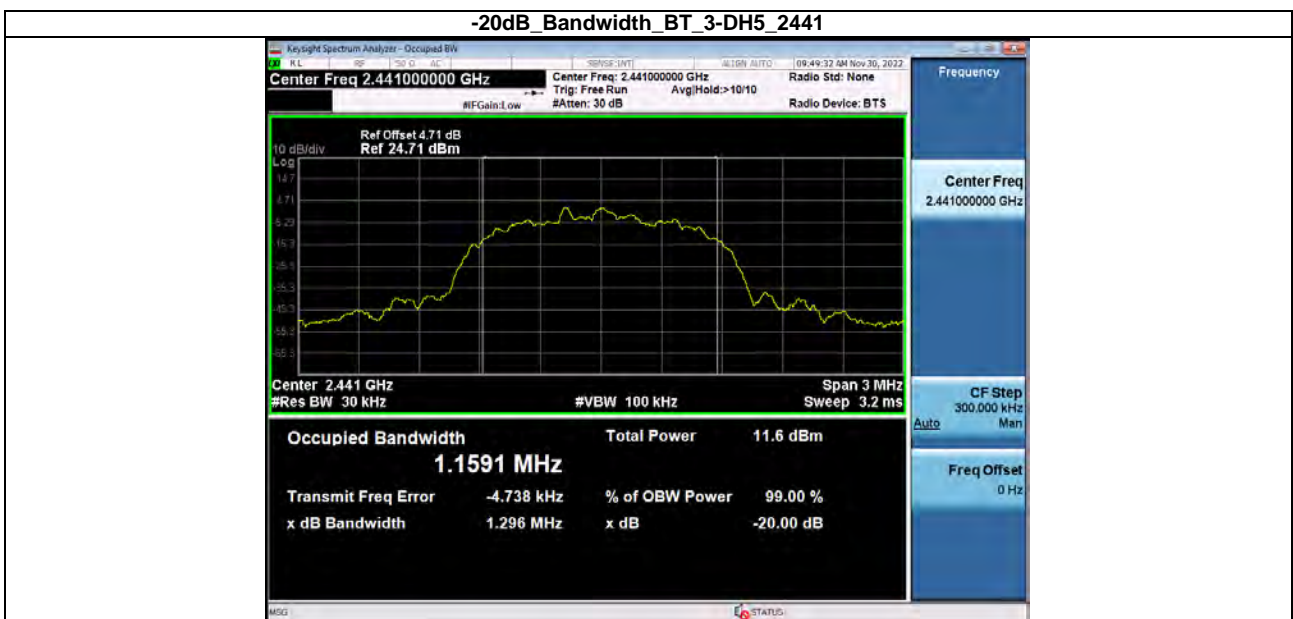

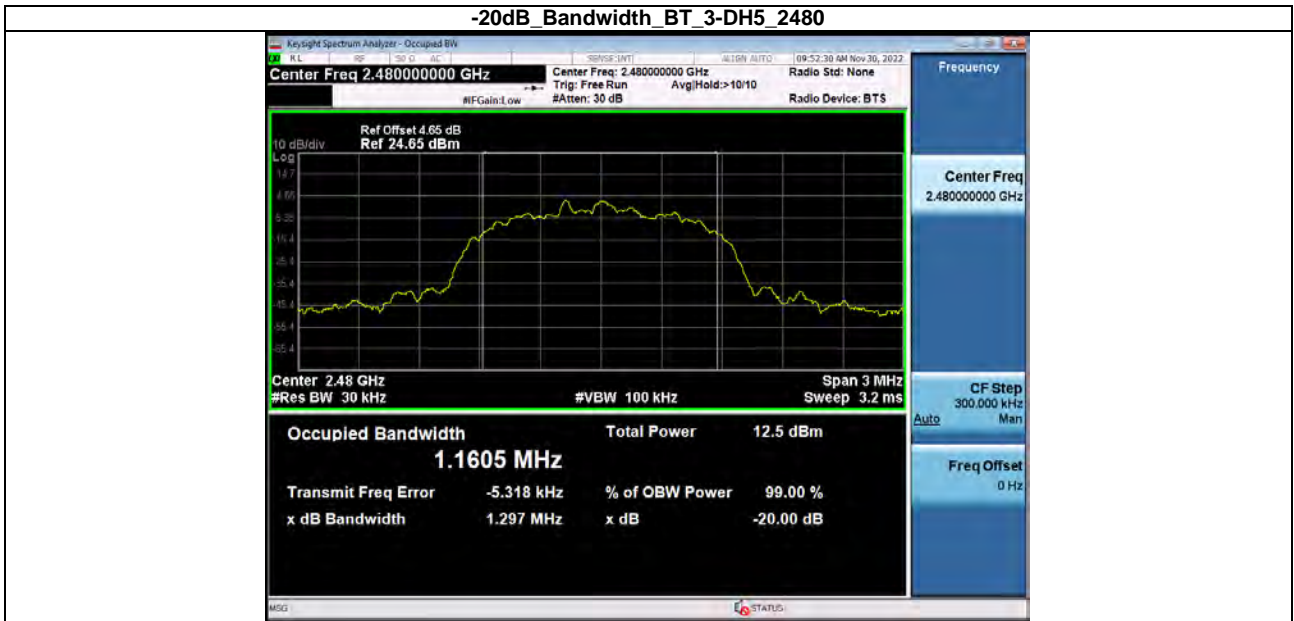

13.2 Peak Output Power

Condition	Antenna	Modulation	Frequency (MHz)	Max. Conducted Power(dBm)	Max. Conducted Power(mW)	Limit(mW)	Result
NVNT	ANT1	1-DH5	2402.00	3.57	2.28	125	Pass
NVNT	ANT1	1-DH5	2441.00	3.68	2.33	125	Pass
NVNT	ANT1	1-DH5	2480.00	4.40	2.75	125	Pass
NVNT	ANT1	2-DH5	2402.00	5.12	3.25	125	Pass
NVNT	ANT1	2-DH5	2441.00	4.81	3.02	125	Pass
NVNT	ANT1	2-DH5	2480.00	6.06	4.03	125	Pass
NVNT	ANT1	3-DH5	2402.00	5.91	3.90	125	Pass
NVNT	ANT1	3-DH5	2441.00	5.44	3.50	125	Pass
NVNT	ANT1	3-DH5	2480.00	6.99	5.00	125	Pass

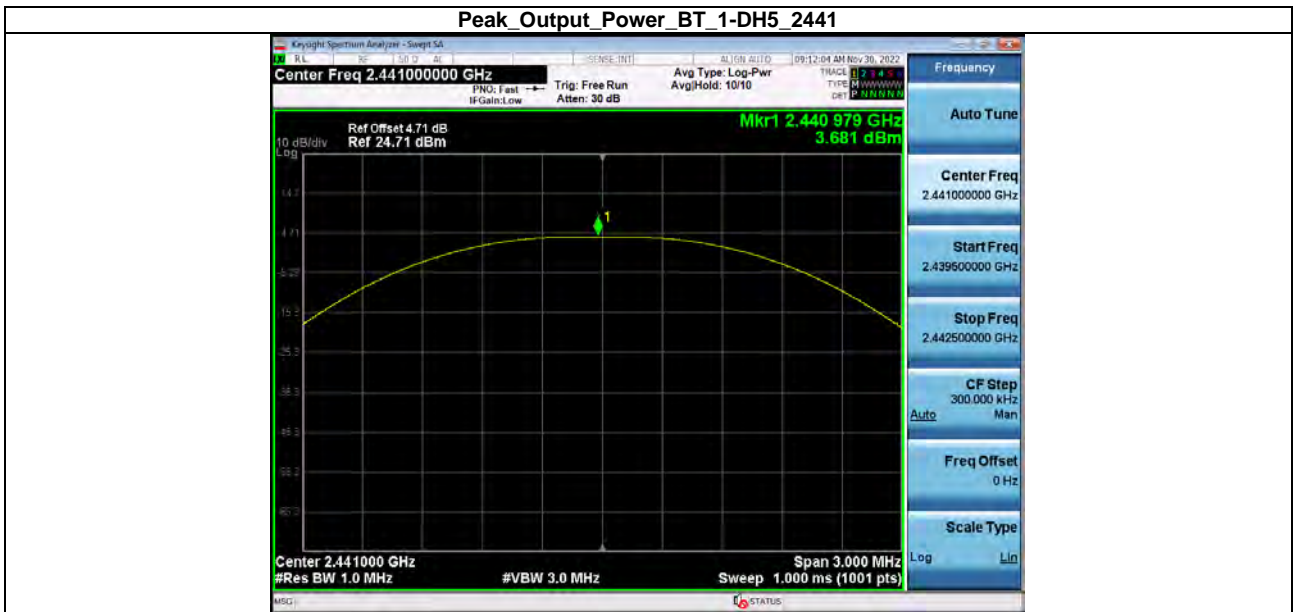

Peak_Output_Power_BT_1-DH5_2480

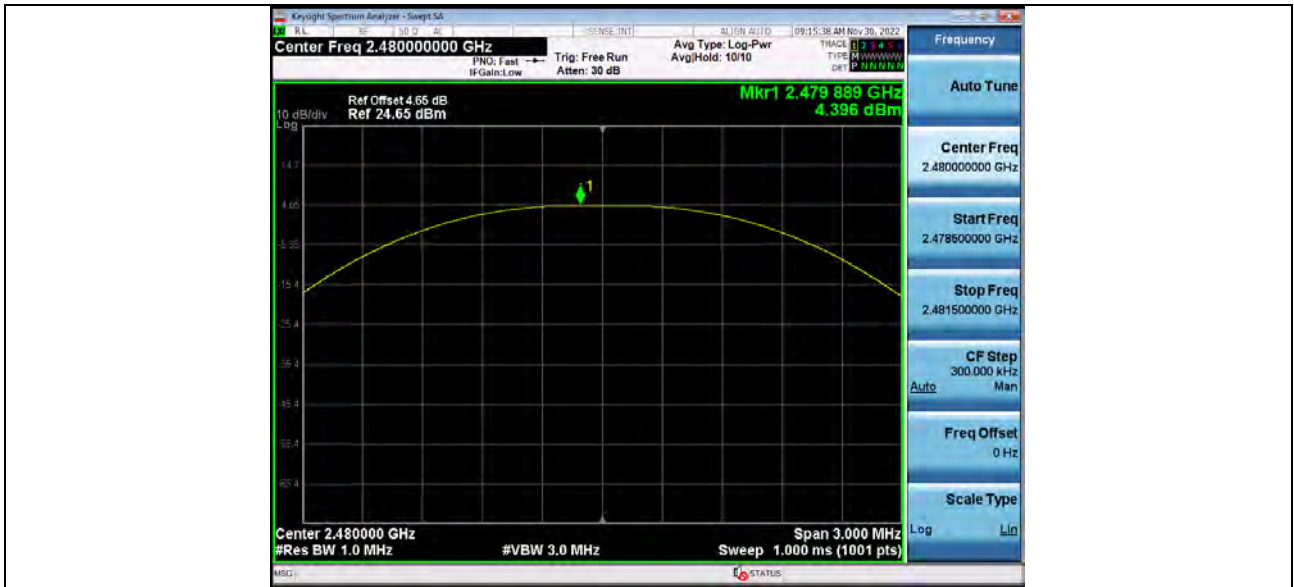

Peak Output Power BT 2-DH5_2402

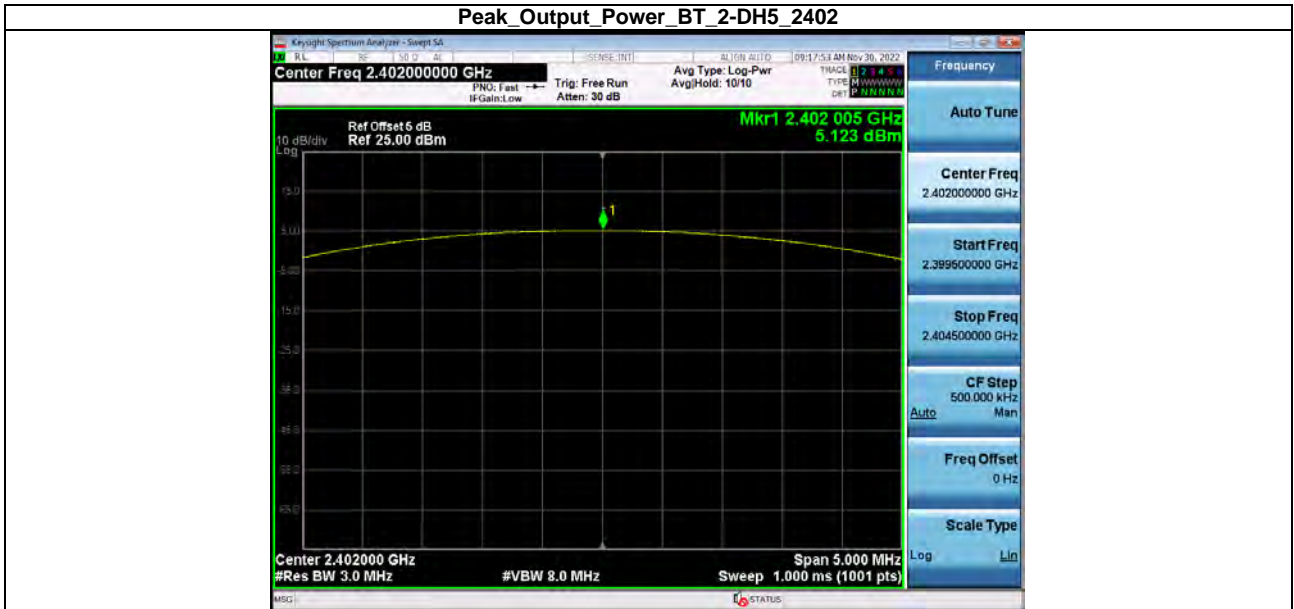

Peak Output Power BT 2-DH5_2441



Peak Output Power BT 2-DH5_2480

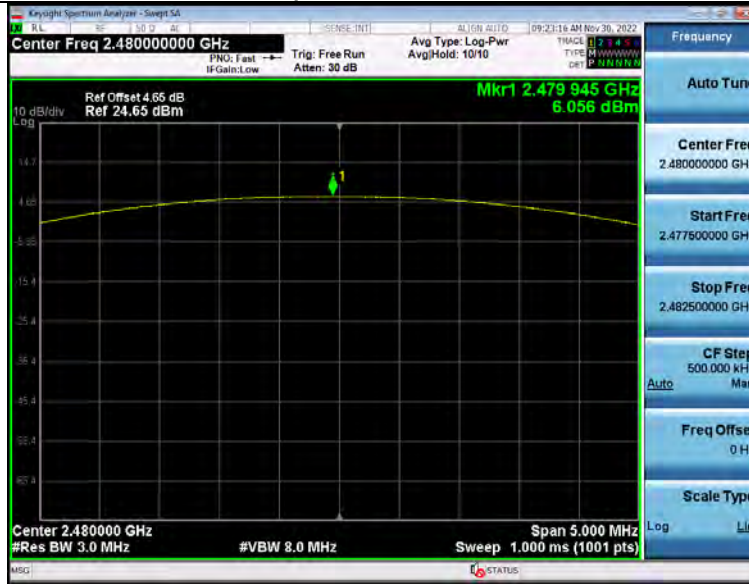

Peak Output Power BT 3-DH5_2402

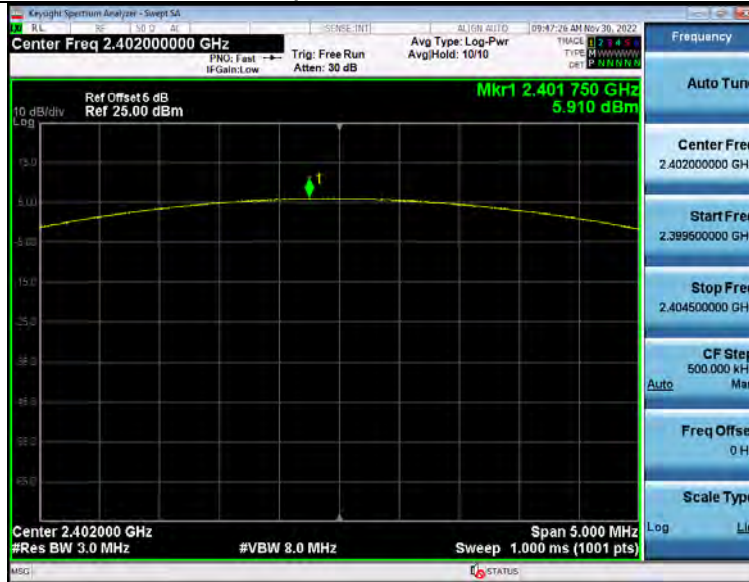

Peak Output Power BT 3-DH5_2441



Peak_Output_Power_BT_3-DH5_2480



13.3 Spurious Emissions

Condition	Antenna	Modulation	TX Mode	Result
NVNT	ANT1	1-DH5	2402.00	Pass
NVNT	ANT1	1-DH5	2441.00	Pass
NVNT	ANT1	1-DH5	2480.00	Pass
NVNT	ANT1	2-DH5	2402.00	Pass
NVNT	ANT1	2-DH5	2441.00	Pass
NVNT	ANT1	2-DH5	2480.00	Pass
NVNT	ANT1	3-DH5	2402.00	Pass
NVNT	ANT1	3-DH5	2441.00	Pass
NVNT	ANT1	3-DH5	2480.00	Pass

1 Reference Level BT_1-DH5_2402

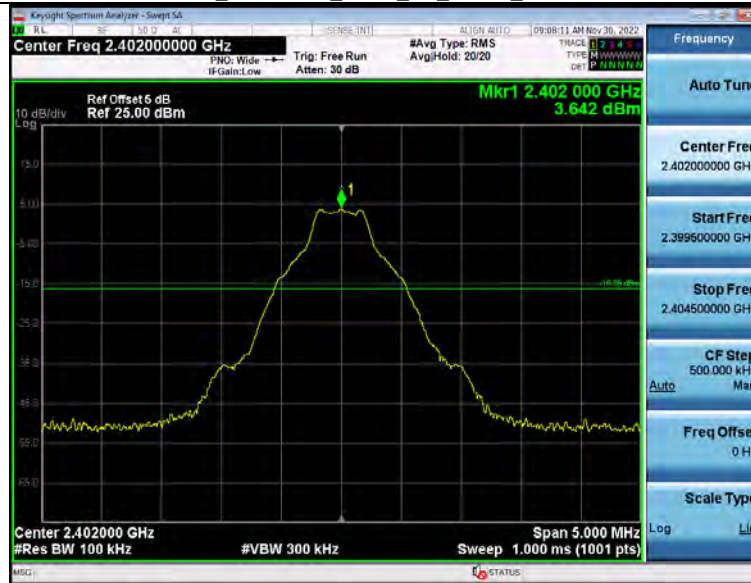

2 Spurious Emissions BT_1-DH5_2402

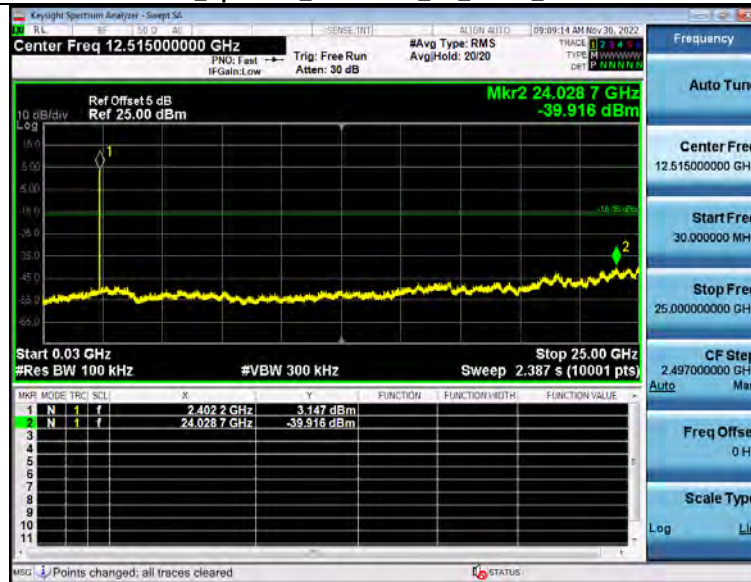

1 Reference Level BT_1-DH5_2441

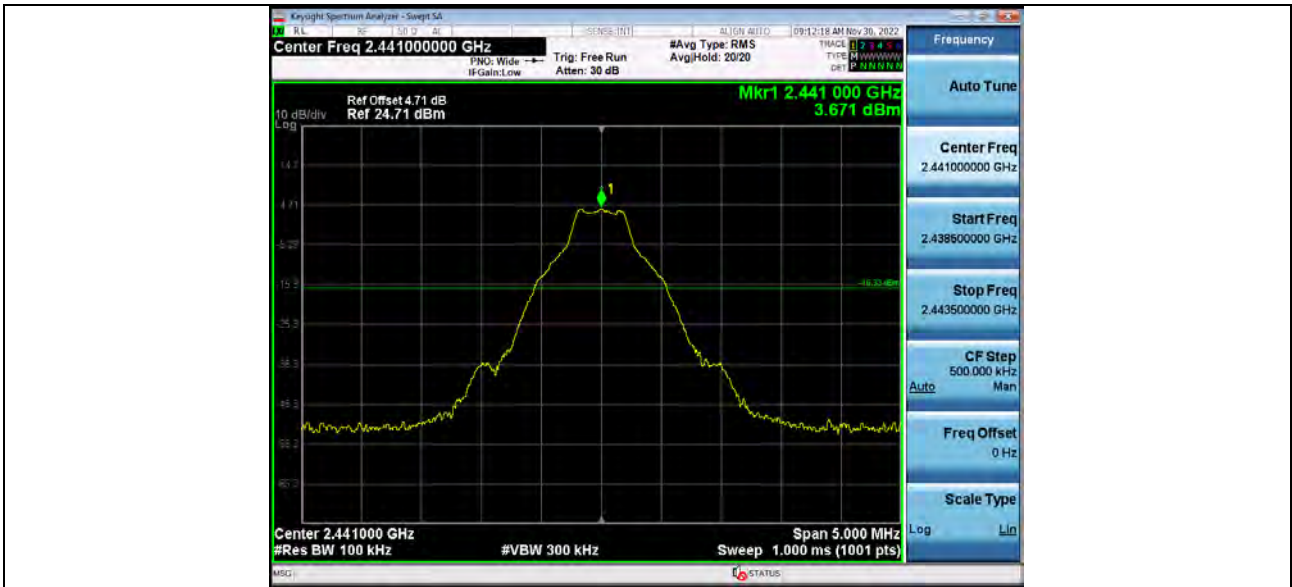

2_Spurious Emissions_BT_1-DH5_2441

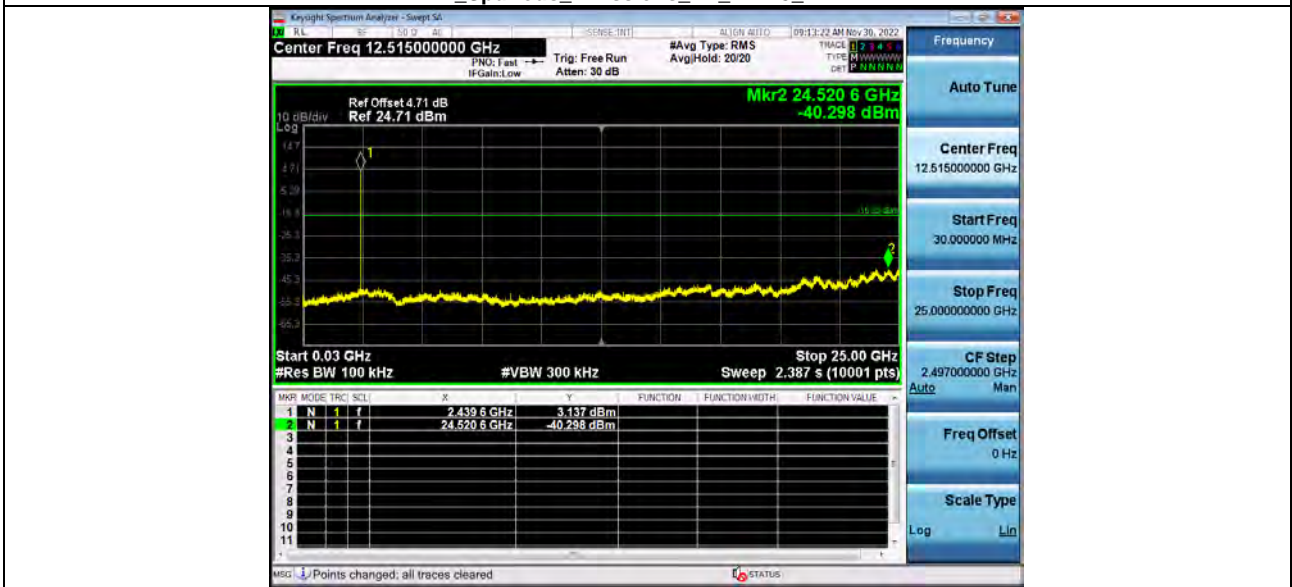

1_Reference Level_BT_1-DH5_2480

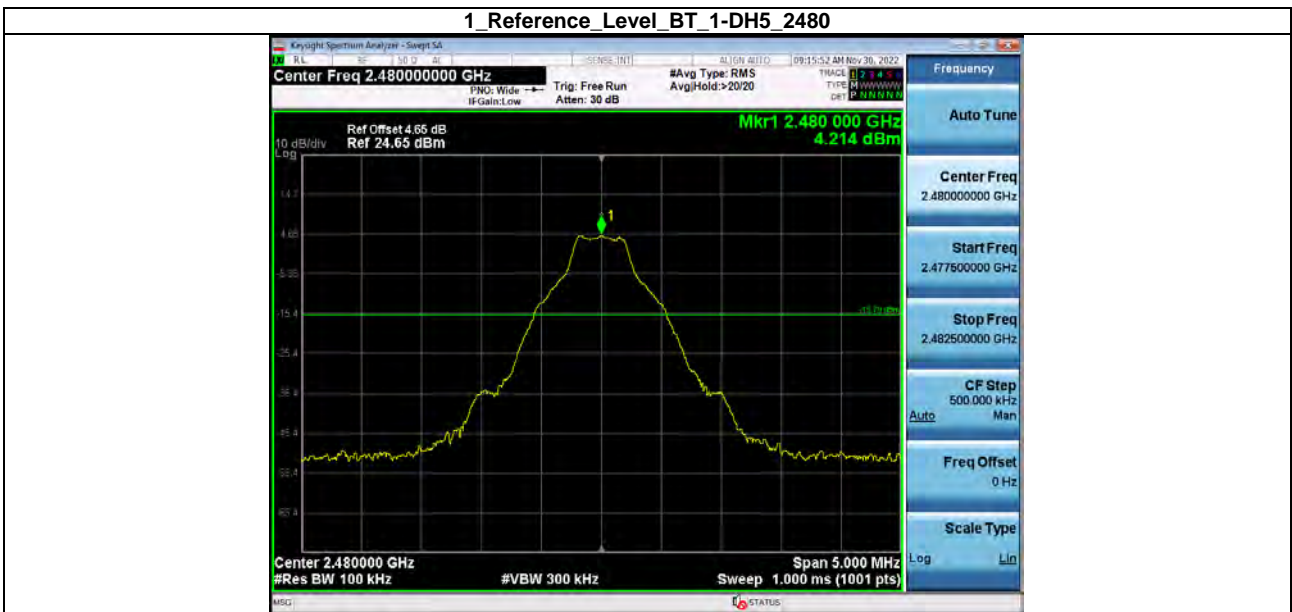

2_Spurious Emissions_BT_1-DH5_2480

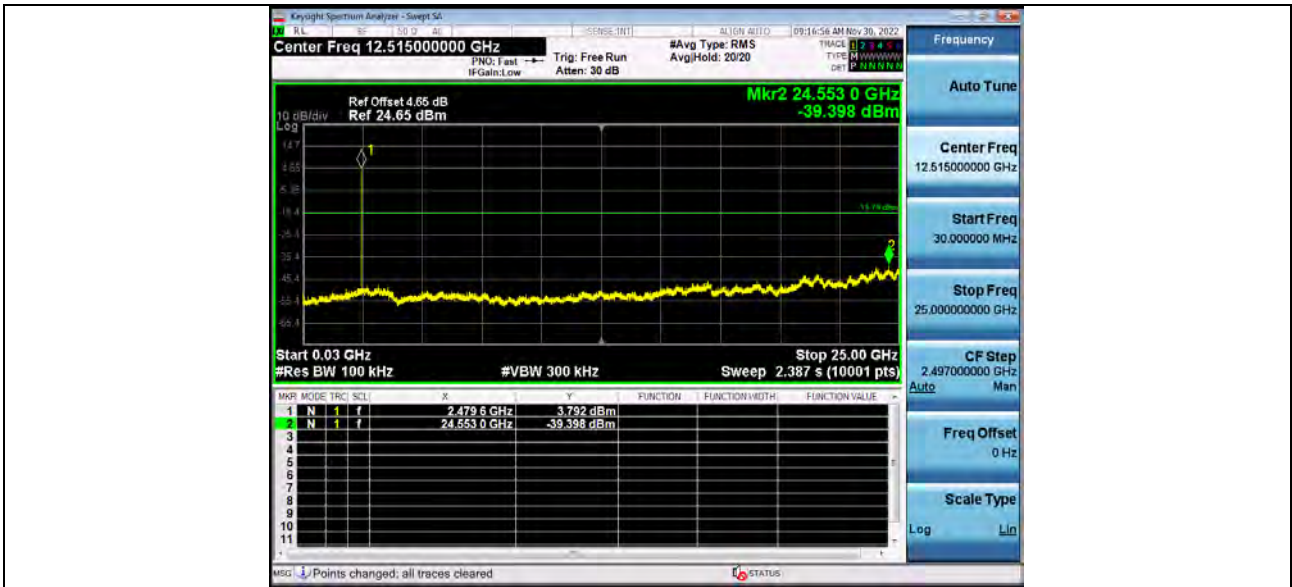

1_Reference Level_BT_2-DH5_2402

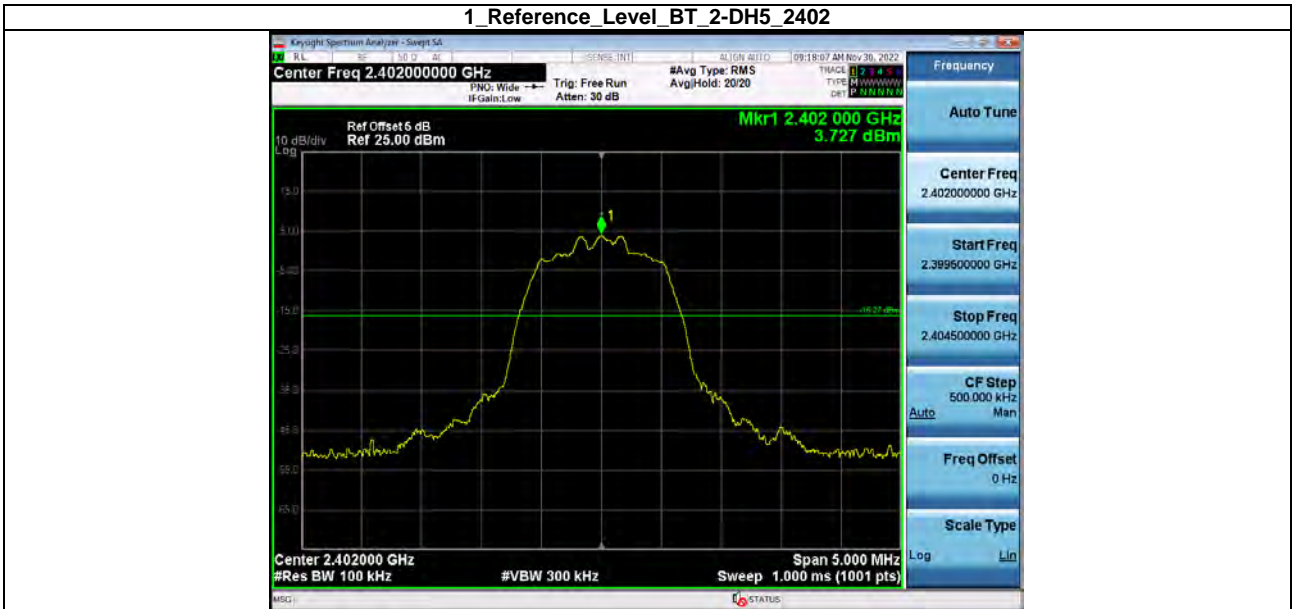

2_Spurious Emissions_BT_2-DH5_2402

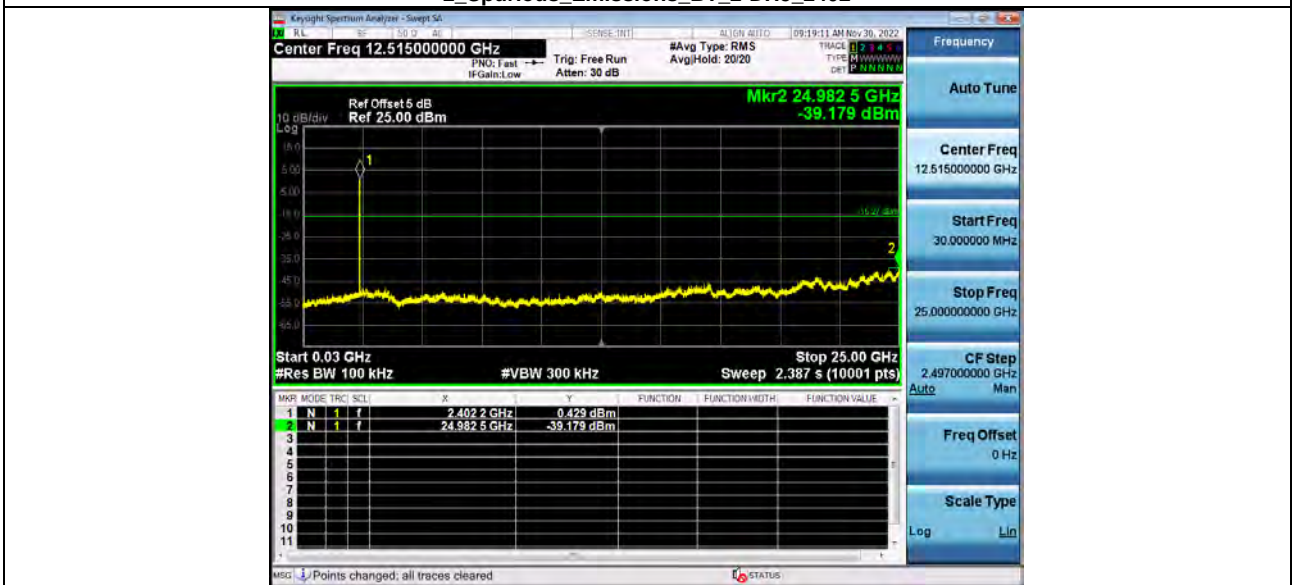

1_Reference Level_BT_2-DH5_2441

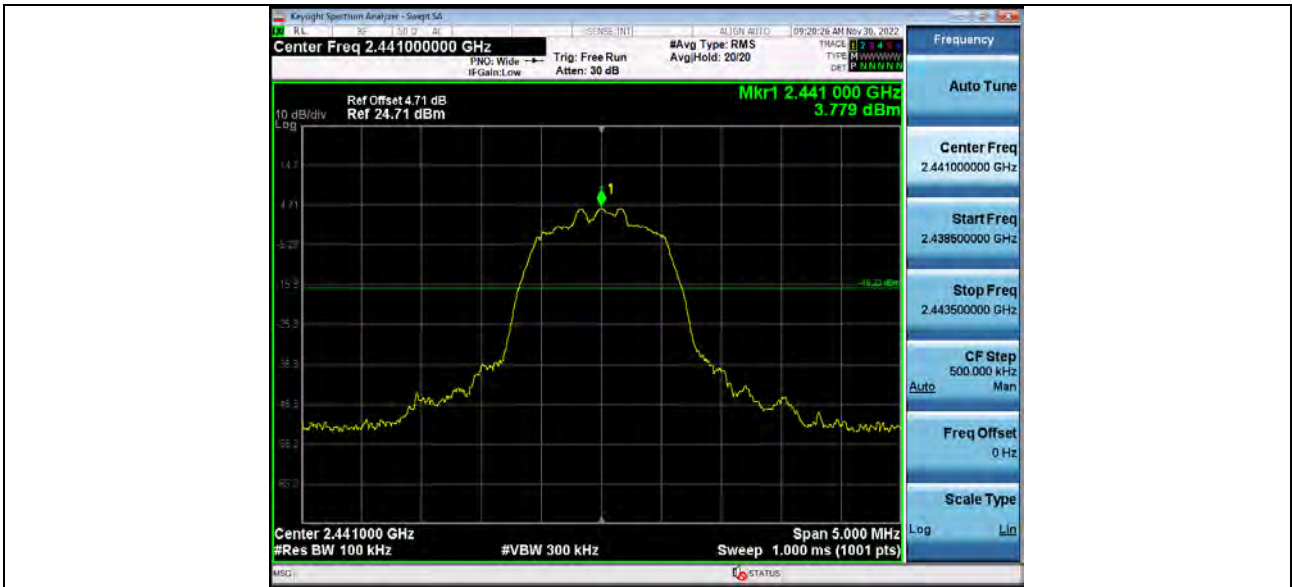

2_Spurious Emissions_BT_2-DH5_2441

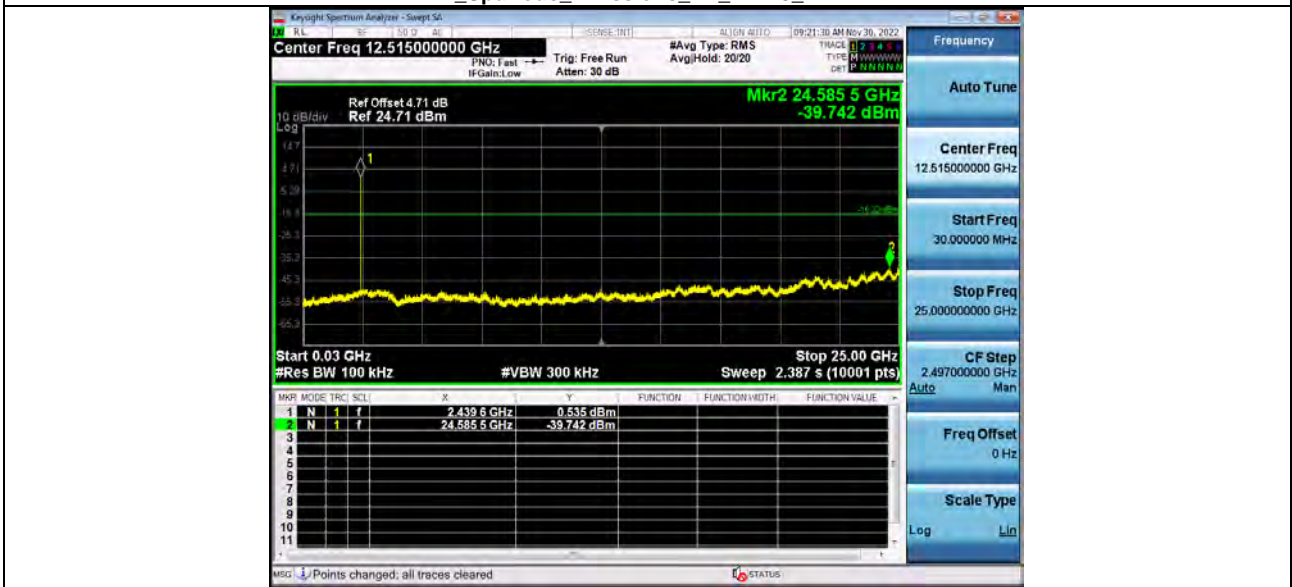

1_Reference Level_BT_2-DH5_2480



2_Spurious Emissions_BT_2-DH5_2480

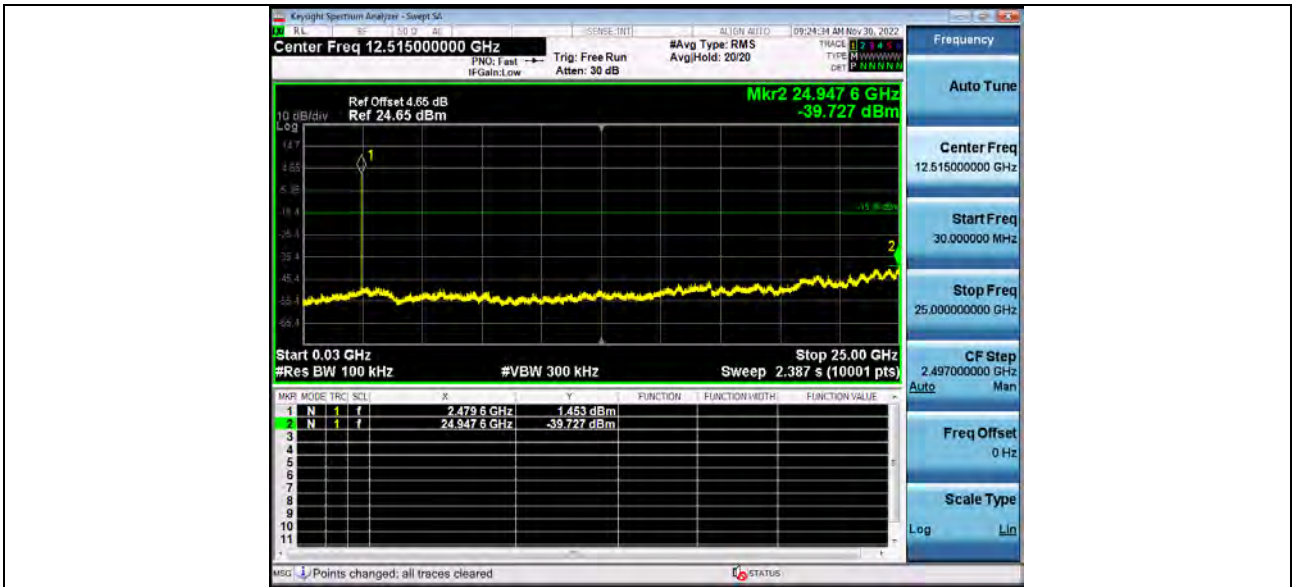

1_Reference Level_BT_3-DH5_2402



2_Spurious Emissions_BT_3-DH5_2402

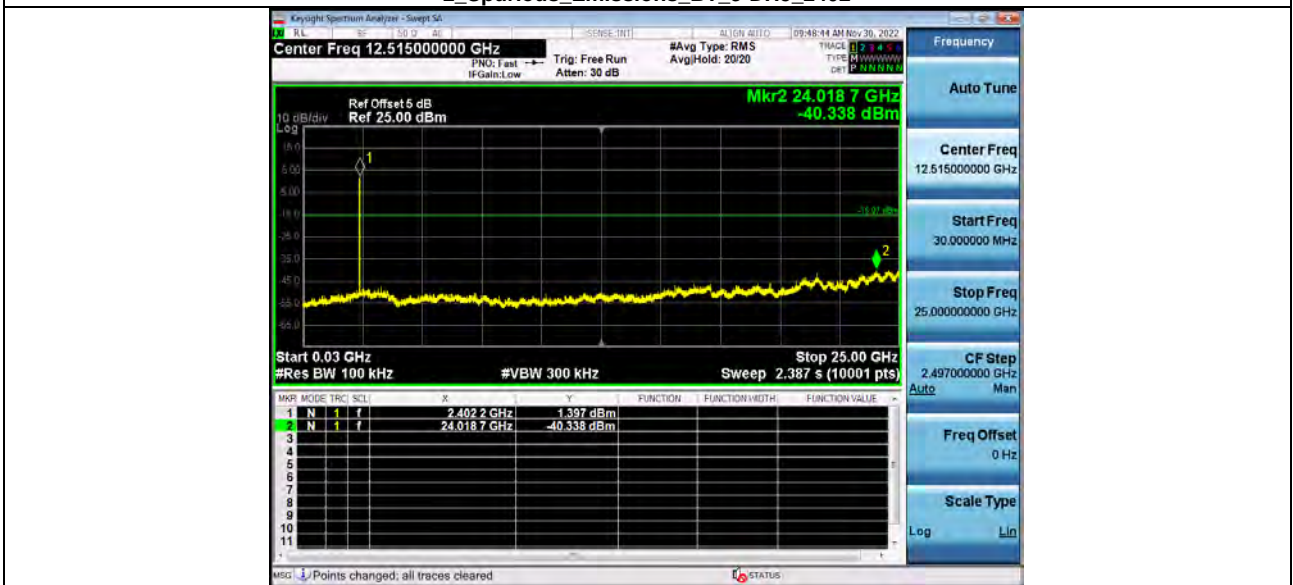

1_Reference Level_BT_3-DH5_2441



2_Spurious_Emissions_BT_3-DH5_2441



1_Reference_Level_BT_3-DH5_2480



2_Spurious_Emissions_BT_3-DH5_2480

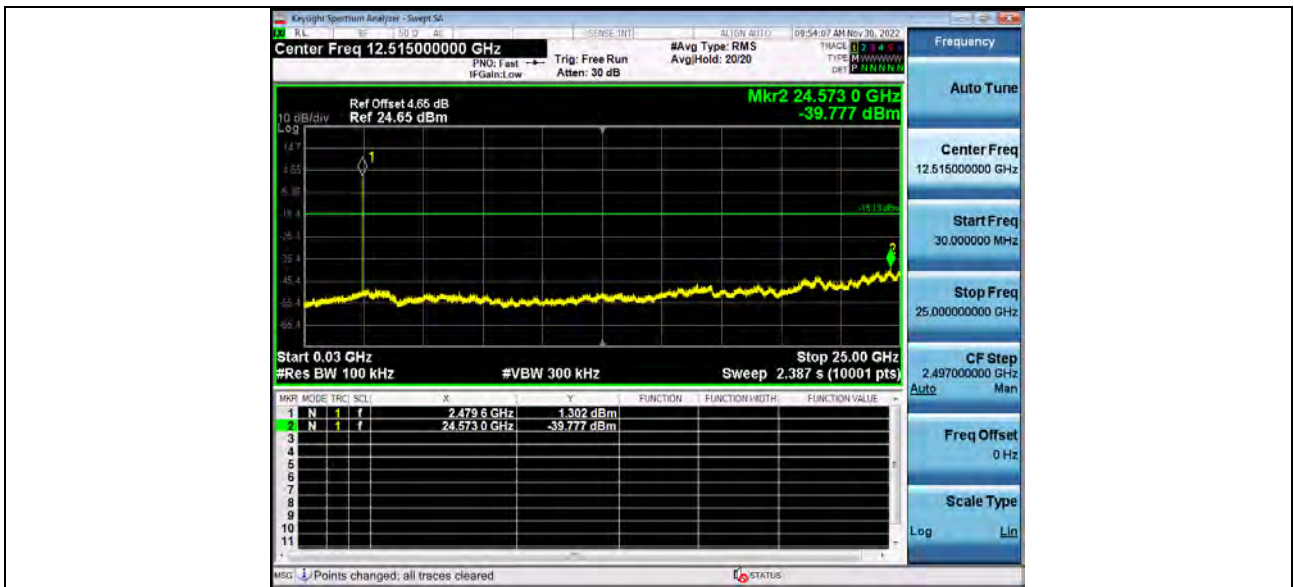

13.4 Bandedge

1_Reference_Level_BT_1-DH5_2402

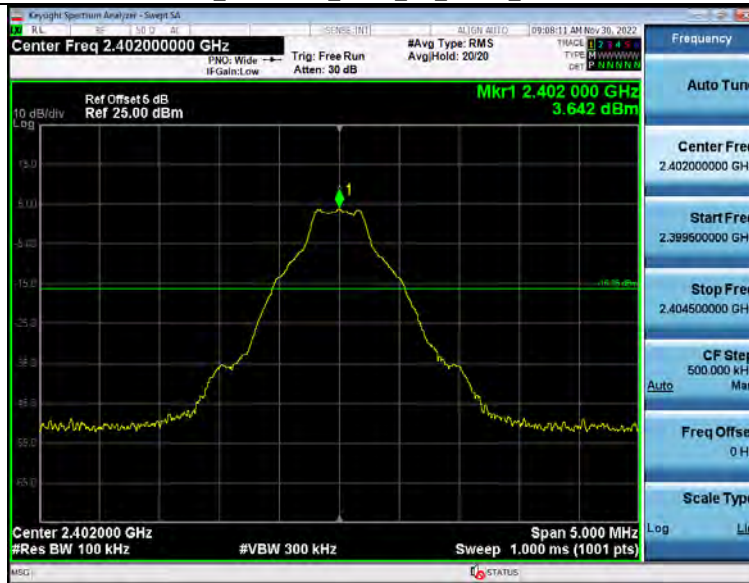

2_Bandedge_BT_1-DH5_2402

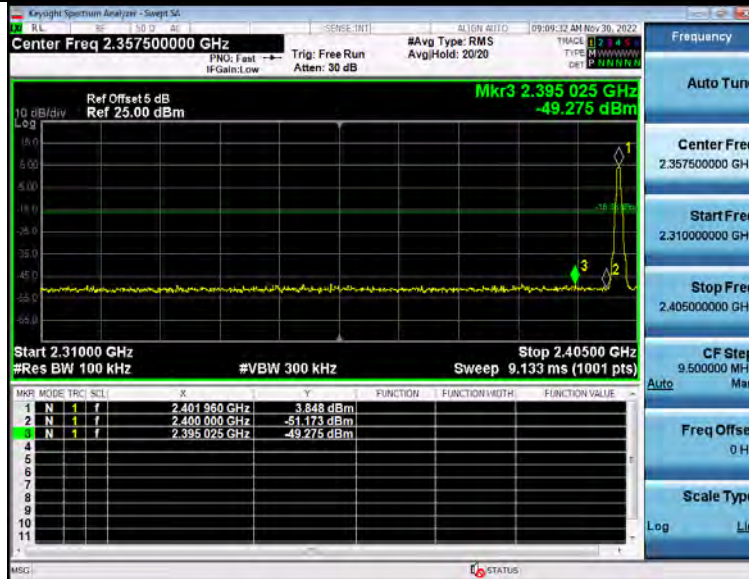

1_Reference_Level_BT_1-DH5_Hopping

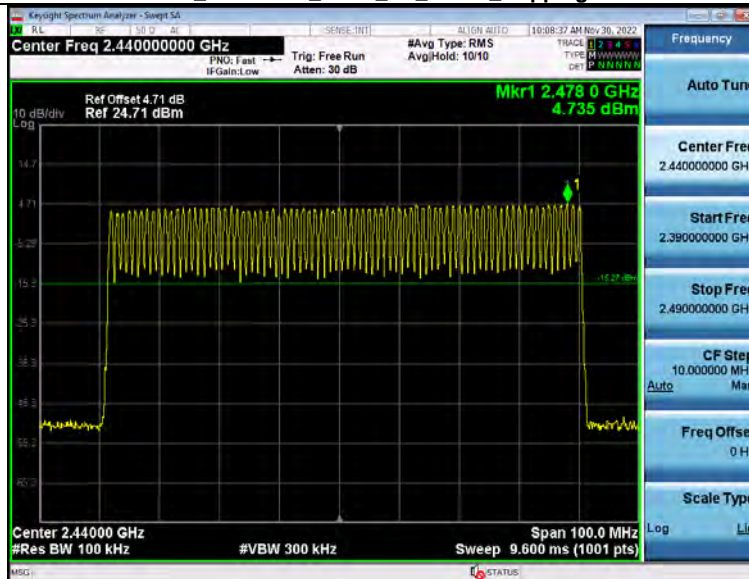

2_Band_Edge_(Hopping)_BT_1-DH5_Hopping

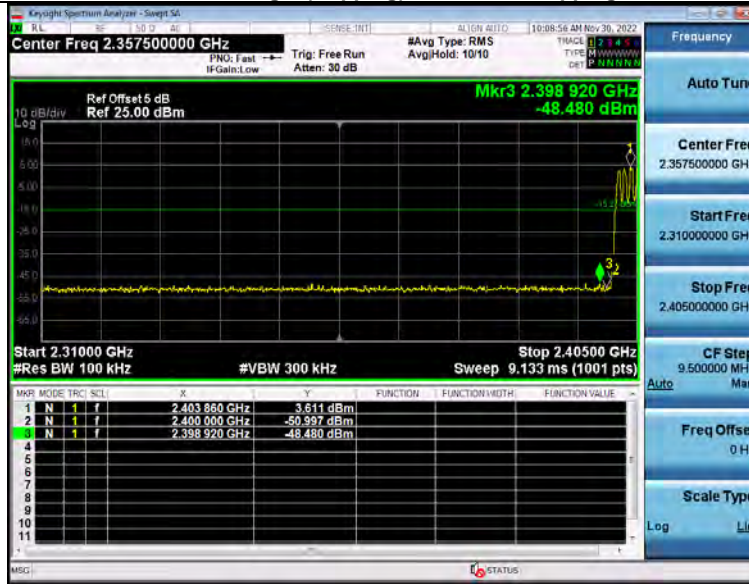

1_Reference_Level_BT_1-DH5_2480



2_Bandedge_BT_1-DH5_2480

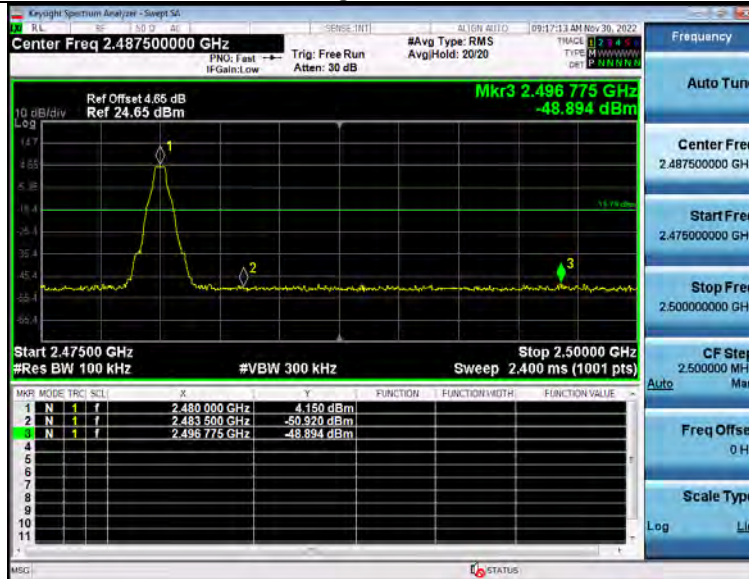

1_Reference_Level_BT_1-DH5_Hopping

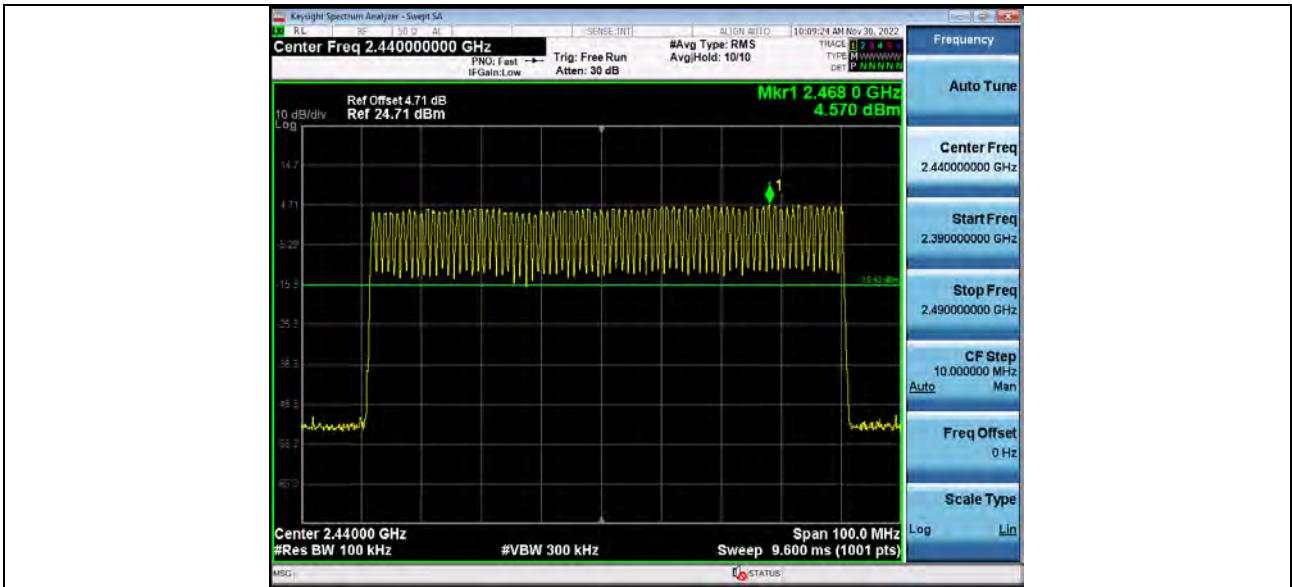

2_Band_Edge_(Hopping)_BT_1-DH5_Hopping

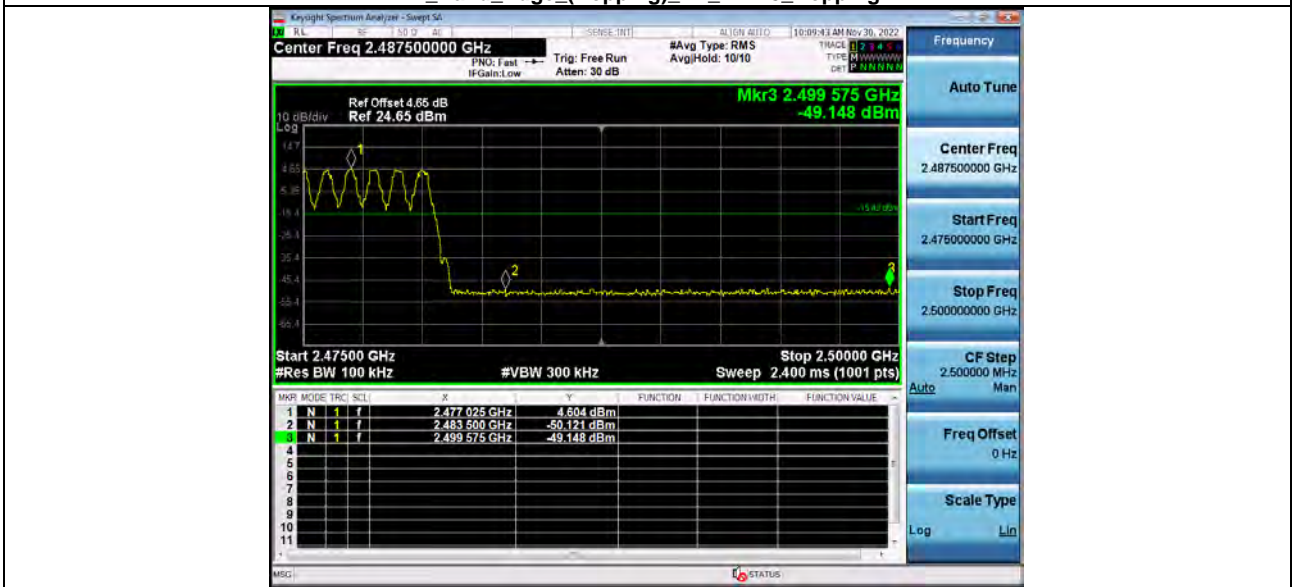

1_Reference_Level_BT_2-DH5_2402

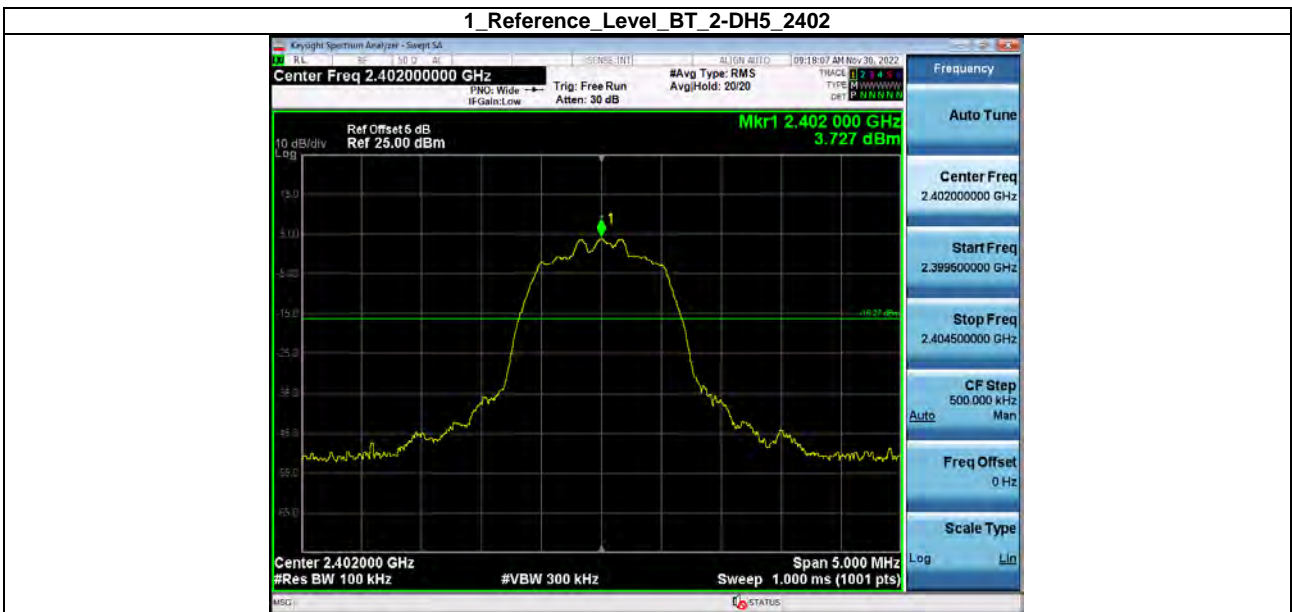

2_Bandedge_BT_2-DH5_2402

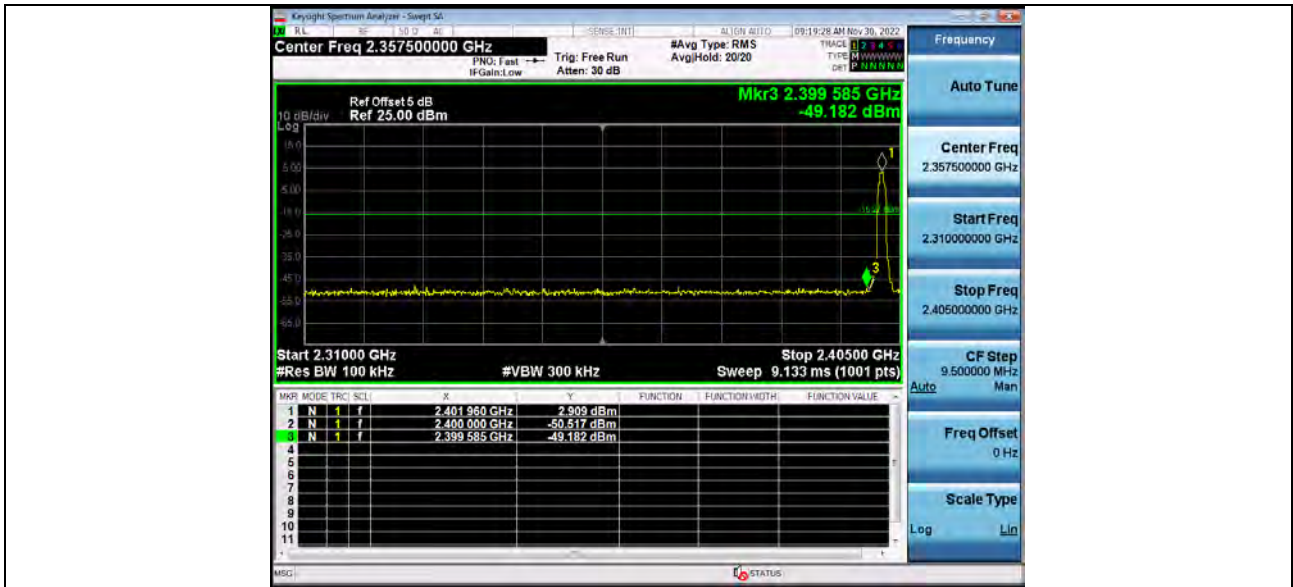

1_Reference_Level_BT_2-DH5_Hopping

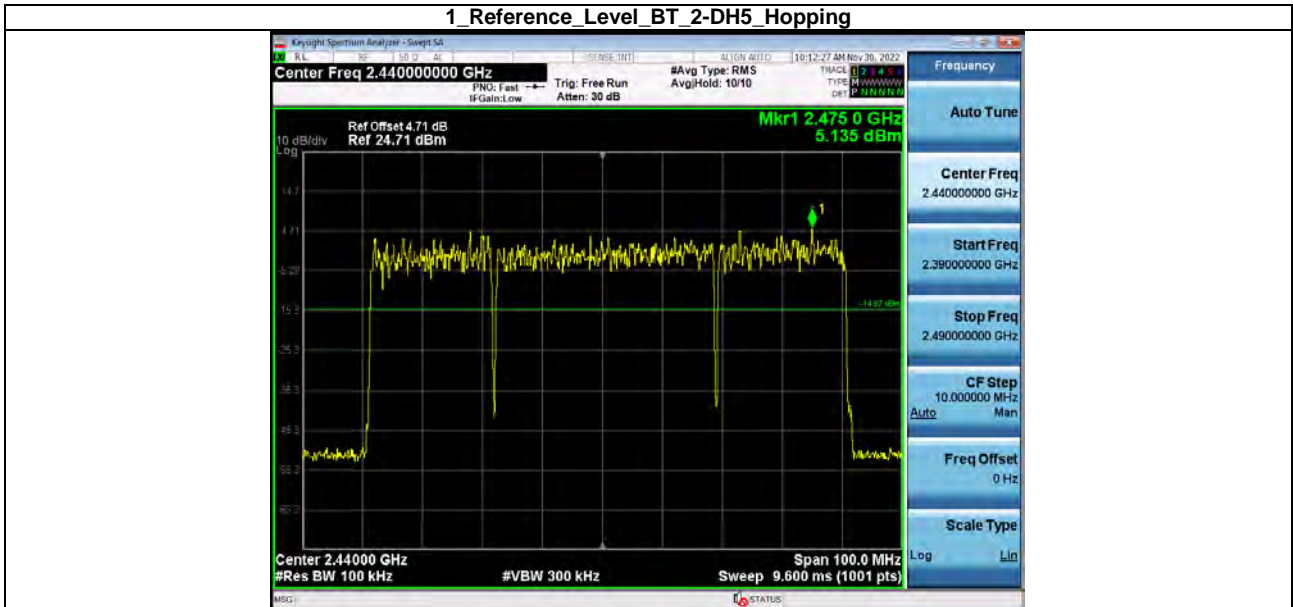

2_Band_Edge_(Hopping)_BT_2-DH5_Hopping



1_Reference_Level_BT_2-DH5_2480



2_Bandedge_BT_2-DH5_2480

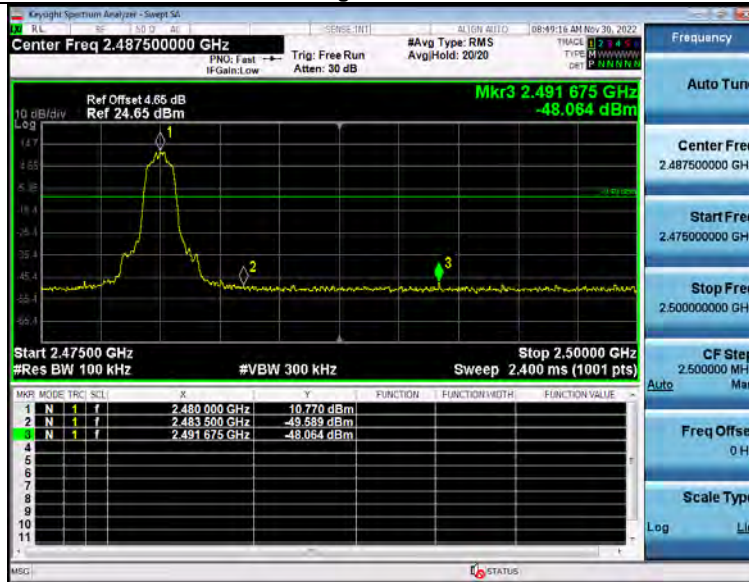

1_Reference_Level_BT_2-DH5_Hopping

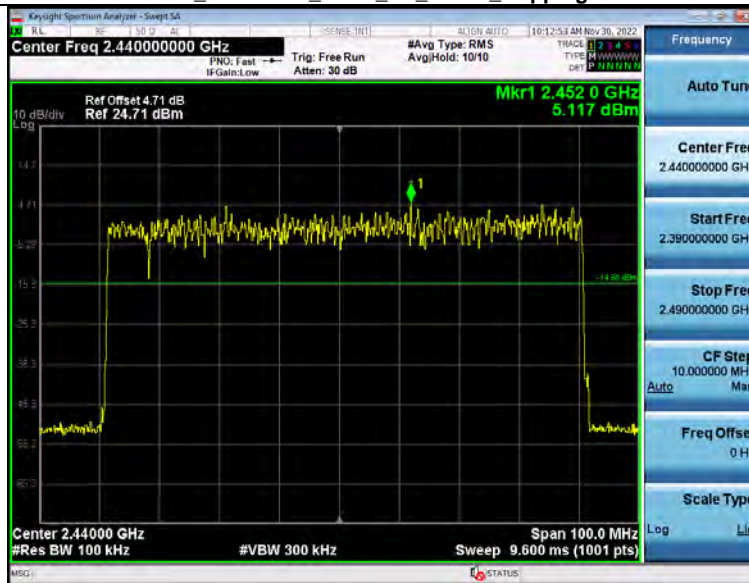

2_Band_Edge_(Hopping)_BT_2-DH5_Hopping



1_Reference_Level_BT_3-DH5_2402



2_Bandedge_BT_3-DH5_2402

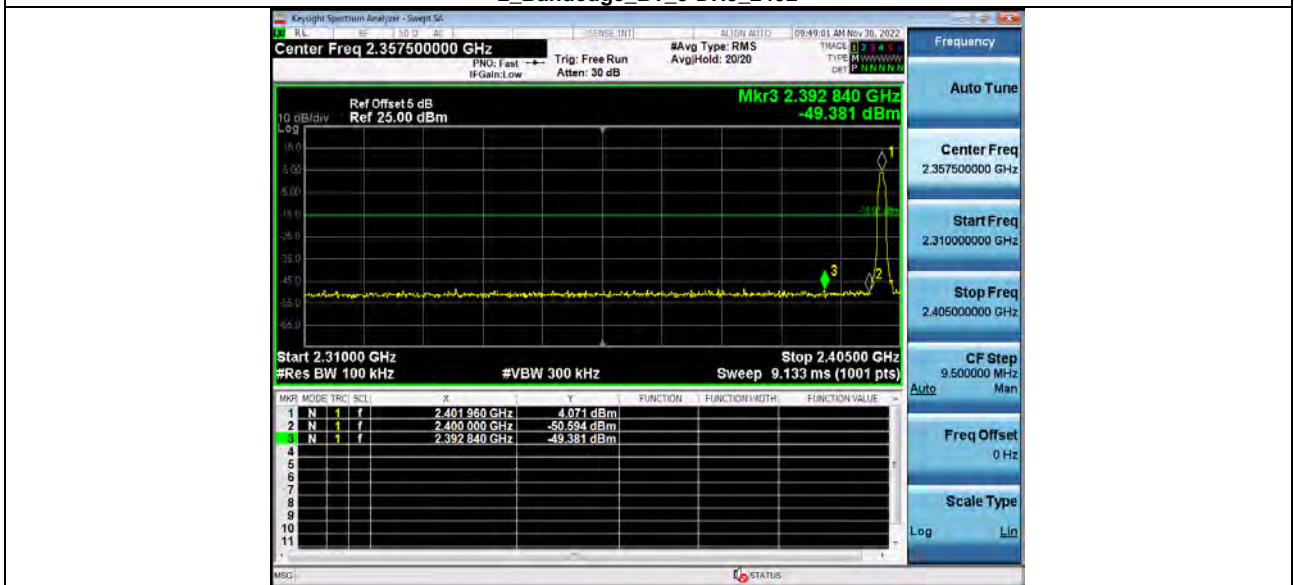

1_Reference_Level_BT_3-DH5_Hopping

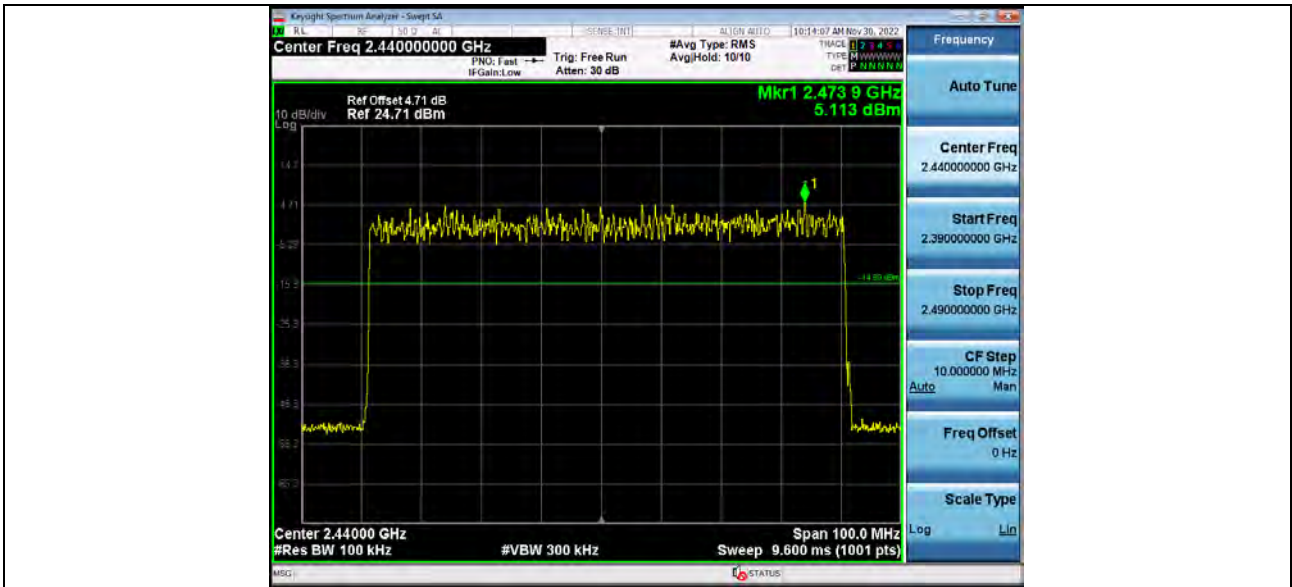

2_Band_Edge_(Hopping)_BT_3-DH5_Hopping

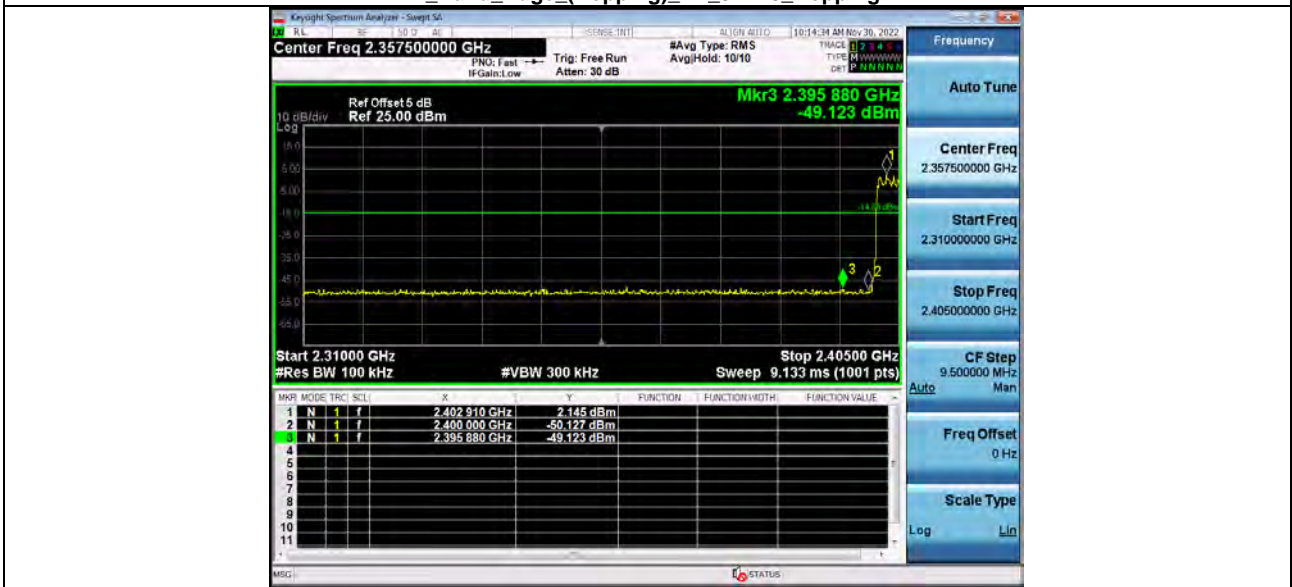

1_Reference_Level_BT_3-DH5_2480



2_Bandedge_BT_3-DH5_2480

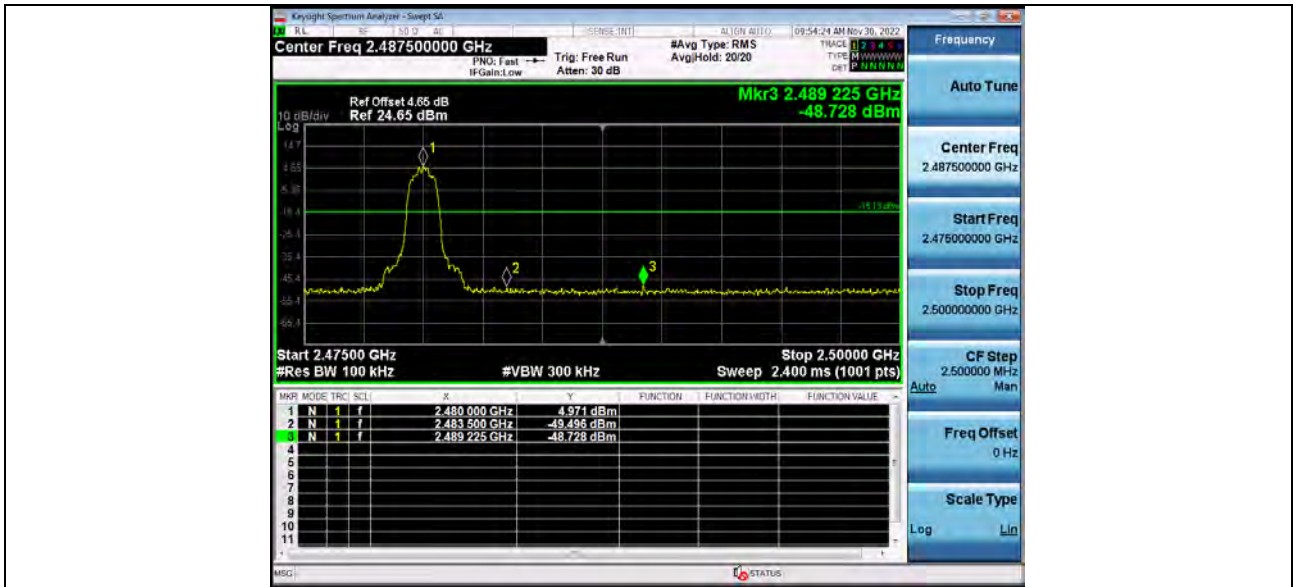

1_Reference_Level_BT_3-DH5_Hopping

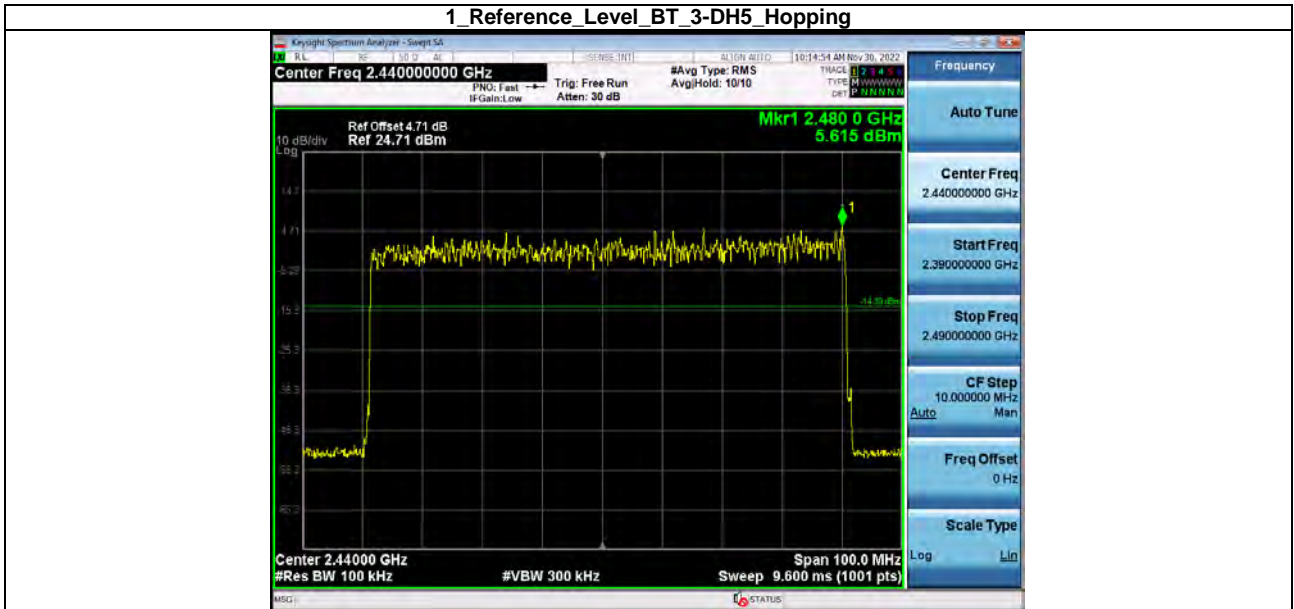

2_Band_Edge_(Hopping)_BT_3-DH5_Hopping



13.5 Carrier Frequencies Separation (Hopping)

Condition	Antenna	Modulation	Frequency(MHz)	Carrier Frequencies Separation(MHz)	Limit(MHz)	Result
NVNT	ANT1	1-DH5	2402.00	1.16	0.639	Pass
NVNT	ANT1	2-DH5	2402.00	0.86	0.850	Pass
NVNT	ANT1	3-DH5	2402.00	1.01	0.863	Pass



Carrier_Frequencies_Separation_(Hopping)_BT_3-DH5_Hopping



13.6 Number of Hopping Channel (Hopping)

Condition	Antenna	Modulation	Hopping Num	Limit	Result
NVNT	ANT1	1-DH5	79	15	Pass
NVNT	ANT1	2-DH5	79	15	Pass
NVNT	ANT1	3-DH5	79	15	Pass

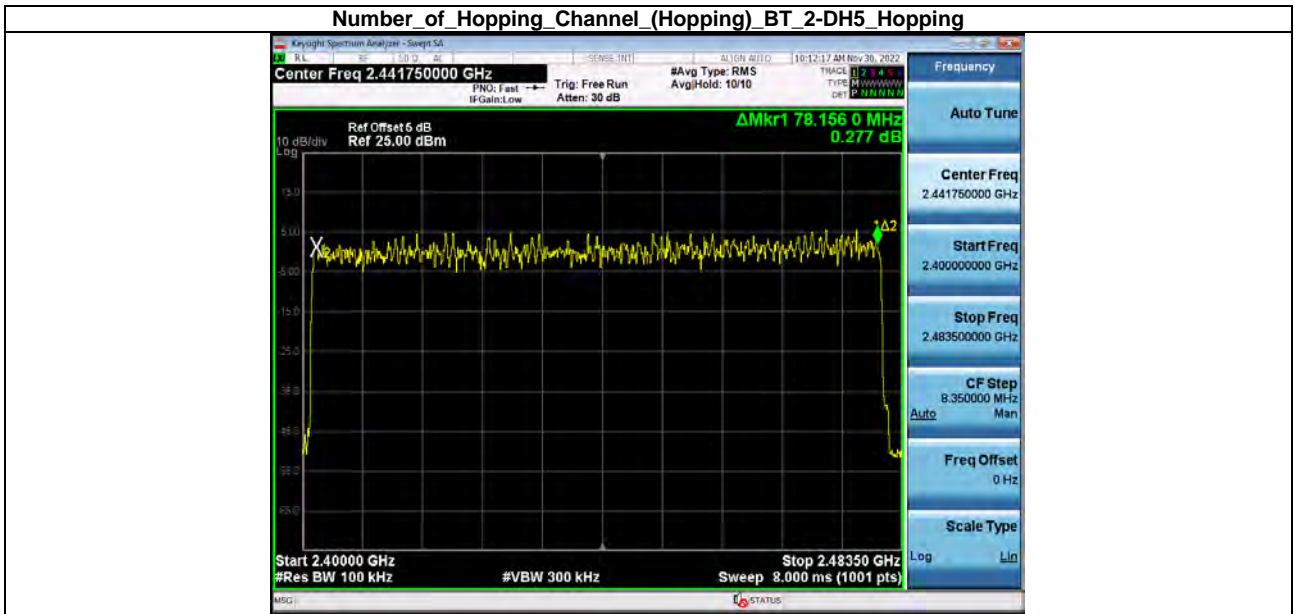
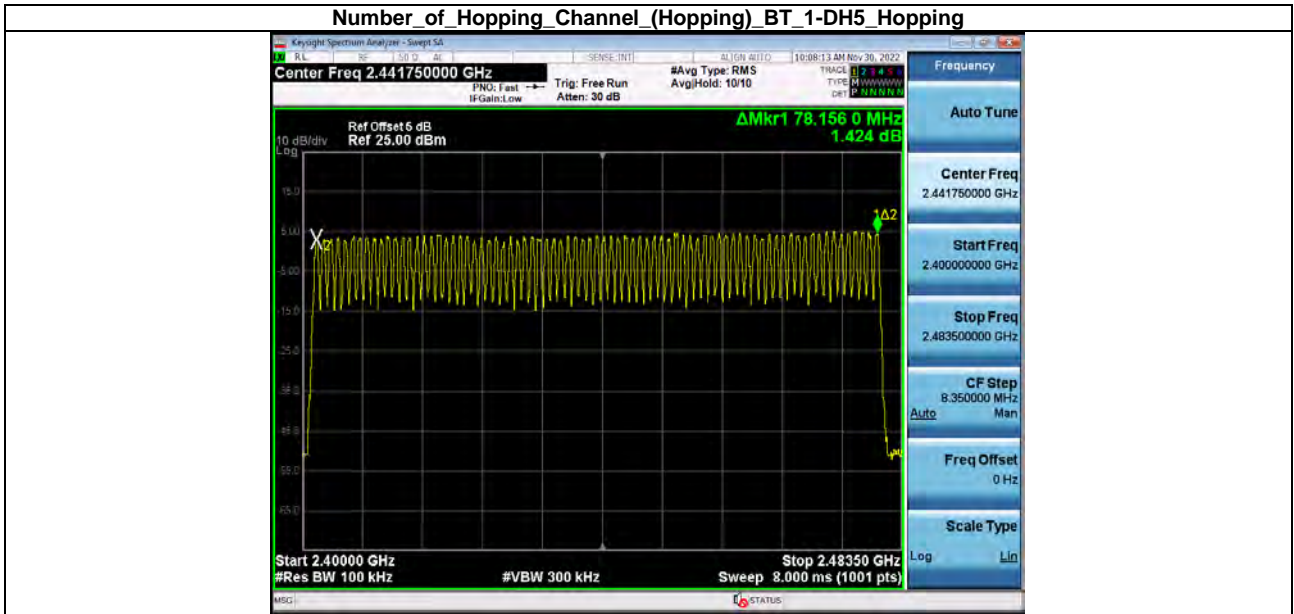

Number_of_Hopping_Channel_(Hopping)_BT_3-DH5_Hopping

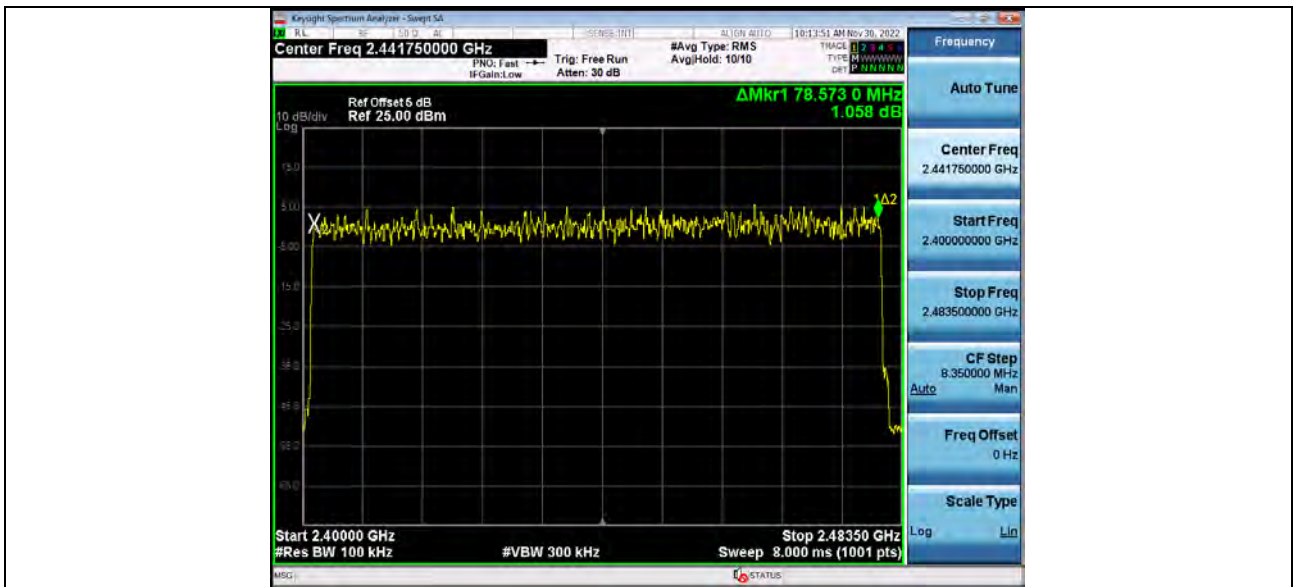

13.7 Dwell Time (Hopping)

Condition	Antenna	Packet Type	Pulse Time(ms)	Limit(s)	Result
NVNT	ANT1	1-DH5	2.885	0.40	Pass
NVNT	ANT1	1-DH3	1.637	0.40	Pass
NVNT	ANT1	1-DH1	0.381	0.40	Pass

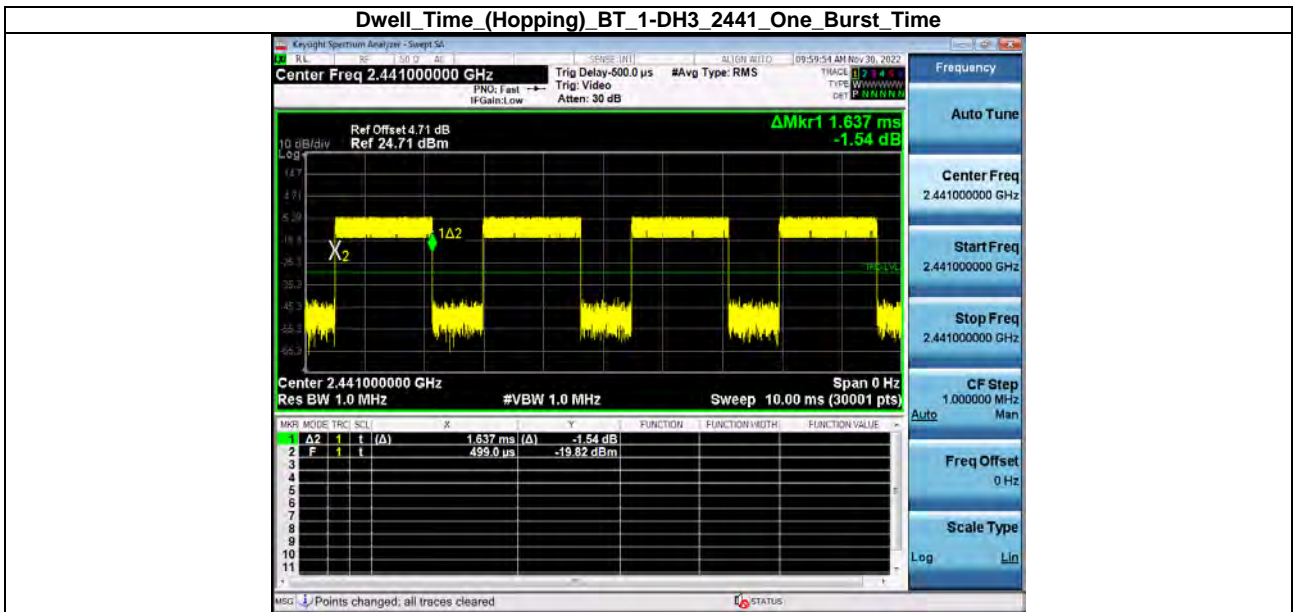
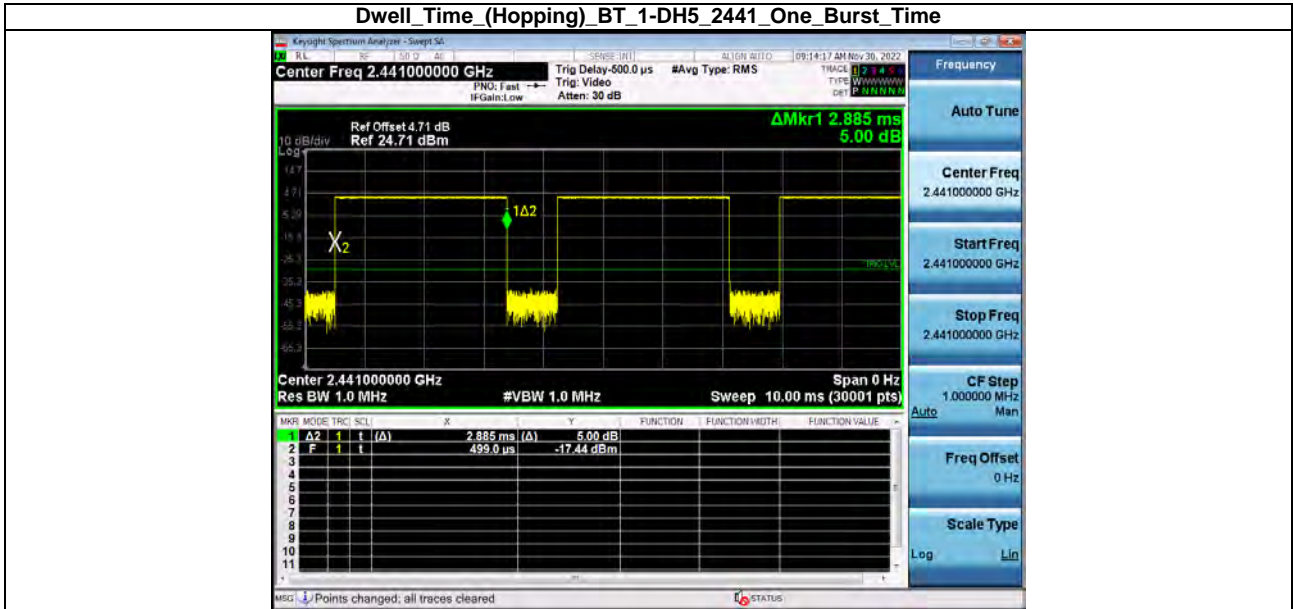

Dwell Time (Hopping) BT 1-DH1 2441 One Burst Time

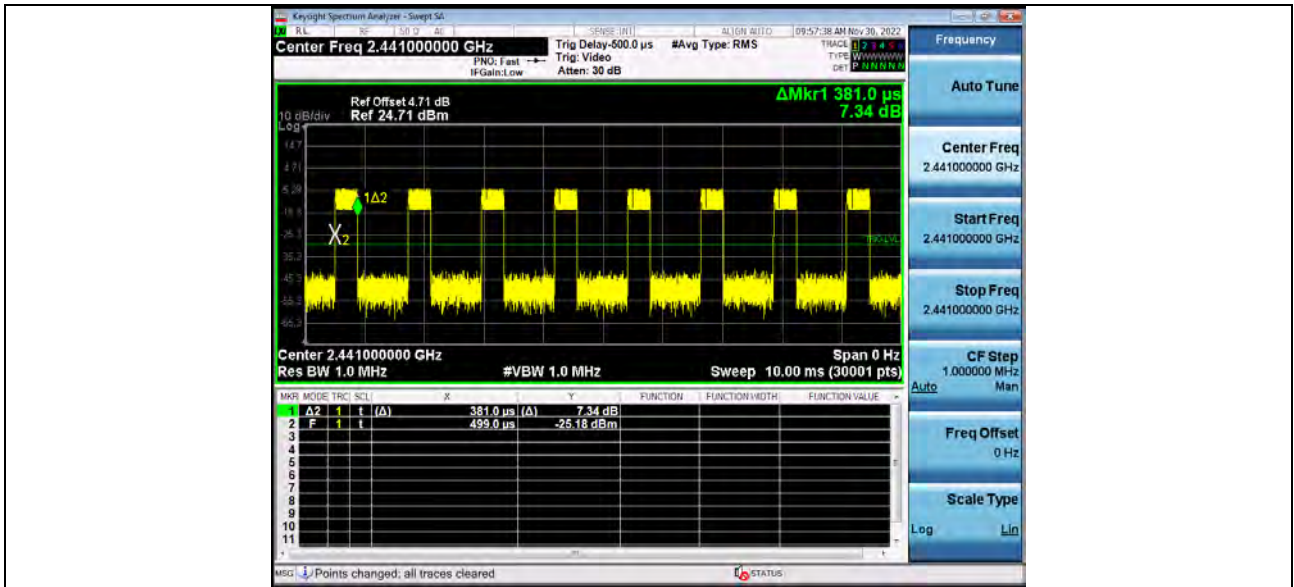

14. Test Setup Photo



15. EUT Constructional Details

external photos







internal photos

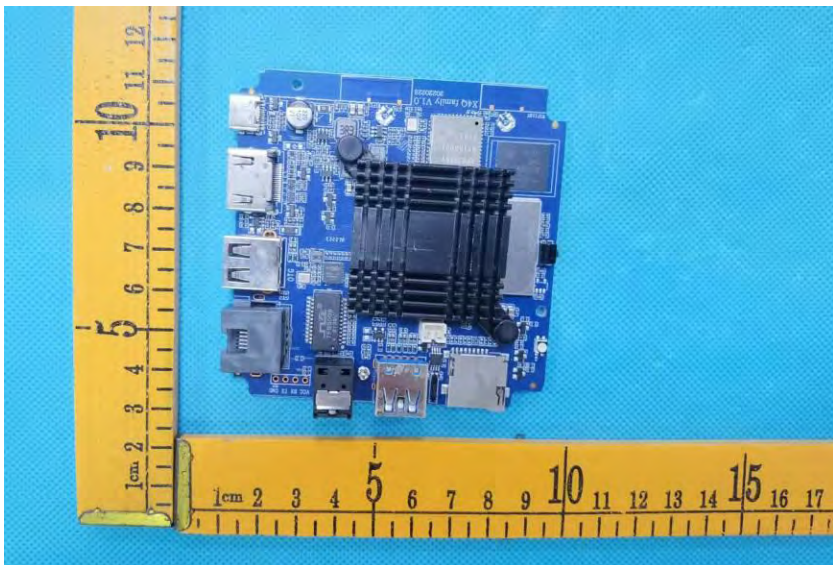
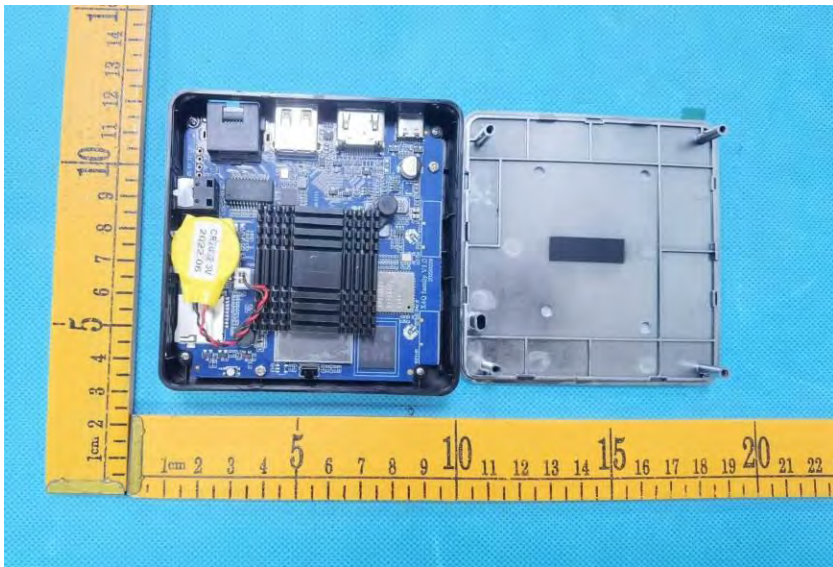

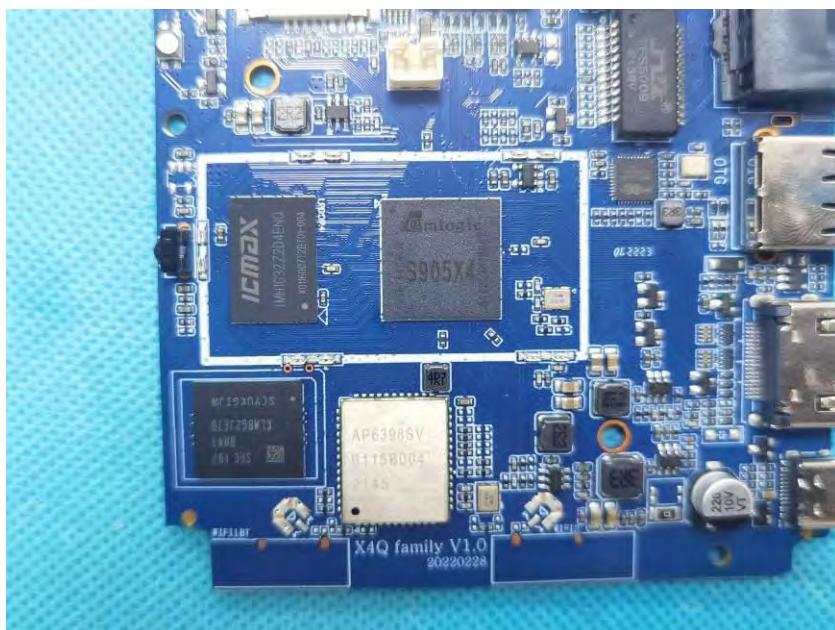
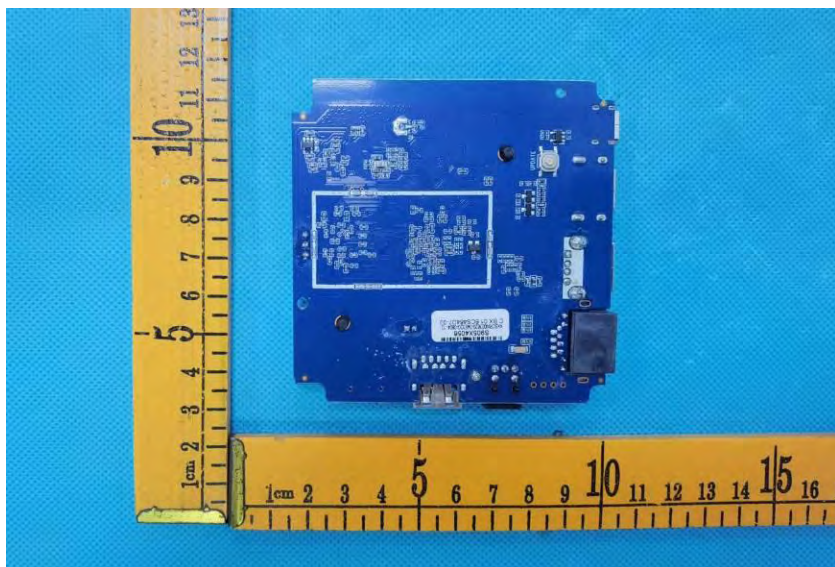
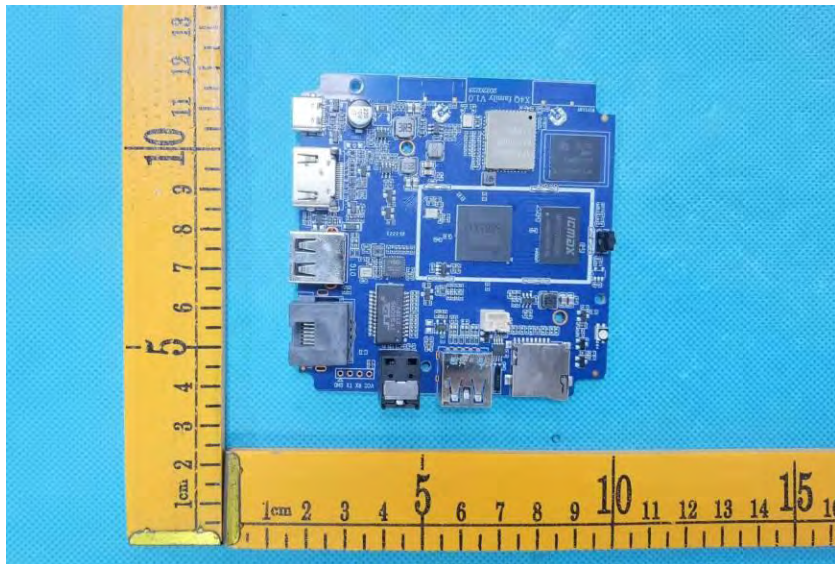

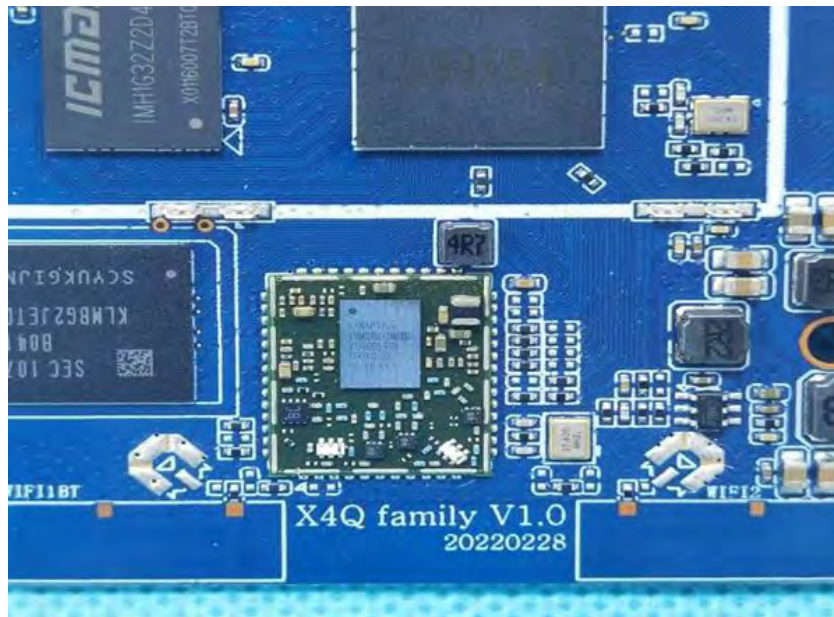

***** END OF REPORT *****