



# FCC TEST REPORT

**Test report  
On Behalf of  
Ugoos Industrial Co.,Ltd  
For  
Android TV Box  
Model No.: AM6, AM6 PRO, AM6 PLUS**

**FCC ID: 2AL8Y-AM6XX**

**Prepared for :** Ugoos Industrial Co.,Ltd  
Room 6A, Building A, Bao'an Plaza, Sun'gang Road, Luohu  
District, Shenzhen

**Prepared By :** Shenzhen HUAKE Testing Technology Co., Ltd.  
1F, B2 Building, Junfeng Zhongcheng Zhizao Innovation Park,  
Fuhai Street, Bao'an District, Shenzhen City, China

**Date of Test:** Oct. 11, 2019 ~ Oct. 21, 2019

**Date of Report:** Oct. 21, 2019

**Report Number:** HK1910152577-E



### TEST RESULT CERTIFICATION

**Applicant's name** .....: Ugoos industrial co.,ltd  
**Address**.....: Room 6A, Building A, Bao'an Plaza, Sun'gang Road, Luohu District, Shenzhen  
**Manufacture's Name** .....: Ugoos industrial co.,ltd  
**Address**.....: Room 6A, Building A, Bao'an Plaza, Sun'gang Road, Luohu District, Shenzhen

**Product description**

**Trade Mark** : Ugoos  
**Product name** .....: Android TV Box  
**Model and/or type reference** .: AM6, AM6 PRO, AM6 PLUS

**Standards** .....: FCC Rules and Regulations Part 15 Subpart C Section 15.247  
 ANSI C63.10: 2013

This publication may be reproduced in whole or in part for non-commercial purposes as long as the Shenzhen HUAK Testing Technology Co., Ltd. is acknowledged as copyright owner and source of the material. Shenzhen HUAK Testing Technology Co., Ltd. takes no responsibility for and will not assume liability for damages resulting from the reader's interpretation of the reproduced material due to its placement and context.

**Date of Test**.....:   
**Date (s) of performance of tests**.....: Oct. 11, 2019 ~ Oct. 21, 2019  
**Date of Issue**.....: Oct. 21, 2019  
**Test Result**.....: **Pass**

Testing Engineer : Gary Qian  
 (Gary Qian)  
 Technical Manager : Eden Hu  
 (Eden Hu)  
 Authorized Signatory : Jason Zhou  
 (Jason Zhou)



## TABLE OF CONTENTS

<b>1. Test Result Summary</b> .....	<b>4</b>
1.1. TEST PROCEDURES AND RESULTS .....	4
1.2. TEST FACILITY .....	4
1.3. Measurement Uncertainty .....	5
<b>2. EUT Description</b> .....	<b>6</b>
2.1. GENERAL DESCRIPTION OF EUT .....	6
2.2. Carrier Frequency of Channels .....	7
2.3. Operation of EUT during testing .....	7
2.4. DESCRIPTION OF TEST SETUP .....	7
<b>3. General Information</b> .....	<b>8</b>
3.1. Test environment and mode .....	8
3.2. Description of Support Units .....	9
<b>4. Test Results and Measurement Data</b> .....	<b>10</b>
4.1. Conducted Emission .....	10
4.2. Maximum Conducted Output Power .....	14
4.3. Emission Bandwidth .....	16
4.4. Power Spectral Density .....	24
4.5. Conducted Band Edge and Spurious Emission Measurement .....	34
4.6. Radiated Spurious Emission Measurement .....	41
4.7. ANTENNA REQUIREMENT .....	67
4.8. PHOTOGRAPH OF TEST .....	68
<b>5. PHOTOS OF THE EUT</b> .....	<b>70</b>



# 1. Test Result Summary

## 1.1. TEST PROCEDURES AND RESULTS

Requirement	CFR 47 Section	Result
Antenna requirement	§15.203/§15.247 (c)	PASS
AC Power Line Conducted Emission	§15.207	PASS
Conducted Peak Output Power	§15.247 (b)(3)	PASS
6dB Emission Bandwidth	§15.247 (a)(2)	PASS
Power Spectral Density	§15.247 (e)	PASS
Band Edge	§15.247(d)	PASS
Spurious Emission	§15.205/§15.209	PASS

**Note:**

1. PASS: Test item meets the requirement.
2. Fail: Test item does not meet the requirement.
3. N/A: Test case does not apply to the test object.
4. The test result judgment is decided by the limit of test standard.

## 1.2. TEST FACILITY

Test Firm : Shenzhen HUAKE Testing Technology Co., Ltd.

Address : 1F, B2 Building, Junfeng Zhongcheng Zhizao Innovation Park, Fuhai Street, Bao'an District, Shenzhen City, China



### 1.3. Measurement Uncertainty

The reported uncertainty of measurement  $y \pm U$ , where expanded uncertainty  $U$  is based on a standard uncertainty multiplied by a coverage factor of  $k=2$ , providing a level of confidence of approximately 95 %.

No.	Item	MU
1	Conducted Emission	$\pm 2.56\text{dB}$
2	RF power, conducted	$\pm 0.12\text{dB}$
3	Spurious emissions, conducted	$\pm 0.11\text{dB}$
4	All emissions, radiated(<1G)	$\pm 3.92\text{dB}$
5	All emissions, radiated(>1G)	$\pm 4.28\text{dB}$
6	Temperature	$\pm 0.1^\circ\text{C}$
7	Humidity	$\pm 1.0\%$



## 2. EUT Description

### GENERAL DESCRIPTION OF EUT

Equipment	Android TV Box
Model Name	AM6
Serial No.	AM6 PRO, AM6 PLUS
Model Difference	All model's the function, software and electric circuit are the same, only with a product color and model named different. Test sample model: AM6
Trade Mark	Ugoos
FCC ID	2AL8Y-AM6XX
Hardware Version:	V1.1
Software Version:	V5.3
Operation frequency	802.11b/g/n 20: 2412~2462 MHz 802.11n 40: 2422~2452MHz
Number of Channels	802.11b/g/n20: 11CH 802.11n 40: 7CH
Antenna Type	Glue stick Antenna
Antenna Gain	2dBi
Modulation Type	CCK/DSSS/OFDM
Power Source	DC 5.0V from adapter



## 2.1. Carrier Frequency of Channels

Channel List for 802.11b/802.11g/802.11n (HT20)							
Channel	Frequency (MHz)	Channel	Frequency (MHz)	Channel	Frequency (MHz)	Channel	Frequency (MHz)
01	2412	04	2427	07	2442	10	2457
02	2417	05	2432	08	2447	11	2462
03	2422	06	2437	09	2452		

Channel List For 802.11n (HT40)							
Channel	Frequency (MHz)	Channel	Frequency (MHz)	Channel	Frequency (MHz)	Channel	Frequency (MHz)
--	--	04	2427	07	2442	--	--
--	--	05	2432	08	2447	--	--
03	2422	06	2437	09	2452		

Note: In section 15.31(m), regards to the operating frequency range over 10 MHz, the Lowest frequency, the middle frequency, and the highest frequency of channel were selected to perform the test, and the selected channel see below.

## 2.2. Operation of EUT during testing

Operating Mode

The mode is used: **Transmitting mode for 802.11b/802.11g/802.11n (HT20)**

Low Channel: 2412MHz

Middle Channel: 2437MHz

High Channel: 2462MHz

The mode is used: **Transmitting mode for 802.11n (HT40)**

Low Channel: 2422MHz

Middle Channel: 2437MHz

High Channel: 2452MHz

## 2.3. DESCRIPTION OF TEST SETUP

Operation of EUT during conducted and Radiation testing and Above1GHz Radiation testing:



Operation of EUT during Radiation and Above1GHz Radiation testing:





### 3. Genera Information

#### 3.1. Test environment and mode

Operating Environment:	
Temperature:	25.0 °C
Humidity:	56 % RH
Atmospheric Pressure:	1010 mbar
Test Mode:	
Engineering mode:	Keep the EUT in continuous transmitting by select channel and modulations(The value of duty cycle is 98.46%)
<p>The sample was placed (0.8m below 1GHz, 1.5m above 1GHz) above the ground plane of 3m chamber. Measurements in both horizontal and vertical polarities were performed. During the test, each emission was maximized by: having the EUT continuously working, investigated all operating modes, rotated about all 3 axis (X, Y &amp; Z) and considered typical configuration to obtain worst position, manipulating interconnecting cables, rotating the turntable, varying antenna height from 1m to 4m in both horizontal and vertical polarizations. The emissions worst-case are shown in Test Results of the following pages. For the full battery state and The output power to the maximum state.</p>	

<p>We have verified the construction and function in typical operation. All the test modes were carried out with the EUT in transmitting operation, which was shown in this test report and defined as follows:</p>	
<p><b>Per-scan all kind of data rate in lowest channel, and found the follow list which it was worst case.</b></p>	
Mode	Data rate
802.11b	1Mbps
802.11g	6Mbps
802.11n(H20)	MCS0
802.11n(H40)	MCS7
Final Test Mode:	
Operation mode:	Keep the EUT in continuous transmitting with modulation
<p>1. For WIFI function, the engineering test program was provided and enabled to make EUT continuous transmit/receive.</p> <p>2. According to ANSI C63.10 standards, the test results are both the “worst case” and “worst setup” 1Mbps for 802.11b, 6Mbps for 802.11g, MCS0 for 802.11n(H20), MCS7 for 802.11(H40). Duty cycle setting during the transmission is 98.5% with maximum power setting for all modulations.</p>	





### 3.2. Description of Support Units

The EUT has been tested as an independent unit together with other necessary accessories or support units. The following support units or accessories were used to form a representative test configuration during the tests.

Description	Model No.	Manufacturer	Remark	Certificate
Switching Adapter	R241-1202000U	SHENZHEN Rongweixin Technology Co.,Ltd	/	SDOC
LCD Color Monitor	V202b	HP	Provide by lab	SDOC
USB cable	/	SHENZHEN TIANYIN ELECTRONICS CO.,LTD.	/	SDOC
HDMI cable	/	SHENZHEN TIANYIN ELECTRONICS CO.,LTD.	/	SDOC

**Note:**

1. All the equipment/cables were placed in the worst-case configuration to maximize the emission during the test.
2. Grounding was established in accordance with the manufacturer's requirements and conditions for the intended use.
3. For conducted measurements (Output Power, 6dB Emission Bandwidth, Power Spectral Density, Spurious Emissions), the antenna of EUT is connected to the test equipment via temporary antenna connector, the antenna connector is soldered on the antenna port of EUT, and the temporary antenna connector is listed in the Test Instruments.



## 4. Test Results and Measurement Data

### 4.1. Conducted Emission

#### Test Specification

<b>Test Requirement:</b>	FCC Part15 C Section 15.207														
<b>Test Method:</b>	ANSI C63.10:2013														
<b>Frequency Range:</b>	150 kHz to 30 MHz														
<b>Receiver setup:</b>	RBW=9 kHz, VBW=30 kHz, Sweep time=auto														
<b>Limits:</b>	<table border="1"> <thead> <tr> <th rowspan="2">Frequency range (MHz)</th> <th colspan="2">Limit (dBuV)</th> </tr> <tr> <th>Quasi-peak</th> <th>Average</th> </tr> </thead> <tbody> <tr> <td>0.15-0.5</td> <td>66 to 56*</td> <td>56 to 46*</td> </tr> <tr> <td>0.5-5</td> <td>56</td> <td>46</td> </tr> <tr> <td>5-30</td> <td>60</td> <td>50</td> </tr> </tbody> </table>	Frequency range (MHz)	Limit (dBuV)		Quasi-peak	Average	0.15-0.5	66 to 56*	56 to 46*	0.5-5	56	46	5-30	60	50
Frequency range (MHz)	Limit (dBuV)														
	Quasi-peak	Average													
0.15-0.5	66 to 56*	56 to 46*													
0.5-5	56	46													
5-30	60	50													
<b>Test Setup:</b>	<p><i>Remark: E.U.T: Equipment Under Test LISN: Line Impedance Stabilization Network Test table height=0.8m</i></p>														
<b>Test Mode:</b>	Charging + transmitting with modulation														
<b>Test Procedure:</b>	<ol style="list-style-type: none"> <li>1. The E.U.T is connected to the main power through a line impedance stabilization network (L.I.S.N.). This provides a 50ohm/50uH coupling impedance for the measuring equipment.</li> <li>2. The peripheral devices are also connected to the main power through a LISN that provides a 50ohm/50uH coupling impedance with 50ohm termination. (Please refer to the block diagram of the test setup and photographs).</li> <li>3. Both sides of A.C. line are checked for maximum conducted interference. In order to find the maximum emission, the relative positions of equipment and all of the interface cables must be changed according to ANSI C63.10: 2013 on conducted measurement.</li> </ol>														
<b>Test Result:</b>	PASS														

**Test Instruments**

<b>Conducted Emission Shielding Room Test Site (843)</b>				
<b>Equipment</b>	<b>Manufacturer</b>	<b>Model</b>	<b>Serial Number</b>	<b>Calibration Due</b>
Receiver	R&S	ESCI 7	HKE-010	Dec. 27, 2019
LISN	R&S	ENV216	HKE-002	Dec. 27, 2019
Conducted test software	Tonscend	TS+ Rev 2.5.0.0	HKE-081	N/A

**Note:** The calibration interval of the above test instruments is 12 months and the calibrations are traceable to international system unit (SI).



### Test data

**Note :**

All the test modes completed for test. only the worst result of AC 120V/60Hz(802.11b at 2412MHz) was reported as below:

**Conducted Emission on Line Terminal of the power line (150 kHz to 30MHz)**

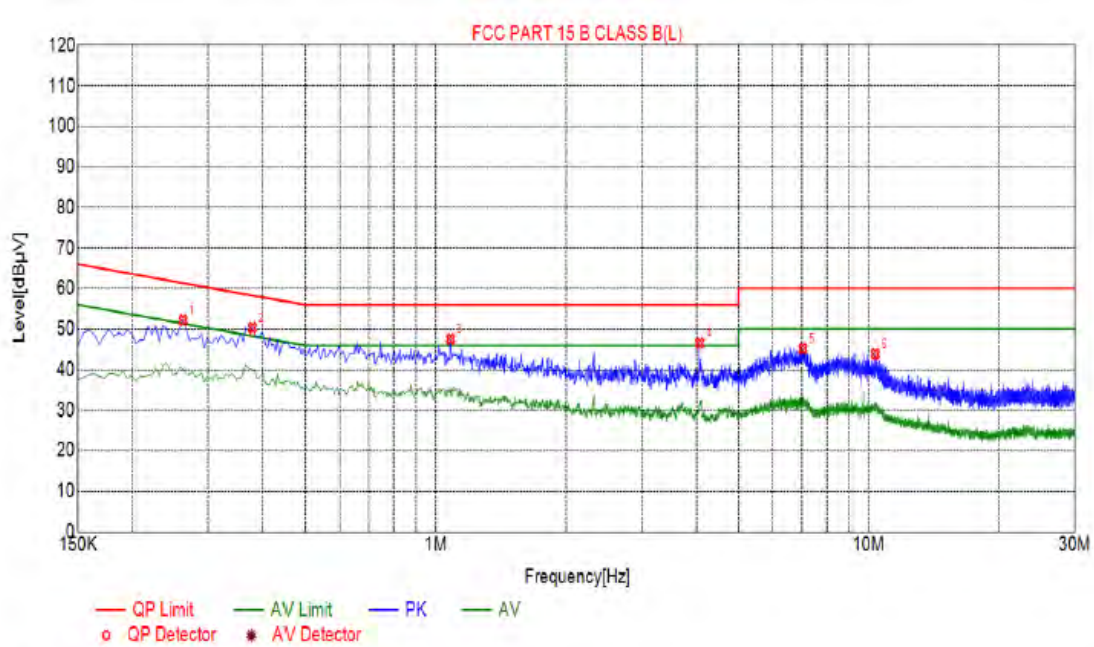

Suspected List						
NO.	Freq. [MHz]	Level [dBµV]	Factor [dB]	Limit [dBµV]	Margin [dB]	Detector
1	0.2625	52.24	10.03	61.35	9.11	PK
2	0.3795	50.32	10.05	58.29	7.97	PK
3	1.0815	47.59	10.07	56.00	8.41	PK
4	4.0740	46.58	10.25	56.00	9.42	PK
5	7.0530	45.24	10.20	60.00	14.76	PK
6	10.3605	43.88	10.05	60.00	16.12	PK

Remark: Margin = Limit – Level  
 Correction factor = Cable lose + LISN insertion loss  
 Level=Test receiver reading + correction factor



**Conducted Emission on Neutral Terminal of the power line (150 kHz to 30MHz)**

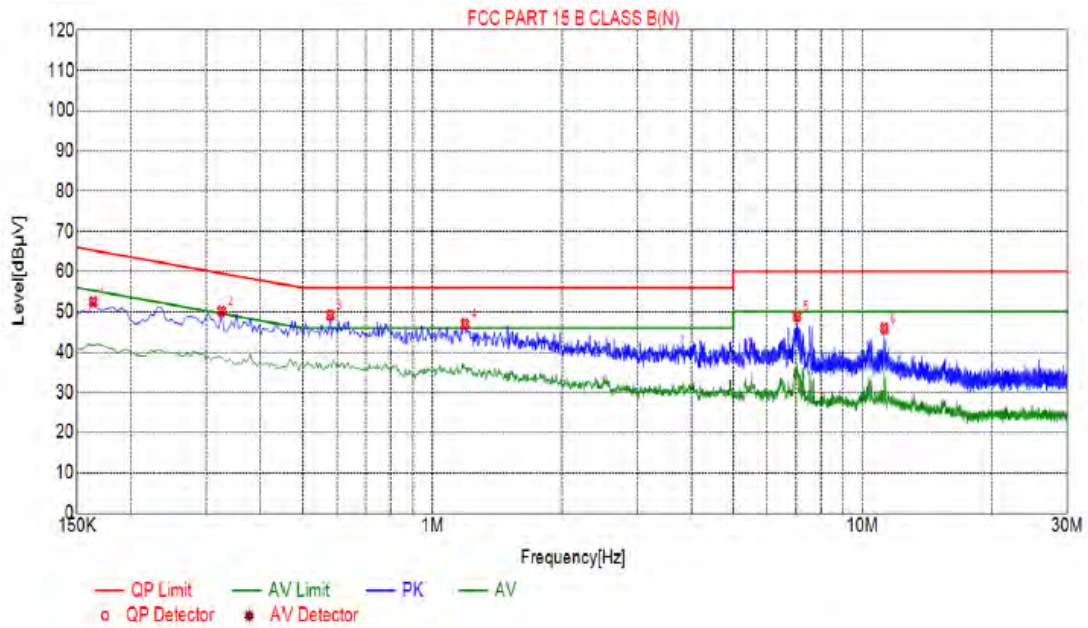

Suspected List						
NO.	Freq. [MHz]	Level [dBµV]	Factor [dB]	Limit [dBµV]	Margin [dB]	Detector
1	0.1635	52.48	9.98	65.28	12.80	PK
2	0.3255	50.19	10.05	59.57	9.38	PK
3	0.5775	49.23	10.05	56.00	6.77	PK
4	1.1895	47.01	10.09	56.00	8.99	PK
5	7.0485	48.91	10.20	60.00	11.09	PK
6	11.2425	45.91	10.00	60.00	14.09	PK

Remark: Margin = Limit – Level  
 Correction factor = Cable lose + LISN insertion loss  
 Level=Test receiver reading + correction factor



## 4.2. Maximum Conducted Output Power

### Test Specification

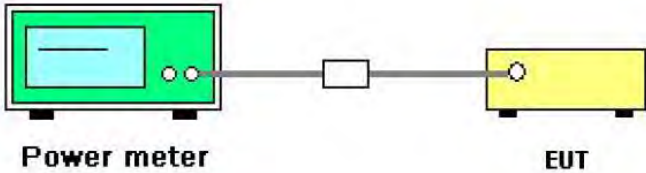
<b>Test Requirement:</b>	FCC Part15 C Section 15.247 (b)(3)
<b>Test Method:</b>	KDB 558074
<b>Limit:</b>	30dBm
<b>Test Setup:</b>	 <p style="text-align: center;"><b>Power meter</b>                      <b>EUT</b></p>
<b>Test Mode:</b>	Transmitting mode with modulation
<b>Test Procedure:</b>	<ol style="list-style-type: none"> <li>1. The testing follows the Measurement Procedure of FCC KDB No. 558074 DTS D01 Meas. Guidance v05.</li> <li>2. The RF output of EUT was connected to the power meter by RF cable and attenuator. The path loss was compensated to the results for each measurement.</li> <li>3. Set to the maximum power setting and enable the EUT transmit continuously.</li> <li>4. Measure the Peak output power and record the results in the test report.</li> </ol>
<b>Test Result:</b>	PASS

### Test Instruments

RF Test Room				
Equipment	Manufacturer	Model	Serial Number	Calibration Due
Power meter	Agilent	E4417B	HKE-107	Dec. 27, 2019
Power Sensor	Agilent	E9327A	HKE-113	Dec. 27, 2019
RF cable	Times	1-40G	HKE-034	Dec. 27, 2019
RF automatic control unit	Tonscend	JS0806-2	HKE-060	Dec. 27, 2019

**Note:** The calibration interval of the above test instruments is 12 months and the calibrations are traceable to international system unit (SI).

**Test Data**

<b>TX 802.11b Mode</b>			
Test Channel	Frequency	Maximum Peak Conducted Output Power	LIMIT
	(MHz)	(dBm)	dBm
CH01	2412	14.35	30
CH06	2437	14.29	30
CH11	2462	14.29	30
<b>TX 802.11g Mode</b>			
CH01	2412	11.48	30
CH06	2437	11.22	30
CH11	2462	11.16	30
<b>TX 802.11n20 Mode</b>			
CH01	2412	10.63	30
CH06	2437	10.28	30
CH11	2462	10.20	30
<b>TX 802.11n40 Mode</b>			
CH03	2422	10.26	30
CH06	2437	9.93	30
CH09	2452	10.12	30



### 4.3. Emission Bandwidth

#### Test Specification

<b>Test Requirement:</b>	FCC Part15 C Section 15.247 (a)(2)
<b>Test Method:</b>	KDB 558074
<b>Limit:</b>	>500kHz
<b>Test Setup:</b>	 <p style="text-align: center;">Spectrum Analyzer                      EUT</p>
<b>Test Mode:</b>	Transmitting mode with modulation
<b>Test Procedure:</b>	<ol style="list-style-type: none"> <li>1. The testing follows FCC KDB Publication No. 558074 DTS D01 Meas. Guidance v05.</li> <li>2. Set to the maximum power setting and enable the EUT transmit continuously.</li> <li>3. Make the measurement with the spectrum analyzer's resolution bandwidth (RBW) = 100 kHz. Set the Video bandwidth (VBW) = 300 kHz. In order to make an accurate measurement. The 6dB bandwidth must be greater than 500 kHz.</li> <li>4. Measure and record the results in the test report.</li> </ol>
<b>Test Result:</b>	PASS

#### Test Instruments

RF Test Room				
Equipment	Manufacturer	Model	Serial Number	Calibration Due
Spectrum analyzer	Agilent	N9020A	HKE-048	Dec. 27, 2019
RF Cable (9KHz-26.5GHz)	Tonscend	170660	N/A	Dec. 27, 2019
RF automatic control unit	Tonscend	JS0806-2	HKE-060	Dec. 27, 2019

**Note:** The calibration interval of the above test instruments is 12 months and the calibrations are traceable to international system unit (SI).





**Test data**

Test channel	6dB Emission Bandwidth (MHz)			
	802.11b	802.11g	802.11n(H20)	802.11n(H40)
Lowest	9.118	16.06	17.68	36.54
Middle	8.933	16.24	17.72	36.35
Highest	9.640	16.57	17.78	36.43
Limit:	>500kHz			
Test Result:	PASS			

Test plots as follows:

**802.11b Modulation**

Lowest channel





### Middle channel



### Highest channel

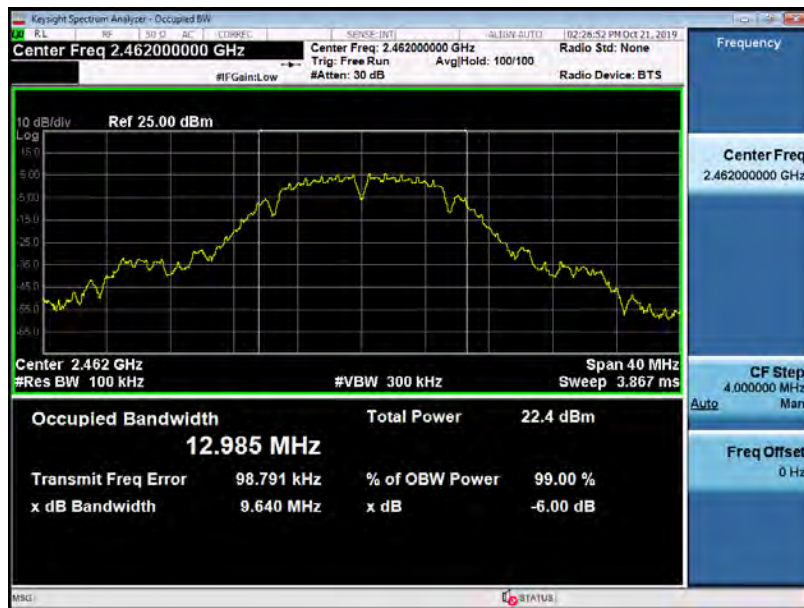



### 802.11g Modulation

#### Lowest channel



#### Middle channel





### Highest channel



### 802.11n (HT20) Modulation

### Lowest channel

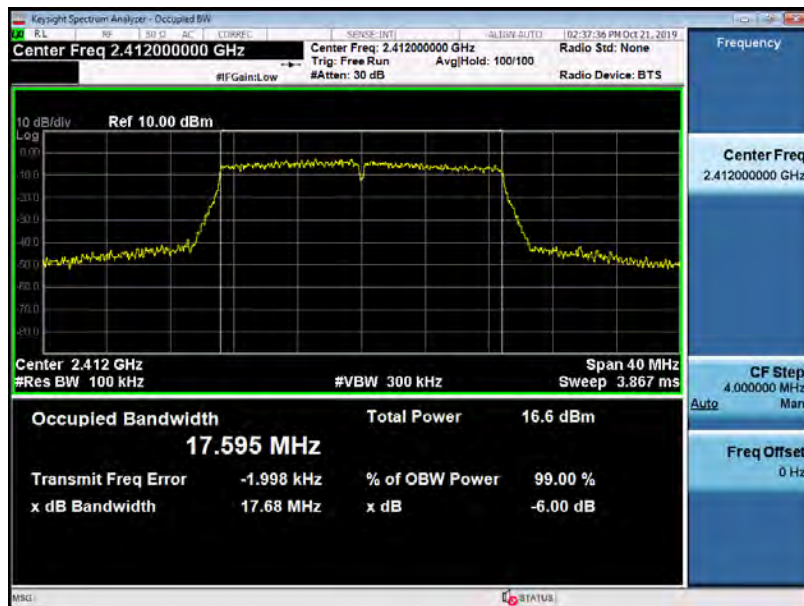





### Middle channel



### Highest channel

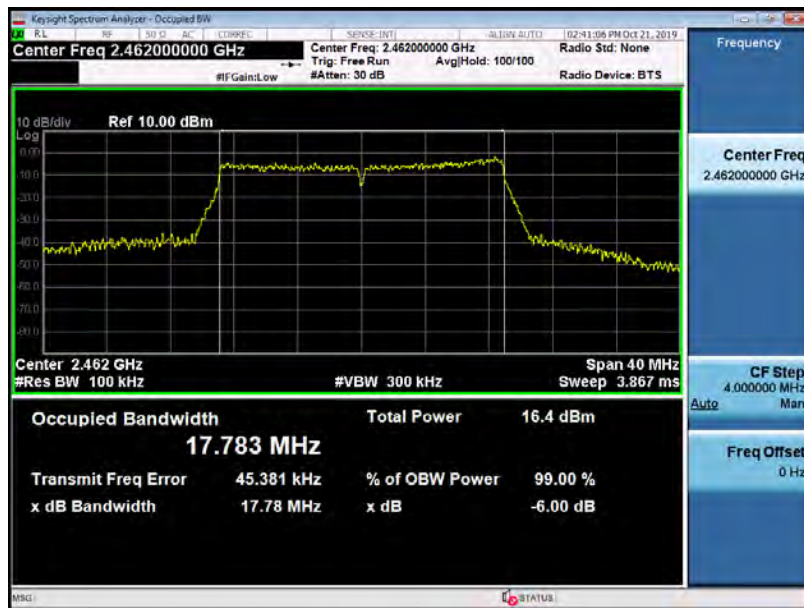



### 802.11n (HT40) Modulation

#### Lowest channel

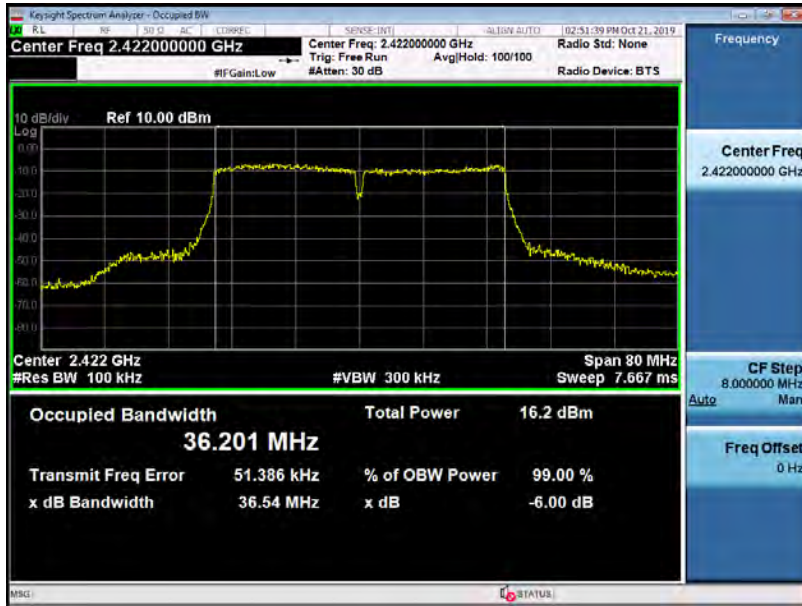

#### Middle channel

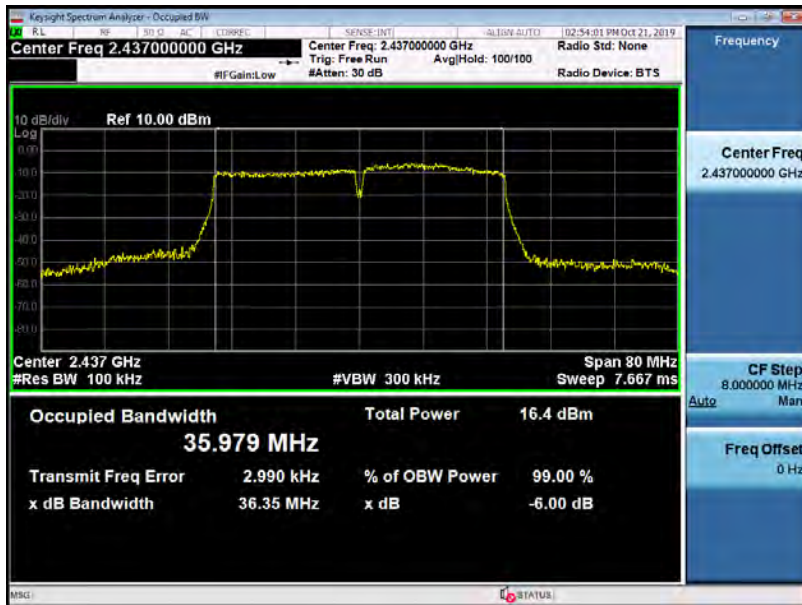



### Highest channel







**Test data**

EUT Set Mode	Channel	Result (dBm/3kHz)
802.11b	Lowest	-15.280
	Middle	-15.219
	Highest	-13.144
802.11g	Lowest	-15.105
	Middle	-15.204
	Highest	-16.309
802.11n(H20)	Lowest	-17.209
	Middle	-14.712
	Highest	-16.435
802.11n(H40)	Lowest	-20.066
	Middle	-18.978
	Highest	-18.635
Limit: 8dBm/3kHz		
Test Result:	PASS	

Test plots as follows:



### 802.11b Modulation

#### Lowest channel



#### Middle channel





### Highest channel





### 802.11g Modulation

#### Lowest channel

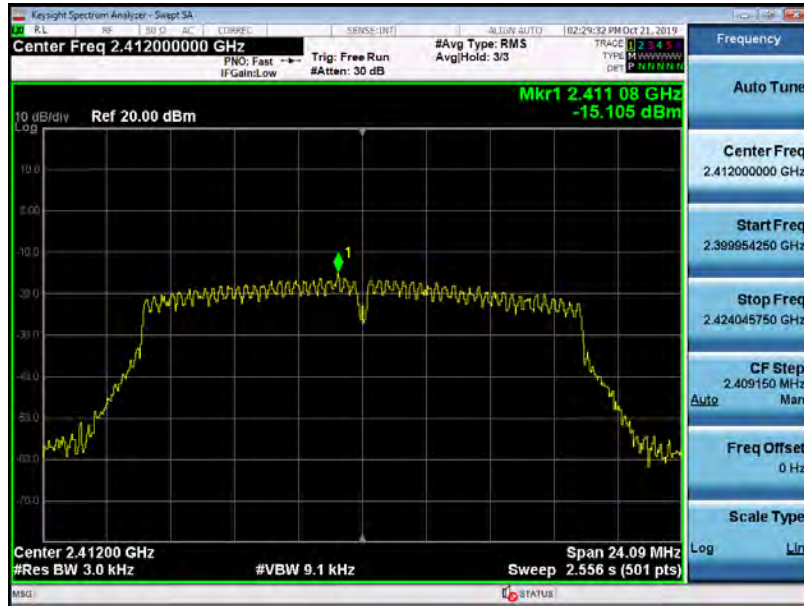

#### Middle channel





### Highest channel

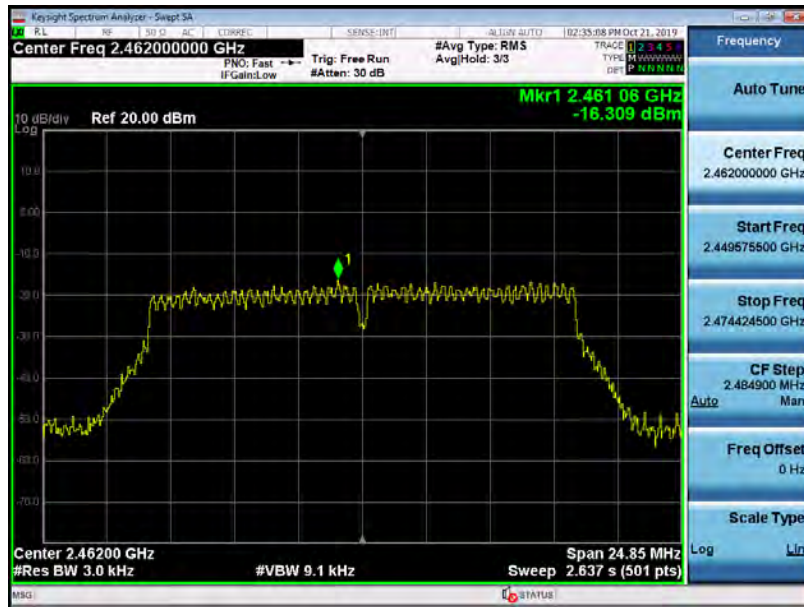



### 802.11n (HT20) Modulation

#### Lowest channel

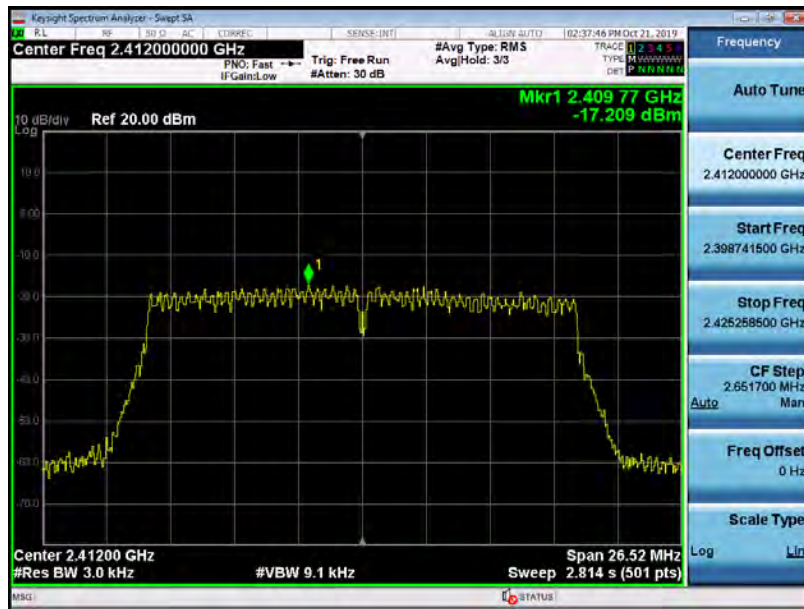

#### Middle channel







### Highest channel





### 802.11n (HT40) Modulation

#### Lowest channel



#### Middle channel

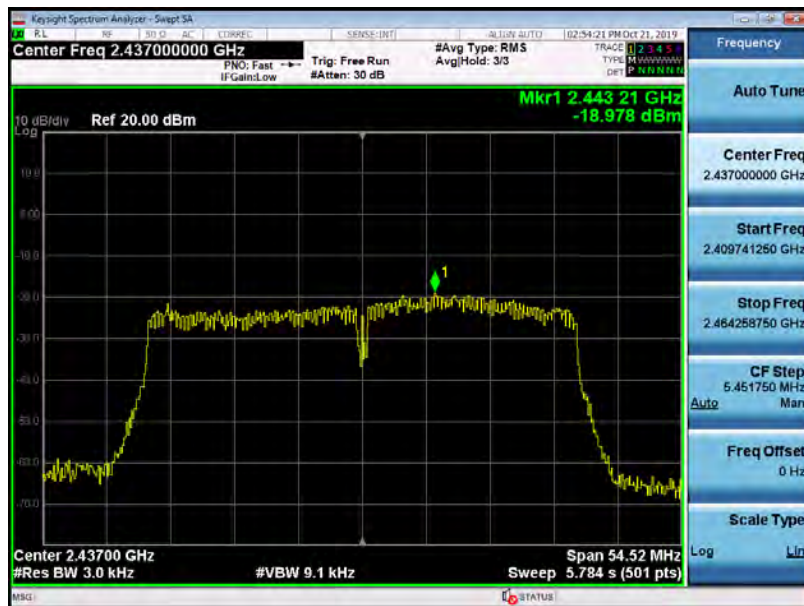





### Highest channel







### Test Instruments

RF Test Room				
Equipment	Manufacturer	Model	Serial Number	Calibration Due
Spectrum analyzer	Agilent	N9020A	HKE-048	Dec. 27, 2019
Signal generator	Agilent	N5183A	HKE-071	Dec. 27, 2019
RF Cable (9KHz-26.5GHz)	Tonscend	170660	N/A	Dec. 27, 2019
RF automatic control unit	Tonscend	JS0806-2	HKE-060	Dec. 27, 2019

**Note:** The calibration interval of the above test instruments is 12 months and the calibrations are traceable to international system unit (SI).

### Test Data

#### 802.11b Modulation

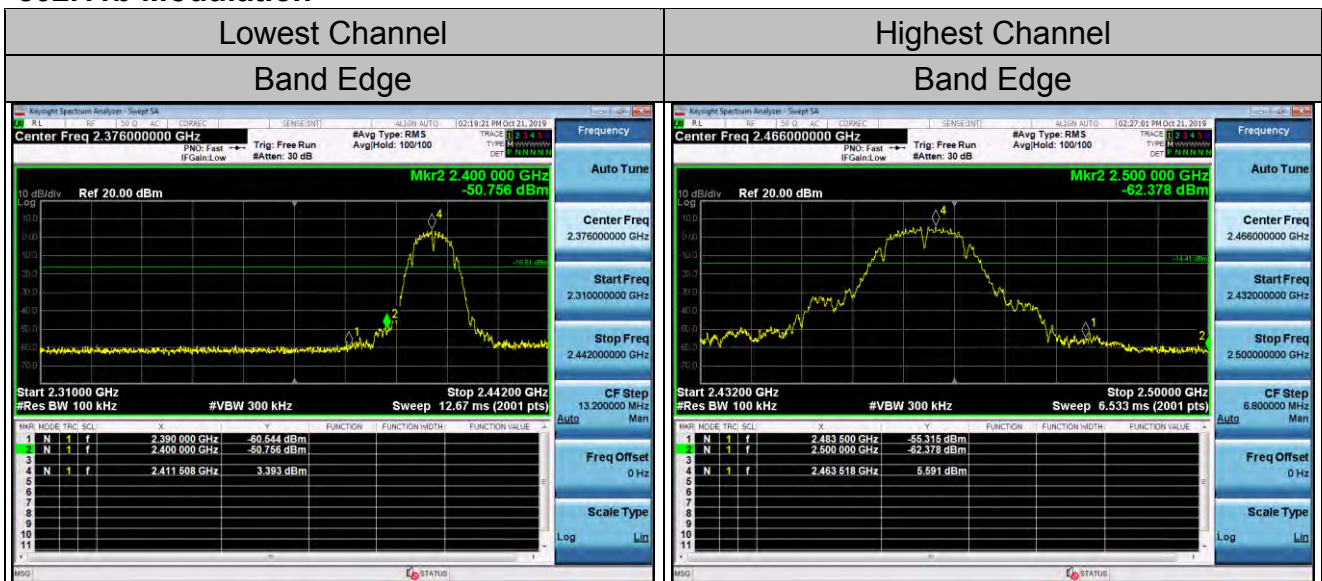

#### Spurious emission

##### Low Channel

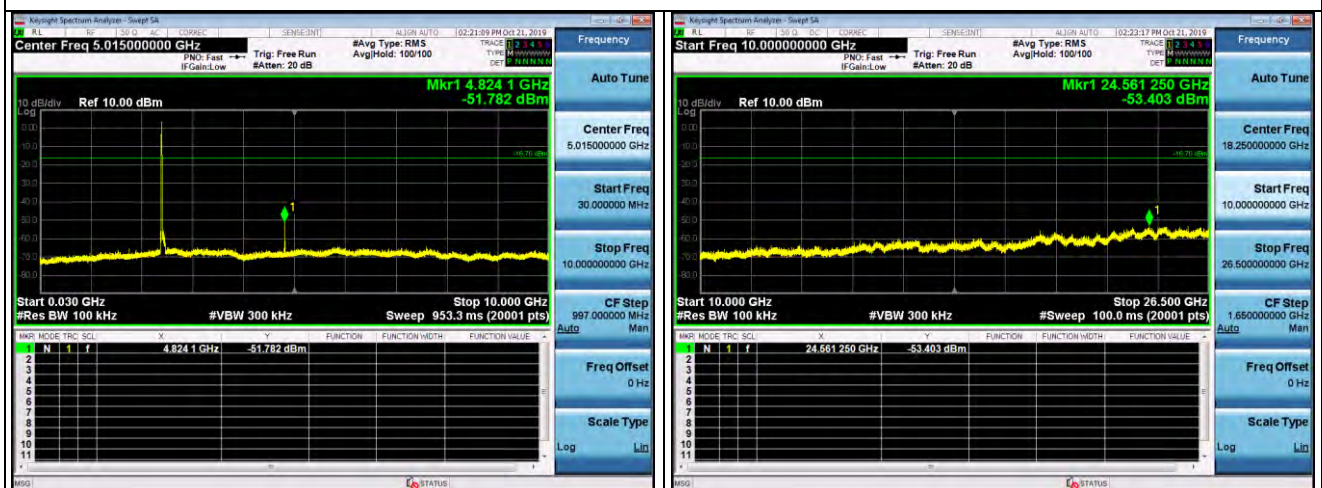





### Middle Channel

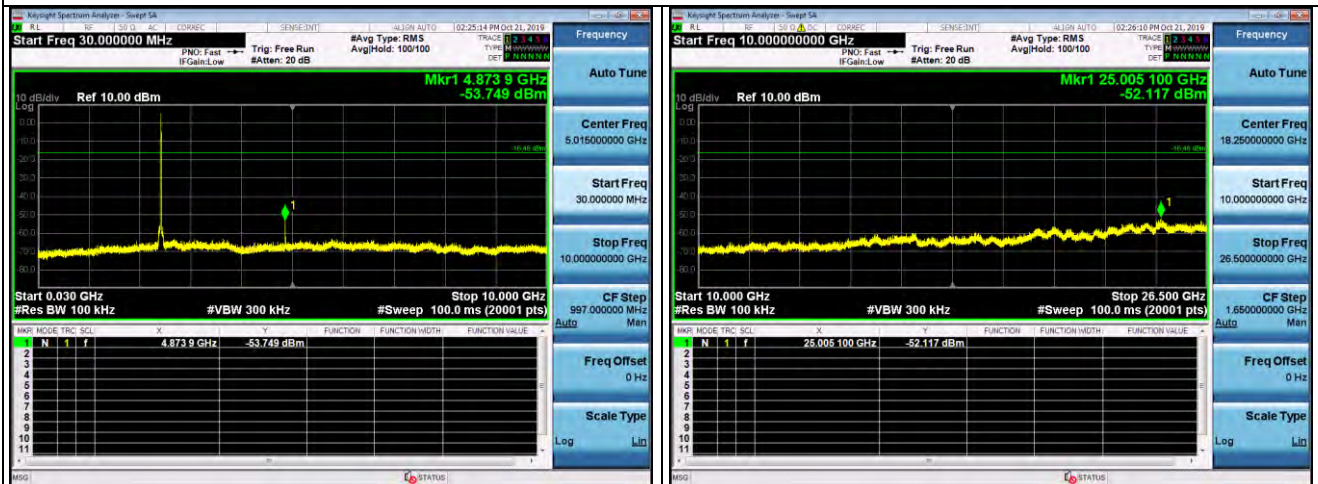

### High Channel

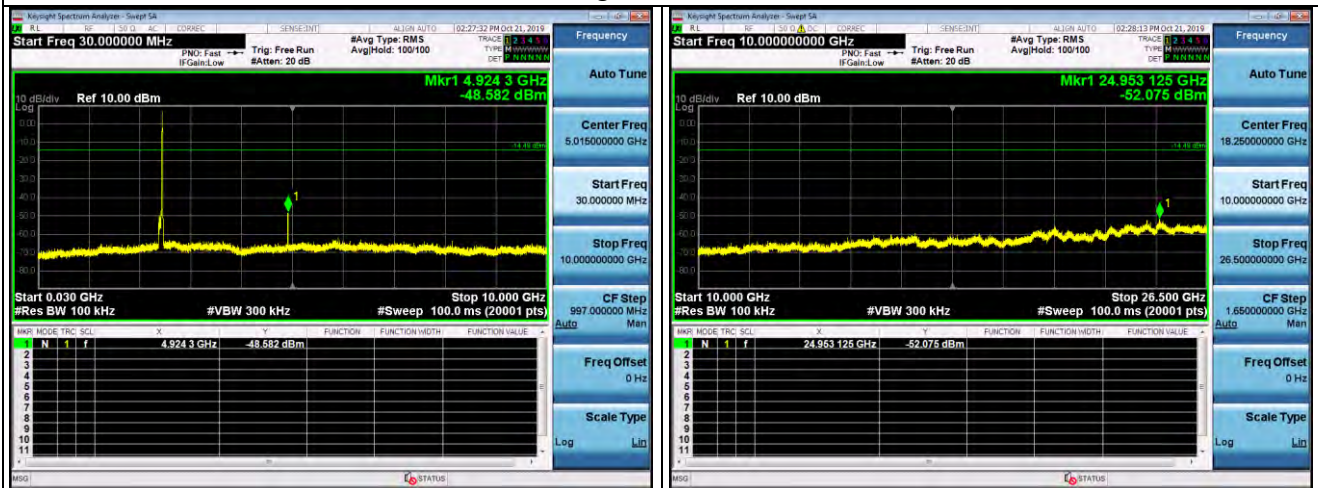

### 802.11g Modulation

#### Lowest Channel Band Edge

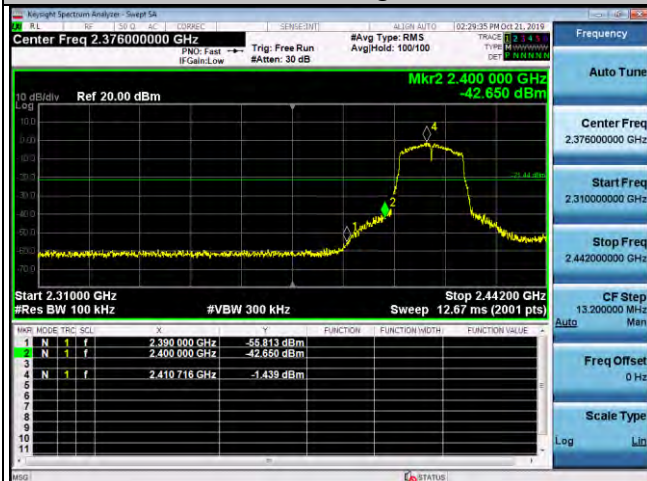

#### Highest Channel Band Edge

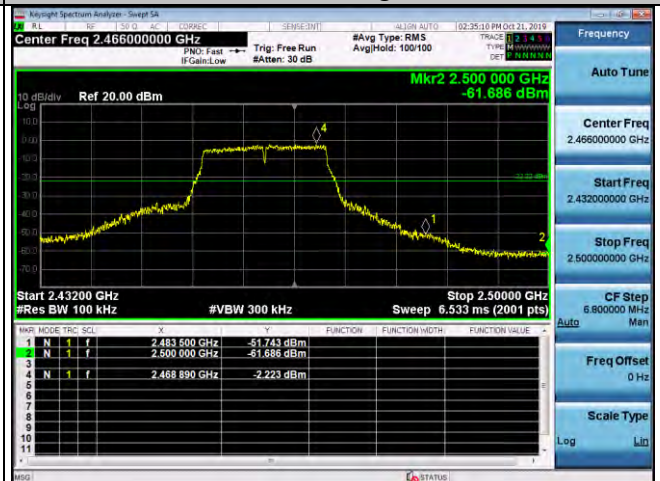

### Spurious emission





### Low Channel

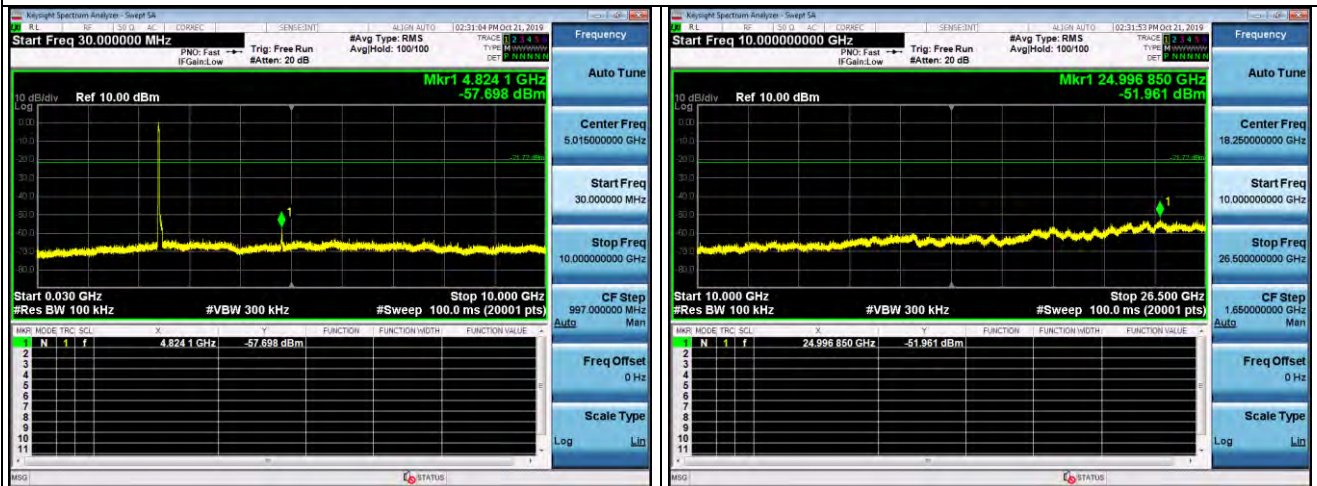

### Middle Channel

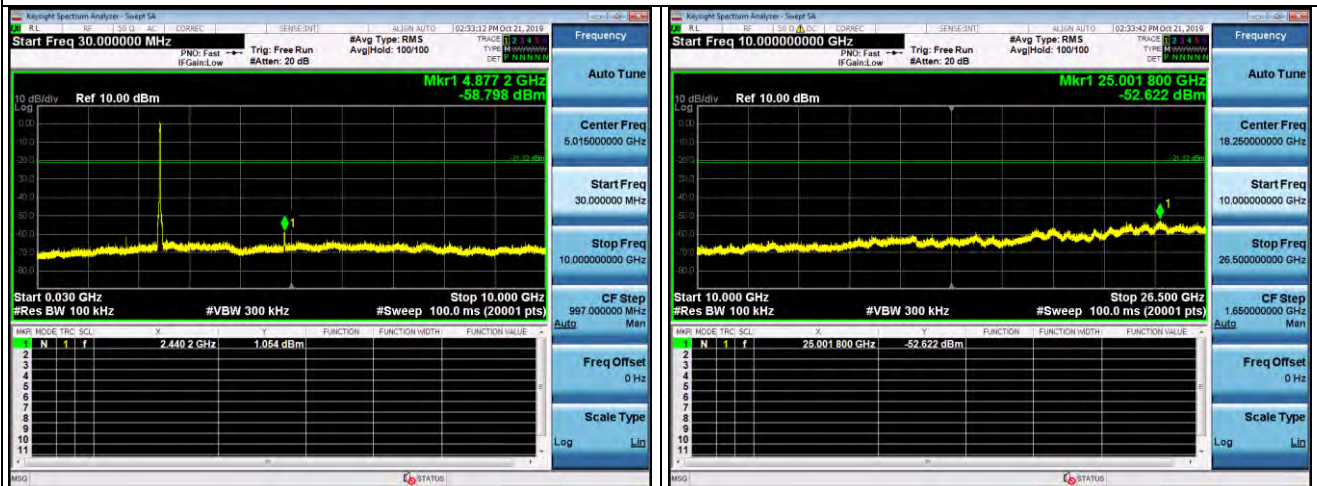

### High Channel

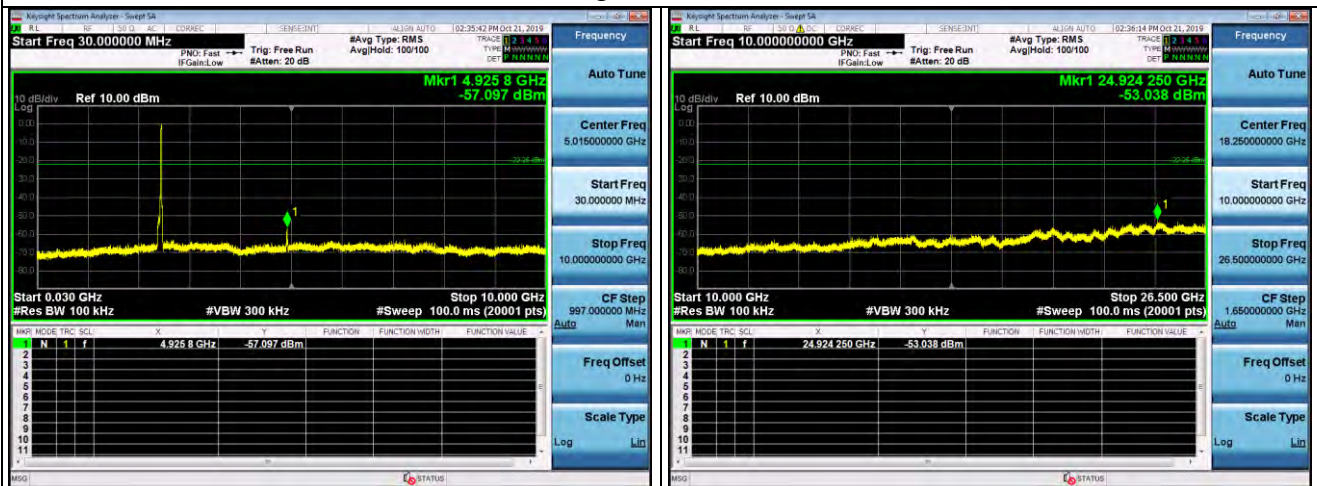





### 802.11n (HT20) Modulation



### Spurious emission

### Low Channel

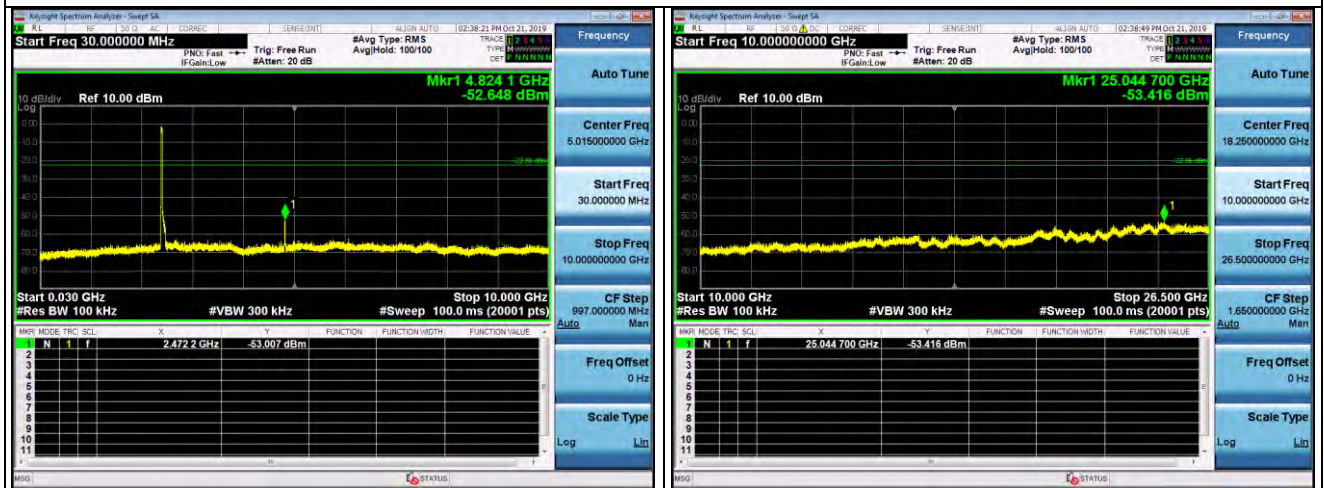

### Middle Channel

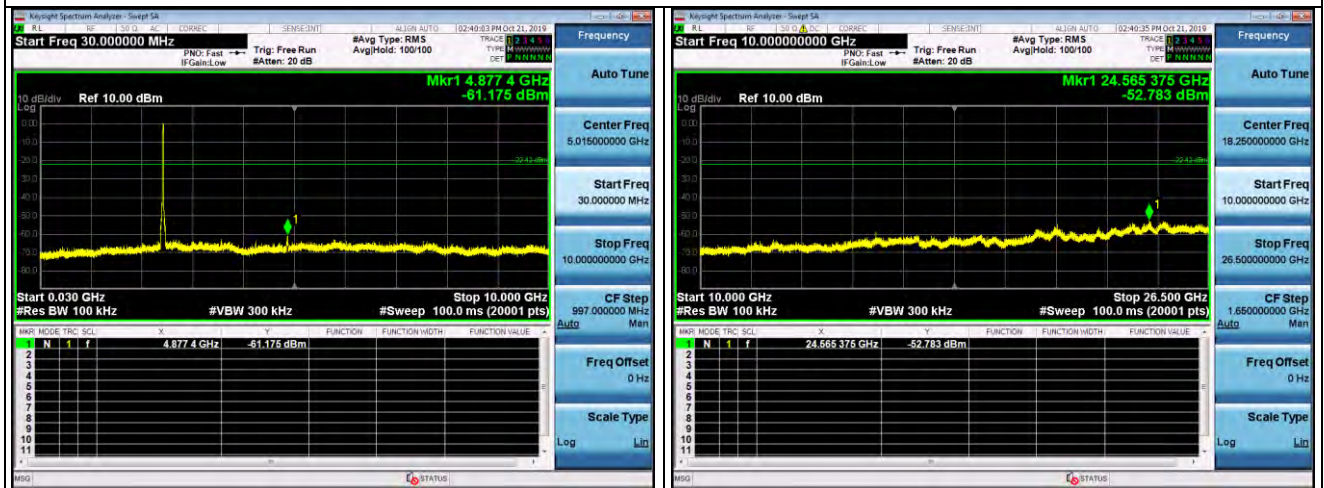





### High Channel

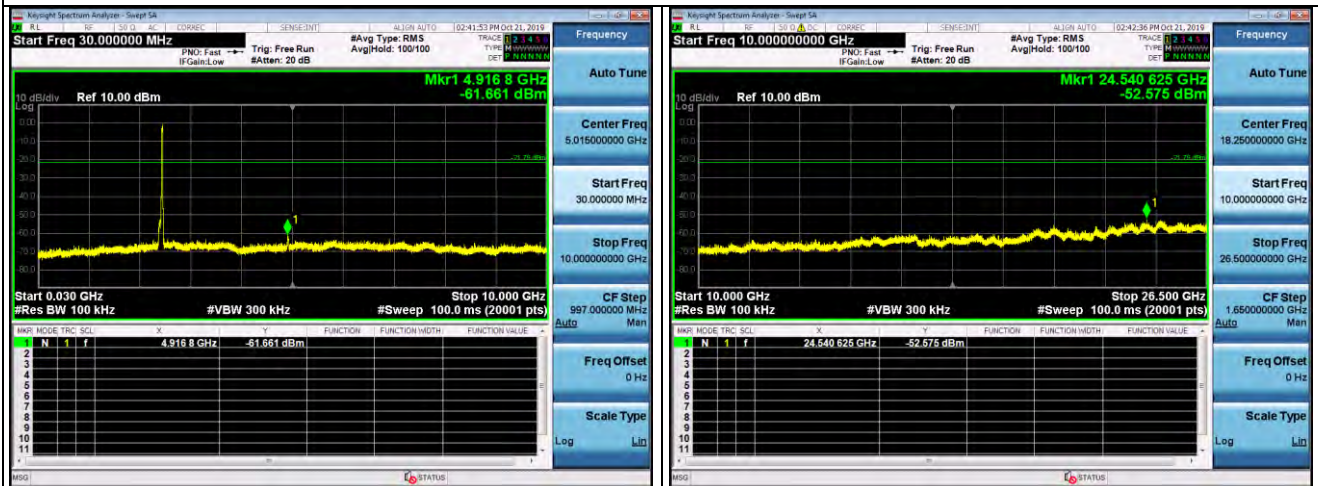

### 802.11n (HT40) Modulation

#### Lowest Channel

#### Band Edge

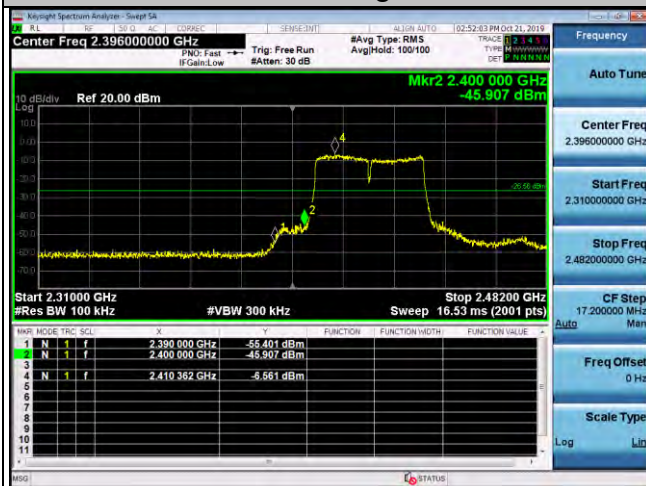

#### Highest Channel

#### Band Edge



### Spurious emission

#### Low Channel

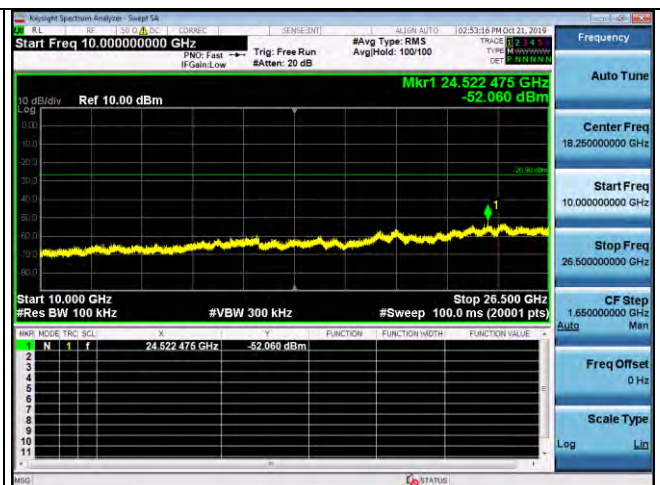
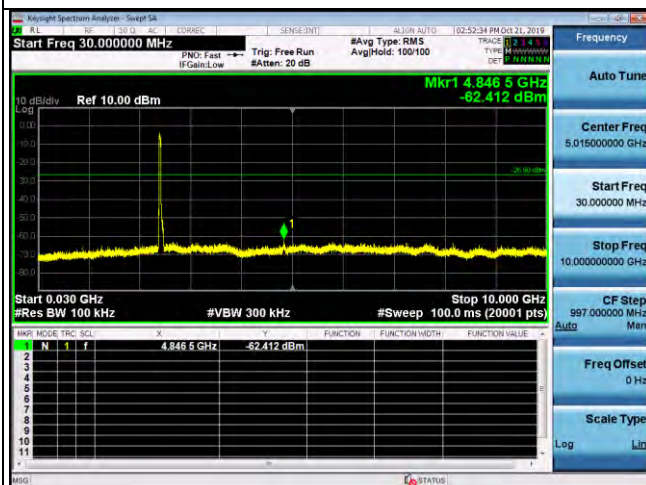



### Middle Channel

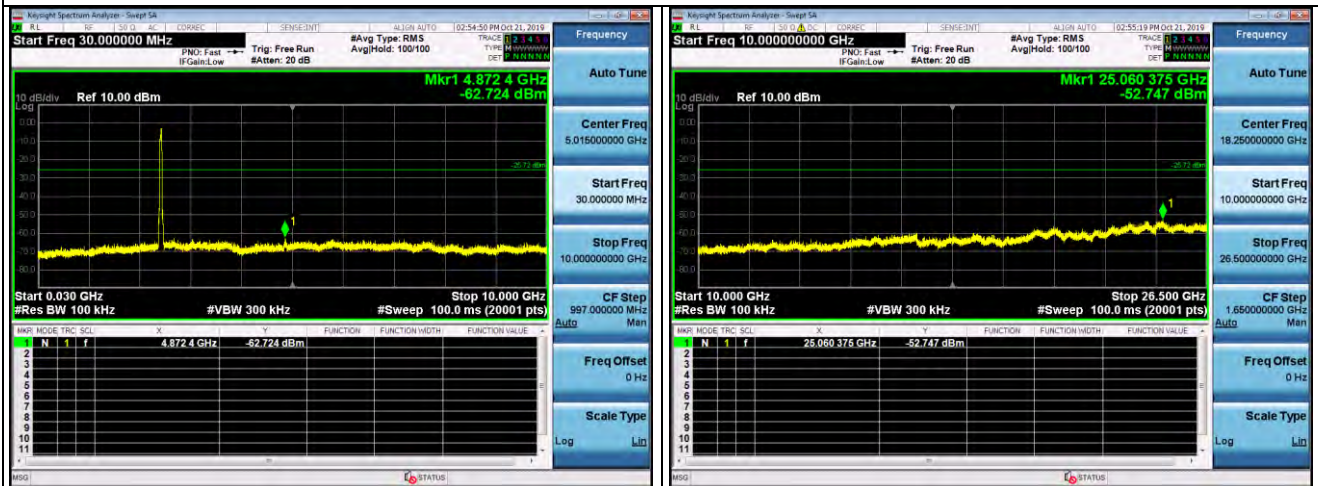

### High Channel

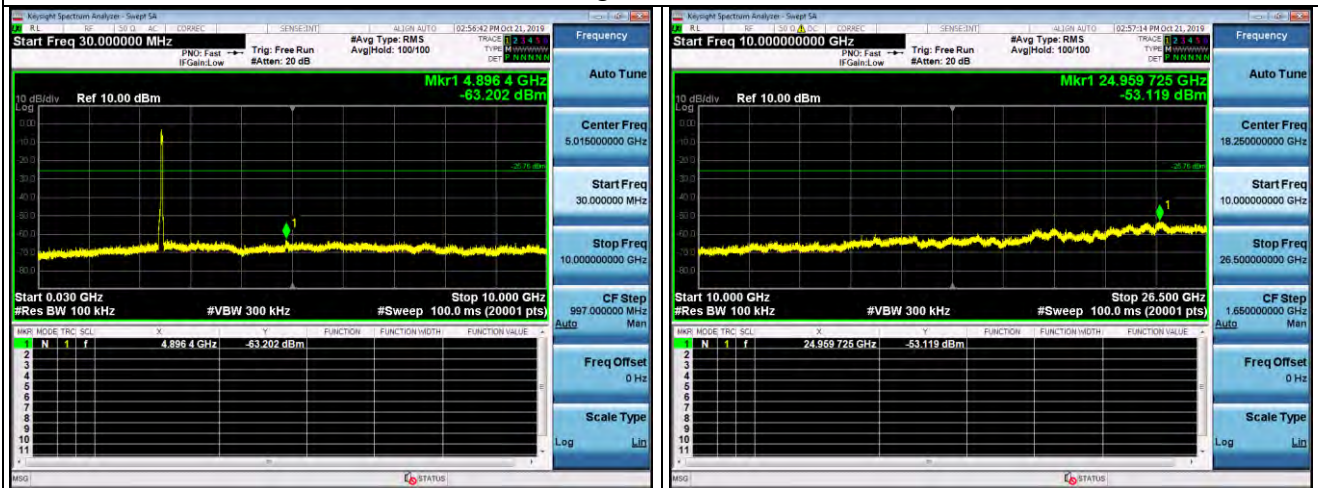





### 4.6. Radiated Spurious Emission Measurement

#### Test Specification

<b>Test Requirement:</b>	FCC Part15 C Section 15.209					
<b>Test Method:</b>	ANSI C63.10: 2013					
<b>Frequency Range:</b>	9 kHz to 25 GHz					
<b>Measurement Distance:</b>	3 m					
<b>Antenna Polarization:</b>	Horizontal & Vertical					
<b>Operation mode:</b>	Transmitting mode with modulation					
<b>Receiver Setup:</b>	Frequency	Detector	RBW	VBW	Remark	
	9kHz- 150kHz	Quasi-peak	200Hz	1kHz	Quasi-peak Value	
	150kHz- 30MHz	Quasi-peak	9kHz	30kHz	Quasi-peak Value	
	30MHz-1GHz	Quasi-peak	120KHz	300KHz	Quasi-peak Value	
	Above 1GHz	Peak	1MHz	3MHz	Peak Value	
		Peak	1MHz	10Hz	Average Value	
<b>Limit:</b>	Frequency	Field Strength (microvolts/meter)	Measurement Distance (meters)			
	0.009-0.490	2400/F(KHz)	300			
	0.490-1.705	24000/F(KHz)	30			
	1.705-30	30	30			
	30-88	100	3			
	88-216	150	3			
	216-960	200	3			
	Above 960	500	3			
	Frequency	Field Strength (microvolts/meter)	Measurement Distance (meters)	Detector		
	Above 1GHz	500	3	Average		
	5000	3	Peak			
<b>Test setup:</b>	For radiated emissions below 30MHz					
	<p>Distance = 3m</p> <p>0.8m</p> <p>EUT</p> <p>Turn table</p> <p>Ground Plane</p> <p>Computer</p> <p>Pre -Amplifier</p> <p>Receiver</p>					
	30MHz to 1GHz					

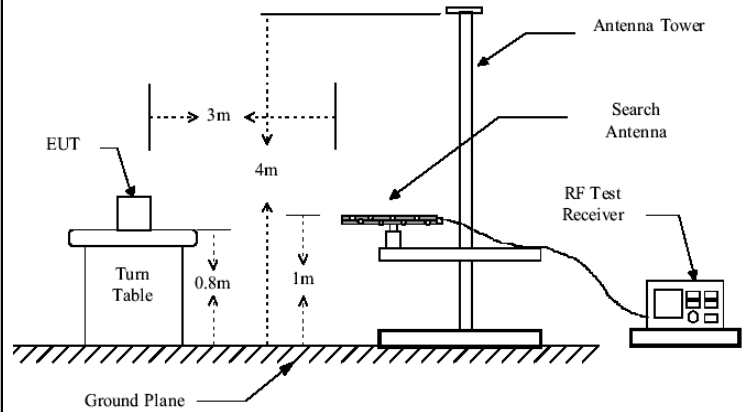

Above 1GHz

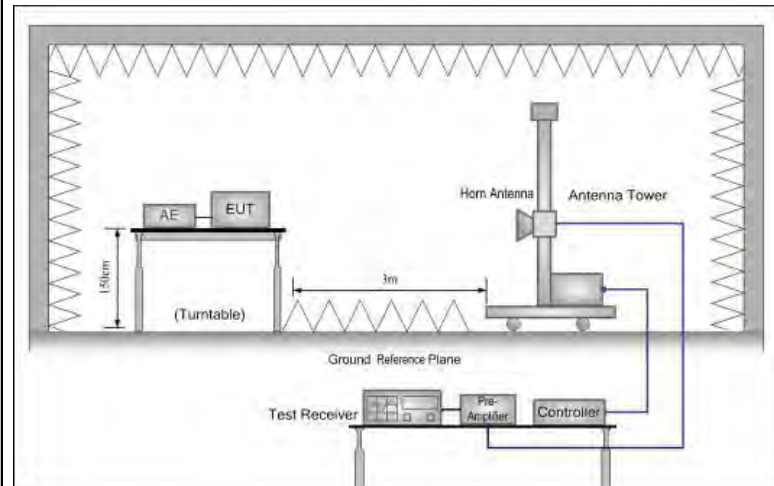

**Test Procedure:**

1. For the radiated emission test below 1GHz:  
 The EUT was placed on a turntable with 0.8 meter above ground. The EUT was set 3 meters from the interference receiving antenna, which was mounted on the top of a variable height antenna tower. The EUT was arranged to its worst case and then tune the antenna tower (from 1 m to 4 m) and turntable (from 0 degree to 360 degrees) to find the maximum reading. A pre-amp and a high PASS filter are used for the test in order to get better signal level.  
 For the radiated emission test above 1GHz:  
 Place the measurement antenna on a turntable with 1.5 meter above ground, which is away from each area of the EUT determined to be a source of emissions at the specified measurement distance, while keeping the measurement antenna aimed at the source of emissions at each frequency of significant emissions, with polarization oriented for maximum response. The measurement antenna may have to be higher or lower than the EUT, depending on the radiation pattern of the emission and staying aimed at the emission source for receiving the maximum signal. The final measurement antenna elevation shall be that which



	<p>maximizes the emissions. The measurement antenna elevation for maximum emissions shall be restricted to a range of heights of from 1 m to 4 m above the ground or reference ground plane.</p> <ol style="list-style-type: none"><li>3. Corrected Reading: Antenna Factor + Cable Loss + Read Level - Preamp Factor = Level</li><li>4. For measurement below 1GHz, If the emission level of the EUT measured by the peak detector is 3 dB lower than the applicable limit, the peak emission level will be reported. Otherwise, the emission measurement will be repeated using the quasi-peak detector and reported.</li><li>5. Use the following spectrum analyzer settings:<ol style="list-style-type: none"><li>(1) Span shall wide enough to fully capture the emission being measured;</li><li>(2) Set RBW=100 kHz for <math>f &lt; 1</math> GHz; VBW <math>\geq</math> RBW; Sweep = auto; Detector function = peak; Trace = max hold;</li><li>(3) Set RBW = 1 MHz, VBW= 3MHz for <math>f \geq 1</math> GHz for peak measurement.</li></ol></li></ol> <p>For average measurement: VBW = 10 Hz, when duty cycle is no less than 98 percent. VBW <math>\geq 1/T</math>, when duty cycle is less than 98 percent where T is the minimum transmission duration over which the transmitter is on and is transmitting at its maximum power control level for the tested mode of operation.</p>
<b>Test results:</b>	PASS

**Test Instruments**

<b>Radiated Emission Test Site (966)</b>				
<b>Name of Equipment</b>	<b>Manufacturer</b>	<b>Model</b>	<b>Serial Number</b>	<b>Calibration Due</b>
Receiver	R&S	ESCI-7	HKE-010	Dec. 27, 2019
Spectrum analyzer	Agilent	N9020A	HKE-048	Dec. 27, 2019
Preamplifier	EMCI	EMC051845 SE	HKE-015	Dec. 27, 2019
Preamplifier	Agilent	83051A	HKE-016	Dec. 27, 2019
Loop antenna	Schwarzbeck	FMZB 1519 B	HKE-014	Dec. 26, 2019
Broadband antenna	Schwarzbeck	VULB 9163	HKE-012	Dec. 26, 2019
Horn antenna	Schwarzbeck	9120D	HKE-013	Dec. 26, 2019
Antenna Mast	Keleto	CC-A-4M	N/A	N/A
Position controller	Taiwan MF	MF7802	HKE-011	Dec. 27, 2019
Radiated test software	Tonscend	TS+ Rev 2.5.0.0	HKE-082	N/A
RF cable (9KHz-1GHz)	Times	381806-001	N/A	N/A
RF cable	Times	1-40G	HKE-034	Dec. 27, 2019

**Note:** The calibration interval of the above test instruments is 12 months and the calibrations are traceable to international system unit (SI).



### Test Data

All the test modes completed for test. only the worst result of AC 120V/60Hz(802.11b at 2412MHz) was reported as below:

#### Below 1GHz

### Horizontal

Test Graph

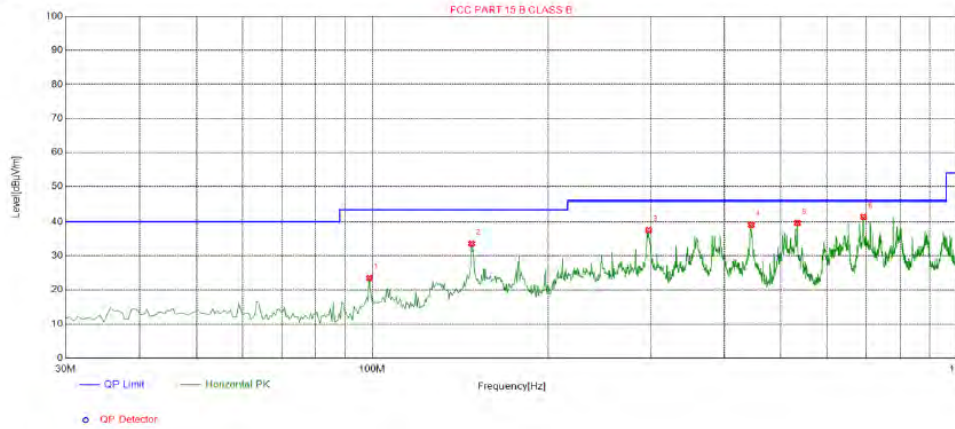

### Suspected List

Suspected List								
NO.	Freq. [MHz]	Level [dBμV/m]	Factor [dB]	Limit [dBμV/m]	Margin [dB]	Height [cm]	Angle [°]	Polarity
1	98.8700	23.45	-15.59	43.50	20.05	100	3	Horizontal
2	147.855	33.56	-18.99	43.50	9.94	100	86	Horizontal
3	297.235	37.48	-12.76	46.00	8.52	100	341	Horizontal
4	445.645	39.08	-9.18	46.00	6.92	100	232	Horizontal
5	534.400	39.66	-7.34	46.00	6.34	100	137	Horizontal
6	693.480	41.48	-5.16	46.00	4.52	100	75	Horizontal

Remark: Margin = Limit – Level

Correction factor = Cable lose + LISN insertion loss

Level=Test receiver reading + correction factor



**Vertical**

**Test Graph**

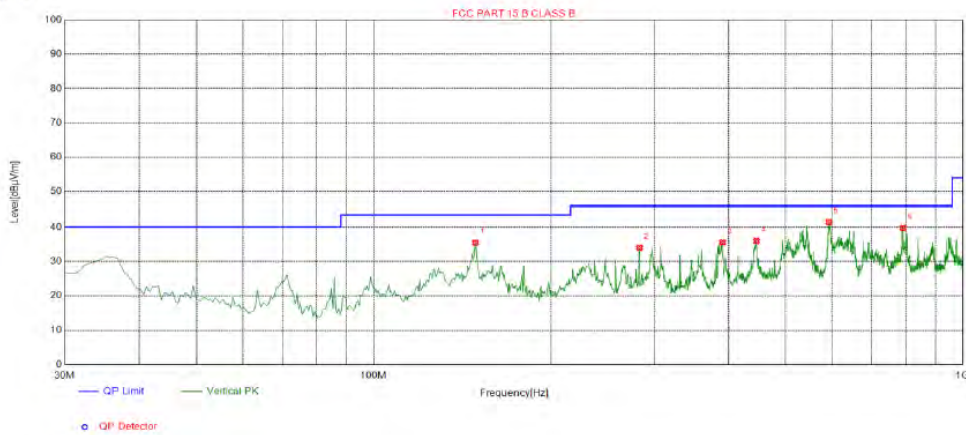

**Suspected List**

Suspected List								
NO.	Freq. [MHz]	Level [dBµV/m]	Factor [dB]	Limit [dBµV/m]	Margin [dB]	Height [cm]	Angle [°]	Polarity
1	148.825	35.46	-18.97	43.50	8.04	100	79	Vertical
2	282.685	33.98	-13.14	46.00	12.02	100	346	Vertical
3	391.325	35.57	-10.62	46.00	10.43	100	137	Vertical
4	447.100	35.94	-9.11	46.00	10.06	100	103	Vertical
5	593.085	41.51	-6.57	46.00	4.49	100	103	Vertical
6	791.935	39.78	-3.24	46.00	6.22	100	12	Vertical

Remark: Margin = Limit – Level  
 Correction factor = Cable lose + LISN insertion loss  
 Level=Test receiver reading + correction factor

**Harmonics and Spurious Emissions**

**Frequency Range (9 kHz-30MHz)**

Frequency (MHz)	Level@3m (dBµV/m)	Limit@3m (dBµV/m)
--	--	--
--	--	--
--	--	--
--	--	--

- Note:** 1. Emission Level=Reading+ Cable loss-Antenna factor-Amp factor  
 2. The emission levels are 20 dB below the limit value, which are not reported. It is deemed to comply with the requirement

**For 1GHz to 25GHz**

LOW CH1 (802.11b Mode)/2412MHz

Horizontal:

Frequency (MHz)	Meter Reading (dB $\mu$ V)	Factor (dB)	Emission Level (dB $\mu$ V/m)	Limits (dB $\mu$ V/m)	Margin (dB)	Detector Type
4824.00	55.30	-3.64	51.66	74	-22.34	Peak
4824.00	46.38	-3.64	42.74	54	-11.26	AVG
7236.00	54.84	-0.95	53.89	74	-20.11	Peak
7236.00	44.60	-0.95	43.65	54	-10.35	AVG

Remark :Factor= Antenna Factor + Cable Loss - Pre-amplifier

Vertical:

Frequency (MHz)	Meter Reading (dB $\mu$ V)	Factor (dB)	Emission Level (dB $\mu$ V/m)	Limits (dB $\mu$ V/m)	Margin (dB)	Detector Type
4824.00	55.29	-3.64	51.65	74	-22.35	Peak
4824.00	46.58	-3.64	42.94	54	-11.06	AVG
7236.00	55.92	-0.95	54.97	74	-19.03	Peak
7236.00	46.43	-0.95	45.48	54	-8.52	AVG

Remark :Factor= Antenna Factor + Cable Loss - Pre-amplifier





MID CH6 (802.11b Mode)/2437

Horizontal:

Frequency (MHz)	Meter Reading (dB $\mu$ V)	Factor (dB)	Emission Level (dB $\mu$ V/m)	Limits (dB $\mu$ V/m)	Margin (dB)	Detector Type
4874.00	56.70	-3.51	53.19	74	-20.81	Peak
4874.00	47.90	-3.51	44.39	54	-9.61	AVG
7311.00	56.36	-0.82	55.54	74	-18.46	Peak
7311.00	45.63	-0.82	44.81	54	-9.19	AVG

Remark :Factor= Antenna Factor + Cable Loss - Pre-amplifier

Vertical:

Frequency (MHz)	Meter Reading (dB $\mu$ V)	Factor (dB)	Emission Level (dB $\mu$ V/m)	Limits (dB $\mu$ V/m)	Margin (dB)	Detector Type
4874.00	55.17	-3.51	51.66	74	-22.34	Peak
4874.00	45.58	-3.51	42.07	54	-11.93	AVG
7311.00	54.69	-0.82	53.87	74	-20.13	Peak
7311.00	47.57	-0.82	46.75	54	-7.25	AVG

Remark :Factor= Antenna Factor + Cable Loss - Pre-amplifier



## HIGH CH11 (802.11b Mode)/2462

Horizontal:

Frequency (MHz)	Meter Reading (dB $\mu$ V)	Factor (dB)	Emission Level (dB $\mu$ V/m)	Limits (dB $\mu$ V/m)	Margin (dB)	Detector Type
4924.00	56.74	-3.43	53.31	74	-20.69	Peak
4924.00	48.22	-3.43	44.79	54	-9.21	AVG
7386.00	54.84	-0.75	54.09	74	-19.91	Peak
7386.00	45.67	-0.75	44.92	54	-9.08	AVG

Remark :Factor= Antenna Factor + Cable Loss - Pre-amplifier

Vertical:

Frequency (MHz)	Meter Reading (dB $\mu$ V)	Factor (dB)	Emission Level (dB $\mu$ V/m)	Limits (dB $\mu$ V/m)	Margin (dB)	Detector Type
4924.00	55.64	-3.43	52.21	74	-21.79	Peak
4924.00	45.53	-3.43	42.10	54	-11.90	AVG
7386.00	56.53	-0.75	55.78	74	-18.22	Peak
7386.00	47.69	-0.75	46.94	54	-7.06	AVG

Remark :Factor= Antenna Factor + Cable Loss - Pre-amplifier

Remark:

(1) Measuring frequencies from 1 GHz to the 25 GHz.

(2) "F" denotes fundamental frequency; "H" denotes spurious frequency. "E" denotes band edge frequency.

(3) \* denotes emission frequency which appearing within the Restricted Bands specified in provision of 15.205, then the general radiated emission limits in 15.209 apply.

(4) Data of measurement within this frequency range shown "---" in the table above means the reading of emissions are attenuated more than 20dB below the permissible limits or the field strength is too small to be measured.

(5) The IF bandwidth of EMI Test Receiver between 30MHz to 1GHz was 120KHz, 1 MHz for measuring above 1 GHz, below 30MHz was 10KHz.

(6) When the test results of Peak Detected below the limits of Average Detected, the Average Detected is not need completed. For example: Top Channel at Fundamental 73.16dBuV/m(PK Value) &lt;93.98(AV Limit), at harmonic 53.20 dBuV/m(PK Value) &lt;54 dBuV/m(AV Limit), the Average Detected not need to completed.



LOW CH1 (802.11g Mode)/2412

Horizontal:

Frequency (MHz)	Meter Reading (dB $\mu$ V)	Factor (dB)	Emission Level (dB $\mu$ V/m)	Limits (dB $\mu$ V/m)	Margin (dB)	Detector Type
4824.00	55.06	-3.64	51.42	74	-22.58	Peak
4824.00	46.77	-3.64	43.13	54	-10.87	AVG
7236.00	55.86	-0.95	54.91	74	-19.09	Peak
7236.00	47.36	-0.95	46.41	54	-7.59	AVG

Remark :Factor= Antenna Factor + Cable Loss - Pre-amplifier

Vertical:

Frequency (MHz)	Meter Reading (dB $\mu$ V)	Factor (dB)	Emission Level (dB $\mu$ V/m)	Limits (dB $\mu$ V/m)	Margin (dB)	Detector Type
4824.00	55.46	-3.64	51.82	74	-22.18	Peak
4824.00	45.49	-3.64	41.85	54	-12.15	AVG
7236.00	54.97	-0.95	54.02	74	-19.98	Peak
7236.00	45.31	-0.95	44.36	54	-9.64	AVG

Remark :Factor= Antenna Factor + Cable Loss - Pre-amplifier



MID CH6 (802.11g Mode)/2437

Horizontal:

Frequency (MHz)	Meter Reading (dB $\mu$ V)	Factor (dB)	Emission Level (dB $\mu$ V/m)	Limits (dB $\mu$ V/m)	Margin (dB)	Detector Type
4874.00	55.09	-3.51	51.58	74	-22.42	Peak
4874.00	47.04	-3.51	43.53	54	-10.47	AVG
7311.00	56.07	-0.82	55.25	74	-18.75	Peak
7311.00	45.90	-0.82	45.08	54	-8.92	AVG

Remark :Factor= Antenna Factor + Cable Loss - Pre-amplifier

Vertical:

Frequency (MHz)	Meter Reading (dB $\mu$ V)	Factor (dB)	Emission Level (dB $\mu$ V/m)	Limits (dB $\mu$ V/m)	Margin (dB)	Detector Type
4874.00	56.67	-3.51	53.16	74	-20.84	Peak
4874.00	45.43	-3.51	41.92	54	-12.08	AVG
7311.00	55.97	-0.82	55.15	74	-18.85	Peak
7311.00	45.32	-0.82	44.50	54	-9.50	AVG

Remark :Factor= Antenna Factor + Cable Loss - Pre-amplifier



## HIGH CH11 (802.11g Mode)/2462

Horizontal:

Frequency (MHz)	Meter Reading (dB $\mu$ V)	Factor (dB)	Emission Level (dB $\mu$ V/m)	Limits (dB $\mu$ V/m)	Margin (dB)	Detector Type
4924.00	56.72	-3.43	53.29	74	-20.71	Peak
4924.00	47.46	-3.43	44.03	54	-9.97	AVG
7386.00	54.78	-0.75	54.03	74	-19.97	Peak
7386.00	45.91	-0.75	45.16	54	-8.84	AVG

Remark :Factor= Antenna Factor + Cable Loss - Pre-amplifier

Vertical:

Frequency (MHz)	Meter Reading (dB $\mu$ V)	Factor (dB)	Emission Level (dB $\mu$ V/m)	Limits (dB $\mu$ V/m)	Margin (dB)	Detector Type
4924.00	55.84	-3.43	52.41	74	-21.59	Peak
4924.00	44.71	-3.43	41.28	54	-12.72	AVG
7386.00	55.67	-0.75	54.92	74	-19.08	Peak
7386.00	46.36	-0.75	45.61	54	-8.39	AVG

Remark :Factor= Antenna Factor + Cable Loss - Pre-amplifier

## Remark:

- (1) Measuring frequencies from 1 GHz to the 25 GHz.
- (2) "F" denotes fundamental frequency; "H" denotes spurious frequency. "E" denotes band edge frequency.
- (3) \* denotes emission frequency which appearing within the Restricted Bands specified in provision of 15.205, then the general radiated emission limits in 15.209 apply.
- (4) Data of measurement within this frequency range shown "---" in the table above means the reading of emissions are attenuated more than 20dB below the permissible limits or the field strength is too small to be measured.
- (5) The IF bandwidth of EMI Test Receiver between 30MHz to 1GHz was 120KHz, 1 MHz for measuring above 1 GHz, below 30MHz was 10KHz.
- (6) When the test results of Peak Detected below the limits of Average Detected, the Average Detected is not need completed. For example: Top Channel at Fundamental 73.16dBuV/m(PK Value) <93.98(AV Limit), at harmonic 53.20 dBuV/m(PK Value) <54 dBuV/m(AV Limit), the Average Detected not need to completed.





LOW CH1 (802.11n/H20 Mode)/2412

Horizontal:

Frequency (MHz)	Meter Reading (dB $\mu$ V)	Factor (dB)	Emission Level (dB $\mu$ V/m)	Limits (dB $\mu$ V/m)	Margin (dB)	Detector Type
4824.00	55.43	-3.64	51.79	74	-22.21	Peak
4824.00	46.33	-3.64	42.69	54	-11.31	AVG
7236.00	55.45	-0.95	54.50	74	-19.50	Peak
7236.00	45.88	-0.95	44.93	54	-9.07	AVG

Remark :Factor= Antenna Factor + Cable Loss - Pre-amplifier

Vertical:

Frequency (MHz)	Meter Reading (dB $\mu$ V)	Factor (dB)	Emission Level (dB $\mu$ V/m)	Limits (dB $\mu$ V/m)	Margin (dB)	Detector Type
4824.00	56.27	-3.64	52.63	74	-21.37	Peak
4824.00	47.04	-3.64	43.40	54	-10.60	AVG
7236.00	55.43	-0.95	54.48	74	-19.52	Peak
7236.00	45.60	-0.95	44.65	54	-9.35	AVG

Remark :Factor= Antenna Factor + Cable Loss - Pre-amplifier



MID CH6 (802.11n/H20 Mode)/2437

Horizontal:

Frequency (MHz)	Meter Reading (dB $\mu$ V)	Factor (dB)	Emission Level (dB $\mu$ V/m)	Limits (dB $\mu$ V/m)	Margin (dB)	Detector Type
4874.00	56.08	-3.51	52.57	74	-21.43	Peak
4874.00	44.04	-3.51	40.53	54	-13.47	AVG
7311.00	56.54	-0.82	55.72	74	-18.28	Peak
7311.00	44.17	-0.82	43.35	54	-10.65	AVG

Remark :Factor= Antenna Factor + Cable Loss - Pre-amplifier

Vertical:

Frequency (MHz)	Meter Reading (dB $\mu$ V)	Factor (dB)	Emission Level (dB $\mu$ V/m)	Limits (dB $\mu$ V/m)	Margin (dB)	Detector Type
4874.00	55.10	-3.51	51.59	74	-22.41	Peak
4874.00	44.54	-3.51	41.03	54	-12.97	AVG
7311.00	55.35	-0.82	54.53	74	-19.47	Peak
7311.00	45.81	-0.82	44.99	54	-9.01	AVG

Remark :Factor= Antenna Factor + Cable Loss - Pre-amplifier



HIGH CH11 (802.11n/H20 Mode)/2462

Horizontal:

Frequency (MHz)	Meter Reading (dBμV)	Factor (dB)	Emission Level (dBμV/m)	Limits (dBμV/m)	Margin (dB)	Detector Type
4924.00	56.75	-3.43	53.32	74	-20.68	Peak
4924.00	45.65	-3.43	42.22	54	-11.78	AVG
7386.00	56.24	-0.75	55.49	74	-18.51	Peak
7386.00	44.79	-0.75	44.04	54	-9.96	AVG

Remark :Factor= Antenna Factor + Cable Loss - Pre-amplifier

Vertical:

Frequency (MHz)	Meter Reading (dBμV)	Factor (dB)	Emission Level (dBμV/m)	Limits (dBμV/m)	Margin (dB)	Detector Type
4924.00	56.91	-3.43	53.48	74	-20.52	Peak
4924.00	47.28	-3.43	43.85	54	-10.15	AVG
7386.00	54.95	-0.75	54.20	74	-19.80	Peak
7386.00	45.54	-0.75	44.79	54	-9.21	AVG

Remark :Factor= Antenna Factor + Cable Loss - Pre-amplifier

Remark:

- (1) Measuring frequencies from 1 GHz to the 25 GHz.
- (2) "F" denotes fundamental frequency; "H" denotes spurious frequency. "E" denotes band edge frequency.
- (3) \* denotes emission frequency which appearing within the Restricted Bands specified in provision of 15.205, then the general radiated emission limits in 15.209 apply.
- (4) Data of measurement within this frequency range shown "---" in the table above means the reading of emissions are attenuated more than 20dB below the permissible limits or the field strength is too small to be measured.
- (5) The IF bandwidth of EMI Test Receiver between 30MHz to 1GHz was 120KHz, 1 MHz for measuring above 1 GHz, below 30MHz was 10KHz.
- (6) When the test results of Peak Detected below the limits of Average Detected, the Average Detected is not need completed. For example: Top Channel at Fundamental 73.16dBuV/m(PK Value) <93.98(AV Limit), at harmonic 53.20 dBuV/m(PK Value) <54 dBuV/m(AV Limit), the Average Detected not need to completed.



LOW CH3 (802.11n/H40 Mode)/2422

Horizontal:

Frequency (MHz)	Meter Reading (dB $\mu$ V)	Factor (dB)	Emission Level (dB $\mu$ V/m)	Limits (dB $\mu$ V/m)	Margin (dB)	Detector Type
4844.00	55.86	-3.63	52.23	74	-21.77	Peak
4844.00	44.56	-3.63	40.93	54	-13.07	AVG
7266.00	54.94	-0.94	54.00	74	-20.00	Peak
7266.00	45.66	-0.94	44.72	54	-9.28	AVG

Remark :Factor= Antenna Factor + Cable Loss - Pre-amplifier

Vertical:

Frequency (MHz)	Meter Reading (dB $\mu$ V)	Factor (dB)	Emission Level (dB $\mu$ V/m)	Limits (dB $\mu$ V/m)	Margin (dB)	Detector Type
4844.00	56.98	-3.63	53.35	74	-20.65	Peak
4844.00	47.83	-3.63	44.20	54	-9.80	AVG
7266.00	56.65	-0.94	55.71	74	-18.29	Peak
7266.00	44.61	-0.94	43.67	54	-10.33	AVG

Remark :Factor= Antenna Factor + Cable Loss - Pre-amplifier



MID CH6 (802.11n/H40 Mode)/2437

Horizontal:

Frequency (MHz)	Meter Reading (dB $\mu$ V)	Factor (dB)	Emission Level (dB $\mu$ V/m)	Limits (dB $\mu$ V/m)	Margin (dB)	Detector Type
4874.00	56.45	-3.51	52.94	74	-21.06	Peak
4874.00	44.12	-3.51	40.61	54	-13.39	AVG
7311.00	56.15	-0.82	55.33	74	-18.67	Peak
7311.00	44.37	-0.82	43.55	54	-10.45	AVG

Remark :Factor= Antenna Factor + Cable Loss - Pre-amplifier

Vertical:

Frequency (MHz)	Meter Reading (dB $\mu$ V)	Factor (dB)	Emission Level (dB $\mu$ V/m)	Limits (dB $\mu$ V/m)	Margin (dB)	Detector Type
4874.00	55.00	-3.51	51.49	74	-22.51	Peak
4874.00	45.42	-3.51	41.91	54	-12.09	AVG
7311.00	55.09	-0.82	54.27	74	-19.73	Peak
7311.00	44.34	-0.82	43.52	54	-10.48	AVG

Remark :Factor= Antenna Factor + Cable Loss - Pre-amplifier





HIGH CH9 (802.11n/H40 Mode)/2452

Horizontal:

Frequency (MHz)	Meter Reading (dBμV)	Factor (dB)	Emission Level (dBμV/m)	Limits (dBμV/m)	Margin (dB)	Detector Type
4904.00	56.72	-3.43	53.29	74	-20.71	Peak
4904.00	45.93	-3.43	42.50	54	-11.50	AVG
7356.00	56.25	-0.75	55.50	74	-18.50	Peak
7356.00	44.71	-0.75	43.96	54	-10.04	AVG

Remark :Factor= Antenna Factor + Cable Loss - Pre-amplifier

Vertical:

Frequency (MHz)	Meter Reading (dBμV)	Factor (dB)	Emission Level (dBμV/m)	Limits (dBμV/m)	Margin (dB)	Detector Type
4904.00	55.90	-3.43	52.47	74	-21.53	Peak
4904.00	47.80	-3.43	44.37	54	-9.63	AVG
7356.00	55.82	-0.75	55.07	74	-18.93	Peak
7356.00	44.25	-0.75	43.50	54	-10.50	AVG

Remark :Factor= Antenna Factor + Cable Loss - Pre-amplifier

Remark:

- (1) Measuring frequencies from 1 GHz to the 25 GHz.
- (2) "F" denotes fundamental frequency; "H" denotes spurious frequency. "E" denotes band edge frequency.
- (3) \* denotes emission frequency which appearing within the Restricted Bands specified in provision of 15.205, then the general radiated emission limits in 15.209 apply.
- (4) Data of measurement within this frequency range shown "---" in the table above means the reading of emissions are attenuated more than 20dB below the permissible limits or the field strength is too small to be measured.
- (5) The IF bandwidth of EMI Test Receiver between 30MHz to 1GHz was 120KHz, 1 MHz for measuring above 1 GHz, below 30MHz was 10KHz.
- (6) When the test results of Peak Detected below the limits of Average Detected, the Average Detected is not need completed. For example: Top Channel at Fundamental 73.16dBuV/m(PK Value) <93.98(AV Limit), at harmonic 53.20 dBuV/m(PK Value) <54 dBuV/m(AV Limit), the Average Detected not need to completed.

**Test Result of Radiated Spurious at Band edges**

Operation Mode:  
802.11b Mode TX CH Low (2412MHz)

Horizontal

Frequency (MHz)	Meter Reading (dB $\mu$ V)	Factor (dB)	Emission Level (dB $\mu$ V/m)	Limits (dB $\mu$ V/m)	Margin (dB)	Detector Type
2310	56.76	-5.81	50.95	74	-23.05	Peak
2310	45.36	-5.81	39.55	54	-14.45	AVG
2390	57.26	-5.84	51.42	74	-22.58	Peak
2390	46.19	-5.84	40.35	54	-13.65	AVG
2400	57.05	-5.84	51.21	74	-22.79	Peak
2400	45.42	-5.84	39.58	54	-14.42	AVG

Remark :Factor= Antenna Factor + Cable Loss - Pre-amplifier

Vertical:

Frequency (MHz)	Meter Reading (dB $\mu$ V)	Factor (dB)	Emission Level (dB $\mu$ V/m)	Limits (dB $\mu$ V/m)	Margin (dB)	Detector Type
2310	58.39	-5.81	52.58	74	-21.42	Peak
2310	44.09	-5.81	38.28	54	-15.72	AVG
2390	57.75	-5.84	51.91	74	-22.09	Peak
2390	45.41	-5.84	39.57	54	-14.43	AVG
2400	56.26	-5.84	50.42	74	-23.58	Peak
2400	45.55	-5.84	39.71	54	-14.29	AVG

Remark :Factor= Antenna Factor + Cable Loss - Pre-amplifier



Operation Mode: TX CH High (2462MHz)

## Horizontal

Frequency (MHz)	Meter Reading (dB $\mu$ V)	Factor (dB)	Emission Level (dB $\mu$ V/m)	Limits (dB $\mu$ V/m)	Margin (dB)	Detector Type
2483.5	57.48	-6.04	51.44	74	-22.56	Peak
2483.5	46.82	-6.04	40.78	54	-13.22	AVG
2500	57.22	-6.06	51.16	74	-22.84	Peak
2500	46.07	-6.06	40.01	54	-13.99	AVG

Remark :Factor= Antenna Factor + Cable Loss - Pre-amplifier

## Vertical:

Frequency (MHz)	Meter Reading (dB $\mu$ V)	Factor (dB)	Emission Level (dB $\mu$ V/m)	Limits (dB $\mu$ V/m)	Margin (dB)	Detector Type
2483.5	56.22	-6.04	50.18	74	-23.82	Peak
2483.5	46.21	-6.04	40.17	54	-13.83	AVG
2500	56.40	-6.06	50.34	74	-23.66	Peak
2500	45.59	-6.06	39.53	54	-14.47	AVG

Remark :Factor= Antenna Factor + Cable Loss - Pre-amplifier



Operation Mode: 802.11g Mode TX CH Low (2412MHz)

## Horizontal

Frequency (MHz)	Meter Reading (dB $\mu$ V)	Factor (dB)	Emission Level (dB $\mu$ V/m)	Limits (dB $\mu$ V/m)	Margin (dB)	Detector Type
2310	55.03	-5.81	49.22	74	-24.78	Peak
2310	43.63	-5.81	37.82	54	-16.18	AVG
2390	56.93	-5.84	51.09	74	-22.91	Peak
2390	46.63	-5.84	40.79	54	-13.21	AVG
2400	56.35	-5.84	50.51	74	-23.49	Peak
2400	45.29	-5.84	39.45	54	-14.55	AVG

Remark :Factor= Antenna Factor + Cable Loss - Pre-amplifier

## Vertical:

Frequency (MHz)	Meter Reading (dB $\mu$ V)	Factor (dB)	Emission Level (dB $\mu$ V/m)	Limits (dB $\mu$ V/m)	Margin (dB)	Detector Type
2310	55.16	-5.81	49.35	74	-24.65	Peak
2310	45.26	-5.81	39.45	54	-14.55	AVG
2390	56.77	-5.84	50.93	74	-23.07	Peak
2390	45.13	-5.84	39.29	54	-14.71	AVG
2400	56.87	-5.84	51.03	74	-22.97	Peak
2400	46.58	-5.84	40.74	54	-13.26	AVG

Remark :Factor= Antenna Factor + Cable Loss - Pre-amplifier



Operation Mode: TX CH High (2462MHz)

## Horizontal

Frequency (MHz)	Meter Reading (dB $\mu$ V)	Factor (dB)	Emission Level (dB $\mu$ V/m)	Limits (dB $\mu$ V/m)	Margin (dB)	Detector Type
2483.5	56.82	-6.04	50.78	74	-23.22	Peak
2483.5	46.04	-6.04	40.00	54	-14.00	AVG
2500	57.07	-6.06	51.01	74	-22.99	Peak
2500	45.58	-6.06	39.52	54	-14.48	AVG

Remark :Factor= Antenna Factor + Cable Loss - Pre-amplifier

## Vertical:

Frequency (MHz)	Meter Reading (dB $\mu$ V)	Factor (dB)	Emission Level (dB $\mu$ V/m)	Limits (dB $\mu$ V/m)	Margin (dB)	Detector Type
2483.5	57.29	-6.04	51.25	74	-22.75	Peak
2483.5	45.17	-6.04	39.13	54	-14.87	AVG
2500	56.50	-6.06	50.44	74	-23.56	Peak
2500	45.10	-6.06	39.04	54	-14.96	AVG

Remark :Factor= Antenna Factor + Cable Loss - Pre-amplifier



Operation Mode: 802.11n/H20 Mode TX CH Low (2412MHz)

## Horizontal

Frequency (MHz)	Meter Reading (dB $\mu$ V)	Factor (dB)	Emission Level (dB $\mu$ V/m)	Limits (dB $\mu$ V/m)	Margin (dB)	Detector Type
2310	55.41	-5.81	49.60	74	-24.40	Peak
2310	44.88	-5.81	39.07	54	-14.93	AVG
2390	57.31	-5.84	51.47	74	-22.53	Peak
2390	46.13	-5.84	40.29	54	-13.71	AVG
2400	57.67	-5.84	51.83	74	-22.17	Peak
2400	46.09	-5.84	40.25	54	-13.75	AVG

Remark :Factor= Antenna Factor + Cable Loss - Pre-amplifier

## Vertical:

Frequency (MHz)	Meter Reading (dB $\mu$ V)	Factor (dB)	Emission Level (dB $\mu$ V/m)	Limits (dB $\mu$ V/m)	Margin (dB)	Detector Type
2310	56.08	-5.81	50.27	74	-23.73	Peak
2310	44.85	-5.81	39.04	54	-14.96	AVG
2390	57.34	-5.84	51.50	74	-22.50	Peak
2390	45.88	-5.84	40.04	54	-13.96	AVG
2400	57.96	-5.84	52.12	74	-21.88	Peak
2400	45.89	-5.84	40.05	54	-13.95	AVG

Remark :Factor= Antenna Factor + Cable Loss - Pre-amplifier





Operation Mode: TX CH High (2462MHz)

## Horizontal

Frequency (MHz)	Meter Reading (dB $\mu$ V)	Factor (dB)	Emission Level (dB $\mu$ V/m)	Limits (dB $\mu$ V/m)	Margin (dB)	Detector Type
2483.5	56.70	-6.04	50.66	74	-23.34	Peak
2483.5	45.83	-6.04	39.79	54	-14.21	AVG
2500	57.66	-6.06	51.60	74	-22.40	Peak
2500	45.58	-6.06	39.52	54	-14.48	AVG

Remark :Factor= Antenna Factor + Cable Loss - Pre-amplifier

## Vertical:

Frequency (MHz)	Meter Reading (dB $\mu$ V)	Factor (dB)	Emission Level (dB $\mu$ V/m)	Limits (dB $\mu$ V/m)	Margin (dB)	Detector Type
2483.5	57.29	-6.04	51.25	74	-22.75	Peak
2483.5	45.44	-6.04	39.40	54	-14.60	AVG
2500	55.98	-6.06	49.92	74	-24.08	Peak
2500	46.04	-6.06	39.98	54	-14.02	AVG

Remark :Factor= Antenna Factor + Cable Loss - Pre-amplifier



Operation Mode: 802.11n/H40 Mode TX CH Low (2422MHz)

## Horizontal

Frequency (MHz)	Meter Reading (dB $\mu$ V)	Factor (dB)	Emission Level (dB $\mu$ V/m)	Limits (dB $\mu$ V/m)	Margin (dB)	Detector Type
2310	55.75	-5.81	49.94	74	-24.06	Peak
2310	43.60	-5.81	37.79	54	-16.21	AVG
2390	57.19	-5.84	51.35	74	-22.65	Peak
2390	46.86	-5.84	41.02	54	-12.98	AVG
2400	57.96	-5.84	52.12	74	-21.88	Peak
2400	46.46	-5.84	40.62	54	-13.38	AVG

Remark :Factor= Antenna Factor + Cable Loss - Pre-amplifier

## Vertical:

Frequency (MHz)	Meter Reading (dB $\mu$ V)	Factor (dB)	Emission Level (dB $\mu$ V/m)	Limits (dB $\mu$ V/m)	Margin (dB)	Detector Type
2310	57.59	-5.81	51.78	74	-22.22	Peak
2310	43.81	-5.81	38.00	54	-16.00	AVG
2390	56.68	-5.84	50.84	74	-23.16	Peak
2390	46.38	-5.84	40.54	54	-13.46	AVG
2400	57.40	-5.84	51.56	74	-22.44	Peak
2400	45.62	-5.84	39.78	54	-14.22	AVG

Remark :Factor= Antenna Factor + Cable Loss - Pre-amplifier



Operation Mode: TX CH High (2452MHz)

## Horizontal

Frequency	Meter Reading	Factor	Emission Level	Limits	Margin	Detector Type
(MHz)	(dB $\mu$ V)	(dB)	(dB $\mu$ V/m)	(dB $\mu$ V/m)	(dB)	
2483.5	57.09	-6.04	51.05	74	-22.95	Peak
2483.5	45.74	-6.04	39.70	54	-14.30	AVG
2500	57.16	-6.06	51.10	74	-22.90	Peak
2500	46.20	-6.06	40.14	54	-13.86	AVG

Remark :Factor= Antenna Factor + Cable Loss - Pre-amplifier

## Vertical:

Frequency	Meter Reading	Factor	Emission Level	Limits	Margin	Detector Type
(MHz)	(dB $\mu$ V)	(dB)	(dB $\mu$ V/m)	(dB $\mu$ V/m)	(dB)	
2483.5	57.87	-6.04	51.83	74	-22.17	Peak
2483.5	46.40	-6.04	40.36	54	-13.64	AVG
2500	56.33	-6.06	50.27	74	-23.73	Peak
2500	45.87	-6.06	39.81	54	-14.19	AVG

Remark :Factor= Antenna Factor + Cable Loss - Pre-amplifier



## 4.7. ANTENNA REQUIREMENT

### Standard Applicable

For intentional device, according to FCC 47 CFR Section 15.203, an intentional radiator shall be designed to ensure that no antenna other than that furnished by the responsible party shall be used with the device. And according to FCC 47 CFR Section 15.247, if transmitting antennas of directional gain greater than 6dBi are used, the power shall be reduced by the amount in dB that the directional gain of the antenna exceeds 6dBi.

### Refer to statement below for compliance.

The manufacturer may design the unit so that the user can replace a broken antenna, but the use of a standard antenna jack or electrical connector is prohibited. Further, this requirement does not apply to intentional radiators that must be professionally installed.

### Antenna Connected Construction

The antenna used in this product is a Glue stick Antenna, The directional gains of antenna used for transmitting is 2dBi.

### WIFI ANTENNA



#### 4.8. PHOTOGRAPH OF TEST

30MHz-1000MHz



Above 1000MHz

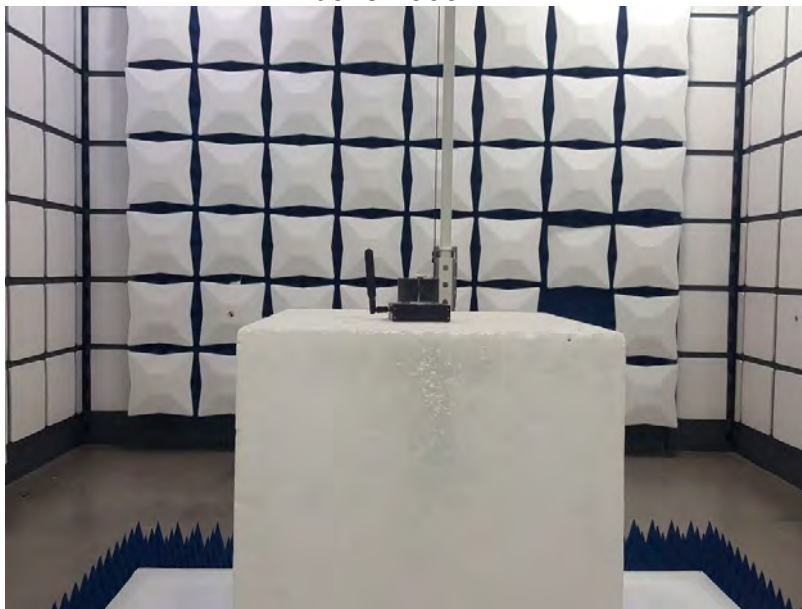



### Conducted Emission

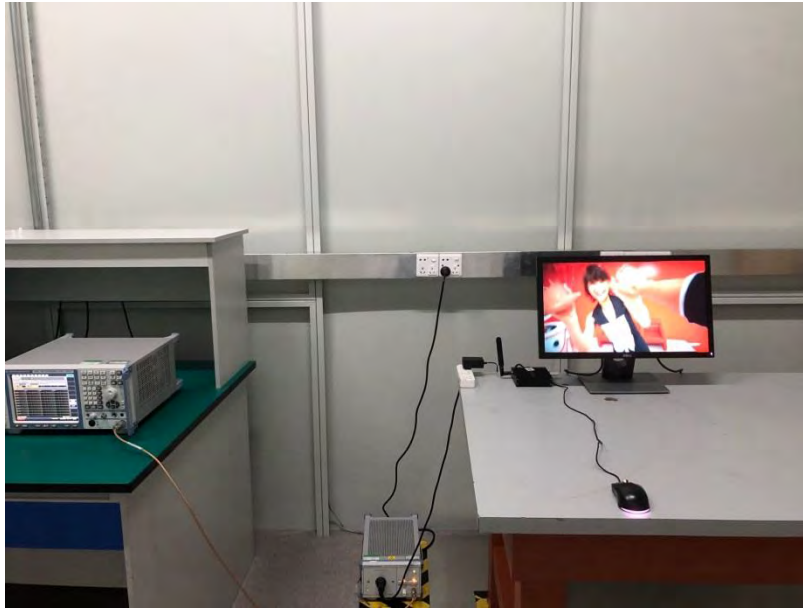



## 5. PHOTOS OF THE EUT

### External photos

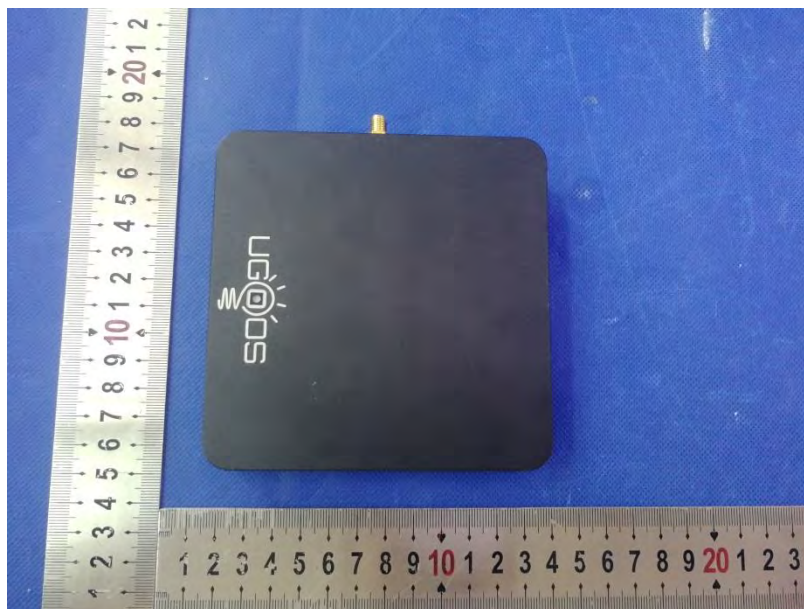

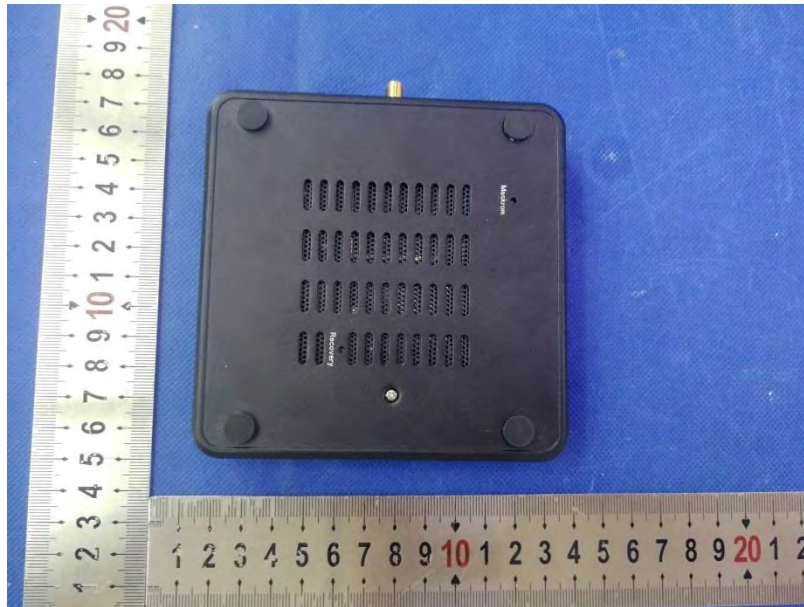







**Internal photos**

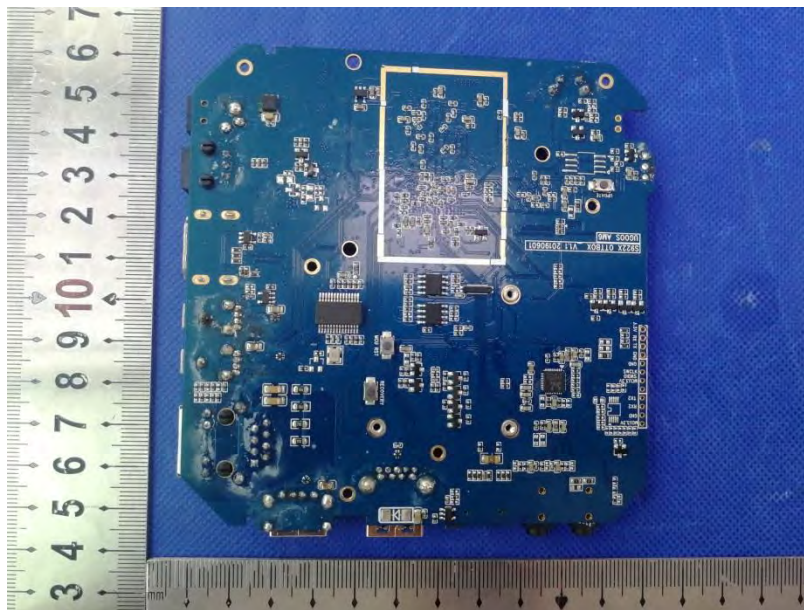
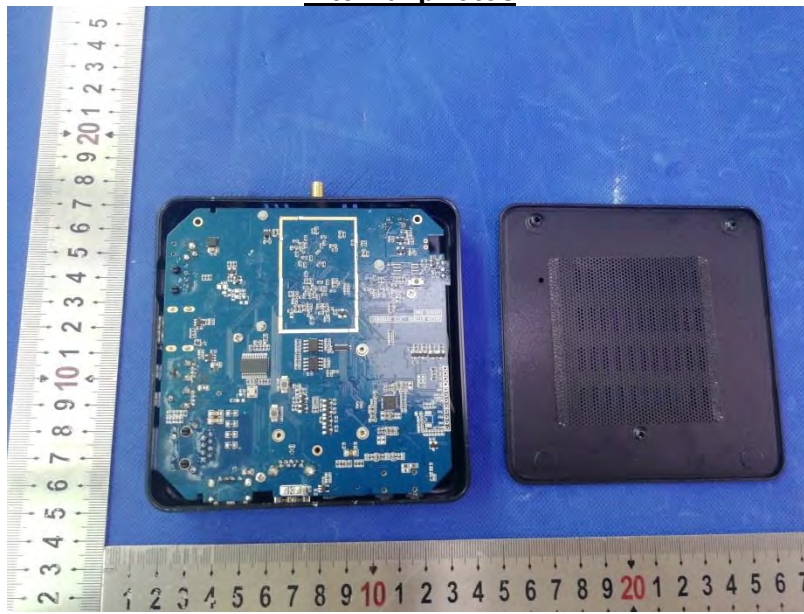

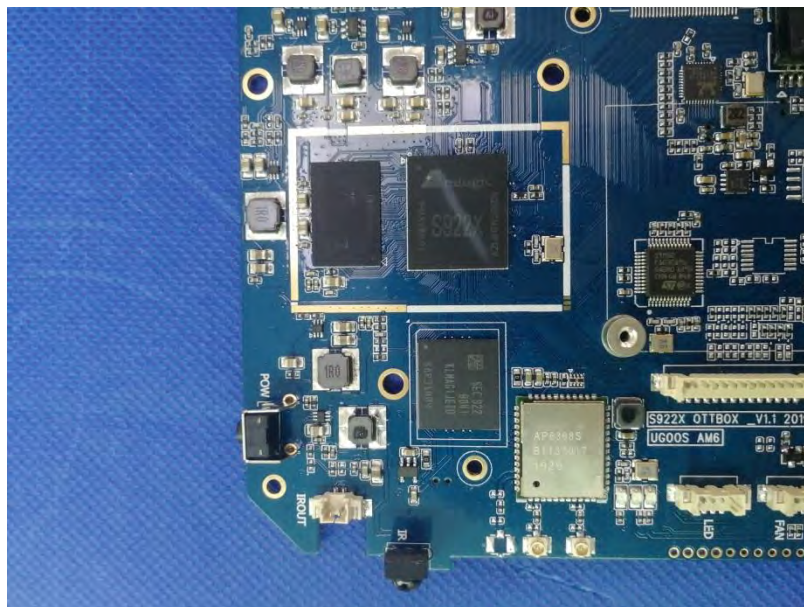
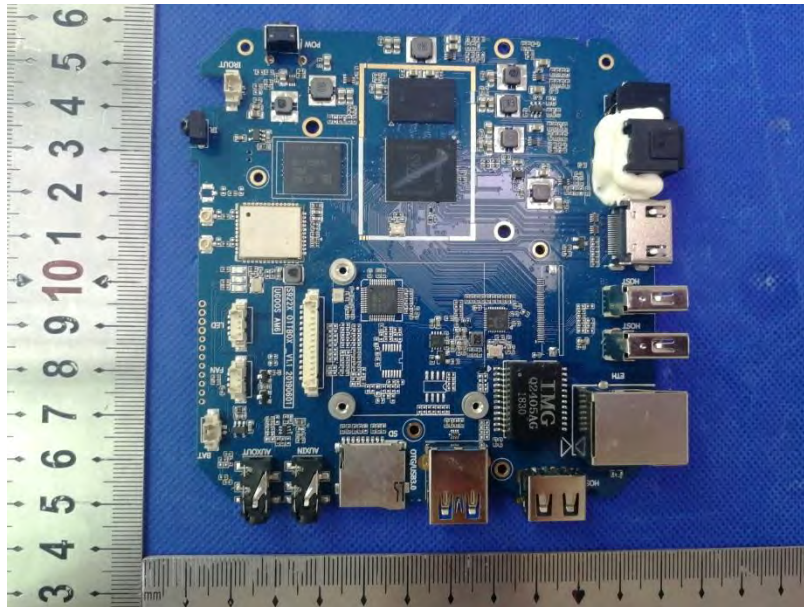

END