承认书

Antenna Data Sheet

天线制造商：宇视

Antenna Manufacturer: Zhejiang Uniview Technologies Co., Ltd.

Address: Zhejiang Uniview Technologies Co., Ltd.

产品名称：2.4G PCB板载天线

Product Name: 2.4G PCB Antenna

天线型号：0302C5N7

Antenna Model: 0302C5N7

1、规格表(Specifications)

主要技术指标		Main technical specifications	
频率范围(MHz)	2400~2500	Frequency Range (MHZ)	2400~2500
特性阻抗(Ω)	50	Impedance(Ω)	50
峰值增益(dBi)	2.29	Peak Gain(dBi)	2.29
反射系数(dB)	≤ -10	S11(dB)	≤ -10
物理性能		Physical Properties	
天线本体材料	PCB	Antenna Base	PCB

2、成品图(Antenna Dimensions)

Antenna Dimensions: 13.5mm*11.5mm

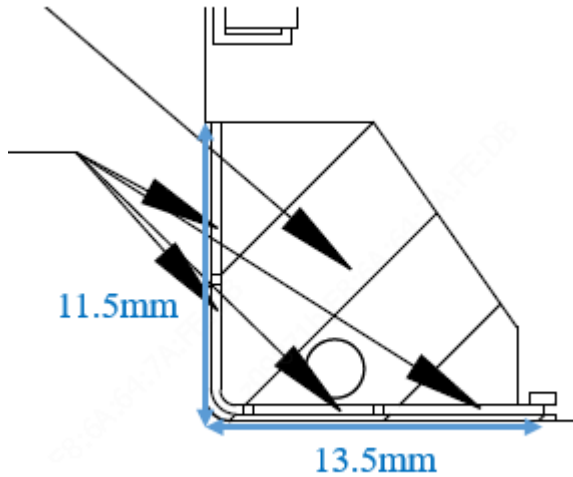

3、测试报告(performance testing)

3.1 Return Loss&VSWR

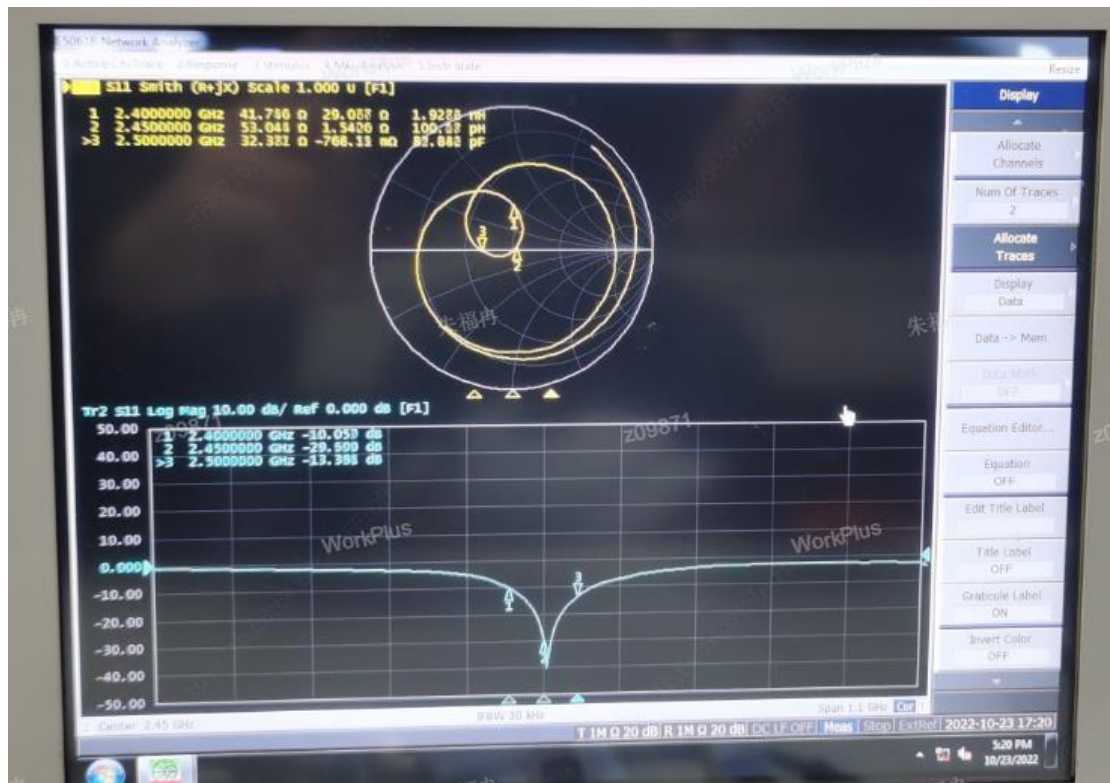

3.2 暗室 2D、3D Raditation Pattern

3.2.1 Efficiency&Gain

Frequency / MHz	Efficiency / %	Gain/ dBi
2400	57.15	1.2
2410	56.49	1.54
2420	56.36	1.75
2430	57.28	1.7
2440	58.48	1.79
2450	58.75	1.72
2460	57.81	1.89
2470	57.28	2.15
2480	55.85	2.2
2490	54.95	2.29
2500	52.12	1.78

3.2.2 2D、3D Raditation Pattern

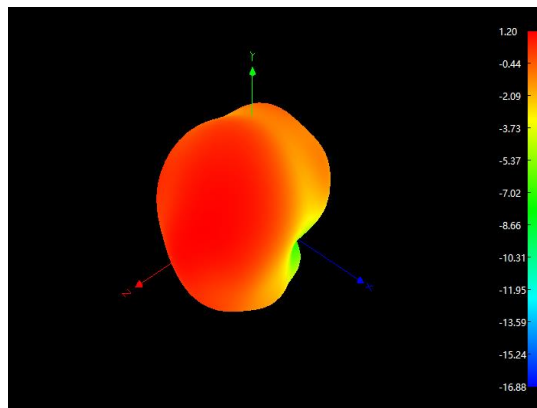

2400MHz

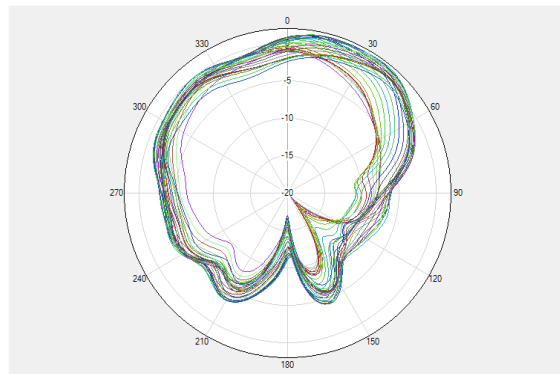

PHI=0 2D

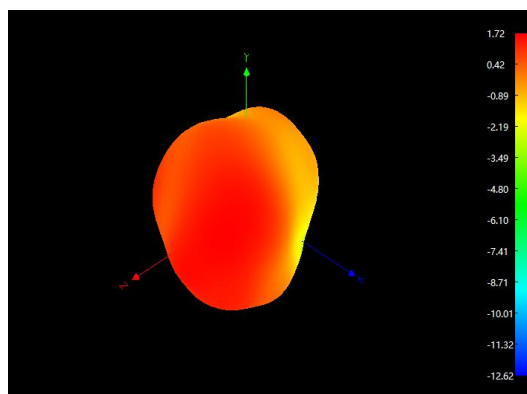

2450MHz

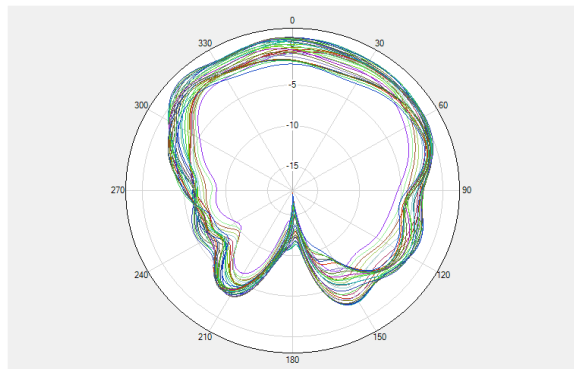

PHI=90 2D

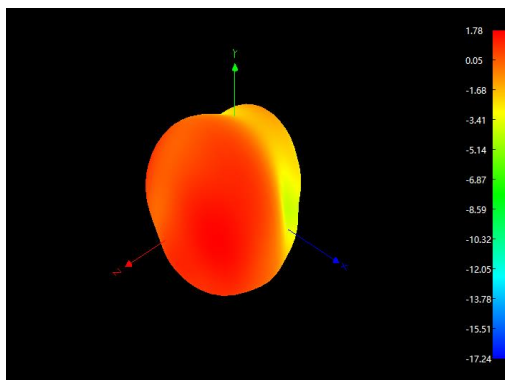

2500MHz

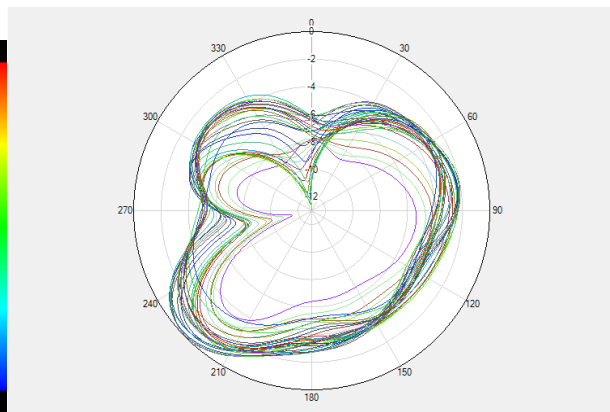

THETA=90 2D

4、天线实物图(Antenna Photo)

