



产品规格承认书

Specification For Approval

客户名称: 浙江宇视科技有限公司
Customer Zhejiang Uniview Technologies Co., Ltd.

供应商: 广州市高科中实通信技术有限公司
Supplier Gaoke Ant Co., Ltd.

客户料号: 2701C02Y
Customer P/N

产品名称: 2.4G 棒状天线
Production Name 2.4G Dipole Antenna

产品型号: GKZS-2.4G-98B-RF1.13I-150
Production Number

供应商确认盖章 (Supplier Signature)

工程师 Engineer	审核 Checked by	批准 Approved by
黄裕明	谢倩菊	杨敬松
2023 年 10 月 21 日	2023 年 10 月 21 日	2023 年 10 月 21 日

客户确认盖章 (Customer Signature)

工程师 Engineer	审核 Checked by	批准 Approved by
年 月 日	年 月 日	年 月 日

Company: Gaoke Ant Co., Ltd.
Address: No. 22 Shengang Guangcong South Road, Conghua District, Guangzhou City,
Guangdong Province, China
Tel: 020-87080630/87080639/87080632
Fax: 020-87080731
<http://www.gkzs.com.cn>

变更履历表

Description Record

版本 Version	修改内容 Content Revised	创建者 Modifier	日期 Date
A/0	初始新建	谢倩菊	2023. 08. 29
A/1	增加防水等级要求	谢倩菊	2023. 10. 21

一、结构尺寸图(Dimensions): (单位(Unit): mm)

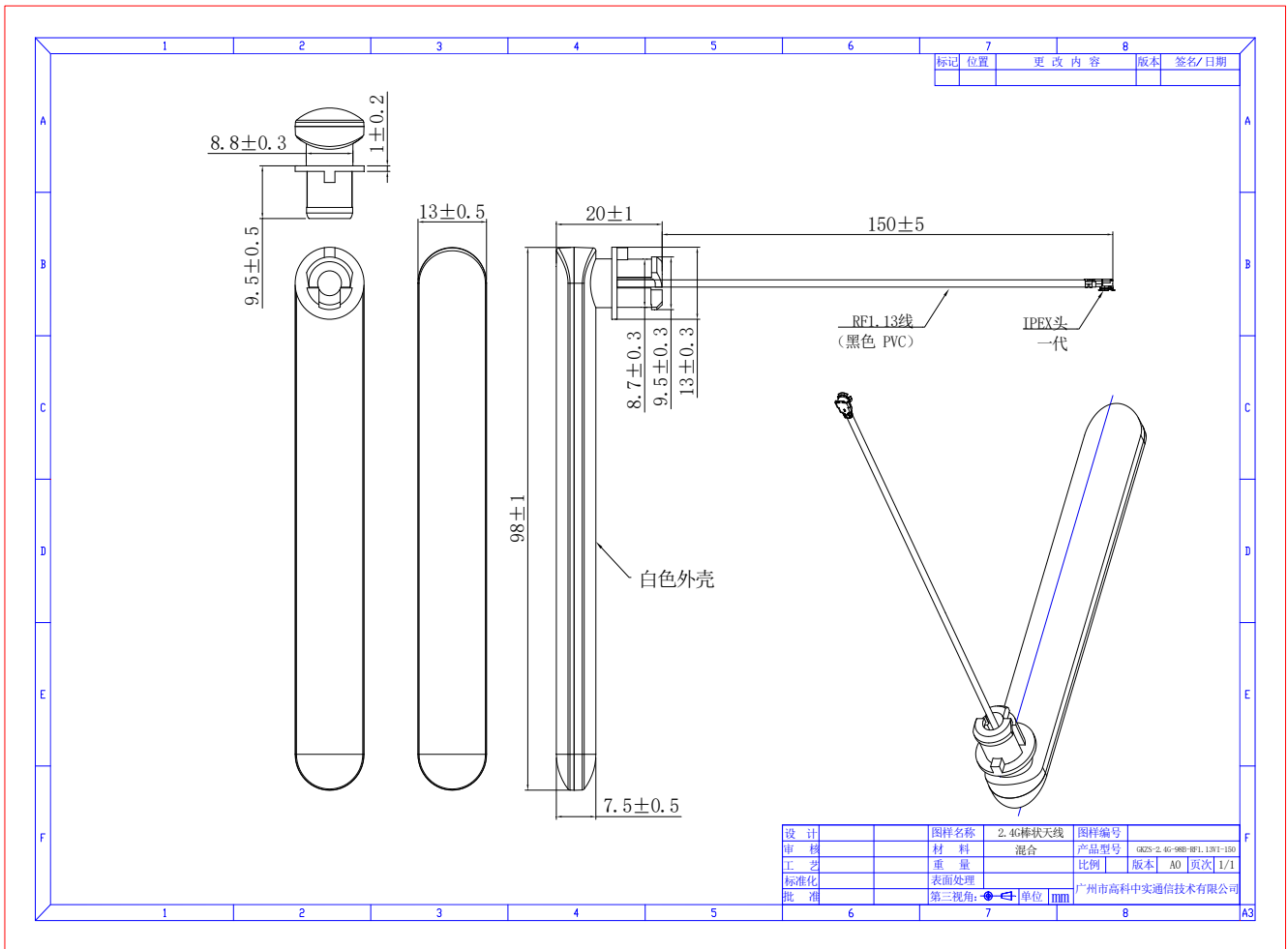

二、实物图 (Antenna Photo)

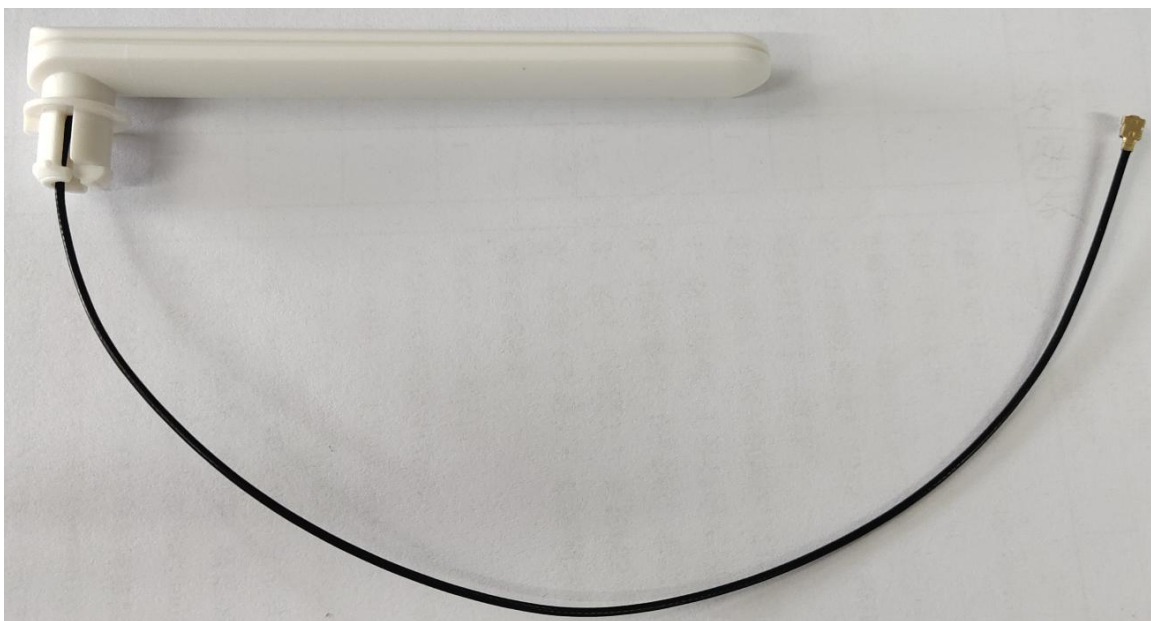



三、天线技术参数(Specifications)

Design Specifications	Typical
天线形式(Antenna Type)	棒状天线(Dipole Antenna)
工作频率(working Frequency)	2400-2500MHz
增益 (Gain)	2.80dBi (peak) 、2.43dBi (average)
天线效率 (Antenna efficiency)	≥40%
电压驻波比 (VSWR)	≤1.8
极化方式(Polarization)	线极化(linear polarization)
辐射方向(Radiation pattern)	全向(Omnidirectional)
馈电阻抗(impedance)	50Ω
天线接口(Interface)	IPEX Length: 150mm
天线尺寸(Overall dimensions)	98x20x13mm
防水等级 (Waterproof grade)	IP67
重量(Weight)	≤10g
外壳颜色 (Color)	White
盐雾等级 (Salt spray grade)	48H
工作温度(Operatin Temp)	-40°C~80°C

四、性能测试图 (performance testing)

1、回波损耗(Return Loss)

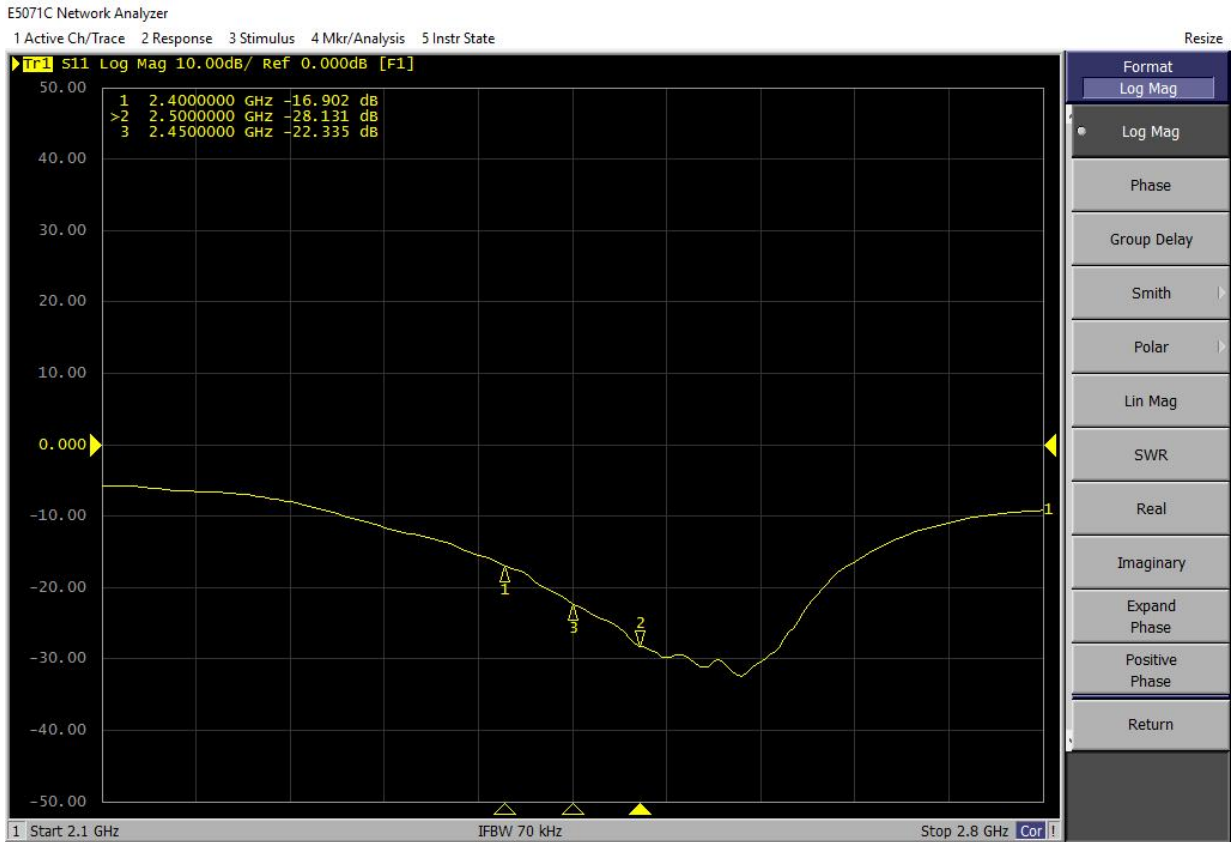

2、驻波比 (VSWR)

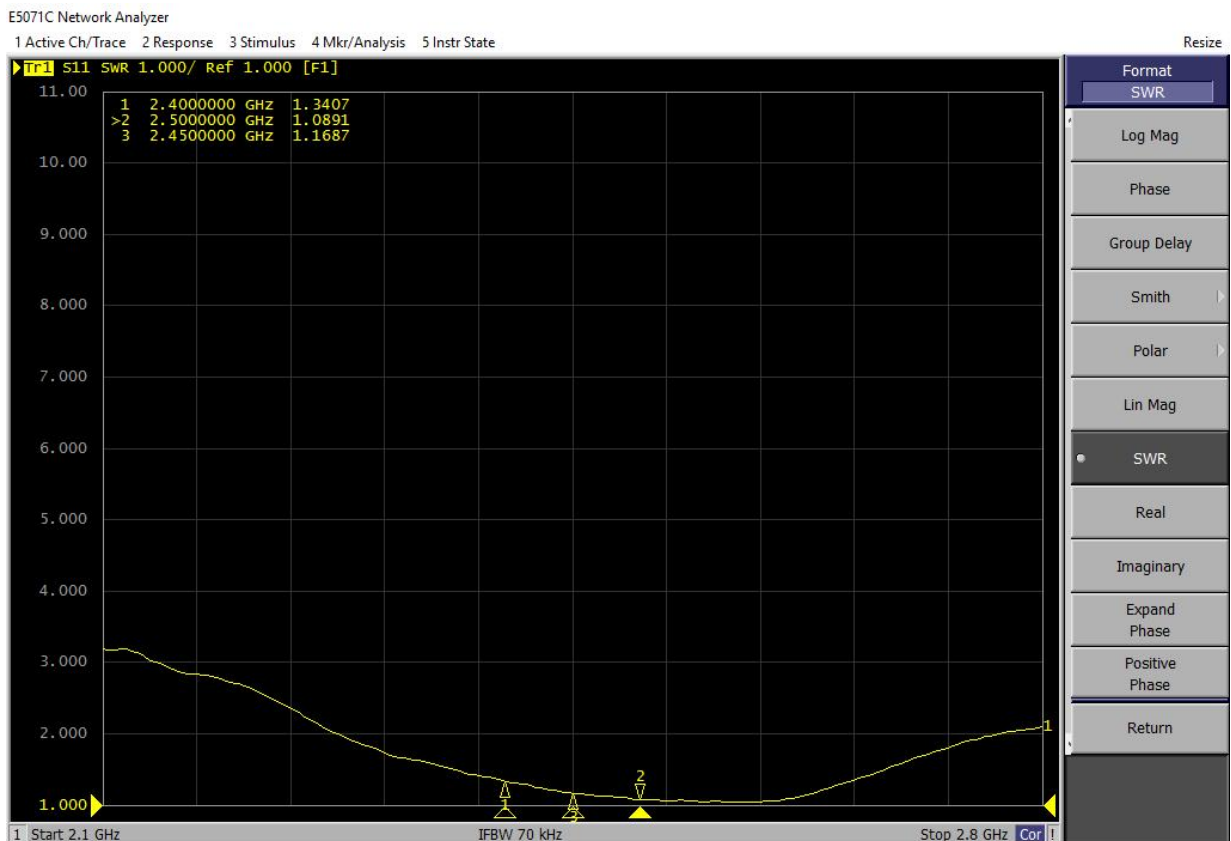

微波暗室检测 (Microwave darkroom detection)

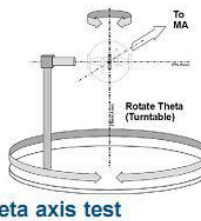
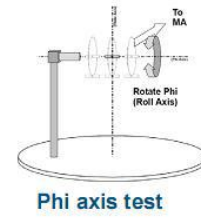
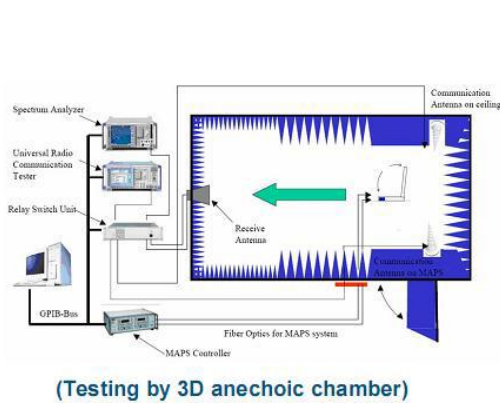

3、Radiation Pattern (2D or 3D)

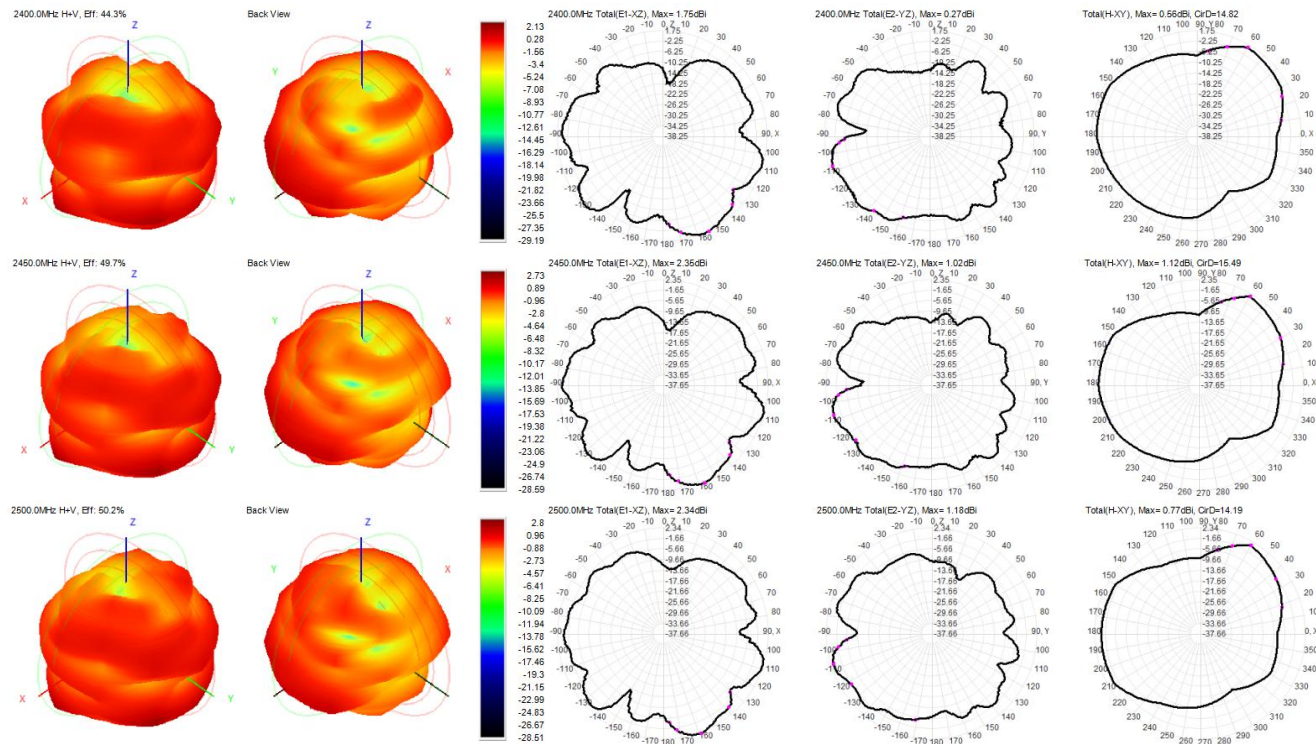



4、效率图(Efficiency chart)

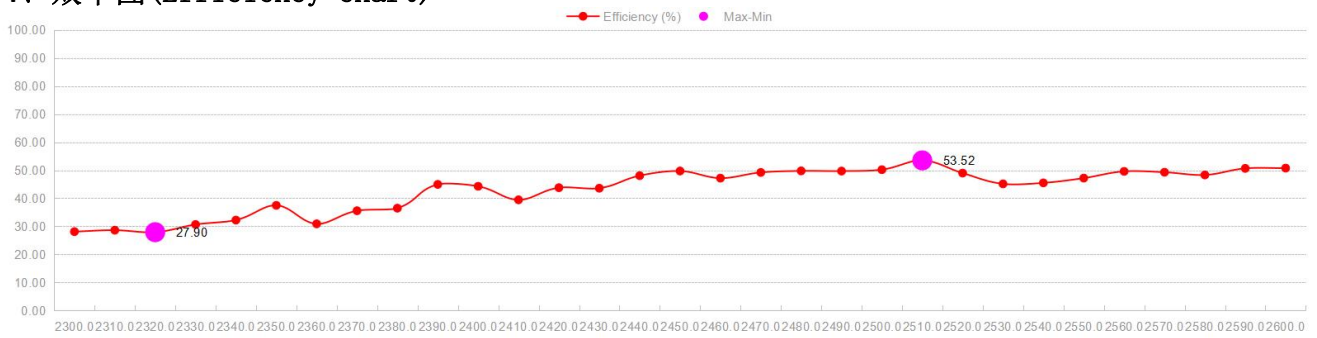

5、增益图(Gain chart)

