Antenna Data Sheet

Antenna Manufacturer: Zhejiang Uniview Technologies Co., Ltd.

Address: No. 369, Xietong Road, Xixing Sub-district, Binjiang District,

Hangzhou City, 310051, Zhejiang Province, China

Product Name: 2.4G PCB on-board antenna

Model Number: 0302C56V

1、规格表 (Specifications)

主要技术指标		Main technical specifications	
频率范围(MHz)	2400~2500	Frequency Range (MHZ)	2400~2500
特性阻抗(Ω)	50	Impedance(Ω)	50
峰值增益(dBi)	2.29	Peak Gain(dBi)	2.29
反射系数(dB)	≤ -10	S11(dB)	≤ -10
物理性能		Physical Properties	
天线本体材料	PCB	Antenna Base	PCB

2、成品图 (Antenna Drawing)

Dimension: 13.5mm*11.5mm

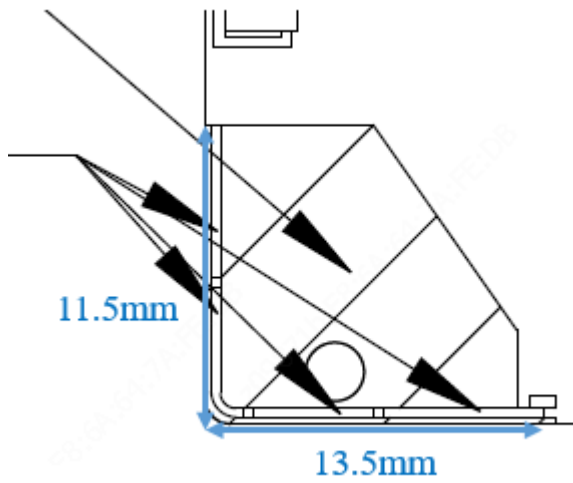

3、测试报告 (Test Report)

3.1 网络分析仪测试报告 (Network Analyzer Test Report)

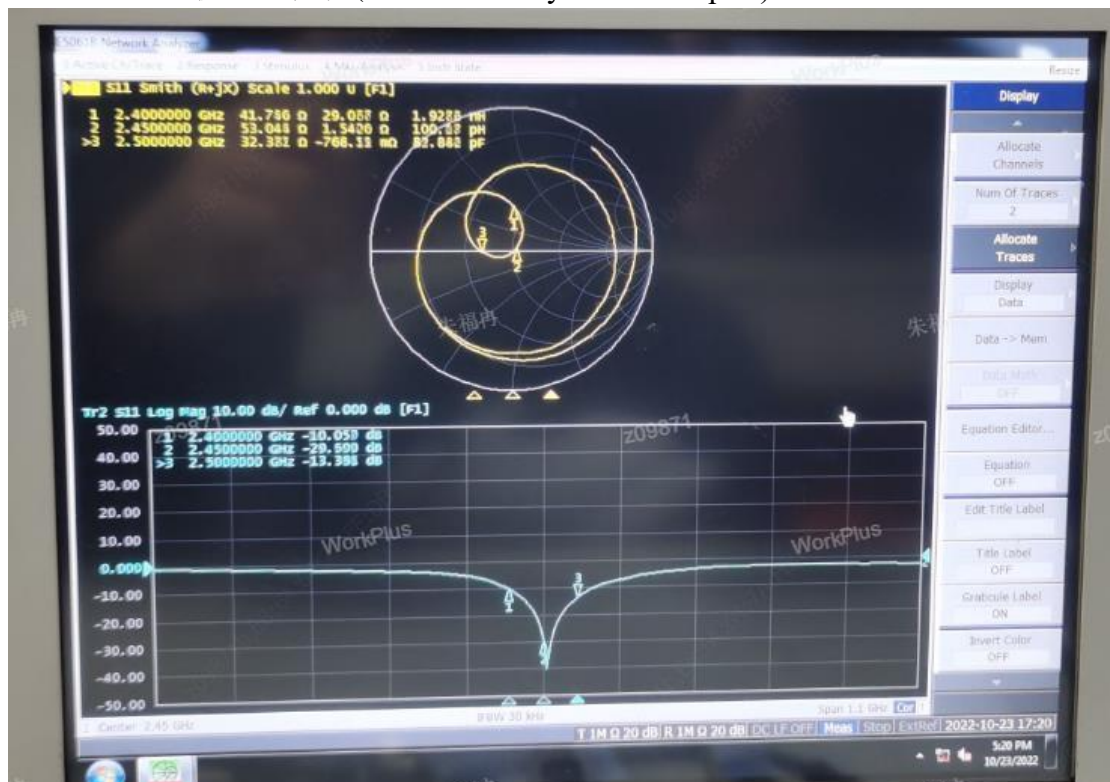

3.2 天线数据(Antenna Data)

3.2.1 效率及增益 (Efficiency&Gain)

Frequency / MHz	Efficiency / %	Gain/ dB
2400	57.15	1.2
2410	56.49	1.54
2420	56.36	1.75
2430	57.28	1.7
2440	58.48	1.79
2450	58.75	1.72
2460	57.81	1.89
2470	57.28	2.15
2480	55.85	2.2
2490	54.95	2.29
2500	52.12	1.78

3.2.2 2D、3D Raditation Pattern

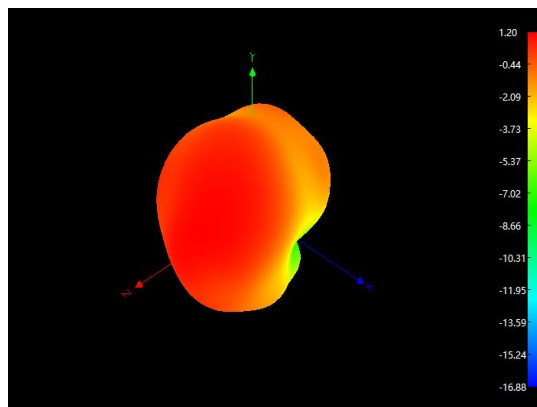

2400MHz

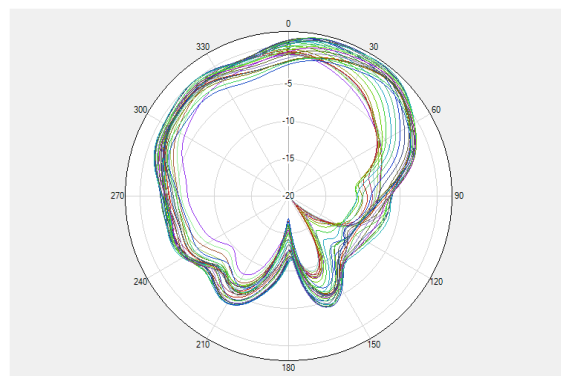

PHI=0 2D

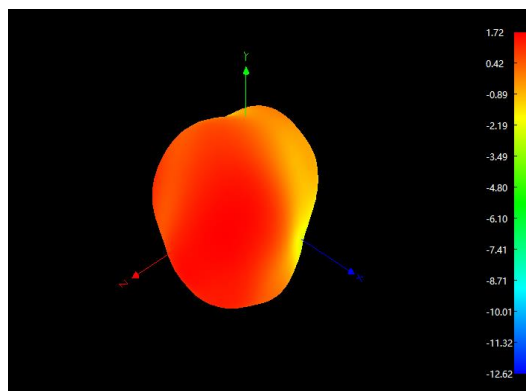

2450MHz

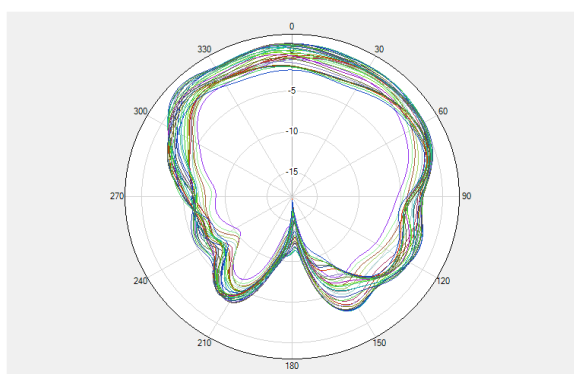

PHI=90 2D

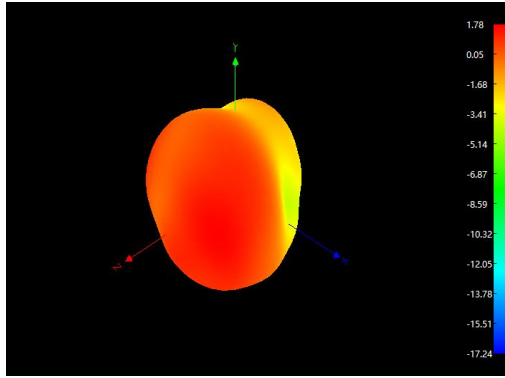

2500MHz

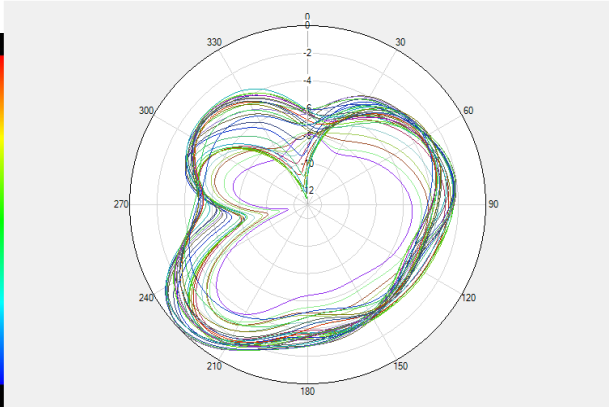

THETA=90 2D