



**FCC 47 CFR PART 15 SUBPART C**

**TEST REPORT**

*For*

**Villa Door Station**

**MODEL NUMBER: OEU-201B-HMK-W**

**ADDITIONAL MODEL NUMBER:**

**OEU-201B-HMK-W -xxxxxxxx-yyy-yyyyy-zzz,**

**OEU-201S-HMK-W -xxxxxxxx-yyy-yyyyy-zzz**

**("x", "y", "z" can be 0-9, A-Z, a-z or blank, - may be blank)**

**PROJECT NUMBER: 4790904051**

**REPORT NUMBER: 4790904051-1**

**FCC ID: 2AL8S-0235C7C6**

**ISSUE DATE: Jul. 26, 2023**

*Prepared for*

**ZHEJIANG UNIVIEW TECHNOLOGIES CO., LTD.**

*Prepared by*

**UL-CCIC COMPANY LIMITED**

**No. 2, Chengwan Road, Suzhou Industrial Park, Suzhou 215122, China**

**Tel: +86 512-6808 6400**

**Fax: +86 512-6808 4099**

**Website: www.ul.com**

Form-ULID-008536-9 V3.0

The results reported herein have been performed in accordance with the laboratory's terms of accreditation. This report shall not be reproduced except in full without the written approval of the Laboratory. The results in this report apply to the test sample(s) mentioned above at the time of the testing period only and are not to be used to indicate applicability to other similar products.

Revision History

<u>Rev.</u>	<u>Issue Date</u>	<u>Revisions</u>	<u>Revised By</u>
V0	07/26/2023	Initial Issue	

## TABLE OF CONTENTS

<b>1. APPLICANT INFORMATION .....</b>	<b>4</b>
<b>2. TEST METHODOLOGY .....</b>	<b>6</b>
<b>3. FACILITIES AND ACCREDITATION .....</b>	<b>6</b>
<b>4. CALIBRATION AND UNCERTAINTY .....</b>	<b>7</b>
4.1. <i>MEASURING INSTRUMENT CALIBRATION.....</i>	<i>7</i>
4.2. <i>MEASUREMENT UNCERTAINTY .....</i>	<i>7</i>
<b>5. EQUIPMENT UNDER TEST .....</b>	<b>8</b>
5.1. <i>DESCRIPTION OF EUT .....</i>	<i>8</i>
5.2. <i>MAXIMUM OUTPUT POWER .....</i>	<i>9</i>
5.3. <i>CHANNEL LIST .....</i>	<i>9</i>
5.4. <i>TEST CHANNEL CONFIGURATION .....</i>	<i>9</i>
5.5. <i>THE WORSE CASE POWER SETTING PARAMETER.....</i>	<i>9</i>
5.6. <i>DESCRIPTION OF AVAILABLE ANTENNAS .....</i>	<i>10</i>
5.7. <i>THE WORSE CASE CONFIGURATIONS.....</i>	<i>10</i>
5.8. <i>TEST ENVIRONMENT .....</i>	<i>10</i>
5.9. <i>DESCRIPTION OF TEST SETUP .....</i>	<i>11</i>
5.10. <i>MEASURING INSTRUMENT AND SOFTWARE USED.....</i>	<i>13</i>
<b>6. MEASUREMENT METHODS .....</b>	<b>14</b>
<b>7. ANTENNA PORT TEST RESULTS.....</b>	<b>15</b>
7.1. <i>ON TIME AND DUTY CYCLE .....</i>	<i>15</i>
7.2. <i>6 dB BANDWIDTH.....</i>	<i>18</i>
7.3. <i>CONDUCTED OUTPUT POWER.....</i>	<i>25</i>
7.4. <i>POWER SPECTRAL DENSITY.....</i>	<i>27</i>
7.5. <i>CONDUCTED BANDEDGE AND SPURIOUS EMISSIONS .....</i>	<i>34</i>
<b>8. RADIATED TEST RESULTS.....</b>	<b>55</b>
8.1. <i>LIMITS AND PROCEDURE.....</i>	<i>55</i>
8.2. <i>TEST ENVIRONMENT .....</i>	<i>61</i>
8.3. <i>RESTRICTED BANDEDGE.....</i>	<i>61</i>
8.4. <i>SPURIOUS EMISSIONS .....</i>	<i>74</i>
<b>9. AC POWER LINE CONDUCTED EMISSIONS .....</b>	<b>118</b>
<b>10. ANTENNA REQUIREMENTS.....</b>	<b>122</b>

# 1. APPLICANT INFORMATION

## Applicant Information

Company Name: ZHEJIANG UNIVIEW TECHNOLOGIES CO., LTD.  
Address: No. 369, Xietong Road, Xixing Sub-district, Binjiang District, Hangzhou City, 310051, Zhejiang Province, China

## Manufacturer Information

Company Name: ZHEJIANG UNIVIEW TECHNOLOGIES CO., LTD.  
Address: No. 369, Xietong Road, Xixing Sub-district, Binjiang District, Hangzhou City, 310051, Zhejiang Province, China

## Factory Information-1

Company Name: Zhejiang Uniview System Technology Co., Ltd.  
Address: No.1277 Qingfeng South Road (South), Tongxiang Economic Development Zone, Tongxiang City, Jiaxing City, 314500, Zhejiang, China

## Factory Information-2

Company Name: TDG Technology Co., Ltd.  
Address: No. 1, Yatai Road, Nanhu district, Jiaxing, Zhejiang 314050, China

## Factory Information-3

Company Name: TOP-TEK TECHNOLOGY(VIETNAM) CO., LTD.  
Address: No.5, Street 7, Vsip II, Hoa Phu Ward, Tdm Town, Binh Duong Province, Vietnam- 820000

## EUT Description

Product Name: Villa Door Station  
Model Name: OEU-201B-HMK-W  
Additional No.: OEU-201B-HMK-W -xxxxxxxx-yyyyyyyy-zzz,  
OEU-201S-HMK-W -xxxxxxxx-yyyyyyyy-zzz  
("x", "y", "z" can be 0-9, A-Z, a-z or blank, - may be blank)  
Model Difference: Their electrical circuit design, layout, components used and internal wiring are identical, only the color and model name is different. The model OEU-201B-HMK-W was selected as the representative model for compliance test.  
Sample Number: 6215301  
Data of Receipt Sample: Jun. 27, 2023  
Test Date: Jun. 27, 2023 ~ Jul. 23, 2023

APPLICABLE STANDARDS	
STANDARD	TEST RESULTS
CFR 47 Part 15 Subpart C	PASS

Summary of Test Results			
Clause	Test Items	FCC Rules	Test Results
1	6db DTS Bandwidth	FCC 15.247 (a) (2)	PASS
2	Conducted Power	FCC 15.247 (b) (3)	PASS
3	Power Spectral Density	FCC 15.247 (e)	PASS
4	Conducted Band edge And Spurious emission	FCC 15.247 (d)	PASS
5	Radiated Band edges and Spurious emission	FCC 15.247 (d) FCC 15.209 FCC 15.205	PASS
6	Conducted Emission Test for AC Power Port	FCC 15.207	PASS
7	Antenna Requirement	FCC 15.203	PASS
Remark: 1) The measurement result for the sample received is <Pass> according to < ANSI C63.10-2013, FCC CFR 47 Part 2, FCC CFR 47 Part 15C> when <Accuracy Method> decision rule is applied.			

Prepared By:

*Tom Tang*

Tom Tang

Reviewed By:

*Leon Wu*

Leon Wu

Authorized By:

*Chris Zhong*

Chris Zhong  
EMC&RF Lab Operations Manager

## 2. TEST METHODOLOGY

The tests documented in this report were performed in accordance with FCC KDB 558074 D01 15.247 Meas Guidance v05r02, KDB 414788 D01 Radiated Test Site v01r01, ANSI C63.10-2013, FCC CFR 47 Part 2, FCC CFR 47 Part 15.

## 3. FACILITIES AND ACCREDITATION

Accreditation Certificate	<p><b>A2LA (Certificate No.: 4829.01)</b> <b>UL-CCIC COMPANY LIMITED has been assessed and proved to be in compliance with A2LA.</b></p> <p><b>FCC (FCC Designation No.: CN1247)</b> <b>UL-CCIC COMPANY LIMITED has been recognized to perform compliance testing on equipment subject to the Commission's Declaration of Conformity (DoC) and Certification rules.</b></p> <p><b>IC (IC Designation No.: 25056; CAB No.: CN0073)</b> <b>UL-CCIC COMPANY LIMITED has been recognized to perform compliance testing on equipment subject to the Commission's Declaration of Conformity (DoC) and Certification rules.</b></p>
---------------------------	--

Note 1: All tests measurement facilities use to collect the measurement data are located at No. 2, Chengwan Road, Suzhou Industrial Park, Suzhou 215122, China.

Note 2: For below 30MHz, lab had performed measurements at test anechoic chamber and comparing to measurements obtained on an open field site. These measurements below 30MHz had been correlated to measurements performed on an OFS.

Note 3: The test anechoic chamber in UL-CCIC COMPANY LIMITED had been calibrated and compared to the open field sites and the test anechoic chamber is shown to be equivalent to or worst case from the open field site.

## 4. CALIBRATION AND UNCERTAINTY

### 4.1. MEASURING INSTRUMENT CALIBRATION

The measuring equipment utilized to perform the tests documented in this report has been calibrated in accordance with the manufacturer's recommendations and is traceable to recognized national standards.

### 4.2. MEASUREMENT UNCERTAINTY

Where relevant, the following measurement uncertainty levels have been estimated for tests performed on the apparatus:

Test Item	Uncertainty
Conduction emission	3.1dB
Maximum Conduct Output Power	± 1.3dB
DTS Bandwidth	±1.9 %
Maximum Conducted Output Power	± 0.69dB
Maximum Power Spectral Density Level	±1.5 dB
Band-edge Compliance	± 1.9%
Unwanted Emissions in Non-restricted Freq Bands	9kHz-30MHz: ±0.90dB 30MHz-1GHz: ±1.5 dB 1GHz-12.75GHz: ±1.9dB 12.75GHz-26.5GHz: ±2.1dB
Radiation Emission test (include Fundamental emission) (9kHz-30MHz)	3.4dB
Radiation Emission test (include Fundamental emission) (30MHz-1GHz)	3.4dB
Radiation Emission test (1GHz to 26GHz) (include Fundamental emission)	3.5dB (1GHz-18GHz)
	3.9dB (18GHz-26.5GHz)
Note: This uncertainty represents an expanded uncertainty expressed at approximately the 95% confidence level using a coverage factor of k=2.	

## 5. EQUIPMENT UNDER TEST

### 5.1. DESCRIPTION OF EUT

Product Name:	Villa Door Station
Model No.:	OEU-201B-HMK-W
Operating Frequency:	IEEE 802.11B/G/N(HT20): 2412MHz to 2462MHz
Type of Modulation:	IEEE for 802.11B: DSSS (CCK, DQPSK, DBPSK) IEEE for 802.11G: OFDM (64QAM, 16QAM, QPSK, BPSK) IEEE for 802.11N HT20: OFDM (64QAM, 16QAM, QPSK, BPSK)
Channels Step:	Channels with 5MHz step
Sample Type:	Fixed production
Test software of EUT:	Secure CRT (manufacturer declare)
Antenna Type:	FPC Antenna
Antenna Gain:	3.07 dBi
	Note: This data is provided by customer and our lab isn't responsible for this data.



## 5.2. MAXIMUM OUTPUT POWER

Number of Transmit Chains (NTX)	IEE Std. 802.11	Channel Number	Max AVG Conducted Power (dBm)
1	IEEE 802.11B	1-11[11]	14.37
1	IEEE 802.11G	1-11[11]	12.20
1	IEEE 802.11N HT20	1-11[11]	12.13

## 5.3. CHANNEL LIST

Channel List for 802.11B/G/N(20 MHz)							
Channel	Frequency (MHz)	Channel	Frequency (MHz)	Channel	Frequency (MHz)	Channel	Frequency (MHz)
1	2412	4	2427	7	2442	10	2457
2	2417	5	2432	8	2447	11	2462
3	2422	6	2437	9	2452		

## 5.4. TEST CHANNEL CONFIGURATION

Test Mode	Test Channel (MHz)
IEEE 802.11B	LCH: CH01 2412
	MCH: CH06 2437
	HCH: CH11 2462
IEEE 802.11G	LCH: CH01 2412
	MCH: CH06 2437
	HCH: CH11 2462
IEEE 802.11N HT20	LCH: CH01 2412
	MCH: CH06 2437
	HCH: CH11 2462

## 5.5. THE WORSE CASE POWER SETTING PARAMETER

The Worst Case Power Setting Parameter under 2400 ~ 2483.5MHz Band							
Test Software		SecureCRT					
Modulation Mode	Transmit Antenna Number	Test Channel					
		NCB: 20MHz			NCB: 40MHz		
		CH 1	CH 6	CH 11	CH 3	CH 6	CH 9
802.11B	1	default	default	default	/		
802.11G	1	default	default	default			
802.11N HT20	1	default	default	default			

### 5.6. DESCRIPTION OF AVAILABLE ANTENNAS

Ant.	Frequency (MHz)	Antenna Type	Antenna Gain (dBi)
1	2400-2483.5	FPC Antenna	3.07

Note: This data is provided by customer and our lab isn't responsible for this data.

Test Mode	Transmit and Receive Mode	Description
IEEE 802.11B	<input checked="" type="checkbox"/> 1TX, 1RX	Antenna1 can be used as transmitting/receiving antenna independently.
IEEE 802.11G	<input checked="" type="checkbox"/> 1TX, 1RX	Antenna1 can be used as transmitting/receiving antenna independently.
IEEE 802.11N HT20	<input checked="" type="checkbox"/> 1TX, 1RX	Antenna1 can be used as transmitting/receiving antenna independently.

### 5.7. THE WORSE CASE CONFIGURATIONS

For WIFI module, the worst-case data rates as provided by the client were:

802.11B mode: 1 Mbps

802.11G mode: 6 Mbps

802.11N HT20 mode: MCS0

### 5.8. TEST ENVIRONMENT

Environment Parameter	Selected Values During Tests	
Relative Humidity:	55 ~ 65%	
Atmospheric Pressure:	101kPa	
Temperature:	TN	23 ~ 28°C
Voltage:	VL	N/A
	VN	AC 120V
	VH	N/A

Note: VL= Lower Extreme Test Voltage

VN= Nominal Voltage

VH= Upper Extreme Test Voltage

TN= Normal Temperature

## 5.9. DESCRIPTION OF TEST SETUP

### SUPPORT EQUIPMENT

Item	Equipment	Brand Name	Model Name	Description
1	Laptop	ThinkPad	E590	/
2	Alarm Light	N/A	N/A	Supplied by UL Lab
3	Electric-magnetic Lock	N/A	N/A	Supplied by UL Lab

### I/O PORT

Cable No	Port	Connector Type	Cable Type	Cable Length(m)	Remarks
1	LAN	LAN	LAN	100cm Length	/

### ACCESSORY

Item	Accessory	Brand Name	Model Name	Description
1	DC Adapter	HONOTO	ADS-24S-12 1224GPCN	INPUT:100-240V~50/60Hz 0.7A Max OUTPUT:12.0V=2.0A

**TEST SETUP**

The EUT can work in an engineer mode with a software through a table PC.

**SETUP DIAGRAM FOR TESTS**

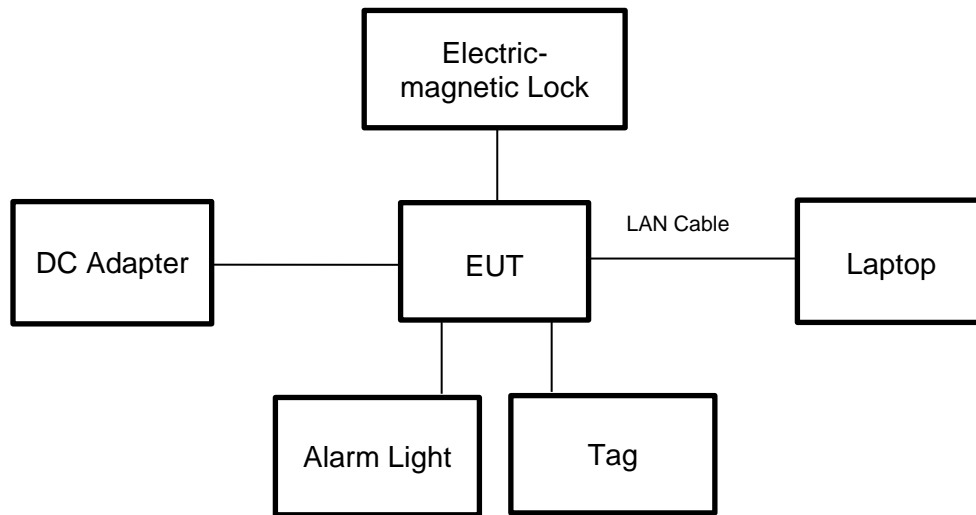

### 5.10. MEASURING INSTRUMENT AND SOFTWARE USED

Conducted Emissions (Instrument)							
Used	Equipment	Manufacturer	Model No.	Serial No.	Upper Last Cal.	Last Cal.	Next Cal.
<input checked="" type="checkbox"/>	EMI Test Receiver	R&S	ESR3	126700	2021-12-04	2022-12-03	2023-12-02
<input checked="" type="checkbox"/>	Two-Line V-Network	R&S	ENV216	126701	2021-12-04	2022-12-03	2023-12-02
<input checked="" type="checkbox"/>	Artificial Mains Networks	R&S	ENY81	126712	2021-10-12	2022-10-09	2023-10-08
Software							
Used	Description		Manufacturer	Name	Version		
<input checked="" type="checkbox"/>	Test Software for Conducted disturbance		R&S	EMC32	Ver. 9.25		
Radiated Emissions (Instrument)							
Used	Equipment	Manufacturer	Model No.	Serial No.	Upper Last Cal.	Last Cal.	Next Cal.
<input checked="" type="checkbox"/>	EMI test receiver	R&S	ESR7	222993	2022-05-20	2023-04-08	2024-04-07
<input checked="" type="checkbox"/>	EMI test receiver	R&S	ESR26	126703	2021-12-04	2022-12-03	2023-12-02
<input checked="" type="checkbox"/>	Spectrum Analyzer	R&S	FSV3044	222992	2022-05-20	2023-04-08	2024-04-07
<input checked="" type="checkbox"/>	Receiver Antenna (9kHz-30MHz)	Schwarzbeck	FMZB 1513	155456	2018-06-04	2021-06-03	2024-06-02
<input checked="" type="checkbox"/>	Receiver Antenna (30MHz-1GHz)	Schwarzbeck	VULB 9163	126704	2019-01-19	2022-01-18	2025-01-17
<input checked="" type="checkbox"/>	Receiver Antenna (1GHz-18GHz)	R&S	HF907	126705	2019-01-27	2022-02-28	2025-02-27
<input checked="" type="checkbox"/>	Receiver Antenna (18GHz-26.5GHz)	Schwarzbeck	BBHA9170	126706	2019-02-29	2022-02-28	2025-02-27
<input checked="" type="checkbox"/>	Pre-amplification (To 18GHz)	Tonscnd	TAP01018050	224539	/	2022-10-20	2023-10-19
<input checked="" type="checkbox"/>	Pre-amplification (To 18GHz)	R&S	SCU-18D	134667	2021-12-04	2022-12-03	2023-12-02
<input checked="" type="checkbox"/>	Pre-amplification (To 26.5GHz)	R&S	SCU-26D	135391	2021-12-04	2022-12-03	2023-12-02
<input checked="" type="checkbox"/>	Band Reject Filter	Wainwright	WRCGV12-2375-2400-2485-2510-40SS	1	2022-05-20	2023-04-08	2024-04-07
<input checked="" type="checkbox"/>	High Pass Filter	COM-MW	ZBF13-3-18G-01	2	2022-05-20	2023-04-08	2024-04-07
Software							
Used	Description		Manufacturer	Name	Version		
<input checked="" type="checkbox"/>	Test Software for Radiated disturbance		Tonscnd	TS+	Ver. 2.5		
<input checked="" type="checkbox"/>	Test Software for Radiated disturbance		Chinese-EMC	RE_RSE	Ver. 3.03		
Other instruments							
Used	Equipment	Manufacturer	Model No.	Serial No.	Upper Last Cal.	Last Cal.	Next Cal.
<input checked="" type="checkbox"/>	Spectrum Analyzer	Keysight	N9010B	155368	2022-05-20	2023-04-08	2024-04-07
<input checked="" type="checkbox"/>	Power Meter	MWT	MW100-RFCB	221694	2022-05-23	2023-04-08	2024-04-07
<input checked="" type="checkbox"/>	Attenuator	PASTERNAK	PE7087-6	1624	2022-05-23	2023-04-08	2024-04-07

## 6. MEASUREMENT METHODS

No.	Test Item	KDB Name	Section
1	6dB Bandwidth and 99% Occupied Bandwidth	KDB 558074 D01 15.247 Meas Guidance v05r02	8.2
2	Output Power	KDB 558074 D01 15.247 Meas Guidance v05r02	8.3.2.3 (Method AVPM)
3	Power Spectral Density	KDB 558074 D01 15.247 Meas Guidance v05r02	8.4 (Method PKPSD)
4	Out-of-band emissions in non-restricted bands	KDB 558074 D01 15.247 Meas Guidance v05r02	8.5
5	Out-of-band emissions in restricted bands	KDB 558074 D01 15.247 Meas Guidance v05r02	8.6
6	Band-edge	KDB 558074 D01 15.247 Meas Guidance v05r02	8.7
7	Conducted Emission Test for AC Power Port	ANSI C63.10-2013	6.2

## 7. ANTENNA PORT TEST RESULTS

### 7.1. ON TIME AND DUTY CYCLE

#### LIMITS

None; for reporting purposes only

#### PROCEDURE

FCC KDB 558074 Zero-Span Spectrum Analyzer Method

#### TEST SETUP

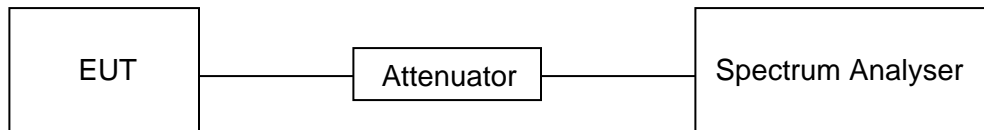

#### TEST ENVIRONMENT

Temperature	22°C	Relative Humidity	56%
Atmosphere Pressure	101kPa	Test Voltage	AC 120V

#### TEST RESULTS TABLE

Mode	On Time (msec)	Period (msec)	Duty Cycle x (Linear)	Duty Cycle (%)	Duty Cycle Correction Factor (db)	1/T Minimum VBW (kHz)	Final VBW (kHz)
11B	100	100	1	100	0	0	0.01
11G	100	100	1	100	0	0	0.01
802.11N HT20	100	100	1	100	0	0	0.01

- Note: 1) Duty Cycle Correction Factor= $10\log(1/x)$ .  
 2) Where: x is Duty Cycle (Linear)  
 3) Where: T is On Time (transmit duration)  
 4) If the duty cycle is above 98%, the Final VBW is 10Hz.

**TEST GRAPHS**

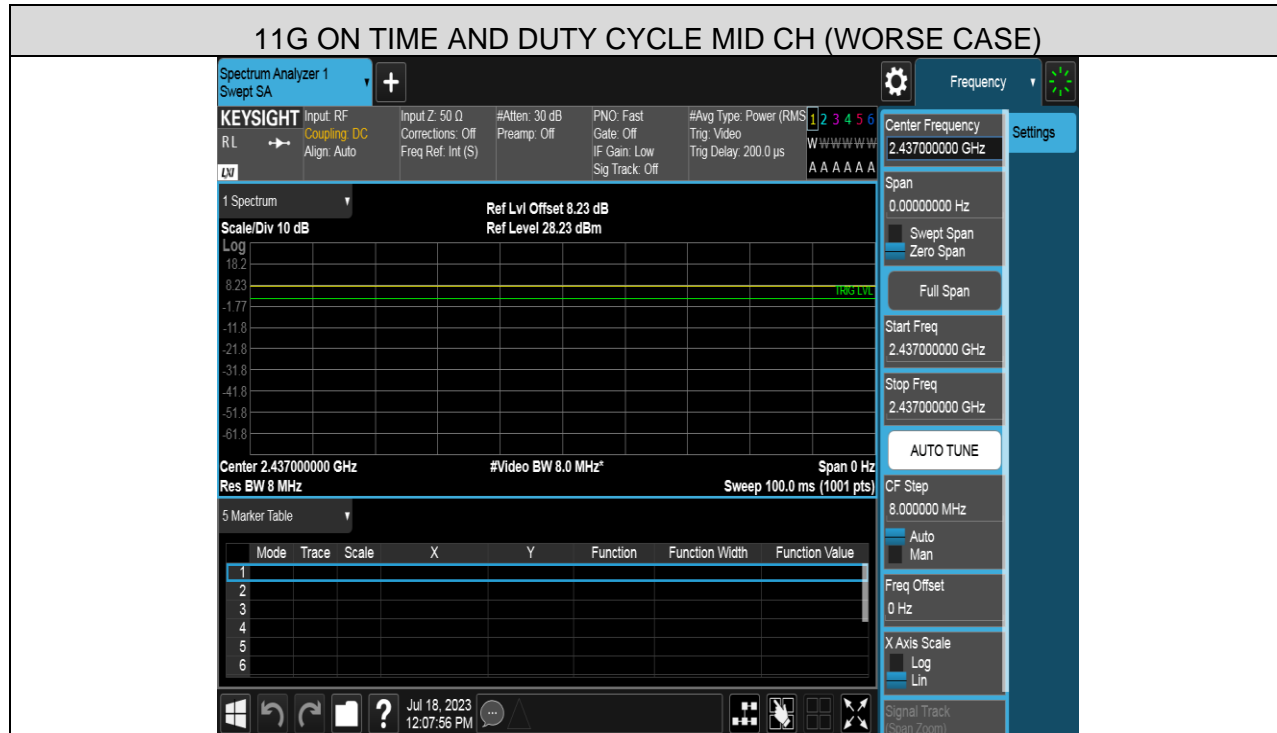
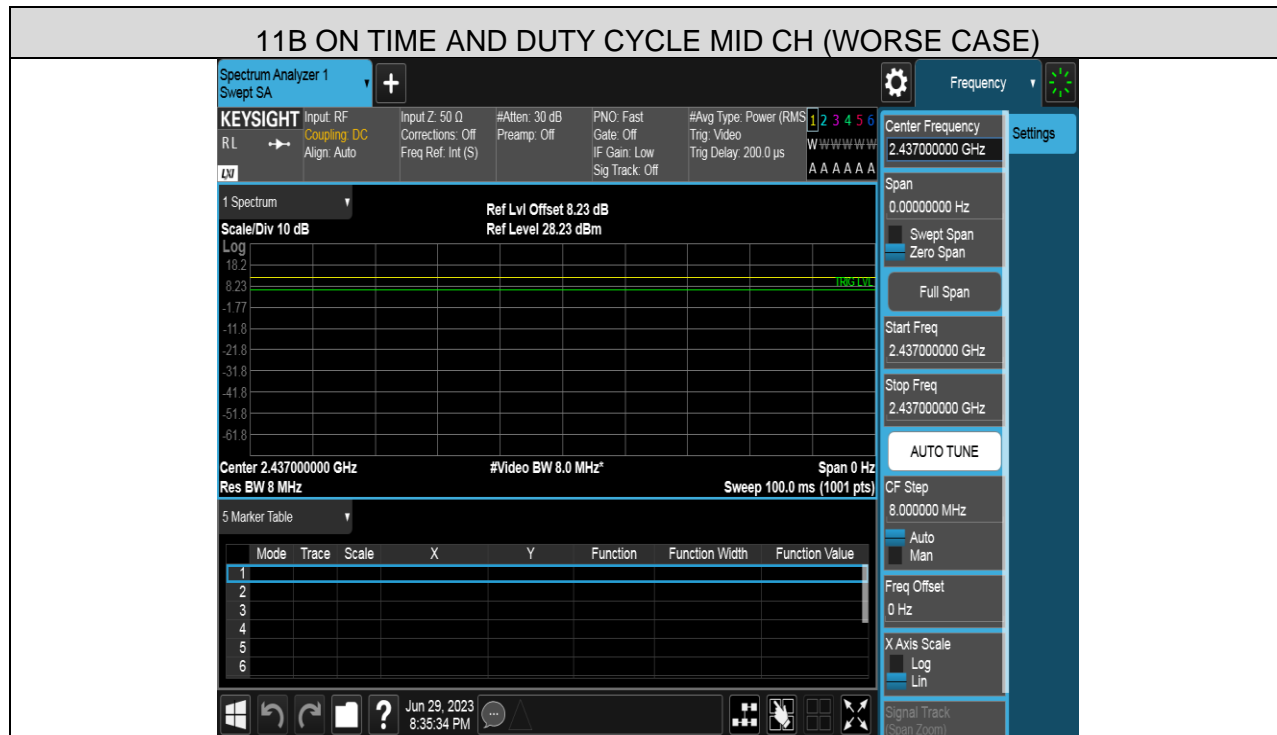



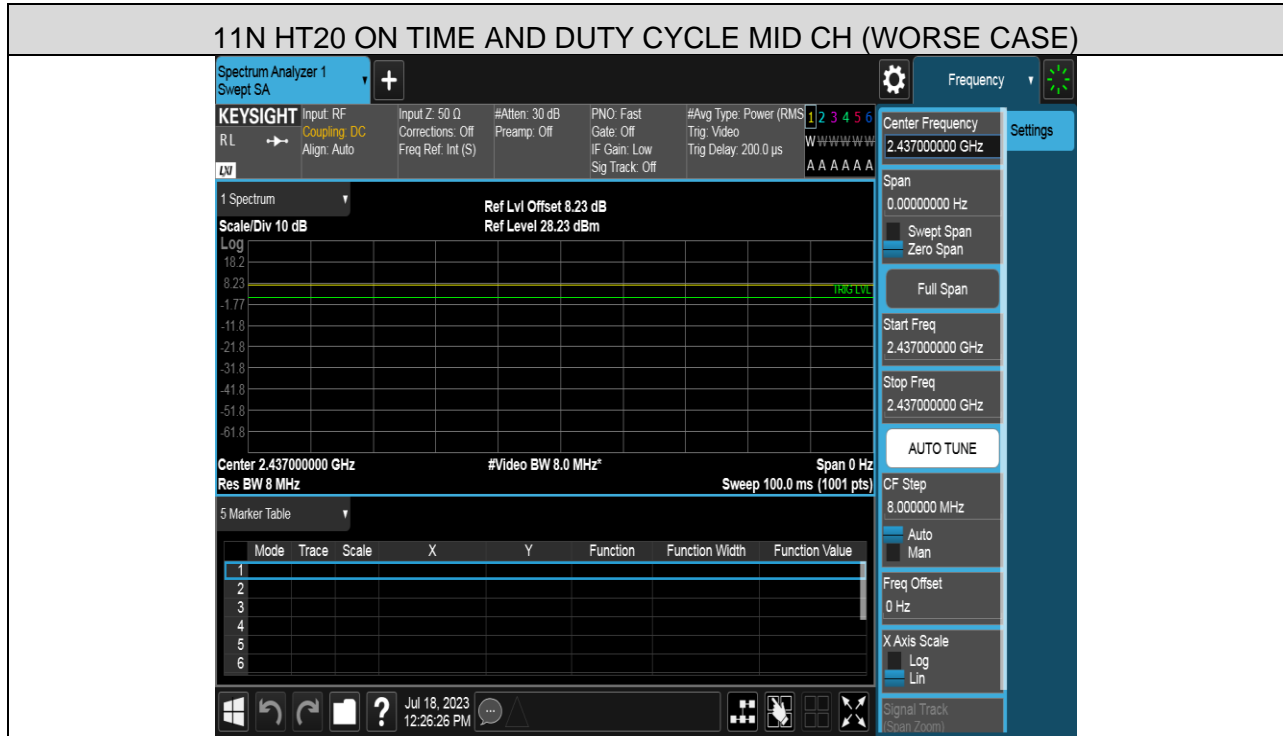

## 7.2. 6 dB BANDWIDTH

### LIMITS

FCC Part15 (15.247), Subpart C			
Section	Test Item	Limit	Frequency Range (MHz)
FCC 15.247(a)(2)	6dB Bandwidth	$\geq 500\text{kHz}$	2400-2483.5

### TEST PROCEDURE

Refer to ANSI C63.10-2013 clause 11.8 for DTS bandwidth.

Connect the EUT to the spectrum analyser and use the following settings:

Center Frequency	The centre frequency of the channel under test
Detector	Peak
RBW	For 6 dB Bandwidth :100K
VBW	For 6dB Bandwidth: $\geq 3 \times \text{RBW}$
Trace	Max hold
Sweep	Auto couple

Allow the trace to stabilize and measure the maximum width of the emission that is constrained by the frequencies associated with the two outermost amplitude points (upper and lower frequencies) that are attenuated by 6 dB relative to the maximum level measured in the fundamental emission.

### TEST SETUP

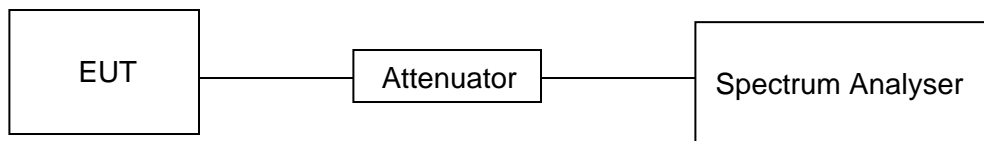

**TEST ENVIRONMENT**

Temperature	22°C	Relative Humidity	56%
Atmosphere Pressure	101kPa	Test Voltage	AC 120V

**TEST RESULTS TABLE**

Test Mode	Test Channel	6dB bandwidth (MHz)	Result
11B	LCH	9.0707	Pass
	MCH	9.0613	Pass
	HCH	9.0160	Pass
11G	LCH	16.5320	Pass
	MCH	16.5187	Pass
	HCH	16.5213	Pass
11N HT20	LCH	17.6987	Pass
	MCH	17.6933	Pass
	HCH	17.7053	Pass

**TEST GRAPHS**

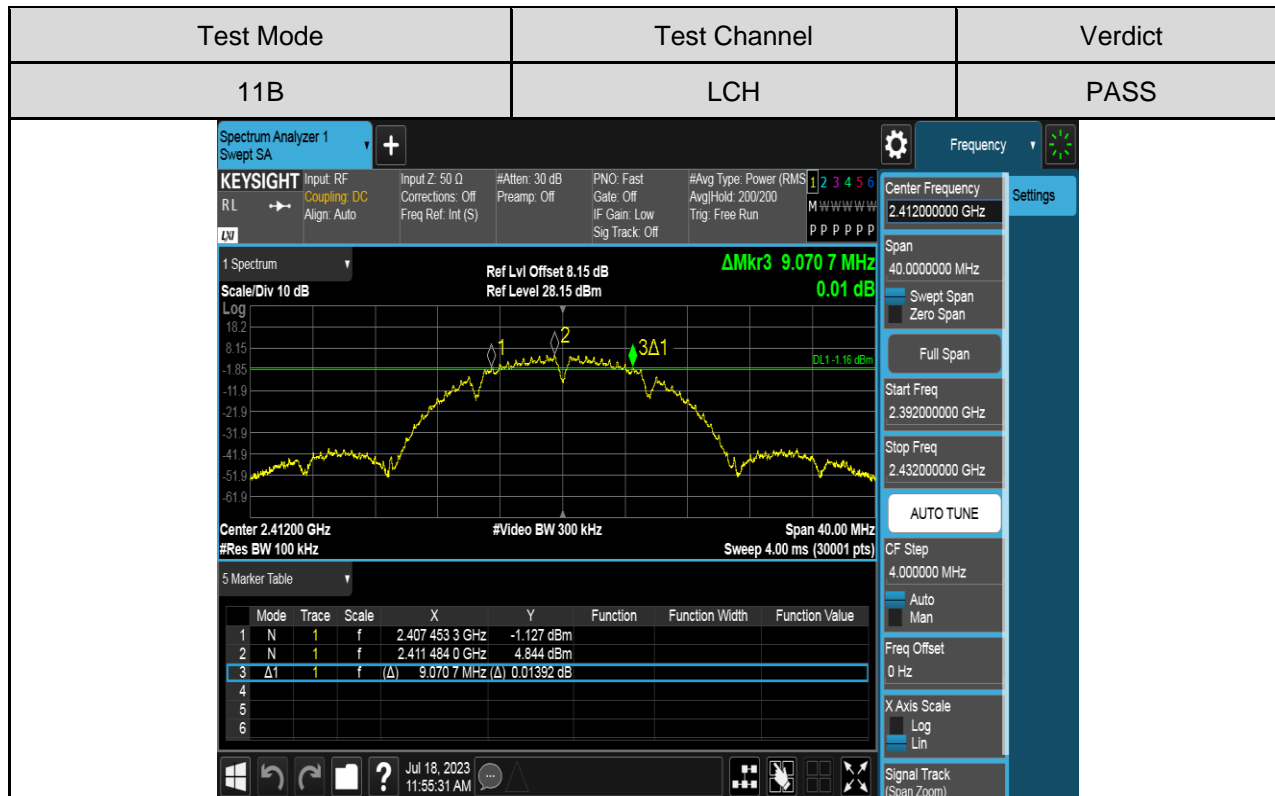

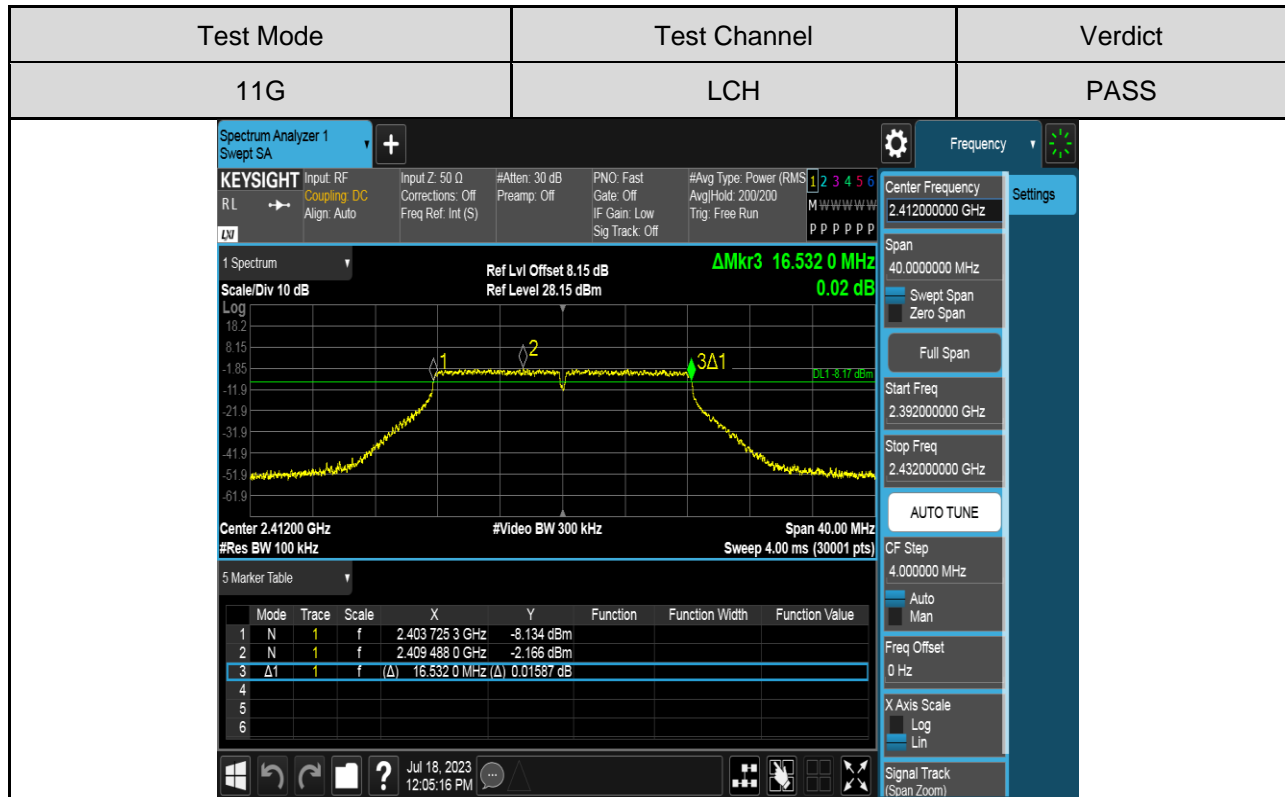
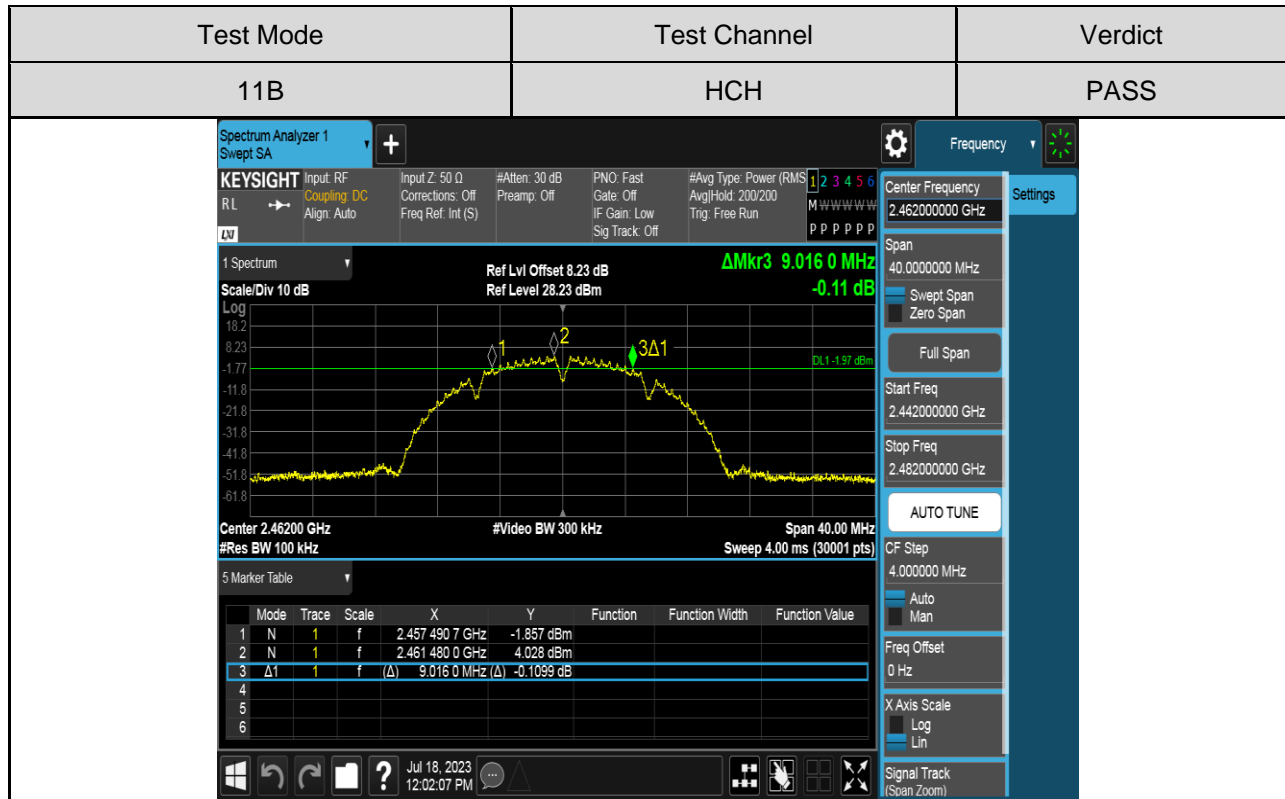

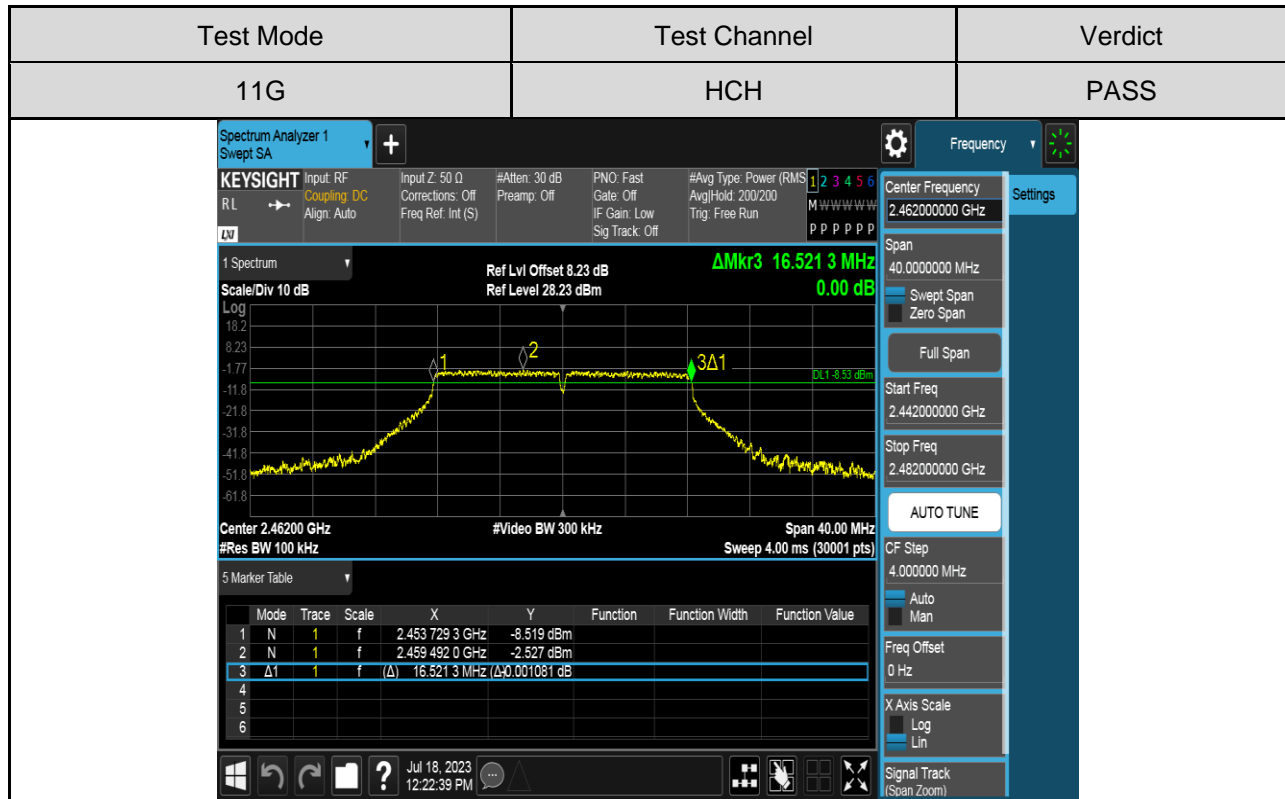
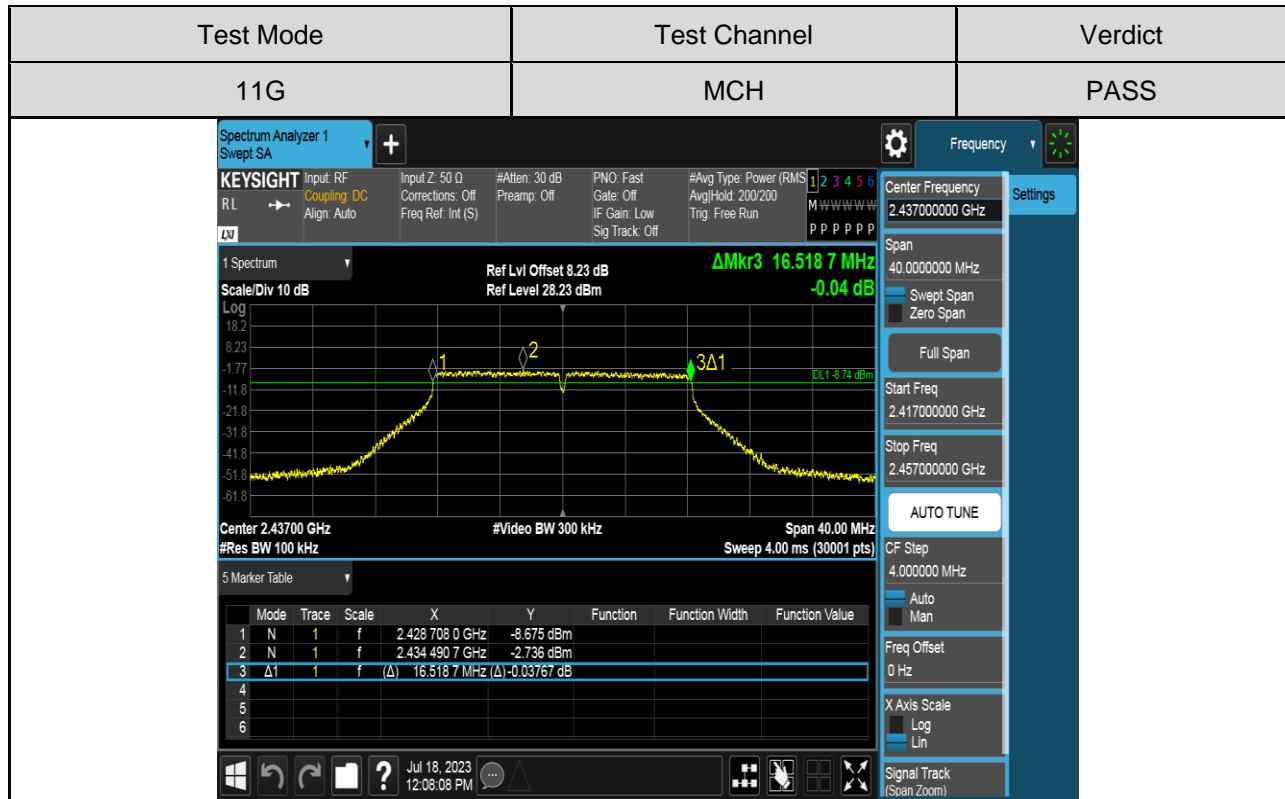

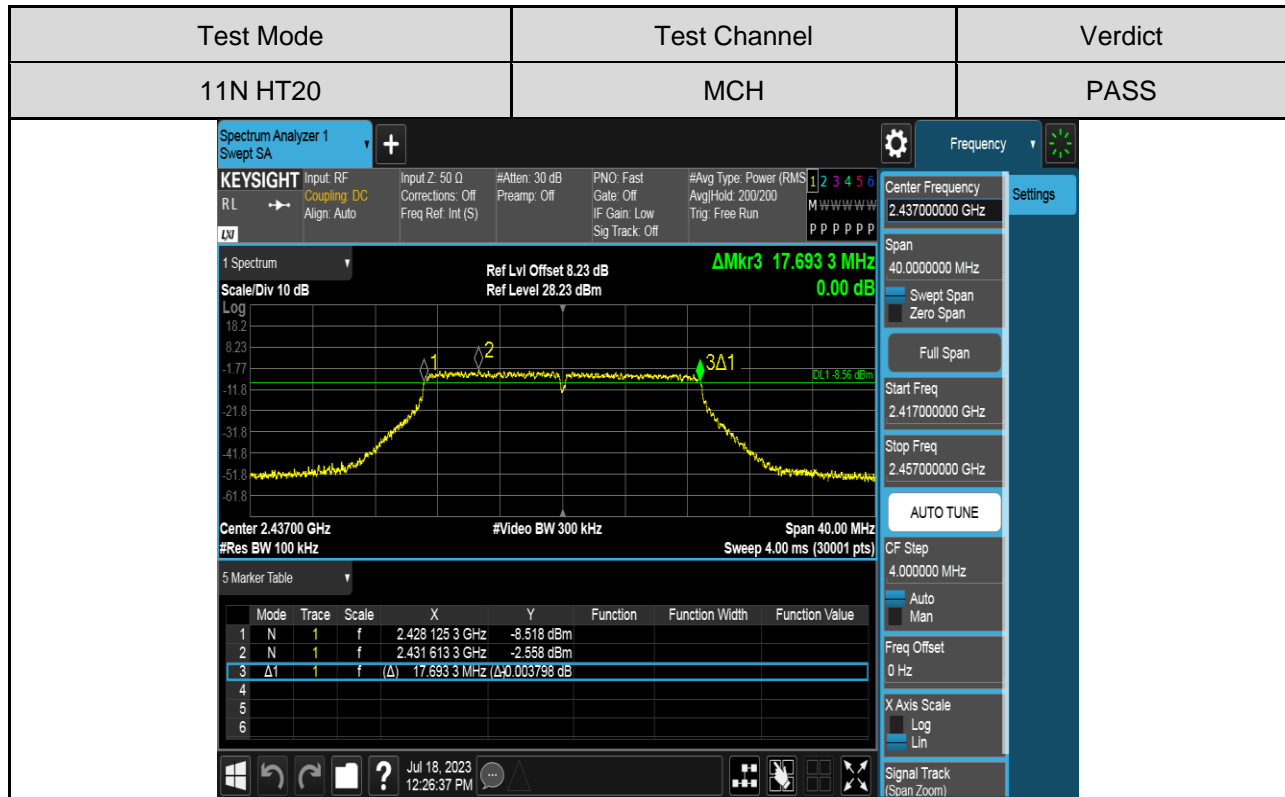
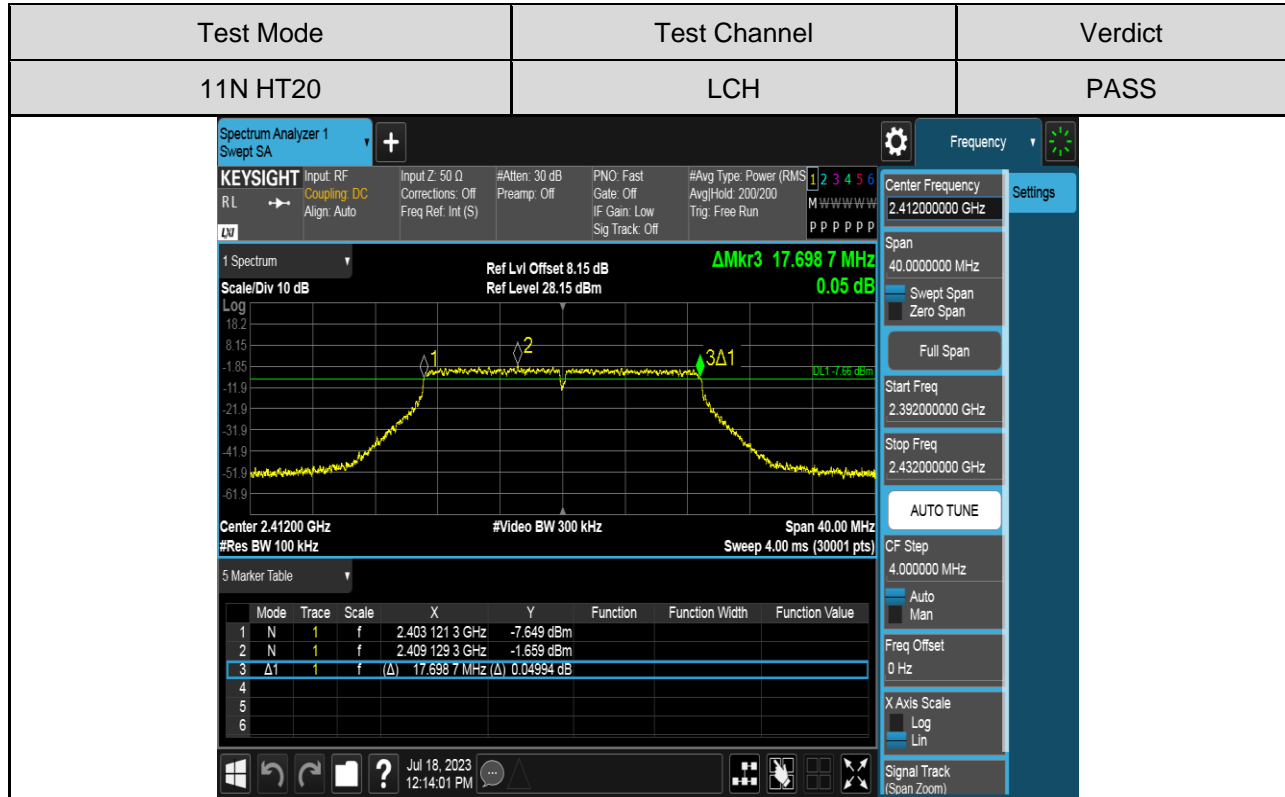

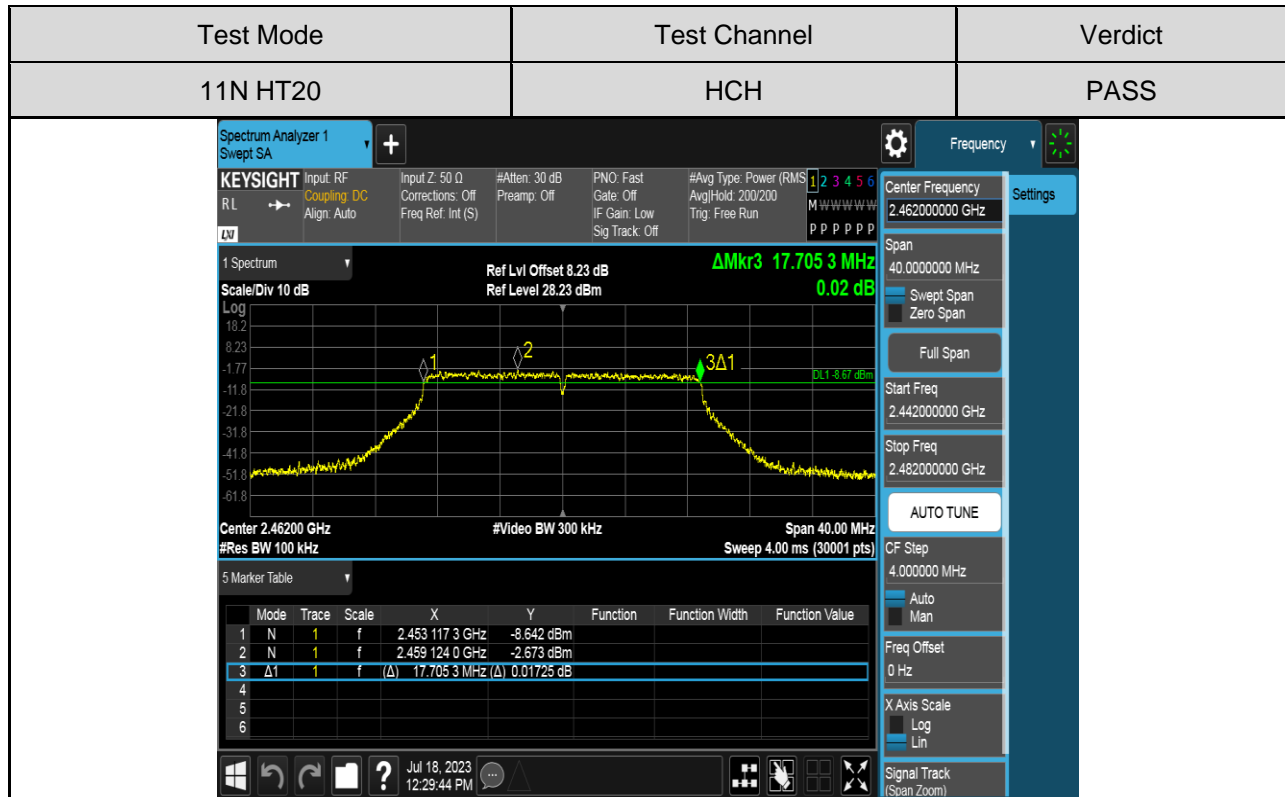



### 7.3. CONDUCTED OUTPUT POWER

#### LIMITS

FCC Part15 (15.247), Subpart C			
Section	Test Item	Limit	Frequency Range (MHz)
FCC 15.247(b)(3)	Output Power	1 watt or 30dBm	2400-2483.5

#### TEST PROCEDURE

Place the EUT on the table and set it in the transmitting mode.  
Remove the antenna from the EUT and then connect a low loss RF cable from the antenna port to the Power sensor.  
Measure the power of each channel.  
AVG Detector used for AVG result.

#### TEST SETUP

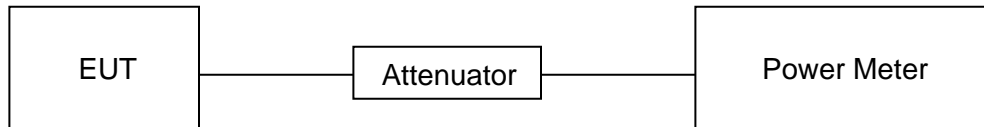

**TEST ENVIRONMENT**

Temperature	22°C	Relative Humidity	56%
Atmosphere Pressure	101kPa	Test Voltage	AC 120V

**TEST RESULTS TABLE**

Test Mode	Test Channel	Measurement Output Power (AV)	10log(1/x) Factor	Maximum Conducted Output Power (AV)	LIMIT
		dBm	dBm	dBm	dBm
11B	LCH	14.10	0	14.10	30
	MCH	14.37	0	14.37	30
	HCH	13.28	0	13.28	30
11G	LCH	12.20	0	12.20	30
	MCH	11.42	0	11.42	30
	HCH	11.63	0	11.63	30
11N HT20	LCH	12.13	0	12.13	30
	MCH	11.29	0	11.29	30
	HCH	11.08	0	11.08	30

## 7.4. POWER SPECTRAL DENSITY

### LIMITS

FCC Part15 (15.247), Subpart C			
Section	Test Item	Limit	Frequency Range (MHz)
FCC §15.247 (e)	Power Spectral Density	8 dBm/3 kHz	2400-2483.5

### TEST PROCEDURE

Refer to FCC KDB 558074, connect the UUT to the spectrum analyser and use the following settings:

Center Frequency	The centre frequency of the channel under test
Detector	Peak
RBW	$3 \text{ kHz} \leq \text{RBW} \leq 100 \text{ kHz}$
VBW	$\geq 3 \times \text{RBW}$
Span	1.5 x DTS bandwidth
Trace	Max hold
Sweep time	Auto couple.

Allow trace to fully stabilize and use the peak marker function to determine the maximum amplitude level within the RBW.

If measured value exceeds limit, reduce RBW (no less than 3 kHz) and repeat.

### TEST SETUP

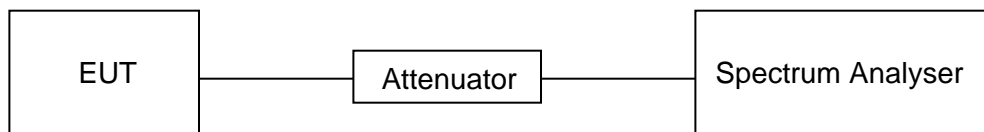

**TEST ENVIRONMENT**

Temperature	22°C	Relative Humidity	56%
Atmosphere Pressure	101kPa	Test Voltage	AC 120V

**TEST RESULTS TABLE**

Test Mode	Test Channel	Maximum Peak power spectral density (dBm/30kHz)	Result
11B	LCH	-0.36	Pass
	MCH	-0.13	Pass
	HCH	-1.08	Pass
11G	LCH	-4.90	Pass
	MCH	-5.70	Pass
	HCH	-5.46	Pass
11N HT20	LCH	-4.39	Pass
	MCH	-5.25	Pass
	HCH	-5.43	Pass

**TEST GRAPHS**

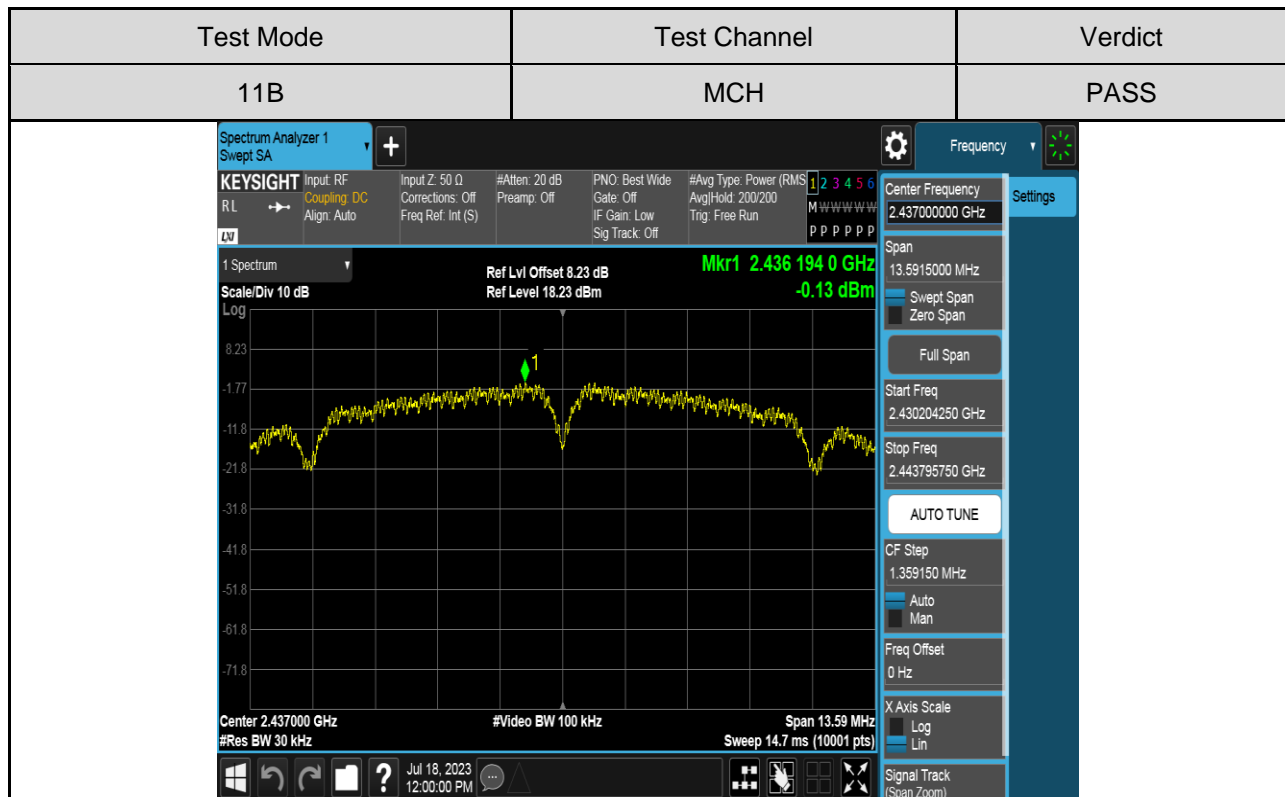
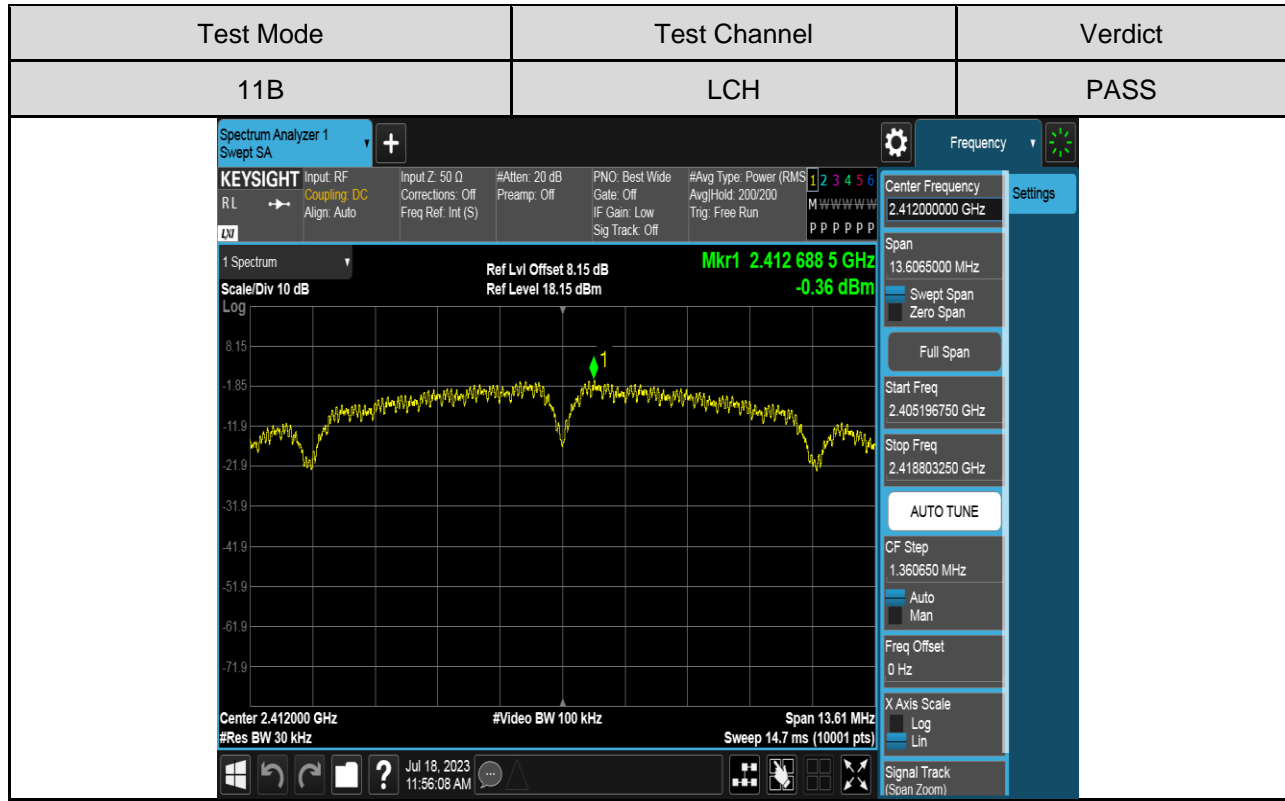

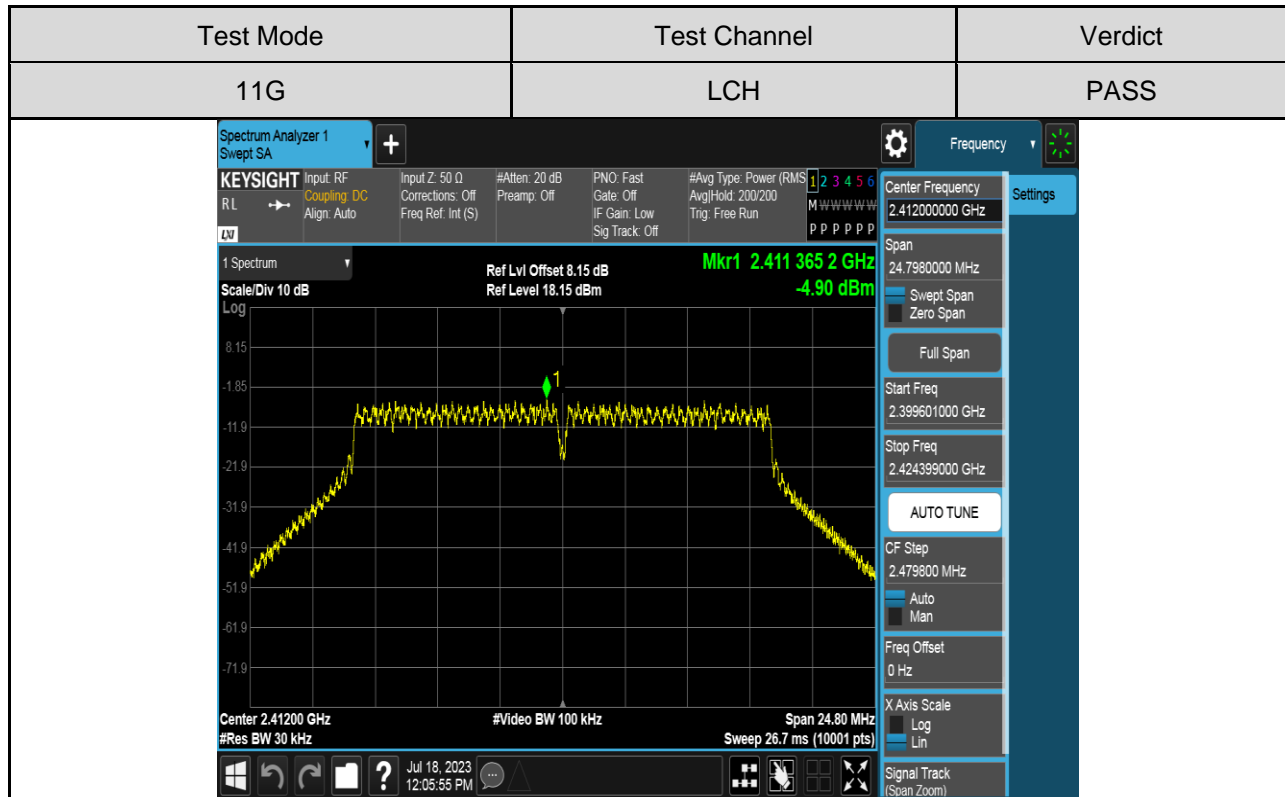
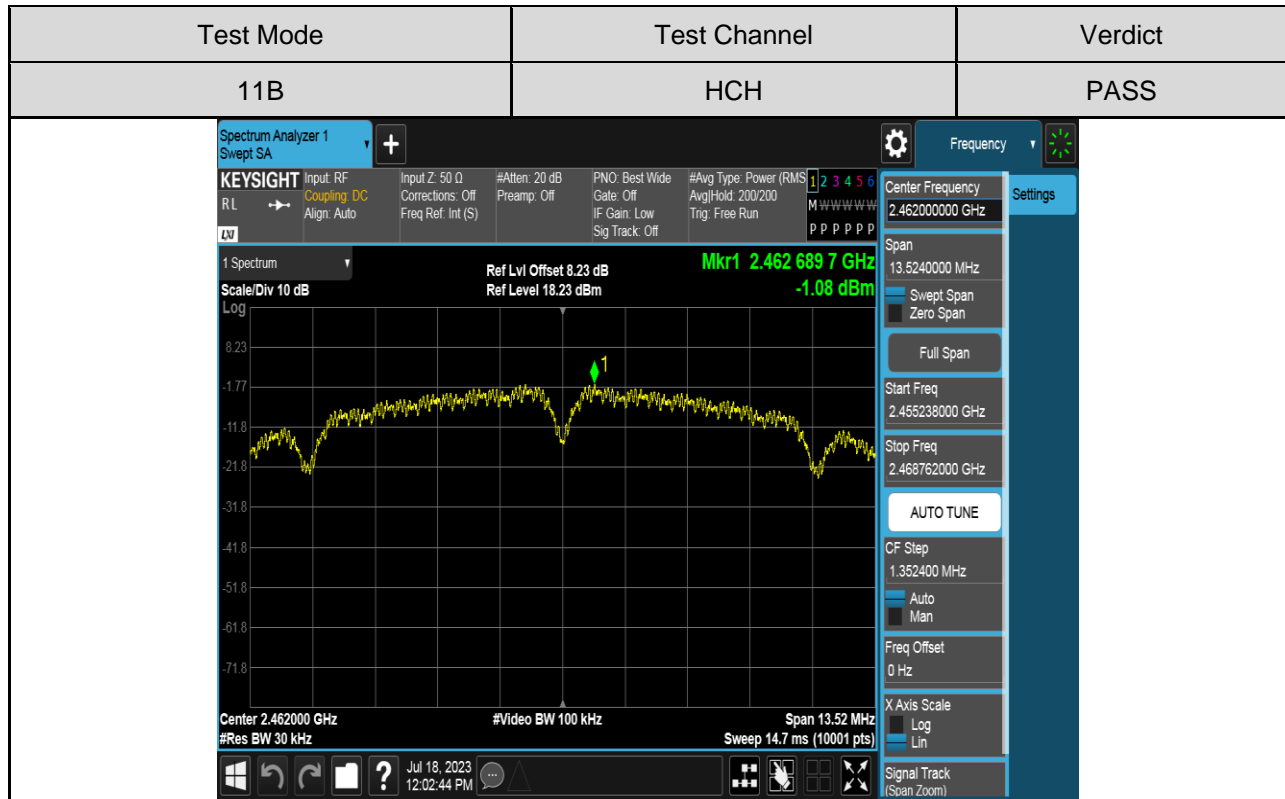

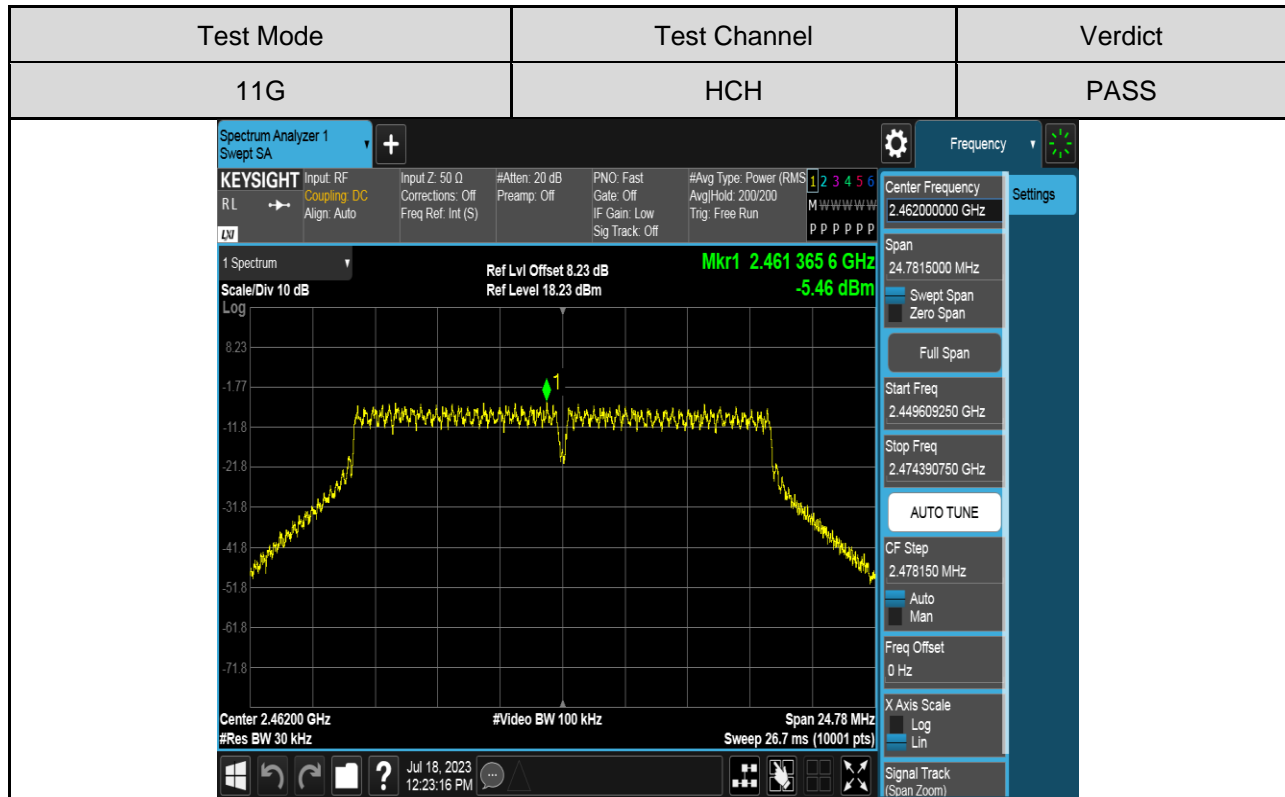
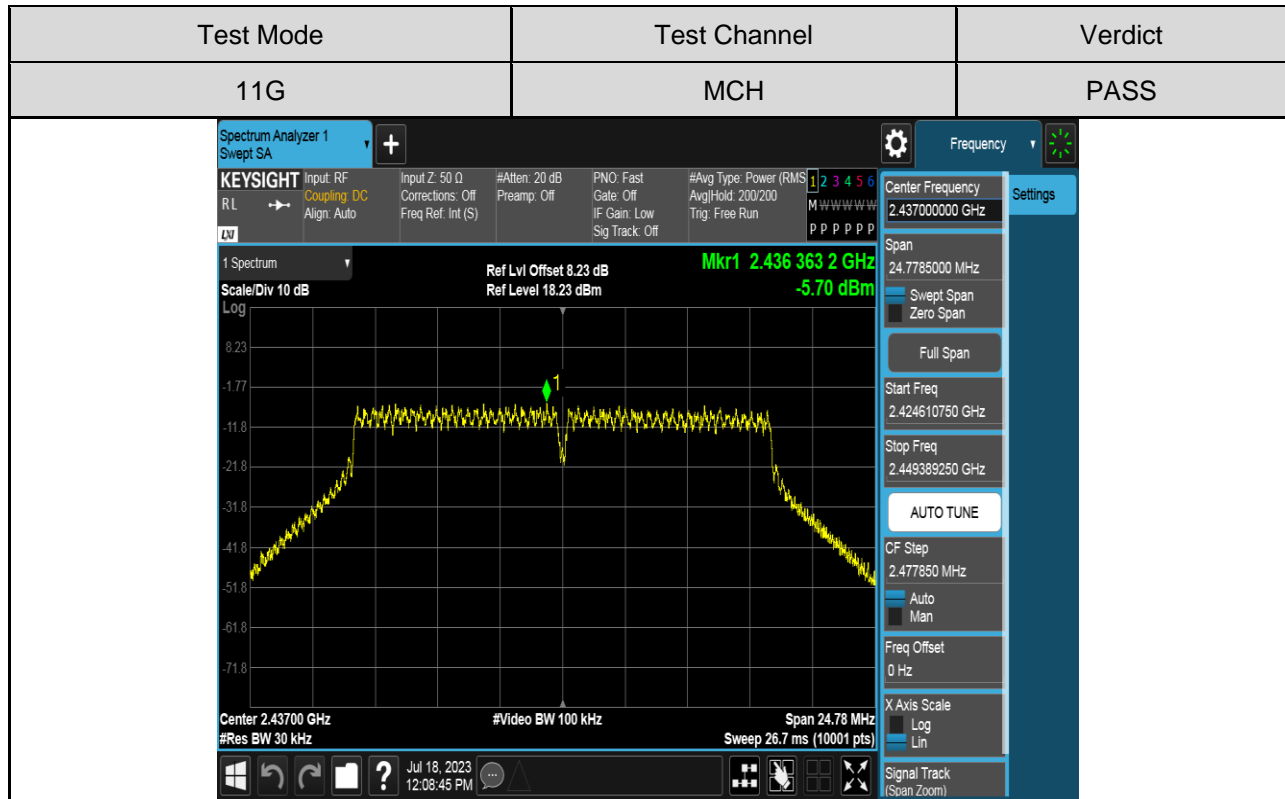

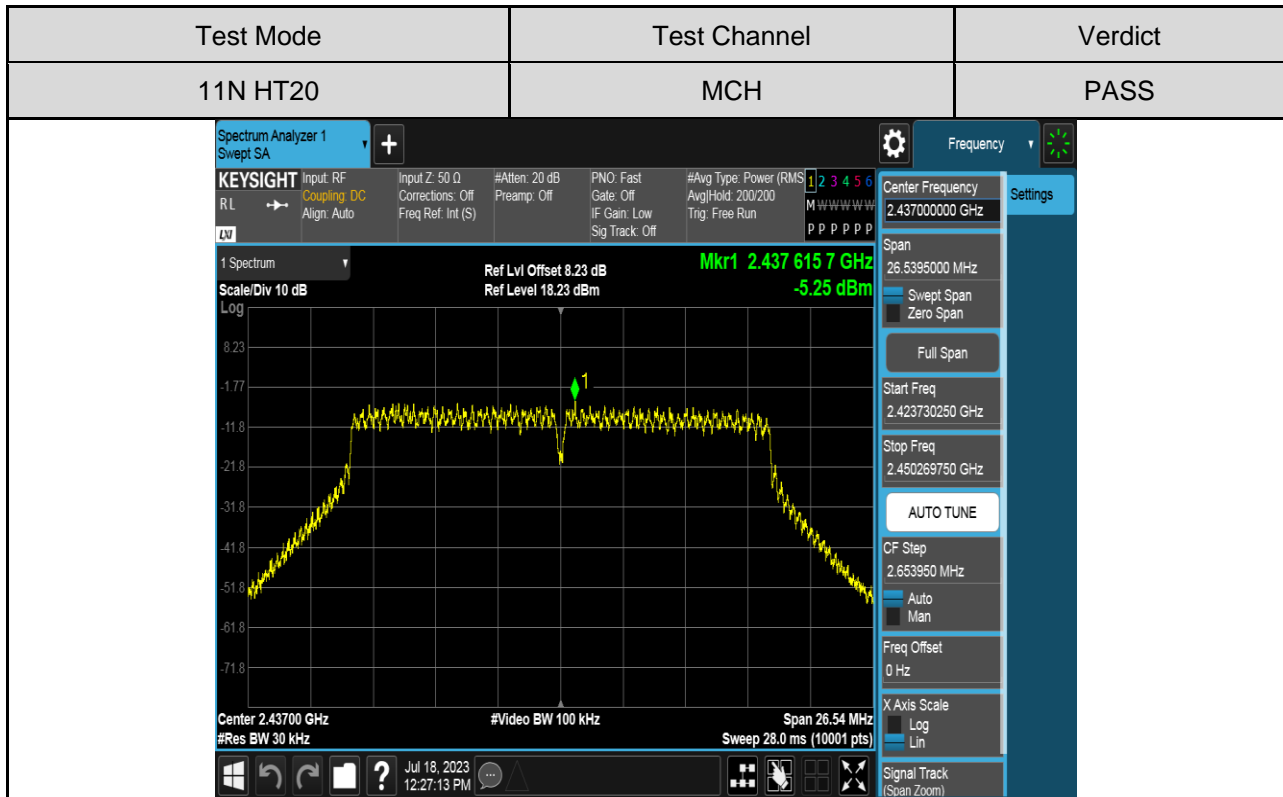
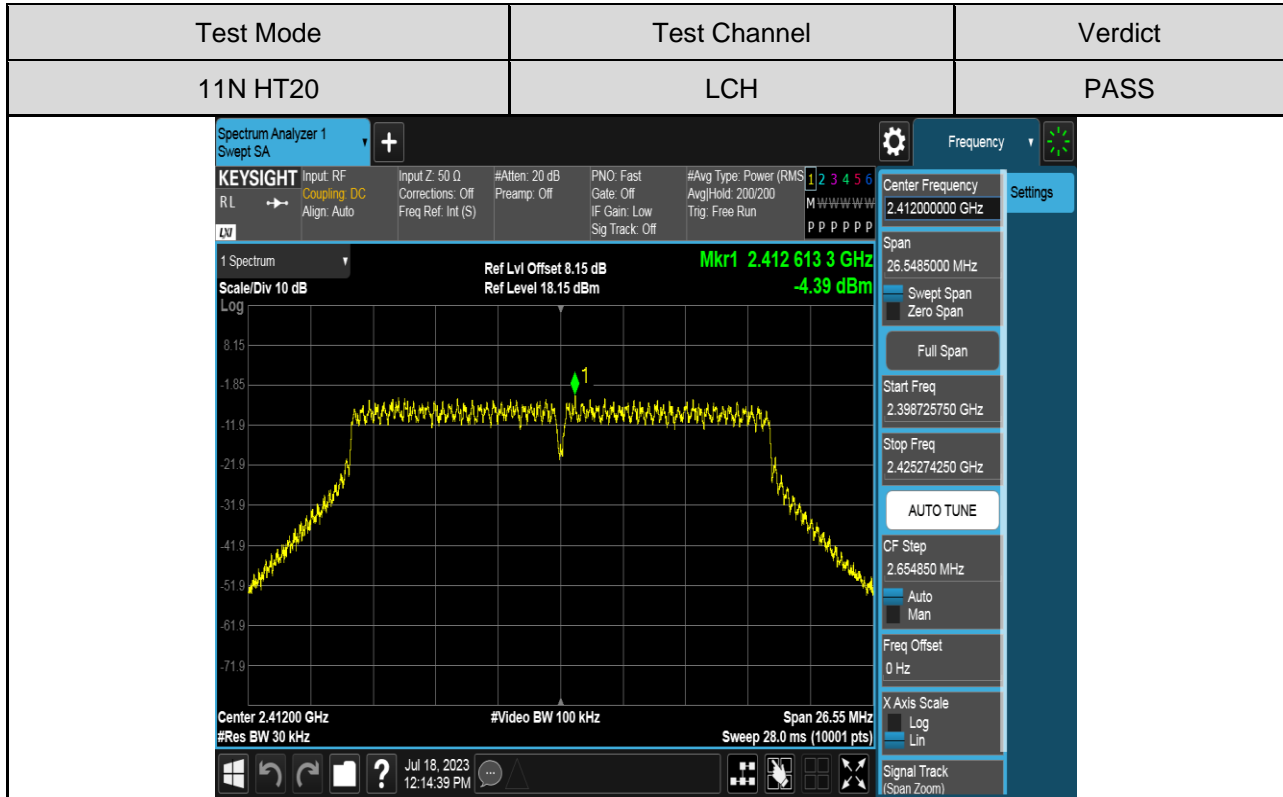



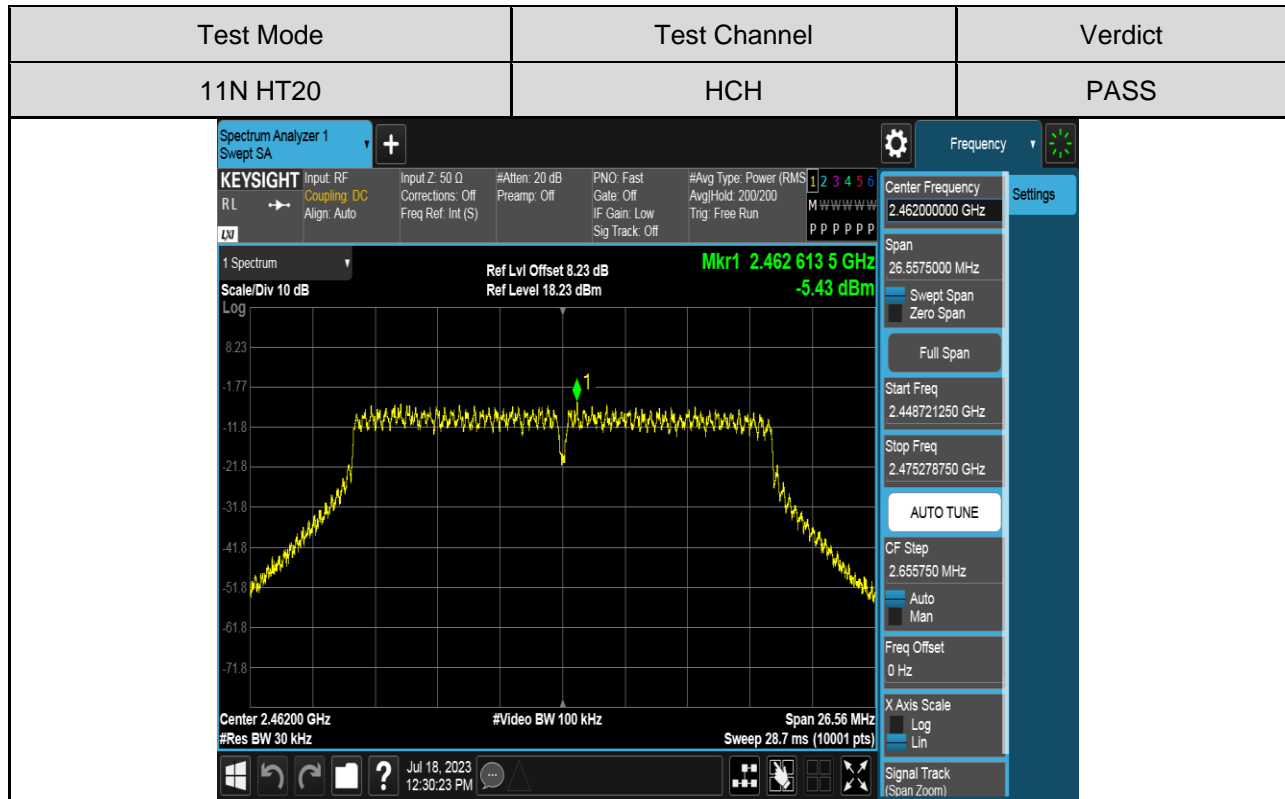

## 7.5. CONDUCTED BANDEGE AND SPURIOUS EMISSIONS

### LIMITS

FCC Part15 (15.247), Subpart C		
Section	Test Item	Limit
FCC §15.247 (d)	Conducted Bandedge and Spurious Emissions	30 dB below that in the 100 kHz bandwidth within the band that contains the highest level of the desired power

### TEST PROCEDURE

Refer to FCC KDB 558074, connect the UUT to the spectrum analyser and use the following settings:

Center Frequency	The centre frequency of the channel under test
Detector	Peak
RBW	100K
VBW	$\geq 3 \times \text{RBW}$
Span	1.5 x DTS bandwidth
Trace	Max hold
Sweep time	Auto couple.

Use the peak marker function to determine the maximum PSD level.

Span	Set the center frequency and span to encompass frequency range to be measured
Detector	Peak
RBW	100K
VBW	$\geq 3 \times \text{RBW}$
measurement points	$\geq \text{span}/\text{RBW}$
Trace	Max hold
Sweep time	Auto couple.

Use the peak marker function to determine the maximum amplitude level.

### TEST SETUP

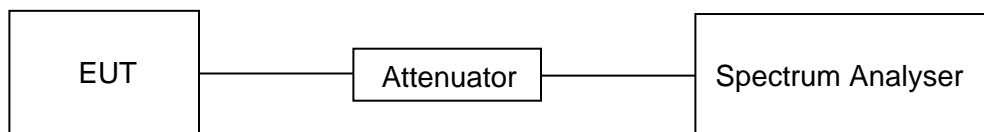

**TEST ENVIRONMENT**

Temperature	22°C	Relative Humidity	56%
Atmosphere Pressure	101kPa	Test Voltage	AC 120V

**PART 1: REFERENCE LEVEL MEASUREMENT****TEST RESULTS TABLE**

Test Mode	Test Channel	Result[dBm]
11B	LCH	4.78
	MCH	5.17
	HCH	4.05
11G	LCH	-2.02
	MCH	-2.72
	HCH	-2.72
11N HT20	LCH	-2.40
	MCH	-2.45
	HCH	-2.78

**TEST GRAPHS**

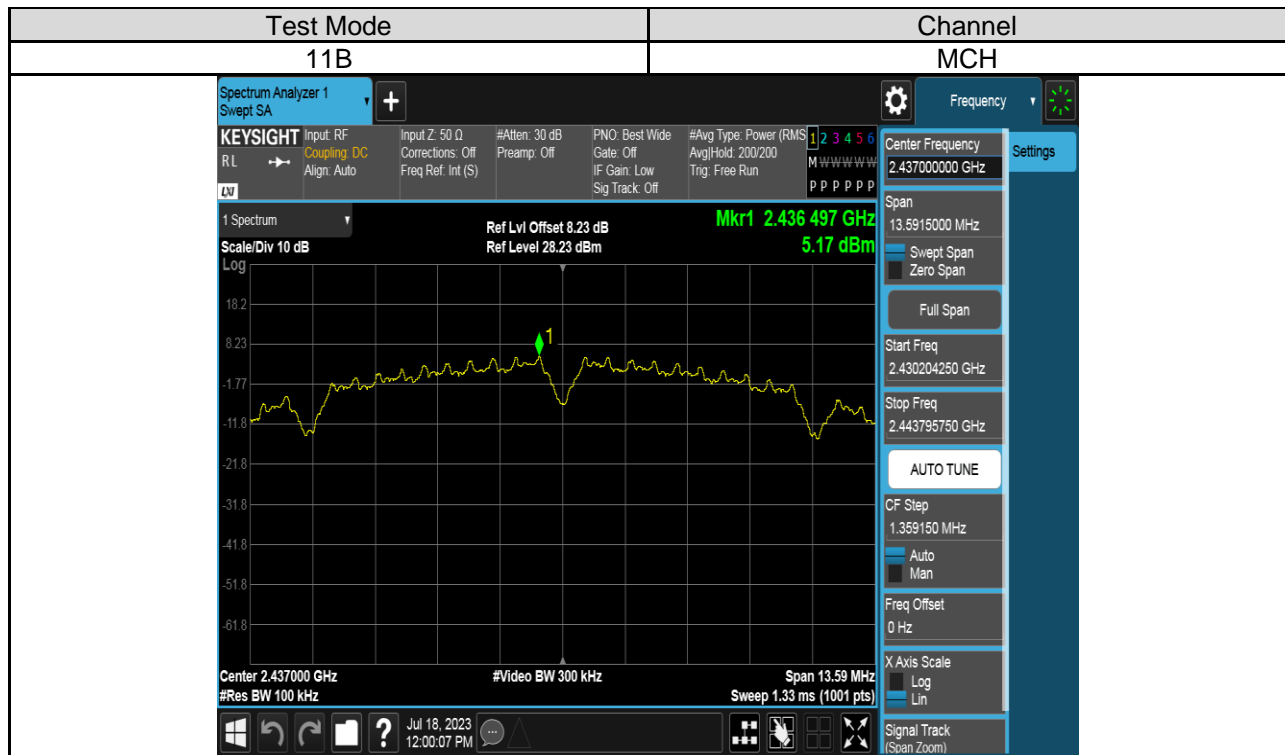
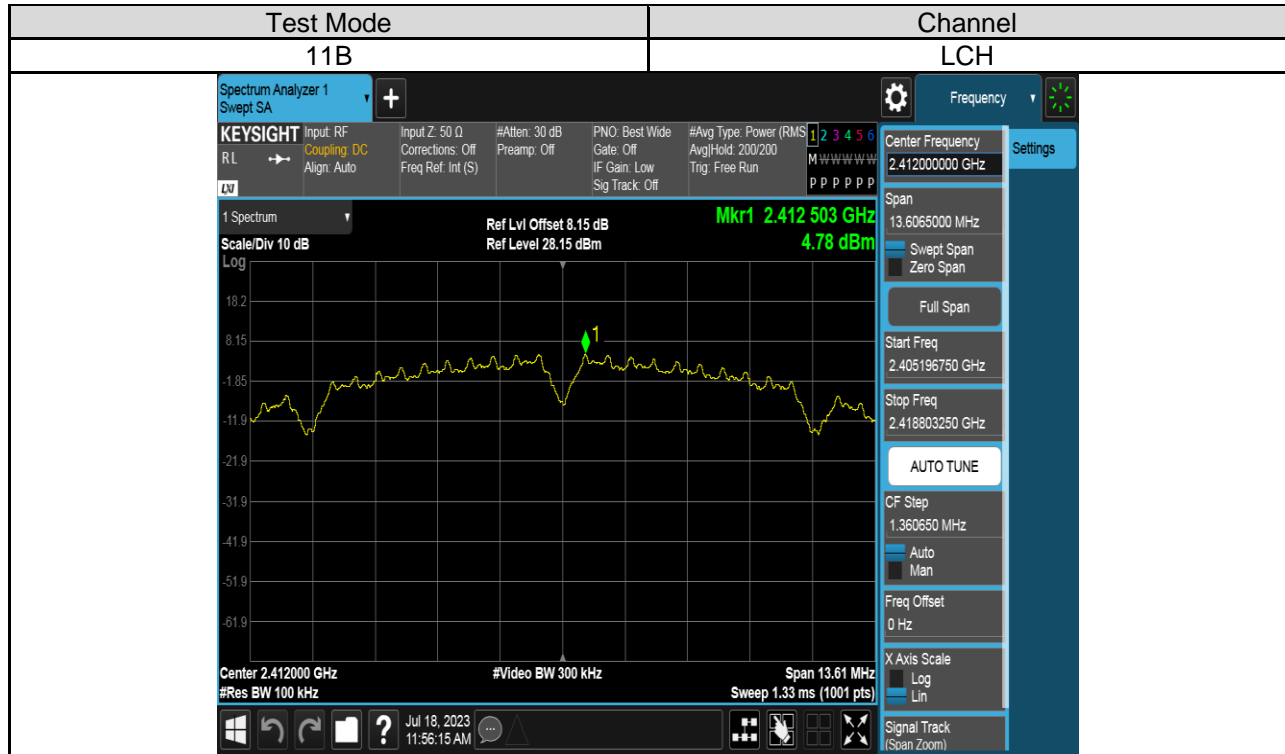

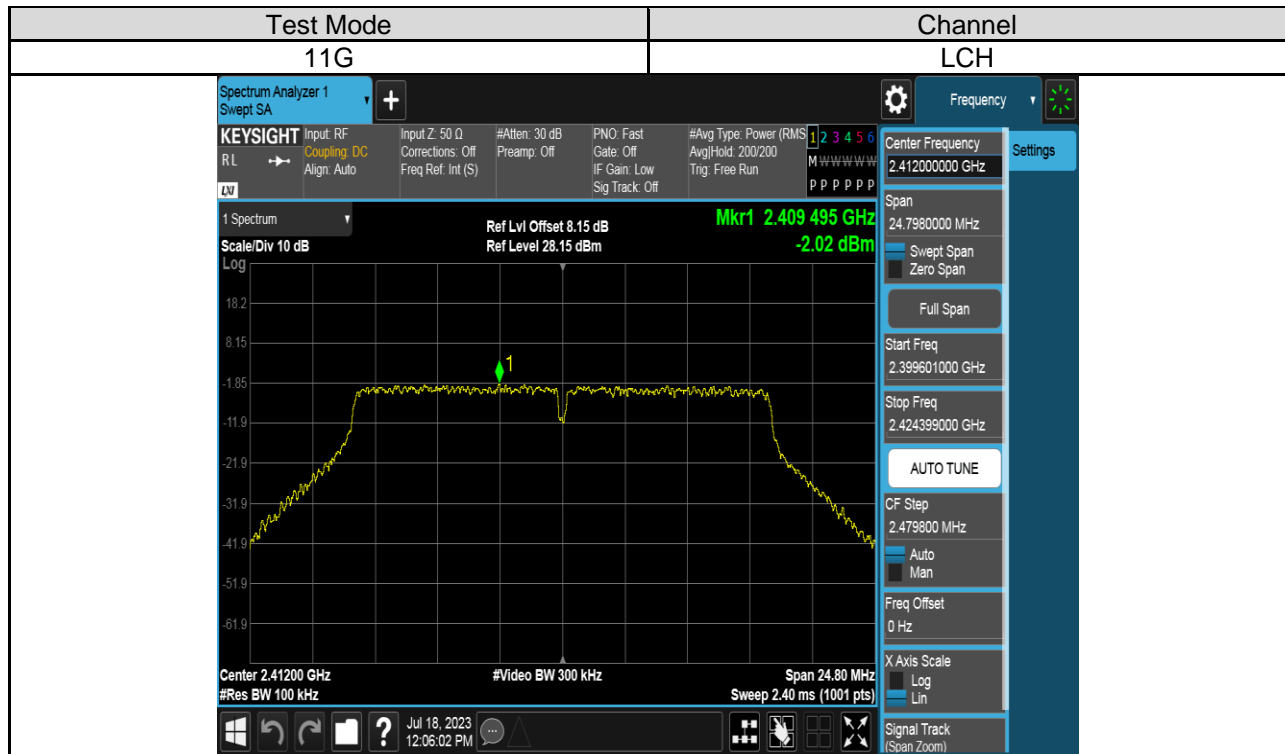
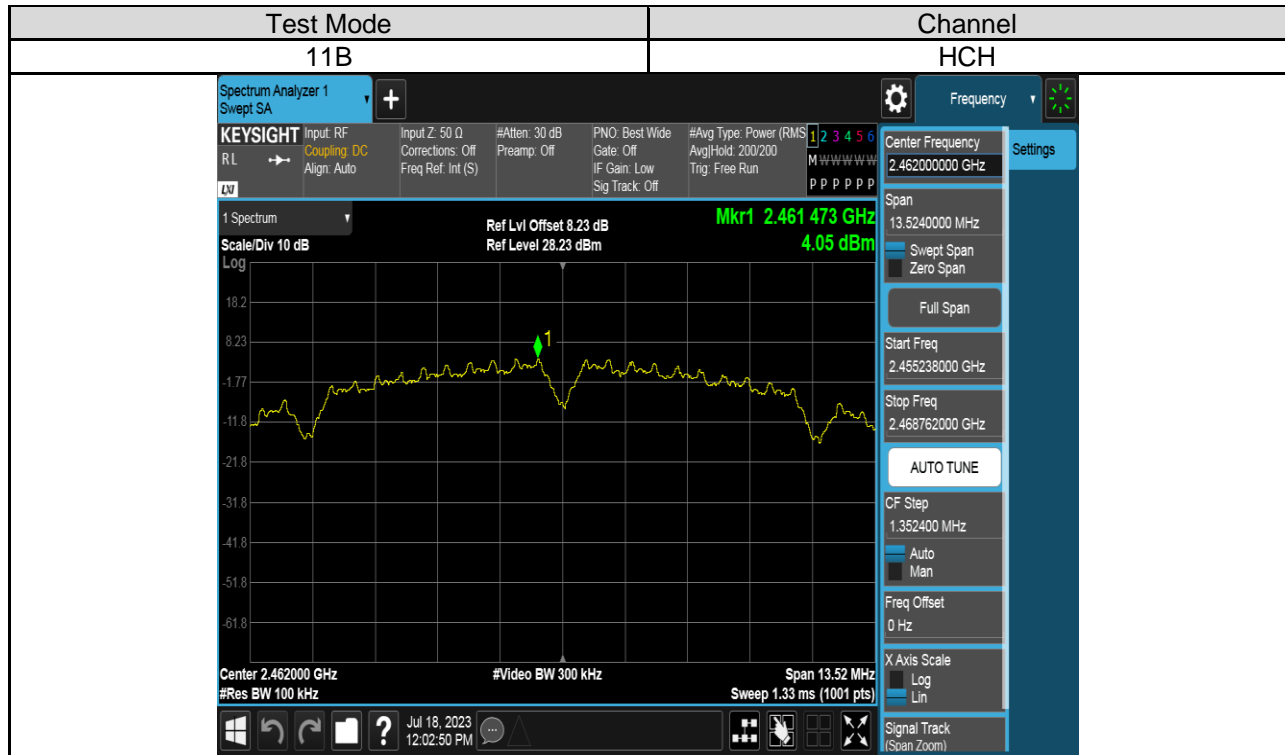

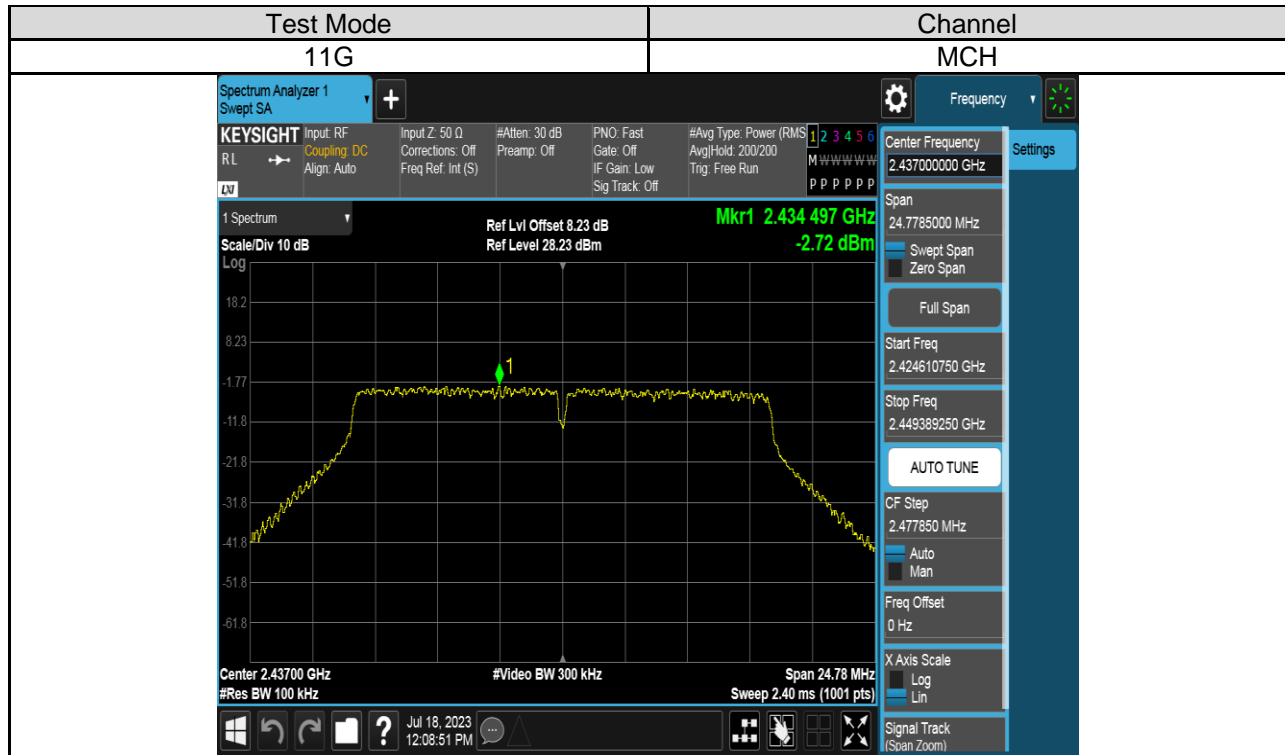

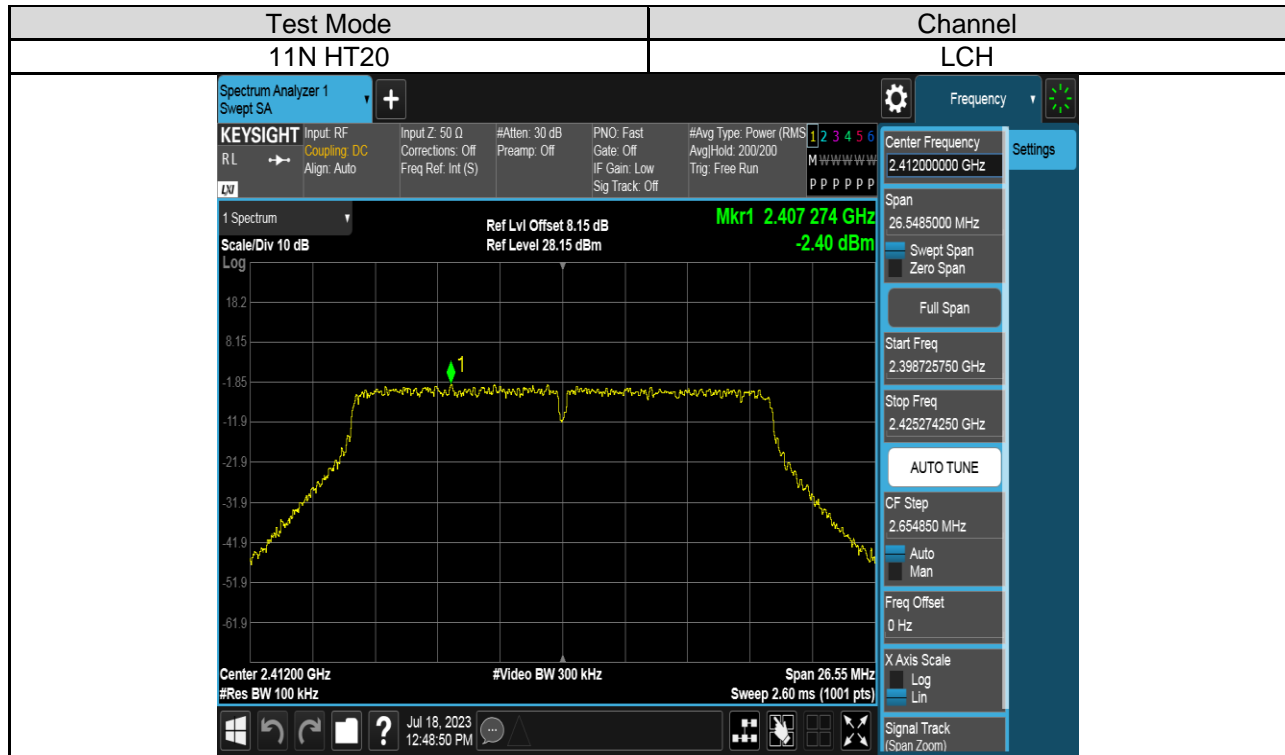

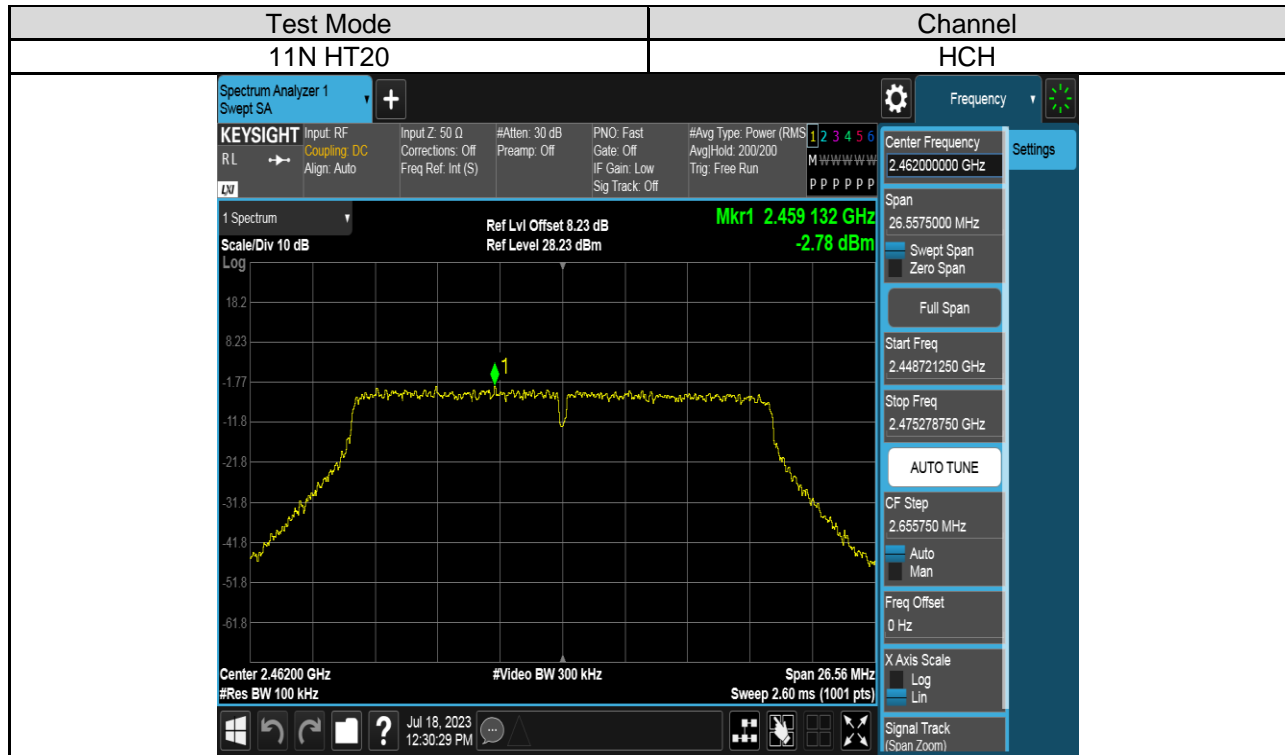



**PART 2: CONDUCTED BANDEDGE****TEST RESULTS TABLE**

<b>Test Mode</b>	<b>Test Channel</b>	<b>Result</b>	<b>Verdict</b>
11B	LCH	Refer to the Test Graph	PASS
	HCH	Refer to the Test Graph	PASS
11G	LCH	Refer to the Test Graph	PASS
	HCH	Refer to the Test Graph	PASS
11N HT20	LCH	Refer to the Test Graph	PASS
	HCH	Refer to the Test Graph	PASS

**TEST GRAPHS**

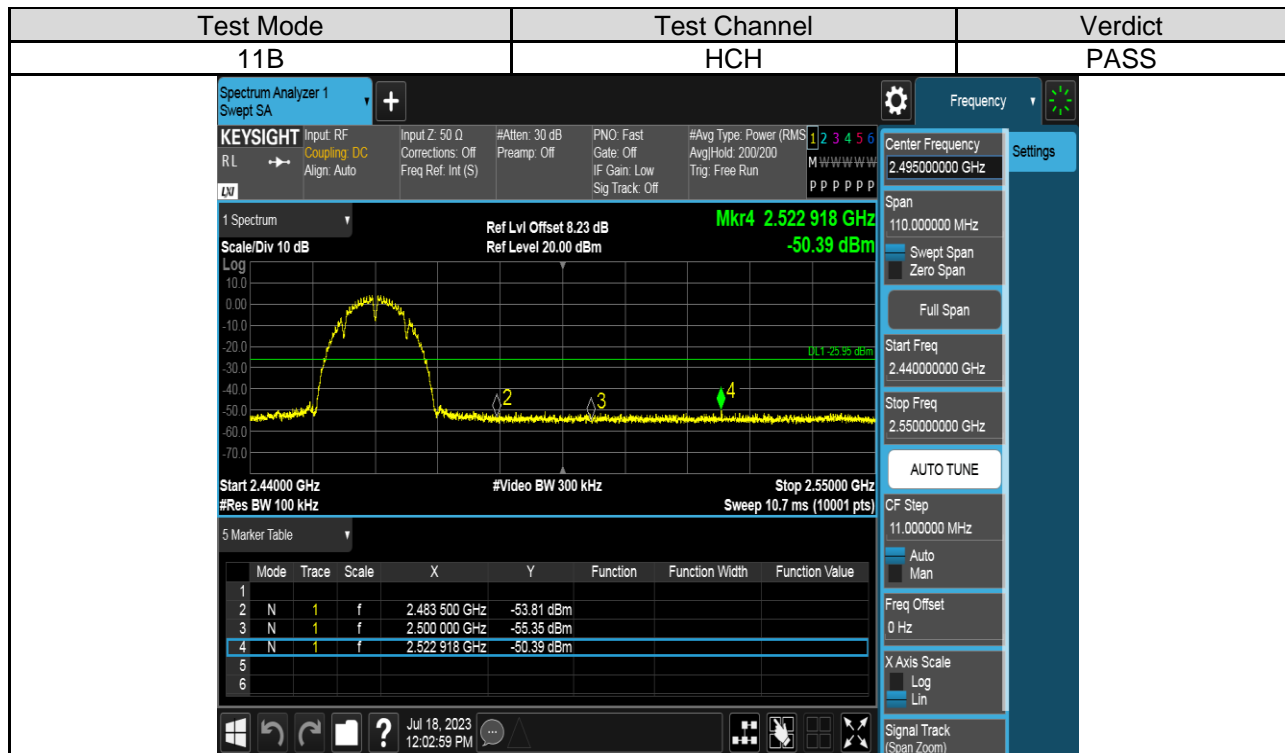
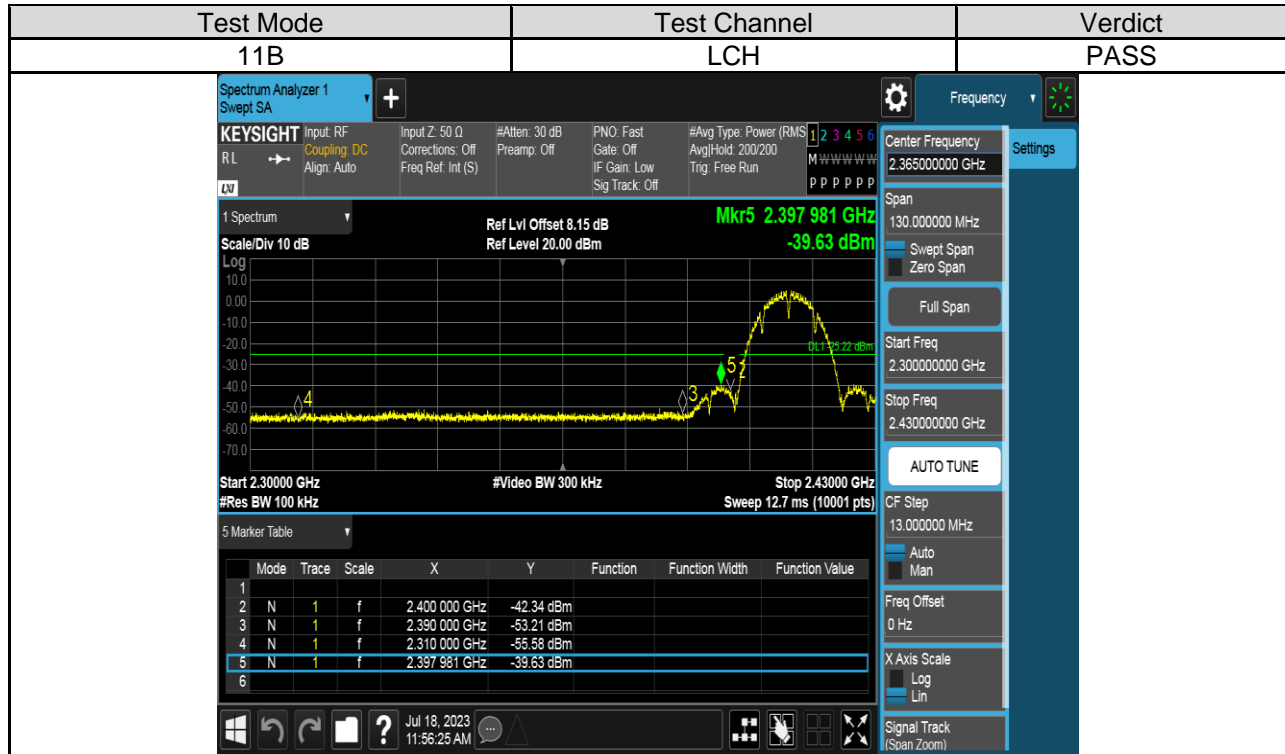

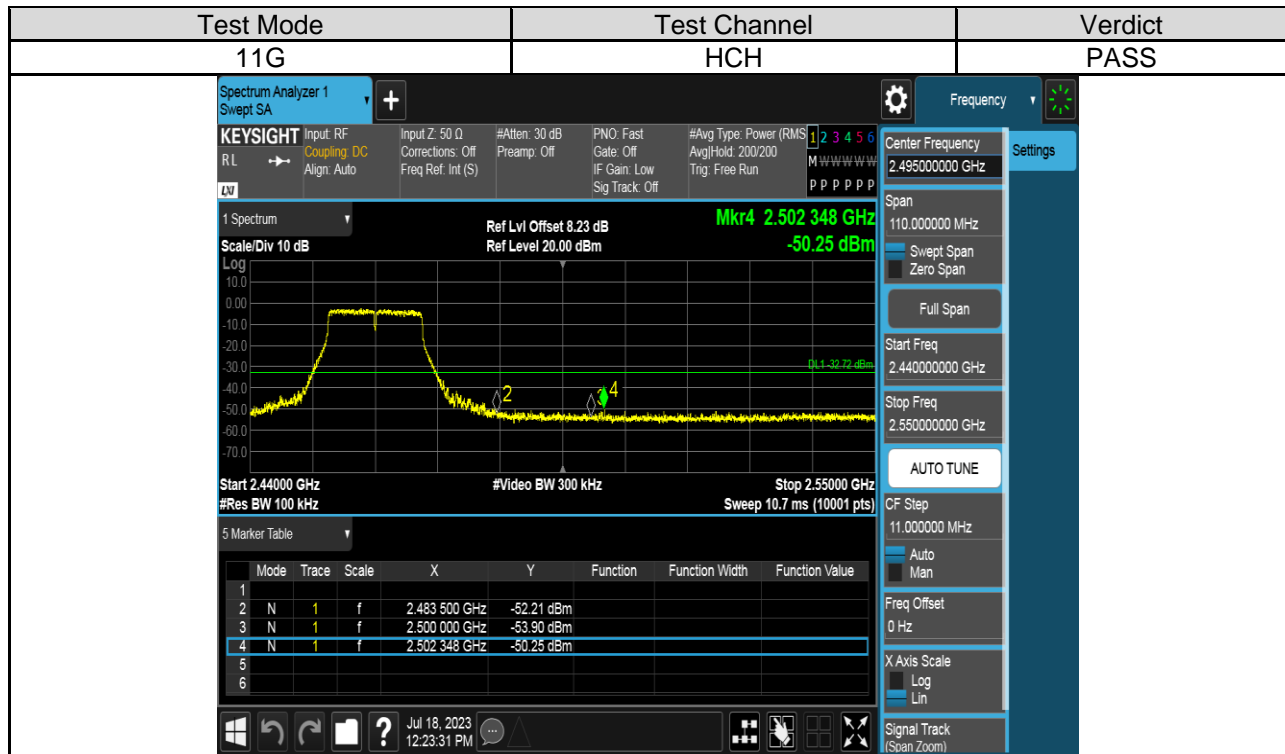
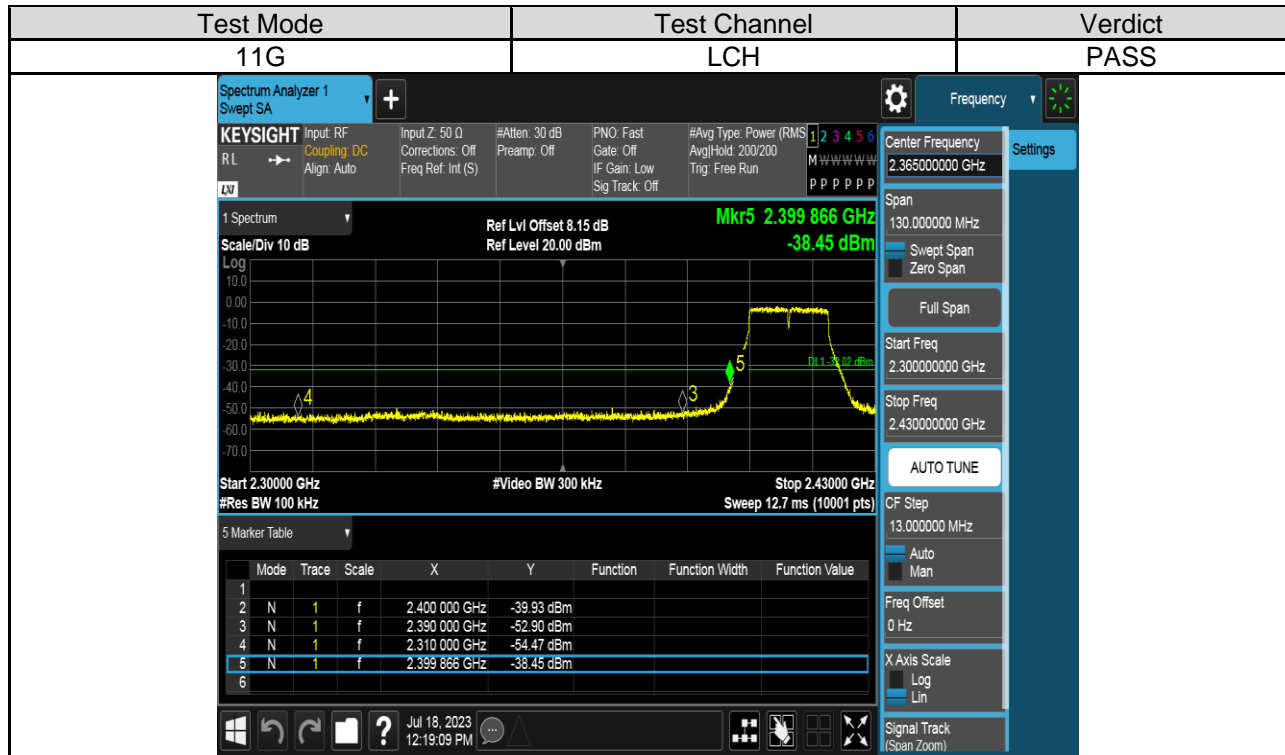

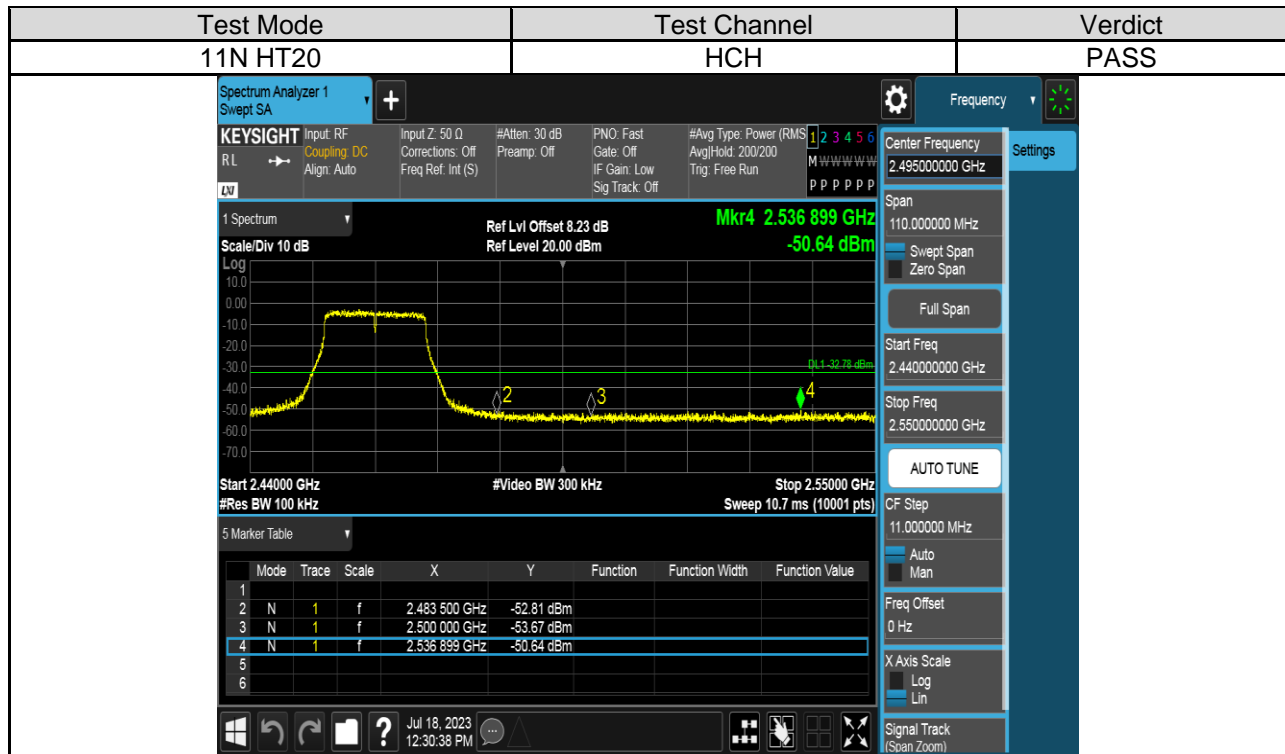
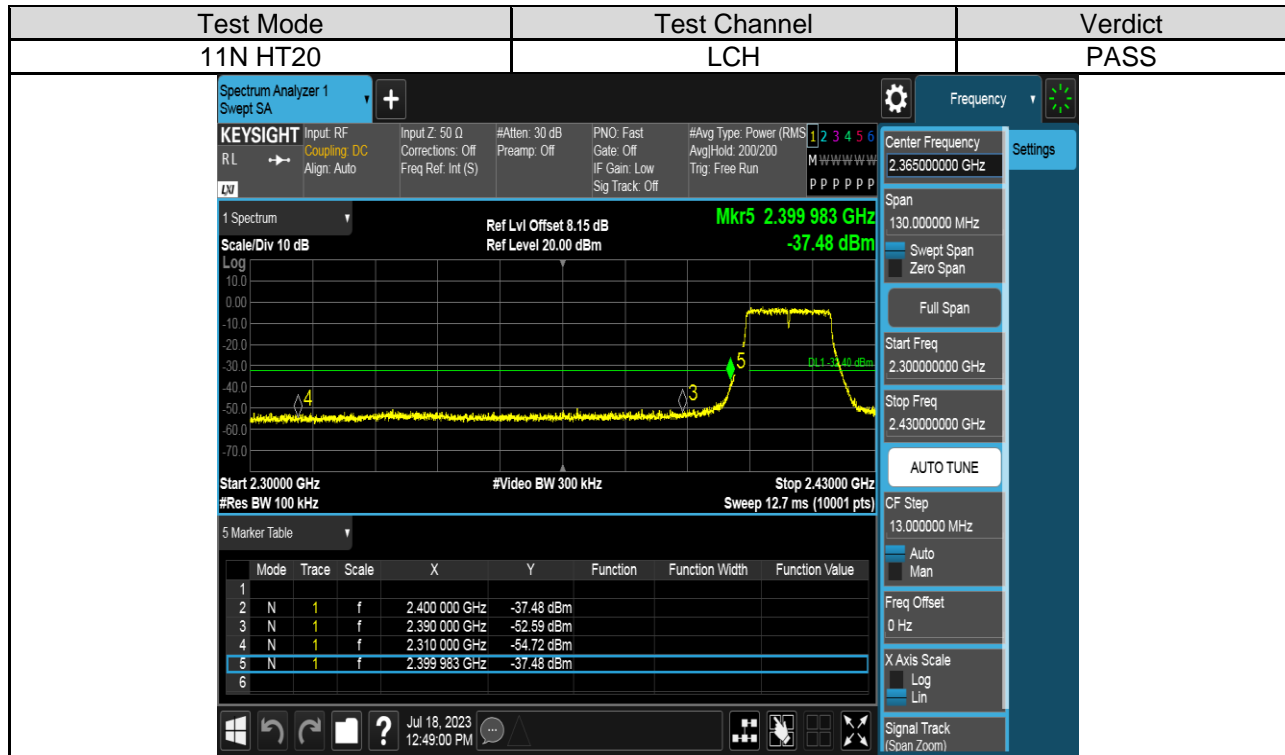

**PART 3: CONDUCTED SPURIOUS EMISSION****TEST RESULTS TABLE**

Test Mode	Test Channel	Result	Verdict
11B	LCH	Refer to the Test Graph	PASS
	MCH	Refer to the Test Graph	PASS
	HCH	Refer to the Test Graph	PASS
11G	LCH	Refer to the Test Graph	PASS
	MCH	Refer to the Test Graph	PASS
	HCH	Refer to the Test Graph	PASS
11N HT20	LCH	Refer to the Test Graph	PASS
	MCH	Refer to the Test Graph	PASS
	HCH	Refer to the Test Graph	PASS

**TEST GRAPHS**

Test Mode	Channel	Verdict
11B	LCH	PASS

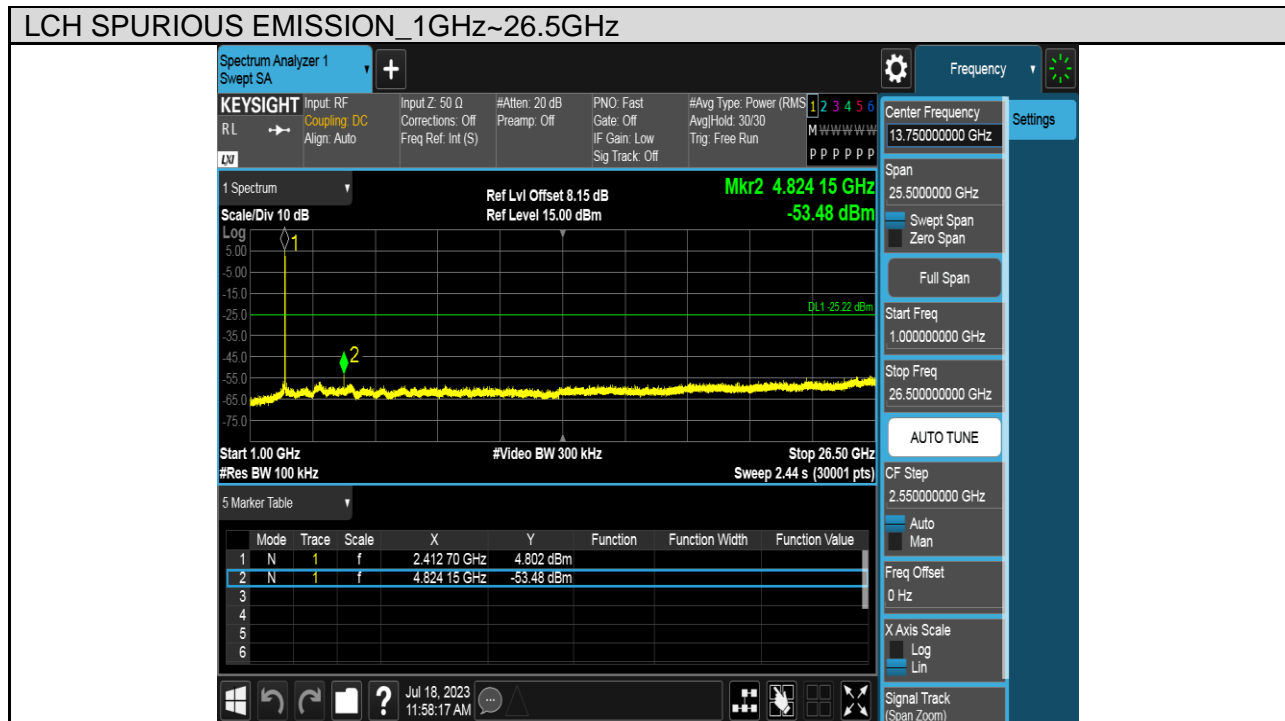
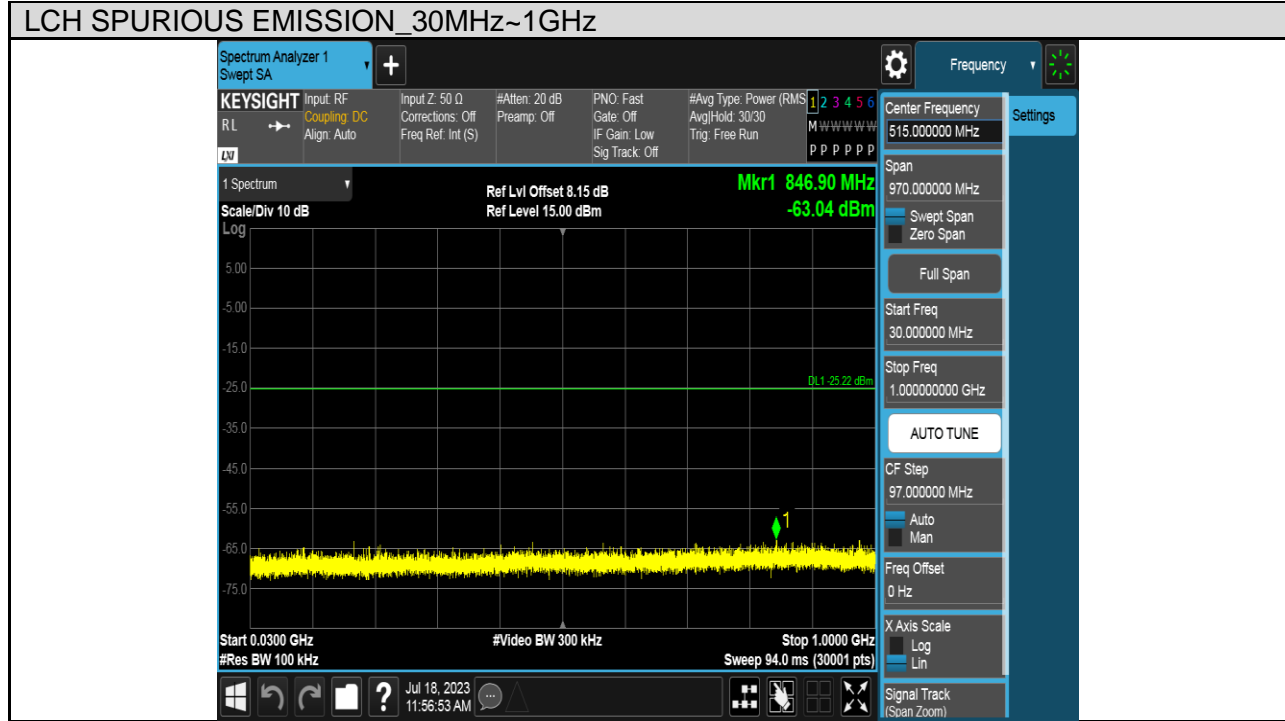

Test Mode	Channel	Verdict
11B	MCH	PASS

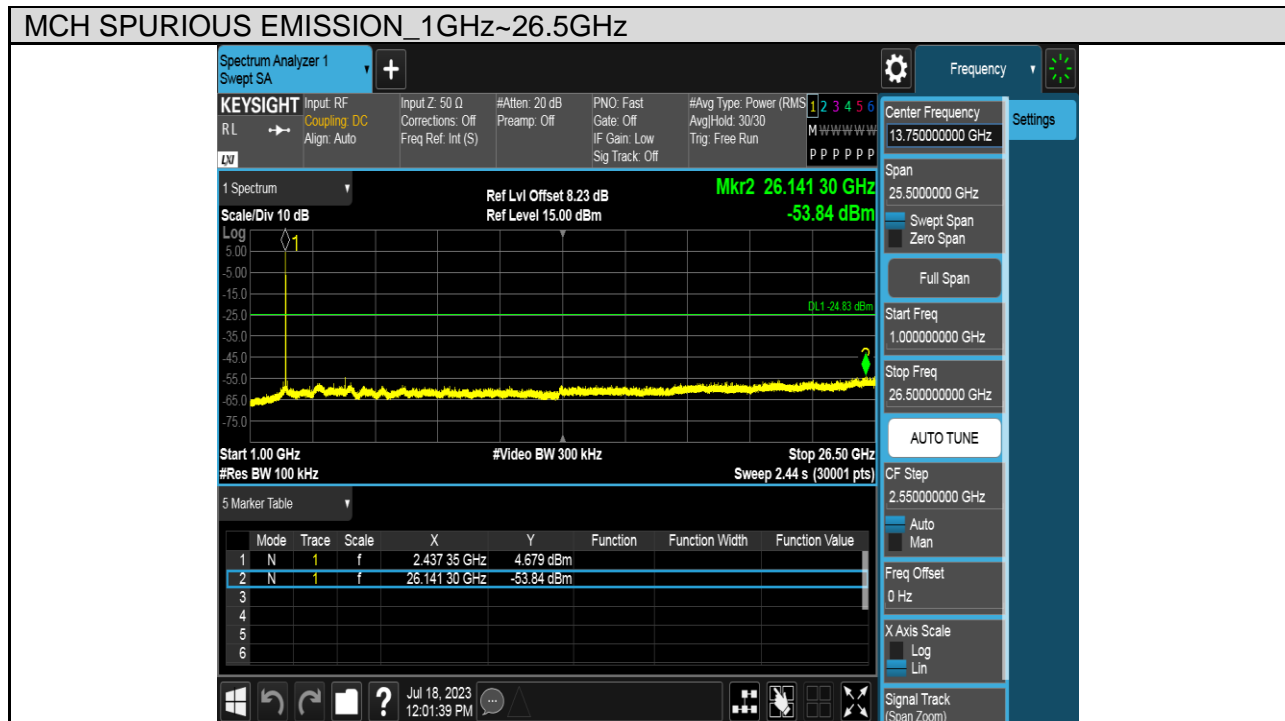
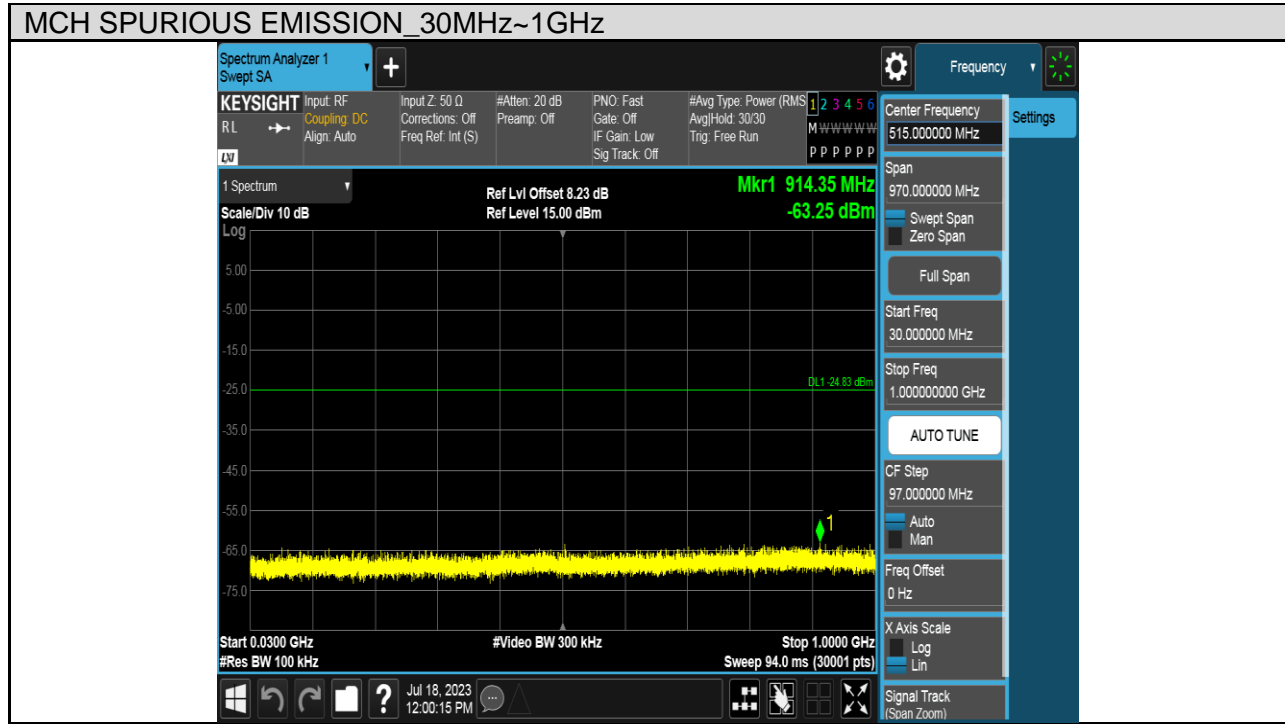

Test Mode	Channel	Verdict
11B	HCH	PASS

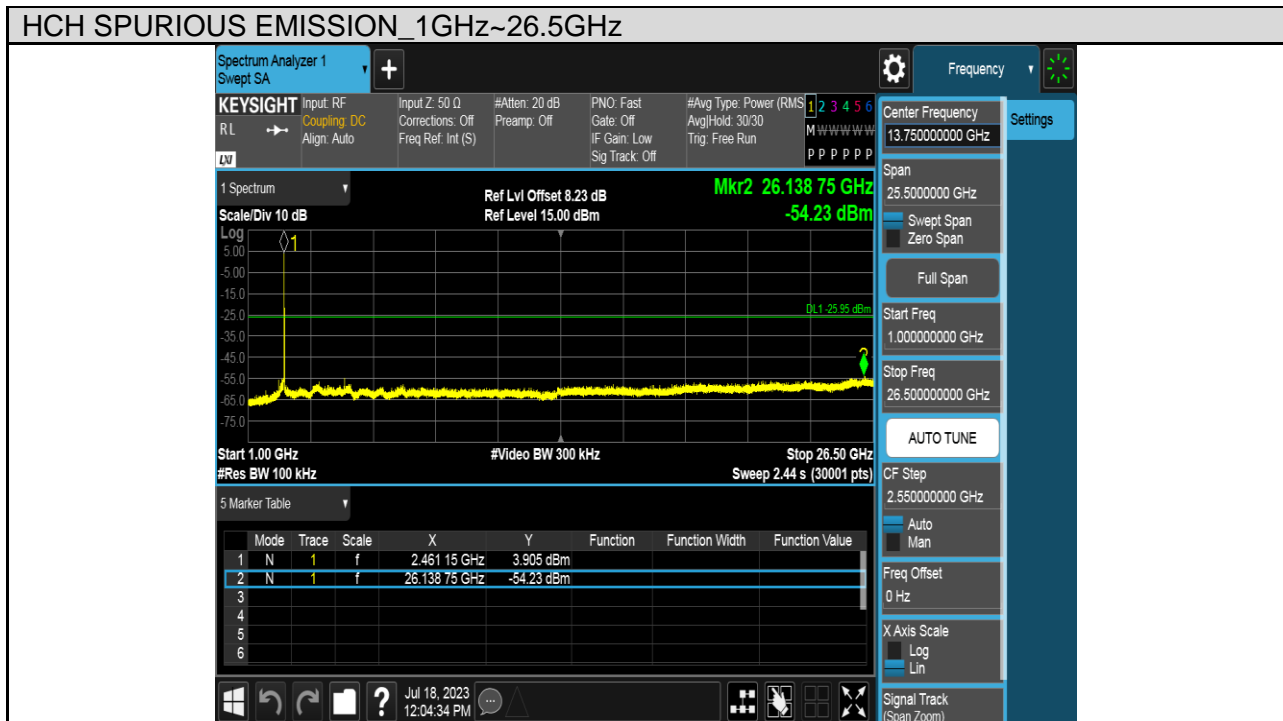
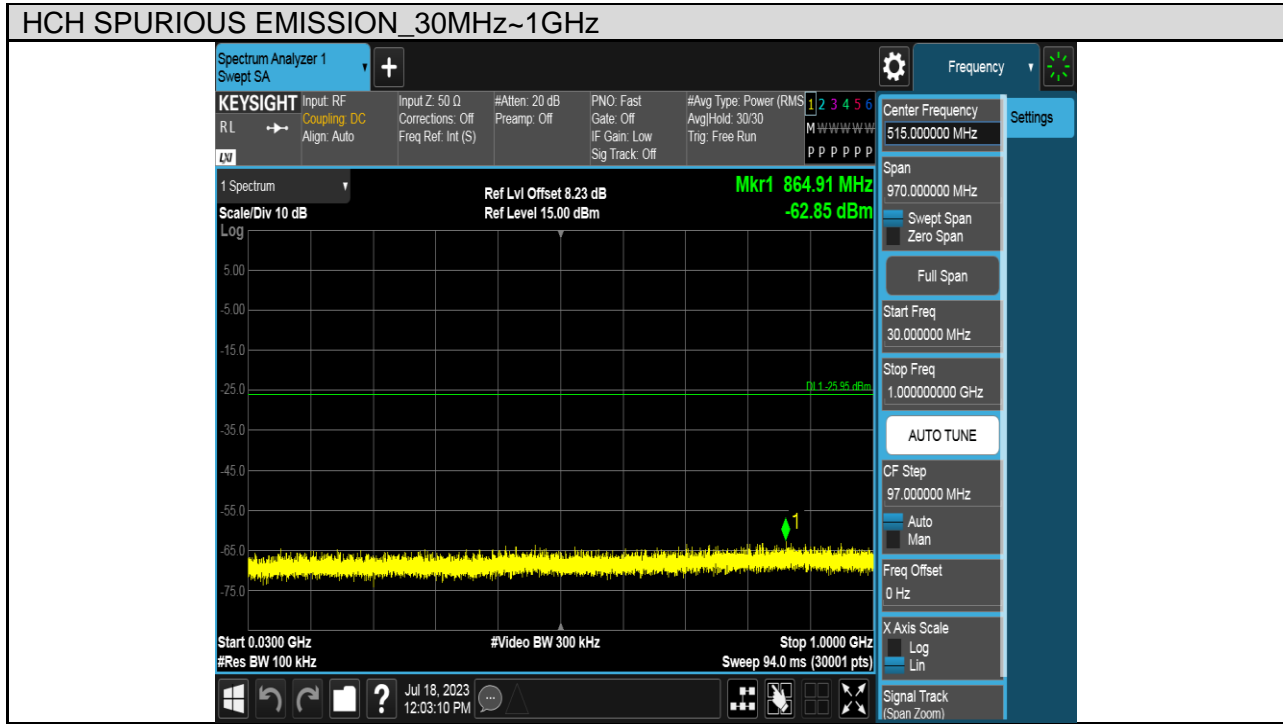



Test Mode	Channel	Verdict
11G	LCH	PASS

