



FCC 47 CFR PART 15 SUBPART C
CERTIFICATION TEST REPORT

For

IP Camera

MODEL NUMBER: IPC6415SR-X5UPW-VG

ADDITIONAL MODEL NUMBER:
IPC6415SR-X5UPW-VG-NB, IPC6412LR-X5UPW-VG, IPC6412LR-X5UPW-VG-NB

PROJECT NUMBER: 4789729351

REPORT NUMBER: 4789729351-1

FCC ID: 2AL8S-0235C4PX

ISSUE DATE: Jan. 06, 2021

Prepared for

Zhejiang Uniview Technologies Co., Ltd.

Prepared by

UL-CCIC COMPANY LIMITED
No. 2, Chengwan Road, Suzhou Industrial Park, People's Republic of China
Tel: +86 512-6808 6400
Fax: +86 512-6808 4099
Website: www.ul.com



Revision History

| <u>Rev.</u> | <u>Issue Date</u> | <u>Revisions</u> | <u>Revised By</u> |
|-------------|-------------------|------------------|-------------------|
| V0 | 01/06/2020 | Initial Issue | |



TABLE OF CONTENTS

| | |
|------------------------------------------------------------|------------|
| 1. ATTESTATION OF TEST RESULTS | 4 |
| 2. TEST METHODOLOGY | 6 |
| 3. FACILITIES AND ACCREDITATION | 6 |
| 4. CALIBRATION AND UNCERTAINTY | 7 |
| 4.1. <i>MEASURING INSTRUMENT CALIBRATION</i> | <i>7</i> |
| 4.2. <i>MEASUREMENT UNCERTAINTY.....</i> | <i>7</i> |
| 5. EQUIPMENT UNDER TEST | 8 |
| 5.1. <i>DESCRIPTION OF EUT</i> | <i>8</i> |
| 5.2. <i>MAXIMUM OUTPUT POWER.....</i> | <i>9</i> |
| 5.3. <i>CHANNEL LIST</i> | <i>9</i> |
| 5.4. <i>TEST CHANNEL CONFIGURATION.....</i> | <i>10</i> |
| 5.5. <i>THE WORSE CASE POWER SETTING PARAMETER.....</i> | <i>10</i> |
| 5.6. <i>DESCRIPTION OF AVAILABLE ANTENNAS</i> | <i>11</i> |
| 5.7. <i>THE WORSE CASE CONFIGURATIONS</i> | <i>11</i> |
| 5.8. <i>TEST ENVIRONMENT</i> | <i>12</i> |
| 5.9. <i>DESCRIPTION OF TEST SETUP.....</i> | <i>13</i> |
| 5.10. <i>MEASURING INSTRUMENT AND SOFTWARE USED</i> | <i>15</i> |
| 6. MEASUREMENT METHODS | 16 |
| 7. ANTENNA PORT TEST RESULTS | 17 |
| 7.1. <i>ON TIME AND DUTY CYCLE.....</i> | <i>17</i> |
| 7.2. <i>6 dB BANDWIDTH.....</i> | <i>20</i> |
| 7.3. <i>CONDUCTED OUTPUT POWER.....</i> | <i>28</i> |
| 7.4. <i>POWER SPECTRAL DENSITY.....</i> | <i>30</i> |
| 7.5. <i>CONDUCTED BANDEDGE AND SPURIOUS EMISSIONS.....</i> | <i>38</i> |
| 7.6. <i>RADIATED TEST RESULTS</i> | <i>68</i> |
| 7.6.1. <i>LIMITS AND PROCEDURE</i> | <i>68</i> |
| 7.6.2. <i>TEST ENVIRONMENT</i> | <i>74</i> |
| 7.6.3. <i>RESTRICTED BANDEDGE</i> | <i>74</i> |
| 7.6.4. <i>SPURIOUS EMISSIONS</i> | <i>91</i> |
| 8. AC POWER LINE CONDUCTED EMISSIONS..... | 147 |
| 9. ANTENNA REQUIREMENTS..... | 150 |



1. ATTESTATION OF TEST RESULTS

Applicant Information

Company Name: Zhejiang Uniview Technologies Co., Ltd.
Address: 88 JIANGLING RD, BINJIANG DISTRICT, HANGZHOU, ZHEJIANG 310051, CHINA

Manufacturer Information

Company Name: Zhejiang Uniview Technologies Co., Ltd.
Address: 88 JIANGLING RD, BINJIANG DISTRICT, HANGZHOU, ZHEJIANG 310051, CHINA

Factory Information-1

Company Name: Zhejiang Uniview Systems Technology Co., Ltd.
Address: NO.1277, QINGFENG SOUTH ROAD (SOUTH), TONGXIANG ECONOMIC DEVELOPMENT ZONE, TONGXIANG CITY, JIAXING, ZHEJIANG 310000, CHINA

Factory Information-2

Company Name: TDG Technology Co., Ltd.
Address: YATAI ROAD NO.1, NANHU DISTRICT, JIAXING, ZHEJIANG 314050, CHINA

Factory Information-3

Company Name: DBG TECHNOLOGY (INDIA) PRIVATE LIMITED
Address: PLOT NO. 2, SECTOR-8, IMT BAWAL REWARI HARYANA 123501, INDIA

EUT Description

Product Name: IP Camera
Model Name: IPC6415SR-X5UPW-VG
Additional No.: IPC6415SR-X5UPW-VG-NB, IPC6412LR-X5UPW-VG, IPC6412LR-X5UPW-VG-NB
Sample Number: 3476622
Data of Receipt Sample: Dec. 06, 2020
Date Tested: Dec. 10, 2020 ~ Dec. 30, 2020

| APPLICABLE STANDARDS | |
|--------------------------|--------------|
| STANDARD | TEST RESULTS |
| CFR 47 Part 15 Subpart C | PASS |



| Summary of Test Results | | | |
|--------------------------------------------------------------------------------------------------------------------------------------------------------------------------------------------------|-------------------------------------------|--------------------------------------------|--------------|
| Clause | Test Items | FCC Rules | Test Results |
| 1 | 6db DTS Bandwidth | FCC 15.247 (a) (2) | PASS |
| 2 | Conducted Power | FCC 15.247 (b) (3) | PASS |
| 3 | Power Spectral Density | FCC 15.247 (e) | PASS |
| 4 | Conducted Band edge And Spurious emission | FCC 15.247 (d) | PASS |
| 5 | Radiated Band edges and Spurious emission | FCC 15.247 (d) FCC 15.209 FCC 15.205 | PASS |
| 6 | Conducted Emission Test For AC Power Port | FCC 15.207 | PASS |
| 7 | Antenna Requirement | FCC 15.203 | PASS |
| Remark: 1) The measurement result for the sample received is <Pass> according to < ANSI C63.10-2013, FCC CFR 47 Part 2, FCC CFR 47 Part 15C> when <Accuracy Method> decision rule is applied. | | | |

Prepared By:

Jason Yang

Jason Yang
Engineer

Reviewed By:

Tom Tang

Tom Tang
Engineer Project Associate

Authorized By:

Chris Zhong

Chris Zhong
Laboratory Leader



2. TEST METHODOLOGY

The tests documented in this report were performed in accordance with FCC KDB 558074 D01 15.247 Meas Guidance v05r02, KDB 414788 D01 Radiated Test Site v01r01, ANSI C63.10-2013, FCC CFR 47 Part 2, FCC CFR 47 Part 15.

3. FACILITIES AND ACCREDITATION

| | |
|---------------------------|----------------------------------------------------------------------------------------------------------------------------------------------------------------------------------------------------------------------------------------------------------------------------------------------------------------------------------------------------------------------------------------------------------------------------------------------------------------------------------------------------------------------------------------------------------------------------------------------------------------------------|
| Accreditation Certificate | <p>A2LA (Certificate No.: 4829.01) UL-CCIC COMPANY LIMITED has been assessed and proved to be in compliance with A2LA.</p> <p>FCC (FCC Designation No.: CN1247) UL-CCIC COMPANY LIMITED has been recognized to perform compliance testing on equipment subject to the Commission's Declaration of Conformity (DoC) and Certification rules.</p> <p>IC (IC Designation No.: 25056) UL-CCIC COMPANY LIMITED has been recognized to perform compliance testing on equipment subject to the Commission's Declaration of Conformity (DoC) and Certification rules.</p> |
|---------------------------|----------------------------------------------------------------------------------------------------------------------------------------------------------------------------------------------------------------------------------------------------------------------------------------------------------------------------------------------------------------------------------------------------------------------------------------------------------------------------------------------------------------------------------------------------------------------------------------------------------------------------|

Note 1: All tests measurement facilities use to collect the measurement data are located at No. 2, Chengwan Road, Suzhou Industrial Park, Suzhou 215122, People's Republic of China

Note 2: For below 30MHz, lab had performed measurements at test anechoic chamber and comparing to measurements obtained on an open field site. These measurements below 30MHz had been correlated to measurements performed on an OFS.

Note 3: The test anechoic chamber in UL-CCIC COMPANY LIMITED had been calibrated and compared to the open field sites and the test anechoic chamber is shown to be equivalent to or worst case from the open field site.



4. CALIBRATION AND UNCERTAINTY

4.1. MEASURING INSTRUMENT CALIBRATION

The measuring equipment utilized to perform the tests documented in this report has been calibrated in accordance with the manufacturer's recommendations, and is traceable to recognized national standards.

4.2. MEASUREMENT UNCERTAINTY

Where relevant, the following measurement uncertainty levels have been estimated for tests performed on the apparatus:

| Test Item | Uncertainty |
|-----------------------------------------------------------------------------------------------------------------------------------------------|----------------------|
| Conduction emission | 3.1dB |
| Radiation Emission test(include Fundamental emission) (9KHz-30MHz) | 3.3dB |
| Radiation Emission test(include Fundamental emission) (30MHz-1GHz) | 3.3dB |
| Radiation Emission test (1GHz to 26GHz)(include Fundamental emission) | 3.9dB (1GHz-18Gz) |
| | 4.2dB (18GHz-26.5Gz) |
| Note: This uncertainty represents an expanded uncertainty expressed at approximately the 95% confidence level using a coverage factor of k=2. | |



5. EQUIPMENT UNDER TEST

5.1. DESCRIPTION OF EUT

| | |
|-----------------------|----------------------------------------------------------------------------------------------------------------------------------------------------------------------|
| Product Name: | IP Camera |
| Model No.: | IPC6415SR-X5UPW-VG |
| Operating Frequency: | IEEE 802.11b/g/n(HT20): 2412MHz to 2462MHz IEEE 802.11n(HT40): 2422MHz to 2452MHz |
| Type of Modulation: | IEEE for 802.11b: DSSS (CCK, DQPSK, DBPSK) IEEE for 802.11g: OFDM (64QAM, 16QAM, QPSK, BPSK) IEEE for 802.11n (HT20 and HT40): OFDM (64QAM, 16QAM, QPSK, BPSK) |
| Channels Step: | Channels with 5MHz step |
| Sample Type: | Fixed production |
| Test power grade: | N/A |
| Test software of EUT: | Secure CRT (manufacturer declare) |
| Antenna Type: | IFA Antenna |
| Antenna Gain: | 3.5 dBi |

Remark:

Model No.:

| No.: | Name: | No.: | Name: | No.: | Name: |
|------|-----------------------|------|-----------------------|------|--------------------|
| 1 | IPC6415SR-X5UPW-VG | 2 | IPC6415SR-X5UPW-VG-NB | 3 | IPC6412LR-X5UPW-VG |
| 4 | IPC6412LR-X5UPW-VG-NB | | | | |

Only the main model IPC6415SR-X5UPW-VG was tested and only the data of this model is shown in this test report. Since Their material, types of encloser, antenna location, electrical circuit design, layout, components used and internal wiring are identical, only the model name and software are different and the user can't change the RF parameters or others access the software setting.



5.2. MAXIMUM OUTPUT POWER

| Number of Transmit Chains (NTX) | IEE Std. 802.11 | Channel Number | Max AVG Conducted Power (dBm) |
|---------------------------------|------------------|----------------|-------------------------------|
| 1 | IEEE 802.11B | 1-11[11] | 13.38 |
| 1 | IEEE 802.11G | 1-11[11] | 11.30 |
| 1 | IEEE 802.11nHT20 | 1-11[11] | 10.30 |
| 1 | IEEE 802.11nHT40 | 3-9[7] | 9.65 |

5.3. CHANNEL LIST

| Channel List for 802.11b/g/n (20 MHz) | | | | | | | |
|---------------------------------------|-----------------|---------|-----------------|---------|-----------------|---------|-----------------|
| Channel | Frequency (MHz) | Channel | Frequency (MHz) | Channel | Frequency (MHz) | Channel | Frequency (MHz) |
| 1 | 2412 | 4 | 2427 | 7 | 2442 | 10 | 2457 |
| 2 | 2417 | 5 | 2432 | 8 | 2447 | 11 | 2462 |
| 3 | 2422 | 6 | 2437 | 9 | 2452 | | |

| Channel List for 802.11n (40 MHz) | | | | | | | |
|-----------------------------------|-----------------|---------|-----------------|---------|-----------------|---------|-----------------|
| Channel | Frequency (MHz) | Channel | Frequency (MHz) | Channel | Frequency (MHz) | Channel | Frequency (MHz) |
| 3 | 2422 | 5 | 2432 | 7 | 2442 | 9 | 2452 |
| 4 | 2427 | 6 | 2437 | 8 | 2447 | | |



5.4. TEST CHANNEL CONFIGURATION

| Test Mode | Test Channel (MHz) |
|-------------------|--------------------|
| IEEE 802.11B | LCH :CH01 2412 |
| | MCH: CH06 2437 |
| | HCH: CH11 2462 |
| IEEE 802.11G | LCH :CH01 2412 |
| | MCH: CH06 2437 |
| | HCH: CH11 2462 |
| IEEE 802.11n HT20 | LCH :CH01 2412 |
| | MCH: CH06 2437 |
| | HCH: CH11 2462 |
| IEEE 802.11n HT40 | LCH :CH03 2422 |
| | MCH: CH06 2437 |
| | HCH: CH09 2452 |

5.5. THE WORSE CASE POWER SETTING PARAMETER

| The Worse Case Power Setting Parameter under 2400 ~ 2483.5MHz Band | | | | | | | |
|--------------------------------------------------------------------|-------------------------|--------------|------|-------|------------|------|------|
| Test Software | | SecureCRT | | | | | |
| Modulation Mode | Transmit Antenna Number | Test Channel | | | | | |
| | | NCB: 20MHz | | | NCB: 40MHz | | |
| | | CH 1 | CH 6 | CH 11 | CH 3 | CH 6 | CH 9 |
| 802.11b | 1 | N/A | N/A | N/A | / | | |
| 802.11g | 1 | N/A | N/A | N/A | | | |
| 802.11n HT20 | 1 | N/A | N/A | N/A | | | |
| 802.11n HT40 | 1 | / | | | N/A | N/A | N/A |



5.6. DESCRIPTION OF AVAILABLE ANTENNAS

| Ant. | Frequency (MHz) | Antenna Type | Antenna Gain (dBi) |
|------|-----------------|---------------|--------------------|
| 1 | 2400-2483.5 | Patch Antenna | 3.5 |

| Test Mode | Transmit and Receive Mode | Description |
|---------------------|----------------------------------------------|-----------------------------------------------------------------------|
| IEEE 802.11b | <input checked="" type="checkbox"/> 1TX, 1RX | Antenna1 can be used as transmitting/receiving antenna independently. |
| IEEE 802.11g | <input checked="" type="checkbox"/> 1TX, 1RX | Antenna1 can be used as transmitting/receiving antenna independently. |
| IEEE 802.11N (HT20) | <input checked="" type="checkbox"/> 1TX, 1RX | Antenna1 can be used as transmitting/receiving antenna independently. |
| IEEE 802.11N (HT40) | <input checked="" type="checkbox"/> 1TX, 1RX | Antenna1 can be used as transmitting/receiving antenna independently. |

5.7. THE WORSE CASE CONFIGURATIONS

For WIFI module, the worst-case data rates as provided by the client were:

802.11b mode: 1 Mbps
802.11b mode: 6 Mbps
802.11n HT20 mode: MCS0
802.11n HT40 mode: MCS0



5.8. TEST ENVIRONMENT

| Environment Parameter | Selected Values During Tests | |
|-----------------------|------------------------------|-----------|
| Relative Humidity | 55 ~ 65% | |
| Atmospheric Pressure: | 1025Pa | |
| Temperature | TN | 23 ~ 28°C |
| Voltage : | VL | N/A |
| | VN | AC 120V |
| | VH | N/A |

Note: VL= Lower Extreme Test Voltage
VN= Nominal Voltage
VH= Upper Extreme Test Voltage
TN= Normal Temperature



5.9. DESCRIPTION OF TEST SETUP

SUPPORT EQUIPMENT

| Item | Equipment | Brand Name | Model Name | Description |
|------|------------------------|------------|------------|------------------|
| 1 | Laptop | ThinkPad | E590 | N/A |
| 2 | Alarm Light | N/A | N/A | Supply by UL Lab |
| 3 | Electric-magnetic Lock | N/A | N/A | Supply by UL Lab |

I/O PORT

| Cable No | Port | Connector Type | Cable Type | Cable Length(m) | Remarks |
|----------|------|----------------|------------|-----------------|---------|
| 1 | USB | USB to TTL | USB | 100cm Length | N/A |
| 2 | LAN | LAN | LAN | 100cm Length | N/A |
| 3 | USB | USB | USB | 100cm Length | N/A |

ACCESSORY

| Item | Accessory | Brand Name | Model Name | Description |
|------|------------|------------|--------------------------|------------------------------------------------------------|
| 1 | DC Adapter | HONOTO | ADS-26FSG-12 12018EPG | INPUT:100-240V~50/60Hz 0.7A Max OUTPUT:12.0V=1.5A 18.0W |

TEST SETUP

The EUT can work in an engineer mode with a software through a table PC.

SETUP DIAGRAM FOR TESTS

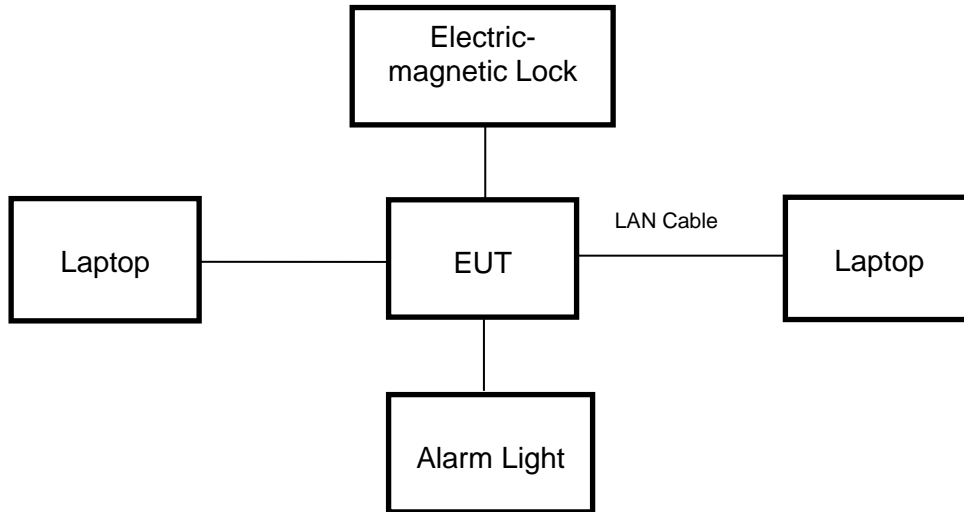



5.10. MEASURING INSTRUMENT AND SOFTWARE USED

| Conducted Emissions (Instrument) | | | | | | | |
|-------------------------------------|-----------------------------------------|----------------------------------|-------------------------------------|-------------|-----------------|------------|------------|
| Used | Equipment | Manufacturer | Model No. | Serial No. | Upper Last Cal. | Last Cal. | Next Cal. |
| <input checked="" type="checkbox"/> | EMI Test Receiver | R&S | ESR3 | 126700 | 2019-12-12 | 2020-12-11 | 2021-12-10 |
| <input checked="" type="checkbox"/> | Two-Line V-Network | R&S | ENV216 | 126701 | 2019-12-12 | 2020-12-11 | 2021-12-10 |
| <input checked="" type="checkbox"/> | Artificial Mains Networks | R&S | ENY81 | 126711 | 2019-12-12 | 2020-12-11 | 2021-12-10 |
| Software | | | | | | | |
| Used | Description | | Manufacturer | Name | Version | | |
| <input checked="" type="checkbox"/> | Test Software for Conducted disturbance | | R&S | EMC32 | Ver. 9.25 | | |
| Radiated Emissions (Instrument) | | | | | | | |
| Used | Equipment | Manufacturer | Model No. | Serial No. | Upper Last Cal. | Last Cal. | Next Cal. |
| <input checked="" type="checkbox"/> | Spectrum Analyzer | Keysight | N9010B | MY57110128 | 2019-05-29 | 2020-05-28 | 2021-05-27 |
| <input checked="" type="checkbox"/> | EMI test receiver | R&S | ESR26 | 1267603 | 2019-12-22 | 2020-12-21 | 2021-12-20 |
| <input checked="" type="checkbox"/> | Receiver Antenna (9kHz-30MHz) | Schwarzbeck | FMZB 1513 | 513-265 | 2019-06-16 | 2020-06-15 | 2021-06-14 |
| <input checked="" type="checkbox"/> | Receiver Antenna (30MHz-1GHz) | SunAR RF Motion | JB1 | 126704 | N/A | 2019-01-28 | 2022-01-27 |
| <input checked="" type="checkbox"/> | Receiver Antenna (1GHz-18GHz) | R&S | HF907 | 126705 | 2019-01-26 | 2020-01-26 | 2021-01-25 |
| <input checked="" type="checkbox"/> | Receiver Antenna (18GHz-26.5GHz) | Schwarzbeck | BBHA9170 | 126706 | 2019-02-06 | 2020-02-05 | 2021-02-04 |
| <input checked="" type="checkbox"/> | Receiver Antenna (26.5GHz-40GHz) | TOYO | HAP 26-40W | 00000012 | 2019-07-23 | 2020-07-22 | 2021-07-21 |
| <input checked="" type="checkbox"/> | Pre-amplification (To 1GHz) | R&S | SCU-03D | 134666 | 2019-02-06 | 2020-02-05 | 2021-02-04 |
| <input checked="" type="checkbox"/> | Pre-amplification (To 18GHz) | Compliance Direction System Inc. | PAP-1G18-50 | 14140-13467 | 2019-03-18 | 2020-03-17 | 2021-03-16 |
| <input checked="" type="checkbox"/> | Pre-amplification (To 26.5GHz) | R&S | SCU-26D | 134668 | 2019-02-06 | 2020-02-05 | 2021-02-04 |
| <input checked="" type="checkbox"/> | Band Reject Filter | Wainwright | WRCJV8-2350-2400-2483.5-2533.5-40SS | 1 | 2019-05-29 | 2020-05-28 | 2021-05-27 |
| <input checked="" type="checkbox"/> | Highpass Filter | Wainwright | WHKX10-2700-3000-18000-40SS | 2 | 2019-05-29 | 2020-05-28 | 2021-05-27 |
| Software | | | | | | | |
| Used | Description | | Manufacturer | Name | Version | | |
| <input checked="" type="checkbox"/> | Test Software for Radiated disturbance | | Tonscend | JS32 | V1.0 | | |
| Other instruments | | | | | | | |
| Used | Equipment | Manufacturer | Model No. | Serial No. | Upper Last Cal. | Last Cal. | Next Cal. |
| <input checked="" type="checkbox"/> | Spectrum Analyzer | Keysight | N9010B | MY57110128 | 2019-05-29 | 2020-05-28 | 2021-05-27 |
| <input checked="" type="checkbox"/> | Power Meter | Keysight | U2021XA | MY57110002 | 2019-06-12 | 2020-06-11 | 2021-06-10 |



6. MEASUREMENT METHODS

| No. | Test Item | KDB Name | Section |
|-----|-----------------------------------------------|--------------------------------------------|-----------------|
| 1 | 6dB Bandwidth | KDB 558074 D01 15.247 Meas Guidance v05r02 | 8.2 |
| 2 | Output Power | KDB 558074 D01 15.247 Meas Guidance v05r02 | 8.3.1.3/8.3.2.3 |
| 3 | Power Spectral Density | KDB 558074 D01 15.247 Meas Guidance v05r02 | 8.4 |
| 4 | Out-of-band emissions in non-restricted bands | KDB 558074 D01 15.247 Meas Guidance v05r02 | 8.5 |
| 5 | Out-of-band emissions in restricted bands | KDB 558074 D01 15.247 Meas Guidance v05r02 | 8.6 |
| 6 | Band-edge | KDB 558074 D01 15.247 Meas Guidance v05r02 | 8.7 |
| 7 | Conducted Emission Test For AC Power Port | ANSI C63.10-2013 | 6.2 |



7. ANTENNA PORT TEST RESULTS

7.1. ON TIME AND DUTY CYCLE

LIMITS

None; for reporting purposes only

PROCEDURE

FCC KDB 558074 Zero-Span Spectrum Analyzer Method

TEST SETUP

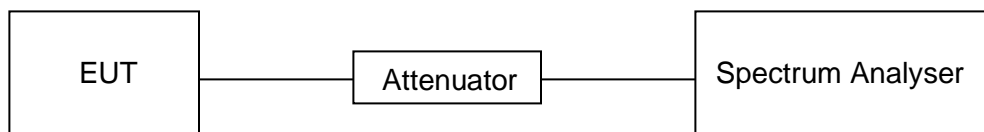

TEST ENVIRONMENT

| | | | |
|---------------------|--------|-------------------|---------|
| Temperature | 22°C | Relative Humidity | 56% |
| Atmosphere Pressure | 101kPa | Test Voltage | AC 120V |

TEST RESULTS TABLE

| Mode | On Time (msec) | Period (msec) | Duty Cycle x (Linear) | Duty Cycle (%) | Duty Cycle Correction Factor (db) | 1/T Minimum VBW (kHz) | Final VBW (kHz) |
|--------------|----------------|---------------|-----------------------|----------------|-----------------------------------|-----------------------|-----------------|
| 11B | 12.38 | 12.56 | 0.985669 | 98.57% | 0.06 | 0.08 | 0.1 |
| 11G | 2.063 | 2.154 | 0.957753 | 95.78% | 0.19 | 0.48 | 1 |
| 802.11n HT20 | 1.919 | 2.046 | 0.937928 | 93.79% | 0.28 | 0.52 | 1 |
| 802.11n HT40 | 0.9435 | 1.0704 | 0.881446 | 88.14% | 0.55 | 1.06 | 2 |

Note: 1) Duty Cycle Correction Factor=10log(1/x).
 2) Where: x is Duty Cycle(Linear)
 3) Where: T is On Time (transmit duration)



TEST GRAPHS

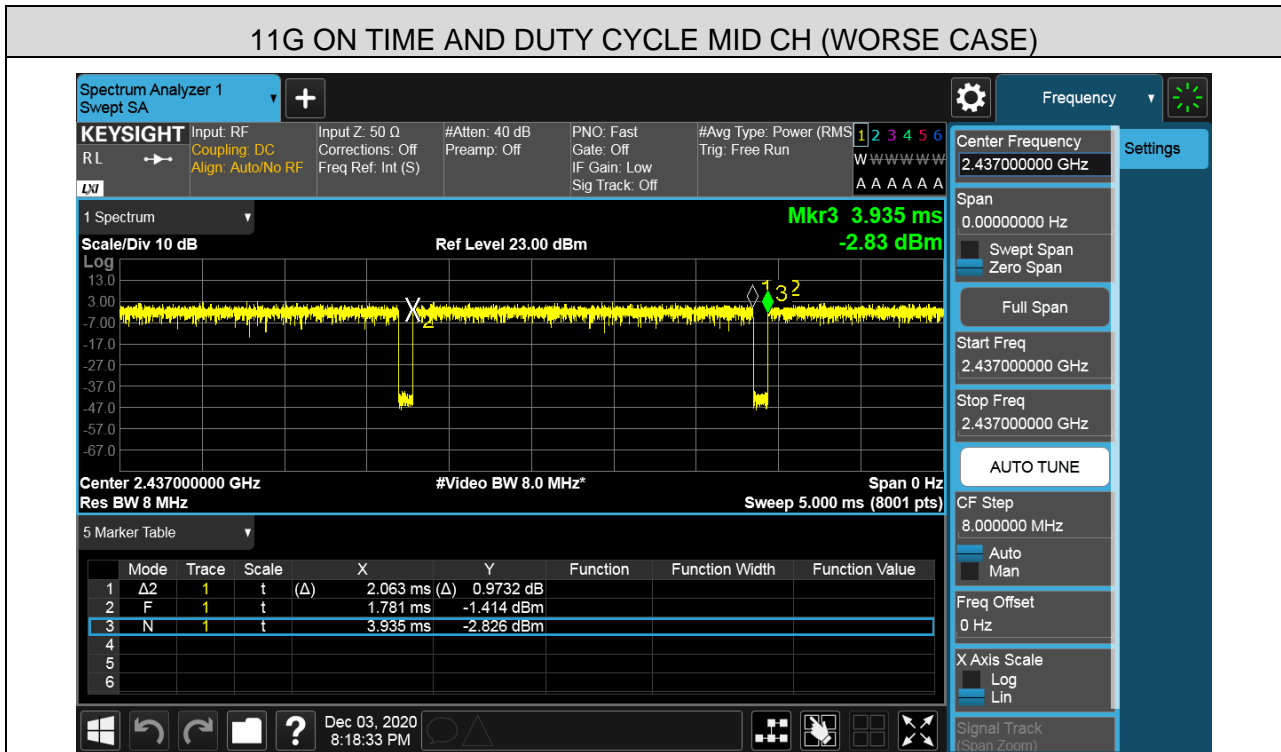
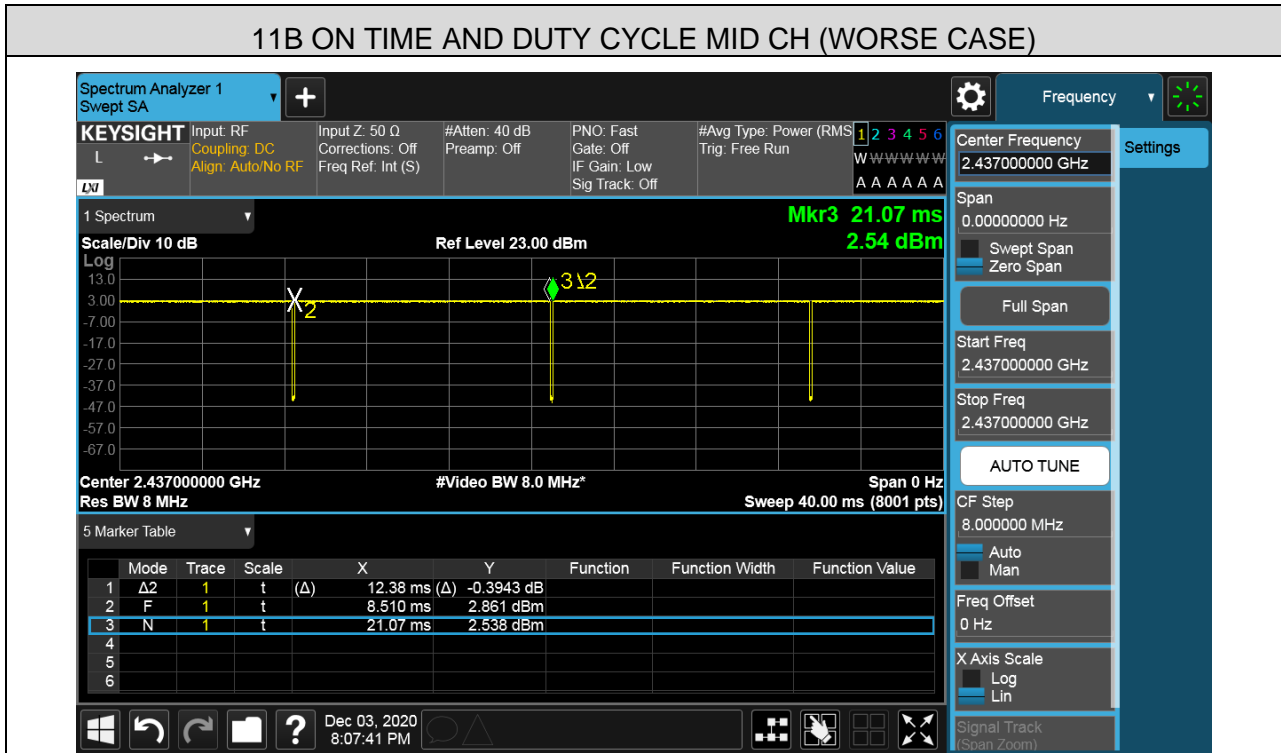



11N (HT20) ON TIME AND DUTY CYCLE MID CH (WORSE CASE)

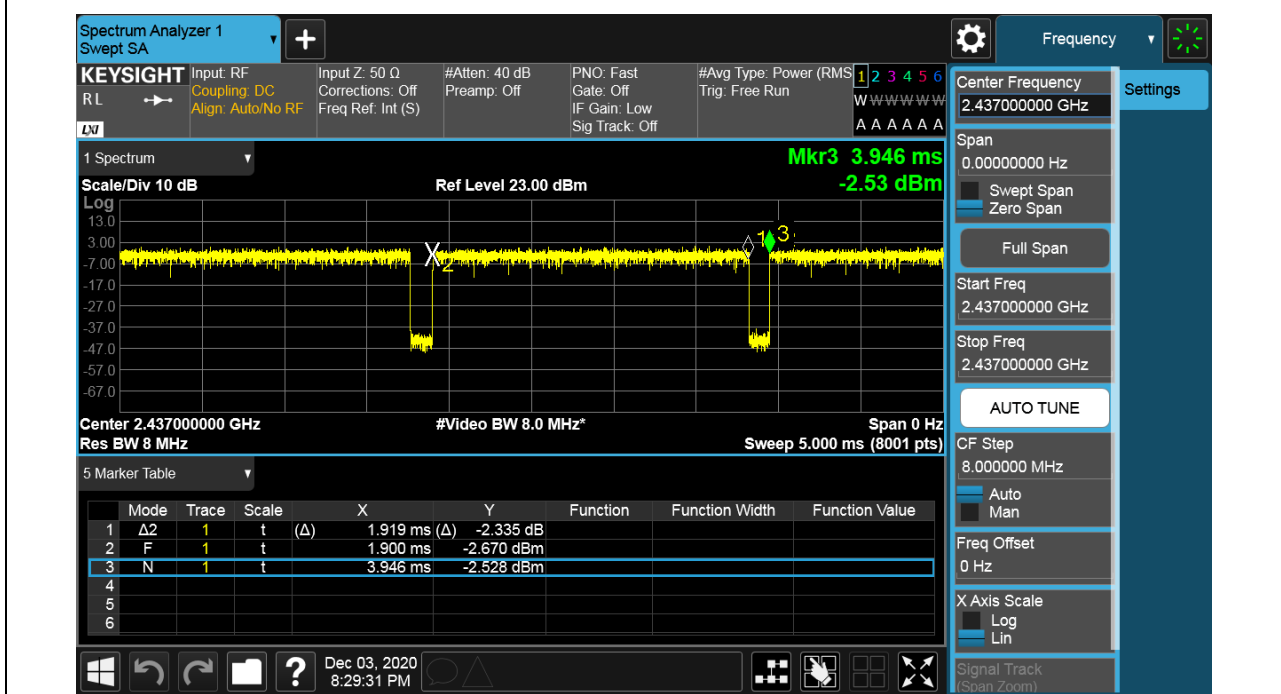

11N (HT40) ON TIME AND DUTY CYCLE MID CH (WORSE CASE)

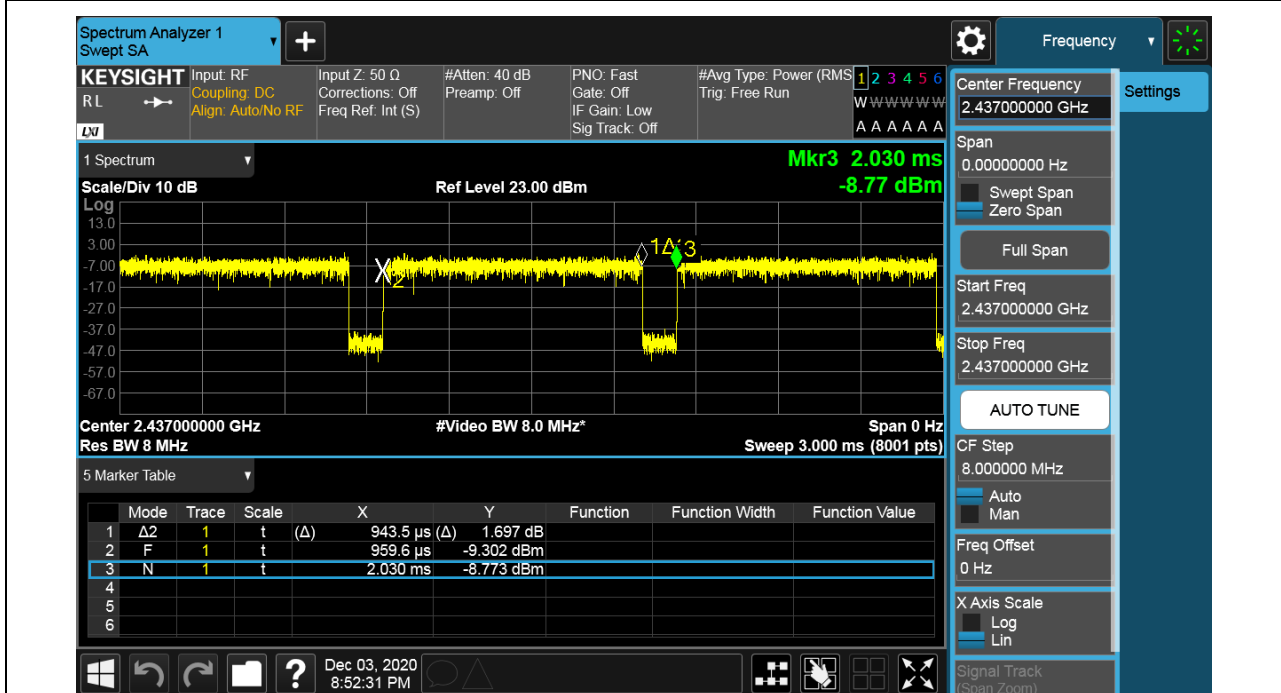

7.2. 6 dB BANDWIDTH

LIMITS

| FCC Part15 (15.247) Subpart C | | | |
|-------------------------------|---------------|----------------------|-----------------------|
| Section | Test Item | Limit | Frequency Range (MHz) |
| FCC 15.247(a)(2) | 6dB Bandwidth | $\geq 500\text{KHz}$ | 2400-2483.5 |

TEST PROCEDURE

Refer to FCC KDB 558074, connect the UUT to the spectrum analyser and use the following settings:

| | |
|------------------|------------------------------------------------|
| Center Frequency | The centre frequency of the channel under test |
| Detector | Peak |
| RBW | For 6 dB Bandwidth :100K |
| VBW | For 6dB Bandwidth : $\geq 3 \times \text{RBW}$ |
| Trace | Max hold |
| Sweep | Auto couple |

Allow the trace to stabilize and measure the maximum width of the emission that is constrained by the frequencies associated with the two outermost amplitude points (upper and lower frequencies) that are attenuated by 6 dB relative to the maximum level measured in the fundamental emission.

TEST SETUP

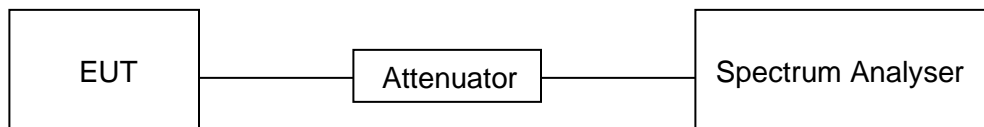



TEST RESULTS TABLE

| Test Mode | Test Channel | 6dB bandwidth (MHz) | Result |
|-----------|--------------|---------------------|--------|
| 11B | LCH | 9.068 | Pass |
| | MCH | 9.018 | Pass |
| | HCH | 8.578 | Pass |
| 11G | LCH | 16.39 | Pass |
| | MCH | 16.34 | Pass |
| | HCH | 16.37 | Pass |
| 11N HT20 | LCH | 17.55 | Pass |
| | MCH | 17.56 | Pass |
| | HCH | 17.57 | Pass |
| 11N HT40 | LCH | 36.29 | Pass |
| | MCH | 36.06 | Pass |
| | HCH | 36.30 | Pass |



TEST GRAPHS

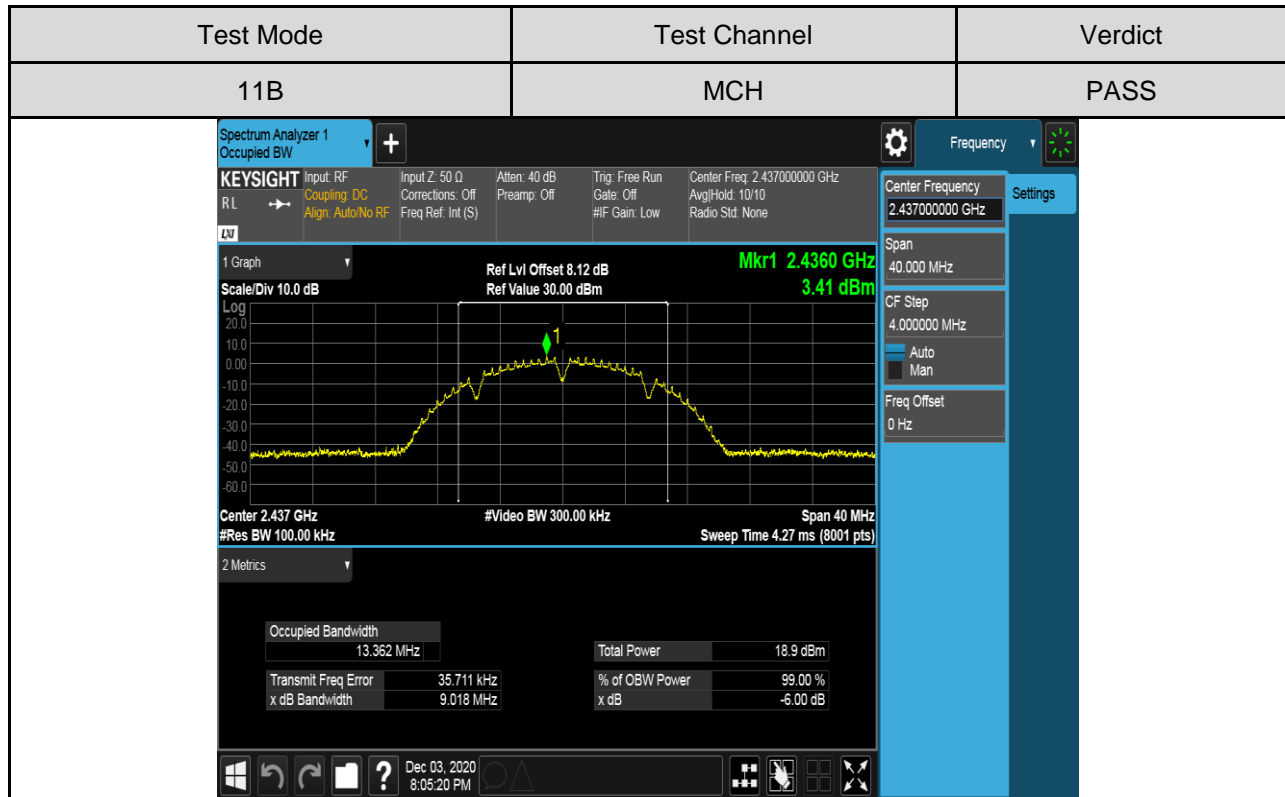
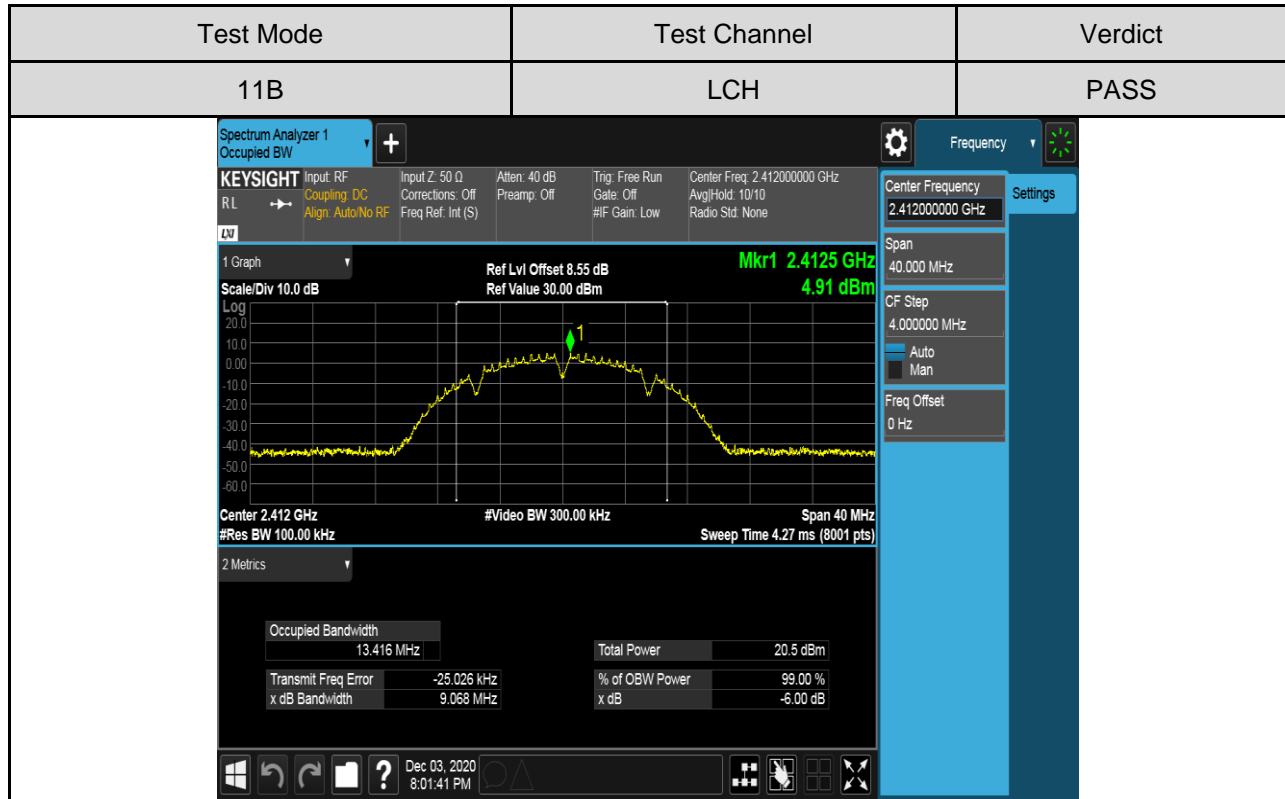

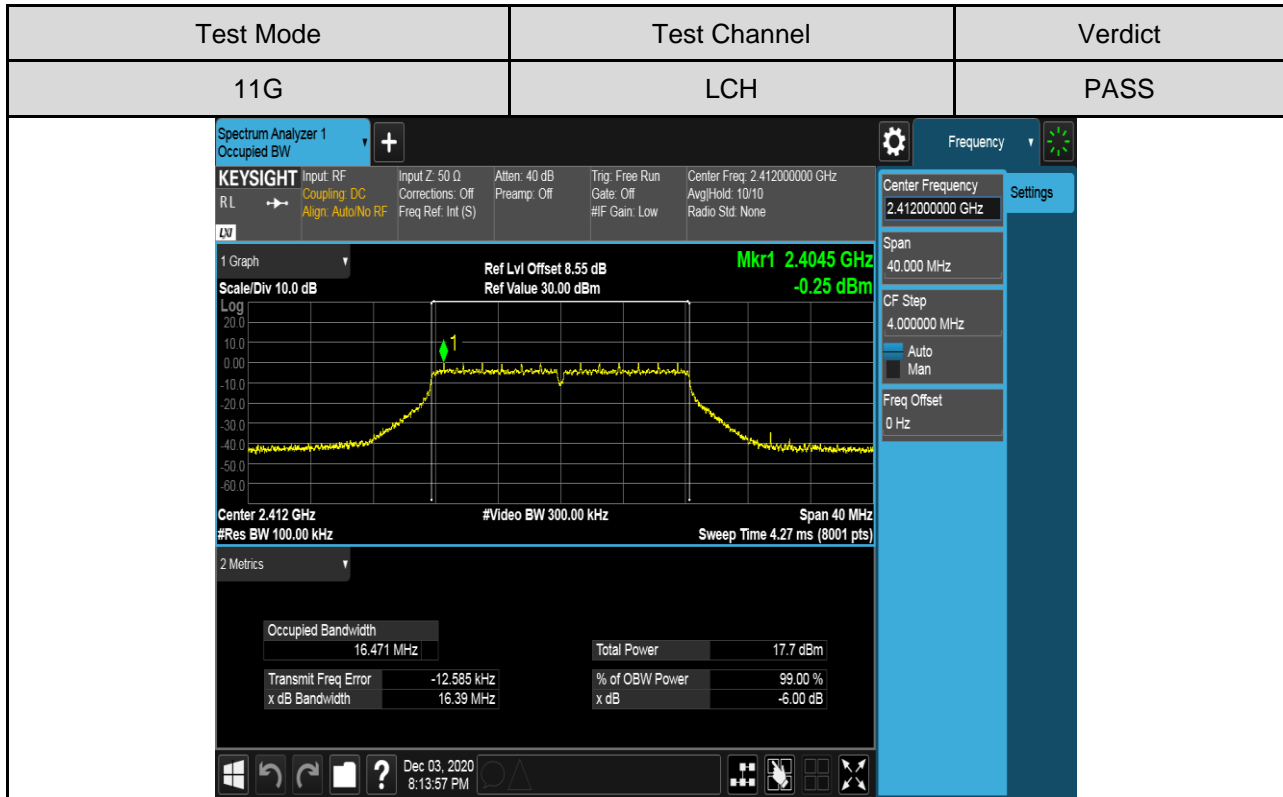
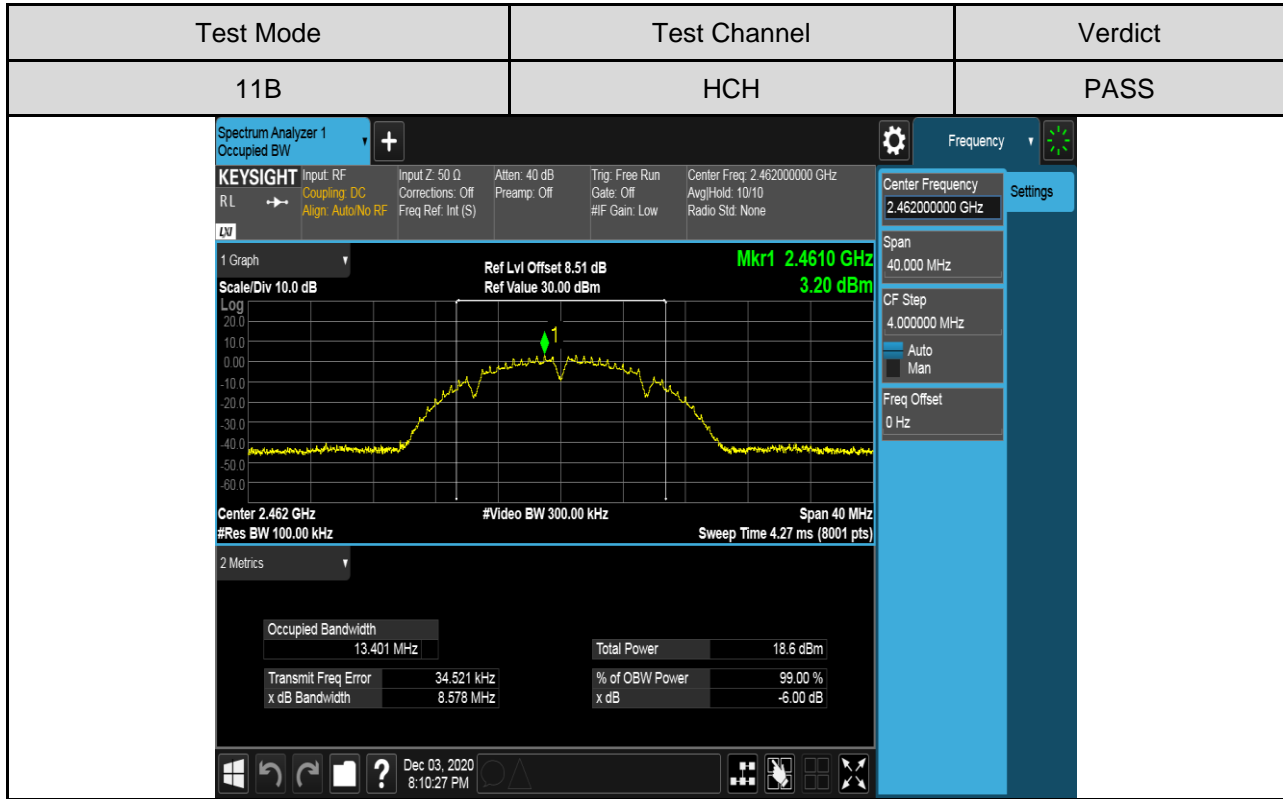

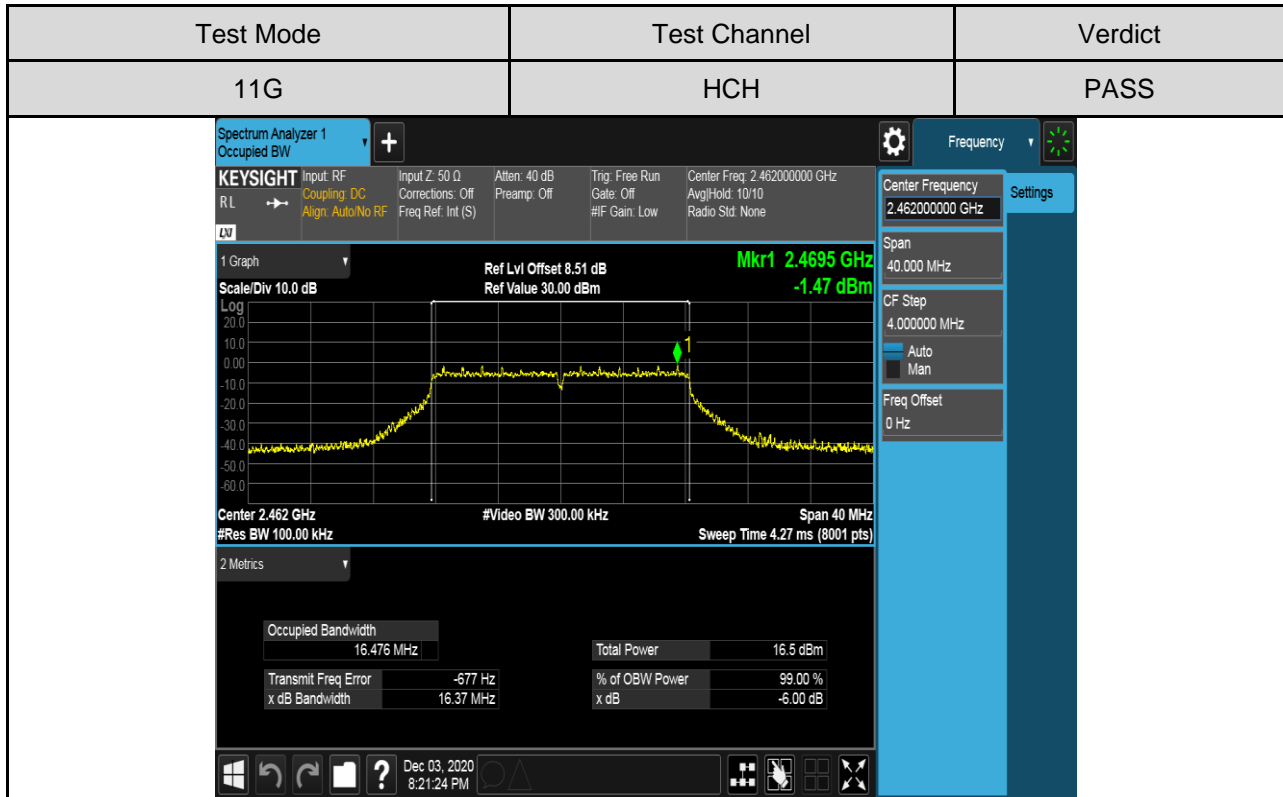
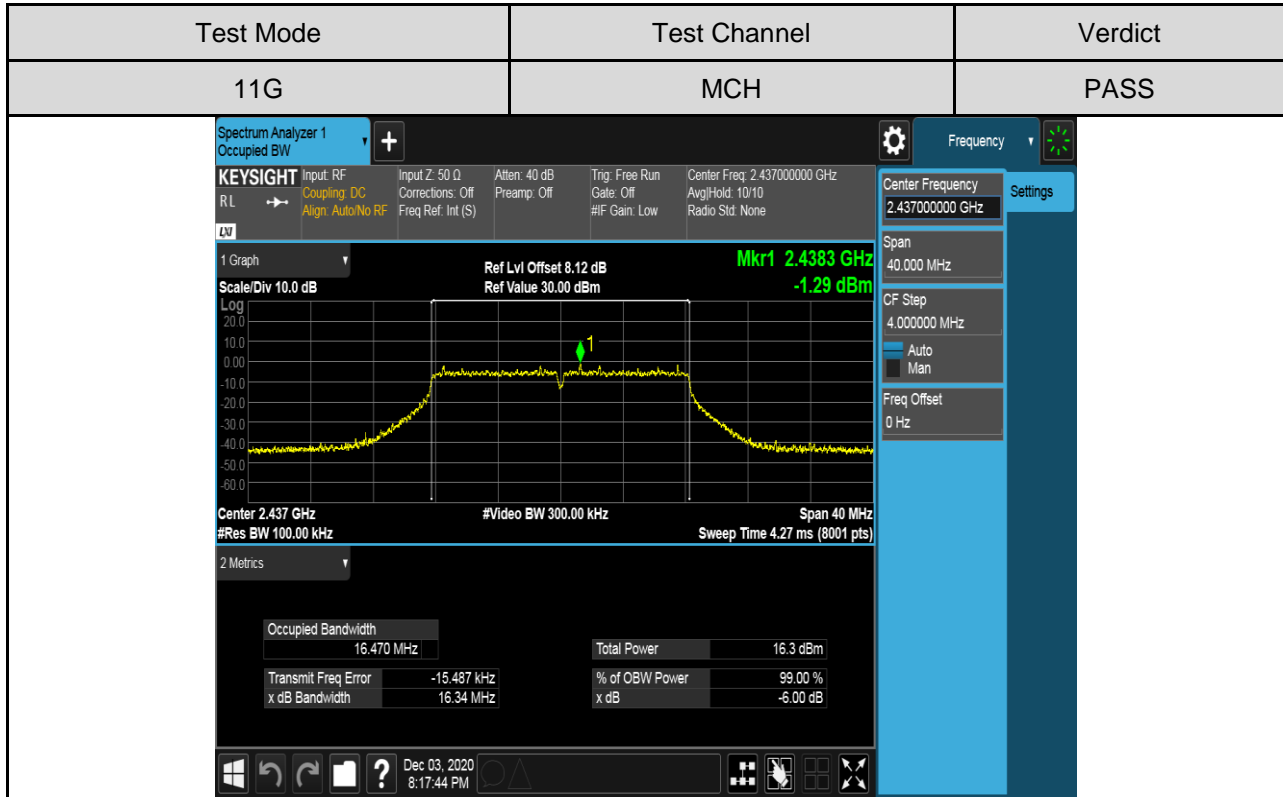

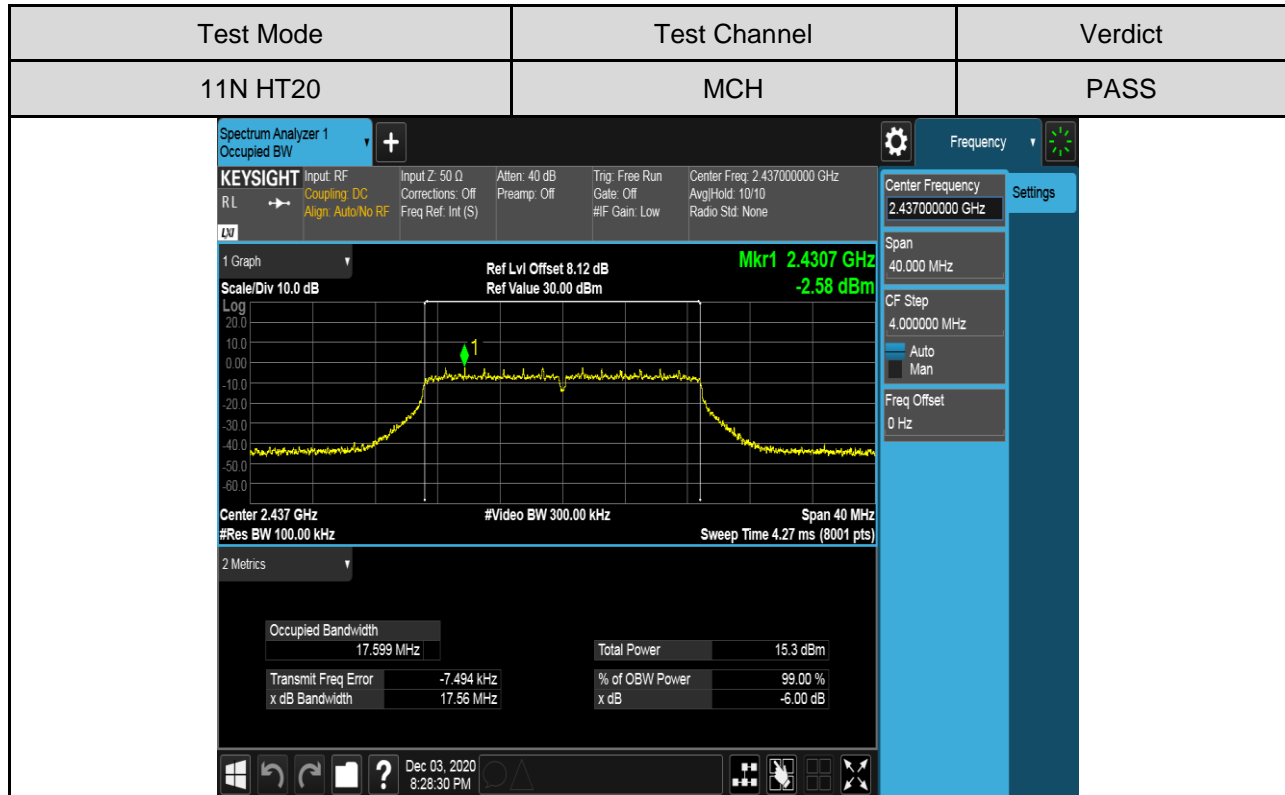
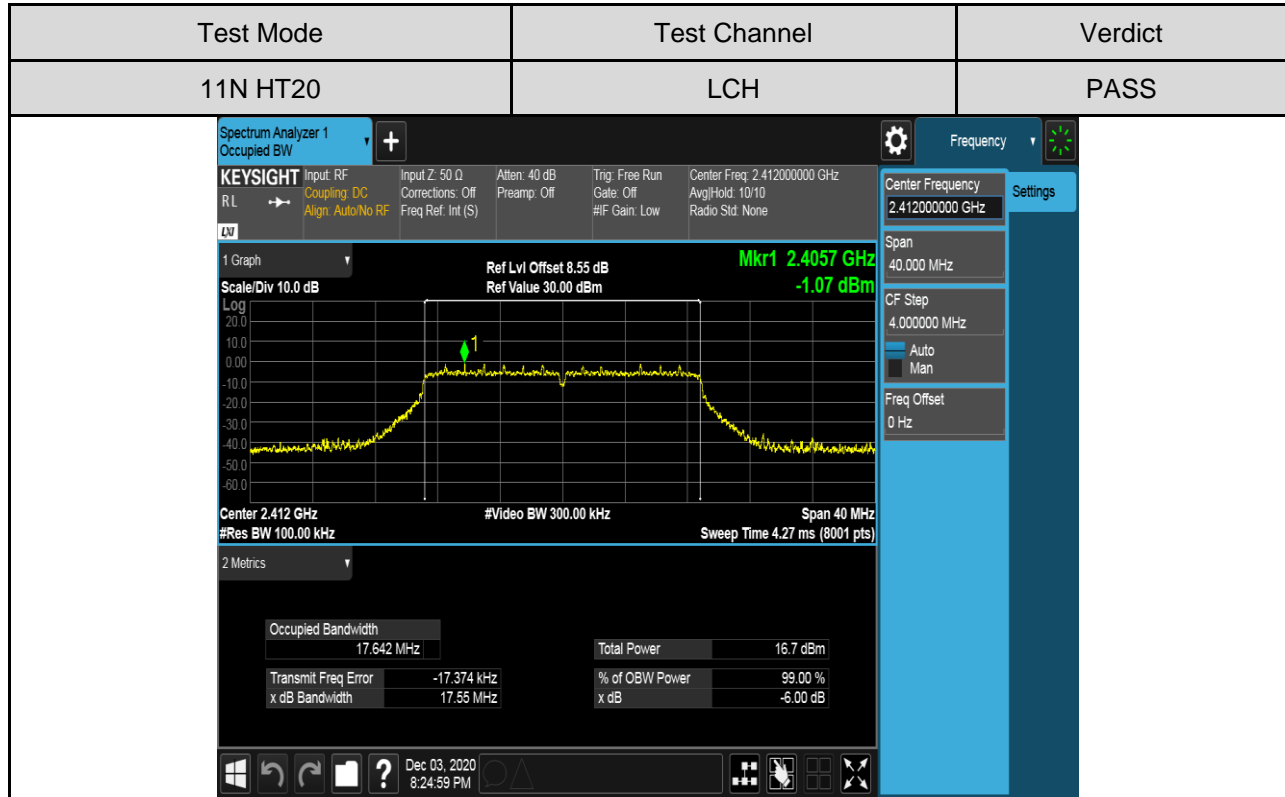

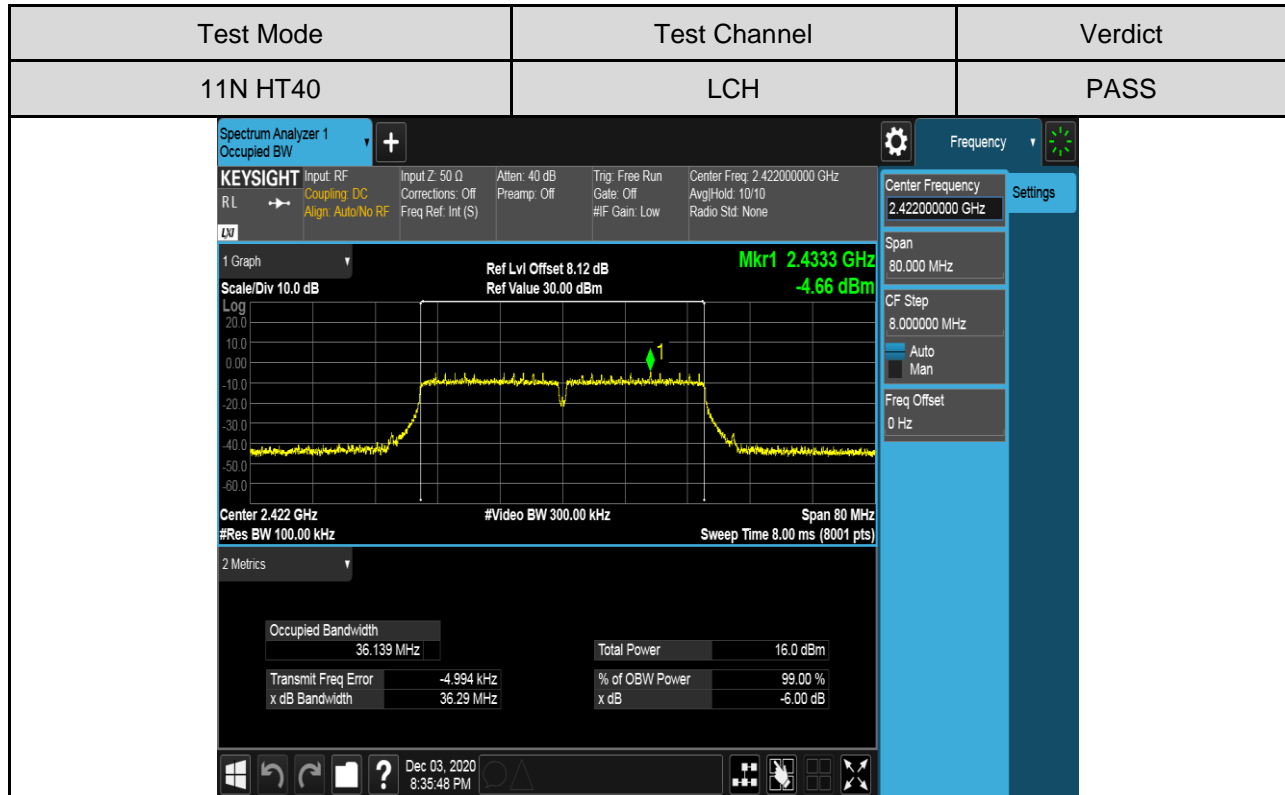
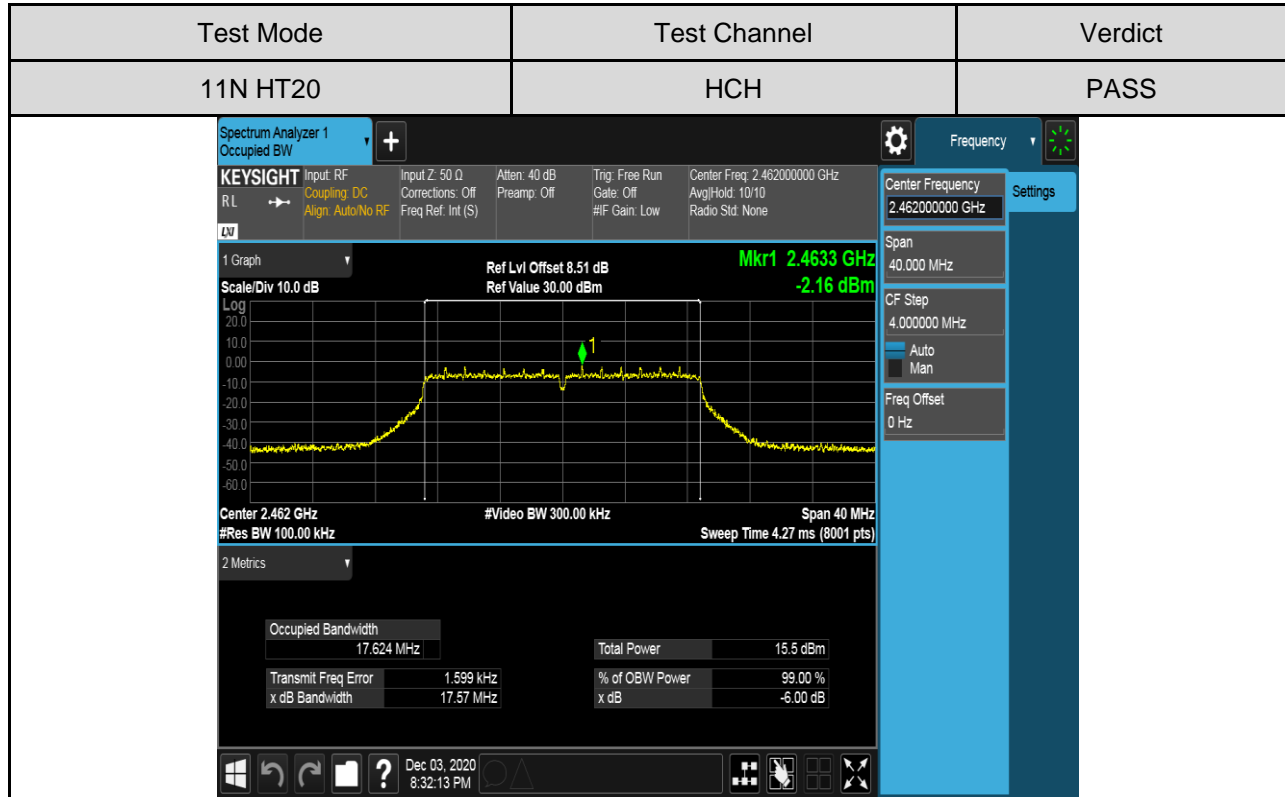

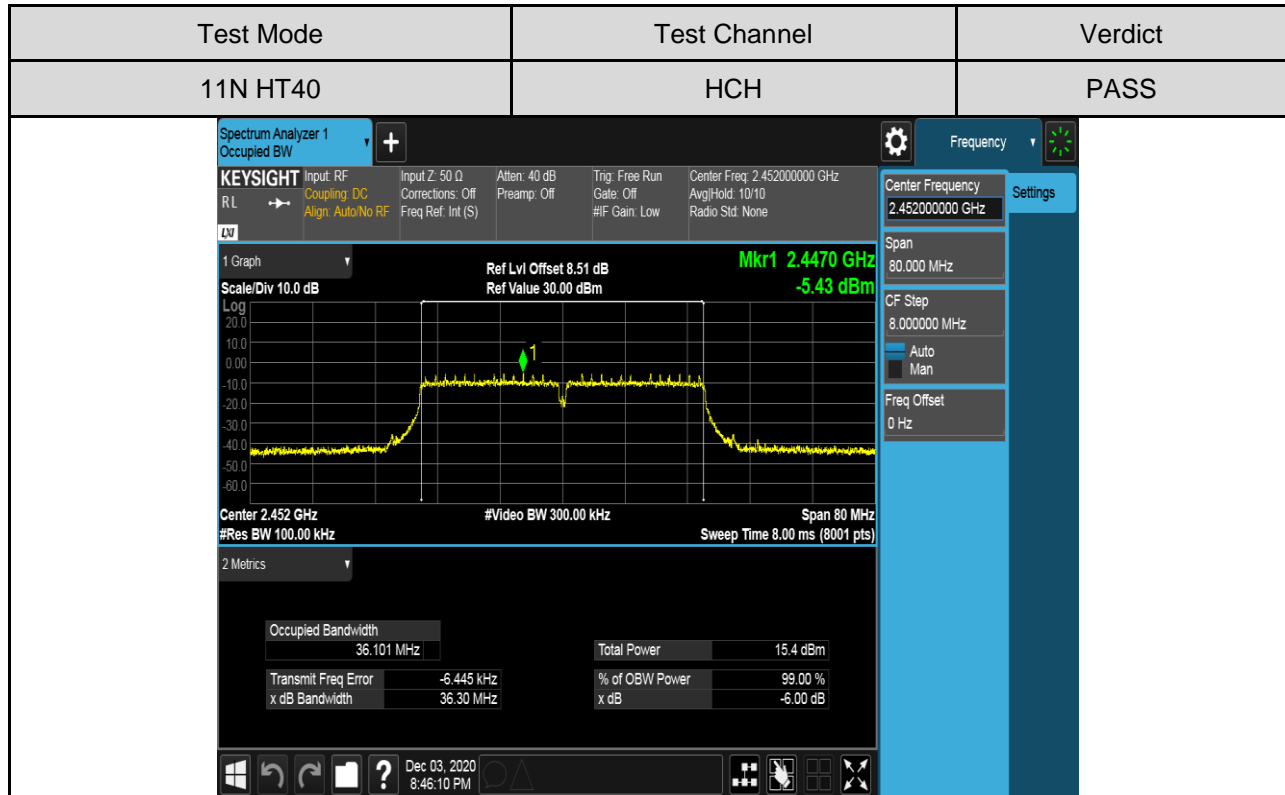
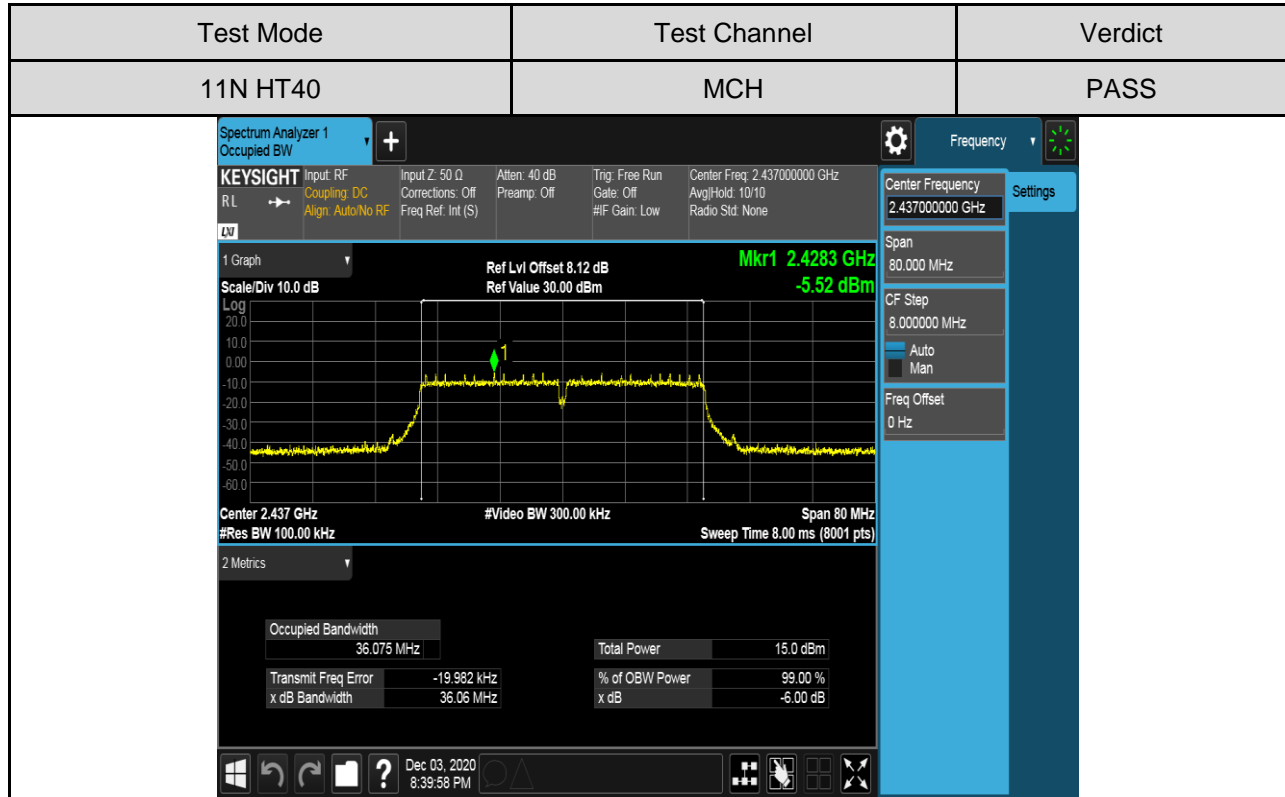

7.3. CONDUCTED OUTPUT POWER

LIMITS

| FCC Part15 (15.247) , Subpart C | | | |
|---------------------------------|--------------|-----------------|-----------------------|
| Section | Test Item | Limit | Frequency Range (MHz) |
| FCC 15.247(b)(3) | Output Power | 1 watt or 30dBm | 2400-2483.5 |

TEST PROCEDURE

Place the EUT on the table and set it in the transmitting mode.
Remove the antenna from the EUT and then connect a low loss RF cable from the antenna port to the Power sensor.
Measure the power of each channel.
Peak Detector use for Peak result.
AVG Detector use for AVG result.

TEST ENVIRONMENT

| | | | |
|---------------------|--------|-------------------|---------|
| Temperature | 22°C | Relative Humidity | 56% |
| Atmosphere Pressure | 101kPa | Test Voltage | AC 120V |

TEST SETUP

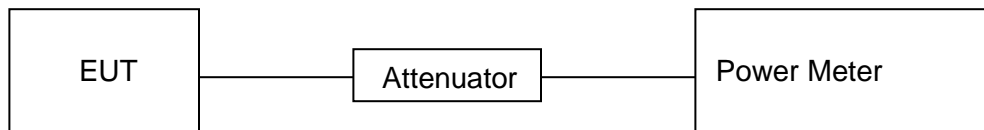



TEST RESULTS TABLE

| Test Mode | Test Channel | Maximum Conducted Output Power (AV) | LIMIT |
|-----------|--------------|-------------------------------------|-------|
| | | dBm | dBm |
| 11B | LCH | 13.38 | 30 |
| | MCH | 11.63 | 30 |
| | HCH | 11.72 | 30 |
| 11G | LCH | 11.30 | 30 |
| | MCH | 9.90 | 30 |
| | HCH | 10.03 | 30 |
| 11n HT20 | LCH | 10.30 | 30 |
| | MCH | 8.92 | 30 |
| | HCH | 9.08 | 30 |
| 11n HT40 | LCH | 9.65 | 30 |
| | MCH | 8.65 | 30 |
| | HCH | 9.02 | 30 |

7.4. POWER SPECTRAL DENSITY

LIMITS

| FCC Part15 (15.247) , Subpart C | | | |
|---------------------------------|------------------------|-------------|-----------------------|
| Section | Test Item | Limit | Frequency Range (MHz) |
| FCC §15.247 (e) | Power Spectral Density | 8 dBm/3 kHz | 2400-2483.5 |

TEST PROCEDURE

Refer to FCC KDB 558074, connect the UUT to the spectrum analyser and use the following settings:

| | |
|------------------|------------------------------------------------------|
| Center Frequency | The centre frequency of the channel under test |
| Detector | Peak |
| RBW | $3 \text{ kHz} \leq \text{RBW} \leq 100 \text{ kHz}$ |
| VBW | $\geq 3 \times \text{RBW}$ |
| Span | 1.5 x DTS bandwidth |
| Trace | Max hold |
| Sweep time | Auto couple. |

Allow trace to fully stabilize and use the peak marker function to determine the maximum amplitude level within the RBW.

If measured value exceeds limit, reduce RBW (no less than 3 kHz) and repeat.

TEST ENVIRONMENT

| | | | |
|---------------------|--------|-------------------|---------|
| Temperature | 22°C | Relative Humidity | 56% |
| Atmosphere Pressure | 101kPa | Test Voltage | AC 120V |

TEST SETUP

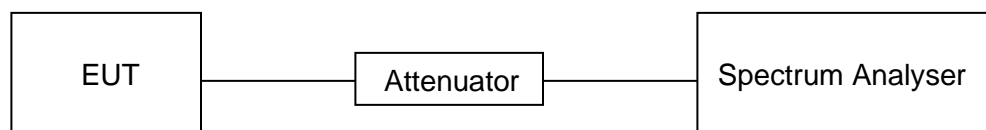



TEST RESULTS TABLE

| Test Mode | Test Channel | Maximum Peak power spectral density (dBm/30kHz) | Result |
|-----------|--------------|-------------------------------------------------|--------|
| 11B | LCH | 1.28 | Pass |
| | MCH | -0.53 | Pass |
| | HCH | -0.03 | Pass |
| 11G | LCH | -4.56 | Pass |
| | MCH | -5.88 | Pass |
| | HCH | -5.70 | Pass |
| 11n HT20 | LCH | -5.94 | Pass |
| | MCH | -7.42 | Pass |
| | HCH | -7.12 | Pass |
| 11n HT40 | LCH | -9.34 | Pass |
| | MCH | -9.56 | Pass |
| | HCH | -9.52 | Pass |



TEST GRAPHS

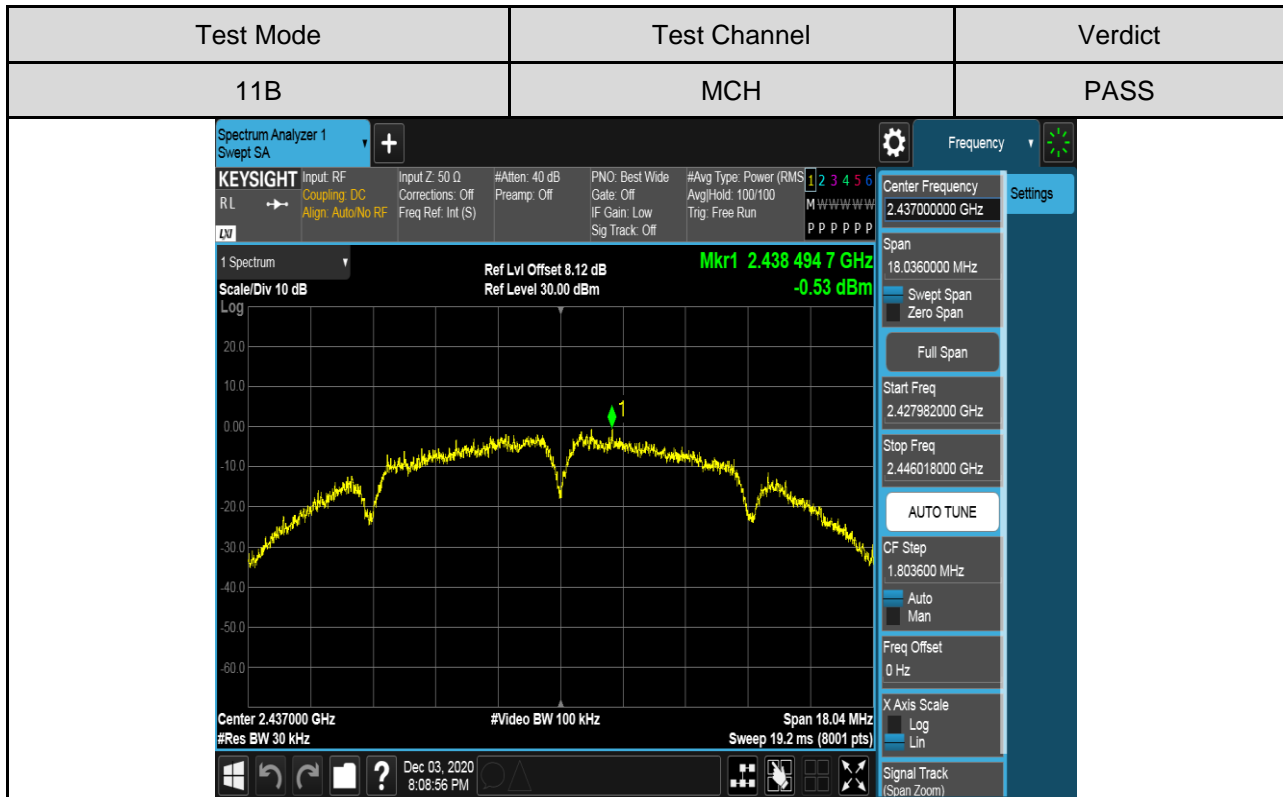
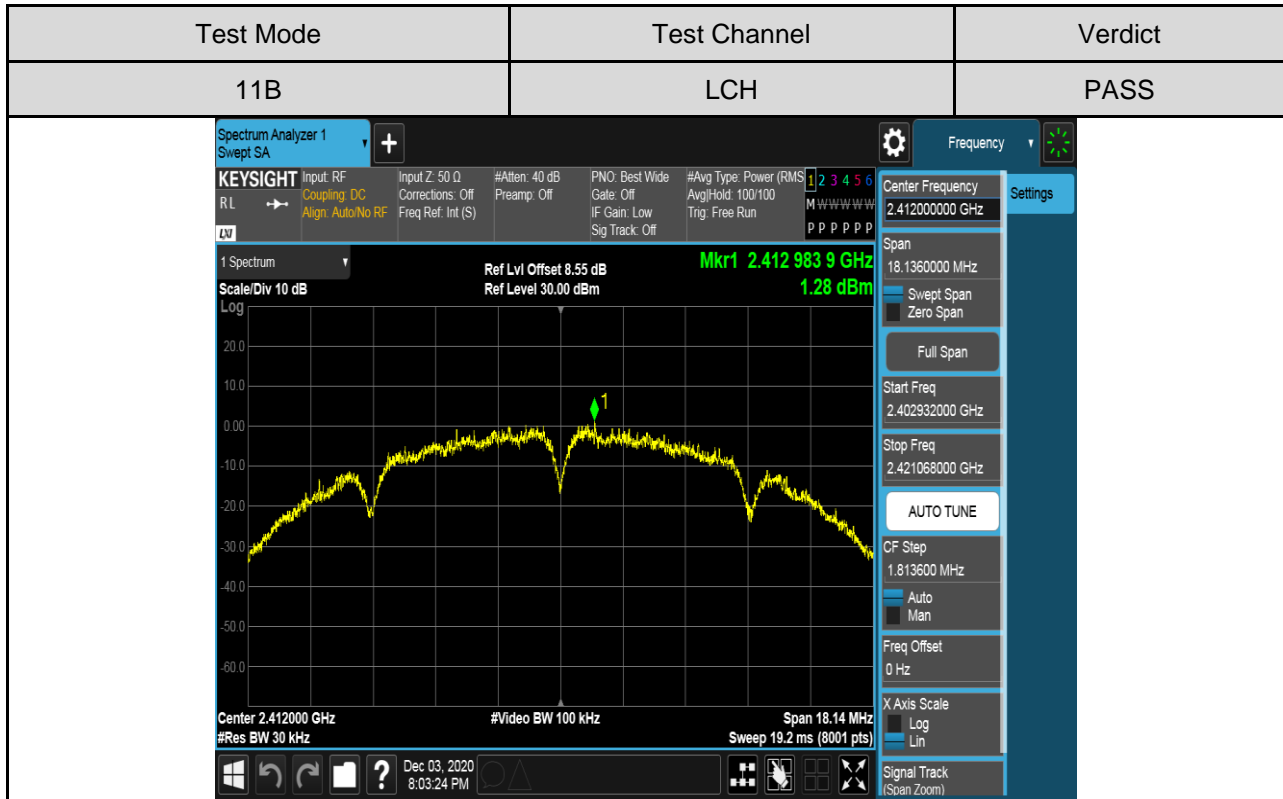

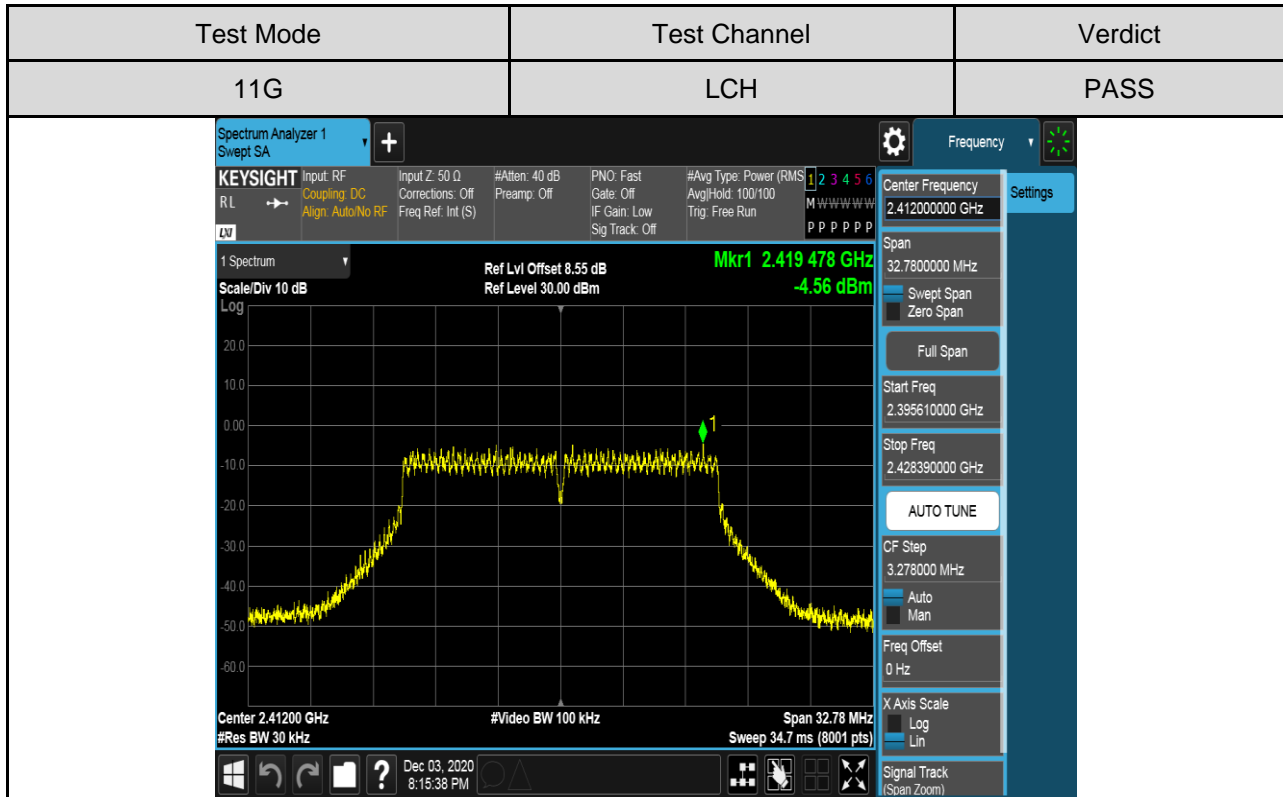
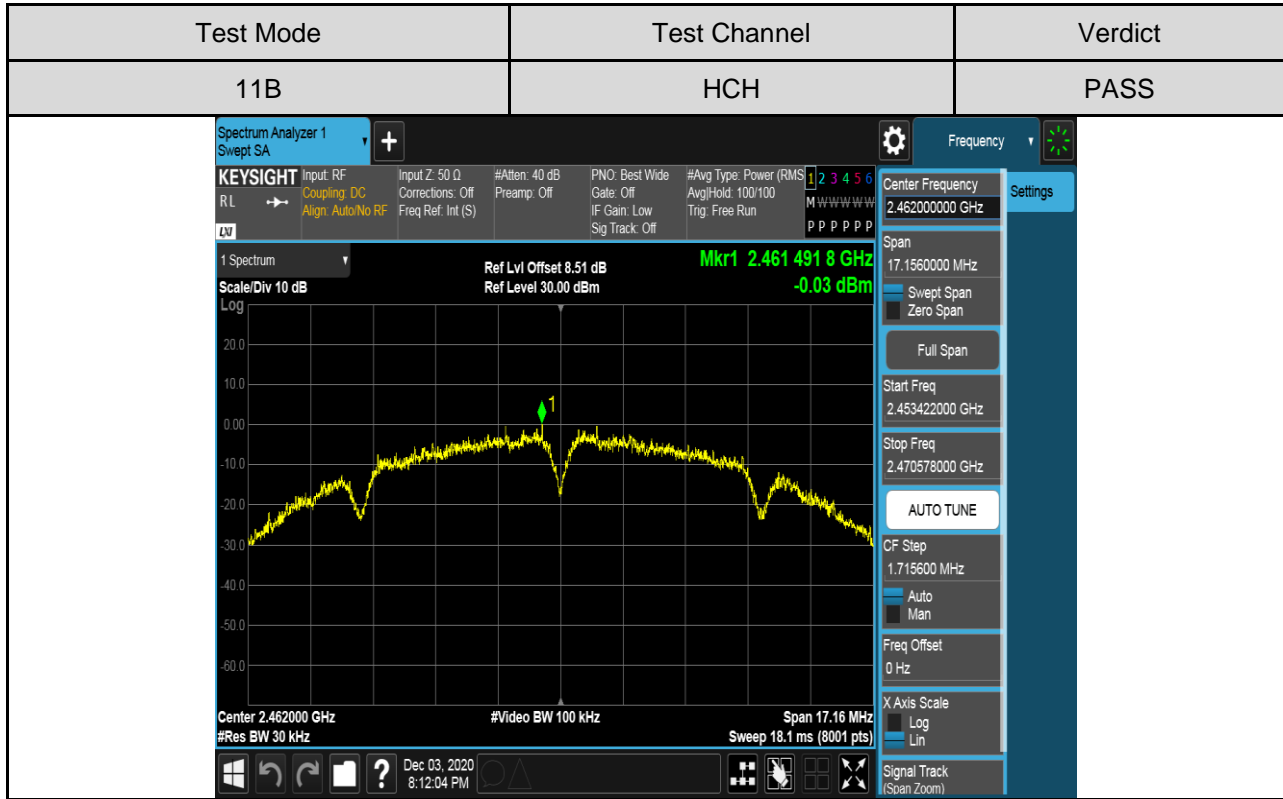

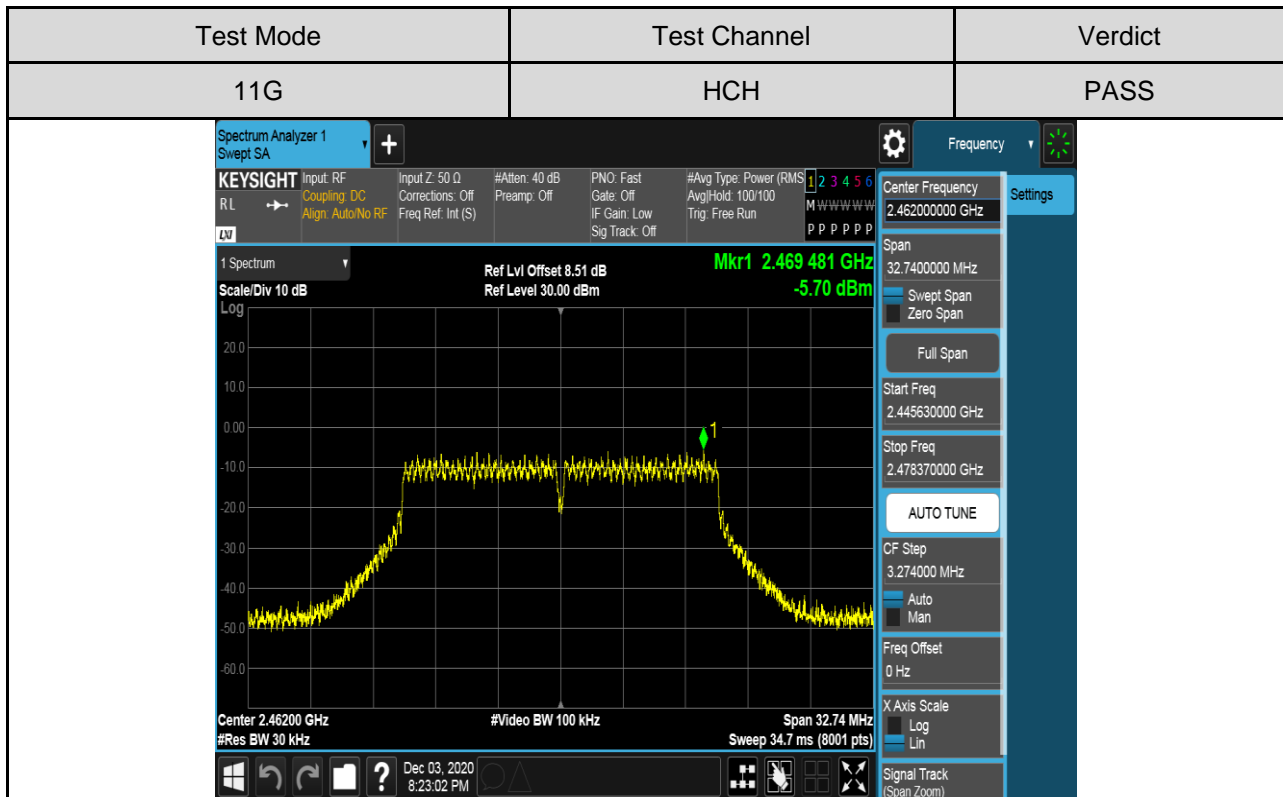
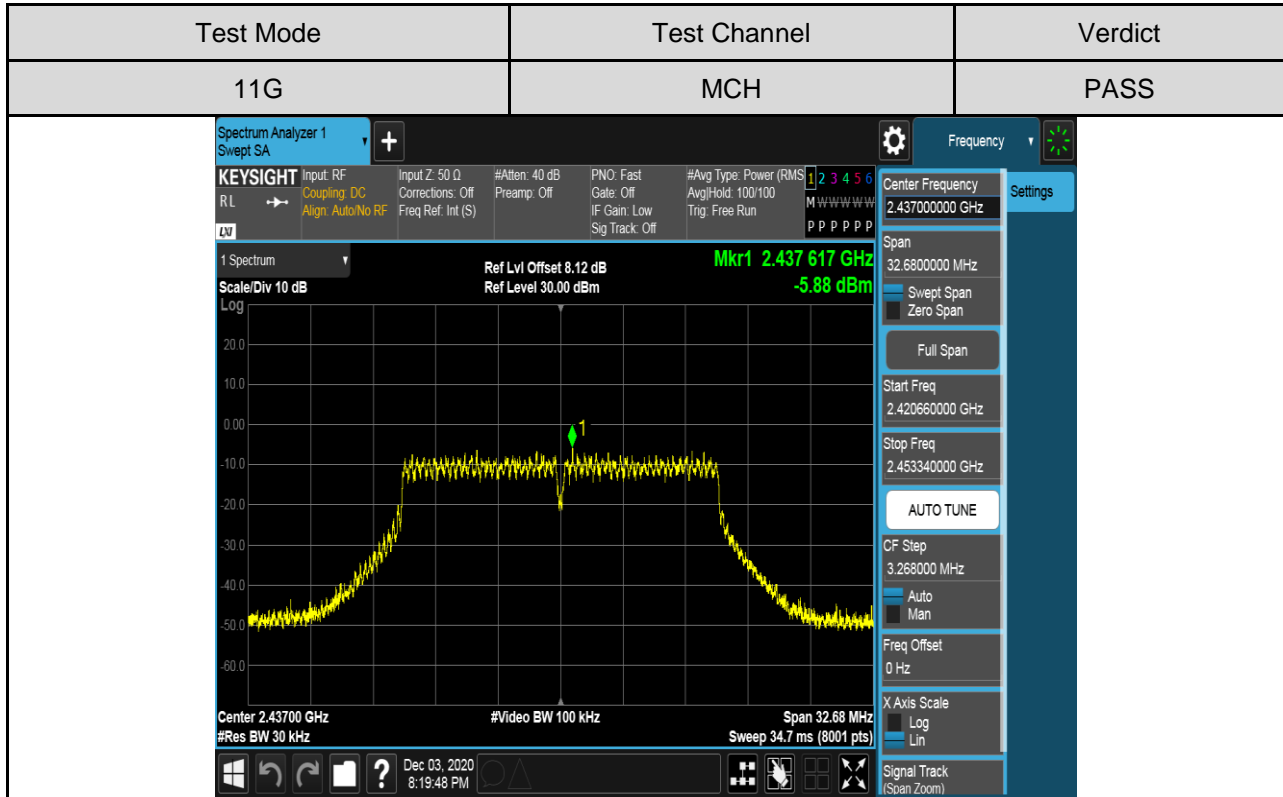

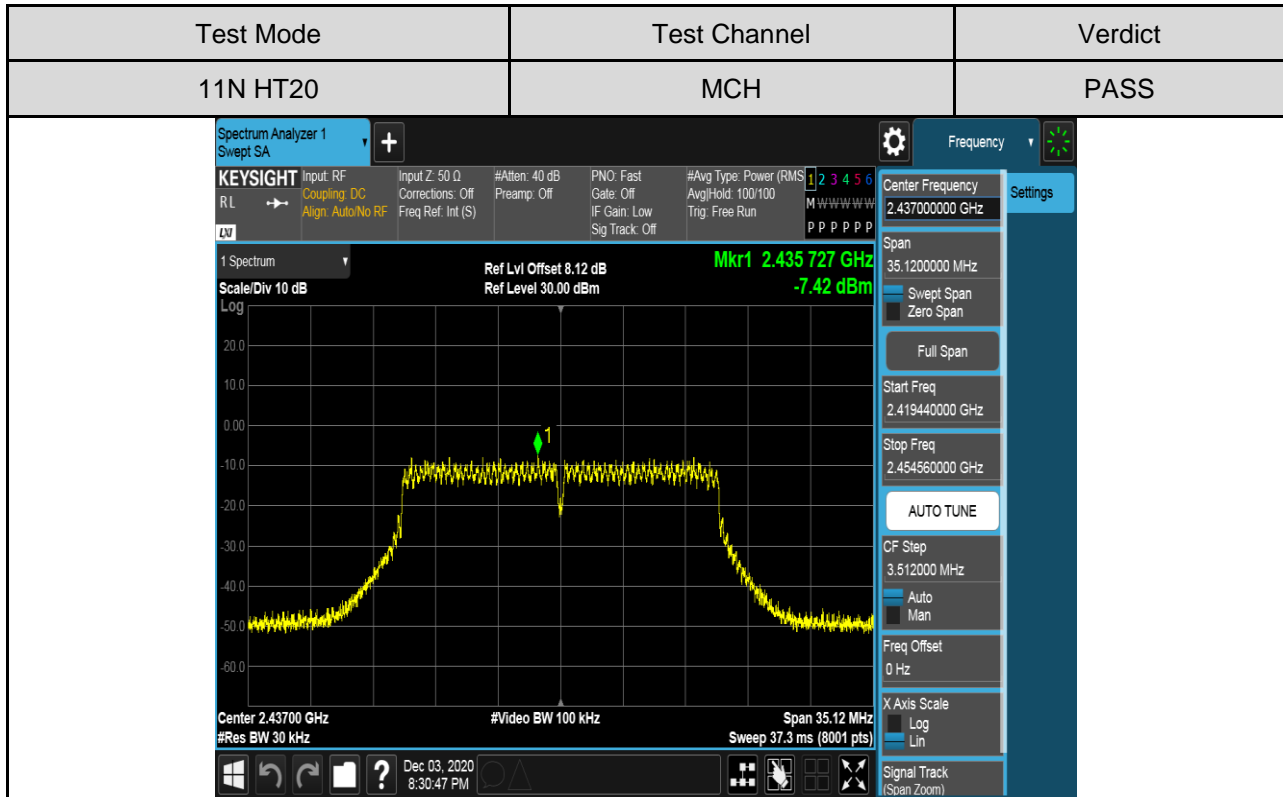
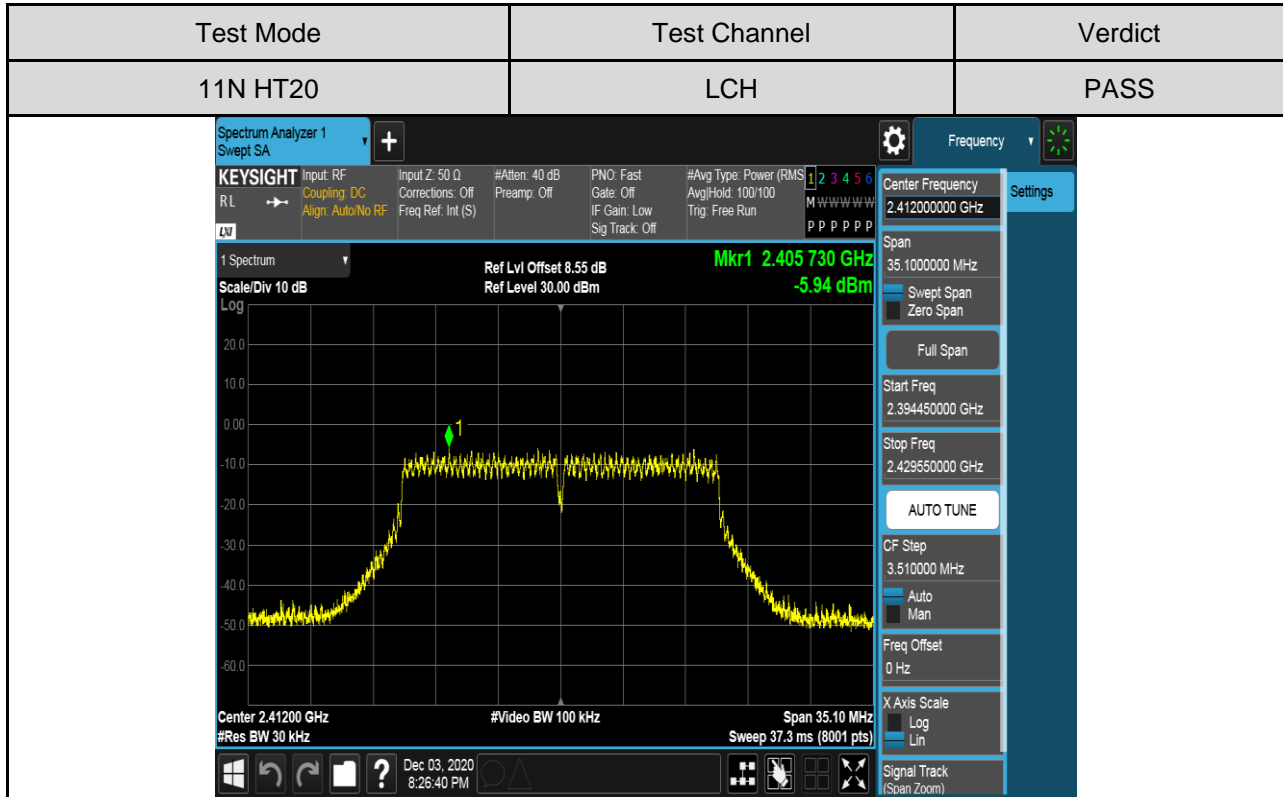

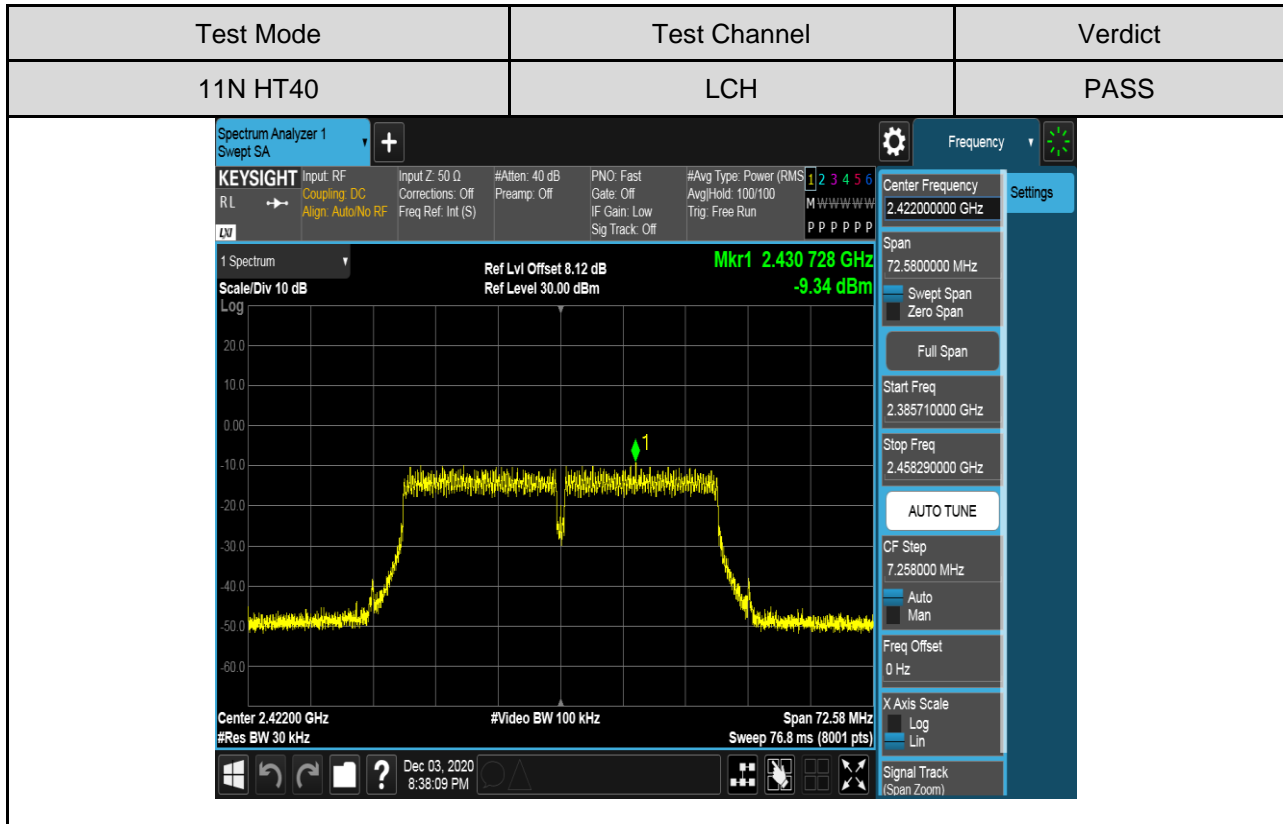
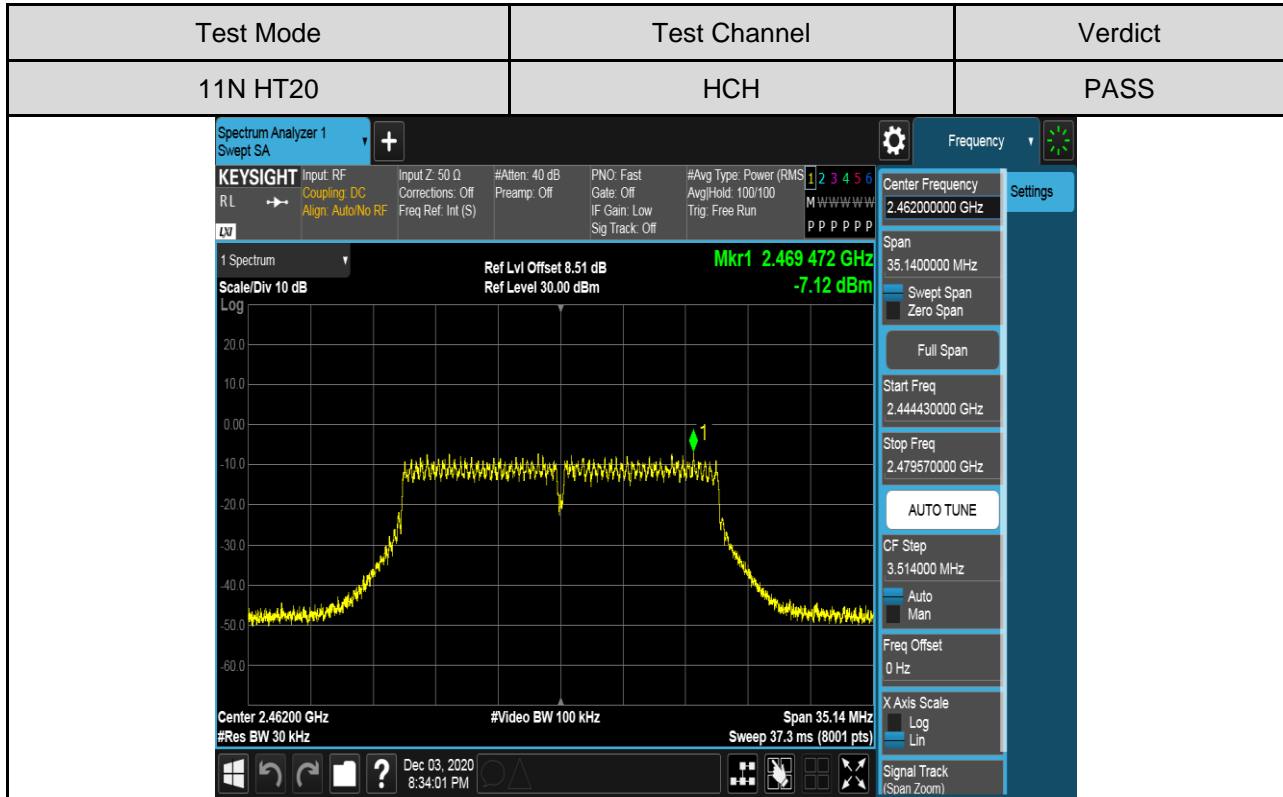

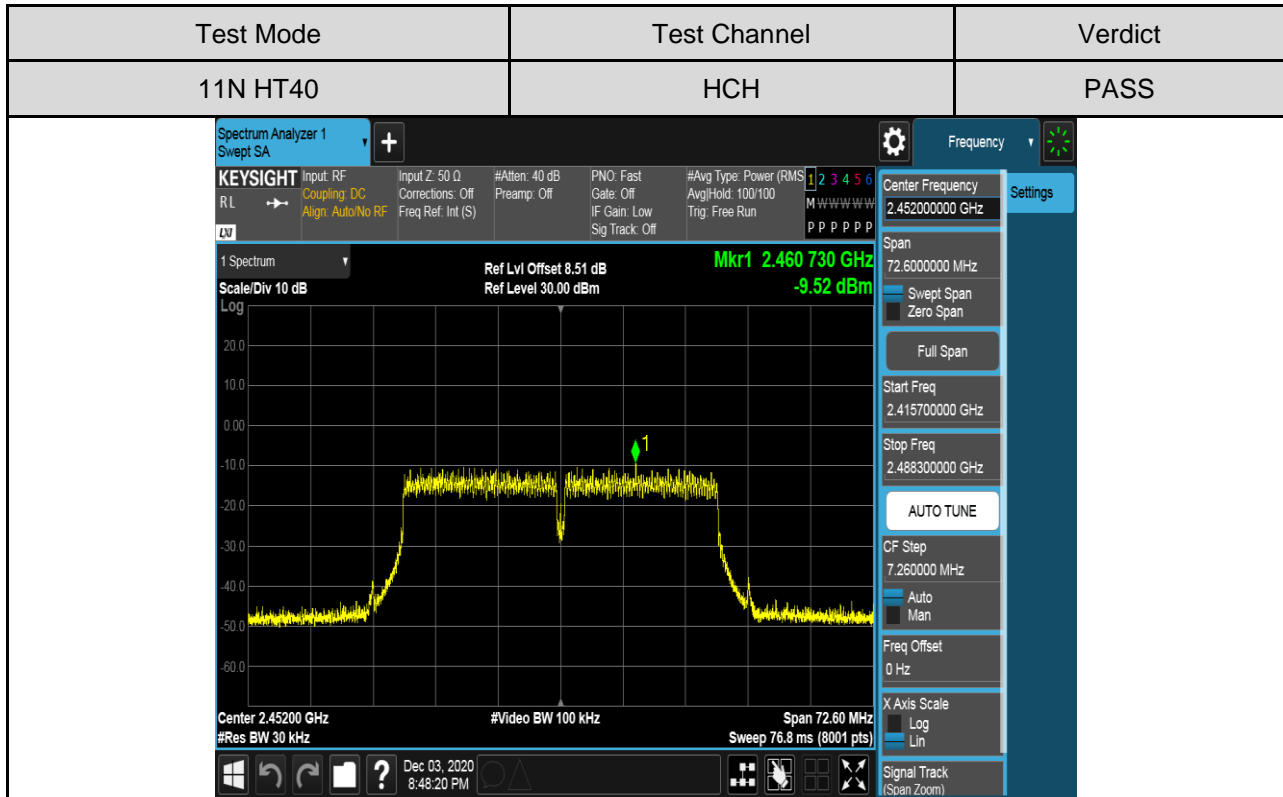
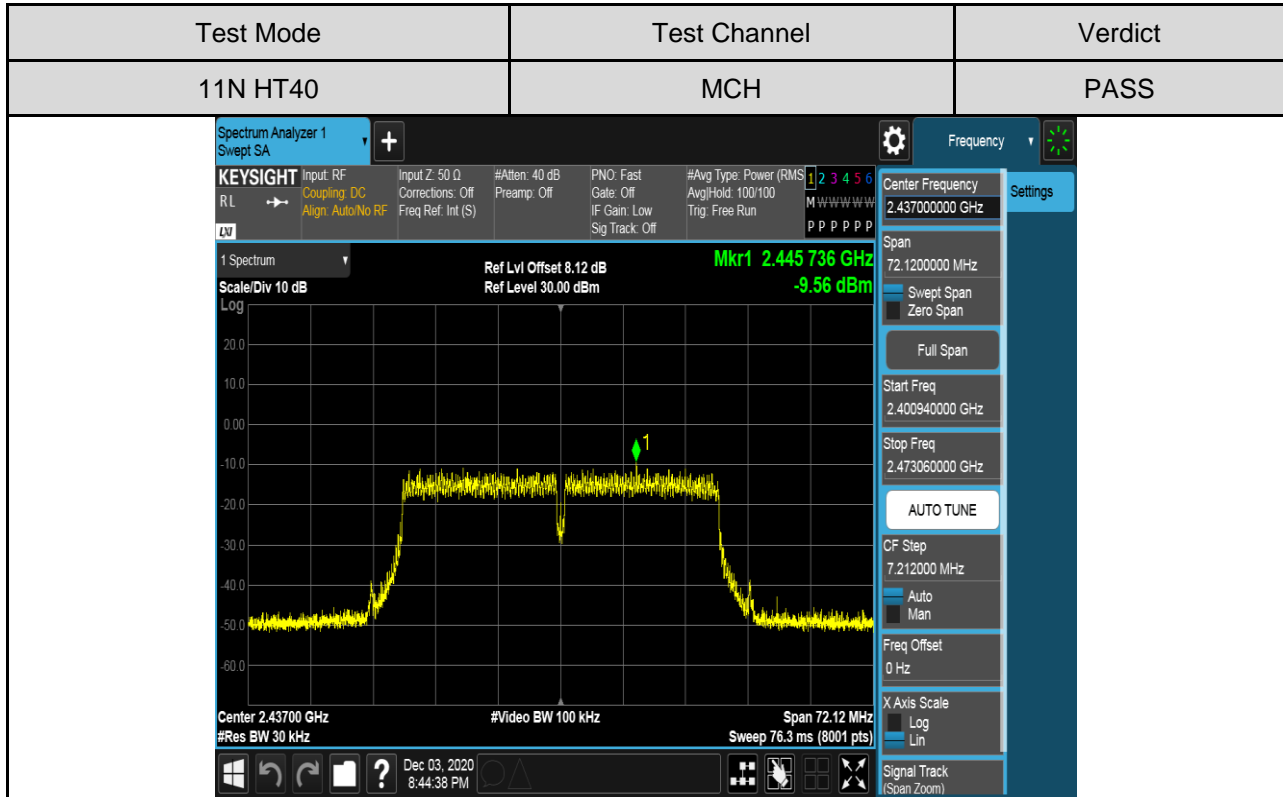

7.5. CONDUCTED BANDEGE AND SPURIOUS EMISSIONS

LIMITS

| FCC Part15 (15.247) , Subpart C | | |
|---------------------------------|-------------------------------------------|----------------------------------------------------------------------------------------------------------------|
| Section | Test Item | Limit |
| FCC §15.247 (d) | Conducted Bandedge and Spurious Emissions | 30 dB below that in the 100 kHz bandwidth within the band that contains the highest level of the desired power |

TEST PROCEDURE

Refer to FCC KDB 558074, connect the UUT to the spectrum analyser and use the following

| | |
|------------------|------------------------------------------------|
| Center Frequency | The centre frequency of the channel under test |
| Detector | Peak |
| RBW | 100K |
| VBW | $\geq 3 \times \text{RBW}$ |
| Span | 1.5 x DTS bandwidth |
| Trace | Max hold |
| Sweep time | Auto couple. |

settings:

Use the peak marker function to determine the maximum PSD level.

| | |
|--------------------|-------------------------------------------------------------------------------|
| Span | Set the center frequency and span to encompass frequency range to be measured |
| Detector | Peak |
| RBW | 100K |
| VBW | $\geq 3 \times \text{RBW}$ |
| measurement points | $\geq \text{span}/\text{RBW}$ |
| Trace | Max hold |
| Sweep time | Auto couple. |

Use the peak marker function to determine the maximum amplitude level.

TEST SETUP

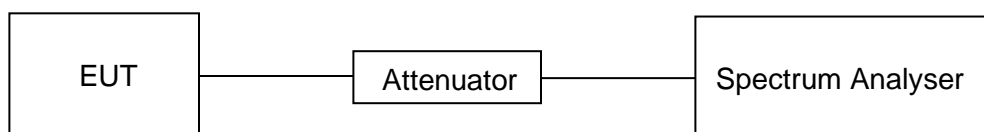



TEST ENVIRONMENT

| | | | |
|---------------------|--------|-------------------|---------|
| Temperature | 22°C | Relative Humidity | 56% |
| Atmosphere Pressure | 101kPa | Test Voltage | AC 120V |

PART I :CONDUCTED BANDEGE

TEST RESULTS TABLE

| Test Mode | Test Channel | Carrier Power[dBm] | Max. Spurious Level [dBm] | Limit [dBm] | Verdict |
|-----------|--------------|--------------------|---------------------------|-------------|---------|
| 11B | LCH | 5.088 | -41.70 | -24.91 | PASS |
| | HCH | 3.227 | -40.27 | -26.77 | PASS |
| 11G | LCH | -0.077 | -41.07 | -30.08 | PASS |
| | HCH | -1.634 | -40.96 | -31.63 | PASS |
| 11N HT20 | LCH | -1.350 | -40.68 | -31.35 | PASS |
| | HCH | -2.380 | -40.62 | -32.38 | PASS |
| 11N HT40 | LCH | -4.697 | -40.36 | -34.70 | PASS |
| | HCH | -5.288 | -40.62 | -35.29 | PASS |



TEST GRAPHS

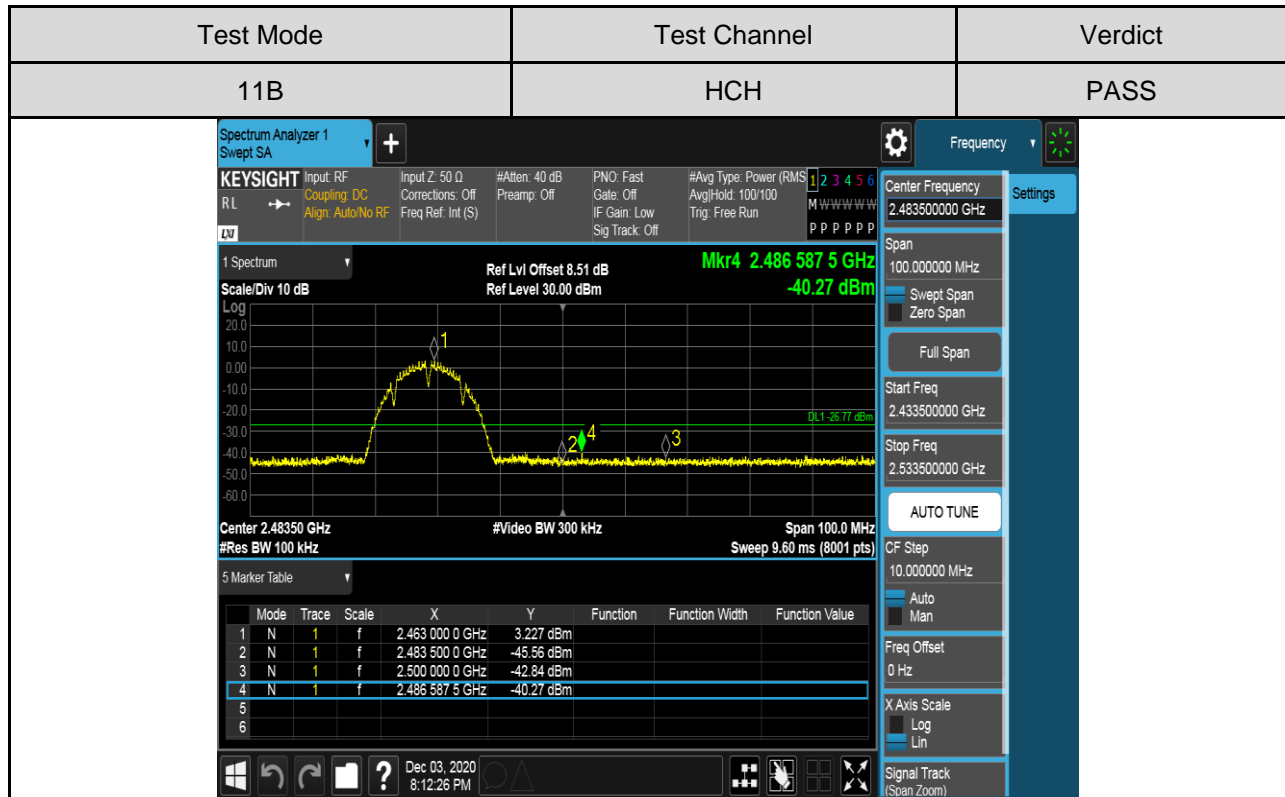
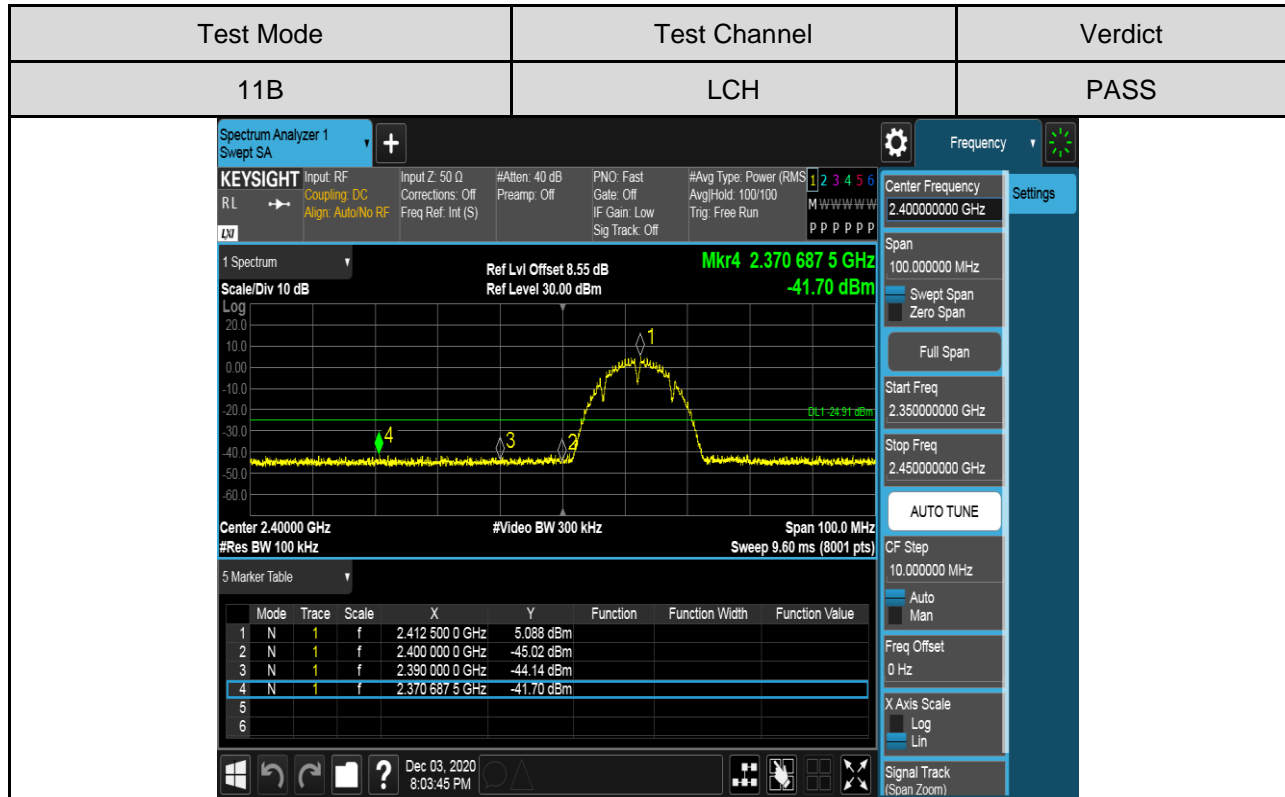

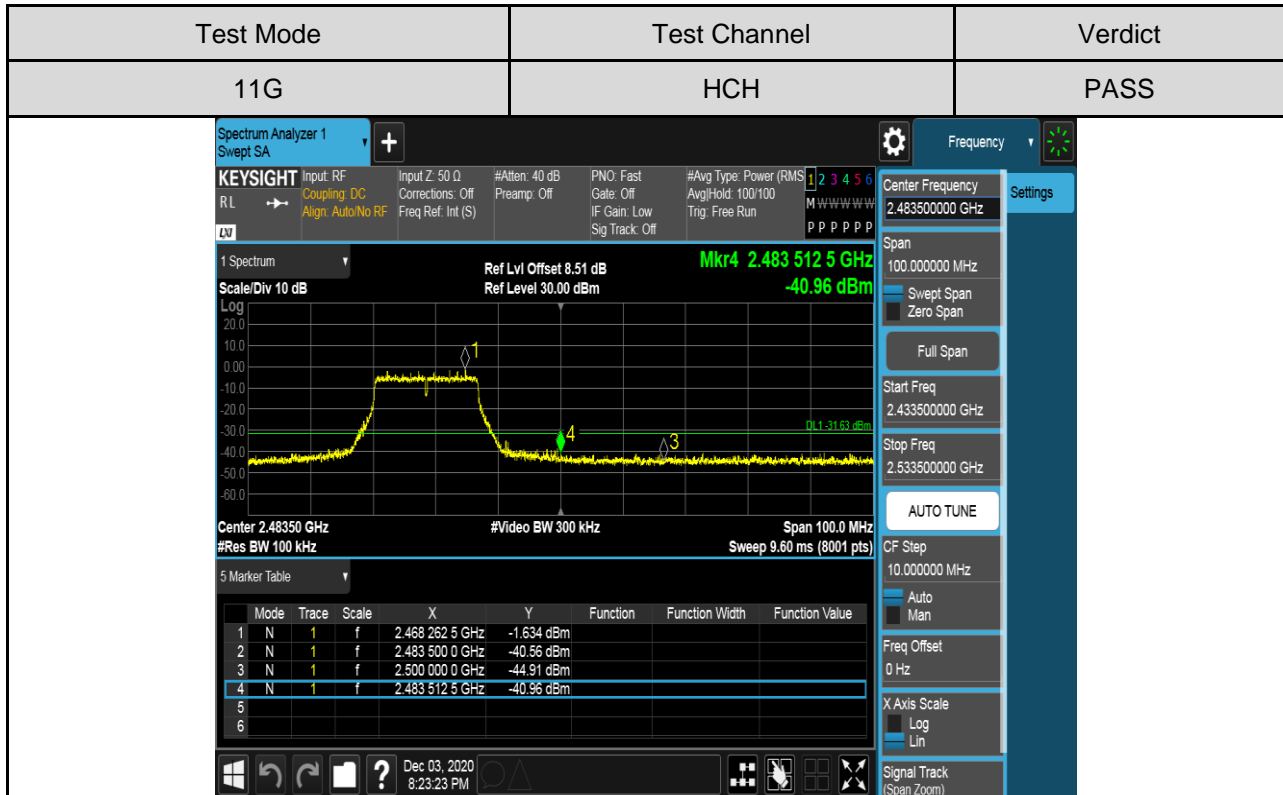
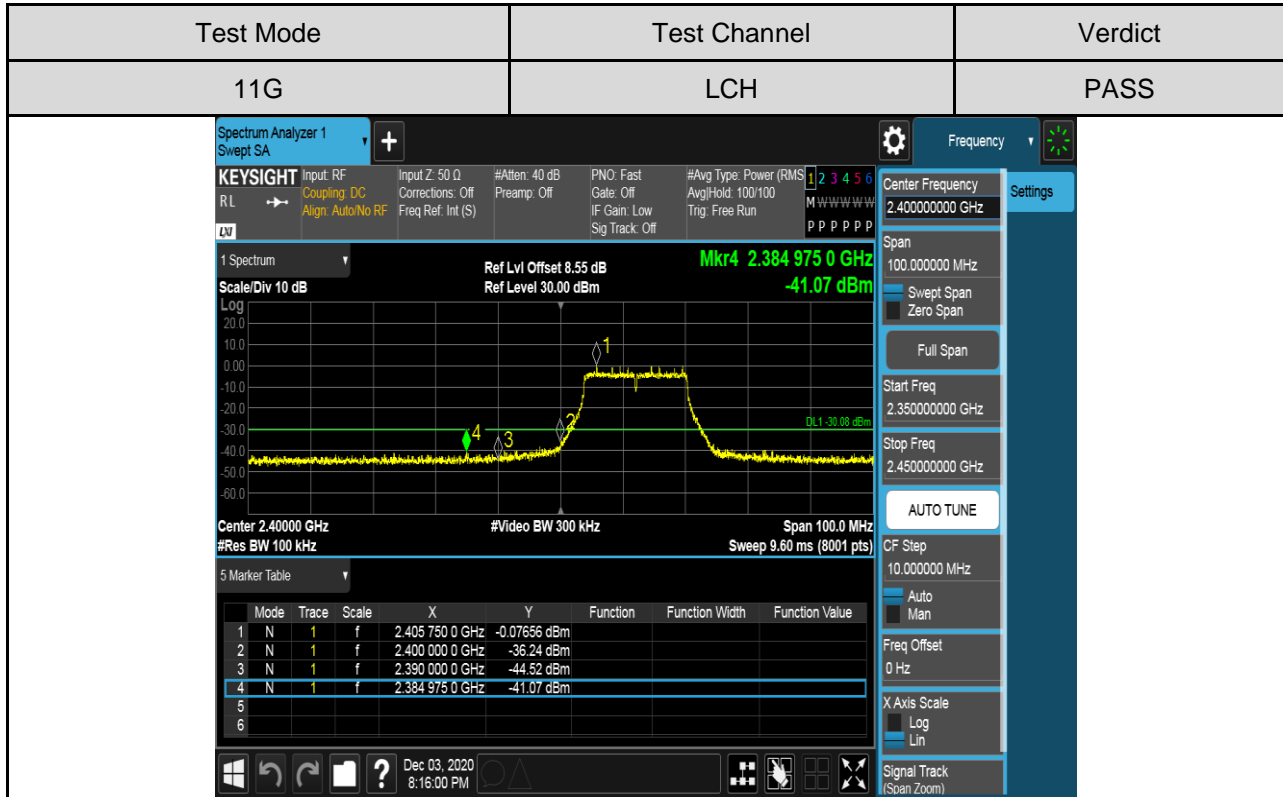

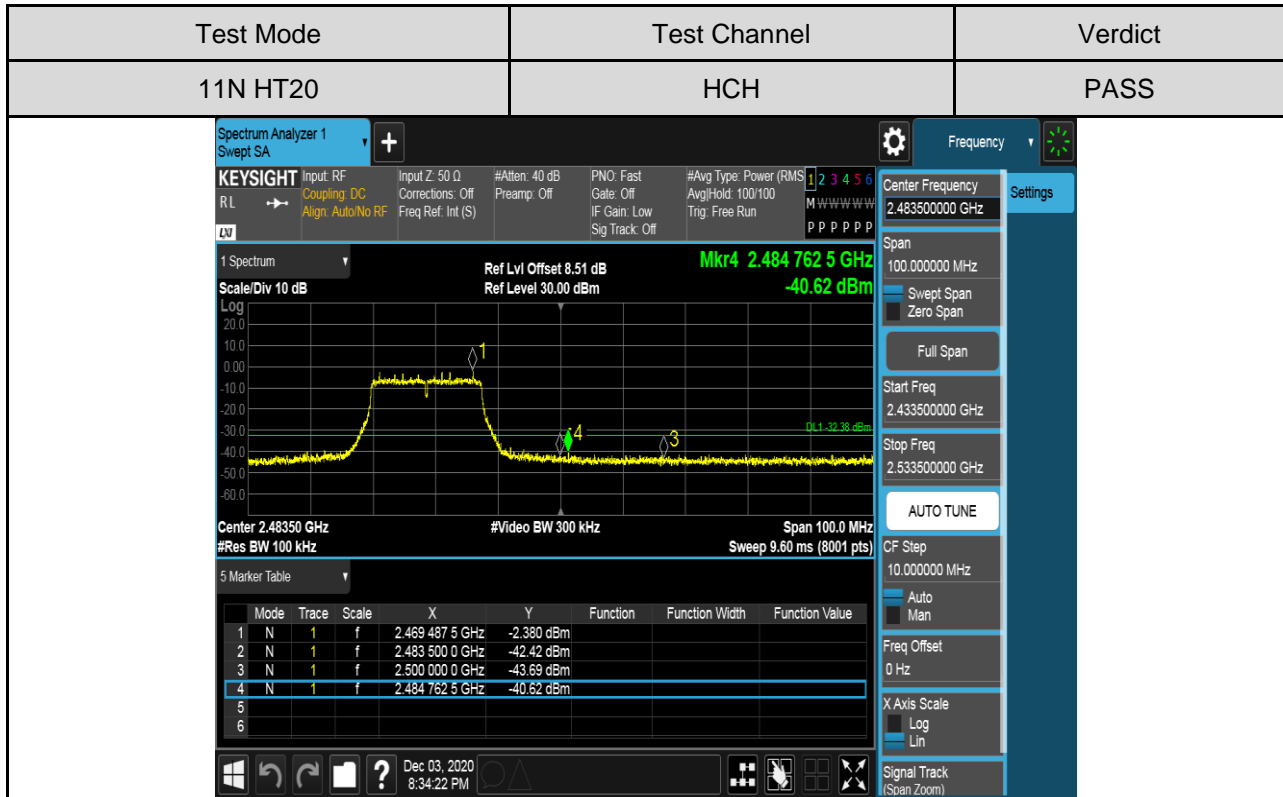
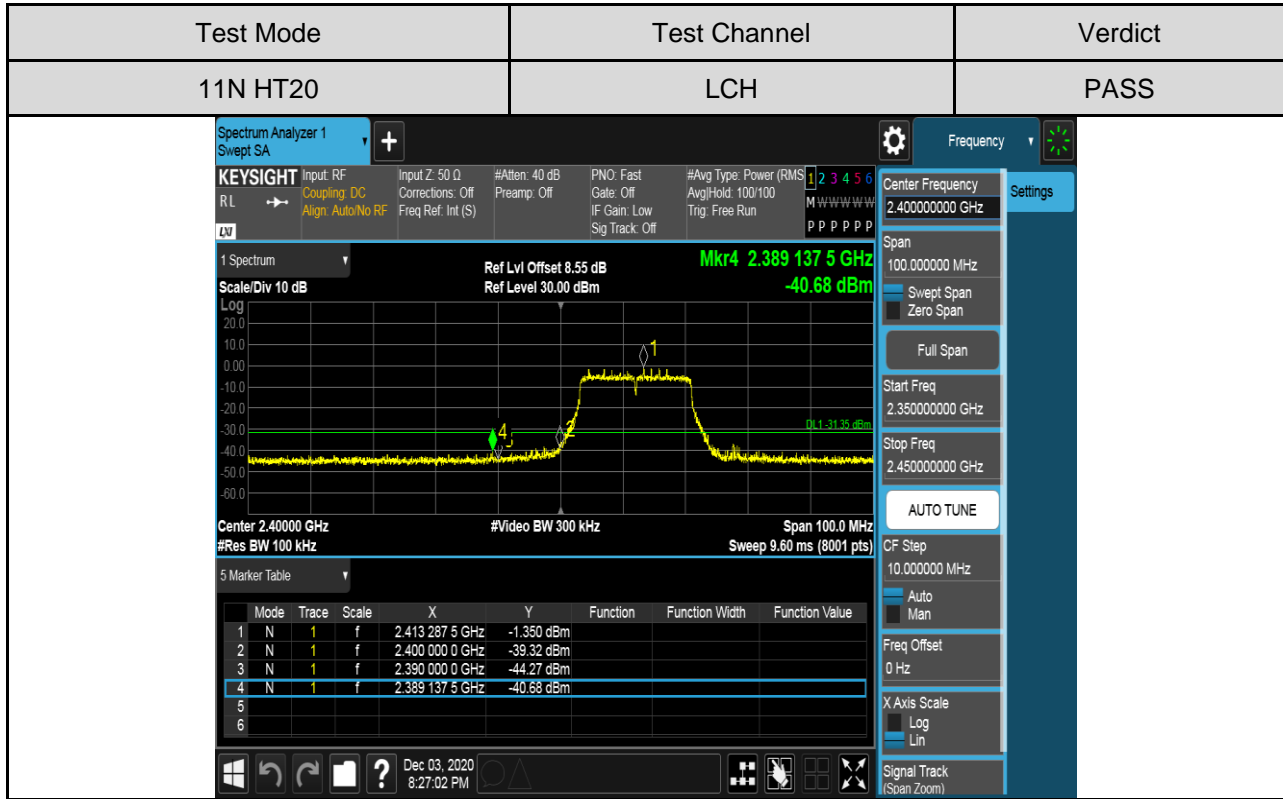

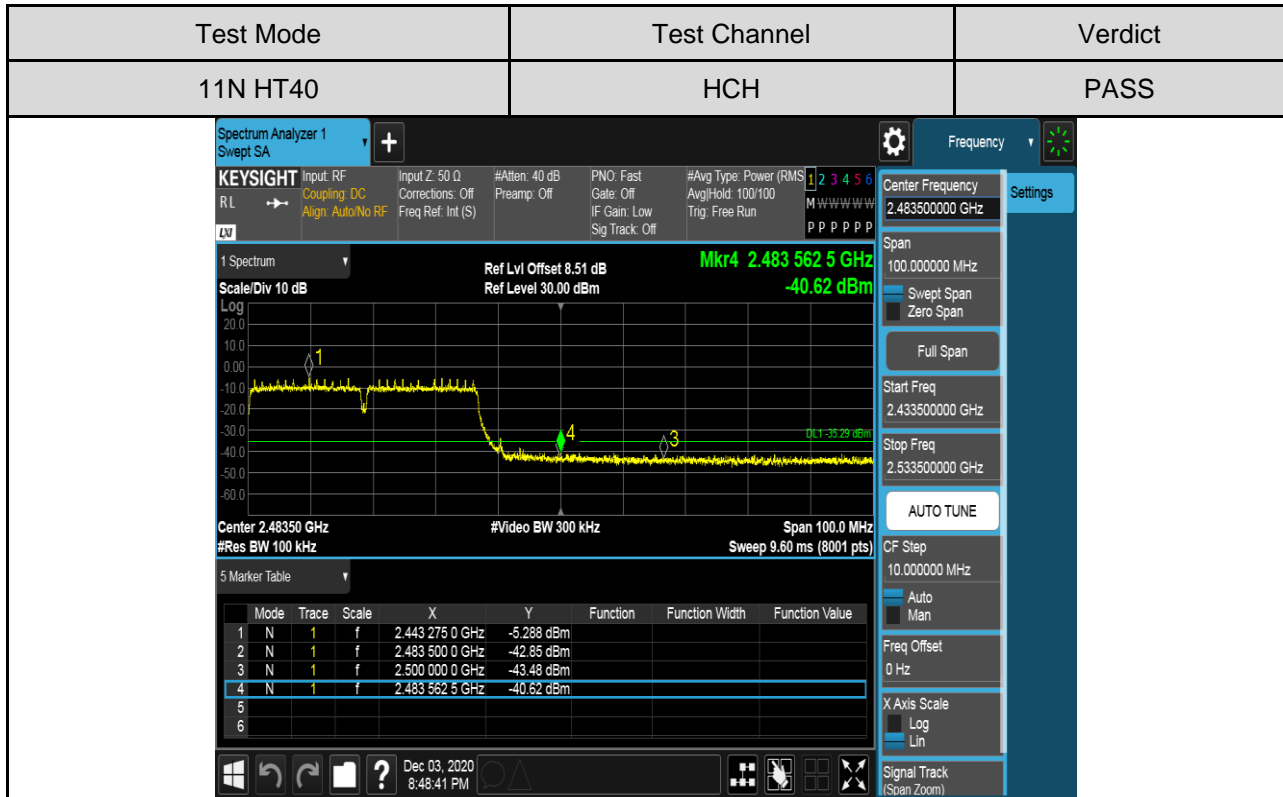
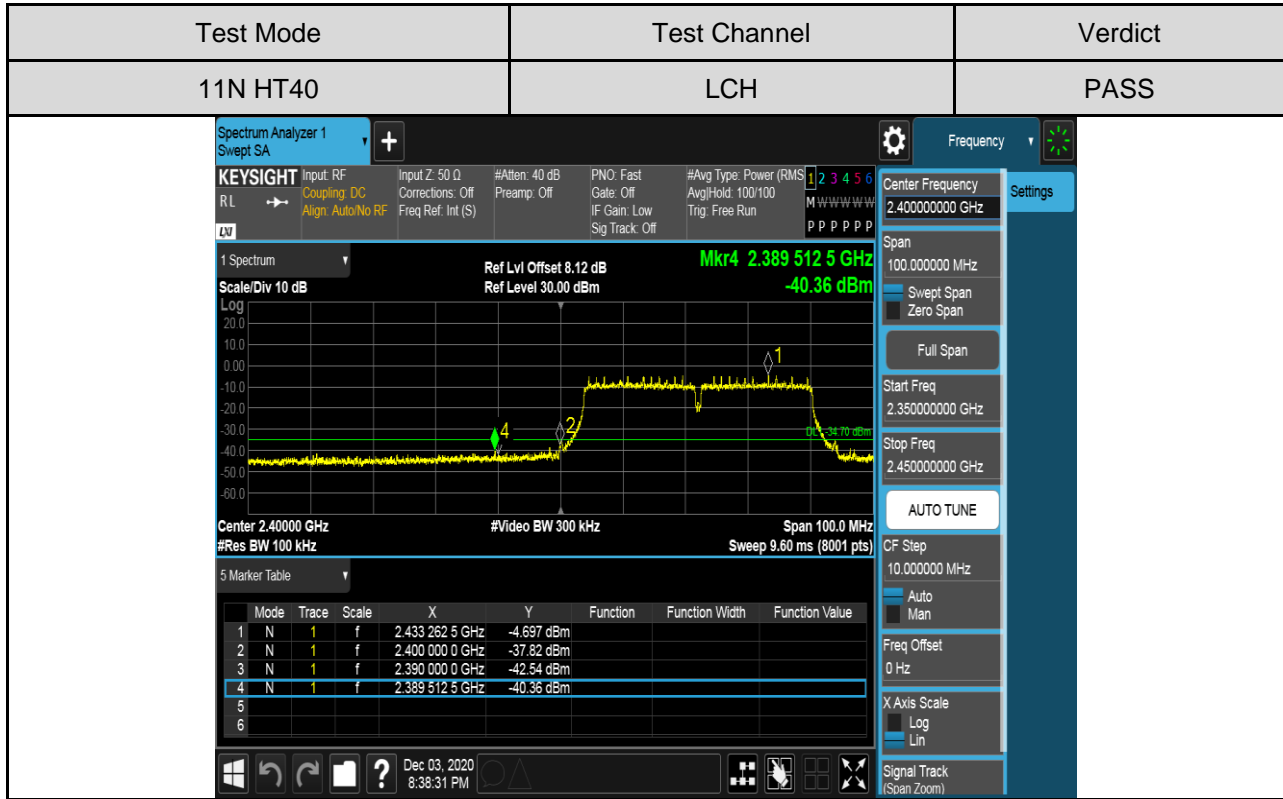



PART II :CONDUCTED EMISSION

TEST RESULTS TABLE

| Test Mode | Channel | Pref(dBm) | Puw(dBm) | Verdict |
|-----------|---------|-----------|----------|---------|
| 11B | LCH | 4.84 | <Limit | PASS |
| | MCH | 3.27 | <Limit | PASS |
| | HCH | 3.52 | <Limit | PASS |
| 11G | LCH | -0.60 | <Limit | PASS |
| | MCH | -1.36 | <Limit | PASS |
| | HCH | -1.25 | <Limit | PASS |
| 11N HT20 | LCH | -1.06 | <Limit | PASS |
| | MCH | -2.55 | <Limit | PASS |
| | HCH | -2.39 | <Limit | PASS |
| 11N HT40 | LCH | -4.58 | <Limit | PASS |
| | MCH | -5.74 | <Limit | PASS |
| | HCH | -5.12 | <Limit | PASS |

TEST GRAPHS

| Test Mode | Channel | Verdict |
|-----------|---------|---------|
| 11B | LCH | PASS |

Pref test Plot

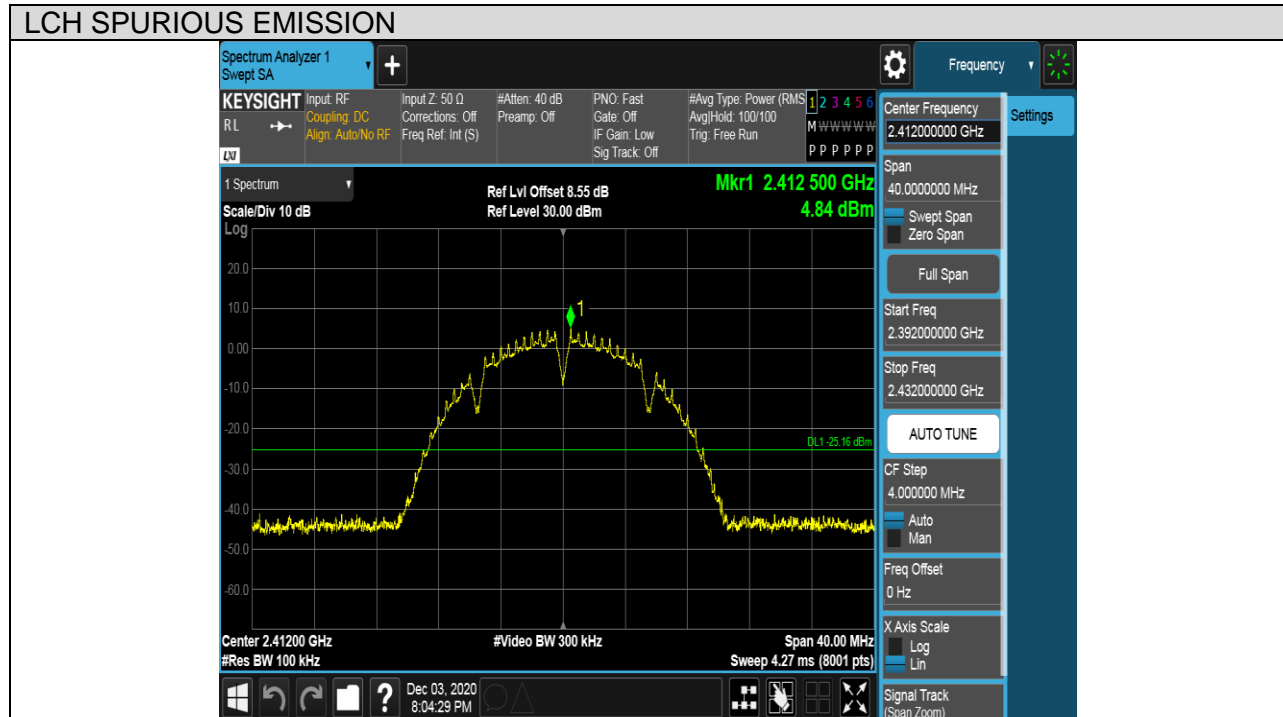



Puw test Plot

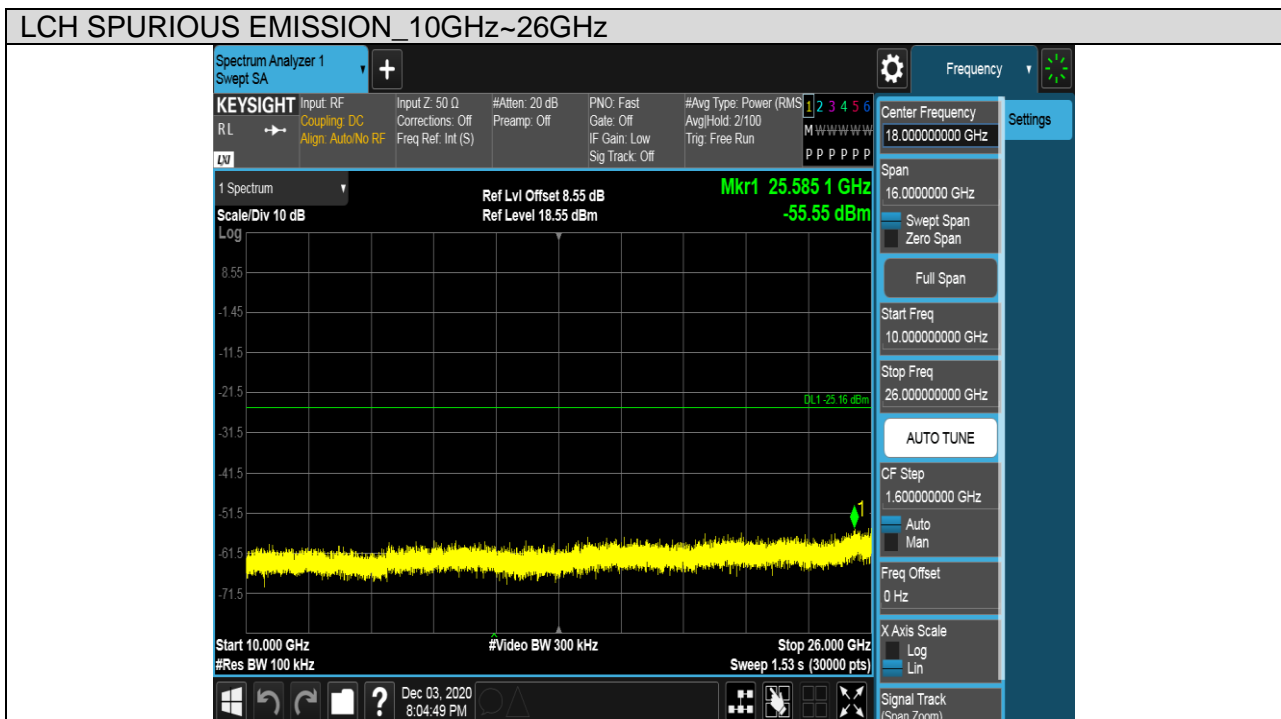
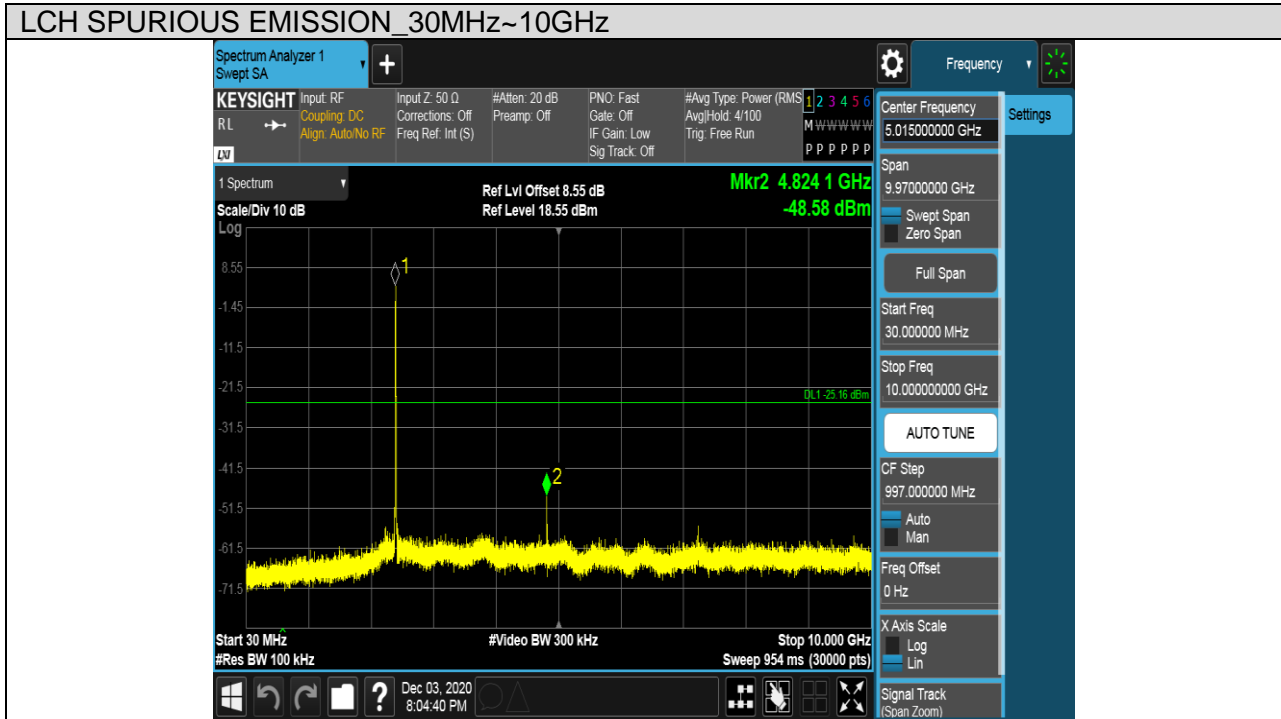



| Test Mode | Channel | Verdict |
|-----------|---------|---------|
| 11B | MCH | PASS |

Pref test Plot

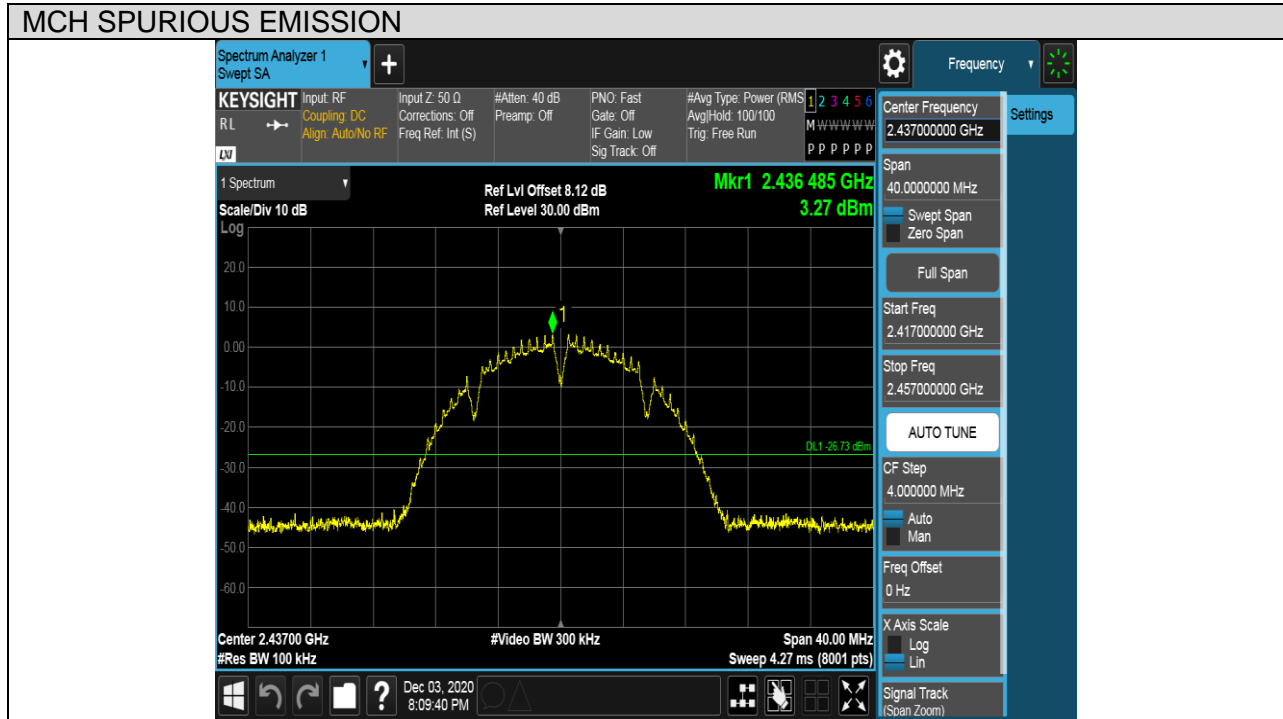



Puw test Plot

MCH SPURIOUS EMISSION_30MHz~10GHz

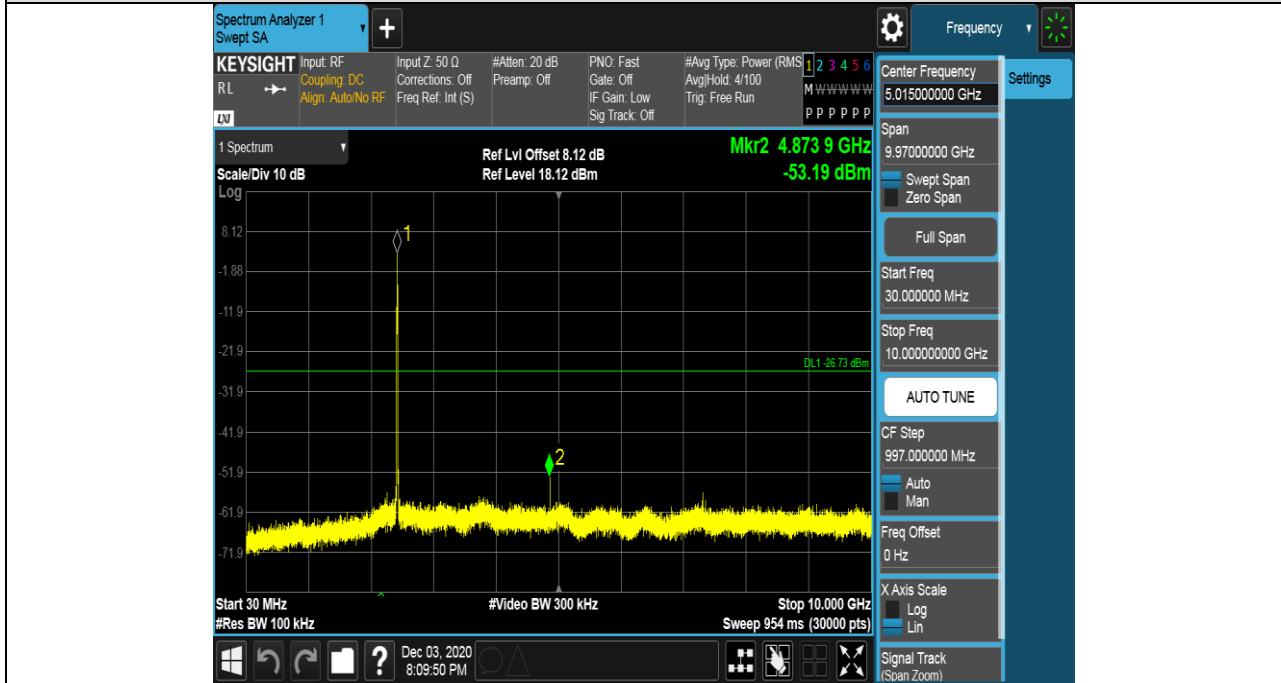

MCH SPURIOUS EMISSION_10GHz~26GHz

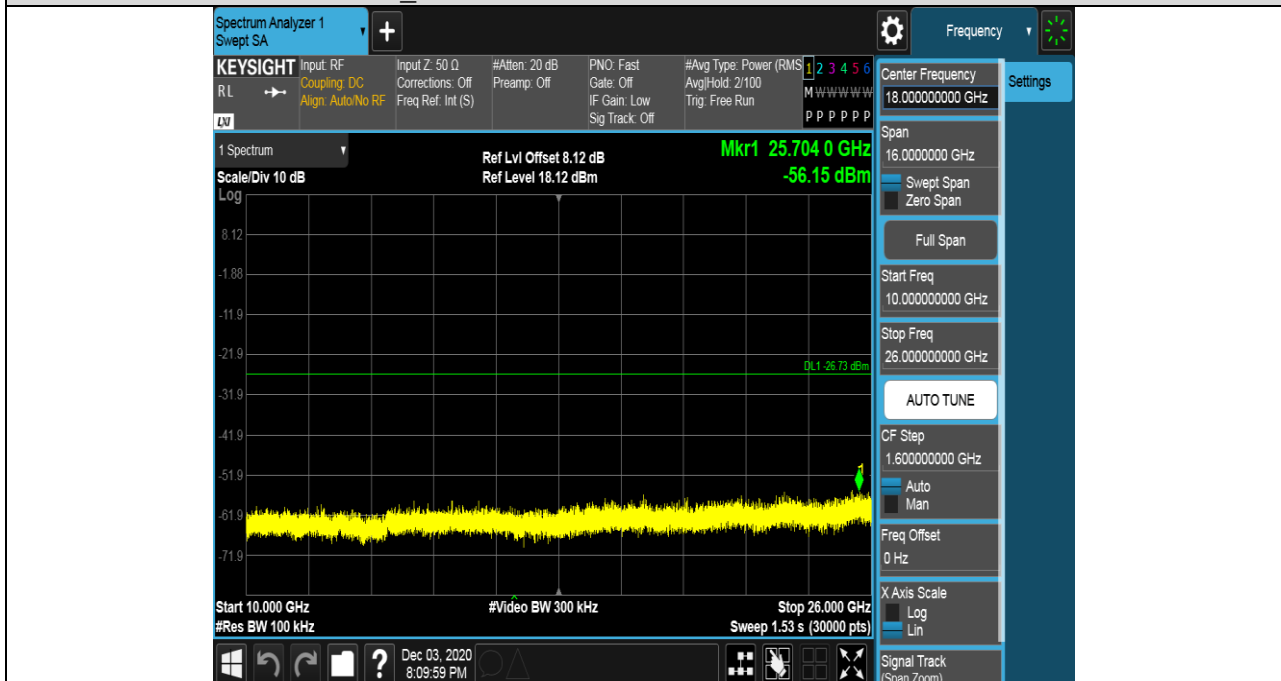



| Test Mode | Channel | Verdict |
|-----------|---------|---------|
| 11B | HCH | PASS |

Pref test Plot

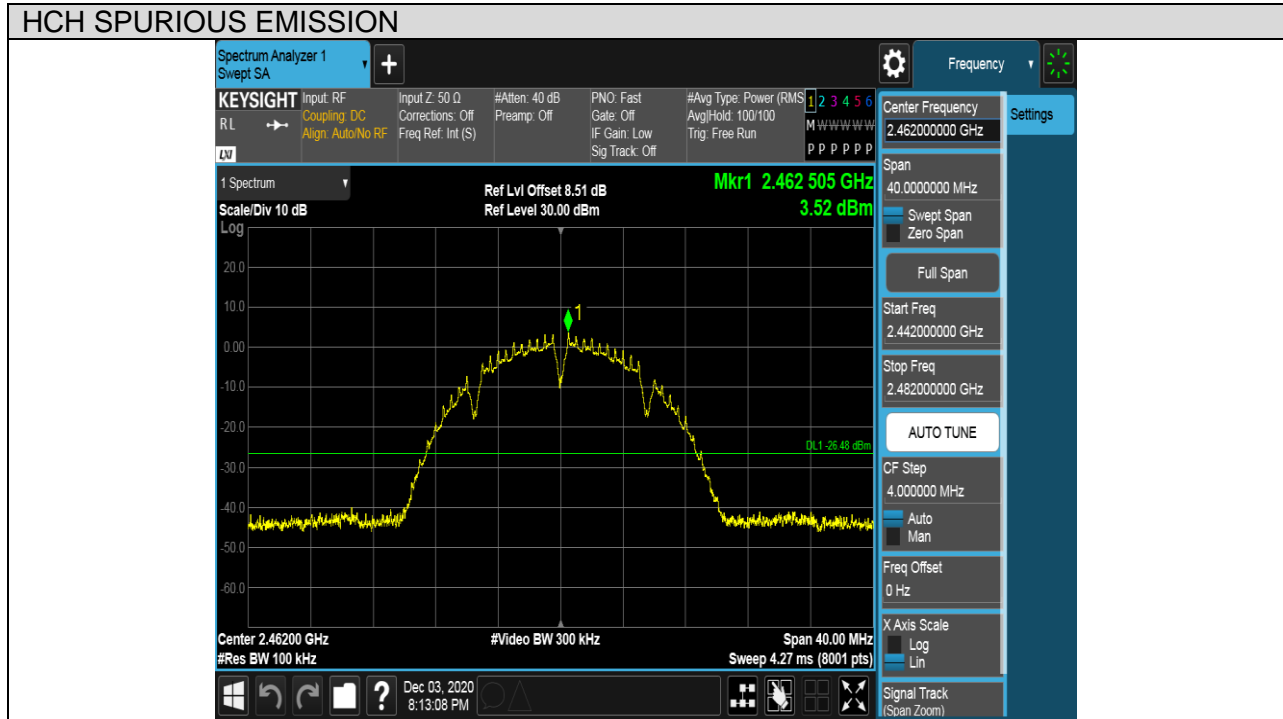



Puw test Plot

HCH SPURIOUS EMISSION_30MHz~10GHz

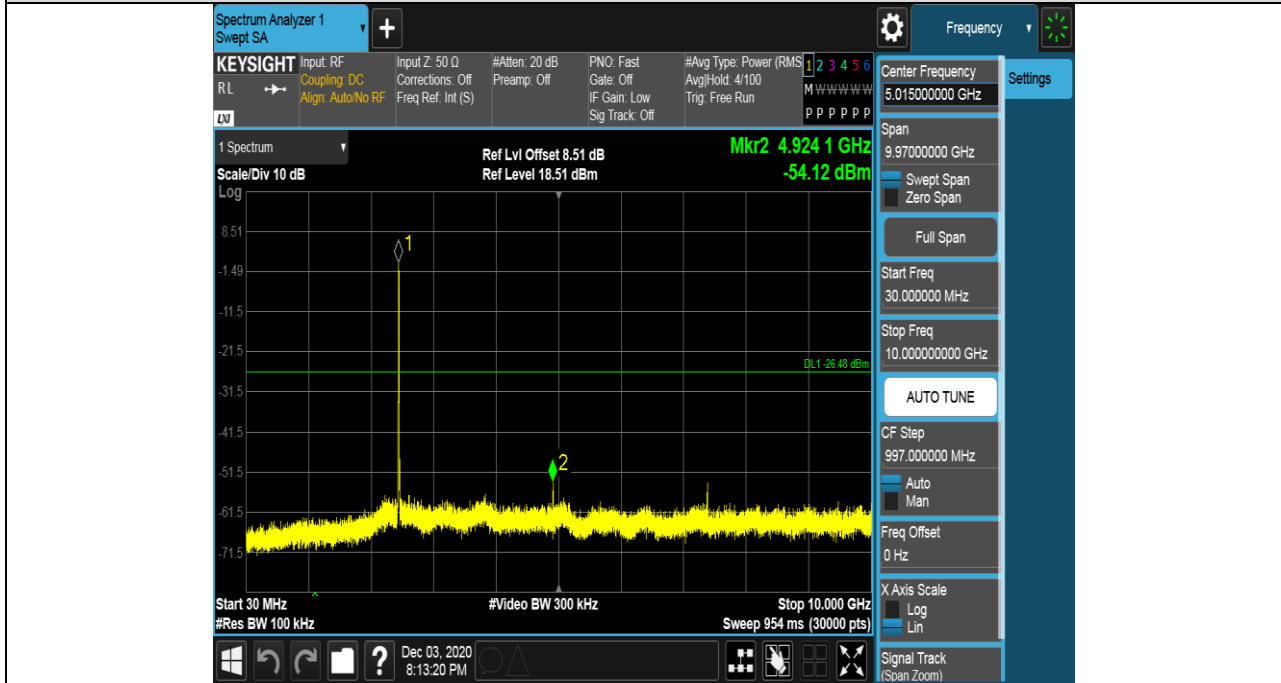

HCH SPURIOUS EMISSION_10GHz~26GHz

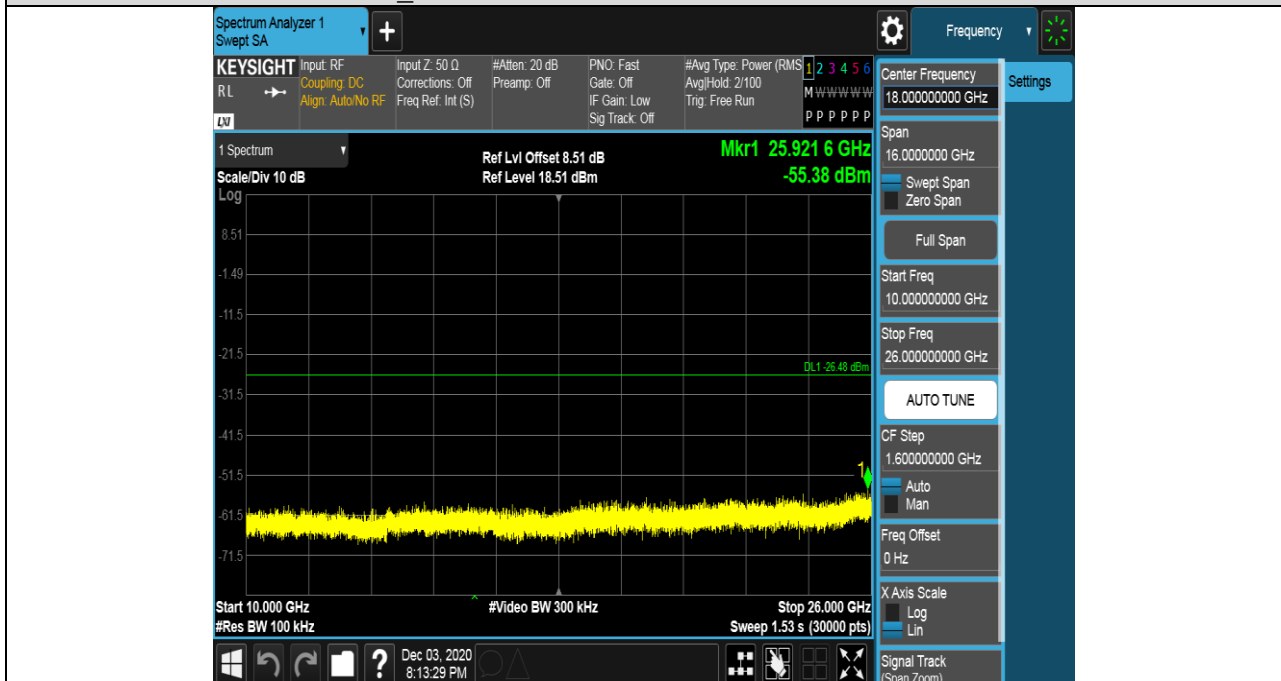



| Test Mode | Channel | Verdict |
|-----------|---------|---------|
| 11G | LCH | PASS |

Pref test Plot

