

The UNIV logo features the letters 'UNIV' in a bold, black, sans-serif font. A red curved line arches over the 'U' and 'N'.



Video Doorbell

1 Doorbell Appearance

·Front and Rear Panels

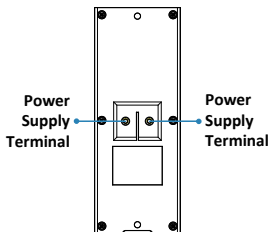
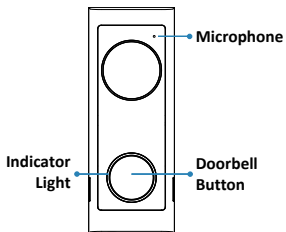

Indicator, button and microphone

Power supply terminal

·Side Panel

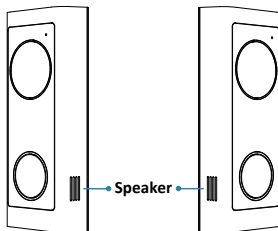

Speaker

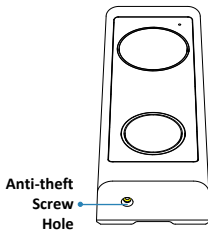

Anti-theft screw hole

·Inside

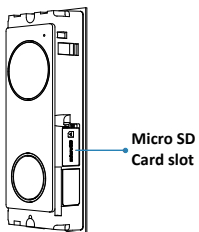

Micro SD card slot

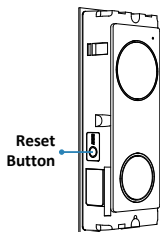

Reset button

2 In The Box



Doorbell body



Replaceable faceplate

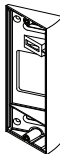

Angle adjustment bracket (horizontal)



Flat bracket



Angle adjustment bracket (vertical)



Mounting level



Dual purpose screwdriver



Set screw for power wire*3



Self-tapping screw (0.75")*3

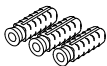

Plastic expansion bolt*3



Anti-theft screw*2

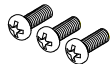

Set screw for securing
the body to the
bracket*3



Self-tapping screw
(1.26")*3



User manual

3 Doorbell Installation

Install Micro SD Card

1. Open the faceplate from the bottom.

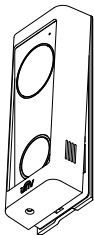

2. Open the Micro SD card slot cover.

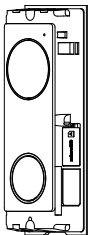

3. Insert the Micro SD card.

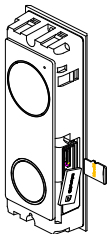

Install the Doorbell

1. Install the mounting level, and mark points on the wall for drilling according to the mounting level.

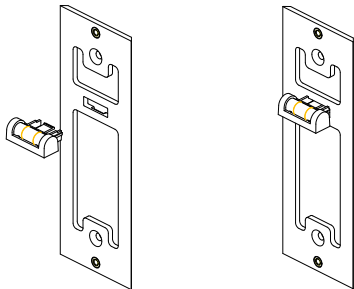

2. Drill holes on the wall, insert expansion bolts, and then insert 0.75" self-tapping screws.

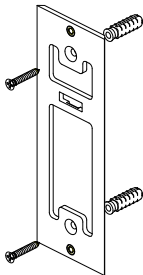

3. Connect the power wires coming out of the wall to the terminals on the back of the doorbell with set screws.(DC 12V or AC 16~24V)

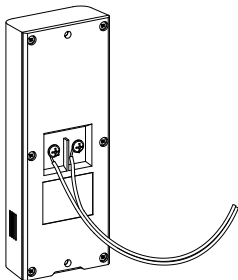

4. Open the faceplate from the bottom.



5. Secure the doorbell body to the bracket using the corresponding set screws.

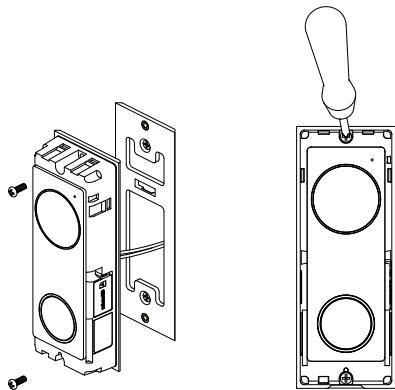

6. Attach the faceplate to the body from the top.

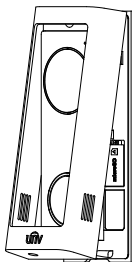

7. Tighten the anti-theft screws at the bottom of the device using the screwdriver.

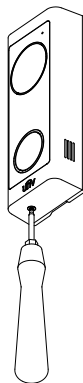

Install the Bracket(Three ways)

A. Install the angle adjustment bracket with 0.75" self-tapping screws.

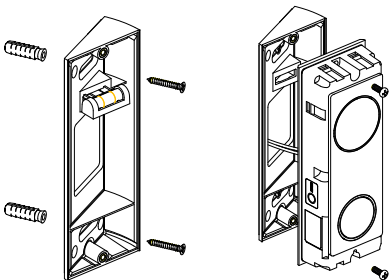

B. Install the angle adjustment bracket with 0.75" self-tapping screws.

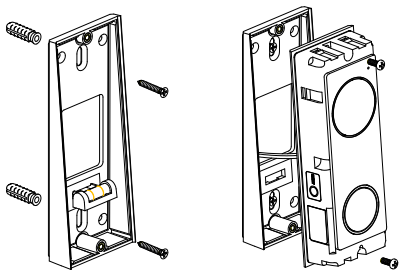

C. Stack angle adjustment brackets

(1) Stack the vertical angle adjustment bracket on top of the horizontal angle adjustment bracket, then install the brackets onto the wall.

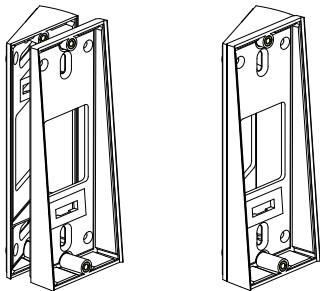

(2) Use the supplied 1.26" self-tapping screws when stacking brackets.

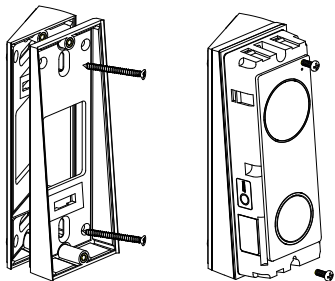

4 Set Up

Download EZLive

Make sure your mobile phone has been connected to Wi-Fi. Scan the following QR code to download and install EZLive.



<https://a.app.qq.com/o/simple.jsp?pkgname=com.uniview.app.smb.phone.en.lingyun>

Add Devices

1. Open EZLive, sign up an overseas account and log in.

2. Click **+** in the upper right corner, and select **“Add Wi-Fi Device”**.

3. Choose video doorbell device.

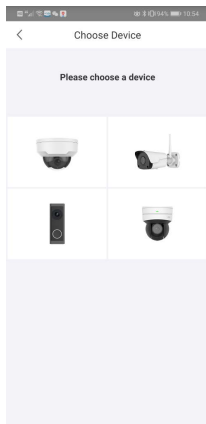
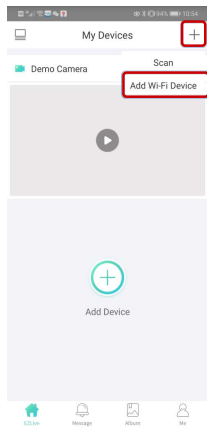

4. Follow the instructions to prepare the device ready for configuration.

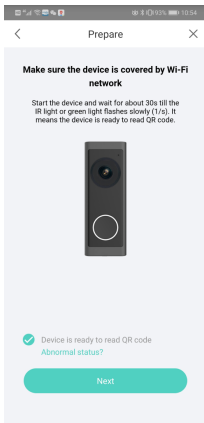

5. Complete configuration information and Scan the QR code on the doorbell.

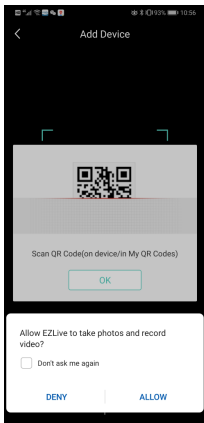
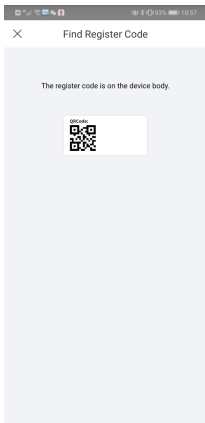
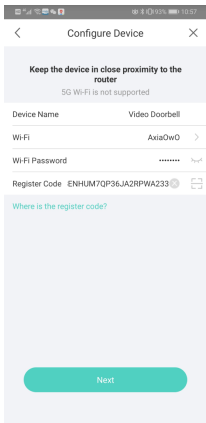

6. A QR code will be Generated on the APP.

7. Use the camera of the doorbell to scan the QR code. When the doorbell indicator turns into steady green and you hear “Network Connected”, click **Success. Continue.**



8. Set DST after the device is added.

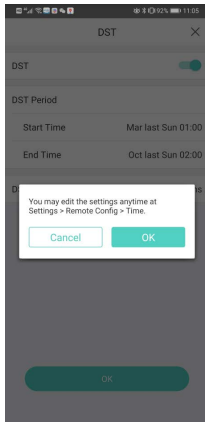
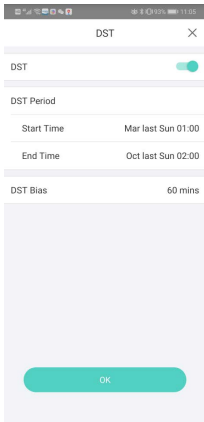

9. View the doorbell in the device list.

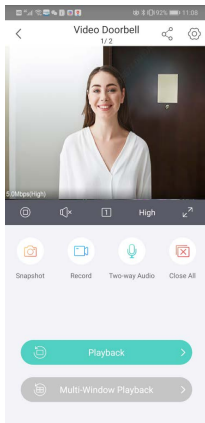

Doorbell Indicator Status During Setup

Indicator Status	Description
Steady red	The device is starting up
Steady green	Wi-Fi connection succeed
Blinking green	<ol style="list-style-type: none">1. Waiting for Wi-Fi configuration.2. QR code scanned, connecting Wi-Fi.

Doorbell Indicator Status After Setup

Indicator Status	Description
Steady green	<ol style="list-style-type: none">1. Normal2. Call ended
Blinking blue	Call initiated
Steady blue	Call connected

Doorbell Indicator Status During Exception

Indicator Status	Description
Blinking red	<ol style="list-style-type: none"><li data-bbox="508 177 866 262">1. Wi-Fi connection failed.<li data-bbox="508 284 866 425">2. The doorbell is resetting or restarting.
Steady yellow	The doorbell gets offline after connected to Wi-Fi.

5 Doorbell Operation

Two-way Audio

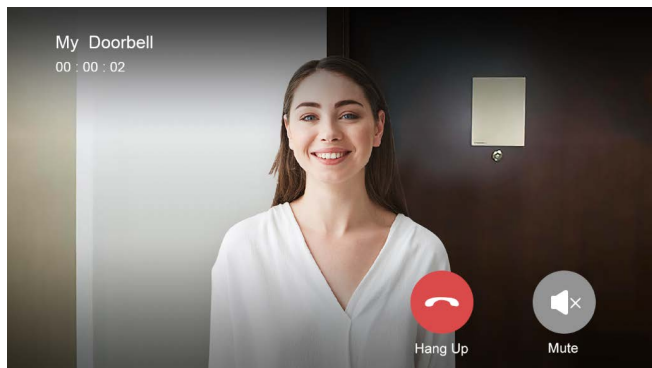

Live View

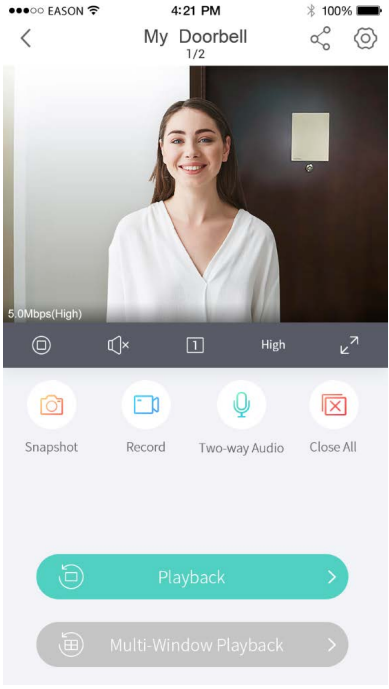

Playback

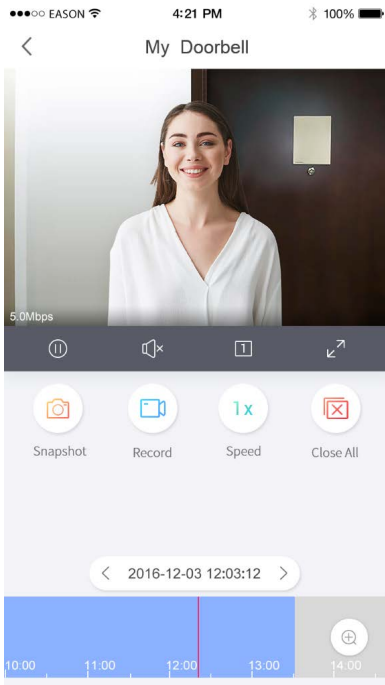

6 Notes

1. Make sure the connected Wi-Fi is 2.4GHz.
2. Make sure your router is close to the doorbell.
3. The installation height of the doorbell is about 1.6 meters.
4. Do not install the doorbell on the metal door to avoid signal interference.

Regulatory Compliance

FCC Part 15

Please take attention that changes or modification not expressly approved by the party responsible for compliance could void the user's authority to operate the equipment.

This device complies with Part 15 of the FCC Rules. Operation is subject to the following two conditions:

- (1) This device may not cause harmful interference, and
- (2) This device must accept any interference received, including interference that may cause undesired operation.

If the distance from the product to the human body is greater than 20cm, the following warning is required.

This equipment complies with FCC radiation exposure limits set forth for an uncontrolled environment. This equipment should be installed and operated with minimum distance 20cm between the radiator & your body.

LVD/EMC Directive



This product complies with the European Low Voltage Directive 2014/35/EU and EMC Directive 2014/30/EU.

WEEE Directive–2012/19/EU



The product this manual refers to is covered by the Waste Electrical & Electronic Equipment (WEEE) Directive and must be disposed of in a responsible manner.





Battery in the product complies with the European Battery Directive 2013/56/EC. For proper recycling, return the battery to your supplier or to a designated collection point.

- Zhejiang Uniview Technologies Co., Ltd.
- Building No.10, Wanlun Science Park, Jiangling Road 88, Binjiang District, Hangzhou, Zhejiang, China (310051)
- Email: overseasbusiness@uniview.com;
globalsupport@uniview.com
- <http://www.uniview.com>
- ©2019 Zhejiang Uniview Technologies Co., Ltd. All rights reserved.
- *Product specifications and availability are subject to change without notice.

Version: V1.02

BOM: 3105C00P