



# RADIO TEST REPORT

Report No: STS1806235W01

Issued for

**ZHEJIANG UNIVIEW TECHNOLOGIES CO LTD**

88 JIANGLING RD, BINJIANG DISTRICT HANGZHOU,  
ZHEJIANG 310051, P.R. CHINA

<b>Product Name:</b>	IP Camera
<b>Brand Name:</b>	N/A
<b>Model Name:</b>	IPC2122SR3-F40W-D
<b>Series Model:</b>	IPC2122SR3-F40W-D-NB, IPC2122SR3-F60W-D, IPC2122SR3-F60W-D-NB
<b>FCC ID:</b>	2AL8S-0211C2W2
<b>Test Standard:</b>	CFR47 FCC Part 15: Subpart C Section 15.247 CFR47 FCC Part 15: Subpart C Section 15.207 CFR47 FCC Part 15: Subpart C Section 15.209 CFR47 FCC Part 15: Subpart B Section 15.107 CFR47 FCC Part 15: Subpart B Section 15.109

Any reproduction of this document must be done in full. No single part of this document may be reproduced without permission from STS, All Test Data Presented in this report is only applicable to presented Test sample.





## TEST RESULT CERTIFICATION

**Applicant's name** ..... : **ZHEJIANG UNIVIEW TECHNOLOGIES CO LTD**  
**Address** ..... : 88 JIANGLING RD, BINJIANG DISTRICT HANGZHOU, ZHEJIANG  
310051, P.R. CHINA  
**Manufacture's Name** ..... : **1. Zhejiang Uniview Technologies Co., Ltd.**  
**2. Suzhou Qiaoxin Electronic Technology Co., Ltd.**  
**3. TDG TECHNOLOGY CO LTD**  
**4. ZHE JIANG RAYSOAR ELECTRONICS CO LTD**  
**Address** ..... : 1. A Zone, Building 2, Wanlun Science Park, 88 Jiangling Road,  
Hangzhou, P.R. China  
2. No. 77, Yitang Road, Economic Development Zone, Wujiang  
District, Suzhou City, Jiangsu Province, China 215200  
3. YATAI ROAD NO.1, SOUTH LAKE DISTRICT, JIAXING,  
ZHEJIANG, PROVINCE, 314050, P.R. CHINA.  
4. No. 367 Weizhong Road, Weitang Street, Jiashan County, Jiaxing,  
Zhejiang

### Product description

**Product Name** ..... : IP Camera  
**Brand Name** ..... : N/A  
**Model Name** ..... : IPC2122SR3-F40W-D  
**Series Model** ..... : IPC2122SR3-F40W-D-NB, IPC2122SR3-F60W-D,  
IPC2122SR3-F60W-D-NB  
**Test Standards** ..... : CFR47 FCC Part 15: Subpart C Section 15.247  
CFR47 FCC Part 15: Subpart C Section 15.207  
CFR47 FCC Part 15: Subpart C Section 15.209  
CFR47 FCC Part 15: Subpart B Section 15.107  
CFR47 FCC Part 15: Subpart B Section 15.109

**Test procedure** ..... : ANSI C63.10: 2013, ANSI C63.4: 2014

This device described above has been tested by STS, the test results show that the equipment under test (EUT) is in compliance with the FCC/IC requirements. And it is applicable only to the tested sample identified in the report.

This report shall not be reproduced except in full, without the written approval of STS, this document only be altered or revised by STS, personal only, and shall be noted in the revision of the document.

**Date of Test** .....

**Date (s) of performance of tests** ..... : 01 Jul. 2018 ~ 26 Jul. 2018

**Date of Issue** ..... : 27 Jul. 2018

**Test Result** ..... : **Pass**



Testing Engineer : Chris Chen  
( Chris Chen )

Technical Manager : Sean She  
( Sean She )

Authorized Signatory : Vita Li  
( Vita Li )





## Table of Contents

Page

<b>1</b>	<b>SUMMARY OF TEST RESULTS</b>	<b>7</b>
1.1	TEST FACTORY	8
1.2	MEASUREMENT UNCERTAINTY	8
<b>2</b>	<b>GENERAL INFORMATION</b>	<b>9</b>
2.1	GENERAL DESCRIPTION OF EUT	9
2.2	DESCRIPTION OF TEST MODES	11
2.3	BLOCK DIGRAM SHOWING THE CONFIGURATION OF SYSTEM TESTED	12
2.4	DESCRIPTION OF SUPPORT UNITS	12
2.5	EQUIPMENTS LIST FOR ALL TEST ITEMS	13
<b>3</b>	<b>EMC EMISSION TEST</b>	<b>15</b>
3.1	CONDUCTED EMISSION MEASUREMENT	15
3.2	RADIATED EMISSION MEASUREMENT	23
3.3	RADIATED SPURIOUS EMISSION MEASUREMENT	33
<b>4</b>	<b>CONDUCTED SPURIOUS &amp; BAND EDGE EMISSION</b>	<b>43</b>
4.1	APPLIED PROCEDURES / LIMIT	43
4.2	TEST PROCEDURE	43
4.3	DEVIATION FROM STANDARD	43
4.4	TEST SETUP	43
4.5	EUT OPERATION CONDITIONS	43
4.6	TEST RESULTS	44
<b>5</b>	<b>POWER SPECTRAL DENSITY TEST</b>	<b>53</b>
5.1	APPLIED PROCEDURES / LIMIT	53
5.2	TEST PROCEDURE	53
5.3	DEVIATION FROM STANDARD	53
5.4	TEST SETUP	53
5.5	EUT OPERATION CONDITIONS	53
5.6	TEST RESULTS	54
<b>6</b>	<b>BANDWIDTH TEST</b>	<b>60</b>
6.1	APPLIED PROCEDURES / LIMIT	60
6.2	TEST PROCEDURE	60
6.3	DEVIATION FROM STANDARD	60
6.4	TEST SETUP	60
6.5	EUT OPERATION CONDITIONS	60
6.6	TEST RESULTS	61



- 7 PEAK OUTPUT POWER TEST ..... 67**
  - 7.1 APPLIED PROCEDURES / LIMIT ..... 67
  - 7.2 TEST PROCEDURE ..... 67
  - 7.3 DEVIATION FROM STANDARD ..... 67
  - 7.4 TEST SETUP ..... 67
  - 7.5 EUT OPERATION CONDITIONS ..... 67
  - 7.6 TEST RESULTS ..... 68
- 8 ANTENNA REQUIREMENT ..... 69**
  - 8.1 STANDARD REQUIREMENT ..... 69
  - 8.2 EUT ANTENNA ..... 69
- 9 APPENDIX - PHOTOS OF TEST SETUP ..... 70**





**Revision History**

Rev.	Issue Date	Report NO.	Effect Page	Contents
00	27 Jul. 2018	STS1806235W01	ALL	Initial Issue





## 1 SUMMARY OF TEST RESULTS

Test procedures according to the technical standards:

KDB 558074 D01 DTS Meas Guidance v04

FCC Part 15, Subpart C			
Standard Section	Test Item	Judgment	Remark
FCC Part 15.207(a)	Conducted Emission	PASS	
FCC Part 15.247(a)(2)	6dB Bandwidth	PASS	
FCC Part 15.247(b)(3)	Output Power	PASS	
FCC Part 15.247(d)	Radiated Spurious Emission	PASS	
FCC Part 15.247(d)	Conducted Spurious & Band Edge Emission	PASS	
FCC Part 15.247(e)	Power Spectral Density	PASS	
FCC Part 15.205	Restricted Band Edge Emission	PASS	
FCC Part 15.247(d) & 15.209(a)	Band Edge Emission	PASS	
FCC Part 15.247(b)(4) & 15.203	Antenna Requirement	PASS	

FCC Part 15, Subpart B			
Standard Section	Test Item	Judgment	Remark
FCC Part 15.107(a)	Conducted Emission	PASS	Class B limit
FCC Part 15.109(a)	Radiated Emission	PASS	Class B limit

NOTE:

- 1) 'N/A' denotes test is not applicable in this test report
- 2) All tests were performed according to the procedures in ANSI C63.10: 2013 and ANSI C63.4: 2014.



## 1.1 TEST FACTORY

Shenzhen STS Test Services Co., Ltd.  
Add. : 1/F., Building B, Zhuoke Science Park, No.190, Chongqing Road, Fuyong Street, Bao'an District, Shenzhen, Guangdong, China

CNAS Registration No.: L7649; FCC Registration No.: 625569  
IC Registration No.: 12108A; A2LA Certificate No.: 4338.01;

## 1.2 MEASUREMENT UNCERTAINTY

The reported uncertainty of measurement  $y \pm U$ , where expanded uncertainty  $U$  is based on a standard uncertainty multiplied by a coverage factor of  $k=2$ , providing a level of confidence of approximately 95 %.

No.	Item	Uncertainty
1	Conducted Emission (9KHz-150KHz)	$\pm 2.88\text{dB}$
2	Conducted Emission (150KHz-30MHz)	$\pm 2.67\text{dB}$
3	RF power,conducted	$\pm 0.71\text{dB}$
4	Spurious emissions,conducted	$\pm 0.63\text{dB}$
5	All emissions,radiated (9KHz-30MHz)	$\pm 3.02\text{dB}$
6	All emissions,radiated (30MHz-200MHz)	$\pm 3.80\text{dB}$
7	All emissions,radiated (200MHz-1000MHz)	$\pm 3.97\text{dB}$
8	All emissions,radiated(>1G)	$\pm 3.03\text{dB}$





## 2 GENERAL INFORMATION

### 2.1 GENERAL DESCRIPTION OF EUT

Product Name	IP Camera	
Trade Name	N/A	
Model Name	IPC2122SR3-F40W-D	
Series Model	IPC2122SR3-F40W-D-NB, IPC2122SR3-F60W-D, IPC2122SR3-F60W-D-NB	
Model Difference	All models are identical except the model number.	
Product Description	The EUT is IP Camera which supports Wi-Fi 802.11 b/g/n wireless technology.	
	Operation Frequency:	2412 - 2462 MHz for 802.11b/g/n(HT20)
	Modulation Type:	DSSS(DBPSK/DQPSK/CCK) OFDM(BPSK/QPSK/16QAM/64QAM)
	Bit Rate of Transmitter:	1/2/5.5/11 Mbps for 802.11b 6/9/12/18/24/36/48/54 Mbps for 802.11g MCS0 ~ MCS7 for 802.11n
	Number Of Channel:	11 channels for 802.11b/g/n(HT20)
	Antenna Designation:	Please see Note 4
	Antenna Gain (dBi):	2.6dBi
	Duty Cycle:	>98%
Channel List	Please refer to the Note 2.	
Adapter	Adapter Model: ADS-12FB-12 12012EPCU (HONOR) Input: AC 100-240V~50/60Hz, 0.3A Output: DC 12.0V@1000mA	
Battery	N/A	
Hardware version	N/A	
Software version	N/A	
Radio Hardware version	N/A	
Radio Software version	N/A	
Test Software	SecureCRT	
RF Power Setting TEST Software (power class)	default	
Connecting I/O Port(s)	Please refer to the User's Manual	



Note:

- 1 For a more detailed features description, please refer to the manufacturer's specifications or the User's Manual.

2

RF Channel and Frequency of Wi-Fi 802.11 b/g/n			
802.11b/g/n (HT20)			
RF Channel	Freq.(MHz)		
<b>01</b>	<b>2412</b>		
02	2417		
03	2422		
04	2427		
05	2432		
<b>06</b>	<b>2437</b>		
07	2442		
08	2447		
09	2452		
10	2457		
<b>11</b>	<b>2462</b>		

3 Note:

- 1) In section 15.31(m), regards to the operating frequency range over 10 MHz, the Lowest frequency, the middle frequency, and the highest frequency of channel were selected to perform the test;
- 2) Test frequencies are lowest channel: 2412 MHz, middle channel: 2437 MHz and highest channel: 2462 MHz for 802.11b/g/n(HT20)

4

Ant	Brand	Model Name	Antenna Type	Connector	Gain (dBi)	NOTE
1	N/A	IPC2122SR3-F4 0W-D	External Antenna	RP-SMA C onconnector	2.6	WLAN Antenna



## 2.2 DESCRIPTION OF TEST MODES

Each of these EUT operation mode(s) or test configuration mode(s) mentioned above was evaluated respectively.

Worst Mode	Description	Data Rate
Mode 1	TX IEEE 802.11b CH1	1 Mbps
Mode 2	TX IEEE 802.11b CH6	1 Mbps
Mode 3	TX IEEE 802.11 b CH11	1 Mbps
Mode 4	TX IEEE 802.11g CH1	6 Mbps
Mode 5	TX IEEE 802.11g CH6	6 Mbps
Mode 6	TX IEEE 802.11g CH11	6 Mbps
Mode 7	TX IEEE 802.11n HT20 CH1	MCS 0
Mode 8	TX IEEE 802.11n HT20 CH6	MCS 0
Mode 9	TX IEEE 802.11n HT20 CH11	MCS 0
Mode10	Wi-Fi transmitting mode	/
Mode 11	Recording+Replay+Download mode	/
Mode 12	Local Recording mode	/

Note:

- 1) The measurements are performed at all Bit Rate of Transmitter, the worst data was reported
- 2) We have be tested for all avaiable U.S. voltage and frequencies(For 120V,50/60Hz and 240V, 50/60Hz) for which the device is capable of operation, and the worst case of 120V/60Hz is shown in the report
- 3) Controlled using a bespoke application on the laptop PC supplied by the customer. The application was used to enable a continuous transmission mode and to select the test channels, data rates and modulation schemes as required.
- 4) According to the model differences description, we choose model: IPC2122SR3-F40W-D to perform all tests.

### 2.3 BLOCK DIGRAM SHOWING THE CONFIGURATION OF SYSTEM TESTED

#### Radiation Test Set

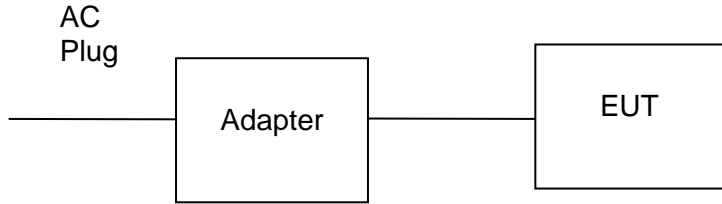

#### Conduction Test Set

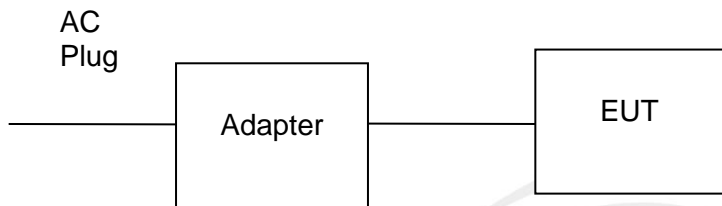

### 2.4 DESCRIPTION OF SUPPORT UNITS

The EUT has been tested as an independent unit together with other necessary accessories or support units. The following support units or accessories were used to form a representative test configuration during the tests.

Item	Equipment	Mfr/Brand	Model/Type No.	Serial No.	Note
1	Adapter	HONOR	ADS-12FB-12 12012EPCU	N/A	Provided by lab
2	Personal computer	HP	500-320cx	4CV428DQYN	
3	TF card	Kingston	32GB	N/A	
4	Honor 8	HUAWEI	FRD-AL00	N/A	
5	iPhone 7	Apple	A1661	N/A	

Item	Shielded Type	Ferrite Core	Length	Note
1	RJ45 cable*2	NO	200cm	N/A

Note:

- 1) The support equipment was authorized by Declaration of Confirmation.
- 2) For detachable type I/O cable should be specified the length in cm in 『Length』 column.
- 3) “YES” is means “shielded” “with core”; “NO” is means “unshielded” “without core”.



## 2.5 EQUIPMENTS LIST FOR ALL TEST ITEMS

### Radiation Test equipment

Kind of Equipment	Manufacturer	Type No.	Serial No.	Last calibration	Calibrated until
EMI Test Receiver	R&S	ESCI	102086	2017.10.15	2018.10.14
Bilog Antenna	TESEQ	CBL6111D	34678	2017.11.02	2018.11.01
Horn Antenna	Schwarzbeck	BBHA 9120D	9120D-1343	2017.10.27	2018.10.26
SHF-EHF Horn Antenna (18G-40GHz)	A-INFO	LB-180400-KF	N/A	2018.03.11	2019.03.10
Temperature & Humidity	HH660	Mieo	N/A	2017.10.15	2018.10.14
Temperature & Humidity	HH660	Mieo	N/A	2017.10.15	2018.10.14
Pre-mpifier (0.1M-3GHz)	EM	EM330	60538	2018.03.11	2019.03.10
PreAmplifier (1G-26.5GHz)	Agilent	8449B	60538	2017.10.15	2018.10.14
Passive Loop (9K--30MHz)	ZHNAN	ZN3090C	16035	2018.03.11	2019.03.10
Low frequency cable	EM	R01	N/A	2018.03.11	2019.03.10
Low frequency cable	EM	R06	N/A	2018.03.11	2019.03.10
High frequency cable	SCHWARZBECK	R04	N/A	2018.03.11	2019.03.10
High frequency cable	SCHWARZBECK	R02	N/A	2018.03.11	2019.03.10
Semi-anechoic chamber	Changling	966	N/A	2017.10.15	2018.10.14
trun table	EM	SC100_1	60531	N/A	N/A
Antnna mast	EM	SC100	N/A	N/A	N/A
Max-full Antenna Corp	MF	MFA-440H	N/A	N/A	N/A

### Conduction Test equipment

Kind of Equipment	Manufacturer	Type No.	Serial No.	Last calibration	Calibrated until
Test Receiver	R&S	ESCI	101427	2017.10.15	2018.10.14
LISN	R&S	ENV216	101242	2017.10.15	2018.10.14
conduction Cable	EM	C01	N/A	2018.03.11	2019.03.10
Temperature & Humidity	Mieo	HH660	N/A	2017.10.15	2018.10.14



## RF Connected Test

Kind of Equipment	Manufacturer	Type No.	Serial No.	Last calibration	Calibrated until
USB RF power sensor	DARE	RPR3006W	15I00041SNO03	2017.10.15	2018.10.14
Power Meter	R&S	NRP	100510	2017.10.15	2018.10.14
Spectrum Analyzer	Agilent	N9020A	MY51110105	2018.03.08	2019.03.07
Signal Analyzer	Agilent	N9020A	MY49100060	2017.10.15	2018.10.14

## Note:

The temporary antenna connector is soldered on the PCB board in order to perform conducted tests and this temporary antenna connector is listed in the equipment list.





### 3 EMC EMISSION TEST

#### 3.1 CONDUCTED EMISSION MEASUREMENT

##### 3.1.1 POWER LINE CONDUCTED EMISSION LIMITS

operating frequency band. In case the emission fall within the restricted band specified on Part 15.207(a), 107(a) limit in the table below has to be followed.

This item was performed according to the procedures in ANSI C63.10: 2013 and ANSI C63.4: 2014.

FREQUENCY (MHz)	Conducted Emission limit (dBuV)	
	Quasi-peak	Average
0.15 -0.5	66 - 56 *	56 - 46 *
0.50 -5.0	56.00	46.00
5.0 -30.0	60.00	50.00

Note:

- 1) The tighter limit applies at the band edges.
- 2) The limit of " \* " marked band means the limitation decreases linearly with the logarithm of the frequency in the range.

The following table is the setting of the receiver

Receiver Parameters	Setting
Attenuation	10 dB
Start Frequency	0.15 MHz
Stop Frequency	30 MHz
IF Bandwidth	9 kHz

### 3.1.2 TEST PROCEDURE

- a. The EUT was 0.8 meters from the horizontal ground plane and 0.4 meters from the vertical ground plane with EUT being connected to the power mains through a line impedance stabilization network (LISN). All other support equipments powered from additional LISN(s). The LISN provide 50 Ohm/ 50uH of coupling impedance for the measuring instrument.
- b. Interconnecting cables that hang closer than 40 cm to the ground plane shall be folded back and forth in the center forming a bundle 30 to 40 cm long.
- c. I/O cables that are not connected to a peripheral shall be bundled in the center. The end of the cable may be terminated, if required, using the correct terminating impedance. The overall length shall not exceed 1 m.
- d. LISN at least 80 cm from nearest part of EUT chassis.
- e. For the actual test configuration, please refer to the related Item –EUT Test Photos.

### 3.1.3 TEST SETUP

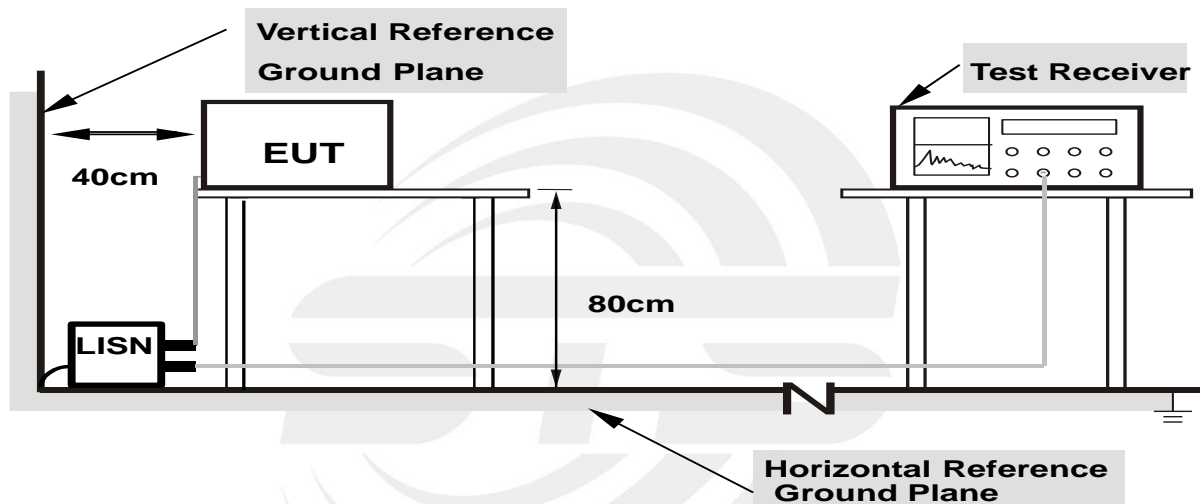

- Note: 1.Support units were connected to second LISN.**  
**2.Both of LISNs (AMN) are 80 cm from EUT and at least 80 from other units and other metal planes**

### 3.1.4 EUT OPERATING CONDITIONS

The EUT was configured for testing in a typical fashion (as a customer would normally use it). The EUT has been programmed to continuously transmit during test. This operating condition was tested and used to collect the included data.





3.1.5 TEST RESULT

Temperature:	25 °C	Relative Humidity:	61%
Test Voltage:	AC 120V/60Hz	Phase:	L
Test Mode:	Mode 10		

Frequency (MHz)	Reading (dBUV)	Correct Factor(dB)	Result (dBUV)	Limit (dBUV)	Margin (dB)	Remark
0.1500	23.78	9.75	33.53	66.00	-32.47	QP
0.1500	7.30	9.75	17.05	56.00	-38.95	AVG
0.4020	23.59	10.06	33.65	57.81	-24.16	QP
0.4020	10.22	10.06	20.28	47.81	-27.53	AVG
0.4940	25.80	9.98	35.78	56.10	-20.32	QP
0.4940	16.40	9.98	26.38	46.10	-19.72	AVG
1.7780	25.89	9.85	35.74	56.00	-20.26	QP
1.7780	9.90	9.85	19.75	46.00	-26.25	AVG
16.1660	34.33	10.16	44.49	60.00	-15.51	QP
16.1660	23.78	10.16	33.94	50.00	-16.06	AVG
23.1300	35.02	10.35	45.37	60.00	-14.63	QP
23.1300	26.41	10.35	36.76	50.00	-13.24	AVG

Remark:

1. All readings are Quasi-Peak and Average values.
2. Margin = Result (Result =Reading + Factor )–Limit

100.0 dBUV

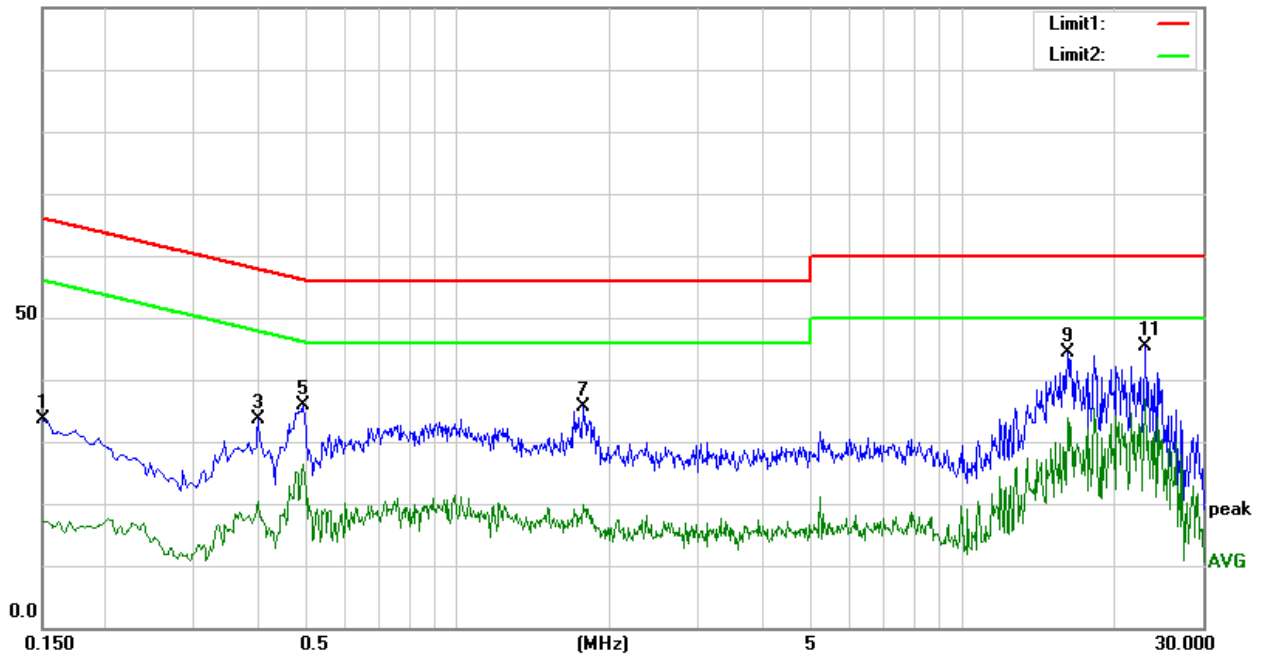



Temperature:	25 °C	Relative Humidity:	61%
Test Voltage:	AC 120V/60Hz	Phase:	N
Test Mode:	Mode 10		

Frequency (MHz)	Reading (dBUV)	Correct Factor(dB)	Result (dBUV)	Limit (dBUV)	Margin (dB)	Remark
0.1500	24.49	9.79	34.28	66.00	-31.72	QP
0.1500	11.14	9.79	20.93	56.00	-35.07	AVG
0.3860	20.03	10.06	30.09	58.15	-28.06	QP
0.3870	14.53	10.06	24.59	48.13	-23.54	AVG
0.4940	27.99	10.03	38.02	56.10	-18.08	QP
0.4940	23.70	10.03	33.73	46.10	-12.37	AVG
0.9980	20.99	9.80	30.79	56.00	-25.21	QP
0.9980	13.36	9.80	23.16	46.00	-22.84	AVG
16.2300	32.80	10.29	43.09	60.00	-16.91	QP
16.2300	20.32	10.29	30.61	50.00	-19.39	AVG
23.1300	33.75	10.27	44.02	60.00	-15.98	QP
23.1300	26.09	10.27	36.36	50.00	-13.64	AVG

Remark:

1. All readings are Quasi-Peak and Average values.
2. Margin = Result (Result = Reading + Factor) – Limit

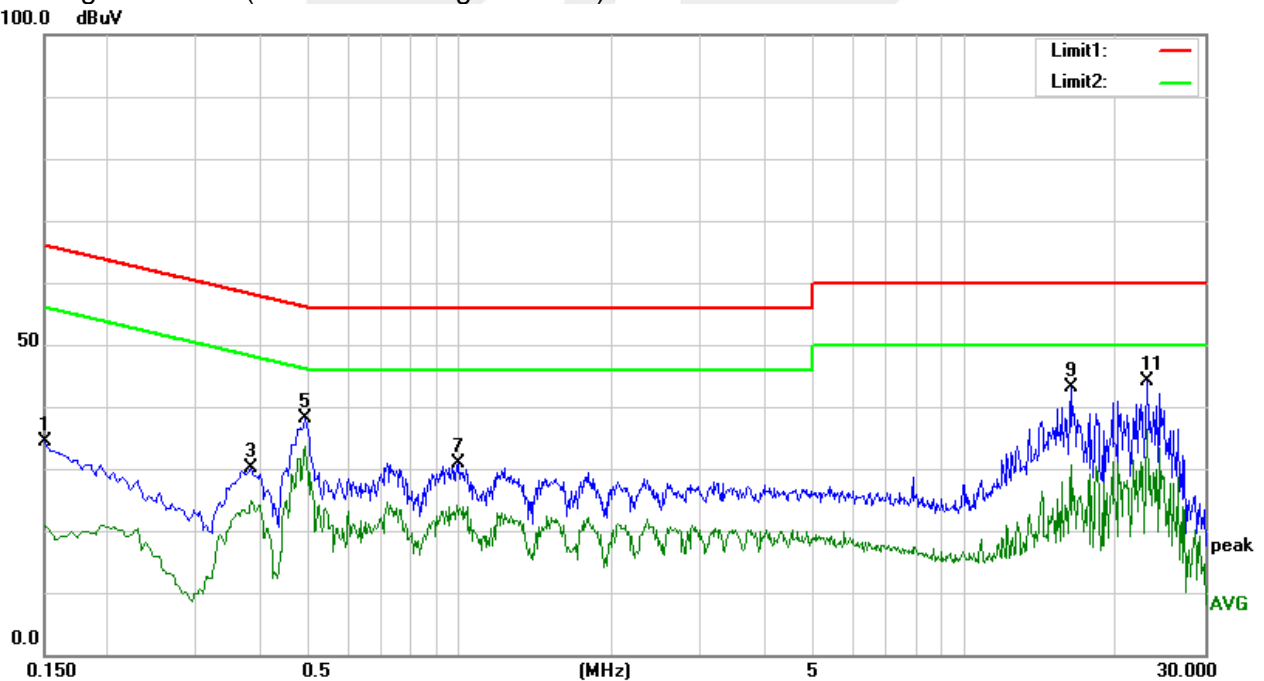



Temperature:	25 °C	Relative Humidity:	61%
Test Voltage:	AC 120V/60Hz	Phase:	N
Test Mode:	Mode 11 (Part 15B)		

Frequency (MHz)	Reading (dBUV)	Correct Factor(dB)	Result (dBUV)	Limit (dBUV)	Margin (dB)	Remark
0.1860	22.23	9.78	32.01	64.21	-32.20	QP
0.1864	6.45	9.78	16.23	54.20	-37.97	AVG
0.4820	23.96	10.03	33.99	56.30	-22.31	QP
0.4820	15.42	10.03	25.45	46.30	-20.85	AVG
0.9420	10.91	9.81	20.72	46.00	-25.28	QP
0.9460	23.06	9.81	32.87	56.00	-23.13	AVG
1.7820	24.70	9.78	34.48	56.00	-21.52	QP
1.8060	8.01	9.78	17.79	46.00	-28.21	AVG
16.1660	35.87	10.28	46.15	60.00	-13.85	QP
16.1660	25.88	10.28	36.16	50.00	-13.84	AVG
23.1300	33.67	10.27	43.94	60.00	-16.06	QP
23.1300	26.47	10.27	36.74	50.00	-13.26	AVG

Remark:

1. All readings are Quasi-Peak and Average values.
2. Margin = Result (Result = Reading + Factor) – Limit

100.0 dBUV

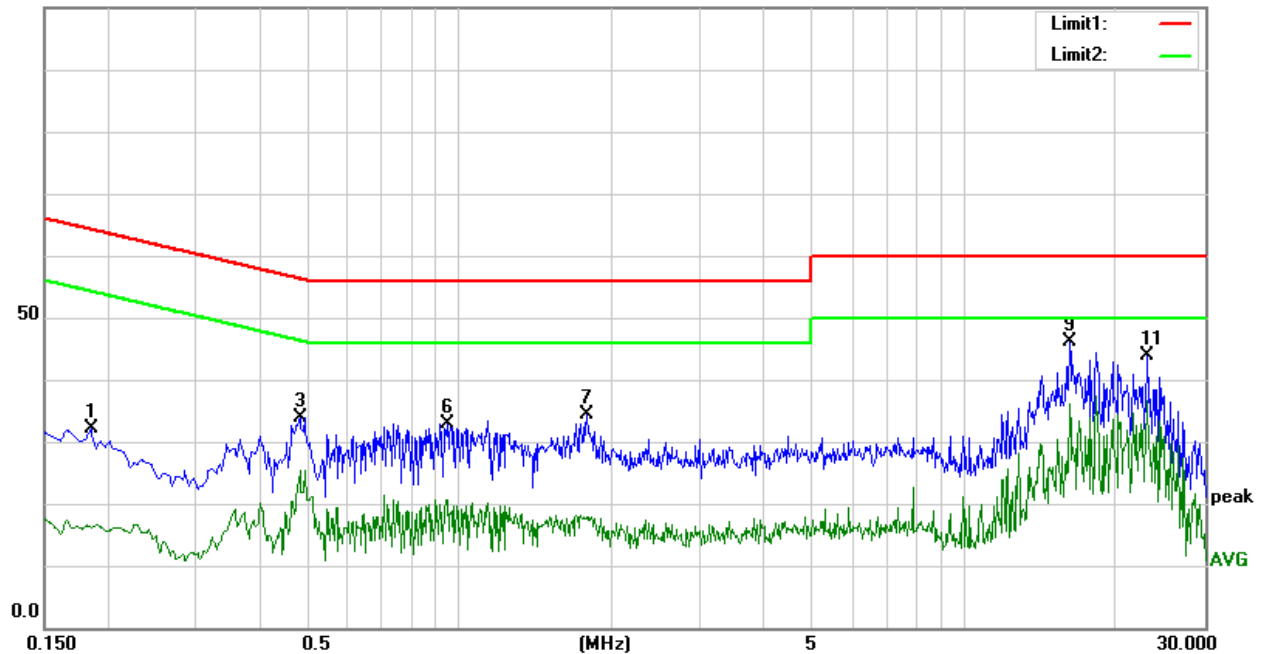



Temperature:	25 °C	Relative Humidity:	61%
Test Voltage:	AC 120V/60Hz	Phase:	L
Test Mode:	Mode 11 (Part 15B)		

Frequency (MHz)	Reading (dBUV)	Correct Factor(dB)	Result (dBUV)	Limit (dBUV)	Margin (dB)	Remark
0.1500	23.87	9.79	33.66	66.00	-32.34	QP
0.1500	9.84	9.79	19.63	56.00	-36.37	AVG
0.4940	27.60	10.03	37.63	56.10	-18.47	QP
0.4940	23.77	10.03	33.80	46.10	-12.30	AVG
0.7100	20.46	9.84	30.30	56.00	-25.70	QP
0.7140	12.89	9.84	22.73	46.00	-23.27	AVG
1.0180	20.61	9.80	30.41	56.00	-25.59	QP
1.0180	13.71	9.80	23.51	46.00	-22.49	AVG
16.2300	33.34	10.29	43.63	60.00	-16.37	QP
16.2300	20.43	10.29	30.72	50.00	-19.28	AVG
23.1300	32.91	10.27	43.18	60.00	-16.82	QP
23.1300	26.61	10.27	36.88	50.00	-13.12	AVG

Remark:

1. All readings are Quasi-Peak and Average values.
2. Margin = Result (Result = Reading + Factor) - Limit

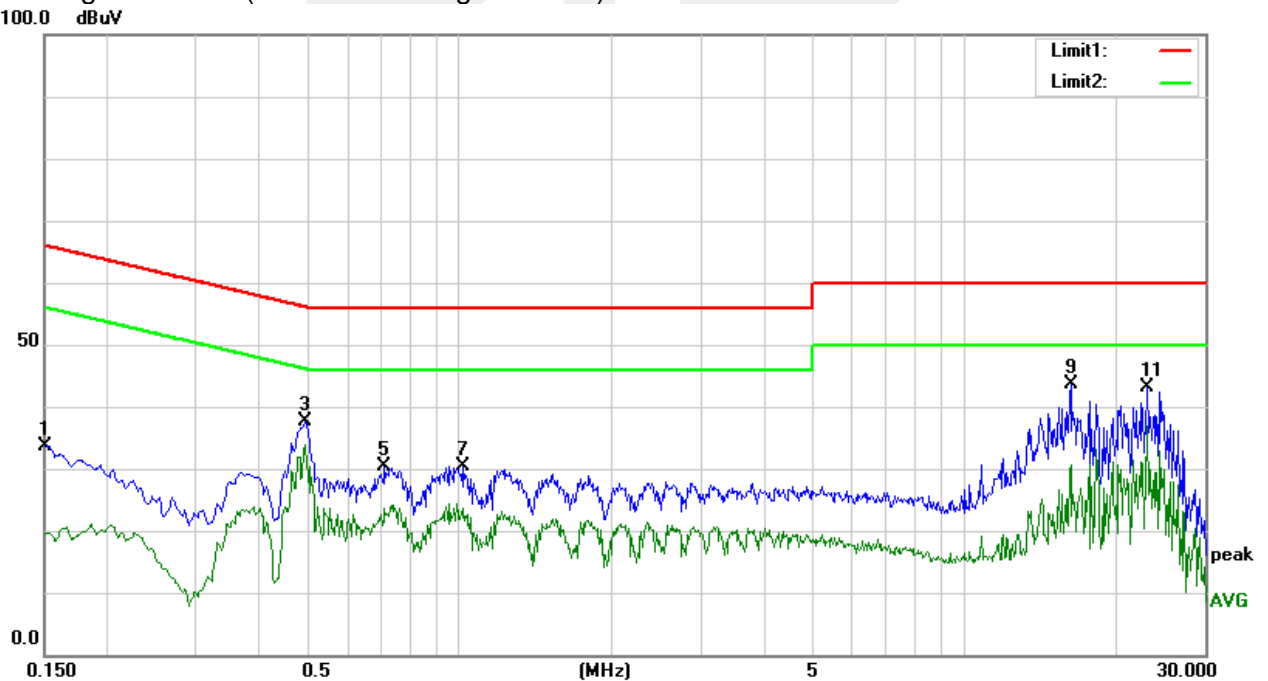



Temperature:	25 °C	Relative Humidity:	61%
Test Voltage:	AC 120V/60Hz	Phase:	N
Test Mode:	Mode 12 (Part 15B)		

Frequency (MHz)	Reading (dBUV)	Correct Factor(dB)	Result (dBUV)	Limit (dBUV)	Margin (dB)	Remark
0.1660	22.18	9.79	31.97	65.16	-33.19	QP
0.1660	6.23	9.79	16.02	55.16	-39.14	AVG
0.4860	23.90	10.03	33.93	56.24	-22.31	QP
0.4940	14.95	10.03	24.98	46.10	-21.12	AVG
1.0060	23.21	9.80	33.01	56.00	-22.99	QP
1.0060	10.86	9.80	20.66	46.00	-25.34	AVG
1.7060	23.06	9.79	32.85	56.00	-23.15	QP
1.7060	7.00	9.79	16.79	46.00	-29.21	AVG
17.6940	34.11	10.35	44.46	60.00	-15.54	QP
17.6940	26.43	10.35	36.78	50.00	-13.22	AVG
23.1300	34.24	10.27	44.51	60.00	-15.49	QP
23.1300	26.98	10.27	37.25	50.00	-12.75	AVG

Remark:

1. All readings are Quasi-Peak and Average values.
2. Margin = Result (Result = Reading + Factor) – Limit

100.0 dBUV

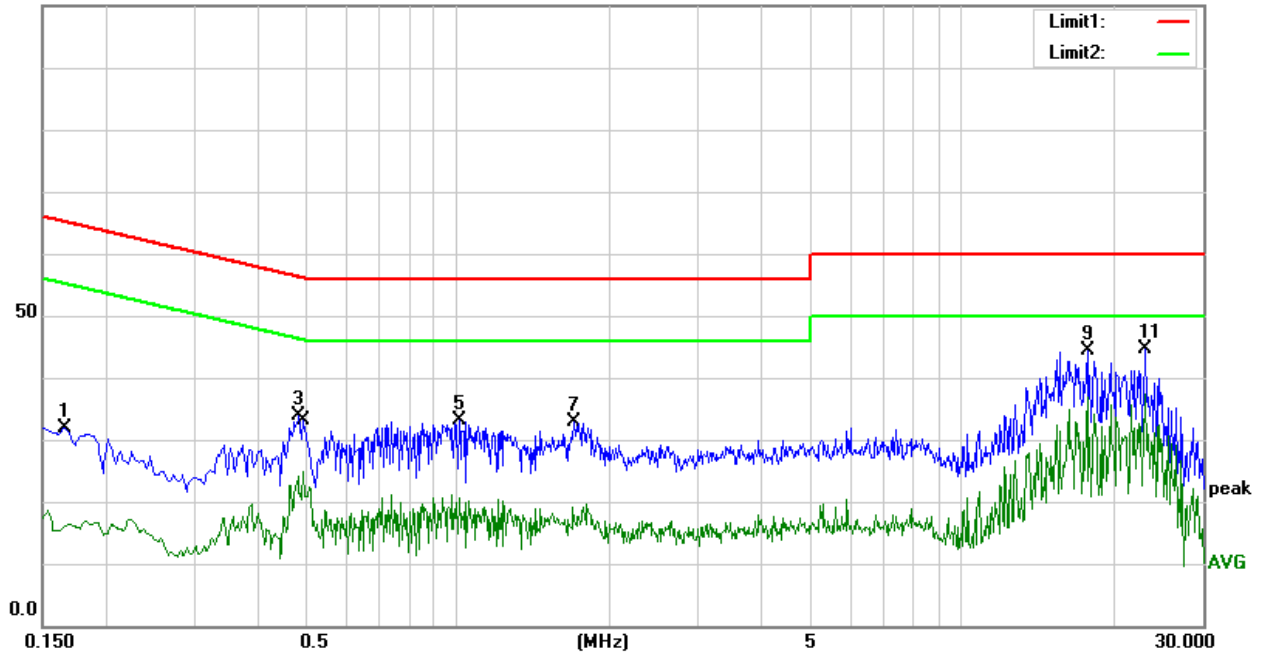



Temperature:	25 °C	Relative Humidity:	61%
Test Voltage:	AC 120V/60Hz	Phase:	L
Test Mode:	Mode 12 (Part 15B)		

Frequency (MHz)	Reading (dBUV)	Correct Factor(dB)	Result (dBUV)	Limit (dBUV)	Margin (dB)	Remark
0.1685	22.27	9.79	32.06	65.03	-32.97	QP
0.1685	9.97	9.79	19.76	55.03	-35.27	AVG
0.4940	27.04	10.03	37.07	56.10	-19.03	QP
0.4940	23.74	10.03	33.77	46.10	-12.33	AVG
0.9860	21.20	9.80	31.00	56.00	-25.00	QP
0.9980	15.03	9.80	24.83	46.00	-21.17	AVG
1.7820	20.63	9.78	30.41	56.00	-25.59	QP
1.7820	11.95	9.78	21.73	46.00	-24.27	AVG
16.2300	34.02	10.29	44.31	60.00	-15.69	QP
16.2300	20.25	10.29	30.54	50.00	-19.46	AVG
23.1300	34.78	10.27	45.05	60.00	-14.95	QP
23.1300	25.99	10.27	36.26	50.00	-13.74	AVG

Remark:

1. All readings are Quasi-Peak and Average values.
2. Margin = Result (Result = Reading + Factor) - Limit

100.0 dBUV

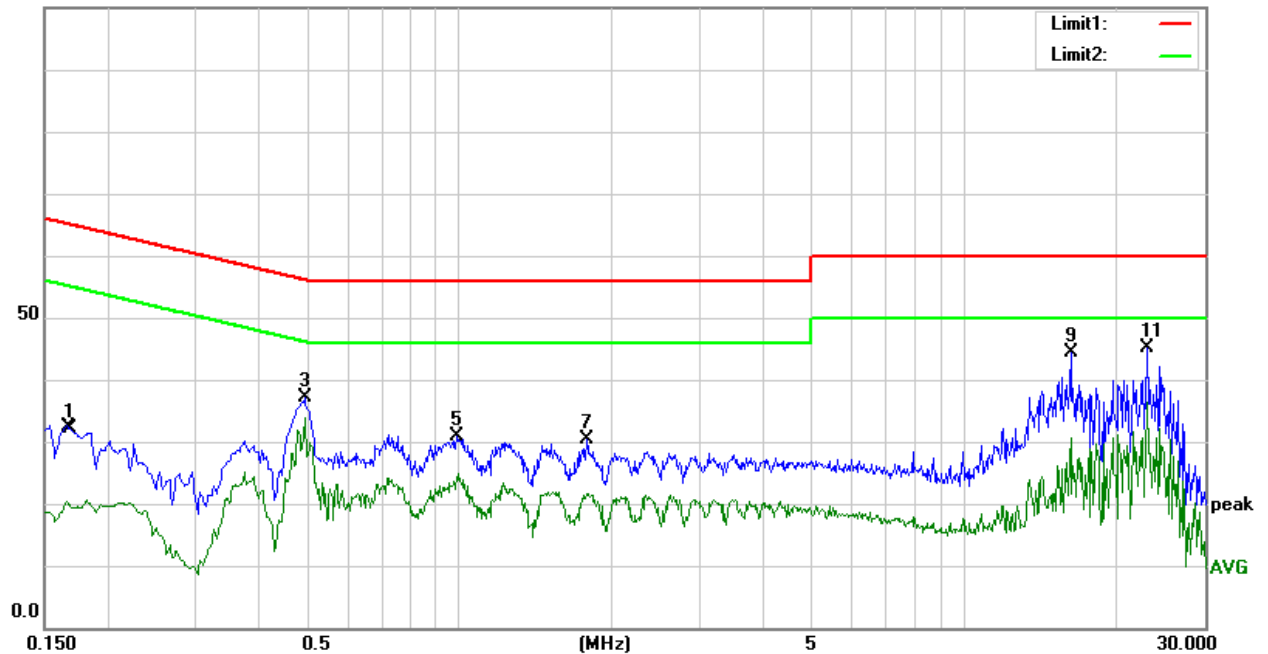



## 3.2 RADIATED EMISSION MEASUREMENT

### 3.2.1 RADIATED EMISSION LIMITS

Frequencies (MHz)	Class A (at 10m) dBuV/m	Class B (at 3m) dBuV/m
30~88	39.0	40.0
88~216	43.5	43.5
216~960	46.5	46.0
Above 960	49.5	54.0

#### LIMITS OF RADIATED EMISSION MEASUREMENT (Above 1000MHz)

FREQUENCY (MHz)	Class A (dBuV/m) (at 3M)		Class B (dBuV/m) (at 3M)	
	PEAK	AVERAGE	PEAK	AVERAGE
Above 1000	80	60	74	54

Note:

- 1) The tighter limit applies at the band edges.
- 2) Emission level (dBuV/m)=20log Emission level (uV/m).

### 3.2.2 TEST PROCEDURE

- a) The measuring distance of at 3 m shall be used for measurements at frequency up to 1GHz. For frequencies above 1GHz, any suitable measuring distance may be used.
- b) The EUT was placed on the top of a rotating table 0.8 meters above the ground at a 3 meter open area test site. The table was rotated 360 degrees to determine the position of the highest radiation.
- c) The height of the equipment or of the substitution antenna shall be 0.8 m; the height of the test antenna shall vary between 0.8 m to 4 m. Both horizontal and vertical polarizations of the antenna are set to make the measurement.
- d) The initial step in collecting conducted emission data is a spectrum analyzer peak detector mode pre-scanning the measurement frequency range. Significant peaks are then marked and then Quasi Peak detector mode re-measured.
- e) If the Peak Mode measured value compliance with and lower than Quasi Peak Mode Limit, the EUT shall be deemed to meet QP Limits and then no additional QP Mode measurement performed.
- f) For the actual test configuration, please refer to the related Item –EUT Test Photos.

*Note: Both horizontal and vertical antenna polarities were tested and performed pretest to three orthogonal axis. The worst case emissions were reported*

### 3.2.3 TEST SETUP

#### a) Radiated Emission Test-Up Frequency 30MHz~1GHz

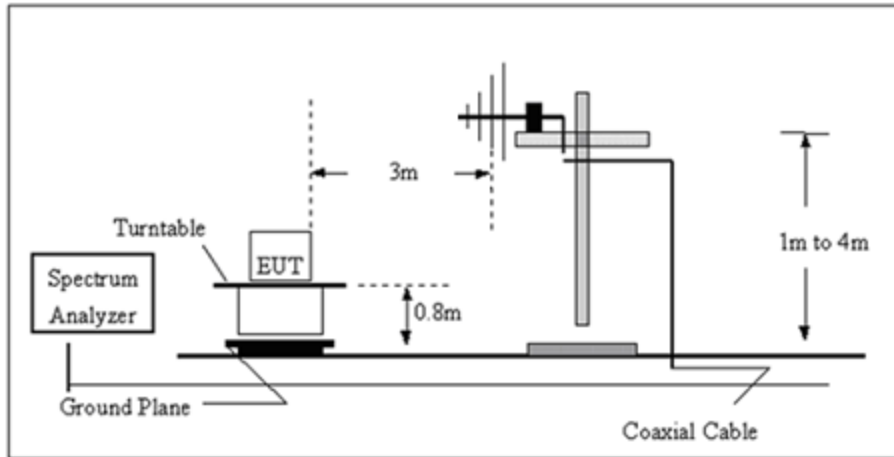

#### b) Radiated Emission Test-Up Frequency Above 1GHz

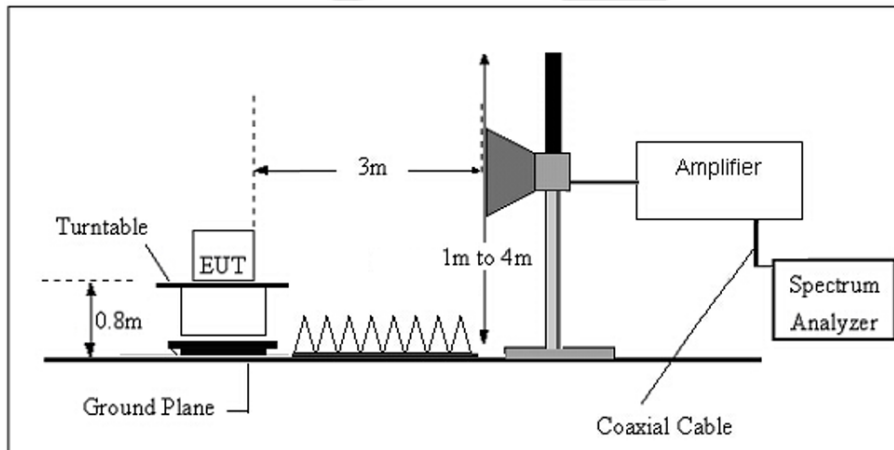

### 3.2.4 EUT OPERATING CONDITIONS

The EUT tested system was configured as the statements of 2.4 Unless otherwise a special operating condition is specified in the follows during the testing.





### 3.2.5 TEST RESULTS

Between 30-1000MHz:

Temperature:	26 °C	Relative Humidity:	54%
Pressure:	1010hPa	Phase:	Horizontal
Test Voltage:	AC 120V/60Hz	Test Mode:	Mode 11 (part 15B)

No.	Frequency (MHz)	Reading (dBUV)	Factor (dB)	Results (dBUV/m)	Limit (dBUV/m)	Margin (dB)	Detector
1	59.0251	56.38	-24.06	32.32	40.00	-7.68	QP
2	106.7587	53.32	-18.61	34.71	43.50	-8.79	QP
3	143.3261	47.95	-17.67	30.28	43.50	-13.22	QP
4	432.5457	49.33	-10.89	38.44	46.00	-7.56	QP
5	815.9678	44.01	-3.51	40.50	46.00	-5.50	QP
6	912.8620	43.95	-1.82	42.13	46.00	-3.87	QP

**Remark:**

1. All readings are Quasi-Peak .
2. Margin = Result (Result =Reading + Factor )-Limit

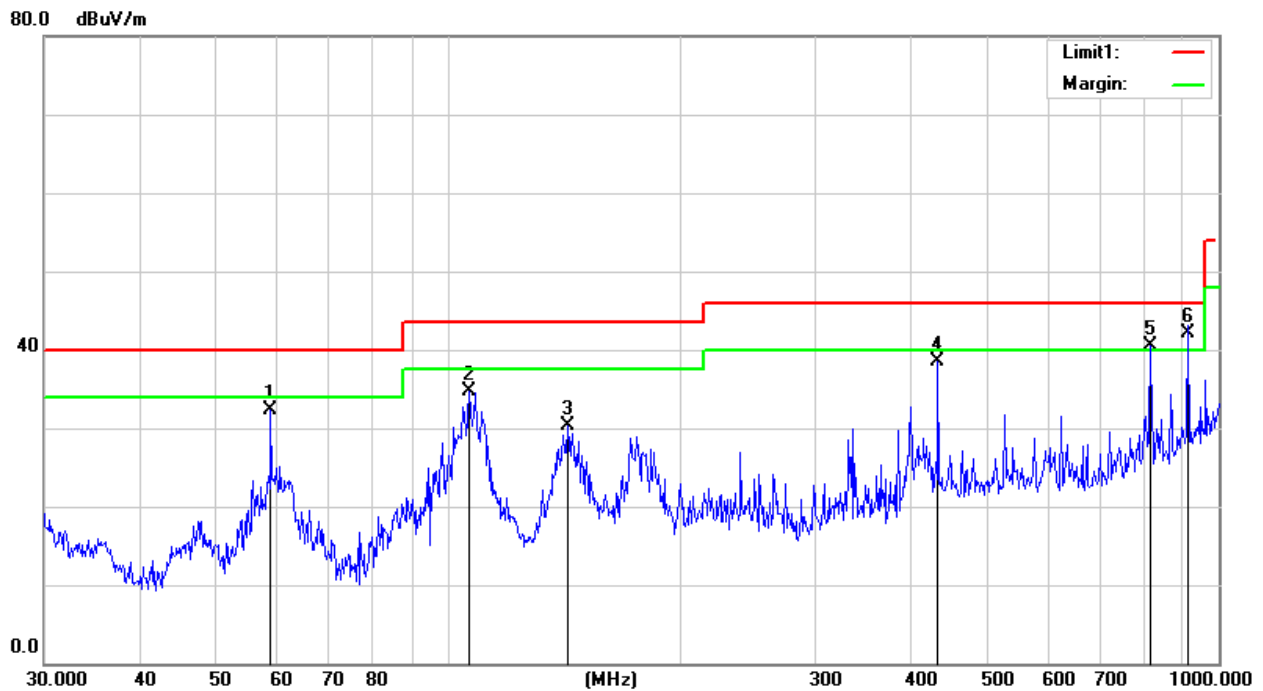



Temperature:	26 °C	Relative Humidity:	54%
Pressure:	1010hPa	Phase:	Vertical
Test Voltage:	AC 120V/60Hz	Test Mode:	Mode 11 (part 15B)

No.	Frequency (MHz)	Reading (dBuV)	Factor (dB)	Results (dBuV/m)	Limit (dBuV/m)	Margin (dB)	Detector
1	30.5306	47.67	-11.47	36.20	40.00	-3.80	QP
2	105.2718	55.52	-18.74	36.78	43.50	-6.72	QP
3	432.5457	53.13	-10.89	42.24	46.00	-3.76	QP
4	625.0780	47.64	-6.43	41.21	46.00	-4.79	QP
5	912.8620	44.39	-1.82	42.57	46.00	-3.43	QP
6	962.1623	45.36	-0.12	45.24	54.00	-8.76	QP

**Remark:**

1. All readings are Quasi-Peak .
2. Margin = Result (Result =Reading + Factor )-Limit

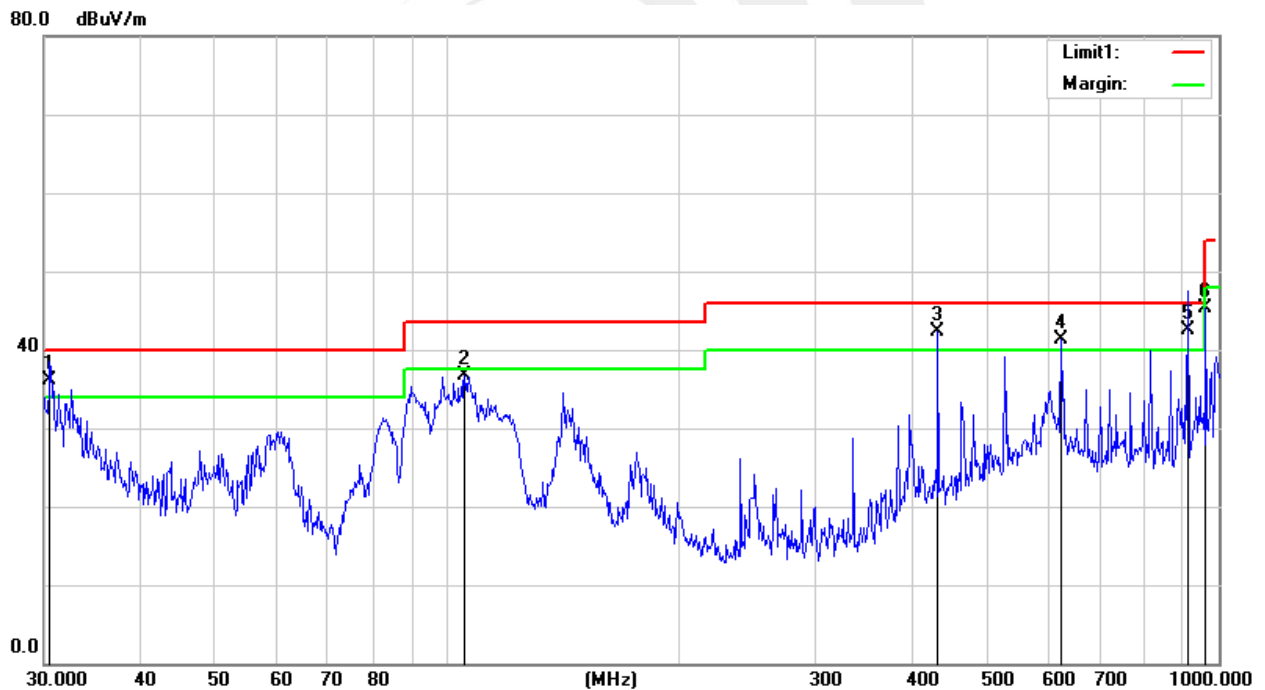



Temperature:	26 °C	Relative Humidity:	54%
Pressure:	1010hPa	Phase:	Horizontal
Test Voltage:	AC 120V/60Hz	Test Mode:	Mode 12 (part 15B)

No.	Frequency (MHz)	Reading (dBuV)	Factor (dB)	Results (dBuV/m)	Limit (dBuV/m)	Margin (dB)	Detector
1	30.6380	46.75	-11.52	35.23	40.00	-4.77	QP
2	104.5361	55.22	-18.81	36.41	43.50	-7.09	QP
3	141.3298	50.71	-17.58	33.13	43.50	-10.37	QP
4	432.5457	52.24	-10.89	41.35	46.00	-4.65	QP
5	625.0780	48.26	-6.43	41.83	46.00	-4.17	QP
6	912.8620	44.17	-1.82	42.35	46.00	-3.65	QP

**Remark:**

- All readings are Quasi-Peak .
- Margin = Result (Result =Reading + Factor )-Limit

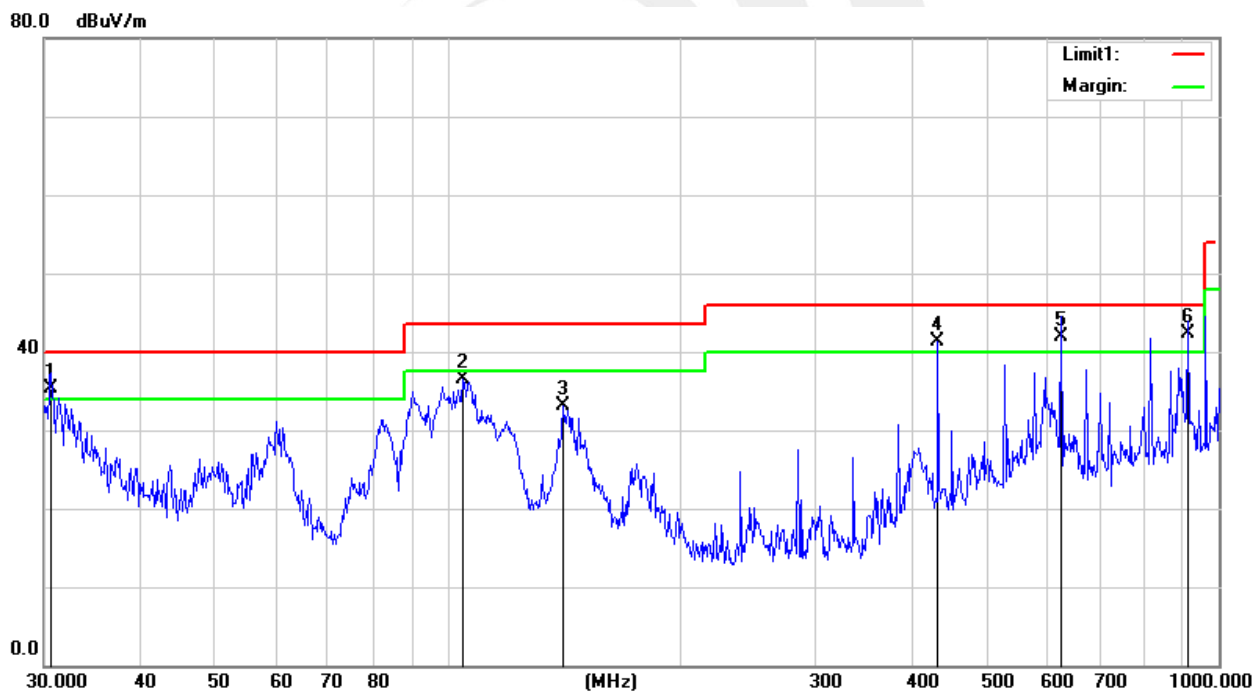



Temperature:	26 °C	Relative Humidity:	54%
Pressure:	1010hPa	Phase:	Vertical
Test Voltage:	AC 120V/60Hz	Test Mode:	Mode 12 (part 15B)

No.	Frequency (MHz)	Reading (dBuV)	Factor (dB)	Results (dBuV/m)	Limit (dBuV/m)	Margin (dB)	Detector
1	60.2801	48.57	-24.33	24.24	40.00	-15.76	QP
2	108.6470	53.23	-18.46	34.77	43.50	-8.73	QP
3	143.3261	48.57	-17.67	30.90	43.50	-12.60	QP
4	432.5457	49.55	-10.89	38.66	46.00	-7.34	QP
5	815.9678	42.41	-3.51	38.90	46.00	-7.10	QP
6	912.8620	44.10	-1.82	42.28	46.00	-3.72	QP

**Remark:**

1. All readings are Quasi-Peak .
2. Margin = Result (Result =Reading + Factor )-Limit

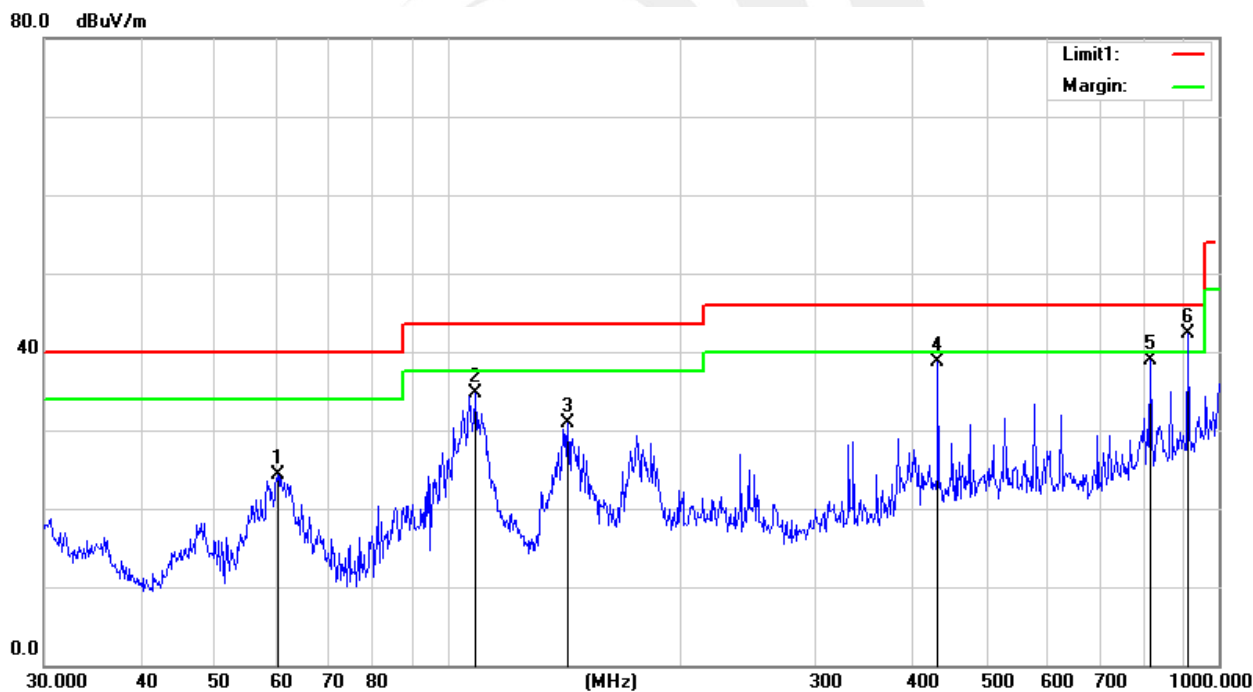



Between 1GHz-18GHz:

Temperature:	26 °C	Relative Humidity:	54%
Pressure:	1010hPa	Phase:	Horizontal
Test Voltage:	AC 120V/60Hz	Test Mode:	Mode 11 (part 15B)

No.	Frequency (MHz)	Reading (dBuV)	Factor (dB)	Results (dBuV/m)	Limit (dBuV/m)	Margin (dB)	Detector
1	13036.000	42.05	3.67	45.72	54.00	-8.28	AVG
2	13036.000	52.27	3.67	55.94	74.00	-18.06	peak
3	14209.000	42.39	4.12	46.51	54.00	-7.49	AVG
4	14209.000	52.60	4.12	56.72	74.00	-17.28	peak
5	17983.000	41.81	8.08	49.89	54.00	-4.11	AVG
6	17983.000	51.96	8.08	60.04	74.00	-13.96	peak

**Remark:**

1. Margin = Result (Result = Reading + Factor) - Limit

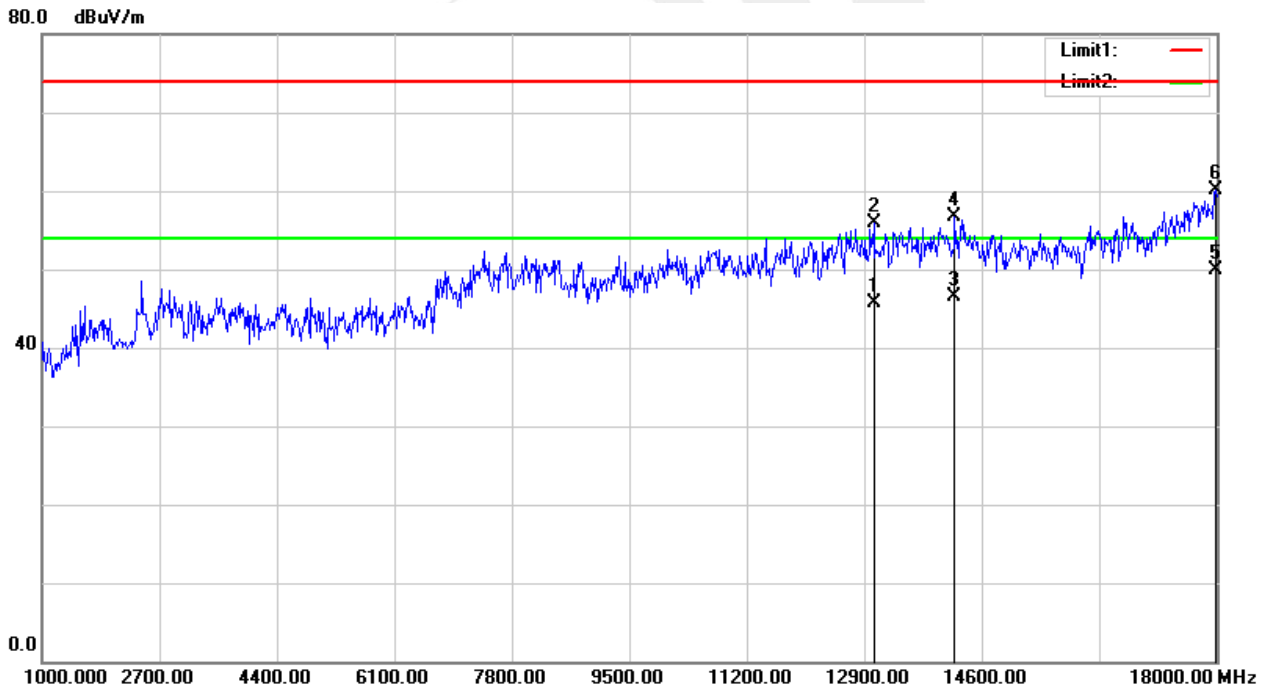



Temperature:	26 °C	Relative Humidity:	54%
Pressure:	1010hPa	Phase:	Vertical
Test Voltage:	AC 120V/60Hz	Test Mode:	Mode 11 (part 15B)

No.	Frequency (MHz)	Reading (dBUV)	Factor (dB)	Results (dBUV/m)	Limit (dBUV/m)	Margin (dB)	Detector
1	8004.000	42.61	-0.40	42.21	54.00	-11.79	AVG
2	8004.000	52.95	-0.40	52.55	74.00	-21.45	peak
3	13750.000	41.56	4.35	45.91	54.00	-8.09	AVG
4	13750.000	51.70	4.35	56.05	74.00	-17.95	peak
5	18000.000	42.06	8.13	50.19	54.00	-3.81	AVG
6	18000.000	52.35	8.13	60.48	74.00	-13.52	peak

Remark:

1. Margin = Result (Result = Reading + Factor) - Limit

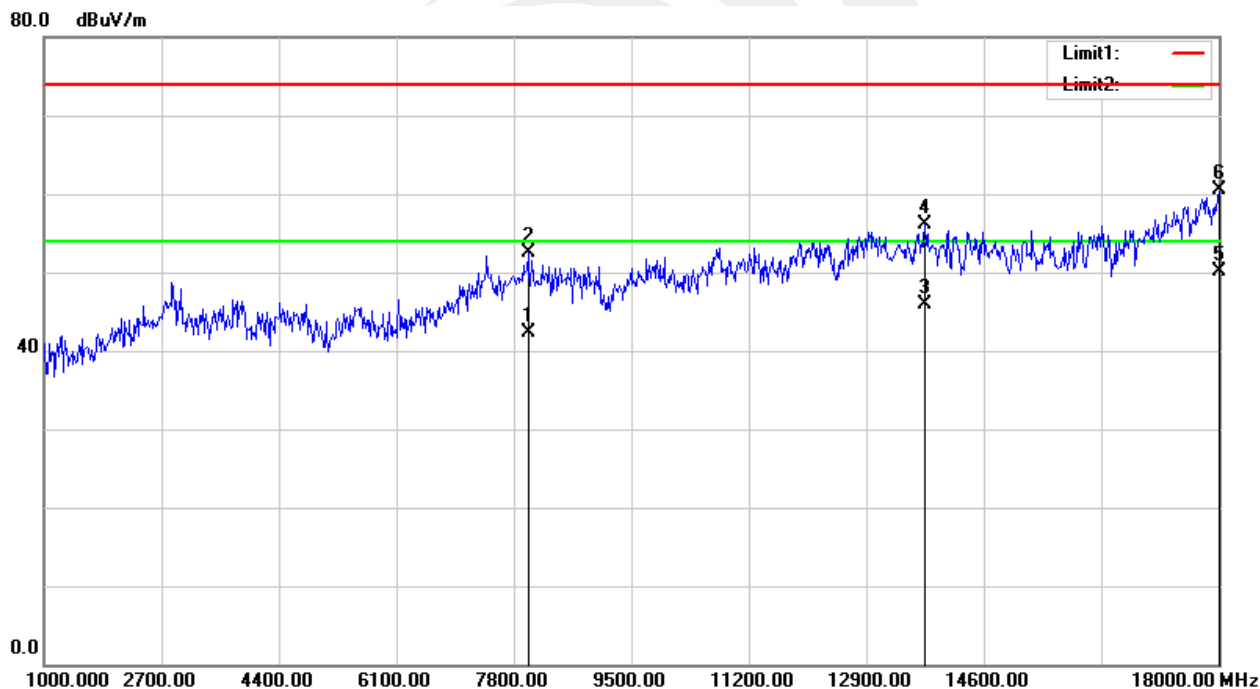



Temperature:	26 °C	Relative Humidity:	54%
Pressure:	1010hPa	Phase:	Horizontal
Test Voltage:	AC 120V/60Hz	Test Mode:	Mode 12 (part 15B)

No.	Frequency (MHz)	Reading (dBuV)	Factor (dB)	Results (dBuV/m)	Limit (dBuV/m)	Margin (dB)	Detector
1	12747.000	51.64	3.84	55.48	74.00	-18.52	AVG
2	12747.000	51.64	3.84	55.48	74.00	-18.52	peak
3	14328.000	51.45	4.62	56.07	74.00	-17.93	AVG
4	14328.000	51.45	4.62	56.07	74.00	-17.93	peak
5	17677.000	51.35	7.16	58.51	74.00	-15.49	AVG
6	17677.000	51.35	7.16	58.51	74.00	-15.49	peak

Remark:

1. Margin = Result (Result = Reading + Factor) - Limit

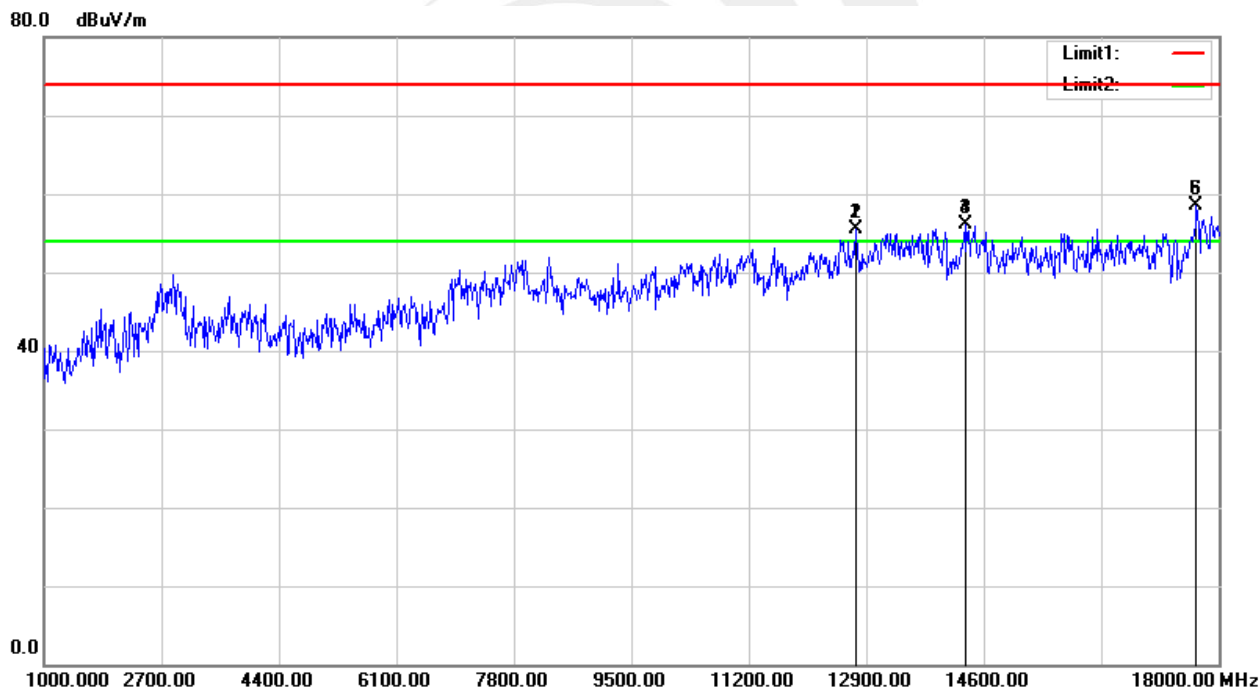



Temperature:	26 °C	Relative Humidity:	54%
Pressure:	1010hPa	Phase:	Vertical
Test Voltage:	AC 120V/60Hz	Test Mode:	Mode 12 (part 15B)

No.	Frequency (MHz)	Reading (dBuV)	Factor (dB)	Results (dBuV/m)	Limit (dBuV/m)	Margin (dB)	Detector
1	12084.000	41.97	2.54	44.51	54.00	-9.49	AVG
2	12084.000	52.29	2.54	54.83	74.00	-19.17	peak
3	14566.000	41.20	4.36	45.56	54.00	-8.44	AVG
4	14566.000	51.38	4.36	55.74	74.00	-18.26	peak
5	17677.000	41.94	7.16	49.10	54.00	-4.90	AVG
6	17677.000	52.21	7.16	59.37	74.00	-14.63	peak

**Remark:**

1. Margin = Result (Result = Reading + Factor) - Limit

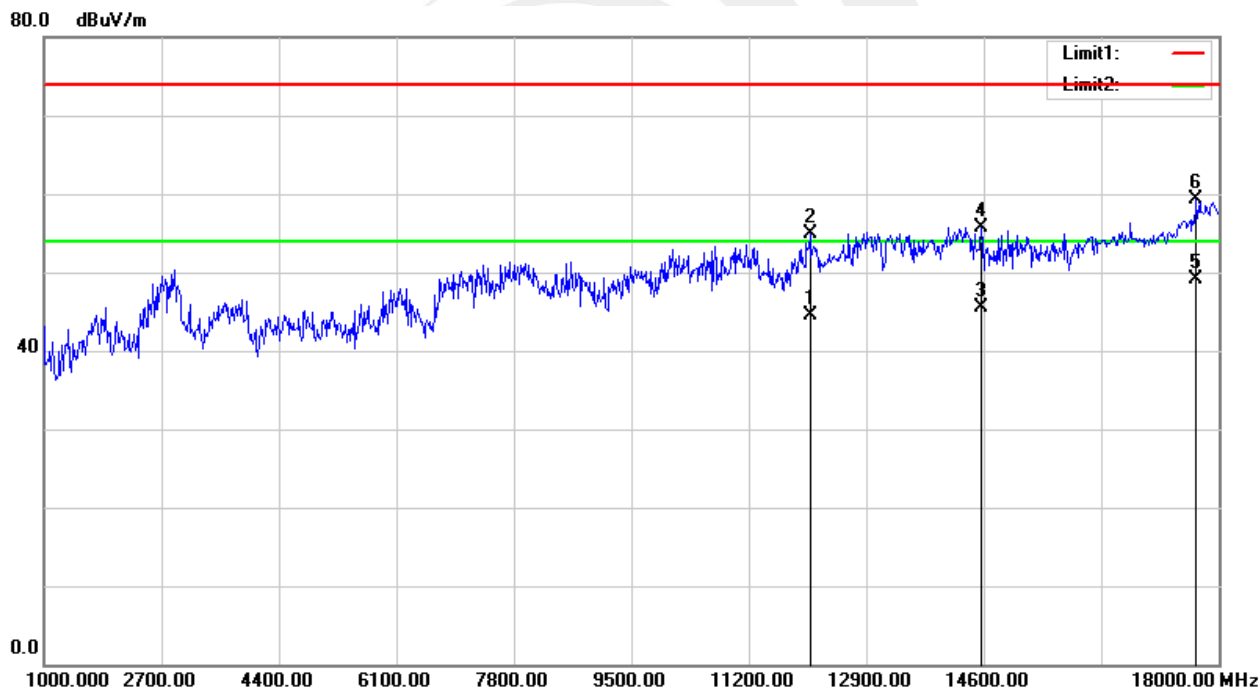





### 3.3 RADIATED SPURIOUS EMISSION MEASUREMENT

#### 3.3.1 RADIATED EMISSION LIMITS

in any 100 kHz bandwidth outside the operating frequency band. In case the emission fall within the Restricted band specified on Part15.205(a)&209(a) limit in the table and according to ANSI C63.10-2013 below has to be followed.

LIMITS OF RADIATED EMISSION MEASUREMENT (0.009MHz - 1000MHz)

Frequencies (MHz)	Field Strength (micorvolts/meter)	Measurement Distance (meters)
0.009~0.490	2400/F(KHz)	300
0.490~1.705	24000/F(KHz)	30
1.705~30.0	30	30
30~88	100	3
88~216	150	3
216~960	200	3
Above 960	500	3

LIMITS OF RADIATED EMISSION MEASUREMENT (1000MHz-25GHz)

FREQUENCY (MHz)	(dBuV/m) (at 3M)	
	PEAK	AVERAGE
Above 1000	74	54

Notes:

- (1) The limit for radiated test was performed according to FCC PART 15C.
- (2) The tighter limit applies at the band edges.
- (3) Emission level (dBuV/m)=20log Emission level (uV/m).

For Radiated Emission

Spectrum Parameter	Setting
Attenuation	Auto
Detector	Peak/AV
Start Frequency	1000 MHz(Peak/AV)
Stop Frequency	10th carrier hamonic(Peak/AV)
RB / VB (emission in restricted band)	1 MHz /3MHz

For Band edge

Spectrum Parameter	Setting
Detector	Peak/AV
Start/Stop Frequency	Lower Band Edge: 2300 to 2422 MHz Upper Band Edge: 2452 to 2500 MHz
RB / VB (emission in restricted band)	1 MHz /3MHz



Receiver Parameter	Setting
Start ~ Stop Frequency	9kHz~90kHz / RB 200Hz for PK & AV
Start ~ Stop Frequency	90kHz~110kHz / RB 200Hz for QP
Start ~ Stop Frequency	110kHz~490kHz / RB 200Hz for PK & AV
Start ~ Stop Frequency	490kHz~30MHz / RB 9kHz for QP
Start ~ Stop Frequency	30MHz~1000MHz / RB 120kHz for QP

### 3.3.2 TEST PROCEDURE

- The measuring distance of at 3 m shall be used for measurements at frequency 0.009MHz up to 1GHz. For frequencies above 1GHz, any suitable measuring distance may be used.
- The EUT was placed on the top of a rotating table 0.8 meters(above 1GHz is 1.5 m) above the ground at a 3 meter anechoic chamber. The table was rotated 360 degrees to determine the position of the highest radiation.
- The height of the equipment shall be 0.8 m(above 1GHz is 1.5 m); the height of the test antenna shall vary between 1 m to 4 m. Horizontal and vertical polarizations of the antenna are set to make the measurement
- The initial step in collecting conducted emission data is a spectrum analyzer peak detector mode pre-scanning the measurement frequency range. Significant peaks are then marked and then Quasi Peak detector mode re-measured.
- If the Peak Mode measured value compliance with and lower than Quasi Peak Mode Limit, the EUT shall be deemed to meet QP Limits and then no additional QP Mode measurement performed.
- For the actual test configuration, please refer to the related Item –EUT Test Photos.

Note:

*Both horizontal and vertical antenna polarities were tested and performed test to three orthogonal axis. The worst case emissions were reported*

### 3.3.3 TEST SETUP

#### a) Radiated Emission Test-Up Frequency Below 30MHz

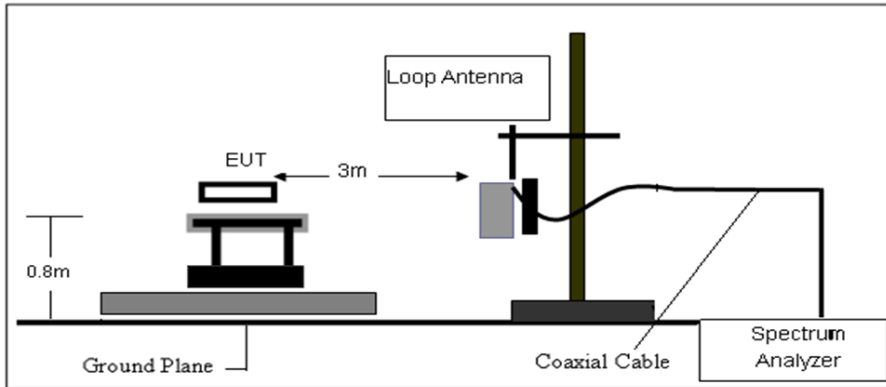

#### b) Radiated Emission Test-Up Frequency 30MHz~1GHz

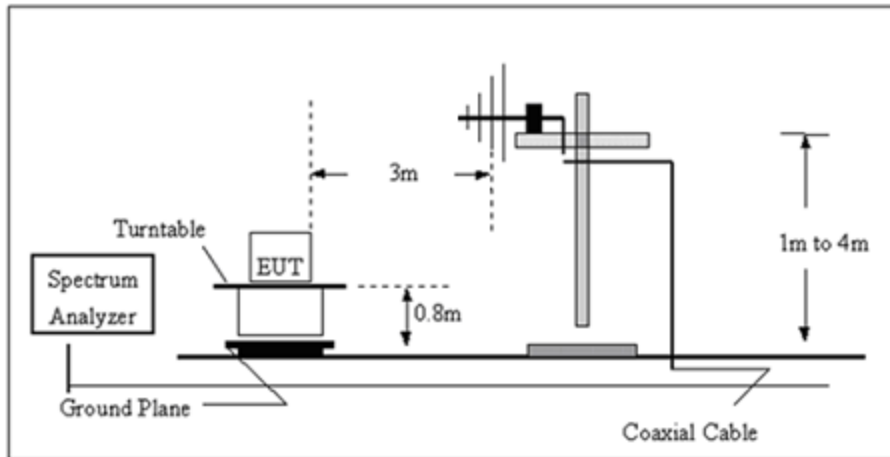

#### c) Radiated Emission Test-Up Frequency Above 1GHz

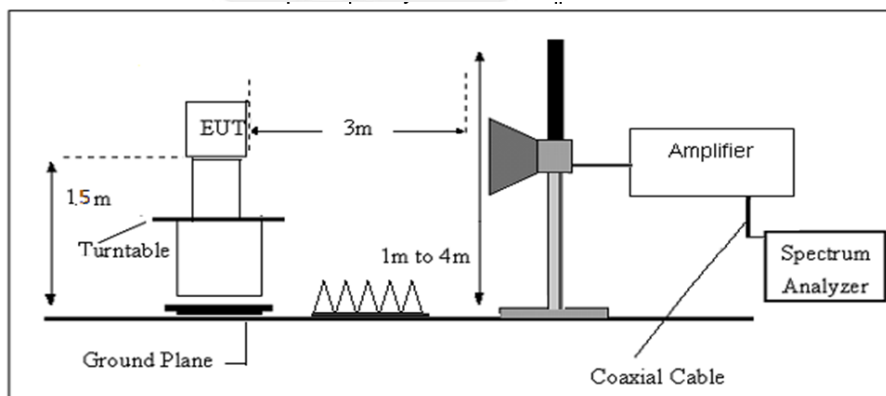

### 3.3.4 EUT OPERATING CONDITIONS

The EUT tested system was configured as the statements of 2.3 Unless otherwise a special operating condition is specified in the follows during the testing.



### 3.3.5 FIELD STRENGTH CALCULATION

The field strength is calculated by adding the Antenna Factor and Cable Factor and subtracting the Amplifier Gain and Duty Cycle Correction Factor (if any) from the measured reading. The basic equation with a sample calculation is as follows:

$$FS = RA + AF + CL - AG$$

Where

FS = Field Strength

CL = Cable Attenuation Factor (Cable Loss)

RA = Reading Amplitude

AG = Amplifier Gain

AF = Antenna Factor

For example

Frequency	FS	RA	AF	CL	AG	Factor
(MHz)	(dB $\mu$ V/m)	(dB $\mu$ V/m)	(dB)	(dB)	(dB)	(dB)
300	40	58.1	12.2	1.6	31.9	-18.1

$$\text{Factor} = \text{AF} + \text{CL} - \text{AG}$$

### 3.3.6 TEST RESULT

9KHz-30MHz

Temperature:	25 °C	Relative Humidity:	61%
Test Voltage :	AC 120V/60Hz	Polarization :	--
Test Mode :	TX Mode		

Freq.	Reading	Limit	Margin	State	Test Result
(MHz)	(dB $\mu$ V/m)	(dB $\mu$ V/m)	(dB)	P/F	
--	--	--	--	--	PASS
--	--	--	--	--	PASS

Note:

The amplitude of spurious emissions which are attenuated by more than 20dB below the permissible value has no need to be reported.

Distance extrapolation factor = 40 log (specific distance/test distance)(dB);

Limit line = specific limits(dB $\mu$ v) + distance extrapolation factor.



(30MHz - 1000MHz)

Temperature:	25.7 °C	Relative Humidity:	63%
Test Voltage :	AC 120V/60Hz	Polarization :	Horizontal
Test Mode :	Mode 1/2/3/4/5/6/7/8/9(Mode 2-1Mbps worst mode)		

Frequency (MHz)	Reading (dBuV)	Correct Factor(dB/m)	Result (dBuV/m)	Limit (dBuV/m)	Margin (dB)	Remark
60.0691	48.48	-24.34	24.14	40.00	-15.86	QP
108.6470	54.22	-18.46	35.76	43.50	-7.74	QP
176.2686	49.26	-19.41	29.85	43.50	-13.65	QP
475.4991	43.50	-9.71	33.79	46.00	-12.21	QP
701.7610	41.02	-5.29	35.73	46.00	-10.27	QP
1000.0000	37.52	-0.07	37.45	54.00	-16.55	QP

Remark:

1. Margin = Result (Result =Reading + Factor )-Limit

80.0 dBuV/m

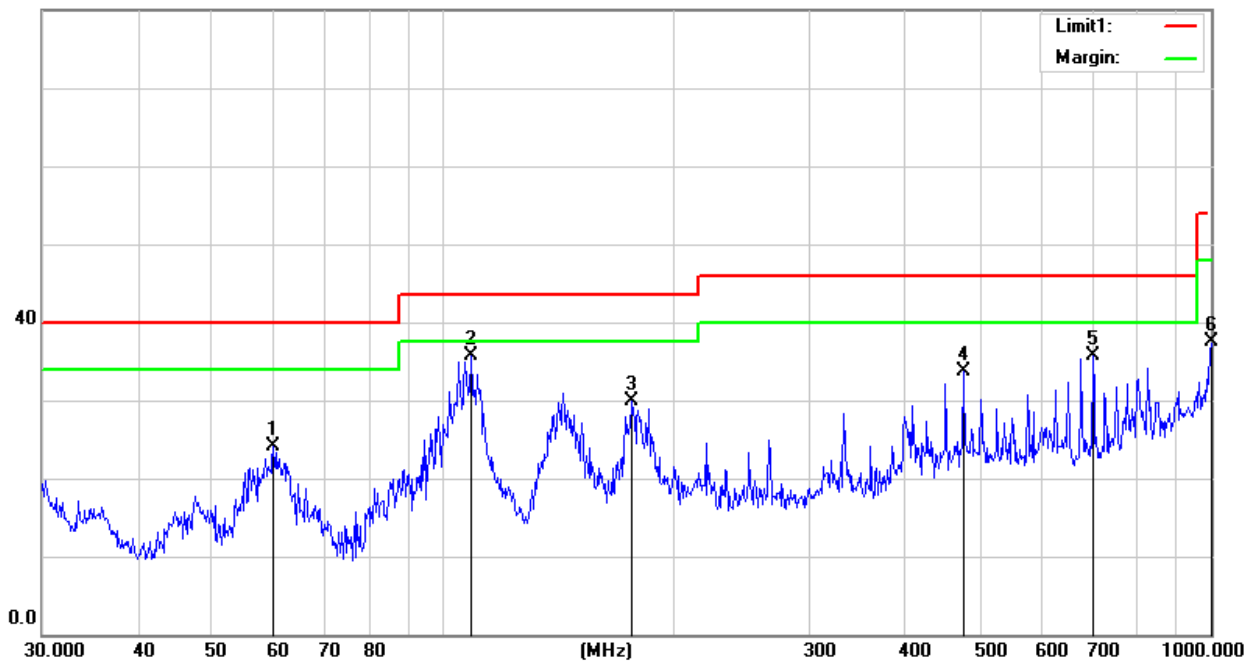



Temperature:	25.7 °C	Relative Humidity:	63%
Test Voltage :	AC 120V/60Hz	Polarization :	Vertical
Test Mode :	Mode 1/2/3/4/5/6/7/8/9(Mode 2-1Mbps worst mode)		

Frequency (MHz)	Reading (dBuV)	Correct Factor(dB/m)	Result (dBuV/m)	Limit (dBuV/m)	Margin (dB)	Remark
30.5306	47.69	-11.47	36.22	40.00	-3.78	QP
106.7587	54.73	-18.61	36.12	43.50	-7.38	QP
141.8262	50.25	-17.59	32.66	43.50	-10.84	QP
627.2738	41.82	-6.42	35.40	46.00	-10.60	QP
798.9797	38.57	-3.45	35.12	46.00	-10.88	QP
906.4824	39.00	-2.05	36.95	46.00	-9.05	QP

Remark:.

1. Margin = Result (Result =Reading + Factor )–Limit

80.0 dBuV/m





(1000MHz-25GHz) Restricted band and Spurious emission Requirements

**802.11b Low Channel**

Frequency (MHz)	Results (dBuV/m)	Factor (dB)	Limit (dBuV/m)	Margin (dB)	Detector	ANT	Verdict
3264.61	-9.80	38.68	74.00	-35.32	Peak	Vertical	Pass
3264.61	-9.80	28.40	54.00	-25.60	Average	Vertical	Pass
3264.75	-9.80	39.30	74.00	-34.70	Peak	Horizontal	Pass
3264.75	-9.80	28.38	54.00	-25.62	Average	Horizontal	Pass
4824.50	-3.56	55.01	74.00	-18.99	Peak	Vertical	Pass
4824.50	-3.56	35.42	54.00	-18.58	Average	Vertical	Pass
4824.34	-3.56	55.04	74.00	-18.96	Peak	Horizontal	Pass
4824.34	-3.56	35.92	54.00	-18.08	Average	Horizontal	Pass
5359.65	-2.34	43.17	74.00	-30.83	Peak	Vertical	Pass
5359.65	-2.34	36.07	54.00	-17.93	Average	Vertical	Pass
5359.65	-2.34	43.80	74.00	-30.20	Peak	Horizontal	Pass
5359.65	-2.34	35.41	54.00	-18.59	Average	Horizontal	Pass
7235.73	3.40	54.79	74.00	-19.21	Peak	Vertical	Pass
7235.73	3.40	36.45	54.00	-17.55	Average	Vertical	Pass
7235.91	3.40	54.04	74.00	-19.96	Peak	Horizontal	Pass
7235.70	3.40	35.01	54.00	-18.99	Average	Horizontal	Pass

**802.11b Mid Channel**

Frequency (MHz)	Results (dBuV/m)	Factor (dB)	Limit (dBuV/m)	Margin (dB)	Detector	ANT	Verdict
3264.72	-9.80	38.46	74.00	-35.54	Peak	Vertical	Pass
3264.72	-9.80	29.08	54.00	-24.92	Average	Vertical	Pass
3264.69	-9.80	38.64	74.00	-35.36	Peak	Horizontal	Pass
3264.69	-9.80	29.42	54.00	-24.58	Average	Horizontal	Pass
4874.39	-3.56	55.75	74.00	-18.25	Peak	Vertical	Pass
4874.39	-3.56	35.81	54.00	-18.19	Average	Vertical	Pass
4874.53	-3.56	56.06	74.00	-17.94	Peak	Horizontal	Pass
4874.53	-3.56	35.54	54.00	-18.46	Average	Horizontal	Pass
5359.61	-2.34	42.81	74.00	-31.19	Peak	Vertical	Pass
5359.61	-2.34	35.81	54.00	-18.19	Average	Vertical	Pass
5359.81	-2.34	43.43	74.00	-30.57	Peak	Horizontal	Pass
5359.81	-2.34	36.08	54.00	-17.92	Average	Horizontal	Pass
7310.75	3.40	54.44	74.00	-19.56	Peak	Vertical	Pass
7310.75	3.40	36.50	54.00	-17.50	Average	Vertical	Pass
7310.88	3.40	54.82	74.00	-19.18	Peak	Horizontal	Pass
7310.88	3.40	36.47	54.00	-17.53	Average	Horizontal	Pass



**802.11b High Channel**

Frequency (MHz)	Results (dBuV/m)	Factor (dB)	Limit (dBuV/m)	Margin (dB)	Detector	ANT	Verdict
3264.85	-9.80	39.39	74.00	-34.61	Peak	Vertical	Pass
3264.85	-9.80	28.22	54.00	-25.78	Average	Vertical	Pass
3264.65	-9.80	38.82	74.00	-35.18	Peak	Horizontal	Pass
3264.65	-9.80	28.60	54.00	-25.40	Average	Horizontal	Pass
4924.29	-3.56	55.16	74.00	-18.84	Peak	Vertical	Pass
4924.29	-3.56	34.56	54.00	-19.44	Average	Vertical	Pass
4924.39	-3.56	54.87	74.00	-19.13	Peak	Horizontal	Pass
4924.39	-3.56	35.06	54.00	-18.94	Average	Horizontal	Pass
5359.82	-2.34	42.66	74.00	-31.34	Peak	Vertical	Pass
5359.82	-2.34	35.59	54.00	-18.41	Average	Vertical	Pass
5359.69	-2.34	42.78	74.00	-31.22	Peak	Horizontal	Pass
5359.69	-2.34	35.76	54.00	-18.24	Average	Horizontal	Pass
7385.86	3.40	54.71	74.00	-19.29	Peak	Vertical	Pass
7385.86	3.40	36.09	54.00	-17.91	Average	Vertical	Pass
7385.95	3.40	54.73	74.00	-19.27	Peak	Horizontal	Pass
7385.95	3.40	36.23	54.00	-17.77	Average	Horizontal	Pass

## Remark:

- Factor = Antenna Factor + Cable Loss – Pre-amplifier.
- Scan with 802.11b, 802.11g, 802.11n (HT-20) the worst case is 802.11b.  
Emission Level = Reading + Factor  
Margin = Limit - Emission Level
- The frequency emission of peak points that did not show above the forms are at least 20dB below the limit, the frequency emission is mainly from the environment noise.



3.3.7 TEST RESULTS (BAND EDGE REQUIREMENTS)

Frequency (MHz)	Reading (dBμV)	Amplifier (dB)	Loss (dB)	Antenna	Corrected	Emission	Limits (dBμV/m)	Margin (dB)	Detector Type	Comment
				Factor (dB/m)	Factor (dB)	Level (dBμV/m)				
802.11b										
2390.00	67.88	43.80	4.91	25.90	-12.99	54.89	74.00	-19.11	Peak	Vertical
2390.00	53.97	43.80	4.91	25.90	-12.99	40.98	54.00	-13.02	Average	Vertical
2390.00	69.55	43.80	4.91	25.90	-12.99	56.56	74.00	-17.44	Peak	Horizontal
2390.00	52.37	43.80	4.91	25.90	-12.99	39.38	54.00	-14.62	Average	Horizontal
2483.50	69.63	43.80	5.12	25.90	-12.78	56.85	74.00	-17.15	Peak	Vertical
2483.50	53.47	43.80	5.12	25.90	-12.78	40.69	54.00	-13.31	Average	Vertical
2483.50	70.37	43.80	5.12	25.90	-12.78	57.59	74.00	-16.41	Peak	Horizontal
2483.50	52.83	43.80	5.12	25.90	-12.78	40.05	54.00	-13.95	Average	Horizontal
802.11g										
2390.00	66.17	43.80	4.91	25.90	-12.99	53.18	74.00	-20.82	Peak	Vertical
2390.00	52.85	43.80	4.91	25.90	-12.99	39.86	54.00	-14.14	Average	Vertical
2390.00	65.88	43.80	4.91	25.90	-12.99	52.89	74.00	-21.11	Peak	Horizontal
2390.00	53.88	43.80	4.91	25.90	-12.99	40.89	54.00	-13.11	Average	Horizontal
2483.50	66.54	43.80	5.12	25.90	-12.78	53.76	74.00	-20.24	Peak	Vertical
2483.50	52.81	43.80	5.12	25.90	-12.78	40.03	54.00	-13.97	Average	Vertical
2483.50	65.25	43.80	5.12	25.90	-12.78	52.47	74.00	-21.53	Peak	Horizontal
2483.50	52.72	43.80	5.12	25.90	-12.78	39.94	54.00	-14.06	Average	Horizontal
802.11n20										
2390.00	66.36	43.80	4.91	25.90	-12.99	53.37	74.00	-20.63	Peak	Vertical
2390.00	53.22	43.80	4.91	25.90	-12.99	40.23	54.00	-13.77	Average	Vertical
2390.00	66.37	43.80	4.91	25.90	-12.99	53.38	74.00	-20.62	Peak	Horizontal
2390.00	53.94	43.80	4.91	25.90	-12.99	40.95	54.00	-13.05	Average	Horizontal
2483.50	65.12	43.80	5.12	25.90	-12.78	52.34	74.00	-21.66	Peak	Vertical
2483.50	53.74	43.80	5.12	25.90	-12.78	40.96	54.00	-13.04	Average	Vertical
2483.50	66.30	43.80	5.12	25.90	-12.78	53.52	74.00	-20.48	Peak	Horizontal
2483.50	53.04	43.80	5.12	25.90	-12.78	40.26	54.00	-13.74	Average	Horizontal
<p>Remark: Factor = Antenna Factor + Cable Loss – Pre-amplifier.            Low measurement frequencies is range from 2300 to 2422 MHz, high measurement frequencies is range from 2452 to 2500 MHz.            Only show the worst point data of the emissions in the frequency 2300-2422 MHz and 2452-2500 MHz.</p>										

## 4 CONDUCTED SPURIOUS & BAND EDGE EMISSION

### 4.1 APPLIED PROCEDURES / LIMIT

According to FCC Part 15.247(d), in any 100kHz bandwidth outside the frequency band in which the spread spectrum or digitally modulated intentional radiator is operating, the radio frequency power that is produced by the intentional radiator shall be at least 20dB below that in the 100kHz bandwidth within the band that contains the highest level of the desired power, based on either an RF conducted or a radiated measurement.

### 4.2 TEST PROCEDURE

Spectrum Parameter	Setting
Detector	Peak
Start/Stop Frequency	30 MHz to 10th carrier harmonic
RB / VB (emission in restricted band)	100 KHz/300 KHz
Trace-Mode:	Max hold

For Band edge

Spectrum Parameter	Setting
Detector	Peak
Start/Stop Frequency	Lower Band Edge: 2300 to 2422 MHz Upper Band Edge: 2452 to 2500 MHz
RB / VB (emission in restricted band)	100 KHz/300 KHz
Trace-Mode:	Max hold

### 4.3 DEVIATION FROM STANDARD

No deviation.

### 4.4 TEST SETUP

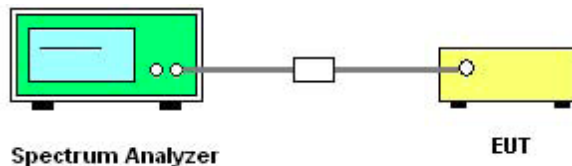

The EUT which is powered by the Battery, is coupled to the Spectrum Analyzer; the RF load attached to the EUT antenna terminal is 50Ohm; the path loss as the factor is calibrated to correct the reading.

Make the measurement with the spectrum analyzer's resolution bandwidth (RBW) = 100 kHz. In order to make an accurate measurement, set the span greater than RBW.

### 4.5 EUT OPERATION CONDITIONS

The EUT tested system was configured as the statements of 2.3 Unless otherwise a special operating condition is specified in the follows during the testing.



4.6 TEST RESULTS

Temperature :	25 °C	Relative Humidity :	60%
Test Voltage :	AC 120V/60Hz	Test Mode :	TX b Mode /CH01, CH06, CH11

CH 01

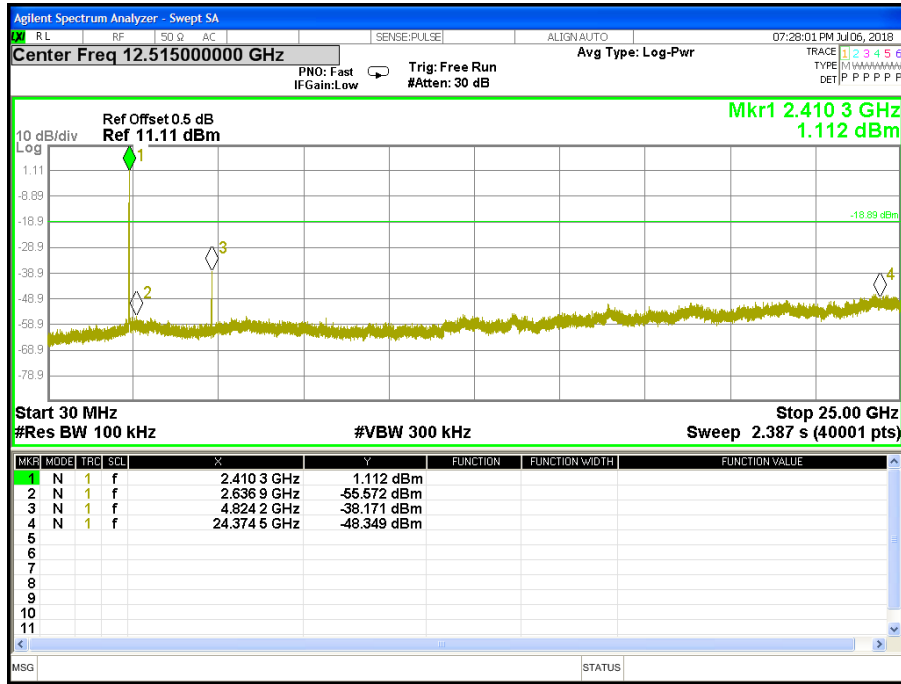

CH 06

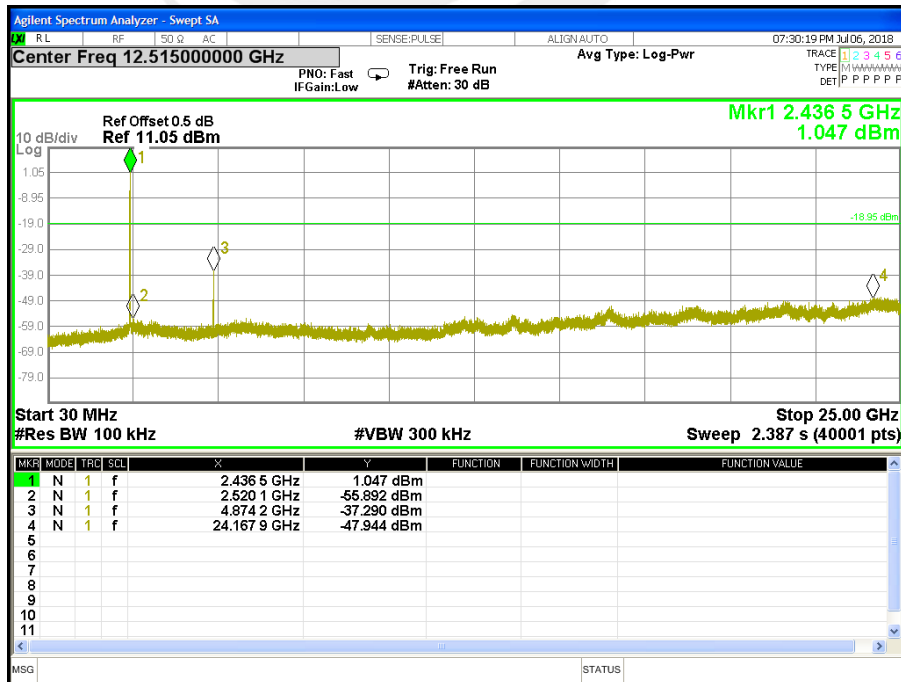



CH 11

