

OneScreen 6

Interactive Display Hardware Manual

Covers all models: OneScreen Hubware(h6), OneScreen Canvas (c6)
and OneScreen Touchscreen (t6)

Contents

1. What's included.....	1
1.1. OneScreen Touchscreen.....	2
1.2. OneScreen Canvas Additional Items.....	2
1.3. OneScreen Hubware Additional Items.....	2
2. About OneScreen.....	3
2.1. Introduction to OneScreen.....	3
2.2. About the Hardware Overview Manual:.....	3
3. Safety First!.....	4
3.1. General.....	4
3.2. Safety Information - OneScreen.....	4
4. Getting Ready!.....	6
4.1. Installing the Wall mount.....	6
5. Hardware Details.....	7
5.1. Top View.....	7
5.2. Bottom View.....	8
5.3. Left Side View.....	9
5.4. Right Side View.....	10
5.5. Front View.....	11
6. Setting Up Your Unit!.....	12
6.1. OneScreen Touchscreen.....	12
6.1.1. Connecting an External PC.....	12
7. Usage Guide.....	13
7.1. Home Screen.....	13
7.1.1. Icons on the Home Screen.....	14
7.1.2. Bottom/Side toolbar.....	15
7.1.3. Applications and Menus.....	16
8. OneScreen Software.....	20
8.1. OneScreen Hype.....	20
8.2. OneScreen Swap.....	20
8.3. OneScreen Annotate.....	20
8.4. EShare.....	21

9.	RS 232 Guide.....	22
9.1.	Settings for RS 232 Control:.....	22
9.2.	RS 232 Commands.....	22
10.	Technical Specifications.....	24
10.1.	Touchscreen Specifications.....	24
11.	Troubleshooting.....	25
12.	Remote control.....	26
	Contact us.....	27

1. What's included



* Optional items are sold as part of different models. These are also sold separately and can be purchased afterwards to complement your OneScreen.

1.1. OneScreen Touchscreen

- OneScreen Touchscreen 4K display
- Wall mount package (contains 1x horizontal mount and 2x mounting arms)
- Remote control (batteries not included)
- Annual User License – OneScreen Hype (Cloud based video conferencing)
- Annual User License – OneScreen Swap (Cloud based screen share and control)
- Perpetual License – OneScreen Annotate (Interactive whiteboard and annotation)
- Perpetual License – Eshare (Wireless presentation with BYOD support)
- Extendible Stylus
- 2x Stylus pens
- HDMI cable
- VGA cable
- Audio Cable (3.5 mm auxiliary)
- Touch USB cable
- Power cable
- Screws

1.2. OneScreen Canvas Additional Items

- On-board OneScreen PC (core i7)
- OneScreen Fixed Camera
- Logitech K400 Plus wireless keyboard with dongle
- Keyboard tray
- Camera tray

1.3. OneScreen Hubware Additional Items

- On-board OneScreen PC (core i7)
- OneScreen PTZ Camera
- Speakerphone Jabra Speak 810
- Logitech K400 Plus wireless keyboard with dongle
- Keyboard tray
- Camera tray

2. About OneScreen

2.1. Introduction to OneScreen:

Every workday is unique. Collaborate the way you need to with OneScreen solutions. From hardware to software, OneScreen offers interactive video collaboration technology for your remote teams along with your conference room, board room and classroom needs. Our solutions include unlimited free, online training and on-demand Screen Skills Guru support.

2.2. About the Hardware Overview Manual:

This guide will lead you through a brief but comprehensive hardware overview of OneScreen solutions including set up, safety warnings, handling, cleaning, precautions, and troubleshooting. It discusses the specifications and set up of OneScreen Touchscreen (t5) whether you use it standalone or as part of Canvas (c5) or Hubware (h5). The chapters included also cover how to install the unit and provide schematics of the various components for better understanding. The guide will help you set up your hardware quickly and easily and will also discuss how you can utilize the hardware with your own computer.

3. Safety First!

3.1. General

Read and understand all safety information, operating instructions, and product labels before operating the equipment. Keep this guide in a safe place for future reference.

- The lightening flash with arrow-head symbol, within a triangle, is intended to alert the user to the presence of “dangerous voltage” within the product’s enclosure that may be sufficient to constitute a risk of electric shock to persons.



- The exclamation mark within a triangle is intended to alert the user to the presence of important operating and maintenance (servicing) instructions.



- To reduce the risk of fire or electric shock, do not expose this product to smoke, rain, dust or moisture!
- To reduce the risk of electric shock, do not remove cover (or back). No user-serviceable parts inside. Refer servicing to qualified service personnel.
- This product is designed and manufactured to operate within defined design limits, and misuse may result in electric shock or fire.
- The installation of this product should be completed by an OneScreen Trained Installer.

3.2. Safety Information - OneScreen

- Inspect OneScreen for any physical damage to the casing before use. If damage is apparent, take care to avoid contact with any potentially live parts.
- Do not under any circumstances try to gain access to internal parts of OneScreen. If you suspect that the device is damaged or faulty, you should contact Technical Customer Support, or an authorized OneScreen service agent for advice.
- Always use accessories recommended by OneScreen to ensure compatibility.
- Only use the power cable that is compatible with your mains outlet socket. If you are unsure of the electrical compatibility of your equipment, please contact OneScreen or an authorized OneScreen service agent before attempting to connect the device to the mains supply.
- Use a wall socket that is close to OneScreen and that is easily accessible.
- Firmly insert the power plug into the wall socket. Partial connection could cause sparks.
- To avoid the risk of electric shock or component damage, disconnect OneScreen from the power supply before plugging in any other cables.
- Hold the power plug when unplugging the device. Pulling the power cable may damage the wires inside the cable and cause fire or electric shock.
- To avoid the risk of electric shock, do not touch the power plug with wet hands.
- Unplug the power plug before cleaning OneScreen.

- Do not use any liquid or spray cleaner when wiping the device. We recommend mixing a solution of 50% isopropanol and 50% water in a spray bottle, and spraying this onto a micro-fiber or 100% cotton cloth
- Wipe the glass surface gently; do not spray the solution onto OneScreen. Doing so could saturate the electronics and cause damage to the device. Only a small amount of the solution is needed to clean and sanitize the glass.
- Do not use volatile solvents (such as alcohol, rosin, and toluene) to clean OneScreen. These types of chemicals might damage the housing.
- Do not use abrasive cleaners.
- Do not apply pressure to the screen. Allow the glass to air dry.
- When moving OneScreen from an area of low temperature to one of high temperature, condensation may form on the housing. Do not power on the device immediately after this to avoid causing fire, electric shock or component damage. To avoid electric shock, avoid handling the power cable during electrical or thunder storms.
- Unplug OneScreen during a lightning storm or when it will not be used for a long period of time. This will protect the device from damage due to power surges.
- Do not place OneScreen in front of an air conditioning unit to avoid condensation which could cause fire, electric shock or component damage.
- The ventilation holes in the housing are designed to protect OneScreen against overheating. Be careful not to block them.
- Do not embed OneScreen in a cabinet, unless the cabinet is well ventilated.
- Do not put OneScreen on or beside any radiator or heater.
- Do not insert hands or any other objects into the ventilation holes or signal joints of OneScreen.
- Never place, spill or pour any liquid on any part of OneScreen. The device could short circuit causing a fire or electric shock.
- Do not apply excessive pressure to the surface of OneScreen.
- Do not use your fingers or any other hard object to knock, press on or scratch the screen of OneScreen.
- Do not put any flammable or explosive objects near OneScreen.
- The remote control operates on 2 x AAA alkaline batteries and wireless keyboard operated on 2 x AA alkaline batteries.
- Risk of explosion if batteries are replaced with incorrect type!
- Incorrect polarity may cause damage or leakage of the batteries, operating injury and contamination of the remote control.
- Keep new and used batteries away from children.
- If the battery compartment does not close securely, stop using the remote control and keep it away from children.
- If you think batteries might have been swallowed or placed inside any part of the body, seek immediate medical attention.

4. Getting Ready!

4.1. Installing the Wall mount

For mounting the unit, check the integrity of the wall, whether it can endure the load of the unit. After that, clean the surface on which the unit is to be installed. Make sure your technician has the proper tools to install the wall mount (these include screws, washers, drill machine, screwdriver etc.)

Follow the steps given below:

- At least two persons are required to lift the screen.
- Hang the horizontal mount with sufficient number of screws.
- Check the level of the mount and make sure that it is properly adjusted.
- Attach and screw the mounting arms on the back side of unit properly, make sure that screws do not damage the screen.
- Hang the screen with the help of others and make sure that the mounting arms properly align and fix themselves on the mount.
- Make sure that spacing between wall and screen is 5 cm or more for proper ventilation.
- Finally, place a little force downward and sideways to check whether the mount withstands the forces.

The following figure shows the mounting arms and horizontal wall mount:

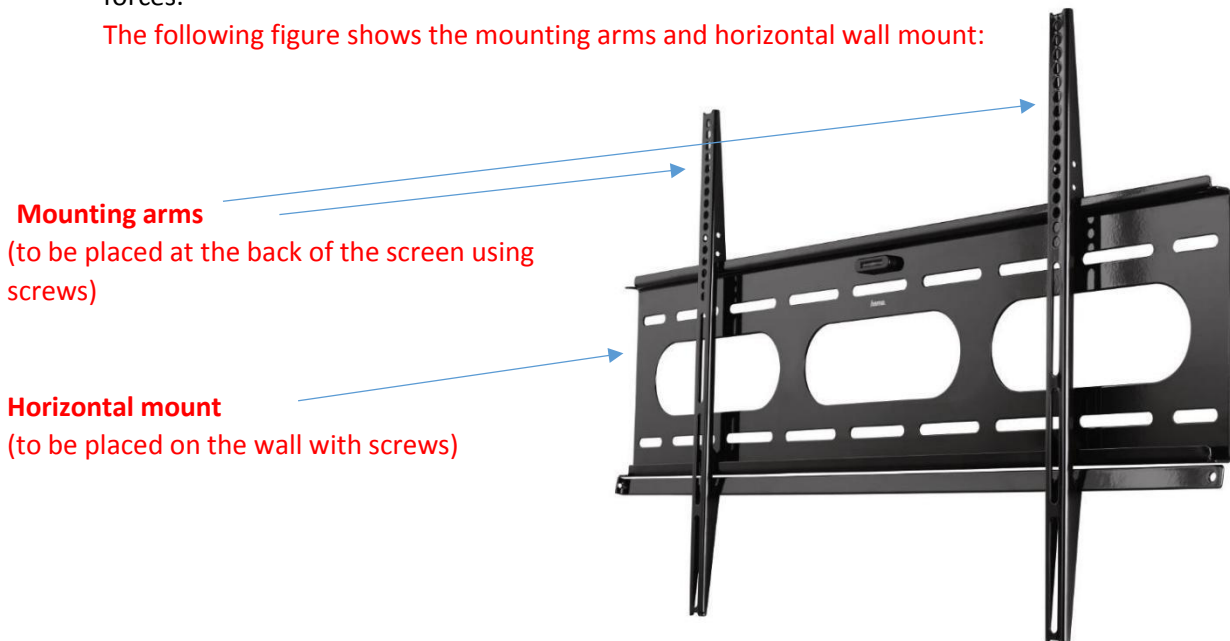

Note: It is recommended that you reinforce the wall to bear the load of the unit.

- The VESA mount pattern for the 55" unit is 400 x 400
- The VESA mount pattern for the 65" unit is 400 x 400
- The VESA mount pattern for the 75" unit is 600 x 400
- The VESA mount pattern for the 86" unit is 600 x 400
- The VESA mount pattern for the 98" unit is 600 x 400

5. Hardware Details

5.1. Top View



5.2. Bottom View

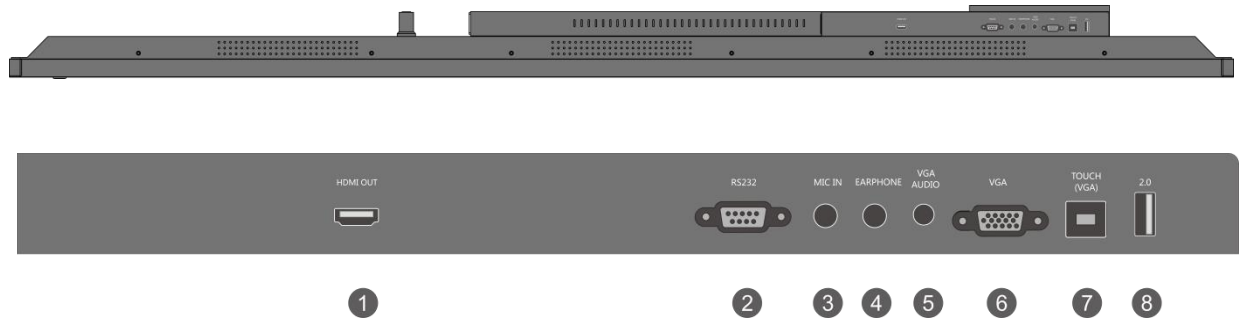

- 1. HDMI 2.0 Out port;
- 2. RS232 control port;
- 3. Microphone port;
- 4. Earphone port;
- 5. VGA Audio port;
- 6. VGA input port;
- 7. Touch USB port (For VGA);
- 8. USB 2.0 Port;

5.3. Left Side View

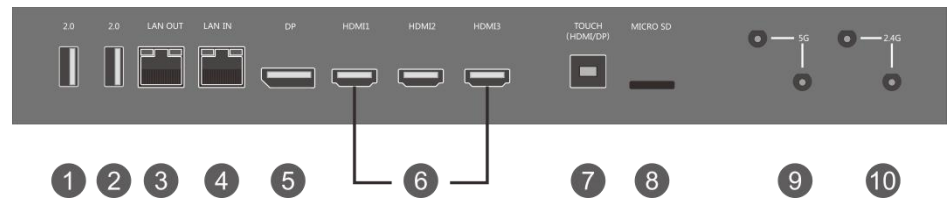
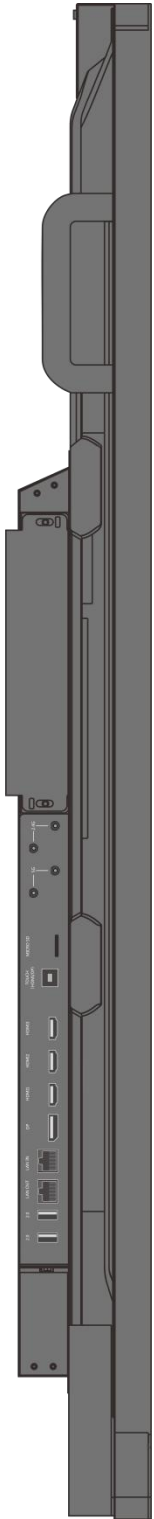

- 1. USB 2.0 Port;
- 2. USB 2.0 Port ;
- 3. LAN for network output port
- 4. LAN for network input port;
- 5. DP 1.2a input port;
- 6. HDMI 2.0 input port;
- 7. Touch USB port (For HDMI and DP);
- 8. Micro SD;
- 9. 5G antenna ports,connected to the flat antenna rod;
- 10. 2.4G Wi-Fi&BLE antenna ports, connected to the circle antenna rod.

5.4. Right Side View

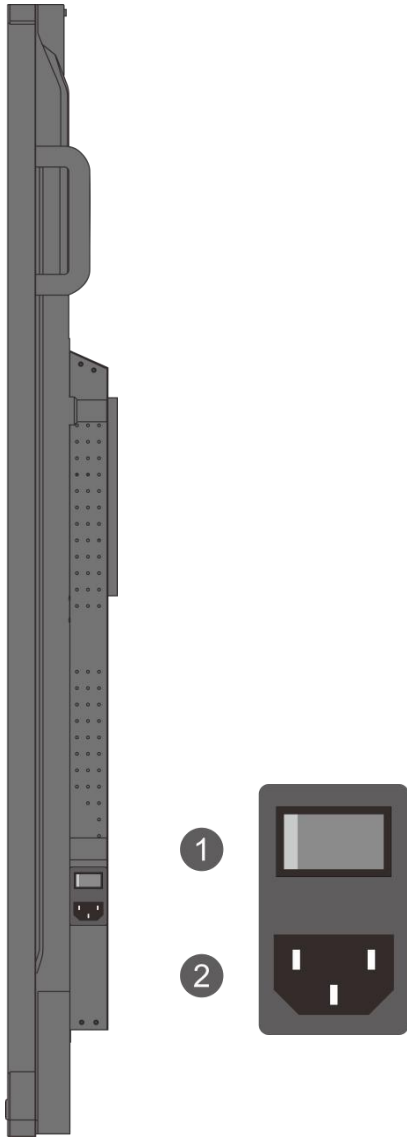

- 1. Power Cable Input
- 2. Power Cable Input Power Button

5.5. Front View



Front USB Ports



① ②

Keypad



③

1. USB Port
2. USB Port

3. Power Button

6. Setting Up Your Unit!

6.1. OneScreen Touchscreen

OneScreen Hubware, Canvas and Touchscreen come with perpetual licenses of OneScreen Annotate & Eshare and the first year subscriptions of OneScreen Hype and OneScreen Swap. If you are not using OPS PC you will have to install these software on your external PC. Please contact us for the digital copy of the software and license. To connect an external PC to the Touchscreen please follow the steps mentioned below.

6.1.1. Connecting an External PC

To connect an external PC, please use the HDMI or VGA cable and the USB touch cable (as shown in What's Included).

Connect one end of the HDMI or VGA cable to your laptop and the other end to one of the corresponding ports on OneScreen Touchscreen. If you are connecting the VGA cable, please also use the AUX cable to transfer audio.

Connect the standard USB end of the USB Touch Cable to your laptop and the other end to the port shown below on OneScreen Touchscreen. Please note that the USB Touch cable should be connected to USB Touch Port A when connecting the PC via HDMI cable and with USB Touch Port B when connecting the PC via VGA cable.

Note: Red lines indicate connections using VGA, AUX and Touch USB cables. Black lines indicate connections using HDMI and Touch USB cables.

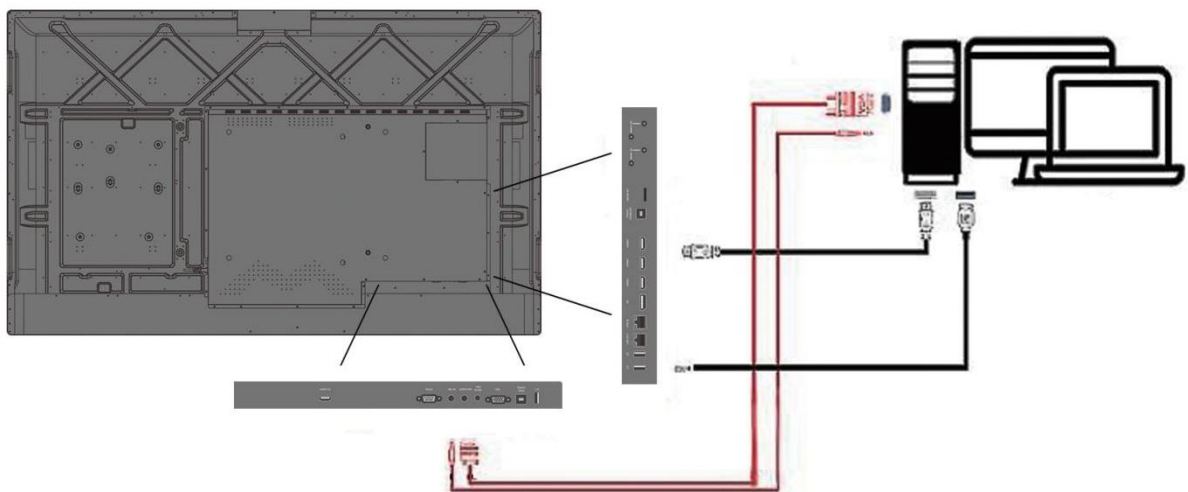







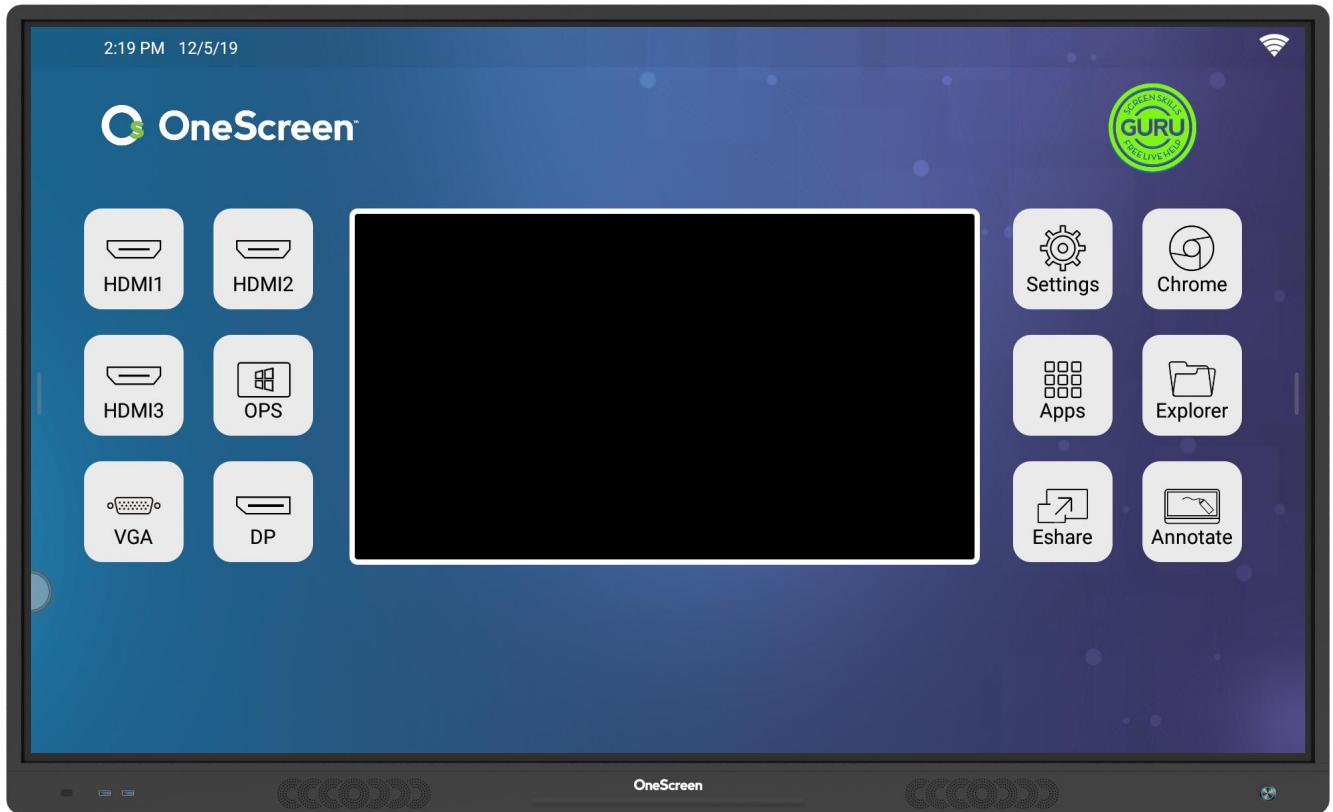





7. Usage Guide

7.1. Home Screen

Pressing OneScreen home button will take you to the Android Home Screen as shown below. Here you will see the time, date, connectivity status and other icons whose purpose is shown in the table.











7.1.1. Icons on the Home Screen

Sr.	Icon	Function
1.		Pressing the GURU icon will connect you to the Support Team via Audio/Video. Please ensure that you have a microphone/Camera connected to OneScreen.
2.		Pressing this icon will make the HDMI 1 as the active input source. Once selected, tap on the mini screen to switch to the respective source.
3.		Pressing this icon will make the HDMI 2 as the active input source. Once selected, tap on the mini screen to switch to the respective source.
4.		Pressing this icon will make the HDMI 3 as the active input source. Once selected, tap on the mini screen to switch to the respective source.
5.		Pressing this icon will make the On-Board PC Source (OPS) as the active input source. Once selected, tap on the mini screen to switch to the respective source.
6.		Pressing this icon will make the VGA as the active input source. Once selected, tap on the mini screen to switch to the respective source.
7.		Pressing this icon will make the Display Port (DP) as the active input source. Once selected, tap on the mini screen to switch to the respective source.
8.		Pressing on this icon will launch the whiteboard application. This application allows the user to perform basic annotation. The application is shown on page no. 16.
9.		Pressing on this icon will take you to the Chrome Browser. The Chrome Browser is shown on page no. 16.
10.		Pressing on this icon will take you to the Android Applications. The Applications window is shown on page no. 17.
11.		Pressing on this icon will take you to the file Explorer. Here you can access the internal storage and external storage devices. The Explorer window is shown on page no. 17.
12.		Pressing on this icon will launch the Eshare Application. This application is used for the wireless screen sharing. The Eshare application is shown on page no. 18.
13.		Pressing on this icon will take you to the settings menu. The settings menu is shown on page no. 18.

7.1.2. Bottom/Side toolbar

Swiping up from the bottom of the screen bring the toolbar which can also be accessed by pressing the arrows keys on either side of OneScreen.

Sr.	Icon	Function
1.		This button will take you to the previous window.
2.		This button will take you to the home screen.
3.		This button will show the running applications. Users can close individual or all applications.
4.		This button will take the user to the source menu.
5.		This button takes the user to the settings side panel . The side panel is shown below.
6.		This button launches the whiteboard application. This application allows the user to perform basic annotation.
7.		Press this button to increase or decrease the volume.
8.		Press this button to increase or decrease the brightness.

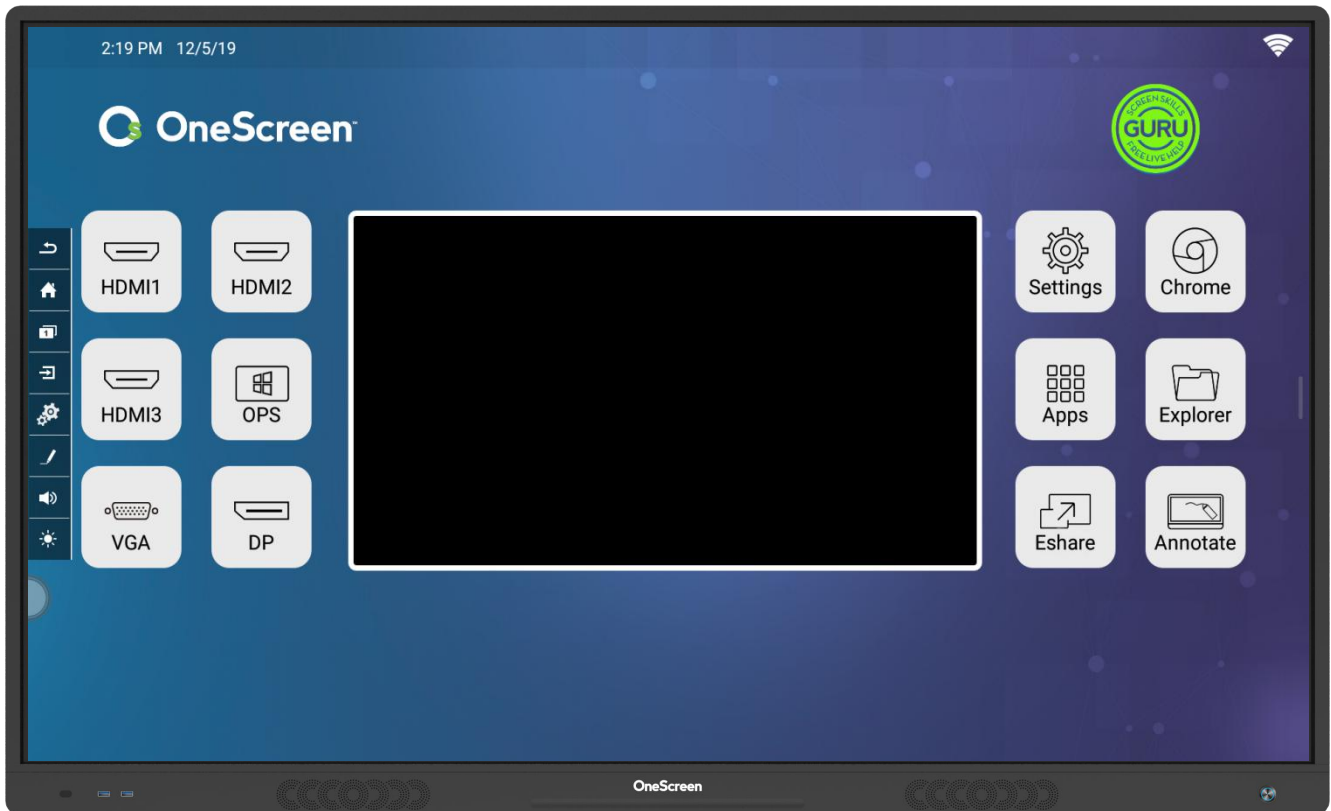

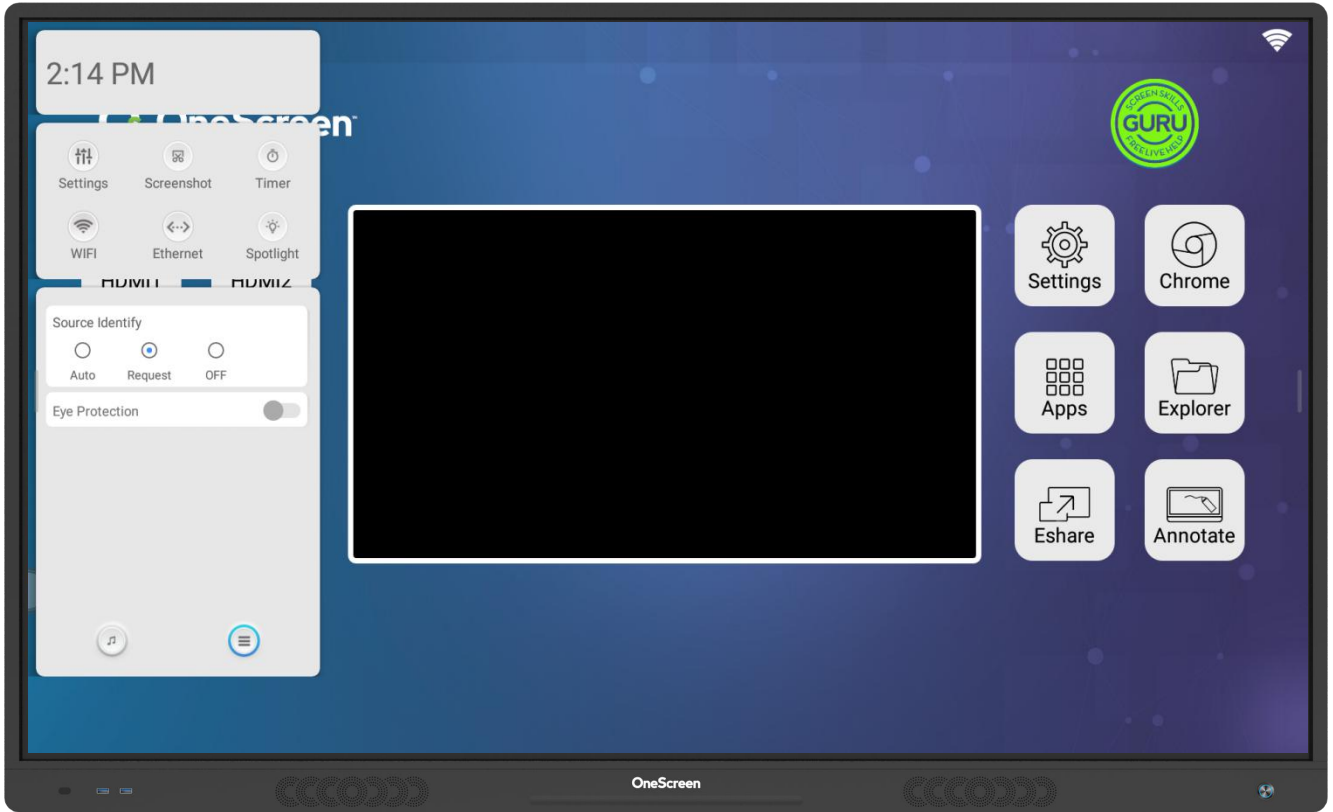

7.1.3. Applications and Menu

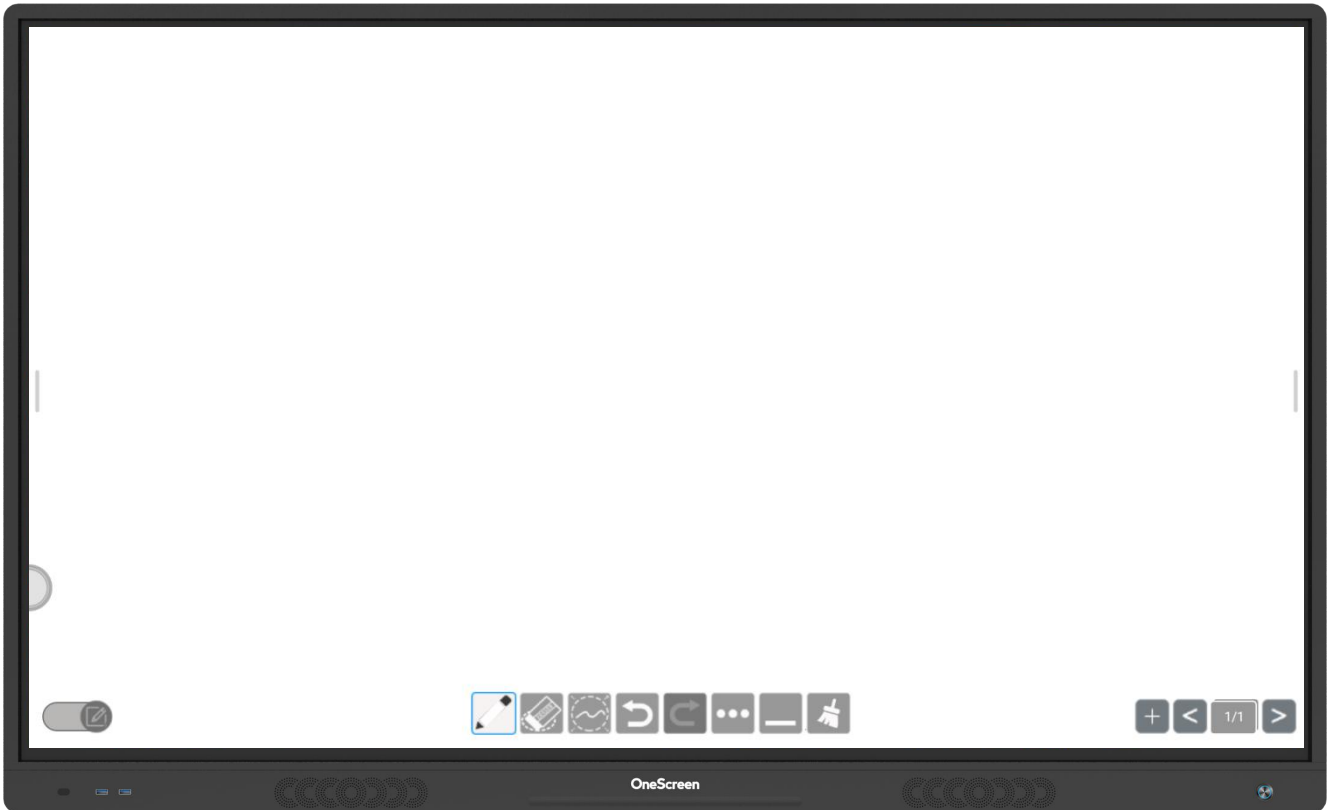

Whiteboard Application

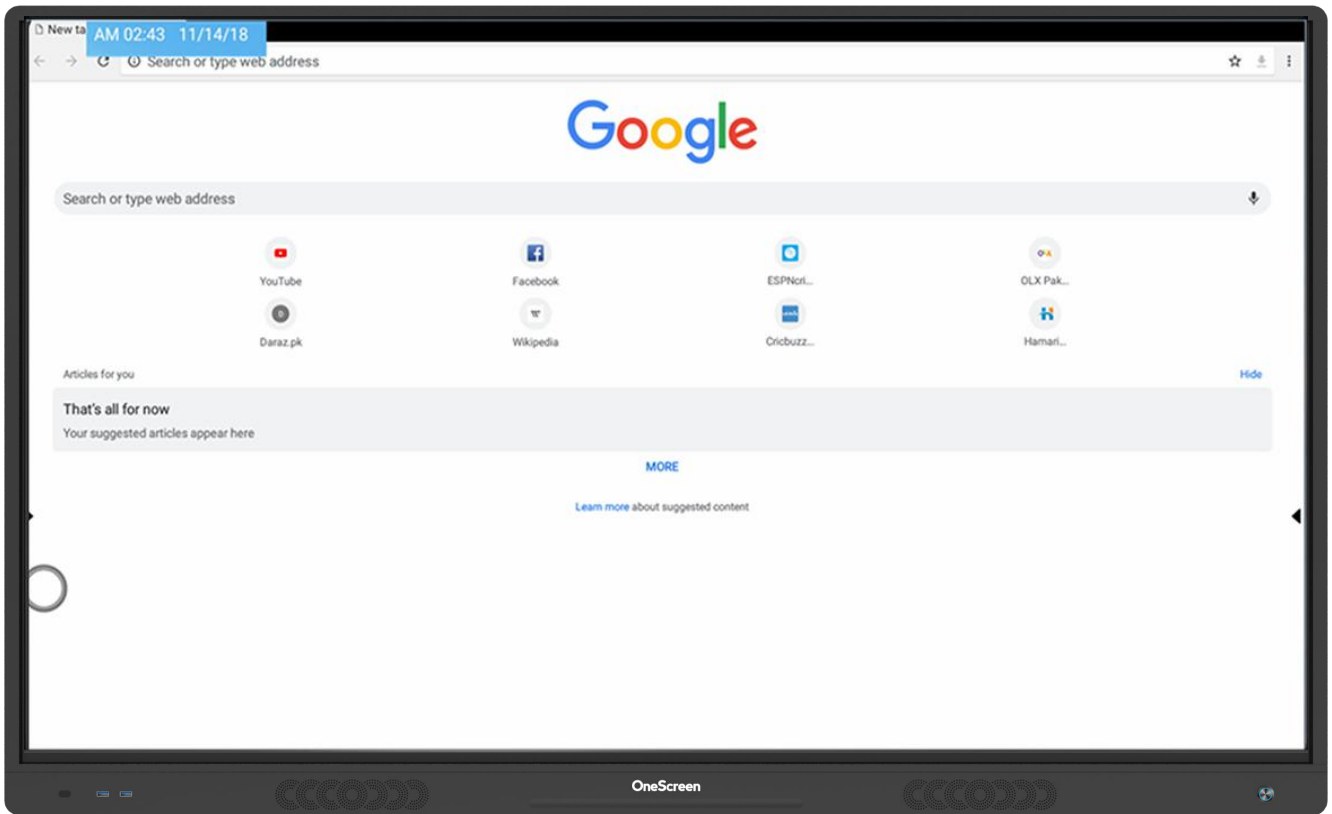

Google Chrome

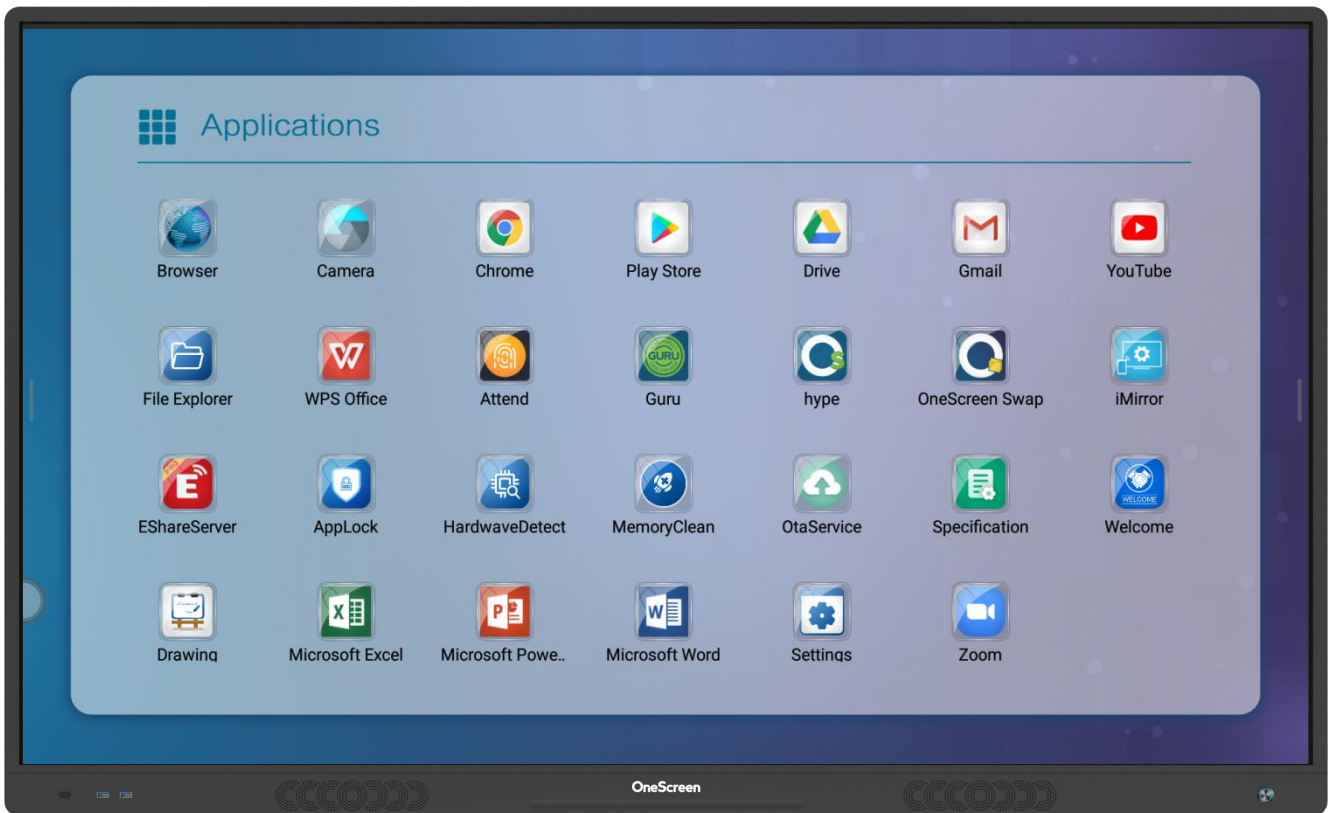

Applications Window

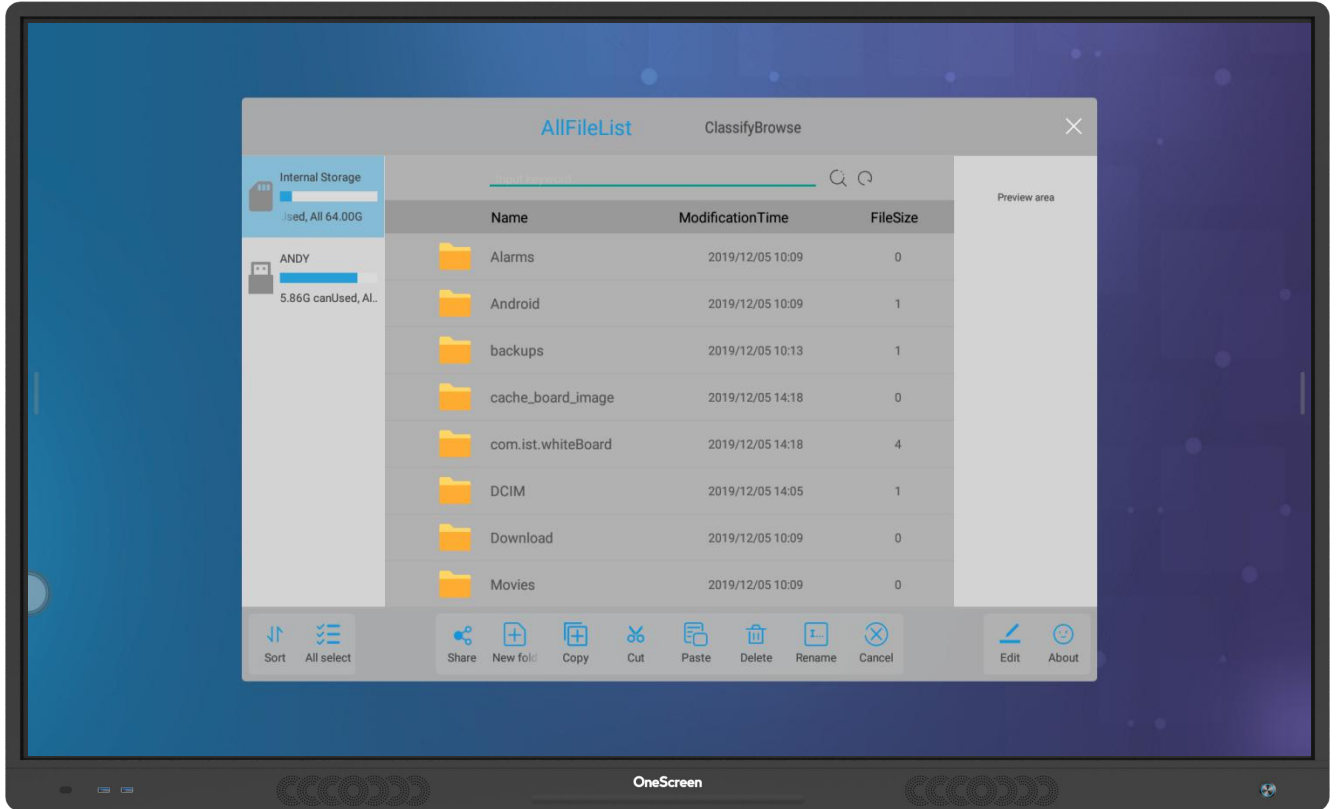

File Explorer



Eshare (Wireless Screen Sharing Application)

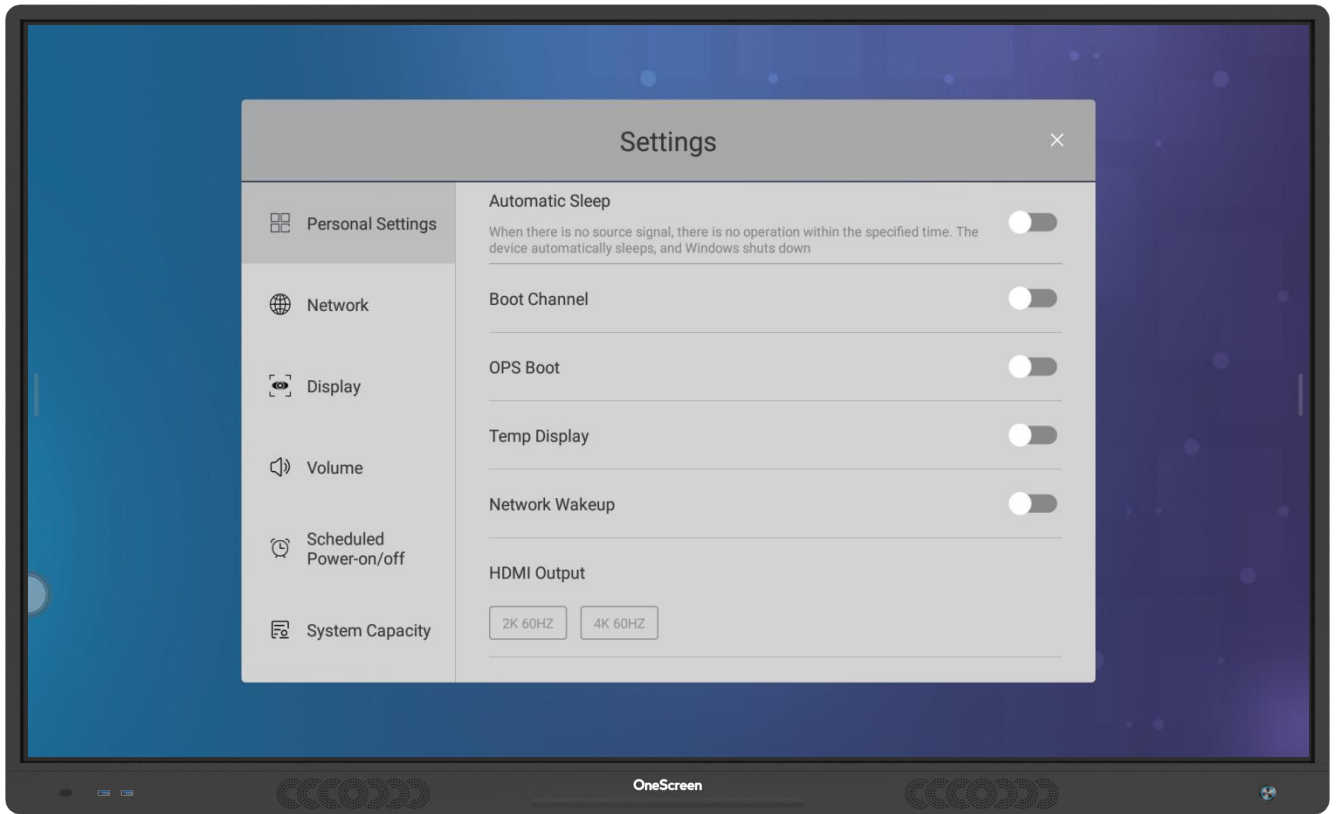

Settings Menu

8. OneScreen Software

8.1. OneScreen Hype

OneScreen Hype is a premium video collaboration software built by OneScreen Solutions. It is a simple-to-use, browser-based software that has all the features you would want in a video conferencing software. The software supports multi-point video/audio call with up to 50 participants in a meeting. It gives users the ability to share screens and pass control of their screens to meeting participants. Interoperability with SIP and PSTN as well as the ability to invite guest users via email makes this solution ideal for your conference room, connecting you with users from different platform. Hype comes with free online training and support which is just one click away from the Screen Skills Guru team. Apart from being functional on web browser, the software has a standalone application as well for Windows, Mac, Android and iOS users.

For more details on OneScreen Hype, please visit the following link or contact our support team.

<https://www.onscreensolutions.com/en/product/hype/>

8.2. OneScreen Swap

OneScreen Swap is browser-based screen sharing and controlling software. Users can share their screens with up to 40 local or remote participants simultaneously. It allows participants to access your screens in one click from any browser. A quick and easy tool that allows you to create teams and then pass control and view to multiple team members at the same time.

OneScreen Swap is designed for maximum collaboration. The software is an ideal choice for remote users and teams. Working together on the same workspace has never been easier. The software does not even require a software download/install to allow remote desktop control. As long as a web browser is present, you are simply a click away from gaining access to the presenter's desktop.

For more details on OneScreen Swap, please visit the following link or contact our support team.

<https://www.onscreensolutions.com/en/product/swap/>

8.3. OneScreen Annotate

OneScreen Annotate is an interactive whiteboard application giving users an unrivaled experience for collaboration, teaching, document editing and brainstorming situations. The software allows up to 50 users to gain access to the whiteboard and contribute in real-time. Annotate is compatible with any machine running Windows and Mac OS and is available with OneScreen products. Annotate has an unlimited canvas size and is presented in an easy to use interface allowing multiple input devices such as fingers & stylus.

OneScreen Annotate saves your work in multiple formats such as .png, .jpeg, .ppt & pdf while also allowing .wmv files to save the audio and annotations simultaneously. This can be particularly useful for classroom sessions so that students can view the lectures later.

Major features include text, shape, and handwriting recognition. Furthermore, Annotate allows the ability to import documents, pdfs, and webpages as well. The intelli-pen feature brings shape recognition converting hand drawn images into pixel perfect clipart and even renders pen drawn text into typed text with advanced text formatting.

For more details on OneScreen Annotate, please visit the following link or contact our support team.

<https://www.onescreensolutions.com/en/product/annotate/>

8.4. EShare

EShare is a multiscreen interaction application for smart phones, tablets or computers to interact with OneScreen. Using EShare you can mirror your phone, tablet and computer screen to the OneScreen and vice versa. It also allows remote control of your OneScreen. Eshare allows up to four users to simultaneously project their screens on OneScreen and is an ideal choice when it comes to mirroring/wireless screen sharing software.

9. RS 232 Guide

9.1. Settings for RS 232 Control:

Use a Straight through Female - Female cable. Connect RS-232 cable between control Processor and OneScreen display. Set your program RS-232 port to the setting below. Control is one-way serial. However you may receive feedback when sending the power on/off commands.			
Port number: COM1(set according the PC or Central control equipment)			
Bit rate	38400	Parity check:	NO
Data byte:	8	Stop byte:	1
Note: Each command must be terminated with a Carriage Return \x0D Hex notation has to be used when sending commands.			

9.2. RS 232 Commands

Function	Required Command
Power On	55 00 8E 00 E3
Power Off	55 00 8D 00 E2
Source	55 00 80 00 D5
Up	55 00 00 01 56
Down	55 00 00 02 57
Left	55 00 00 03 58
Right	55 00 00 04 59
OK	55 00 00 00 55
Menu	55 00 14 00 69
Exit	55 00 16 00 6B
Info	55 00 18 00 6D
Mute	55 00 1A 00 6F
Sleep Mode	55 00 20 00 75
Sound Mode	55 00 22 00 77
Picture Mode	55 00 28 00 7D
Set Sleep Timer	55 00 4A 00 9F
Aspect Ratio	55 00 4C 00 A1
Volume Increase	55 00 0C 00 61
Volume Decrease	55 00 0E 00 63
Return	55 00 0A 00 5F
Switch Source to YPbPr	55 00 80 04 D9
Switch Source to VGA	55 00 80 05 DA
Switch Source to HDMI 1	55 00 80 08 DD
Switch Source to HDMI 2	55 00 80 09 DE
Switch Source to HDMI 3	55 00 80 11 E6
Switch Source to DP	55 00 80 15 EA
Switch Source to On-board PC (OPS)	55 00 80 0B E0
Switch Source to AV in	55 00 80 0C E1
Switch Source to USB	55 00 80 0F E4
Set Contrast	55 00 2A 00 7F
Set Color Temperature	55 00 34 00 89
Set Reduction Noise	55 00 36 00 8B

Set Language	55 00 42 00 97
Enter Factory Settings/Menu	55 00 82 00 D7
Factory Reset	55 00 84 00 D9
Home	55 00 91 00 E6
Resolution Switch	55 00 95 00 EA
Audio Only	55 00 97 00 EC

10. Technical Specifications

10.1. Touchscreen Specifications

Specification	Details
Screen Type	LCD (LED backlight)
Resolution	3840(H) ×2160 (V)
Response Time	<9ms
Touch Capability	20 Points (Finger or Pen)
Surface Protection	Anti-glare Tempered Glass
Panel Size	55" / 65" / 75" / 86" / 98"
Brightness	350-450 cd/m ²
Display colors	1.07 Billion (10-bit)
Audio/Video Input Ports	3x HDMI, 1x Display Port, 1x VGA, 1x Audio in, 1x Mic in
Audio/Video Output Ports	1x Earphone, 1x HDMI out
Connectivity	1x RS232, 1x Lan in, 1x Lan out, 1 x Bluetooth(2.4 GHz), 1 x Wi-Fi(2.4 GHz) , 2 x Hotspot 5.0 GHz , 5x USB, 2x Touch USB, 1 x Micro SD card slot
Refresh Rate	60 Hz (98" is 120Hz)
Speakers	speakers 15W + 15W
Power Supply	AC 100-240V, 50/60 Hz
Remote Control	Monitor Remote Control

11. Troubleshooting

It is always advisable to contact OneScreen technical support team in case of any problem. Technical Support team can be reached by clicking on the Screen Skills Guru button on your screen (camera, mic and Internet connection required), calling +1 855-898-8111 or sending email to support@onescreensolutions.com. The table below will help you identify how to get the system running efficiently in case you encounter any of the following problems:

PROBLEM	Do's	Do not's
PC not working	<ul style="list-style-type: none"> Check if the cables are intact. Check whether the ports are functional. Check for the power button for powering ON the PC from the side. Remove the PC from the screen and insert back. 	<ul style="list-style-type: none"> Do not press ON/OFF button of the PC repeatedly. Do not press power button of the screen repeatedly.
Touchscreen not working	<ul style="list-style-type: none"> Check the cables to ensure they are functioning properly. Check whether the ports are functional. Check whether the USB touch cable is connected properly. Restart the system. 	<ul style="list-style-type: none"> Do not try to fix by dismantling the screen unless you are accompanied by an expert technician. Do not squeeze the USB port. Do not adjust the cables without proper tools.
Touch being recorded incorrectly	<ul style="list-style-type: none"> Confirm that the aspect ratio of the screen and that of the PC is same. Check the calibration of the screen with the PC. Check if there is any dust on the IR frame and clean it. 	<ul style="list-style-type: none"> Do not try to dismantle the screen. Do not damage the IR frame with a sharp object.

12. Remote control

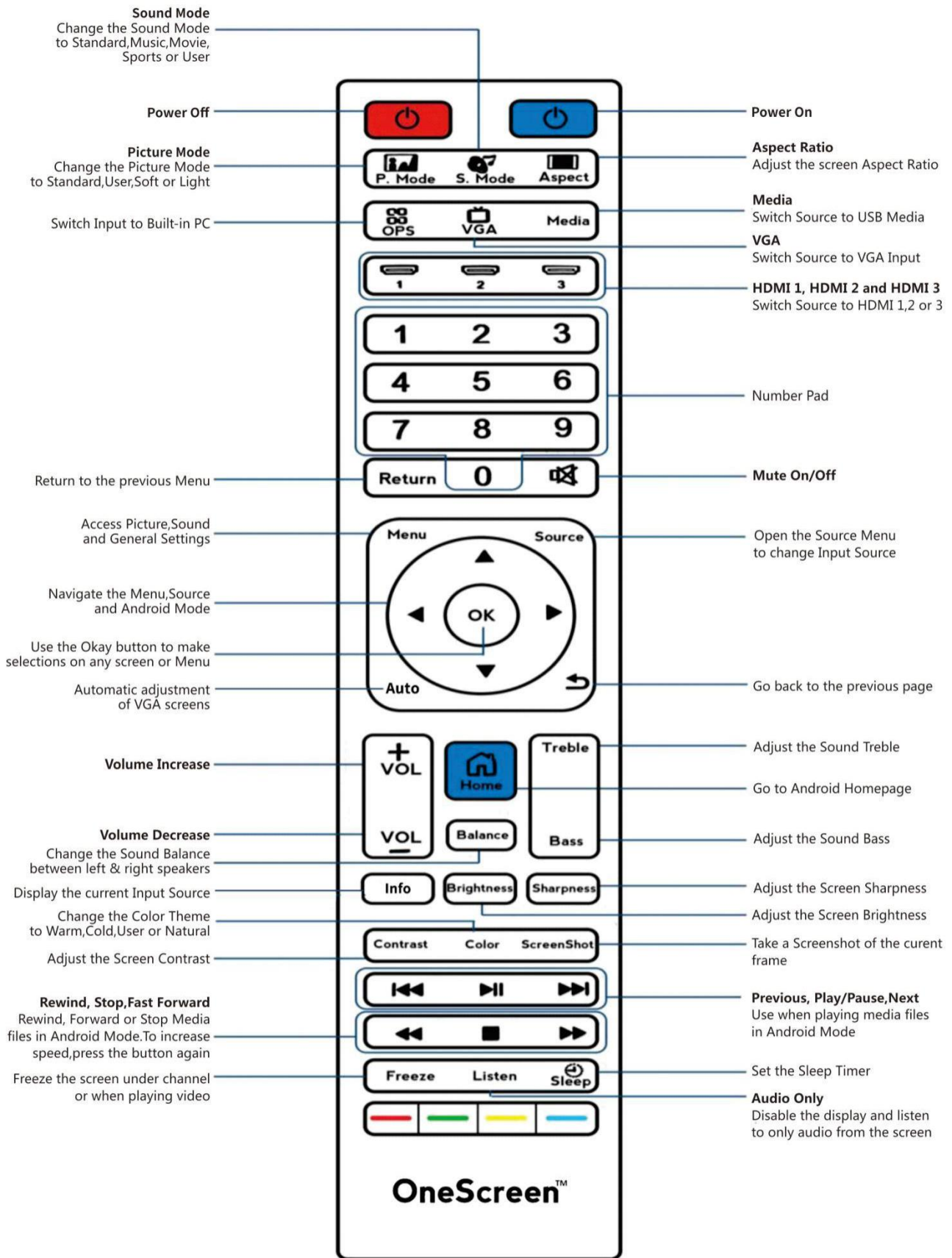

Contact us

USA

Corporate Headquarters

8168 Miramar Road
San Diego, CA 92126
Phone: +1 (858) 552-0290
Fax: +1 (858) 552-0910
support@onescreensolutions.com

UAE

Office C60, 4th Floor
Block C, Dubai Oasis HQ Building.
Dubai, UAE
Phone: +971-4-5015990

Colombia

Transversal 93 No.53-32
Bodega 13, Bogota,
Cundinamarca Colombia
Phone: +57 (1) 547-3589

Mexico

Ejido Santa Isabel Tola 34-201,
San Francisco Culhuacán, Coyoacán,
CDMX México CP. 04420
Phone: + 52 (01)68428081– (01)68428082

Pakistan

278, Sumbal Road F-10/4,
Islamabad
Phone: +92 51 2370270

Specifications are subject to change at any time without notice © 2019. All rights reserved. April 2019

FCC Warning:

This equipment has been tested and found to comply with the limits for a Class B digital device, pursuant to part 15 of the FCC Rules. These limits are designed to provide reasonable protection against harmful interference in a residential installation. This equipment generates, uses and can radiate radio frequency energy and, if not installed and used in accordance with the instructions, may cause harmful interference to radio communications. However, there is no guarantee that interference will not occur in a particular installation. If this equipment does cause harmful interference to radio or television reception, which can be determined by turning the equipment off and on, the user is encouraged to try to correct the interference by one or more of the following measures:

- Reorient or relocate the receiving antenna.
- Increase the separation between the equipment and receiver.
- Connect the equipment into an outlet on a circuit different from that to which the receiver is connected.
- Consult the dealer or an experienced radio/TV technician for help.

Caution: Any changes or modifications to this device not explicitly approved by manufacturer could void your authority to operate this equipment.

This device complies with part 15 of the FCC Rules. Operation is subject to the following two conditions: (1) This device may not cause harmful interference, and (2) this device must accept any interference received, including interference that may cause undesired operation.

FCC

This equipment complies with FCC radiation exposure limits set forth for an uncontrolled environment. This equipment should be installed and operated with minimum distance 20cm between the radiator & your body.