

# FCC Radio Test Report

## FCC ID: 2AL8K-H5

### Original Grant

**Report No.** : TB-FCC163270  
**Applicant** : NZS Inc. DBA Clary Icon  
**Equipment Under Test (EUT)**  
**EUT Name** : KK Intelligent Hub/ Interactive Touch Screen  
**Model No.** : H5 OneScreen  
**Serial Model No.** : N/A  
**Brand Name** : **OneScreen**  
**Receipt Date** : 2018-12-05  
**Test Date** : 2018-12- 06 to 2018-12-16  
**Issue Date** : 2018-12-17  
**Standards** : FCC Part 15: 2018, Subpart C(15.247)  
**Test Method** : ANSI C63.10: 2013  
**Conclusions** : **PASS**

In the configuration tested, the EUT complied with the standards specified above,

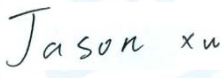
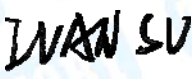
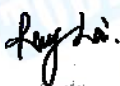
**Test/Witness Engineer** :  Jason Xu  
**Engineer Supervisor** :  Ivan Su  
**Engineer Manager** :  Ray Lai

This report details the results of the testing carried out on one sample. The results contained in this test report do not relate to other samples of the same product. The manufacturer should ensure that all products in series production are in conformity with the product sample detailed in the report.

---

---

# Contents

- CONTENTS.....2**
- 1. GENERAL INFORMATION ABOUT EUT .....5**
  - 1.1 Client Information.....5
  - 1.2 General Description of EUT (Equipment Under Test) .....5
  - 1.3 Block Diagram Showing the Configuration of System Tested.....6
  - 1.4 Description of Support Units .....6
  - 1.5 Description of Test Mode.....6
  - 1.6 Description of Test Software Setting .....8
  - 1.7 Measurement Uncertainty .....8
  - 1.8 Test Facility.....9
- 2. TEST SUMMARY .....10**
- 3. TEST EQUIPMENT .....11**
- 4. CONDUCTED EMISSION TEST .....12**
  - 4.1 Test Standard and Limit.....12
  - 4.2 Test Setup.....12
  - 4.3 Test Procedure.....12
  - 4.4 EUT Operating Mode .....13
  - 4.5 Test Da5ta.....13
- 5. RADIATED EMISSION TEST .....14**
  - 5.1 Test Standard and Limit.....14
  - 5.2 Test Setup.....15
  - 5.3 Test Procedure.....16
  - 5.4 EUT Operating Condition .....17
  - 5.5 Test Data.....17
- 6. RESTRICTED BANDS REQUIREMENT .....18**
  - 6.1 Test Standard and Limit.....18
  - 6.2 Test Setup.....18
  - 6.3 Test Procedure.....18
  - 6.4 EUT Operating Condition .....19
  - 6.5 Test Data.....19
- 7. BANDWIDTH TEST .....20**
  - 7.1 Test Standard and Limit.....20
  - 7.2 Test Setup.....20
  - 7.3 Test Procedure.....20
  - 7.4 EUT Operating Condition .....20
  - 7.5 Test Data.....20
- 8. PEAK OUTPUT POWER TEST.....21**
  - 8.1 Test Standard and Limit.....21
  - 8.2 Test Setup.....21

---

---

|   |           |
|---|-----------|
| 8.3 Test Procedure.....   | 21        |
| 8.4 EUT Operating Condition .....                                 | 21        |
| 8.5 Test Data.....  | 21        |
| <b>9. POWER SPECTRAL DENSITY TEST .....</b>                       | <b>22</b> |
| 9.1 Test Standard and Limit.....                                  | 22        |
| 9.2 Test Setup.....   | 22        |
| 9.3 Test Procedure.....   | 22        |
| 9.4 EUT Operating Condition .....                                 | 22        |
| 9.5 Test Data.....  | 22        |
| <b>10. ANTENNA REQUIREMENT.....</b>                               | <b>23</b> |
| 10.1 Standard Requirement.....                                    | 23        |
| 10.2 Antenna Connected Construction.....                          | 23        |
| 10.3 Result.....  | 23        |
| <b>ATTACHMENT A-- CONDUCTED EMISSION TEST DATA .....</b>          | <b>24</b> |
| <b>ATTACHMENT B-- RADIATED EMISSION TEST DATA .....</b>           | <b>28</b> |
| <b>ATTACHMENT C-- RESTRICTED BANDS REQUIREMENT TEST DATA.....</b> | <b>36</b> |
| <b>ATTACHMENT D-- BANDWIDTH TEST DATA.....</b>                    | <b>41</b> |
| <b>ATTACHMENT E-- PEAK OUTPUT POWER TEST DATA.....</b>            | <b>43</b> |
| <b>ATTACHMENT F-- POWER SPECTRAL DENSITY TEST DATA.....</b>       | <b>45</b> |

**Revision History**

| Report No.  | Version | Description             | Issued Date |
|-------------|---------|-------------------------|-------------|
| TB-RF163270 | Rev.01  | Initial issue of report | 2018-12-17  |
|             |         |                         |             |
|             |         |                         |             |
|             |         |                         |             |
|             |         |                         |             |
|             |         |                         |             |
|             |         |                         |             |
|             |         |                         |             |
|             |         |                         |             |
|             |         |                         |             |
|             |         |                         |             |
|             |         |                         |             |
|             |         |                         |             |
|             |         |                         |             |
|             |         |                         |             |
|             |         |                         |             |
|             |         |                         |             |
|             |         |                         |             |
|             |         |                         |             |
|             |         |                         |             |
|             |         |                         |             |

# 1. General Information about EUT

## 1.1 Client Information

|                     |   |   |
|---------------------|---|---|
| <b>Applicant</b>    | : | NZS Inc. DBA Clary Icon   |
| <b>Address</b>      | : | 6224 Ferris Square, Suite C, San Diego, California, United States                                 |
| <b>Manufacturer</b> | : | Shenzhen Konka E-display Co.,Ltd  |
| <b>Address</b>      | : | 22A,KONKA Building,South Technology Road No.12th,High-tech Industrial Park,Nanshan,Shenzhen China |

## 1.2 General Description of EUT (Equipment Under Test)

|                               |   |  |   |
|-------------------------------|---|--|---|
| <b>EUT Name</b>               | : | KK Intelligent Hub/ Interactive Touch Screen       |   |
| <b>Models No.</b>             | : | H5 OneScreen                                       |   |
| <b>Product Description</b>    | : | Operation Frequency:                               | Bluetooth (BLE): 2402MHz~2480MHz                |
|                               | : | Number of Channel:                                 | Bluetooth (BLE): 40 channels <b>see note(3)</b> |
|                               | : | Antenna Gain:                                      | 5dBi Reverse SMA Antenna                        |
|                               | : | Modulation Type:                                   | GFSK  |
|                               | : | Bit Rate of Transmitter:                           | 1Mbps(GFSK)                                     |
| <b>Power Rating</b>           | : | Input: AC 100-240, 50/60Hz<br>Output: AC 120V/60HZ |   |
| <b>Connecting I/O Port(S)</b> | : | Please refer to the User's Manual                  |   |

### Note:

This Test Report is FCC Part 15.247 for Bluetooth BLE, the test procedure follows the FCC KDB 558074 D01v05.

(1) For a more detailed features description, please refer to the manufacturer's specifications or the User's Manual.

(2) Antenna information provided by the applicant.

(3) Channel List:

| Channel | Frequency (MHz) | Channel | Frequency (MHz) | Channel | Frequency (MHz) |
|---------|-----------------|---------|-----------------|---------|-----------------|
| 00      | 2402            | 14      | 2430            | 28      | 2458            |
| 01      | 2404            | 15      | 2432            | 29      | 2460            |
| 02      | 2406            | 16      | 2434            | 30      | 2462            |
| 03      | 2408            | 17      | 2436            | 31      | 2464            |

|    |      |    |      |    |      |
|----|------|----|------|----|------|
| 04 | 2410 | 18 | 2438 | 32 | 2466 |
| 05 | 2412 | 19 | 2440 | 33 | 2468 |
| 06 | 2414 | 20 | 2442 | 34 | 2470 |
| 07 | 2416 | 21 | 2444 | 35 | 2472 |
| 08 | 2418 | 22 | 2446 | 36 | 2474 |
| 09 | 2420 | 23 | 2448 | 37 | 2476 |
| 10 | 2422 | 24 | 2450 | 38 | 2478 |
| 11 | 2424 | 25 | 2452 | 39 | 2480 |
| 12 | 2426 | 26 | 2454 |    |      |
| 13 | 2428 | 27 | 2456 |    |      |

### 1.3 Block Diagram Showing the Configuration of System Tested

#### TX Mode

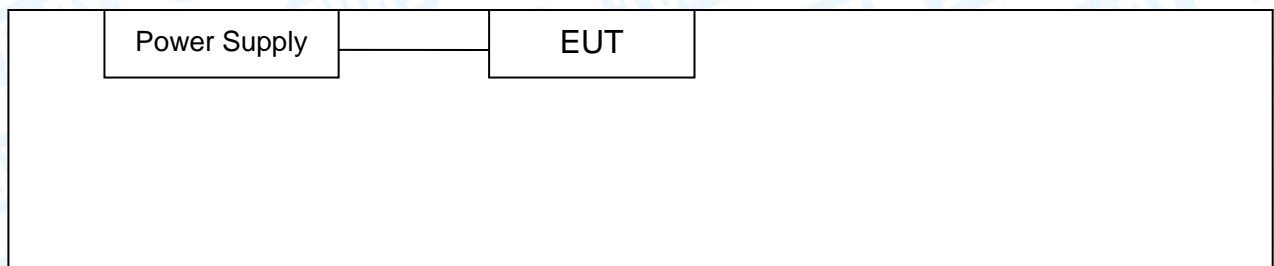

### 1.4 Description of Support Units

| Equipment Information |               |              |              |          |
|-----------------------|---------------|--------------|--------------|----------|
| Name                  | Model         | FCC ID/VOC   | Manufacturer | Used “√” |
| ----                  | ----          | ----         | ----         | ----     |
| Cable Information     |               |              |              |          |
| Number                | Shielded Type | Ferrite Core | Length       | Note     |
| ----                  | ----          | ----         | ----         | ----     |

### 1.5 Description of Test Mode

To investigate the maximum EMI emission characteristics generates from EUT, the test system was pre-scanning tested base on the consideration of following EUT operation mode or test configuration mode which possible have effect on EMI emission level. Each of these EUT operation mode(s) or test configuration mode(s) mentioned follow was evaluated respectively.

| For Conducted Test |             |
|--------------------|-------------|
| Final Test Mode    | Description |
| Mode 1             | TX Mode     |

| For Radiated Test |                            |
|-------------------|----------------------------|
| Final Test Mode   | Description                |
| Mode 2            | TX Mode                    |
| Mode 3            | TX Mode (Channel 00/20/39) |

**Note:**

- (1) For all test, we have verified the construction and function in typical operation. And all the test modes were carried out with the EUT in transmitting operation in maximum power with all kinds of data rate.  
According to ANSI C63.10 standards, the measurements are performed at the highest, middle, lowest available channels, and the worst case data rate as follows:  
BLE Mode: GFSK Modulation Transmitting mode.
- (2) During the testing procedure, the continuously transmitting with the maximum power mode was programmed by the customer.
- (3) The EUT is considered a portable unit; in normal use it was positioned on X-plane. The worst case was found positioned on X-plane. Therefore only the test data of this X-plane was used for radiated emission measurement test.

## 1.6 Description of Test Software Setting

During testing channel & Power controlling software provided by the customer was used to control the operating channel as well as the output power level. The RF output power selection is for the setting of RF output power expected by the customer and is going to be fixed on the firmware of the final end product power parameters of RF setting.

| Test Software Version | ISRT.exe |         |          |
|-----------------------|----------|---------|----------|
| Frequency             | 2402 MHz | 2442MHz | 2480 MHz |
| GFSK                  | DEF      | DEF     | DEF      |

## 1.7 Measurement Uncertainty

The reported uncertainty of measurement  $y \pm U$ , where expanded uncertainty  $U$  is based on a standard uncertainty multiplied by a coverage factor of  $k=2$ , providing a level of confidence of approximately 95 %.

| Test Item          | Parameters                           | Expanded Uncertainty ( $U_{Lab}$ ) |
|--------------------|--------------------------------------|------------------------------------|
| Conducted Emission | Level Accuracy:<br>9kHz~150kHz       | $\pm 3.42$ dB                      |
|                    | 150kHz to 30MHz                      | $\pm 3.42$ dB                      |
| Radiated Emission  | Level Accuracy:<br>9kHz to 30 MHz    | $\pm 4.60$ dB                      |
| Radiated Emission  | Level Accuracy:<br>30MHz to 1000 MHz | $\pm 4.40$ dB                      |
| Radiated Emission  | Level Accuracy:<br>Above 1000MHz     | $\pm 4.20$ dB                      |



## 1.8 Test Facility

The testing was performed by the Shenzhen Toby Technology Co., Ltd., in their facilities located at:1A/F., Bldg.6, Yusheng Industrial Zone, The National Road No.107 Xixiang Section 467, Xixiang, Bao'an, Shenzhen, Guangdong, China.

At the time of testing, the following bodies accredited the Laboratory:

### **CNAS (L5813)**

The Laboratory has been accredited by CNAS to ISO/IEC 17025: 2005 General Requirements for the Competence of Testing and Calibration Laboratories for the competence in the field of testing. And the Registration No.: CNAS L5813.

### **A2LA Certificate No.: 4750.01**

The laboratory has been accredited by American Association for Laboratory Accreditation(A2LA) to ISO/IEC 17025: 2005 General Requirements for the Competence of Testing and Calibration Laboratories for the technical competence in the field of Electrical Testing. And the A2LA Certificate No.: 4750.01.

FCC Accredited Test Site Number: 854351.

### **IC Registration No.: (11950A-1)**

The Laboratory has been registered by Certification and Engineering Bureau of Industry Canada for radio equipment testing. The site registration: Site# 11950A-1.

## 2. Test Summary

| FCC Part 15 Subpart C(15.247)/RSS 247 Issue 2 |                    |  |          |        |
|---|--------------------|--|----------|--------|
| Standard Section                              |                    | Test Item  | Judgment | Remark |
| FCC   | IC                 |  |          |        |
| 15.203  |                    | Antenna Requirement  | PASS     | N/A    |
| 15.207(a)                                     | RSS-GEN<br>7.2.4   | Conducted Emission   | PASS     | N/A    |
| 15.205&15.247(d)                              | RSS-GEN<br>7.2.2   | Band-Edge & Unwanted Emissions into Restricted Frequency                     | PASS     | N/A    |
| 15.247(a)(2)                                  | RSS 247<br>5.2 (1) | 6dB Bandwidth  | PASS     | N/A    |
| 15.247(b)(3)                                  | RSS 247<br>5.4 (4) | Conducted Max Output Power   | PASS     | N/A    |
| 15.247(e)                                     | RSS 247<br>5.2 (2) | Power Spectral Density   | PASS     | N/A    |
| 15.205,<br>15.209&15.247(d)                   | RSS 247<br>5.5     | Transmitter Radiated Spurious & Unwanted Emissions into Restricted Frequency | PASS     | N/A    |

**Note:** N/A is an abbreviation for Not Applicable.

### 3. Test Equipment

| Conducted Emission Test    |                                  |                   |               |               |               |
|----------------------------|----------------------------------|-------------------|---------------|---------------|---------------|
| Equipment                  | Manufacturer                     | Model No.         | Serial No.    | Last Cal.     | Cal. Due Date |
| EMI Test Receiver          | Rohde & Schwarz                  | ESCI              | 100321        | Jul.18, 2018  | Jul. 17, 2019 |
| RF Switching Unit          | Compliance Direction Systems Inc | RSU-A4            | 34403         | Jul.18, 2018  | Jul. 17, 2019 |
| AMN                        | SCHWARZBECK                      | NNBL 8226-2       | 8226-2/164    | Jul.18, 2018  | Jul. 17, 2019 |
| LISN                       | Rohde & Schwarz                  | ENV216            | 101131        | Jul.18, 2018  | Jul. 17, 2019 |
| Radiation Emission Test    |                                  |                   |               |               |               |
| Equipment                  | Manufacturer                     | Model No.         | Serial No.    | Last Cal.     | Cal. Due Date |
| Spectrum Analyzer          | Agilent                          | E4407B            | MY45106456    | Jul.18, 2018  | Jul. 17, 2019 |
| EMI Test Receiver          | Rohde & Schwarz                  | ESPI              | 100010/007    | Jul.18, 2018  | Jul. 17, 2019 |
| Bilog Antenna              | ETS-LINDGREN                     | 3142E             | 00117537      | Mar.16, 2018  | Mar. 15, 2019 |
| Bilog Antenna              | ETS-LINDGREN                     | 3142E             | 00117542      | Mar.16, 2018  | Mar. 15, 2019 |
| Horn Antenna               | ETS-LINDGREN                     | 3117              | 00143207      | Mar.16, 2018  | Mar. 15, 2019 |
| Horn Antenna               | ETS-LINDGREN                     | 3117              | 00143209      | Mar.16, 2018  | Mar. 15, 2019 |
| Loop Antenna               | SCHWARZBECK                      | FMZB 1519 B       | 1519B-059     | Jul. 15, 2018 | Jul. 14, 2019 |
| Pre-amplifier              | Sonoma                           | 310N              | 185903        | Mar.16, 2018  | Mar. 15, 2019 |
| Pre-amplifier              | HP                               | 8449B             | 3008A00849    | Mar.16, 2018  | Mar. 15, 2019 |
| Cable                      | HUBER+SUHNER                     | 100               | SUCOFLEX      | Mar.16, 2018  | Mar. 15, 2019 |
| Positioning Controller     | ETS-LINDGREN                     | 2090              | N/A           | N/A           | N/A           |
| Antenna Conducted Emission |                                  |                   |               |               |               |
| Equipment                  | Manufacturer                     | Model No.         | Serial No.    | Last Cal.     | Cal. Due Date |
| Spectrum Analyzer          | Agilent                          | E4407B            | MY45106456    | Jul.18, 2018  | Jul. 17, 2019 |
| Spectrum Analyzer          | Rohde & Schwarz                  | ESCI              | 100010/007    | Jul.18, 2018  | Jul. 17, 2019 |
| MXA Signal Analyzer        | Agilent                          | N9020A            | MY49100060    | Sep. 15, 2018 | Sep. 14, 2019 |
| Vector Signal Generator    | Agilent                          | N5182A            | MY50141294    | Sep. 15, 2018 | Sep. 14, 2019 |
| Analog Signal Generator    | Agilent                          | N5181A            | MY50141953    | Sep. 15, 2018 | Sep. 14, 2019 |
| RF Power Sensor            | DARE!! Instruments               | RadiPowerRPR3006W | 17I00015SNO26 | Sep. 15, 2018 | Sep. 14, 2019 |
|                            | DARE!! Instruments               | RadiPowerRPR3006W | 17I00015SNO29 | Sep. 15, 2018 | Sep. 14, 2019 |
|                            | DARE!! Instruments               | RadiPowerRPR3006W | 17I00015SNO31 | Sep. 15, 2018 | Sep. 14, 2019 |
|                            | DARE!! Instruments               | RadiPowerRPR3006W | 17I00015SNO33 | Sep. 15, 2018 | Sep. 14, 2019 |

## 4. Conducted Emission Test

### 4.1 Test Standard and Limit

#### 4.1.1 Test Standard

FCC Part 15.207

#### 4.1.2 Test Limit

**Conducted Emission Test Limit**

| Frequency     | Maximum RF Line Voltage (dB $\mu$ V) |               |
|---------------|--------------------------------------|---------------|
|               | Quasi-peak Level                     | Average Level |
| 150kHz~500kHz | 66 ~ 56 *                            | 56 ~ 46 *     |
| 500kHz~5MHz   | 56                                   | 46            |
| 5MHz~30MHz    | 60                                   | 50            |

Notes:

(1) \*Decreasing linearly with logarithm of the frequency.

(2) The lower limit shall apply at the transition frequencies.

(3) The limit decrease in line with the logarithm of the frequency in the range of 0.15 to 0.50MHz.

### 4.2 Test Setup

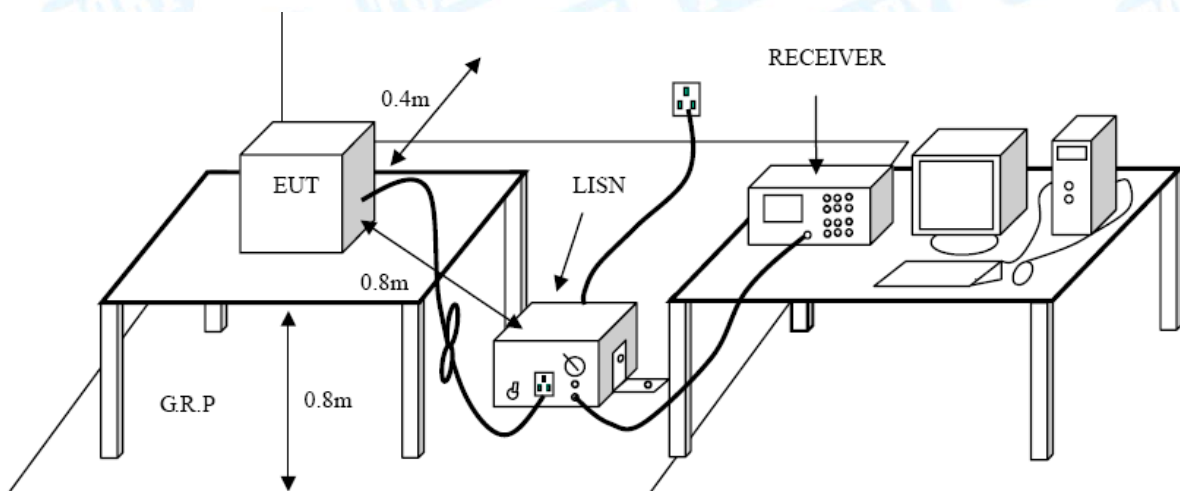

### 4.3 Test Procedure

The EUT was placed 0.8 meters from the horizontal ground plane with EUT being connected to the power mains through a line impedance stabilization network (LISN). All other support equipments powered from additional LISN(s). The LISN provide 50 Ohm/ 50uH of coupling impedance for the measuring instrument.

Interconnecting cables that hang closer than 40 cm to the ground plane shall be folded back and forth in the center forming a bundle 30 to 40 cm long.

I/O cables that are not connected to a peripheral shall be bundled in the center. The end of the cable may be terminated, if required, using the correct terminating impedance. The overall length shall not exceed 1 m.

LISN at least 80 cm from nearest part of EUT chassis.

The bandwidth of EMI test receiver is set at 9 kHz, and the test frequency band is from 0.15MHz to 30MHz.

#### 4.4 EUT Operating Mode

Please refer to the description of test mode.

#### 4.5 Test Da5ta

Please refer to the Attachment A.

## 5. Radiated Emission Test

### 5.1 Test Standard and Limit

#### 5.1.1 Test Standard

FCC Part 15.247(d)

#### 5.1.2 Test Limit

#### Radiated Emission Limits (9kHz~1000MHz)

| Frequency (MHz) | Field Strength (microvolt/meter) | Measurement Distance (meters) |
|-----------------|----------------------------------|-------------------------------|
| 0.009~0.490     | 2400/F(KHz)                      | 300                           |
| 0.490~1.705     | 24000/F(KHz)                     | 30                            |
| 1.705~30.0      | 30                               | 30                            |
| 30~88           | 100                              | 3                             |
| 88~216          | 150                              | 3                             |
| 216~960         | 200                              | 3                             |
| Above 960       | 500                              | 3                             |

#### Radiated Emission Limit (Above 1000MHz)

| Frequency (MHz) | Distance Meters(at 3m) |                  |
|-----------------|------------------------|------------------|
|                 | Peak (dBuV/m)          | Average (dBuV/m) |
| Above 1000      | 74                     | 54               |

**Note:**

- (1) The tighter limit applies at the band edges.
- (2) Emission Level (dBuV/m)=20log Emission Level (uV/m)

5.2 Test Setup

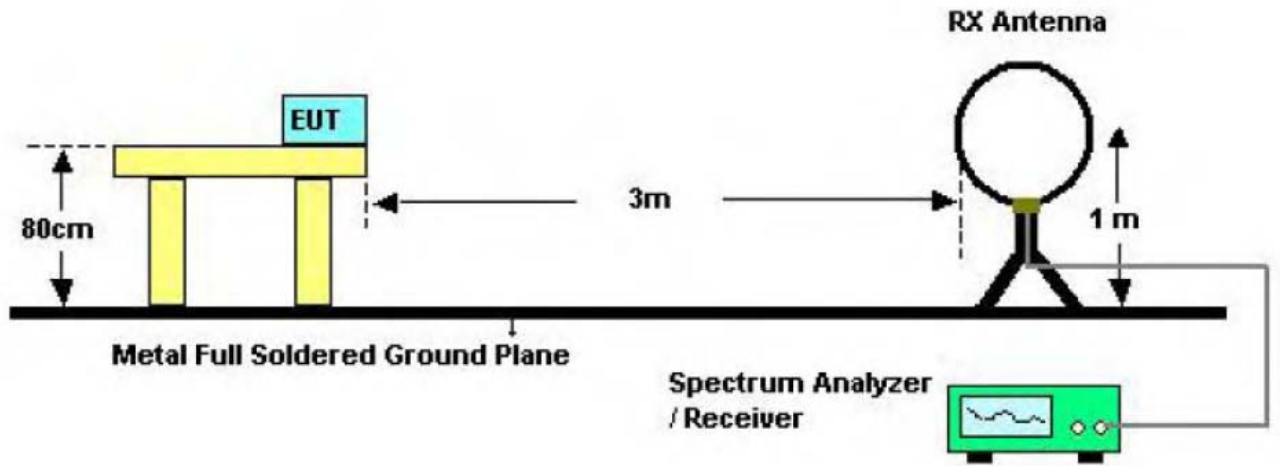

Below 30MHz Test Setup

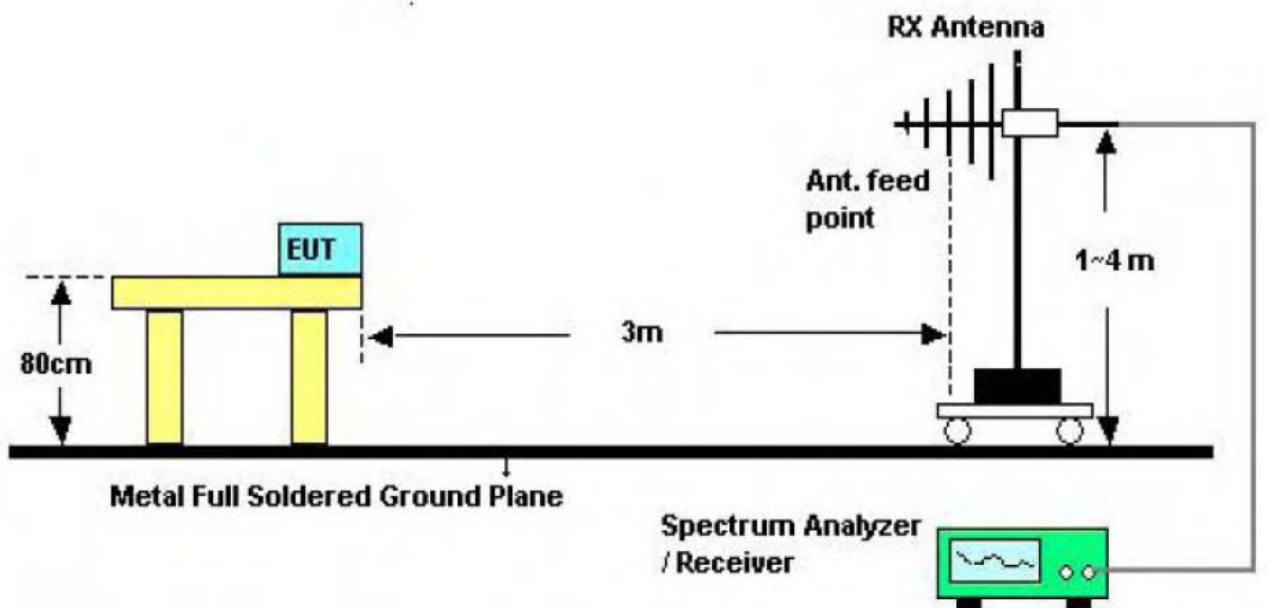

Below 1000MHz Test Setup



Above 1GHz Test Setup

### 5.3 Test Procedure

- (1) The measuring distance of 3m shall be used for measurements at frequency up to 1GHz and above 1 GHz. The EUT was placed on a rotating 0.8m high above ground, the table was rotated 360 degrees to determine the position of the highest radiation.
- (2) Measurements at frequency above 1GHz. The EUT was placed on a rotating 1.5m high above the ground. RF absorbers covered the ground plane with a minimum area of 3.0m by 3.0m between the EUT and measurement receiver antenna. The RF absorber shall not exceed 30cm in high above the conducting floor. The table was rotated 360 degrees to determine the position of the highest radiation.
- (3) The Test antenna shall vary between 1m and 4m, Both Horizontal and Vertical antenna are set to make measurement.
- (4) The initial step in collecting conducted emission data is a spectrum analyzer peak detector mode pre-scanning the measurement frequency range. Significant peaks are then marked and then Quasi Peak detector mode re-measured.
- (5) If the Peak Mode measured value compliance with and lower than Quasi Peak Mode Limit Bellow 1 GHz, the EUT shall be deemed to meet QP Limits and then no additional QP Mode measurement performed. But the Peak Value and average value both need to comply with applicable limit above 1 GHz.
- (6) Testing frequency range below 1GHz the measuring instrument use VBW=120 kHz with Quasi-peak detection.
- (7) Testing frequency range above 1GHz the measuring instrument use RBW=1 MHz and VBW=3 MHz with Peak Detector for Peak Values, and use RBW=1 MHz and VBW=10 Hz with Peak Detector for Average Values.
- (8) For the actual test configuration, please see the test setup photo.



## 5.4 EUT Operating Condition

The Equipment Under Test was set to Continual Transmitting in maximum power.

## 5.5 Test Data

Remark: During testing above 1GHz the measuring instrument use RBW=1 MHz and VBW=3 MHz with Peak Detector for Peak Values, and use RBW=1 MHz and VBW=10 Hz with Peak Detector for Average Values.

Please refer to the Attachment B.

## 6. Restricted Bands Requirement

### 6.1 Test Standard and Limit

#### 6.1.1 Test Standard

FCC Part 15.247(d) FCC Part 15.205

#### 6.1.2 Test Limit

| Restricted Frequency Band (MHz) | Distance Meters(at 3m) |                  |
|---------------------------------|------------------------|------------------|
|                                 | Peak (dBuV/m)          | Average (dBuV/m) |
| 2310 ~2390                      | 74                     | 54               |
| 2483.5 ~2500                    | 74                     | 54               |

### 6.2 Test Setup

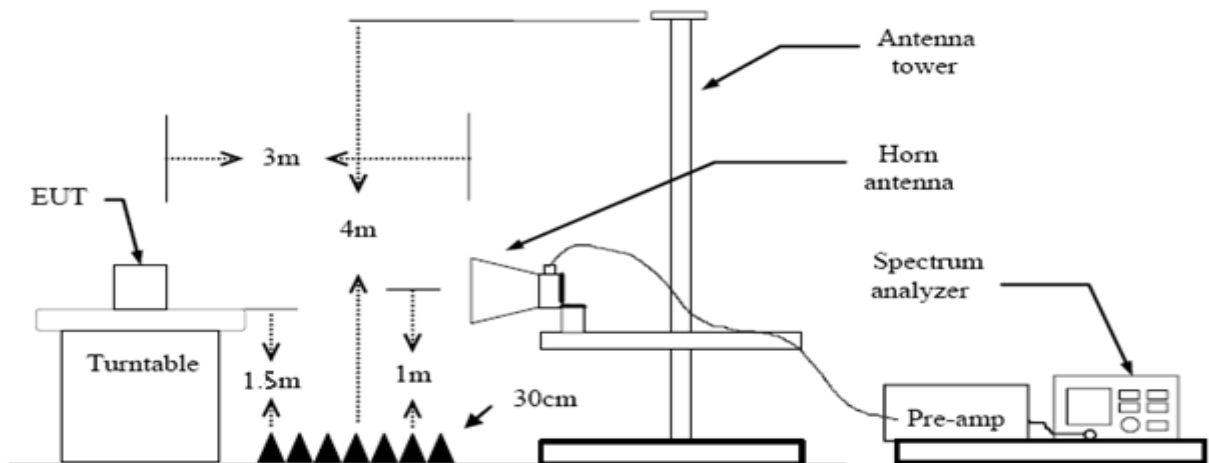

### 6.3 Test Procedure

- (1) The measuring distance of 3m shall be used for measurements at frequency up to 1GHz and above 1 GHz. The EUT was placed on a rotating 0.8m high above ground, the table was rotated 360 degrees to determine the position of the highest radiation.
- (2) Measurements at frequency above 1GHz. The EUT was placed on a rotating 1.5m high above the ground. RF absorbers covered the ground plane with a minimum area of 3.0m by 3.0m between the EUT and measurement receiver antenna. The RF absorber shall not exceed 30cm in high above the conducting floor. The table was rotated 360 degrees to determine the position of the highest radiation.
- (3) The Test antenna shall vary between 1m and 4m, Both Horizontal and Vertical antenna are set to make measurement.
- (4) The initial step in collecting conducted emission data is a spectrum analyzer peak detector

mode pre-scanning the measurement frequency range. Significant peaks are then marked and then Quasi Peak detector mode re-measured.

- (5) If the Peak Mode measured value compliance with and lower than Quasi Peak Mode Limit Bellow 1 GHz, the EUT shall be deemed to meet QP Limits and then no additional QP Mode measurement performed. But the Peak Value and average value both need to comply with applicable limit above 1 GHz.
- (6) Testing frequency range below 1GHz the measuring instrument use VBW=120 kHz with Quasi-peak detection.
- (7) Testing frequency range above 1GHz the measuring instrument use RBW=1 MHz and VBW=3 MHz with Peak Detector for Peak Values, and use RBW=1 MHz and VBW=10 Hz with Peak Detector for Average Values.
- (8) For the actual test configuration, please see the test setup photo.

#### 6.4 EUT Operating Condition

The Equipment Under Test was set to Continual Transmitting in maximum power.

#### 6.5 Test Data

Remark: During testing above 1GHz the measuring instrument use RBW=1 MHz and VBW=3 MHz with Peak Detector for Peak Values, and use RBW=1 MHz and VBW=10 Hz with Peak Detector for Average Values.

Please refer to the Attachment C.

## 7. Bandwidth Test

### 7.1 Test Standard and Limit

#### 7.1.1 Test Standard

FCC Part 15.247 (a)(2)

#### 7.1.2 Test Limit

| FCC Part 15 Subpart C(15.247)/RSS-247 |                                   |                      |
|---------------------------------------|-----------------------------------|----------------------|
| Test Item                             | Limit                             | Frequency Range(MHz) |
| Bandwidth                             | $\geq 500$ KHz<br>(6dB bandwidth) | 2400~2483.5          |

### 7.2 Test Setup

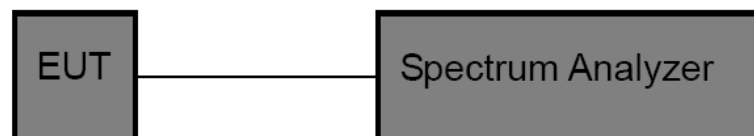

### 7.3 Test Procedure

- (1) The EUT was directly connected to the spectrum analyzer and antenna output port as show in the block diagram above.
- (2) The bandwidth is measured at an amplitude level reduced 6dB from the reference level. The reference level is the level of the highest amplitude signal observed from the transmitter at the fundamental frequency. Once the reference level is established, the equipment is conditioned with typical modulating signal to produce the worst -case (i.e the widest) bandwidth.
- (3) Measure the channel separation the spectrum analyzer was set to Resolution Bandwidth:100 kHz, and Video Bandwidth:300 kHz, Detector: Peak, Sweep Time set auto.

### 7.4 EUT Operating Condition

The EUT was set to continuously transmitting in each mode and low, middle and high channel for the test.

### 7.5 Test Data

Please refer to the Attachment D.

## 8. Peak Output Power Test

### 8.1 Test Standard and Limit

- 8.1.1 Test Standard  
FCC Part 15.247 (b)(3)
- 8.1.2 Test Limit

| FCC Part 15 Subpart C(15.247)/RSS-247 |                  |                      |
|---------------------------------------|------------------|----------------------|
| Test Item                             | Limit            | Frequency Range(MHz) |
| Peak Output Power                     | 1 Watt or 30 dBm | 2400~2483.5          |

### 8.2 Test Setup

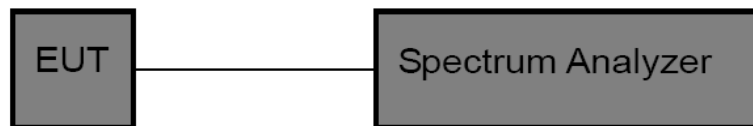

### 8.3 Test Procedure

The EUT was directly connected to the Spectrum Analyzer and antenna output port as show in the block diagram above. The measurement is according to section 9.1.1 of KDB 558074 D01 DTS Meas Guidance v04.

- (1) Set the RBW  $\geq$  DTS Bandwidth
- (2) Set VBW  $\geq 3 \times$  RBW
- (3) Set Span  $\geq 3 \times$  RBW
- (4) Sweep time=auto
- (5) Detector= peak
- (6) Trace mode= maxhold.
- (7) Allow trace to fully stabilize, and then use peak marker function to determine the peak amplitude level.

### 8.4 EUT Operating Condition

The EUT was set to continuously transmitting in the max power during the test.

### 8.5 Test Data

Please refer to the Attachment E.

## 9. Power Spectral Density Test

### 9.1 Test Standard and Limit

#### 9.1.1 Test Standard

FCC Part 15.247 (e)

#### 9.1.2 Test Limit

| FCC Part 15 Subpart C(15.247) |                    |                      |
|-------------------------------|--------------------|----------------------|
| Test Item                     | Limit              | Frequency Range(MHz) |
| Power Spectral Density        | 8dBm(in any 3 kHz) | 2400~2483.5          |

### 9.2 Test Setup

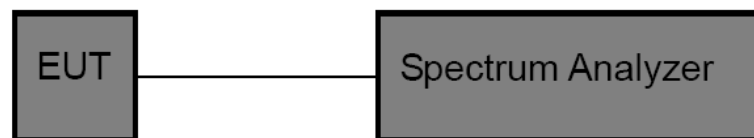

### 9.3 Test Procedure

The EUT was directly connected to the Spectrum Analyzer and antenna output port as show in the block diagram above. The measurement according to section 10.2 of KDB 558074 D01 DTS Meas Guidance v04.

- (1) The EUT was directly connected to the spectrum analyzer and antenna output port as show in the block diagram above.
- (2) Set analyser center frequency to DTS channel center frequency.
- (3) Set the span to 1.5 times the DTS bandwidth.
- (4) Set the RBW to: 3 kHz
- (5) Set the VBW to: 10 kHz
- (6) Detector: peak
- (7) Sweep time: auto
- (8) Allow trace to fully stabilize. Then use the peak marker function to determine the maximum amplitude level.

### 9.4 EUT Operating Condition

The EUT was set to continuously transmitting in each mode and low, Middle and high channel for the test.

### 9.5 Test Data

Please refer to the Attachment F.

## 10. Antenna Requirement

### 10.1 Standard Requirement

#### 10.1.1 Standard

FCC Part 15.203

#### 10.1.2 Requirement

An intentional radiator shall be designed to ensure that no antenna other than that furnished by the responsible party shall be used with the device. The use of a permanently attached antenna or of an antenna that uses a unique coupling to the intentional radiator shall be considered sufficient to comply with the provisions of this Section. The manufacturer may design the unit so that a broken antenna can be replaced by the user, but the use of a standard antenna jack or electrical connector is prohibited.

### 10.2 Antenna Connected Construction

The gains of the antenna used for transmitting is 5dBi, and the antenna de-signed with permanent attachment and no consideration of replacement. Please see the EUT photo for details.

### 10.3 Result

The EUT antenna is Reverse SMA Antenna. It complies with the standard requirement.

| Antenna Type   |
|--|
| <input type="checkbox"/> Permanent attached antenna          |
| <input checked="" type="checkbox"/> Unique connector antenna |
| <input type="checkbox"/> Professional installation antenna   |

### Attachment A-- Conducted Emission Test Data

|               |                             |                    |     |
|---------------|-----------------------------|--------------------|-----|
| Temperature:  | 25°C                        | Relative Humidity: | 55% |
| Test Voltage: | AC 120V/60 Hz               |                    |     |
| Terminal:     | Line                        |                    |     |
| Test Mode:    | BLE Mode 2402 MHz           |                    |     |
| Remark:       | Only worse case is reported |                    |     |

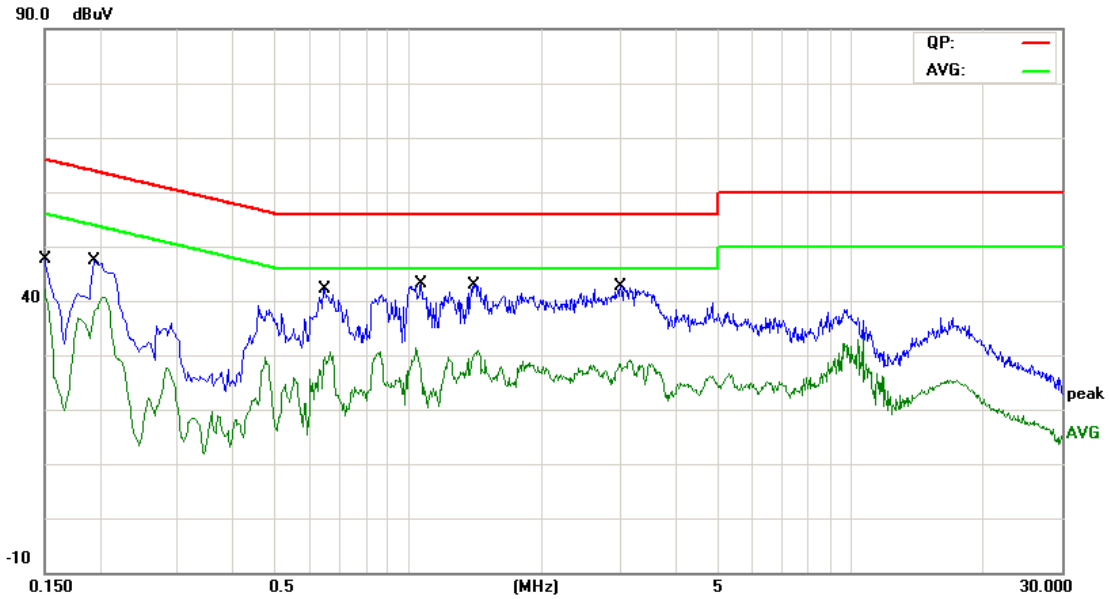

| No. | Mk. | Freq.<br>MHz | Reading<br>Level<br>dBuV | Correct<br>Factor<br>dB | Measure-<br>ment<br>dBuV | Limit<br>dBuV | Over<br>dB | Detector |
|-----|-----|--------------|--------------------------|-------------------------|--------------------------|---------------|------------|----------|
| 1   |     | 0.1500       | 34.93                    | 9.58                    | 44.51                    | 65.99         | -21.48     | QP       |
| 2   | *   | 0.1500       | 32.05                    | 9.58                    | 41.63                    | 55.99         | -14.36     | AVG      |
| 3   |     | 0.1940       | 33.85                    | 9.58                    | 43.43                    | 63.86         | -20.43     | QP       |
| 4   |     | 0.1940       | 21.60                    | 9.58                    | 31.18                    | 53.86         | -22.68     | AVG      |
| 5   |     | 0.6460       | 26.99                    | 9.61                    | 36.60                    | 56.00         | -19.40     | QP       |
| 6   |     | 0.6460       | 16.46                    | 9.61                    | 26.07                    | 46.00         | -19.93     | AVG      |
| 7   |     | 1.0660       | 28.86                    | 9.60                    | 38.46                    | 56.00         | -17.54     | QP       |
| 8   |     | 1.0660       | 17.06                    | 9.60                    | 26.66                    | 46.00         | -19.34     | AVG      |
| 9   |     | 1.4060       | 27.90                    | 9.60                    | 37.50                    | 56.00         | -18.50     | QP       |
| 10  |     | 1.4060       | 18.97                    | 9.60                    | 28.57                    | 46.00         | -17.43     | AVG      |
| 11  |     | 3.0140       | 27.27                    | 9.65                    | 36.92                    | 56.00         | -19.08     | QP       |
| 12  |     | 3.0140       | 18.27                    | 9.65                    | 27.92                    | 46.00         | -18.08     | AVG      |

Emission Level= Read Level+ Correct Factor



|                      |                             |                           |     |
|----------------------|-----------------------------|---------------------------|-----|
| <b>Temperature:</b>  | 25°C                        | <b>Relative Humidity:</b> | 55% |
| <b>Test Voltage:</b> | AC 120V/60 Hz               |                           |     |
| <b>Terminal:</b>     | Neutral                     |                           |     |
| <b>Test Mode:</b>    | BLE Mode 2402 MHz           |                           |     |
| <b>Remark:</b>       | Only worse case is reported |                           |     |

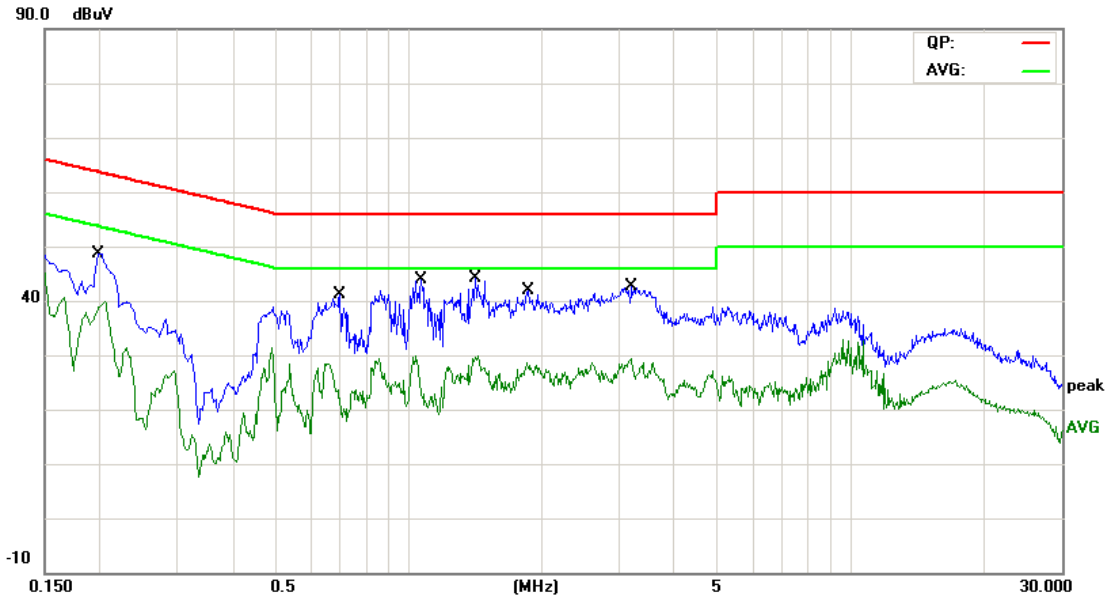

| No. | Mk. | Freq.<br>MHz | Reading<br>Level<br>dBuV | Correct<br>Factor<br>dB | Measure-<br>ment<br>dBuV | Limit<br>dBuV | Over<br>dB | Detector |
|-----|-----|--------------|--------------------------|-------------------------|--------------------------|---------------|------------|----------|
| 1   |     | 0.1980       | 27.80                    | 9.65                    | 37.45                    | 63.69         | -26.24     | QP       |
| 2   |     | 0.1980       | 19.15                    | 9.65                    | 28.80                    | 53.69         | -24.89     | AVG      |
| 3   |     | 0.6980       | 28.59                    | 9.59                    | 38.18                    | 56.00         | -17.82     | QP       |
| 4   |     | 0.6980       | 15.86                    | 9.59                    | 25.45                    | 46.00         | -20.55     | AVG      |
| 5   | *   | 1.0660       | 29.23                    | 9.59                    | 38.82                    | 56.00         | -17.18     | QP       |
| 6   |     | 1.0660       | 17.59                    | 9.59                    | 27.18                    | 46.00         | -18.82     | AVG      |
| 7   |     | 1.4140       | 23.69                    | 9.60                    | 33.29                    | 56.00         | -22.71     | QP       |
| 8   |     | 1.4140       | 14.68                    | 9.60                    | 24.28                    | 46.00         | -21.72     | AVG      |
| 9   |     | 1.8660       | 28.94                    | 9.61                    | 38.55                    | 56.00         | -17.45     | QP       |
| 10  |     | 1.8660       | 18.83                    | 9.61                    | 28.44                    | 46.00         | -17.56     | AVG      |
| 11  |     | 3.1980       | 22.63                    | 9.68                    | 32.31                    | 56.00         | -23.69     | QP       |
| 12  |     | 3.1980       | 14.88                    | 9.68                    | 24.56                    | 46.00         | -21.44     | AVG      |

Emission Level= Read Level+ Correct Factor

|                      |                             |                           |     |
|----------------------|-----------------------------|---------------------------|-----|
| <b>Temperature:</b>  | 25 °C                       | <b>Relative Humidity:</b> | 55% |
| <b>Test Voltage:</b> | AC 240V/60 Hz               |                           |     |
| <b>Terminal:</b>     | Line                        |                           |     |
| <b>Test Mode:</b>    | BLE Mode 2402 MHz           |                           |     |
| <b>Remark:</b>       | Only worse case is reported |                           |     |

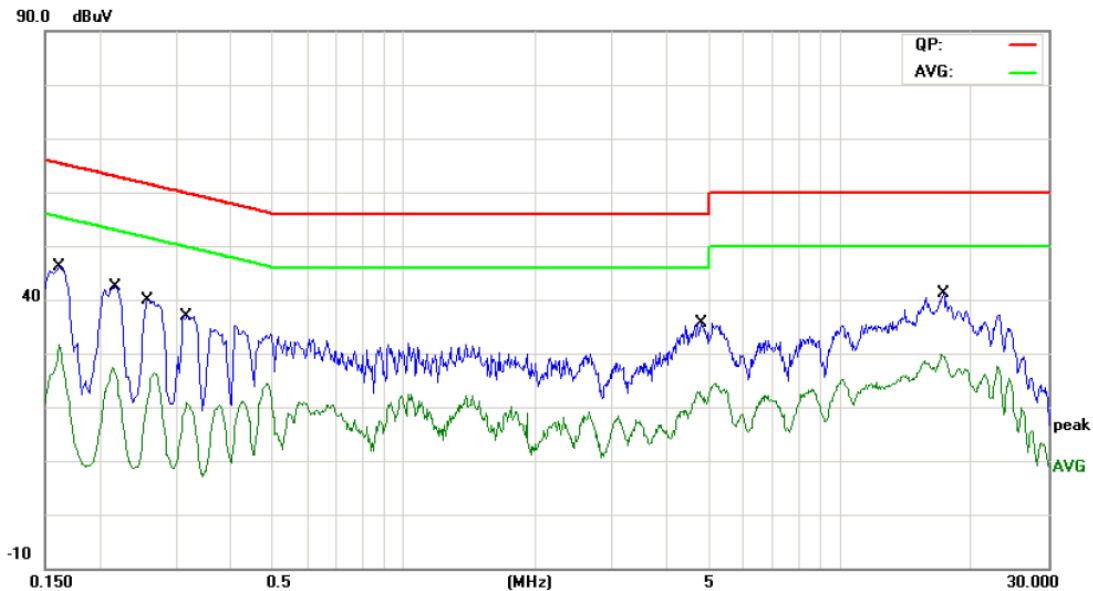

| No. | Mk. | Freq.<br>MHz | Reading<br>Level<br>dBuV | Correct<br>Factor<br>dB | Measure-<br>ment<br>dBuV | Limit<br>dBuV | Over<br>dB | Detector |
|-----|-----|--------------|--------------------------|-------------------------|--------------------------|---------------|------------|----------|
| 1   |     | 0.1620       | 33.87                    | 9.58                    | 43.45                    | 65.36         | -21.91     | QP       |
| 2   |     | 0.1620       | 19.39                    | 9.58                    | 28.97                    | 55.36         | -26.39     | AVG      |
| 3   |     | 0.2180       | 29.01                    | 9.58                    | 38.59                    | 62.89         | -24.30     | QP       |
| 4   |     | 0.2180       | 14.87                    | 9.58                    | 24.45                    | 52.89         | -28.44     | AVG      |
| 5   |     | 0.2580       | 25.48                    | 9.59                    | 35.07                    | 61.49         | -26.42     | QP       |
| 6   |     | 0.2580       | 12.20                    | 9.59                    | 21.79                    | 51.49         | -29.70     | AVG      |
| 7   |     | 0.3180       | 23.25                    | 9.59                    | 32.84                    | 59.76         | -26.92     | QP       |
| 8   |     | 0.3180       | 10.26                    | 9.59                    | 19.85                    | 49.76         | -29.91     | AVG      |
| 9   |     | 4.8140       | 19.73                    | 9.73                    | 29.46                    | 56.00         | -26.54     | QP       |
| 10  |     | 4.8140       | 12.43                    | 9.73                    | 22.16                    | 46.00         | -23.84     | AVG      |
| 11  |     | 17.2620      | 24.44                    | 10.49                   | 34.93                    | 60.00         | -25.07     | QP       |
| 12  | *   | 17.2620      | 17.65                    | 10.49                   | 28.14                    | 50.00         | -21.86     | AVG      |

\*:Maximum data    x:Over limit    !:over margin

**Emission Level= Read Level+ Correct Factor**

|                      |                             |                           |     |
|----------------------|-----------------------------|---------------------------|-----|
| <b>Temperature:</b>  | 25 °C                       | <b>Relative Humidity:</b> | 55% |
| <b>Test Voltage:</b> | AC 240V/60 Hz               |                           |     |
| <b>Terminal:</b>     | Neutral                     |                           |     |
| <b>Test Mode:</b>    | BLE Mode 2402 MHz           |                           |     |
| <b>Remark:</b>       | Only worse case is reported |                           |     |

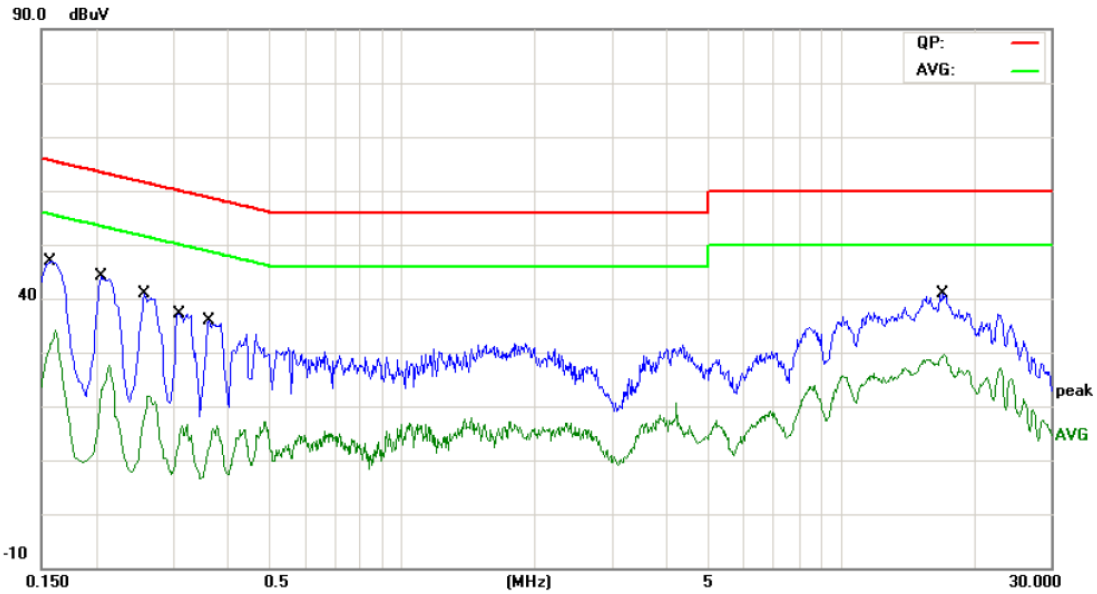

| No. | Mk. | Freq.<br>MHz | Reading<br>Level<br>dBuV | Correct<br>Factor<br>dB | Measure-<br>ment<br>dBuV | Limit<br>dBuV | Over<br>dB | Detector |
|-----|-----|--------------|--------------------------|-------------------------|--------------------------|---------------|------------|----------|
| 1   |     | 0.1580       | 34.45                    | 9.58                    | 44.03                    | 65.56         | -21.53     | QP       |
| 2   |     | 0.1580       | 23.01                    | 9.58                    | 32.59                    | 55.56         | -22.97     | AVG      |
| 3   |     | 0.2060       | 29.06                    | 9.58                    | 38.64                    | 63.36         | -24.72     | QP       |
| 4   |     | 0.2060       | 12.67                    | 9.58                    | 22.25                    | 53.36         | -31.11     | AVG      |
| 5   |     | 0.2580       | 25.95                    | 9.59                    | 35.54                    | 61.49         | -25.95     | QP       |
| 6   |     | 0.2580       | 8.92                     | 9.59                    | 18.51                    | 51.49         | -32.98     | AVG      |
| 7   |     | 0.3100       | 22.53                    | 9.59                    | 32.12                    | 59.97         | -27.85     | QP       |
| 8   |     | 0.3100       | 3.73                     | 9.59                    | 13.32                    | 49.97         | -36.65     | AVG      |
| 9   |     | 0.3620       | 20.26                    | 9.60                    | 29.86                    | 58.68         | -28.82     | QP       |
| 10  |     | 0.3620       | 2.47                     | 9.60                    | 12.07                    | 48.68         | -36.61     | AVG      |
| 11  |     | 17.0780      | 24.53                    | 10.49                   | 35.02                    | 60.00         | -24.98     | QP       |
| 12  | *   | 17.0780      | 18.05                    | 10.49                   | 28.54                    | 50.00         | -21.46     | AVG      |

\*:Maximum data    x:Over limit    !:over margin

**Emission Level= Read Level+ Correct Factor**

Remark: All modes and channels have been tested and only listed BLE link mode that is worst data

# Attachment B-- Radiated Emission Test Data

## 9 KHz~30 MHz

From 9 KHz to 30 MHz: Conclusion: PASS

Note: The amplitude of spurious emissions which are attenuated by more than 20dB  
Below the permissible value has no need to be reported.

## 30MHz~1GHz

|                      |                             |                           |     |
|----------------------|-----------------------------|---------------------------|-----|
| <b>Temperature:</b>  | 25°C                        | <b>Relative Humidity:</b> | 55% |
| <b>Test Voltage:</b> | AC 120V/60HZ                |                           |     |
| <b>Ant. Pol.</b>     | Horizontal                  |                           |     |
| <b>Test Mode:</b>    | BLE TX 2402 Mode            |                           |     |
| <b>Remark:</b>       | Only worse case is reported |                           |     |

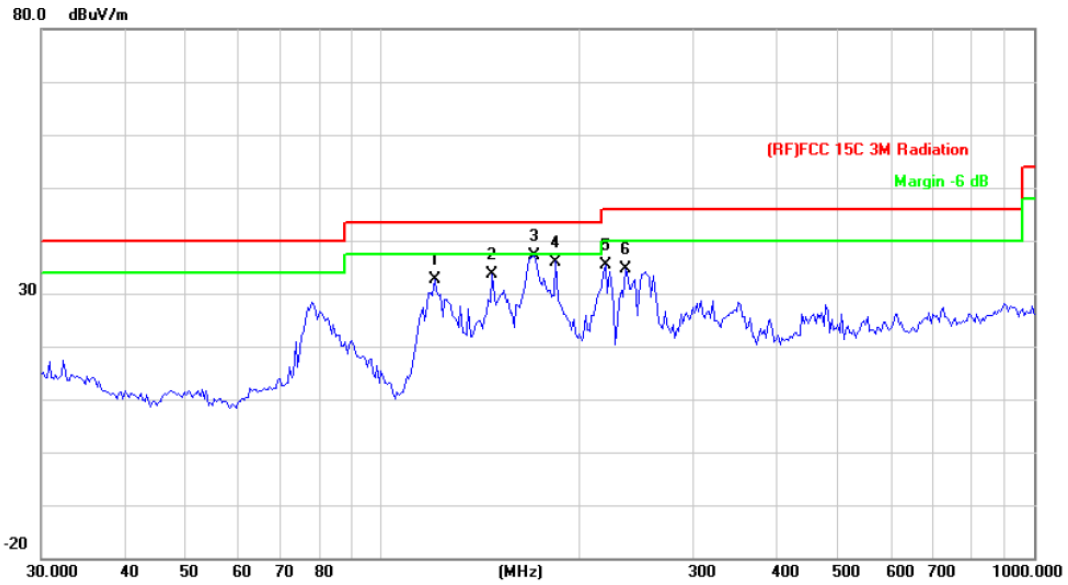

| No. | Mk. | Freq.    | Reading Level | Correct Factor | Measurement | Limit  | Over   | Detector |
|-----|-----|----------|---------------|----------------|-------------|--------|--------|----------|
|     |     | MHz      | dBuV          | dB/m           | dBuV/m      | dBuV/m | dB     |          |
| 1   |     | 120.2766 | 54.86         | -22.30         | 32.56       | 43.50  | -10.94 | QP       |
| 2   |     | 147.4036 | 55.40         | -21.71         | 33.69       | 43.50  | -9.81  | QP       |
| 3   | *   | 170.7923 | 57.63         | -20.49         | 37.14       | 43.50  | -6.36  | QP       |
| 4   |     | 184.4898 | 56.02         | -20.02         | 36.00       | 43.50  | -7.50  | QP       |
| 5   |     | 219.8447 | 54.35         | -18.86         | 35.49       | 46.00  | -10.51 | QP       |
| 6   |     | 235.8163 | 52.58         | -17.97         | 34.61       | 46.00  | -11.39 | QP       |

\*:Maximum data    x:Over limit    !:over margin

**Emission Level= Read Level+ Correct Factor**

|                      |                             |                           |     |
|----------------------|-----------------------------|---------------------------|-----|
| <b>Temperature:</b>  | 25°C                        | <b>Relative Humidity:</b> | 55% |
| <b>Test Voltage:</b> | AC 120V/60HZ                |                           |     |
| <b>Ant. Pol.</b>     | Vertical                    |                           |     |
| <b>Test Mode:</b>    | BLE TX 2402 Mode            |                           |     |
| <b>Remark:</b>       | Only worse case is reported |                           |     |

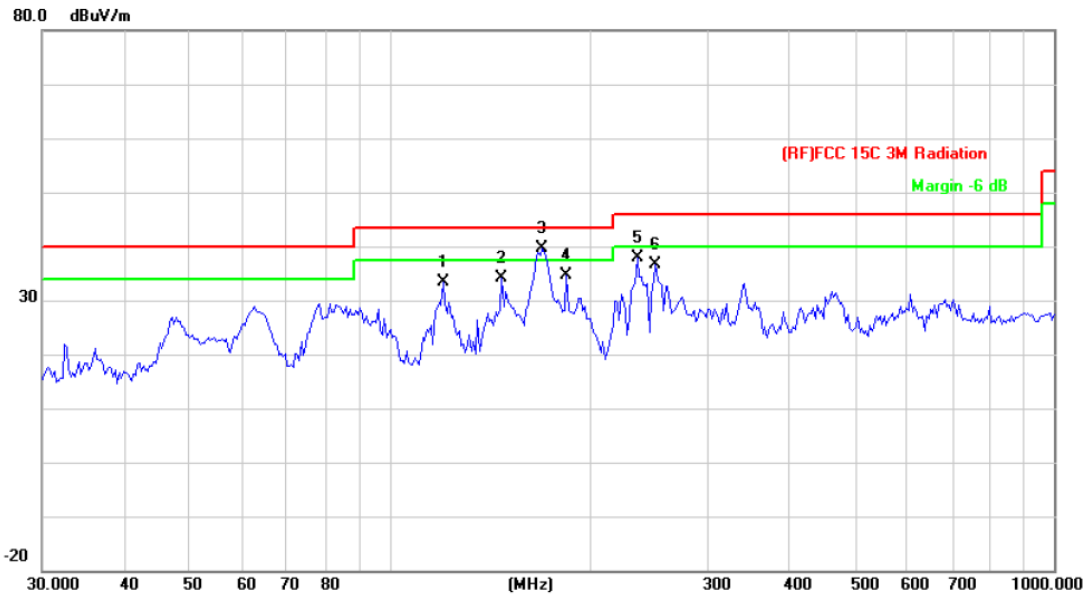

| No. | Mk. | Freq.<br>MHz | Reading<br>Level<br>dBuV | Correct<br>Factor<br>dB/m | Measure-<br>ment<br>dBuV/m | Limit<br>dBuV/m | Over<br>dB | Detector |
|-----|-----|--------------|--------------------------|---------------------------|----------------------------|-----------------|------------|----------|
| 1   |     | 120.2766     | 55.63                    | -22.30                    | 33.33                      | 43.50           | -10.17     | QP       |
| 2   |     | 147.4036     | 55.85                    | -21.71                    | 34.14                      | 43.50           | -9.36      | QP       |
| 3   | *   | 169.5988     | 60.07                    | -20.54                    | 39.53                      | 43.50           | -3.97      | QP       |
| 4   |     | 184.4898     | 54.72                    | -20.02                    | 34.70                      | 43.50           | -8.80      | QP       |
| 5   |     | 235.8163     | 55.88                    | -17.97                    | 37.91                      | 46.00           | -8.09      | QP       |
| 6   |     | 251.1802     | 53.85                    | -17.16                    | 36.69                      | 46.00           | -9.31      | QP       |

\*:Maximum data    x:Over limit    !:over margin

**Emission Level= Read Level+ Correct Factor**

**Above 1GHz**

|                      |  |                           |     |
|----------------------|--|---------------------------|-----|
| <b>Temperature:</b>  | 25°C   | <b>Relative Humidity:</b> | 55% |
| <b>Test Voltage:</b> | AC 120V/60HZ   |                           |     |
| <b>Ant. Pol.</b>     | Horizontal   |                           |     |
| <b>Test Mode:</b>    | BLE Mode TX 2402 MHz   |                           |     |
| <b>Remark:</b>       | No report for the emission which more than 10 dB below the prescribed limit. |                           |     |

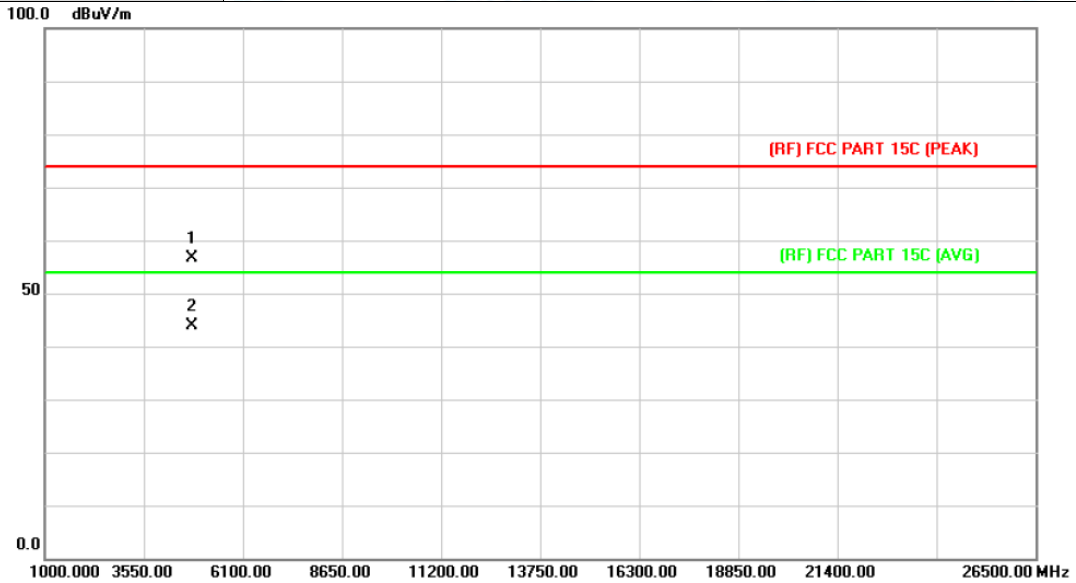

| No. | Mk. | Freq.    | Reading Level | Correct Factor | Measurement | Limit  | Over   |          |
|-----|-----|----------|---------------|----------------|-------------|--------|--------|----------|
|     |     | MHz      | dBuV          | dB/m           | dBuV/m      | dBuV/m | dB     | Detector |
| 1   |     | 4805.500 | 42.09         | 14.44          | 56.53       | 74.00  | -17.47 | peak     |
| 2   | *   | 4805.500 | 29.53         | 14.44          | 43.97       | 54.00  | -10.03 | AVG      |

**Emission Level= Read Level+ Correct Factor**

|                      |  |                           |     |
|----------------------|--|---------------------------|-----|
| <b>Temperature:</b>  | 25°C   | <b>Relative Humidity:</b> | 55% |
| <b>Test Voltage:</b> | AC 120V/60HZ   |                           |     |
| <b>Ant. Pol.</b>     | Vertical   |                           |     |
| <b>Test Mode:</b>    | BLE Mode TX 2402 MHz   |                           |     |
| <b>Remark:</b>       | No report for the emission which more than 10 dB below the prescribed limit. |                           |     |

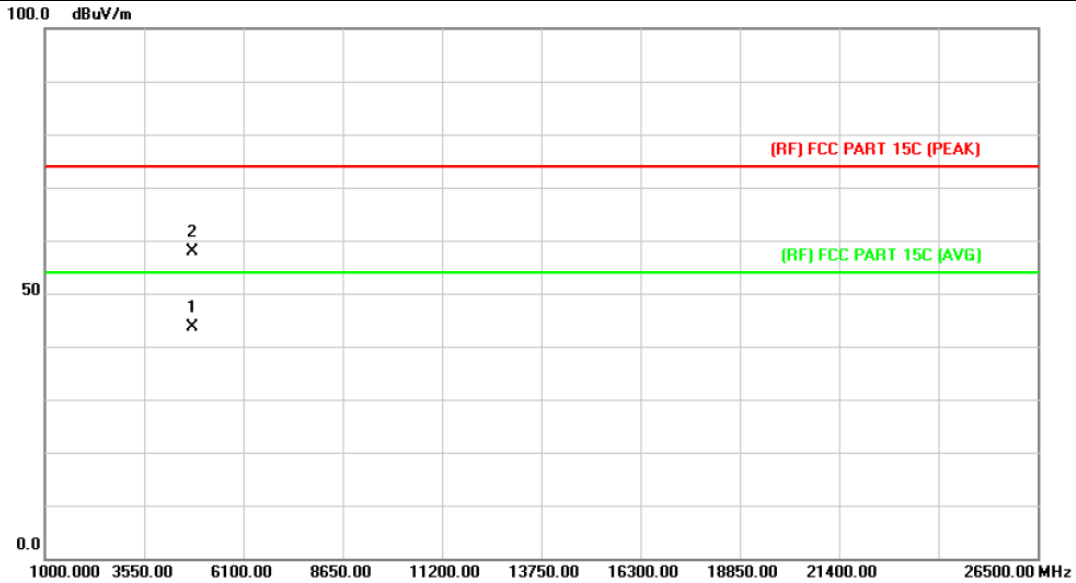

| No. | Mk. | Freq.<br>MHz | Reading<br>Level<br>dBuV | Correct<br>Factor<br>dB/m | Measure-<br>ment<br>dBuV/m | Limit<br>dBuV/m | Over<br>dB | Detector |
|-----|-----|--------------|--------------------------|---------------------------|----------------------------|-----------------|------------|----------|
| 1   | *   | 4802.500     | 29.21                    | 14.42                     | 43.63                      | 54.00           | -10.37     | AVG      |
| 2   |     | 4803.046     | 43.44                    | 14.42                     | 57.86                      | 74.00           | -16.14     | peak     |

Emission Level= Read Level+ Correct Factor

|                      |  |                           |     |
|----------------------|--|---------------------------|-----|
| <b>Temperature:</b>  | 25°C   | <b>Relative Humidity:</b> | 55% |
| <b>Test Voltage:</b> | AC 120V/60HZ   |                           |     |
| <b>Ant. Pol.</b>     | Horizontal   |                           |     |
| <b>Test Mode:</b>    | BLE Mode TX 2442 MHz   |                           |     |
| <b>Remark:</b>       | No report for the emission which more than 10 dB below the prescribed limit. |                           |     |

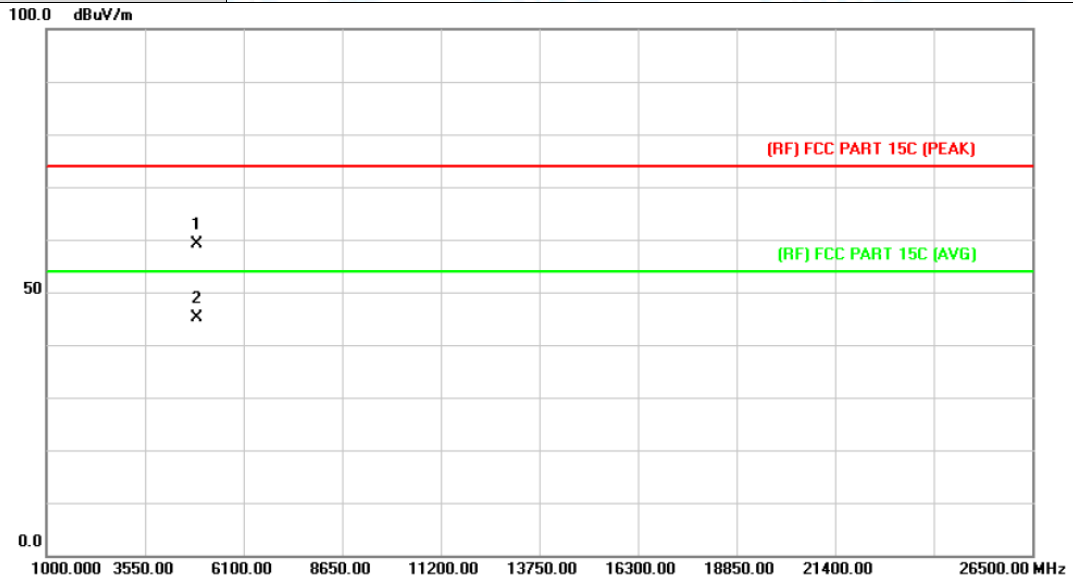

| No. | Mk. | Freq.    | Reading Level | Correct Factor | Measurement | Limit  | Over   | Detector |
|-----|-----|----------|---------------|----------------|-------------|--------|--------|----------|
|     |     | MHz      | dBuV          | dB/m           | dBuV/m      | dBuV/m | dB     |          |
| 1   |     | 4885.332 | 44.22         | 14.93          | 59.15       | 74.00  | -14.85 | peak     |
| 2   | *   | 4885.356 | 30.30         | 14.93          | 45.23       | 54.00  | -8.77  | AVG      |

Emission Level= Read Level+ Correct Factor



|                      |  |                           |     |
|----------------------|--|---------------------------|-----|
| <b>Temperature:</b>  | 25°C   | <b>Relative Humidity:</b> | 55% |
| <b>Test Voltage:</b> | AC 120V/60HZ   |                           |     |
| <b>Ant. Pol.</b>     | Vertical   |                           |     |
| <b>Test Mode:</b>    | BLE Mode TX 2442 MHz   |                           |     |
| <b>Remark:</b>       | No report for the emission which more than 10 dB below the prescribed limit. |                           |     |

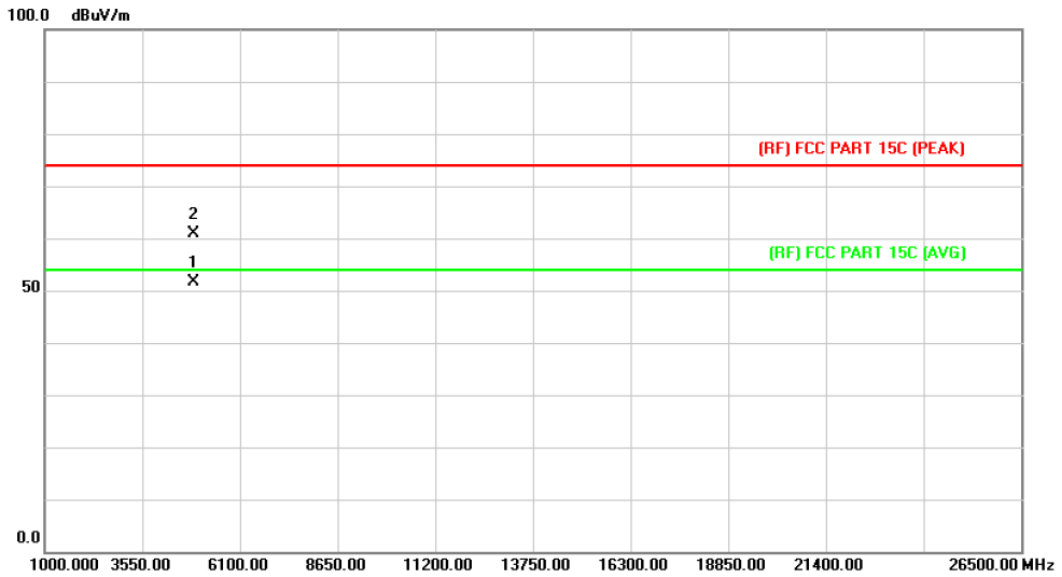

| No. | Mk. | Freq.    | Reading Level | Correct Factor | Measurement | Limit  | Over   | Detector |
|-----|-----|----------|---------------|----------------|-------------|--------|--------|----------|
|     |     | MHz      | dBuV          | dB/m           | dBuV/m      | dBuV/m | dB     |          |
| 1   | *   | 4881.888 | 36.78         | 14.91          | 51.69       | 54.00  | -2.31  | AVG      |
| 2   |     | 4881.908 | 45.95         | 14.91          | 60.86       | 74.00  | -13.14 | peak     |

Emission Level= Read Level+ Correct Factor

|                      |  |                           |     |
|----------------------|--|---------------------------|-----|
| <b>Temperature:</b>  | 25°C   | <b>Relative Humidity:</b> | 55% |
| <b>Test Voltage:</b> | AC 120V/60HZ   |                           |     |
| <b>Ant. Pol.</b>     | Horizontal   |                           |     |
| <b>Test Mode:</b>    | BLE Mode TX 2480 MHz   |                           |     |
| <b>Remark:</b>       | No report for the emission which more than 10 dB below the prescribed limit. |                           |     |

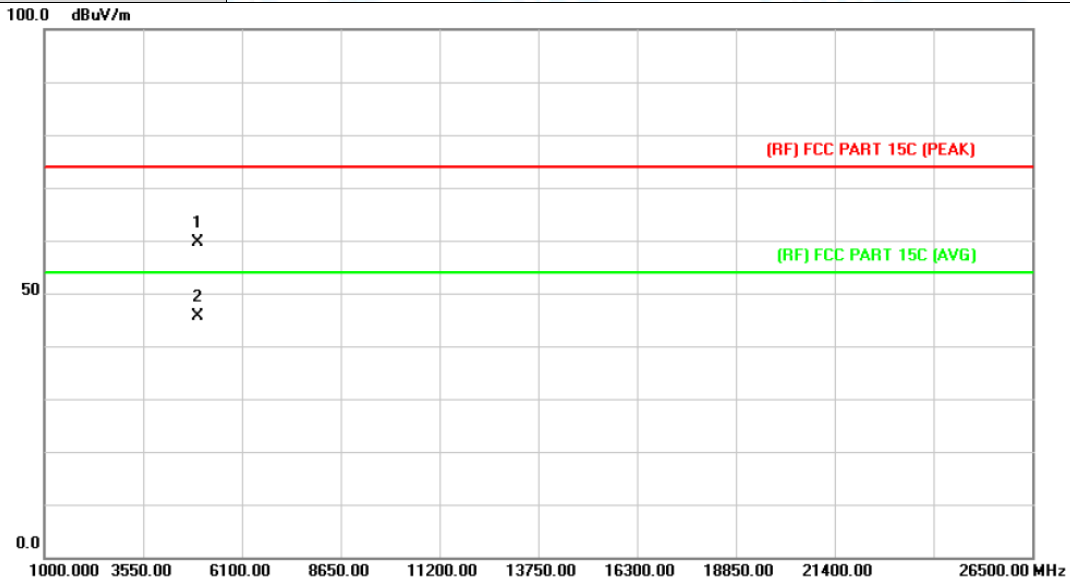

| No. | Mk. | Freq.    | Reading Level | Correct Factor | Measurement | Limit  | Over   | Detector |
|-----|-----|----------|---------------|----------------|-------------|--------|--------|----------|
|     |     | MHz      | dBuV          | dB/m           | dBuV/m      | dBuV/m | dB     |          |
| 1   |     | 4960.150 | 44.34         | 15.39          | 59.73       | 74.00  | -14.27 | peak     |
| 2   | *   | 4960.150 | 30.25         | 15.39          | 45.64       | 54.00  | -8.36  | AVG      |

Emission Level= Read Level+ Correct Factor

|                      |  |                           |     |
|----------------------|--|---------------------------|-----|
| <b>Temperature:</b>  | 25°C   | <b>Relative Humidity:</b> | 55% |
| <b>Test Voltage:</b> | AC 120V/60HZ   |                           |     |
| <b>Ant. Pol.</b>     | Vertical   |                           |     |
| <b>Test Mode:</b>    | BLE Mode TX 2480 MHz   |                           |     |
| <b>Remark:</b>       | No report for the emission which more than 10 dB below the prescribed limit. |                           |     |

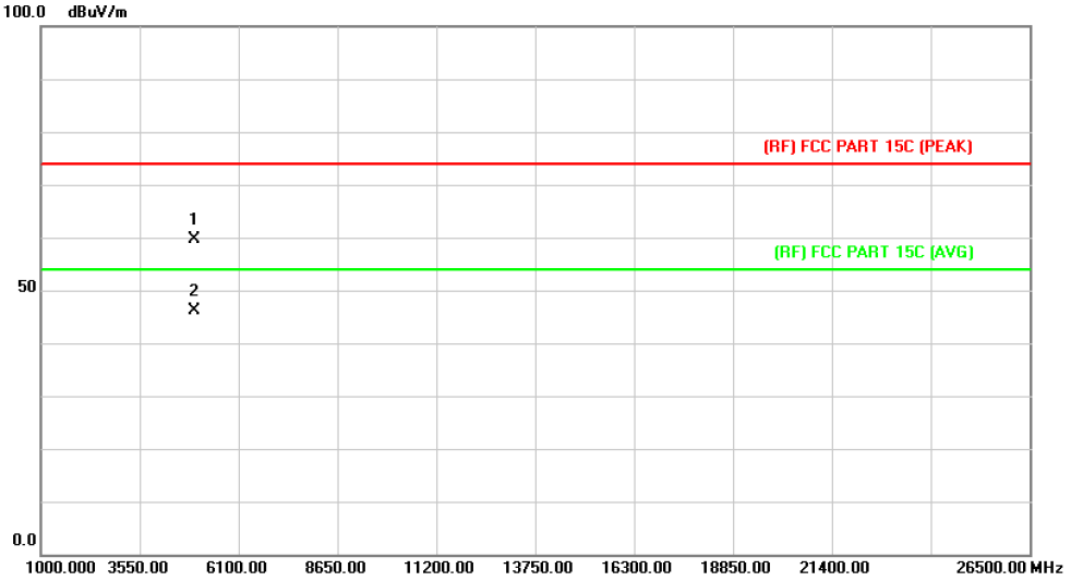

| No. | Mk. | Freq.<br>MHz | Reading<br>Level<br>dBuV | Correct<br>Factor<br>dB/m | Measure-<br>ment<br>dBuV/m | Limit<br>dBuV/m | Over<br>dB | Detector |
|-----|-----|--------------|--------------------------|---------------------------|----------------------------|-----------------|------------|----------|
| 1   |     | 4959.808     | 44.21                    | 15.39                     | 59.60                      | 74.00           | -14.40     | peak     |
| 2   | *   | 4960.474     | 30.64                    | 15.40                     | 46.04                      | 54.00           | -7.96      | AVG      |

Emission Level= Read Level+ Correct Factor

## Attachment C-- Restricted Bands Requirement Test Data

### (1) Radiation Test

|               |                      |                    |     |
|---------------|----------------------|--------------------|-----|
| Temperature:  | 25°C                 | Relative Humidity: | 55% |
| Test Voltage: | AC 120V/60HZ         |                    |     |
| Ant. Pol.     | Horizontal           |                    |     |
| Test Mode:    | BLE Mode TX 2402 MHz |                    |     |
| Remark:       | N/A                  |                    |     |

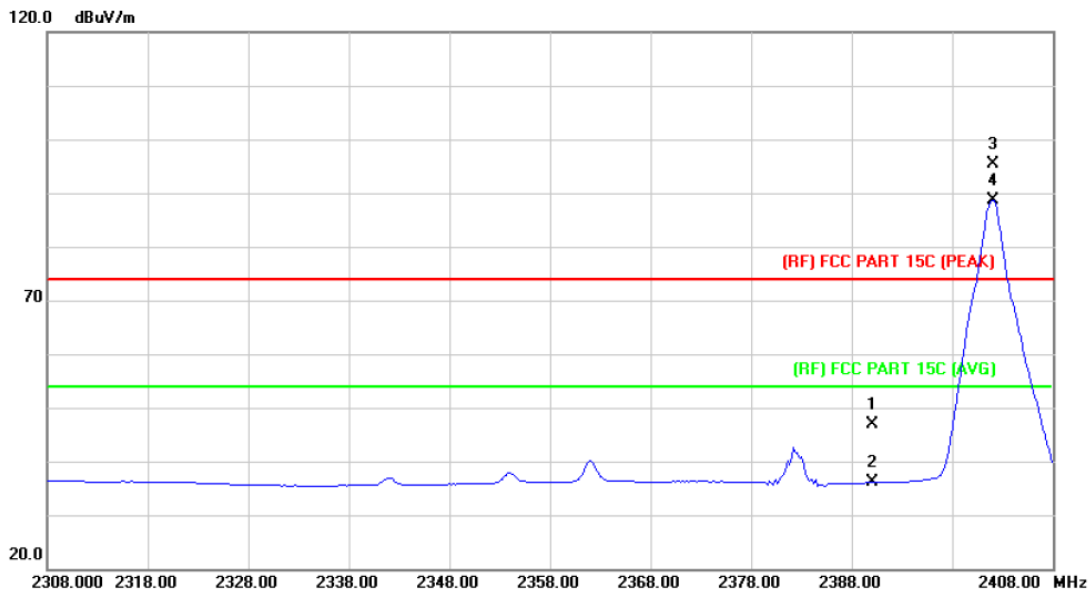

| No. | Mk. | Freq.    | Reading Level | Correct Factor | Measurement | Limit                 | Over   | Detector |
|-----|-----|----------|---------------|----------------|-------------|-----------------------|--------|----------|
|     |     | MHz      | dBuV          | dB/m           | dBuV/m      | dBuV/m                | dB     |          |
| 1   |     | 2390.000 | 44.08         | 2.82           | 46.90       | 74.00                 | -27.10 | peak     |
| 2   |     | 2390.000 | 33.29         | 2.82           | 36.11       | 54.00                 | -17.89 | AVG      |
| 3   | X   | 2402.000 | 92.50         | 2.87           | 95.37       | Fundamental Frequency |        | peak     |
| 4   | *   | 2402.000 | 85.78         | 2.87           | 88.65       | Fundamental Frequency |        | AVG      |

Emission Level= Read Level+ Correct Factor

|                      |                      |                           |     |
|----------------------|----------------------|---------------------------|-----|
| <b>Temperature:</b>  | 25°C                 | <b>Relative Humidity:</b> | 55% |
| <b>Test Voltage:</b> | AC 120V/60HZ         |                           |     |
| <b>Ant. Pol.</b>     | Vertical             |                           |     |
| <b>Test Mode:</b>    | BLE Mode TX 2402 MHz |                           |     |
| <b>Remark:</b>       | N/A                  |                           |     |

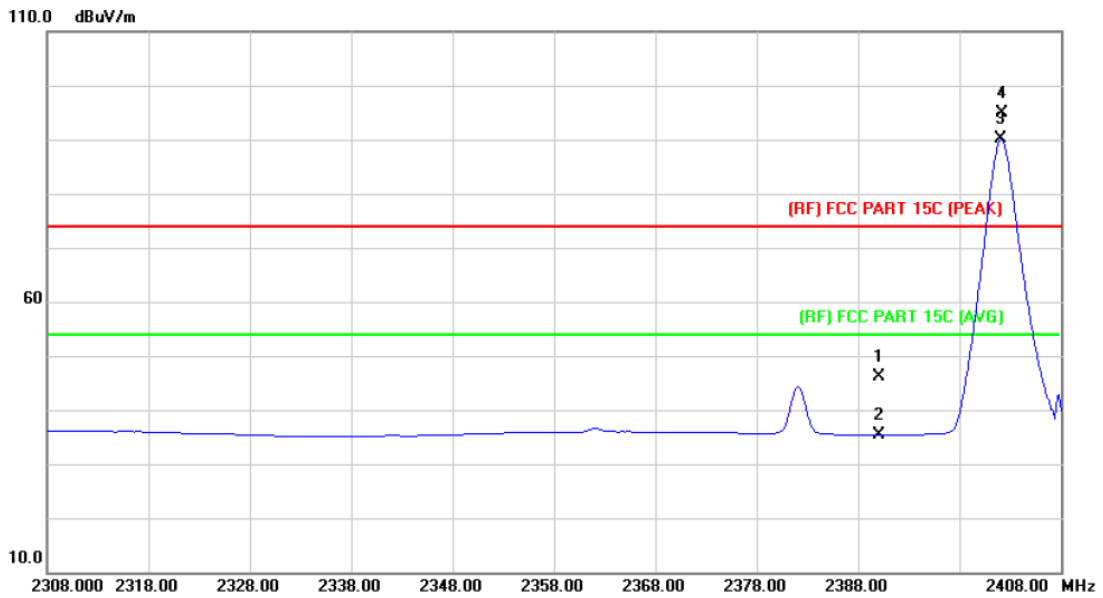

| No. | Mk. | Freq.<br>MHz | Reading<br>Level<br>dBuV | Correct<br>Factor<br>dB/m | Measure-<br>ment<br>dBuV/m | Limit<br>dBuV/m       | Over<br>dB | Detector |
|-----|-----|--------------|--------------------------|---------------------------|----------------------------|-----------------------|------------|----------|
| 1   |     | 2390.000     | 43.29                    | 2.82                      | 46.11                      | 74.00                 | -27.89     | peak     |
| 2   |     | 2390.000     | 32.66                    | 2.82                      | 35.48                      | 54.00                 | -18.52     | AVG      |
| 3   | *   | 2402.000     | 87.16                    | 2.87                      | 90.03                      | Fundamental Frequency |            | AVG      |
| 4   | X   | 2402.200     | 92.06                    | 2.87                      | 94.93                      | Fundamental Frequency |            | peak     |

**Emission Level= Read Level+ Correct Factor**

|                      |                      |                           |     |
|----------------------|----------------------|---------------------------|-----|
| <b>Temperature:</b>  | 25°C                 | <b>Relative Humidity:</b> | 55% |
| <b>Test Voltage:</b> | AC 120V/60HZ         |                           |     |
| <b>Ant. Pol.</b>     | Horizontal           |                           |     |
| <b>Test Mode:</b>    | BLE Mode TX 2480 MHz |                           |     |
| <b>Remark:</b>       | N/A                  |                           |     |

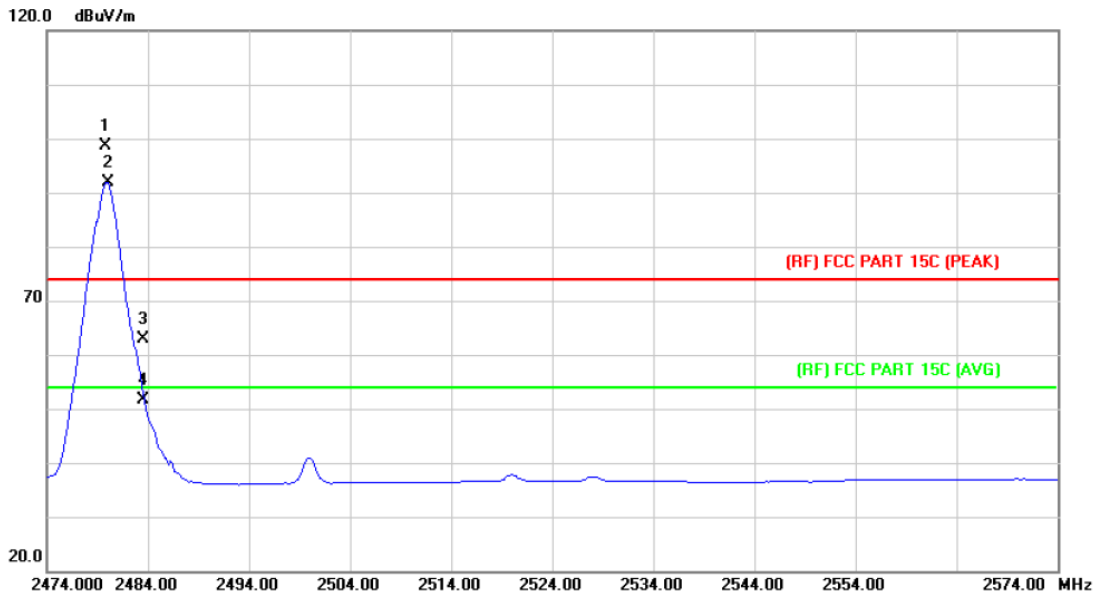

| No. | Mk. | Freq.<br>MHz | Reading<br>Level<br>dBuV | Correct<br>Factor<br>dB/m | Measure-<br>ment<br>dBuV/m | Limit<br>dBuV/m       | Over<br>dB | Detector |
|-----|-----|--------------|--------------------------|---------------------------|----------------------------|-----------------------|------------|----------|
| 1   | X   | 2479.800     | 95.32                    | 3.38                      | 98.70                      | Fundamental Frequency |            | peak     |
| 2   | *   | 2480.000     | 88.58                    | 3.38                      | 91.96                      | Fundamental Frequency |            | AVG      |
| 3   |     | 2483.500     | 59.59                    | 3.41                      | 63.00                      | 74.00                 | -11.00     | peak     |
| 4   |     | 2483.500     | 48.24                    | 3.41                      | 51.65                      | 54.00                 | -2.35      | AVG      |

Emission Level= Read Level+ Correct Factor

|                      |                      |                           |     |
|----------------------|----------------------|---------------------------|-----|
| <b>Temperature:</b>  | 25°C                 | <b>Relative Humidity:</b> | 55% |
| <b>Test Voltage:</b> | AC 120V/60HZ         |                           |     |
| <b>Ant. Pol.</b>     | Vertical             |                           |     |
| <b>Test Mode:</b>    | BLE Mode TX 2480 MHz |                           |     |
| <b>Remark:</b>       | N/A                  |                           |     |

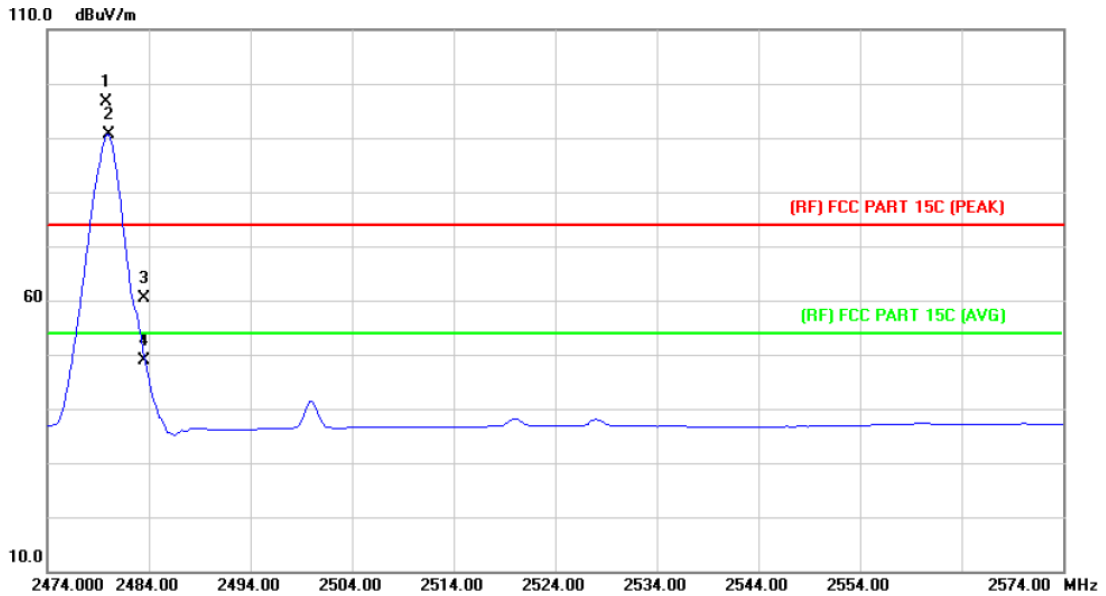

| No. | Mk. | Freq.<br>MHz | Reading<br>Level<br>dBuV | Correct<br>Factor<br>dB/m | Measure-<br>ment<br>dBuV/m | Limit<br>dBuV/m       | Over<br>dB | Detector |
|-----|-----|--------------|--------------------------|---------------------------|----------------------------|-----------------------|------------|----------|
| 1   | X   | 2479.800     | 93.37                    | 3.38                      | 96.75                      | Fundamental Frequency |            | peak     |
| 2   | *   | 2480.000     | 87.17                    | 3.38                      | 90.55                      | Fundamental Frequency |            | AVG      |
| 3   |     | 2483.500     | 57.03                    | 3.41                      | 60.44                      | 74.00                 | -13.56     | peak     |
| 4   |     | 2483.500     | 45.59                    | 3.41                      | 49.00                      | 54.00                 | -5.00      | AVG      |

Emission Level= Read Level+ Correct Factor

**(2) Conducted Test**

|               |  |                    |     |
|---------------|--|--------------------|-----|
| Temperature:  | 25°C   | Relative Humidity: | 55% |
| Test Voltage: | AC 120V/60HZ   |                    |     |
| Test Mode:    | BLE Mode TX 2402MHz / BLE Mode TX 2480MHz              |                    |     |
| Remark:       | The EUT is programed in continuously transmitting mode |                    |     |

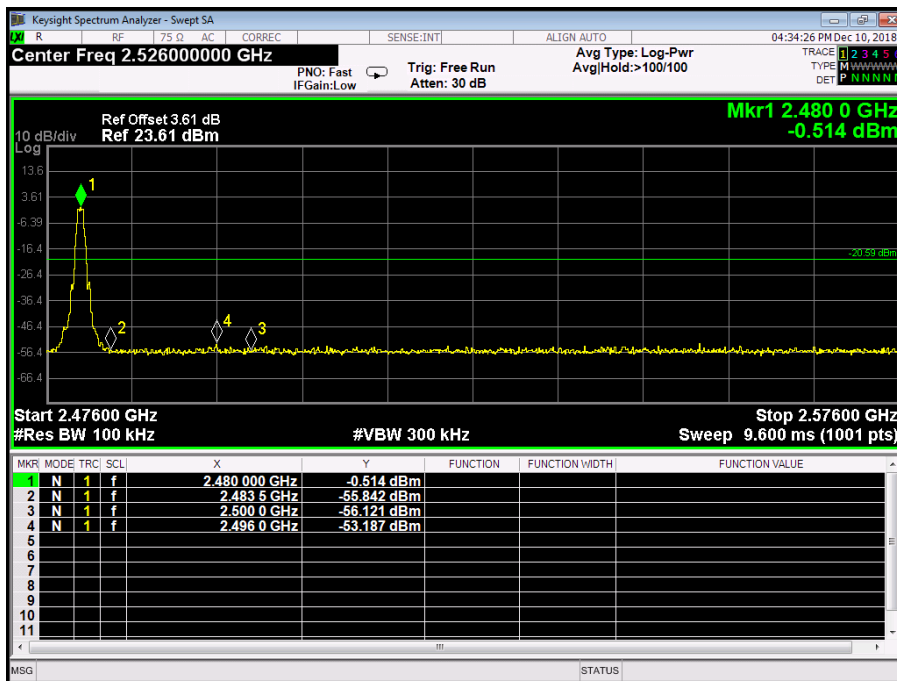
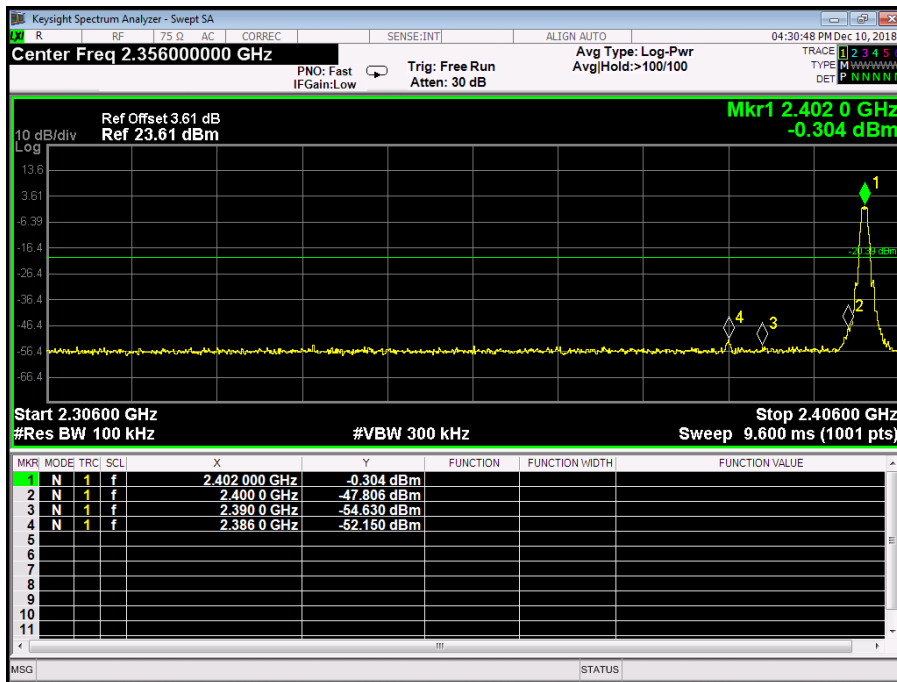



## Attachment D-- Bandwidth Test Data

| <b>Temperature:</b>     | 25°C                | <b>Relative Humidity:</b> | 55%         |
|-------------------------|---------------------|---------------------------|-------------|
| <b>Test Voltage:</b>    | AC 120V/60HZ        |                           |             |
| <b>Test Mode:</b>       | BLE TX Mode         |                           |             |
| Channel frequency (MHz) | 6dB Bandwidth (kHz) | 99% Bandwidth (kHz)       | Limit (kHz) |
| 2402                    | 663.7               | 1070.9                    | ≥500        |
| 2442                    | 666.2               | 1071.4                    |             |
| 2480                    | 660.6               | 1068.4                    |             |
| <b>BLE Mode</b>         |                     |                           |             |
| <b>2402 MHz</b>         |                     |                           |             |

**Occupied Bandwidth**      **Total Power**      2.06 dBm  
**1.0709 MHz**

**Transmit Freq Error**      384 Hz      **% of OBW Power**      99.00 %  
**x dB Bandwidth**      663.7 kHz      **x dB**      -6.00 dB

**BLE Mode**  
**2442 MHz**

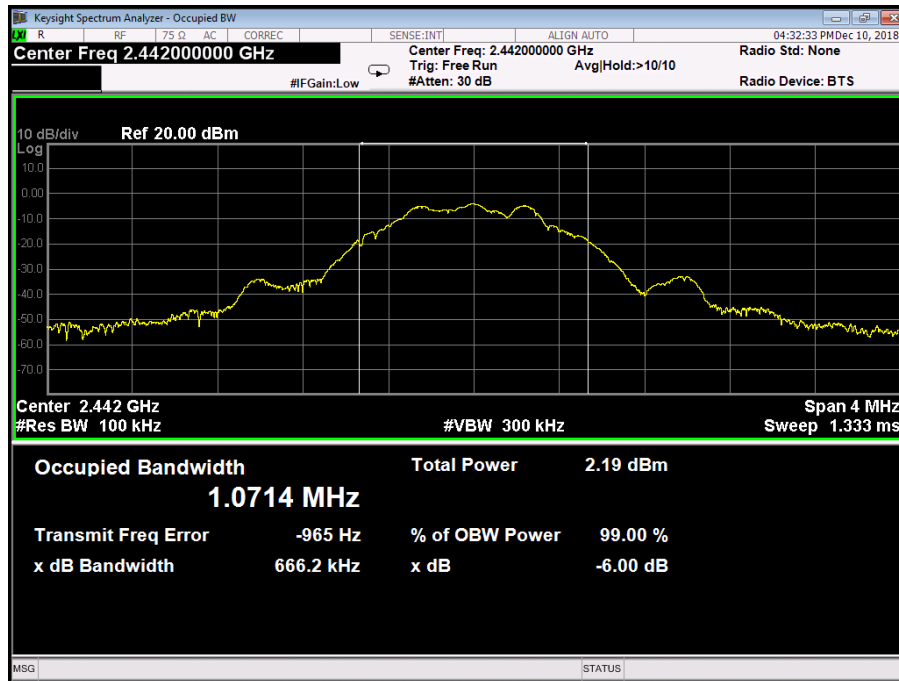

**BLE Mode**  
**2480 MHz**

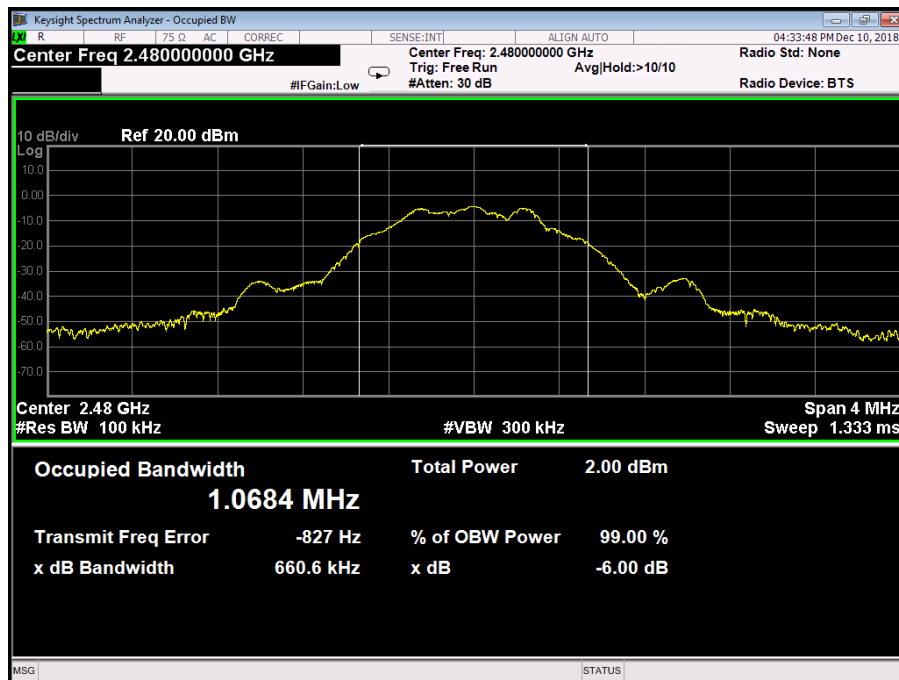

## Attachment E-- Peak Output Power Test Data

|                                |                          |                           |     |
|--------------------------------|--------------------------|---------------------------|-----|
| <b>Temperature:</b>            | 25°C                     | <b>Relative Humidity:</b> | 55% |
| <b>Test Voltage:</b>           | AC 120V/60HZ             |                           |     |
| <b>Test Mode:</b>              | BLE TX Mode              |                           |     |
| <b>Channel frequency (MHz)</b> | <b>Test Result (dBm)</b> | <b>Limit (dBm)</b>        |     |
| 2402                           | 0.099                    | <b>30</b>                 |     |
| 2442                           | -0.055                   |                           |     |
| 2480                           | -0.219                   |                           |     |
| <b>BLE Mode</b>                |                          |                           |     |
| <b>2402 MHz</b>                |                          |                           |     |

Keysight Spectrum Analyzer - Swept SA  
Center Freq 2.40200000 GHz  
PNO: Fast IFGain:Low Trig: Free Run Atten: 30 dB  
Avg Type: Log-Pwr AvgHold: >100/100  
Mkr1 2.402 217 GHz 0.099 dBm  
Ref Offset 3.61 dB Ref 23.61 dBm  
10 dB/div Log  
Center 2.402000 GHz #Res BW 1.0 MHz #VBW 3.0 MHz Span 10.00 MHz Sweep 1.333 ms (10001 pts)

**BLE Mode**

**2442 MHz**

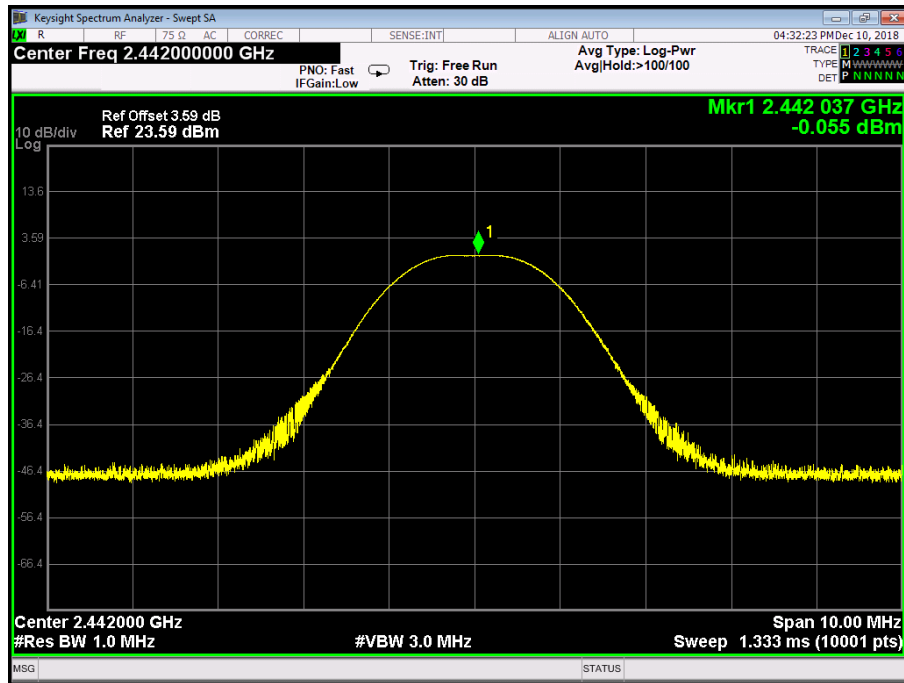

**BLE Mode**

**2480 MHz**

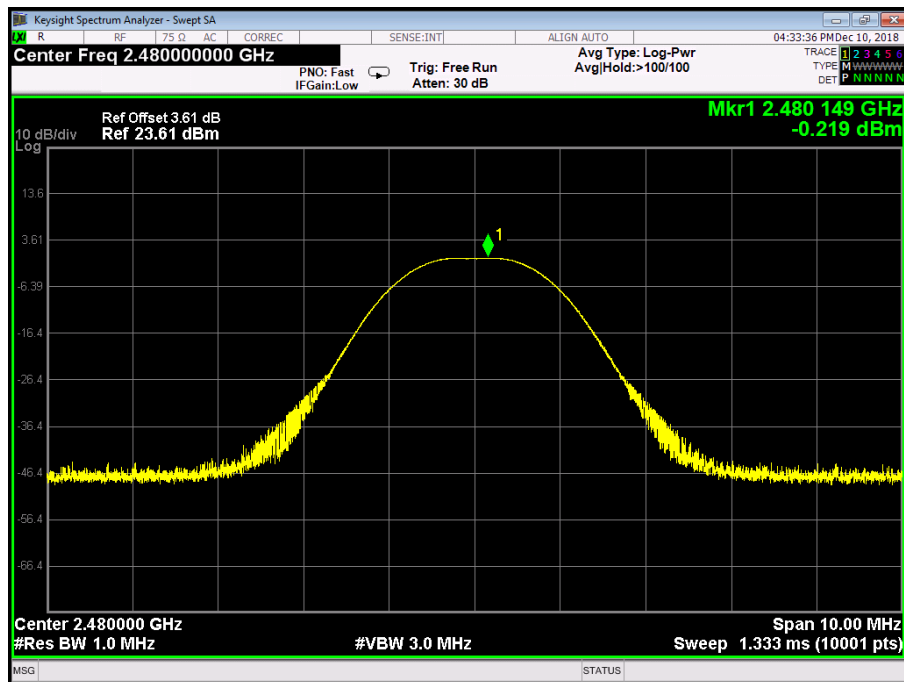

## Attachment F-- Power Spectral Density Test Data

| Temperature:            | 25°C                     | Relative Humidity: | 55%    |
|-------------------------|--------------------------|--------------------|--------|
| Test Voltage:           | AC 120V/60HZ             |                    |        |
| Test Mode:              | BLE TX Mode              |                    |        |
| Channel Frequency (MHz) | Power Density (dBm/3KHz) | Limit (dBm/3KHz)   | Result |
| 2402                    | -15.716                  | 8                  | PASS   |
| 2442                    | -15.826                  |                    |        |
| 2480                    | -15.966                  |                    |        |

**BLE Mode**  
**2402 MHz**

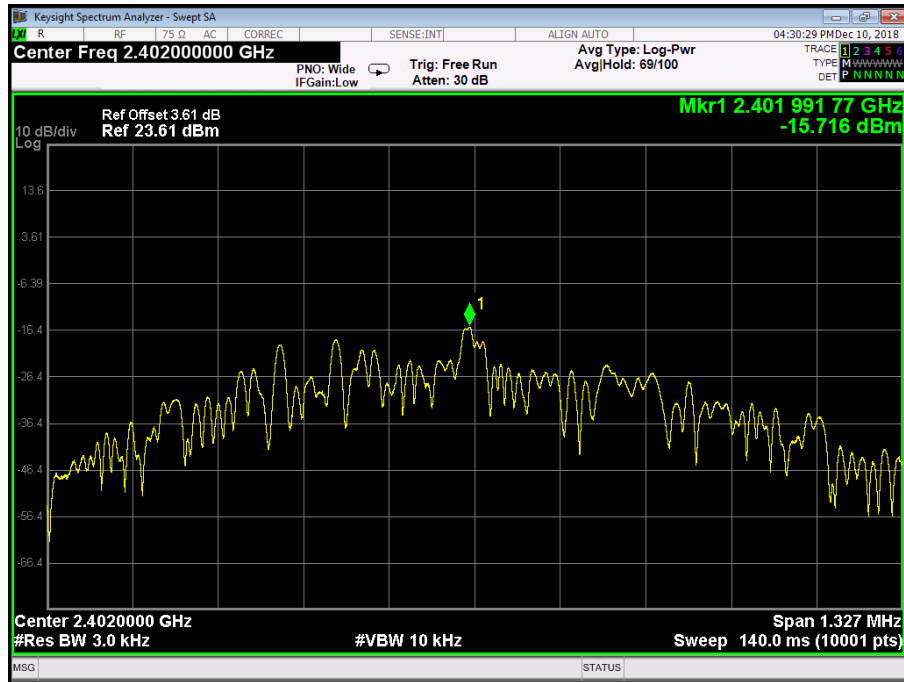

**BLE Mode**  
**2442 MHz**

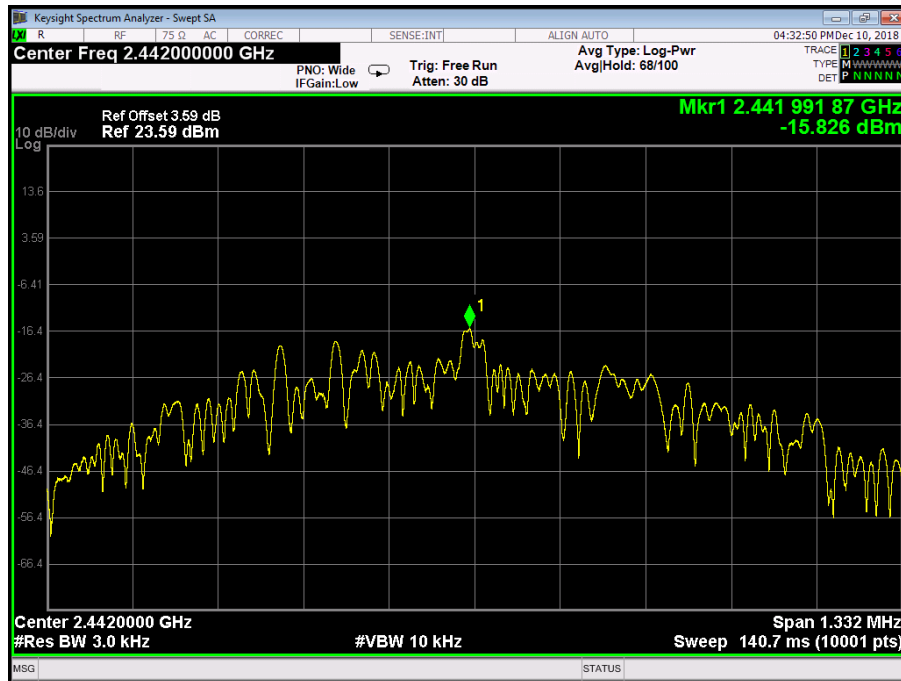

**BLE Mode**  
**2480 MHz**

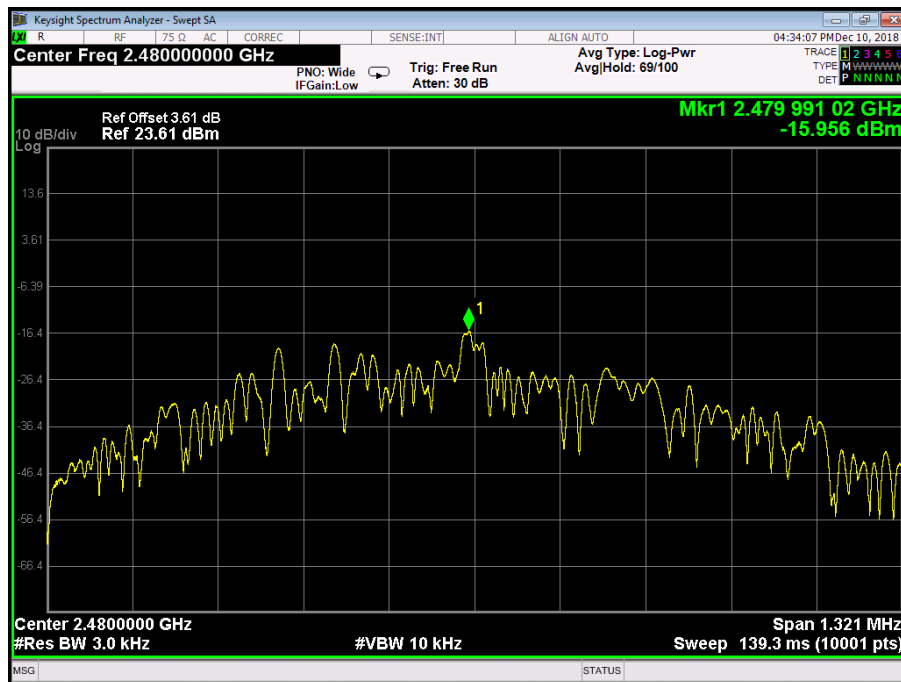

-----END OF REPORT-----