



FCC Part 15C Test Report

FCC ID: 2AL7VRLN4-211W

Product Name:	Network Video Recorder
Trademark:	
Model Name :	RLN4-211W RLN4-211W-S, RLN4-211W-1T, RLN4-211W-2T
Prepared For :	Shenzhen Reo-link Digital Technology Co., Ltd
Address :	11th Floor, Building C, Unisplendour Information Harbour, North High-Tech Zone Nanshan District, Shenzhen 518057, China
Prepared By :	Shenzhen BCTC Testing Co., Ltd.
Address :	BCTC Building & 1-2F, East of B Building, Pengzhou Industrial, Fuyuan 1st Road, Qiaotou Community, Fuyong Street, Bao'an District, Shenzhen, China
Test Date:	Aug. 01, 2019 – Aug. 22, 2019
Date of Report :	Aug. 22, 2019
Report No.:	BCTC-FY190603625-1E

TEST RESULT CERTIFICATION

Applicant's name : Shenzhen Reo-link Digital Technology Co., Ltd
Address : 11th Floor, Building C, Unisplendour Information Harbour,
North High-Tech Zone Nanshan District, Shenzhen 518057,
China
Manufacture's Name..... : SHENZHEN BAICHUAN SECURITY TECHNOLOGY
CO.,LTD
Address : 2-4th Floor, Building 2, YuanLing Industrial Park, ShangWu,
Shiyan Street, Bao' an District, Shenzhen, China

Product description

Product name : Network Video Recorder

Trademark :



Model and/or type reference : RLN4-211W

RLN4-211W-S, RLN4-211W-1T, RLN4-211W-2T

Standards : FCC Part15.247

ANSI C63.10:2013

KDB558074 D01 15.247 Meas Guidance v05r02

This device described above has been tested by BCTC, and the test results show that the equipment under test (EUT) is in compliance with the FCC requirements. And it is applicable only to the tested sample identified in the report.

This report shall not be reproduced except in full, without the written approval of BCTC, this document may be altered or revised by BCTC, personal only, and shall be noted in the revision of the document.

Prepared by(Engineer): Cai Fang Zhong



Reviewer(Supervisor): Eric Yang



Approved(Manager): Zero Zhou



	Page
1 . SUMMARY OF TEST RESULTS	6
1.1 TEST FACILITY	7
1.2 MEASUREMENT UNCERTAINTY	7
2 . GENERAL INFORMATION	8
2.1 GENERAL DESCRIPTION OF EUT	8
2.2 DESCRIPTION OF TEST MODES	9
2.3 BLOCK DIGRAM SHOWING THE CONFIGURATION OF SYSTEM TESTED	10
2.4 DESCRIPTION OF SUPPORT UNITS(CONDUCTED MODE)	10
2.5 EQUIPMENTS LIST FOR ALL TEST ITEMS	11
3 . EMC EMISSION TEST	13
3.1 CONDUCTED EMISSION MEASUREMENT	13
3.1.1 POWER LINE CONDUCTED EMISSION LIMITS	13
3.1.2 TEST PROCEDURE	13
3.1.3 DEVIATION FROM TEST STANDARD	13
3.1.4 TEST SETUP	14
3.1.5 EUT OPERATING CONDITIONS	14
3.1.6 TEST RESULTS	15
3.2 RADIATED EMISSION MEASUREMENT	17
3.2.1 RADIATED EMISSION LIMITS	17
3.2.2 TEST PROCEDURE	17
3.2.3 DEVIATION FROM TEST STANDARD	18
3.2.4 TEST SETUP	18
3.2.5 EUT OPERATING CONDITIONS	19
3.2.6 TEST RESULTS (BETWEEN 9KHZ – 30 MHZ)	20
3.2.7 TEST RESULTS (BETWEEN 30MHZ – 1GHZ)	21
3.2.8 TEST RESULTS (1GHZ~25GHZ)	23
3.3 RADIATED BAND EMISSION MEASUREMENT	27
3.3.1 TEST REQUIREMENT:	27
3.3.2 TEST PROCEDURE	27
3.3.3 DEVIATION FROM TEST STANDARD	28
3.3.4 TEST SETUP	28
3.3.5 EUT OPERATING CONDITIONS	28
4 . POWER SPECTRAL DENSITY TEST	30

Table of Contents	Page
4.1 APPLIED PROCEDURES / LIMIT	30
4.1.1 TEST PROCEDURE	30
4.1.2 DEVIATION FROM STANDARD	30
4.1.3 TEST SETUP	30
4.1.4 EUT OPERATION CONDITIONS	30
4.1.5 TEST RESULTS	31
5 . BANDWIDTH TEST	39
5.1 APPLIED PROCEDURES / LIMIT	39
5.1.1 TEST PROCEDURE	39
5.1.2 DEVIATION FROM STANDARD	39
5.1.3 TEST SETUP	39
5.1.4 EUT OPERATION CONDITIONS	39
5.1.5 TEST RESULTS	40
6 . PEAK OUTPUT POWER TEST	48
6.1 APPLIED PROCEDURES/LIMIT	48
6.1.1 TEST PROCEDURE	48
6.1.2 DEVIATION FROM STANDARD	48
6.1.3 TEST SETUP	48
6.1.4 EUT OPERATION CONDITIONS	48
6.1.5 TEST RESULTS	49
7 . 100 KHZ BANDWIDTH OF FREQUENCY BAND EDGE	50
7.1 APPLICABLE STANDARD	50
7.2 TEST PROCEDURE	50
7.3 DEVIATION FROM STANDARD	50
7.4 TEST SETUP	50
7.5 EUT OPERATION CONDITIONS	50
7.1 TEST RESULTS	50
8 . DUTY CYCLE OF TEST SIGNAL	59
8.1 STANDARD REQUIREMENT	59
8.2 FORMULA:	59
9 . ANTENNA REQUIREMENT	62
9.1 STANDARD REQUIREMENT	62
9.2 EUT ANTENNA	62



Table of Contents

	Page
10 . EUT TEST PHOTO	63
11 . EUT PHOTO	65
APPENDIX-PHOTOGRAPHS OF EUT CONSTRUCTIONAL DETAILS	

1. SUMMARY OF TEST RESULTS

Test procedures according to the technical standards:

FCC Part15 (15.247) , Subpart C			
Standard Section	Test Item	Judgment	Remark
15.207	Conducted Emission	PASS	
15.247 (a)(2)	6dB Bandwidth	PASS	
15.247 (b)	Peak Output Power	PASS	
15.247 (d)	Radiated Spurious Emission	PASS	
15.247 (e)	Power Spectral Density	PASS	
15.205	Restricted Band of Operation	PASS	
15.247 (d)	Band Edge (Out of Band Emissions)	PASS	
15.203	Antenna Requirement	PASS	

NOTE:

(1) "N/A" denotes test is not applicable in this Test Report

1.1 TEST FACILITY

Shenzhen BCTC Testing Co., Ltd.

Add. : BCTC Building & 1-2F, East of B Building, Pengzhou Industrial, Fuyuan 1st Road, Qiaotou Community, Fuyong Street, Bao'an District, Shenzhen, China

FCC Test Firm Registration Number: 712850

IC Registered No.: 23583

1.2 MEASUREMENT UNCERTAINTY

The reported uncertainty of measurement $y \pm U$, where expanded uncertainty U is based on a standard uncertainty multiplied by a coverage factor of $k=2$, providing a level of confidence of approximately **95 %**.

No.	Item	Uncertainty
1	3m chamber Radiated spurious emission(30MHz-1GHz)	U=4.3dB
2	3m chamber Radiated spurious emission(1GHz-18GHz)	U=4.5dB
3	3m chamber Radiated spurious emission(18GHz-40GHz)	U=3.34dB
4	Conducted Adjacent channel power	U=1.38dB
5	Conducted output power uncertainty Above 1G	U=1.576dB
6	Conducted output power uncertainty below 1G	U=1.28dB
7	humidity uncertainty	U=5.3%
8	Temperature uncertainty	U=0.59°C

2. GENERAL INFORMATION

2.1 GENERAL DESCRIPTION OF EUT

Equipment	Network Video Recorder	
Trade Name		
Model Name	RLN4-211W RLN4-211W-S, RLN4-211W-1T, RLN4-211W-2T	
Model Difference	All the model are the same circuit and RF module, except model names.	
Product Description	Operation Frequency:	802.11b/g/n20MHz:2412~2462 MHz 802.11n HT40: 2422-2452MHz
	Modulation Type:	WIFI: OFDM/DSSS
	Bit Rate of Transmitter	802.11b:11/5.5/2/1 Mbps 802.11g:54/48/36/24/18/12/9/6Mbps 802.11n Up to 150Mbps
	Number Of Channel	802.11b/g/n20MHz:11 CH 802.11n40MHz:7 CH
	Antenna Designation:	Please see Note 3.
	Based on the application, features, or specification exhibited in User's Manual, the EUT is considered as an ITE/Computing Device. More details of EUT technical specification, please refer to the User's Manual.	
Channel List	Please refer to the Note 4.	
Ratings	DC 12V	
Adapter	Model: FJ-SW1202000E Input: 100-240V~50/60Hz 0.6A Max. Output: 12.0V 2000mA	
Connecting I/O Port(s)	Please refer to the User's Manual	

Note:

- For a more detailed features description, please refer to the manufacturer's specifications or the User's Manual.
- The Testing software is "adb command", The power level set "--txpwr 14".

3.

Channel List for 802.11b/g/n(20)							
Channel	Frequency (MHz)	Channel	Frequency (MHz)	Channel	Frequency (MHz)	Channel	Frequency (MHz)
01	2412	04	2427	07	2442	10	2457
02	2417	05	2432	08	2447	11	2462
03	2422	06	2437	09	2452		

Channel List for 802.11n(40)							
Channel	Frequency (MHz)	Channel	Frequency (MHz)	Channel	Frequency (MHz)	Channel	Frequency (MHz)
03	2422	05	2432	07	2442	09	2452
04	2427	06	2437	08	2447		

4.

Table for Filed Antenna

Ant.	Brand	Model Name	Antenna Type	Gain (dBi)	NOTE
A	N/A	N/A	R-SMA Antenna	3	non-standard
B	N/A	N/A	R-SMA Antenna	3	non-standard

Antenna A gain: 3dBi, Antenna B gain: 3dBi,

 For MIMO mode for 802.11n20, 802.11n40, Directional gain= $[10\log(GA+ G B)]$ dbi =6.01dbi

2.2 DESCRIPTION OF TEST MODES

Pretest Mode	Description
Mode 1	802.11b CH1/ CH6/ CH11
Mode 2	802.11g CH1/ CH6/ CH11
Mode 3	802.11n20 CH1/ CH6/ CH11
Mode 4	802.11n40 CH3/ CH6/ CH9
Mode 5	Link Mode

Conducted Emission	
Final Test Mode	Description
Mode 5	Link Mode

For Radiated Emission	
Final Test Mode	Description
Mode 1	802.11b CH1/ CH6/ CH11
Mode 2	802.11g CH1/ CH6/ CH11
Mode 3	802.11n20 CH1/ CH6/ CH11
Mode 4	802.11n40 CH3/ CH6/ CH9

Note:

(1) The measurements are performed at all Bit Rate of Transmitter, the worst data was reported.

2.3 BLOCK DIGRAM SHOWING THE CONFIGURATION OF SYSTEM TESTED

Conducted Emission Test

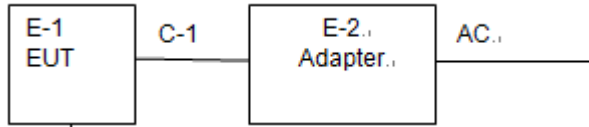

Radiated Spurious Emission

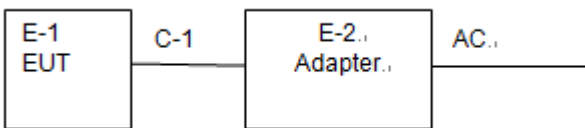

2.4 DESCRIPTION OF SUPPORT UNITS(CONDUCTED MODE)

The EUT has been tested as an independent unit together with other necessary accessories or support units. The following support units or accessories were used to form a representative test configuration during the tests.

Item	Equipment	Mfr/Brand	Model/Type No.	Series No.	Note
E-1	Network Video Recorder	N/A	RLN4-211W	N/A	EUT
E-2	Adapter	N/A	FJ-SW1202000E	N/A	EUT

Item	Shielded Type	Ferrite Core	Length	Note
C-1	NO	NO	1M	DC cableunshielded

Note:

- (1) The support equipment was authorized by Declaration of Confirmation.
- (2) For detachable type I/O cable should be specified the length in cm in 『Length』 column.

2.5 EQUIPMENTS LIST FOR ALL TEST ITEMS

Radiation Test equipment

Item	Equipment	Manufacturer	Type No.	Serial No.	Last calibration	Calibrated until
1	Spectrum Analyzer (9kHz-26.5GHz)	Agilent	E4407B	MY45109572	2019.06.13	2020.06.12
2	Test Receiver (9kHz-7GHz)	R&S	ESR7	101154	2019.06.13	2020.06.12
3	Bilog Antenna (30MHz-3GHz)	SCHWARZBE CK	VULB9163	VULB9163-94 2	2019.06.22	2020.06.21
4	Horn Antenna (1GHz-18GHz)	SCHWARZBE CK	BBHA9120D	1541	2019.06.22	2020.06.21
5	Horn Antenna (18GHz-40GHz)	SCHWARZBE CK	BBHA9170	822	2019.06.22	2020.06.21
6	Amplifier (9KHz-6GHz)	SCHWARZBE CK	BBV9744	9744-0037	2019.06.25	2020.06.24
7	Amplifier (0.5GHz-18GHz)	SCHWARZBE CK	BBV9718	9718-309	2019.06.25	2020.06.24
8	Amplifier (18GHz-40GHz)	MITEQ	TTA1840-35- HG	2034381	2019.06.17	2020.06.16
9	Loop Antenna (9KHz-30MHz)	SCHWARZBE CK	FMZB1519B	014	2019.07.02	2020.07.01
10	RF cables1 (9kHz-30MHz)	Huber+Suhnar	9kHz-30MHz	B1702988-000 8	2019.06.25	2020.06.24
11	RF cables2 (30MHz-1GHz)	Huber+Suhnar	30MHz-1GHz	1486150	2019.06.25	2020.06.24
12	RF cables3 (1GHz-40GHz)	Huber+Suhnar	1GHz-40GHz	1607106	2019.06.25	2020.06.24
13	Power Metter	Keysight	E4419	\	2019.06.17	2020.06.16
14	Power Sensor (AV)	Keysight	E9 300A	\	2019.06.17	2020.06.16
15	Spectrum Analyzer 20kHz-26.5GHz	KEYSIGHT	N9020A	MY49100060	2019.06.13	2020.06.12
16	Spectrum Analyzer 9kHz-40GHz	R&S	FSP40	100363	2019.06.13	2020.06.12
17	D.C. Power Supply	LongWei	TPR-6405D	\	\	\
18	Software	Frad	EZ-EMC	FA-03A2 RE	\	\



Conduction Test equipment

Item	Equipment	Manufacturer	Type No.	Serial No.	Last calibration	Calibrated until
1	Test Receiver	R&S	ESR3	102075	2019.06.13	2020.06.12
2	LISN	SCHWARZBEC K	NSLK8127	8127739	2019.06.13	2020.06.12
3	LISN	R&S	ENV216	101375	2019.06.13	2020.06.12
4	RF cables	Huber+Suhnar	9kHz-30MHz	B1702988-00 08	2019.06.25	2020.06.24
5	Software	Frad	EZ-EMC	EMC-CON 3A1	\	\

3. EMC EMISSION TEST

3.1 CONDUCTED EMISSION MEASUREMENT

3.1.1 POWER LINE CONDUCTED EMISSION Limits (Frequency Range 150KHz-30MHz)

FREQUENCY (MHz)	Limit (dBuV)		Standard
	Quasi-peak	Average	
0.15 -0.5	66 - 56 *	56 - 46 *	FCC
0.50 -5.0	56.00	46.00	FCC
5.0 -30.0	60.00	50.00	FCC

Note:

- (1) The tighter limit applies at the band edges.
- (2) The limit of " * " marked band means the limitation decreases linearly with the logarithm of the frequency in the range.

The following table is the setting of the receiver

Receiver Parameters	Setting
Attenuation	10 dB
Start Frequency	0.15 MHz
Stop Frequency	30 MHz
IF Bandwidth	9 kHz

3.1.2 TEST PROCEDURE

- a. The EUT was placed 0.8 meters from the horizontal ground plane with EUT being connected to the power mains through a line impedance stabilization network (LISN). All other support equipments powered from additional LISN(s). The LISN provide 50 Ohm/ 50uH of coupling impedance for the measuring instrument.
- b. Interconnecting cables that hang closer than 40 cm to the ground plane shall be folded back and forth in the center forming a bundle 30 to 40 cm long.
- c. I/O cables that are not connected to a peripheral shall be bundled in the center. The end of the cable may be terminated, if required, using the correct terminating impedance. The overall length shall not exceed 1 m.
- d. LISN at least 80 cm from nearest part of EUT chassis.
- e. For the actual test configuration, please refer to the related Item –EUT Test Photos.

3.1.3 DEVIATION FROM TEST STANDARD

No deviation

3.1.4 TEST SETUP

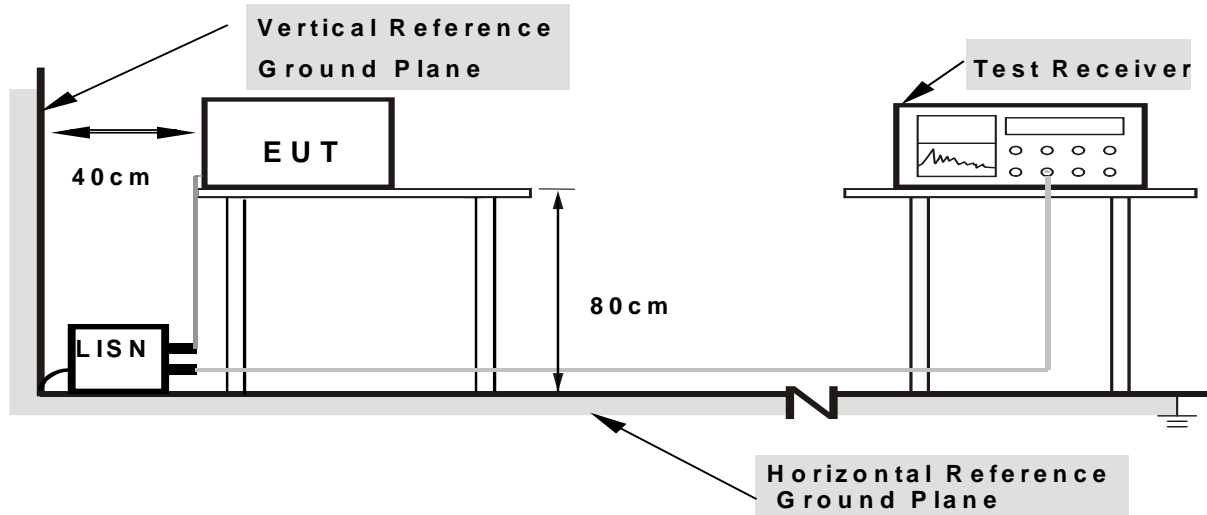

Note: 1.Support units were connected to second LISN.

2.Both of LISNs (AMN) are 80 cm from EUT and at least 80 from other units and other metal planes

3.1.5 EUT OPERATING CONDITIONS

The EUT was configured for testing in a typical fashion (as a customer would normally use it). The EUT has been programmed to continuously transmit during test. This operating condition was tested and used to collect the included data.

We pretest AC 120V and AC 240V, the worst voltage was AC 120V and the data recording in the report.

3.1.6 TEST RESULTS

Temperature :	26 °C	Relative Humidity :	54%
Pressure :	101kPa	Phase :	L
Test Voltage :	AC 120V/60Hz	Test Mode :	Mode 5

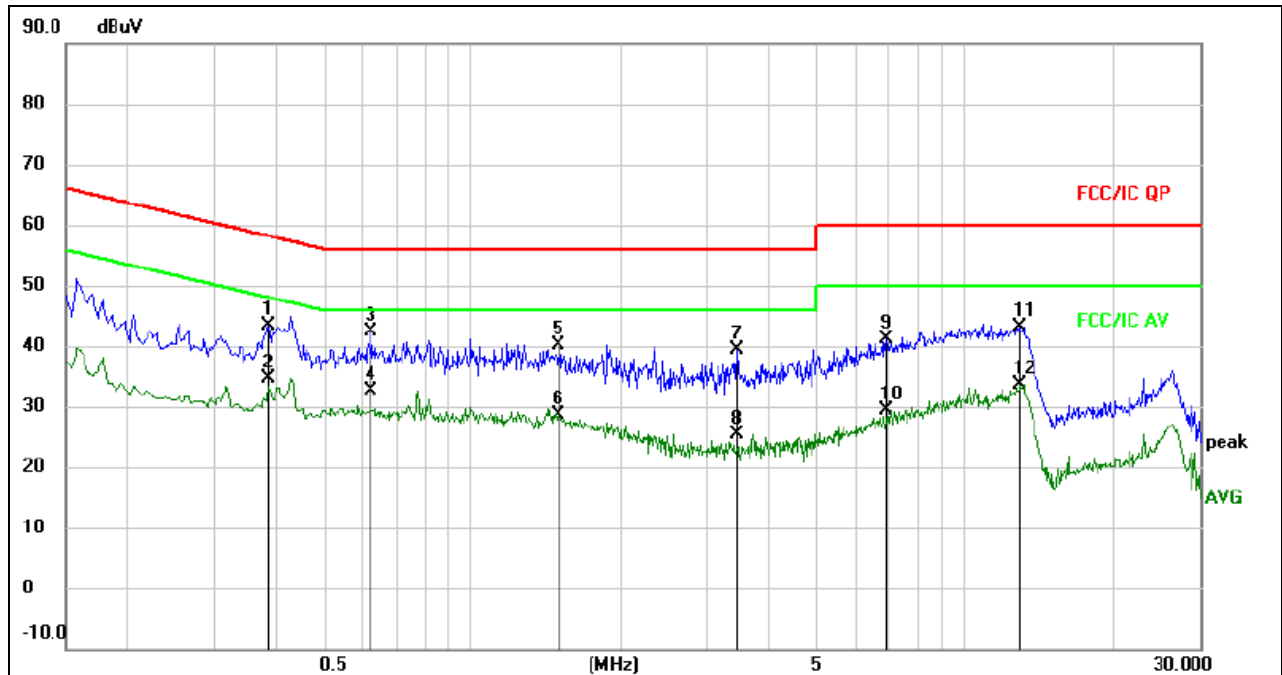

Remark:

1. All readings are Quasi-Peak and Average values.
2. Factor = Insertion Loss + Cable Loss.

No.	Mk.	Freq. MHz	Reading Level dBuV	Correct Factor	Measure- ment dBuV	Limit dBuV	Over dB	Detector	Comment
1		0.3860	23.94	19.51	43.45	58.15	-14.70	QP	
2		0.3860	15.02	19.51	34.53	48.15	-13.62	AVG	
3		0.6260	22.42	19.91	42.33	56.00	-13.67	QP	
4	*	0.6260	12.80	19.91	32.71	46.00	-13.29	AVG	
5		1.5020	20.54	19.58	40.12	56.00	-15.88	QP	
6		1.5020	9.01	19.58	28.59	46.00	-17.41	AVG	
7		3.4420	19.57	19.69	39.26	56.00	-16.74	QP	
8		3.4420	5.73	19.69	25.42	46.00	-20.58	AVG	
9		6.9300	21.47	19.72	41.19	60.00	-18.81	QP	
10		6.9300	9.55	19.72	29.27	50.00	-20.73	AVG	
11		12.9140	23.50	19.70	43.20	60.00	-16.80	QP	
12		12.9140	13.84	19.70	33.54	50.00	-16.46	AVG	



Temperature :	26 °C	Relative Humidity :	54%
Pressure :	101kPa	Phase :	N
Test Voltage :	AC 120V/60Hz	Test Mode :	Mode 5

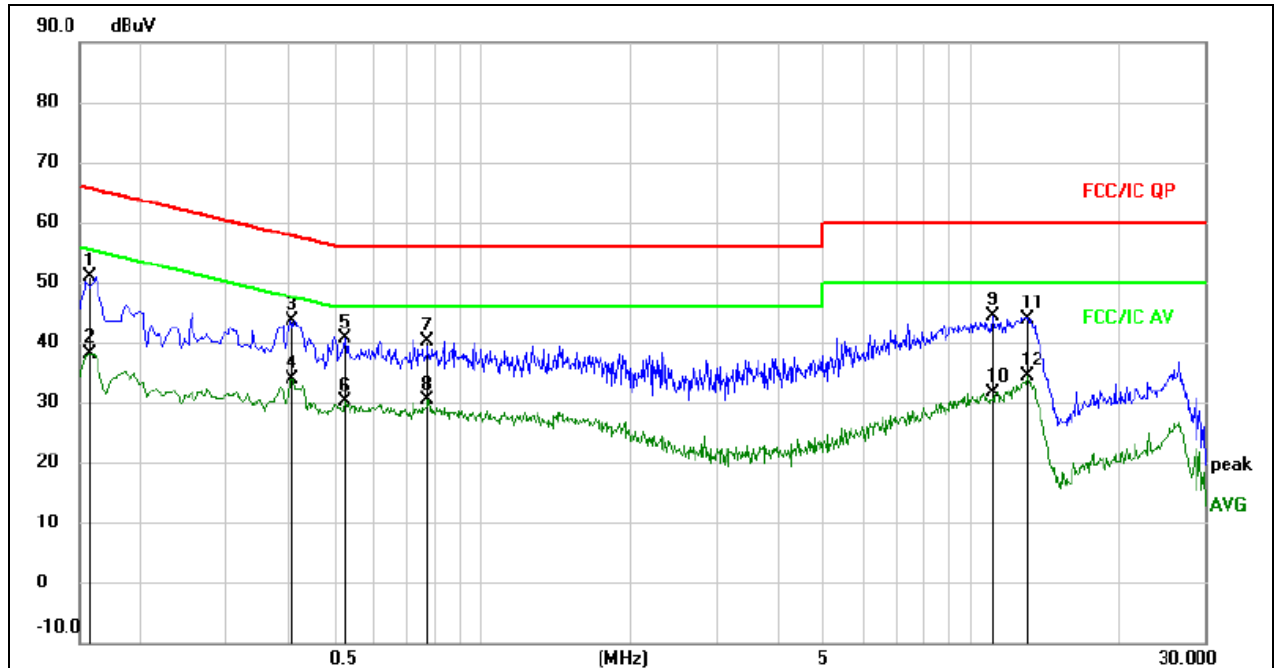

Remark:

1. All readings are Quasi-Peak and Average values.
2. Factor = Insertion Loss + Cable Loss.

No.	Mk.	Freq. MHz	Reading Level dBuV	Correct Factor	Measure- ment dBuV	Limit dBuV	Over dB	Detector	Comment
1		0.1580	31.30	19.51	50.81	65.57	-14.76	QP	
2		0.1580	18.64	19.51	38.15	55.57	-17.42	AVG	
3		0.4100	24.06	19.51	43.57	57.65	-14.08	QP	
4	*	0.4100	14.48	19.51	33.99	47.65	-13.66	AVG	
5		0.5220	21.01	19.68	40.69	56.00	-15.31	QP	
6		0.5220	10.44	19.68	30.12	46.00	-15.88	AVG	
7		0.7740	20.42	19.63	40.05	56.00	-15.95	QP	
8		0.7740	10.85	19.63	30.48	46.00	-15.52	AVG	
9		11.0740	24.61	19.69	44.30	60.00	-15.70	QP	
10		11.0740	11.90	19.69	31.59	50.00	-18.41	AVG	
11		13.0460	24.06	19.70	43.76	60.00	-16.24	QP	
12		13.0460	14.71	19.70	34.41	50.00	-15.59	AVG	

3.2 RADIATED EMISSION MEASUREMENT

3.2.1 RADIATED EMISSION LIMITS (Frequency Range 9kHz-1000MHz)

20dBc in any 100 kHz bandwidth outside the operating frequency band. In case the emission fall within the restricted band specified on 15.205(a), then the 15.209(a) limit in the table below has to be followed.

Frequencies (MHz)	Field Strength (micorvolts/meter)	Measurement Distance (meters)
0.009~0.490	2400/F(KHz)	300
0.490~1.705	24000/F(KHz)	30
1.705~30.0	30	30
30~88	100	3
88~216	150	3
216~960	200	3
Above 960	500	3

LIMITS OF RADIATED EMISSION MEASUREMENT (Above 1000MHz)

FREQUENCY (MHz)	Limit (dBuV/m) (at 3M)	
	PEAK	AVERAGE
Above 1000	74	54

Notes:

- (1) The limit for radiated test was performed according to FCC PART 15C.
- (2) The tighter limit applies at the band edges.
- (3) Emission level (dBuV/m)=20log Emission level (uV/m).

3.2.2 TEST PROCEDURE

Below 1GHz test procedure as below:

- a. The EUT was placed on the top of a rotating table 0.8 meters above the ground at a 3 meter semi-anechoic chamber. The table was rotated 360 degrees to determine the position of the highest radiation.
- b. The EUT was set 3 meters away from the interference-receiving antenna, which was mounted on the top of a variable-height antenna tower.
- c. The antenna height is varied from one meter to four meters above the ground to determine the maximum value of the field strength. Both horizontal and vertical polarizations of the antenna are set to make the measurement.
- d. For each suspected emission, the EUT was arranged to its worst case and then the antenna was tuned to heights from 1 meter to 4 meters (for the test frequency of below 30MHz, the antenna was tuned to heights 1 meter) and the rotatable table was turned from 0 degrees to 360 degrees to find the maximum reading.
- e. The test-receiver system was set to Peak Detect Function and Specified Bandwidth with Maximum Hold Mode.

f. If the emission level of the EUT in peak mode was 10dB lower than the limit specified, then testing could be stopped and the peak values of the EUT would be reported. Otherwise the emissions that did not have 10dB margin would be re-tested one by one using peak, quasi-peak or average method as specified and then reported in a data sheet.

Above 1GHz test procedure as below:

- g. Different between above is the test site, change from Semi- Anechoic Chamber to fully Anechoic Chamber and change form table 0.8 metre to 1.5 metre(Above 18GHz the distance is 1 meter and table is 1.5 metre).
- h. Test the EUT in the lowest channel ,the middle channel ,the Highest channel

Note:

Both horizontal and vertical antenna polarities were tested and performed pretest to three orthogonal axis. The worst case emissions were reported

3.2.3 DEVIATION FROM TEST STANDARD

No deviation

3.2.4 TEST SETUP

(A) Radiated Emission Test-Up Frequency Below 30MHz

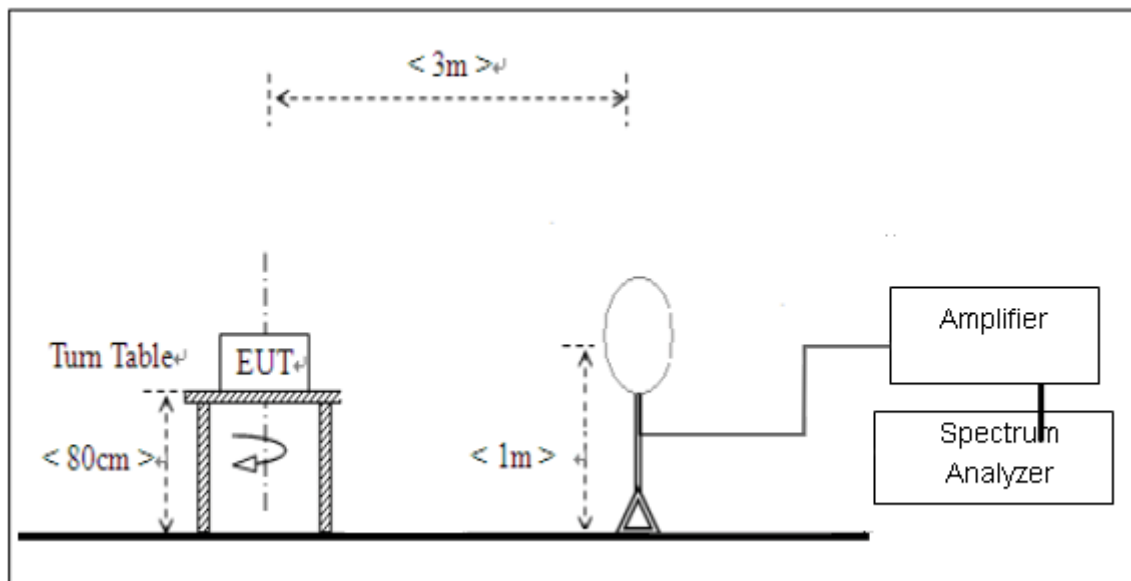

(B) Radiated Emission Test-Up Frequency 30MHz~1GHz

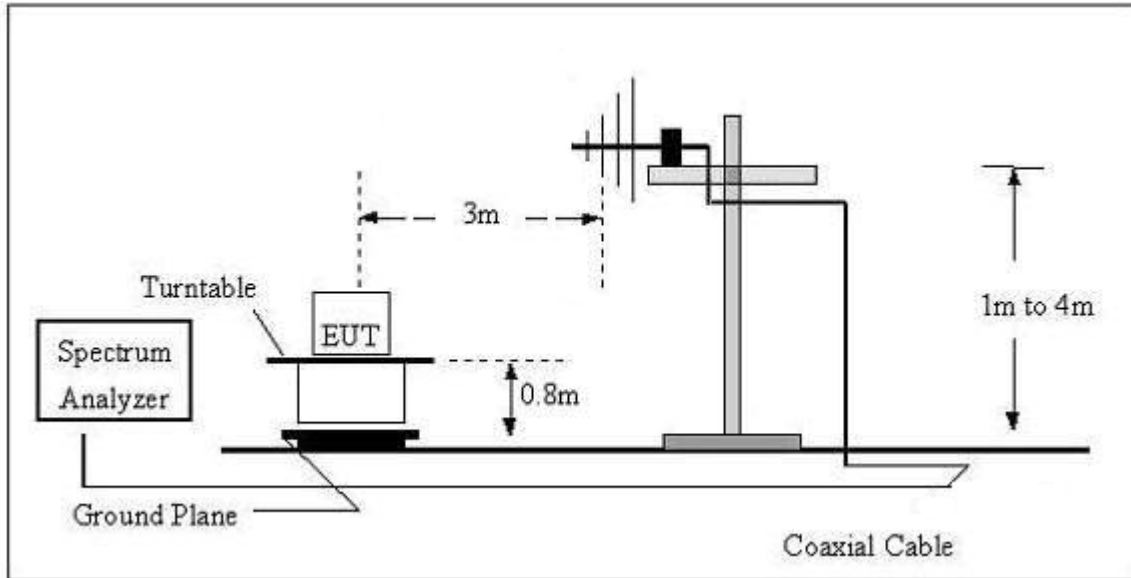

(C) Radiated Emission Test-Up Frequency Above 1GHz

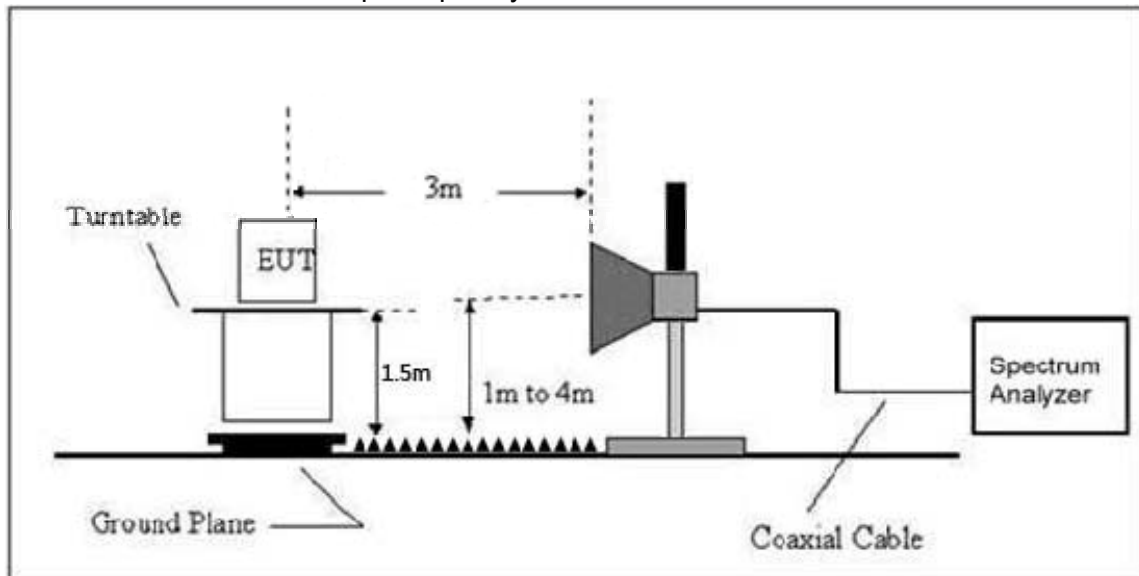

3.2.5 EUT OPERATING CONDITIONS

The EUT tested system was configured as the statements of 2.4 Unless otherwise a special operating condition is specified in the follows during the testing.



3.2.6 TEST RESULTS (BETWEEN 9KHZ – 30 MHZ)

Temperature:	26 °C	Relative Humidity :	54%
Pressure:	101kPa	Test Voltage :	AC 120V/60Hz
Test Mode :	Mode 5	Polarization :	--

Freq.	Reading	Limit	Margin	State
(MHz)	(dBuV/m)	(dBuV/m)	(dB)	P/F
--	--	--	--	PASS
--	--	--	--	PASS

NOTE:

The amplitude of spurious emissions which are attenuated by more than 20dB below the permissible value has no need to be reported.

Distance extrapolation factor = $40 \log(\text{specific distance}/\text{test distance})$ (dB);

Limit line = specific limits(dBuv) + distance extrapolation factor.



3.2.7 TEST RESULTS (BETWEEN 30MHZ – 1GHZ)

Temperature :	26 °C	Relative Humidity :	54%
Pressure :	101 kPa	Polarization :	Horizontal
Test Voltage :	AC 120V/60Hz		
Test Mode :	Mode 5		

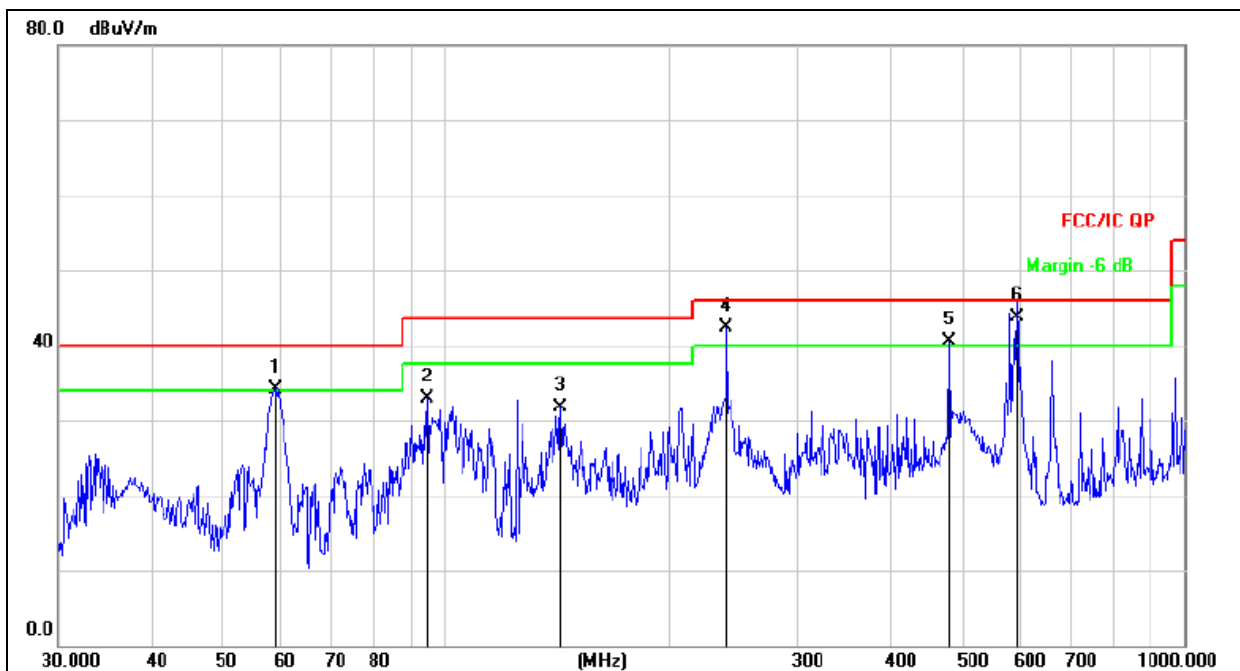

Remark:
Factor = Antenna Factor + Cable Loss – Pre-amplifier.

No.	Mk.	Freq. MHz	Reading Level dBuV	Correct Factor dB	Measure- ment dBuV/m	Limit dB/m	Over dB	Detector
1	!	58.8185	49.87	-15.78	34.09	40.00	-5.91	QP
2		94.4283	50.28	-17.29	32.99	43.50	-10.51	QP
3		143.3260	50.68	-19.07	31.61	43.50	-11.89	QP
4	!	239.9874	57.61	-15.38	42.23	46.00	-3.77	QP
5	!	480.5276	49.82	-9.34	40.48	46.00	-5.52	QP
6	*	593.0497	50.46	-6.68	43.78	46.00	-2.22	QP



Temperature :	26 °C	Relative Humidity :	54%
Pressure :	101kPa	Polarization :	Vertical
Test Voltage :	AC 120V/60Hz		
Test Mode :	Mode 5		

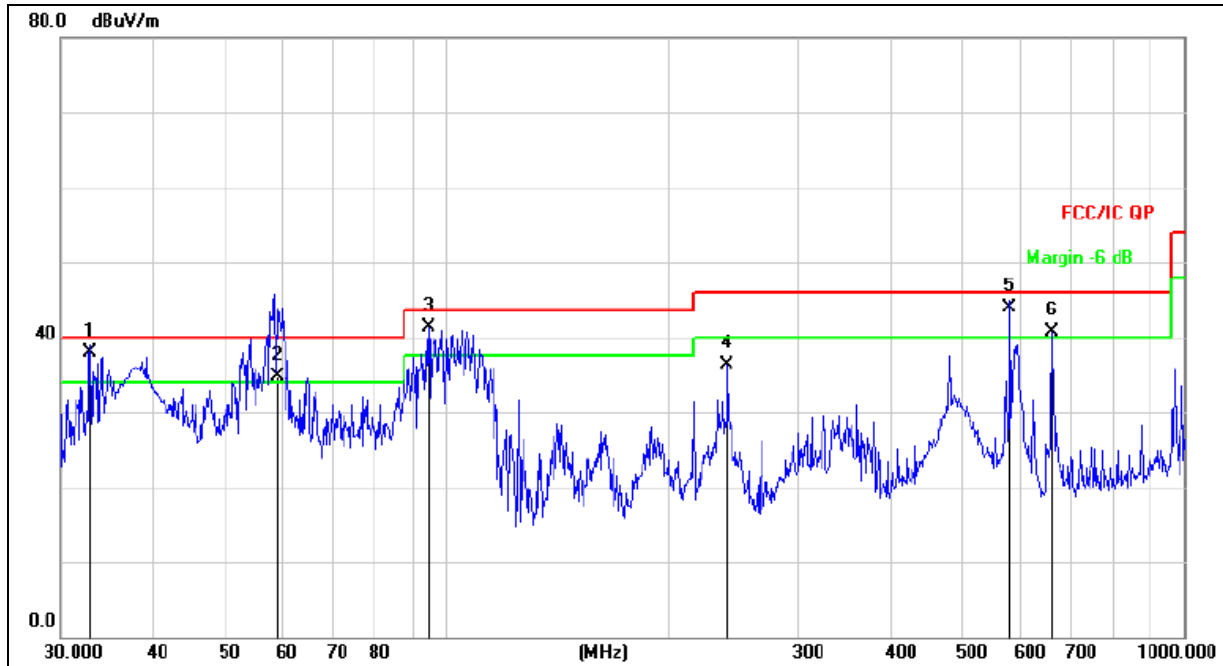

Remark:
Factor = Antenna Factor + Cable Loss – Pre-amplifier.

No.	Mk.	Freq. MHz	Reading Level dBuV	Correct Factor dB	Measure- ment dBuV/m	Limit dB/m	Over dB	Detector
1	!	32.8637	54.58	-16.74	37.84	40.00	-2.16	QP
2	!	58.7185	50.45	-15.77	34.68	40.00	-5.32	QP
3	!	94.4283	58.56	-17.29	41.27	43.50	-2.23	QP
4		239.9874	51.62	-15.38	36.24	46.00	-9.76	QP
5	*	580.7025	50.89	-6.97	43.92	46.00	-2.08	QP
6	!	661.1504	47.06	-6.44	40.62	46.00	-5.38	QP

3.2.8 TEST RESULTS (1GHZ~25GHZ)
802.11b

Polar (H/V)	Frequency	Meter Reading	Pre-amplifier	Cable Loss	Antenna Factor	Emission Level	Limits	Margin	Detector Type
	(MHz)	(dBuV)	(dB)	(dB)	(dB)	(dBuV/m)	(dBuV/m)	(dB)	
Low Channel:2412MHz									
V	4824.00	66.52	39.55	7.85	25.66	60.48	74.00	-13.52	PK
V	4824.00	51.26	39.55	7.85	25.66	45.22	54.00	-8.78	AV
V	7236.00	67.02	38.33	7.52	24.55	60.76	74.00	-13.24	PK
V	7236.00	49.35	38.33	7.52	24.55	43.09	54.00	-10.91	AV
V	15450.00	52.11	35.23	6.75	26.59	50.22	74.00	-23.78	PK
H	4824.00	67.92	39.55	7.85	25.66	61.88	74.00	-12.12	PK
H	4824.00	51.03	39.55	7.85	25.66	44.99	54.00	-9.01	AV
H	7236.00	67.15	38.33	7.52	23.55	59.89	74.00	-14.11	PK
H	7236.00	50.37	38.33	7.52	23.22	42.78	54.00	-11.22	AV
H	15450.00	51.36	35.45	6.75	27.88	50.54	74.00	-23.46	PK

Polar (H/V)	Frequency	Meter Reading	Pre-amplifier	Cable Loss	Antenna Factor	Emission Level	Limits	Margin	Detector Type
	(MHz)	(dBuV)	(dB)	(dB)	(dB)	(dBuV/m)	(dBuV/m)	(dB)	
Middle Channel:2437MHz									
V	4874.00	66.87	38.89	7.57	25.45	61.00	74.00	-13.00	Pk
V	4874.00	51.50	38.89	7.57	25.45	45.63	54.00	-8.37	AV
V	7311.00	66.80	38.78	7.35	24.78	60.15	74.00	-13.85	Pk
V	7311.00	49.48	38.78	7.35	24.78	42.83	54.00	-11.17	AV
V	15450.00	51.26	35.89	6.42	26.47	48.26	74.00	-25.74	Pk
H	4874.00	67.10	38.89	7.57	25.45	61.23	74.00	-12.77	Pk
H	4874.00	51.03	38.89	7.57	25.45	45.16	54.00	-8.84	AV
H	7311.00	67.15	38.78	7.35	24.78	60.50	74.00	-13.50	Pk
H	7311.00	50.81	38.78	7.35	24.78	44.16	54.00	-9.84	AV
H	15450.00	52.03	36.68	6.42	26.65	48.42	74.00	-25.58	Pk

Polar (H/V)	Frequency	Meter Reading	Pre-amplifier	Cable Loss	Antenna Factor	Emission Level	Limits	Margin	Detector Type
	(MHz)	(dBuV)	(dB)	(dB)	(dB)	(dBuV/m)	(dBuV/m)	(dB)	
High Channel: 2462MHz									
V	4924.00	68.03	38.75	7.46	25.45	62.19	74.00	-11.81	PK
V	4924.00	52.68	38.75	7.46	25.45	46.84	54.00	-7.16	AV
V	7386.00	67.97	38.65	7.22	24.78	61.32	74.00	-12.68	PK
V	7386.00	50.55	38.65	7.22	24.78	43.90	54.00	-10.10	AV
V	15450.00	49.87	35.58	6.35	26.47	47.11	74.00	-26.89	PK
H	4924.00	66.04	38.75	7.46	25.45	60.20	74.00	-13.80	PK
H	4924.00	51.65	38.75	7.46	25.45	45.81	54.00	-8.19	AV
H	7386.00	66.52	38.65	7.22	24.78	59.87	74.00	-14.13	PK
H	7386.00	50.32	38.65	7.22	24.78	43.67	54.00	-10.33	AV
H	15450.00	51.37	36.42	6.32	26.65	47.92	74.00	-26.08	PK

Remark:

1. Emission Level = Meter Reading + Antenna Factor + Cable Loss – Pre-amplifier,
Margin= Emission Level - Limit
2. If peak below the average limit, the average emission was no test.
3. In restricted bands of operation, The spurious emissions below the permissible value more than 20dB
4. The amplitude of spurious emissions which are attenuated by more than 20dB below the permissible value has no need to be reported.
5. We test Antenna A and B, the worst Antenna A data recording in the report.

802.11g

Polar (H/V)	Frequency	Meter Reading	Pre-amplifier	Cable Loss	Antenna Factor	Emission Level	Limits	Margin	Detector Type
	(MHz)	(dBuV)	(dB)	(dB)	(dB)	(dBuV/m)	(dBuV/m)	(dB)	
Low Channel:2412MHz									
V	4824.00	39.55	7.85	25.66	63.06	74.00	-10.94	39.55	PK
V	4824.00	39.55	7.85	25.66	47.23	54.00	-6.77	39.55	AV
V	7236.00	38.33	7.52	24.55	62.76	74.00	-11.24	38.33	PK
V	7236.00	38.33	7.52	24.55	42.91	54.00	-11.09	38.33	AV
V	15450.00	35.23	6.75	26.59	47.67	74.00	-26.33	35.23	PK
H	4824.00	39.55	7.85	25.66	59.16	74.00	-14.84	39.55	PK
H	4824.00	39.55	7.85	25.66	45.09	54.00	-8.91	39.55	AV
H	7236.00	38.33	7.52	23.55	60.46	74.00	-13.54	38.33	PK
H	7236.00	38.33	7.52	23.22	44.00	54.00	-10.00	38.33	AV
H	15450.00	35.45	6.75	27.88	51.59	74.00	-22.41	35.45	PK

Polar (H/V)	Frequency	Meter Reading	Pre-amplifier	Cable Loss	Antenna Factor	Emission Level	Limits	Margin	Detector Type
	(MHz)	(dBuV)	(dB)	(dB)	(dB)	(dBuV/m)	(dBuV/m)	(dB)	
Middle Channel:2437MHz									
V	4874.00	68.74	38.89	7.57	25.45	62.87	74.00	-11.13	PK
V	4874.00	52.71	38.89	7.57	25.45	46.84	54.00	-7.16	AV
V	7311.00	70.30	38.78	7.35	24.78	63.65	74.00	-10.35	PK
V	7311.00	48.50	38.78	7.35	24.78	41.85	54.00	-12.15	AV
V	15450.00	50.41	35.89	6.42	26.47	47.41	74.00	-26.59	PK
H	4874.00	65.66	38.89	7.57	25.45	59.79	74.00	-14.21	PK
H	4874.00	50.21	38.89	7.57	25.45	44.34	54.00	-9.66	AV
H	7311.00	67.71	38.78	7.35	24.78	61.06	74.00	-12.94	PK
H	7311.00	52.13	38.78	7.35	24.78	45.48	54.00	-8.52	AV
H	15450.00	53.28	36.68	6.42	26.65	49.67	74.00	-24.33	PK

Polar (H/V)	Frequency	Meter Reading	Pre-amplifier	Cable Loss	Antenna Factor	Emission Level	Limits	Margin	Detector Type
	(MHz)	(dBuV)	(dB)	(dB)	(dB)	(dBuV/m)	(dBuV/m)	(dB)	
High Channel: 2462MHz									
V	4924.00	68.37	38.75	7.46	25.45	62.53	74.00	-11.47	PK
V	4924.00	52.60	38.75	7.46	25.45	46.76	54.00	-7.24	AV
V	7386.00	71.54	38.65	7.22	24.78	64.89	74.00	-9.11	PK
V	7386.00	47.27	38.65	7.22	24.78	40.62	54.00	-13.38	AV
V	15450.00	50.77	35.58	6.35	26.47	48.01	74.00	-25.99	PK
H	4924.00	66.96	38.75	7.46	25.45	61.12	74.00	-12.88	PK
H	4924.00	51.06	38.75	7.46	25.45	45.22	54.00	-8.78	AV
H	7386.00	69.11	38.65	7.22	24.78	62.46	74.00	-11.54	PK
H	7386.00	50.86	38.65	7.22	24.78	44.21	54.00	-9.79	AV
H	15450.00	54.32	36.42	6.32	26.65	50.87	74.00	-23.13	PK

Remark:

1. Emission Level = Meter Reading + Antenna Factor + Cable Loss – Pre-amplifier,
Margin= Emission Level - Limit
2. If peak below the average limit, the average emission was no test.
3. In restricted bands of operation, The spurious emissions below the permissible value more than 20dB
4. The amplitude of spurious emissions which are attenuated by more than 20dB below the permissible value has no need to be reported.
5. We test Antenna A and B, the worst Antenna A data recording in the report.

802.11n(20MHz)

Polar (H/V)	Frequency	Meter Reading	Pre-amplifier	Cable Loss	Antenna Factor	Emission Level	Limits	Margin	Detector Type
	(MHz)	(dBuV)	(dB)	(dB)	(dB)	(dBuV/m)	(dBuV/m)	(dB)	
Low Channel:2412MHz									
V	4824.00	67.32	39.55	7.85	25.66	61.28	74.00	-12.72	PK
V	4824.00	53.87	39.55	7.85	25.66	47.83	54.00	-6.17	AV
V	7236.00	71.66	38.33	7.52	24.55	65.40	74.00	-8.60	PK
V	7236.00	46.44	38.33	7.52	24.55	40.18	54.00	-13.82	AV
V	15450.00	51.00	35.23	6.75	26.59	49.11	74.00	-24.89	PK
H	4824.00	65.47	39.55	7.85	25.66	59.43	74.00	-14.57	PK
H	4824.00	52.11	39.55	7.85	25.66	46.07	54.00	-7.93	AV
H	7236.00	68.74	38.33	7.52	23.55	61.48	74.00	-12.52	PK
H	7236.00	50.40	38.33	7.52	23.22	42.81	54.00	-11.19	AV
H	15450.00	54.89	35.45	6.75	27.88	54.07	74.00	-19.93	PK

Polar (H/V)	Frequency	Meter Reading	Pre-amplifier	Cable Loss	Antenna Factor	Emission Level	Limits	Margin	Detector Type
	(MHz)	(dBuV)	(dB)	(dB)	(dB)	(dBuV/m)	(dBuV/m)	(dB)	
Middle Channel:2437MHz									
V	4874.00	66.49	38.89	7.57	25.45	60.62	74.00	-13.38	PK
V	4874.00	54.11	38.89	7.57	25.45	48.24	54.00	-5.76	AV
V	7311.00	70.88	38.78	7.35	24.78	64.23	74.00	-9.77	PK
V	7311.00	47.01	38.78	7.35	24.78	40.36	54.00	-13.64	AV
V	15450.00	51.86	35.89	6.42	26.47	48.86	74.00	-25.14	PK
H	4874.00	66.09	38.89	7.57	25.45	60.22	74.00	-13.78	PK
H	4874.00	52.16	38.89	7.57	25.45	46.29	54.00	-7.71	AV
H	7311.00	68.74	38.78	7.35	24.78	62.09	74.00	-11.91	PK
H	7311.00	49.40	38.78	7.35	24.78	42.75	54.00	-11.25	AV
H	15450.00	54.73	36.68	6.42	26.65	51.12	74.00	-22.88	PK

Polar (H/V)	Frequency	Meter Reading	Pre-amplifier	Cable Loss	Antenna Factor	Emission Level	Limits	Margin	Detector Type
	(MHz)	(dBuV)	(dB)	(dB)	(dB)	(dBuV/m)	(dBuV/m)	(dB)	
High Channel: 2462MHz									
V	4924.00	67.79	38.75	7.46	25.45	61.95	74.00	-12.05	PK
V	4924.00	52.72	38.75	7.46	25.45	46.88	54.00	-7.12	AV
V	7386.00	69.66	38.65	7.22	24.78	63.01	74.00	-10.99	PK
V	7386.00	47.19	38.65	7.22	24.78	40.54	54.00	-13.46	AV
V	15450.00	53.05	35.58	6.35	26.47	50.29	74.00	-23.71	PK
H	4924.00	65.44	38.75	7.46	25.45	59.60	74.00	-14.40	PK
H	4924.00	51.39	38.75	7.46	25.45	45.55	54.00	-8.45	AV
H	7386.00	69.34	38.65	7.22	24.78	62.69	74.00	-11.31	PK
H	7386.00	50.25	38.65	7.22	24.78	43.60	54.00	-10.40	AV
H	15450.00	53.61	36.42	6.32	26.65	50.16	74.00	-23.84	PK

Remark:

1. Emission Level = Meter Reading + Antenna Factor + Cable Loss – Pre-amplifier,

Margin= Emission Level - Limit

2. If peak below the average limit, the average emission was no test.

3. In restricted bands of operation, The spurious emissions below the permissible value more than 20dB

4. The amplitude of spurious emissions which are attenuated by more than 20dB below the permissible value has no need to be reported.

5. We test Antenna A and B, MIMO mode, the worst MIMO mode data recording in the report.

802.11n(40MHz)

Polar (H/V)	Frequency	Meter Reading	Pre-amplifier	Cable Loss	Antenna Factor	Emission Level	Limits	Margin	Detector Type
	(MHz)	(dBuV)	(dB)	(dB)	(dB)	(dBuV/m)	(dBuV/m)	(dB)	
Low Channel:2422MHz									
V	4844.00	68.97	39.55	7.77	25.66	62.85	74.00	-11.15	PK
V	4844.00	53.74	39.55	7.77	25.66	47.62	54.00	-6.38	AV
V	7266.00	70.03	38.33	7.3	24.55	63.55	74.00	-10.45	PK
V	7266.00	48.72	38.33	7.3	24.55	42.24	54.00	-11.76	AV
V	15450.00	52.37	35.23	6.6	26.59	50.33	74.00	-23.67	PK
H	4844.00	66.07	39.55	7.77	25.66	59.95	74.00	-14.05	PK
H	4844.00	52.43	39.55	7.77	25.66	46.31	54.00	-7.69	AV
H	7266.00	70.33	38.33	7.3	23.55	62.85	74.00	-11.15	PK
H	7266.00	49.25	38.33	7.3	23.22	41.44	54.00	-12.56	AV
H	15450.00	54.84	35.45	6.6	27.88	53.87	74.00	-20.13	PK

Polar (H/V)	Frequency	Meter Reading	Pre-amplifier	Cable Loss	Antenna Factor	Emission Level	Limits	Margin	Detector Type
	(MHz)	(dBuV)	(dB)	(dB)	(dB)	(dBuV/m)	(dBuV/m)	(dB)	
Middle Channel:2437MHz									
V	4874.00	67.82	38.89	7.57	25.45	61.95	74.00	-12.05	PK
V	4874.00	54.92	38.89	7.57	25.45	49.05	54.00	-4.95	AV
V	7311.00	71.08	38.78	7.35	24.78	64.43	74.00	-9.57	PK
V	7311.00	48.01	38.78	7.35	24.78	41.36	54.00	-12.64	AV
V	15450.00	52.40	35.89	6.42	26.47	49.40	74.00	-24.60	PK
H	4874.00	65.52	38.89	7.57	25.45	59.65	74.00	-14.35	PK
H	4874.00	53.83	38.89	7.57	25.45	47.96	54.00	-6.04	AV
H	7311.00	71.41	38.78	7.35	24.78	64.76	74.00	-9.24	PK
H	7311.00	48.24	38.78	7.35	24.78	41.59	54.00	-12.41	AV
H	15450.00	54.81	36.68	6.42	26.65	51.20	74.00	-22.80	PK

Polar (H/V)	Frequency	Meter Reading	Pre-amplifier	Cable Loss	Antenna Factor	Emission Level	Limits	Margin	Detector Type
	(MHz)	(dBuV)	(dB)	(dB)	(dB)	(dBuV/m)	(dBuV/m)	(dB)	
High Channel: 2452MHz									
V	4904.00	68.45	38.75	7.38	25.45	62.53	74.00	-11.47	PK
V	4904.00	53.78	38.75	7.38	25.45	47.86	54.00	-6.14	AV
V	7356.00	71.10	38.65	7.15	24.78	64.38	74.00	-9.62	PK
V	7356.00	48.61	38.65	7.15	24.78	41.89	54.00	-12.11	AV
V	15450.00	53.62	35.58	6.25	26.47	50.76	74.00	-23.24	PK
H	4904.00	66.88	38.75	7.38	25.45	60.96	74.00	-13.04	PK
H	4904.00	52.89	38.75	7.38	25.45	46.97	54.00	-7.03	AV
H	7356.00	70.18	38.65	7.15	24.78	63.46	74.00	-10.54	PK
H	7356.00	47.39	38.65	7.15	24.78	40.67	54.00	-13.33	AV
H	15450.00	55.93	36.42	6.25	26.65	52.41	74.00	-21.59	PK

Remark:

1. Emission Level = Meter Reading + Antenna Factor + Cable Loss – Pre-amplifier,
Margin= Emission Level - Limit
2. If peak below the average limit, the average emission was no test.
3. In restricted bands of operation, The spurious emissions below the permissible value more than 20dB
4. The amplitude of spurious emissions which are attenuated by more than 20dB below the permissible value has no need to be reported.
5. We test Antenna A and B, MIMO mode, the worst MIMO mode data recording in the report.



3.3 RADIATED BAND EMISSION MEASUREMENT

3.3.1 TEST REQUIREMENT:

FCC Part15 C Section 15.209 and 15.205

(a) Except as shown in paragraph (d) of this section, only spurious emissions are permitted in any of the frequency bands listed below:

MHz	MHz	MHz	GHz
0.090-0.110	16.42-16.423	399.9-410	4.5-5.15
0.495-0.505	16.69475-16.69525	608-614	5.35-5.46
2.1735-2.1905	16.80425-16.80475	960-1240	7.25-7.75
4.125-4.128	25.5-25.67	1300-1427	8.025-8.5
4.17725-4.17775	37.5-38.25	1435-1626.5	9.0-9.2
4.20725-4.20775	73-74.6	1645.5-1646.5	9.3-9.5
6.215-6.218	74.8-75.2	1660-1710	10.6-12.7
6.26775-6.26825	108-121.94	1718.8-1722.2	13.25-13.4
6.31175-6.31225	123-138	2200-2300	14.47-14.5
8.291-8.294	149.9-150.05	2310-2390	15.35-16.2
8.362-8.366	156.52475-156.52525	2483.5-2500	17.7-21.4
8.37625-8.38675	156.7-156.9	2690-2900	22.01-23.12
8.41425-8.41475	162.0125-167.17	3260-3267	23.6-24.0
12.29-12.293	167.72-173.2	3332-3339	31.2-31.8
12.51975-12.52025	240-285	3345.8-3358	36.43-36.5
12.57675-12.57725	322-335.4	3600-4400	(²)
13.36-13.41			

LIMITS OF RADIATED EMISSION MEASUREMENT (Above 1000MHz)

FREQUENCY (MHz)	Class B (dBuV/m) (at 3M)	
	PEAK	AVERAGE
Above 1000	74	54

Notes:

- (1) The limit for radiated test was performed according to FCC PART 15C.
- (2) The tighter limit applies at the band edges.
- (3) Emission level (dBuV/m)=20log Emission level (uV/m).

Spectrum Parameter	Setting
Attenuation	Auto
Start Frequency	2300MHz
Stop Frequency	2520
RB / VB (emission in restricted band)	1 MHz / 1 MHz for Peak, 1 MHz / 10Hz for Average

3.3.2 TEST PROCEDURE

Above 1GHz test procedure as below:

- a. 1. The EUT was placed on the top of a rotating table 1.5 meters above the ground at a 3 meter camber. The table was rotated 360 degrees to determine the position of the highest radiation.
- b. The EUT was set 3 meters away from the interference-receiving antenna, which was mounted on the top of a variable-height antenna tower.
- c. The antenna height is varied from one meter to four meters above the ground to determine the maximum value of the field strength. Both horizontal and vertical polarizations of the antenna are set to make the measurement.

- d. For each suspected emission, the EUT was arranged to its worst case and then the antenna was tuned to heights from 1 meter to 4 meters and the rota table was turned from 0 degrees to 360 degrees to find the maximum reading.
- e. The test-receiver system was set to Peak Detect Function and Specified Bandwidth with Maximum Hold Mode.
- f. If the emission level of the EUT in peak mode was 10dB lower than the limit specified, then testing could be stopped and the peak values of the EUT would be reported. Otherwise the emissions that did not have 10dB margin would be re-tested one by one using peak, quasi-peak or average method as specified and then reported in a data sheet.
- g. Test the EUT in the lowest channel, the Highest channel

Note:

Both horizontal and vertical antenna polarities were tested and performed pretest to three orthogonal axis. The worst case emissions were reported

3.3.3 DEVIATION FROM TEST STANDARD

No deviation

3.3.4 TEST SETUP

Radiated Emission Test-Up Frequency Above 1GHz

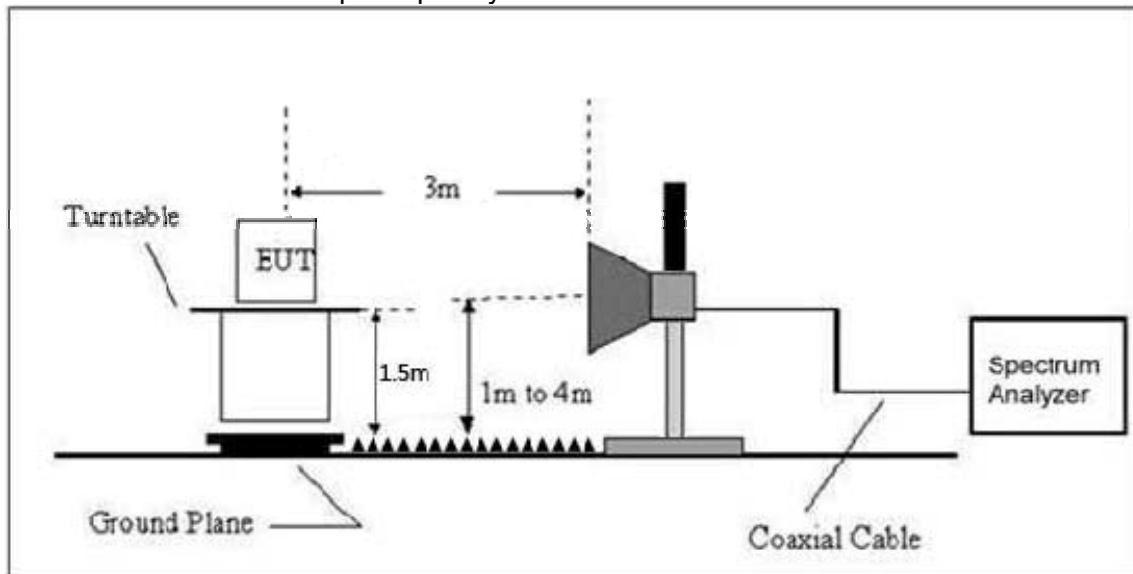

3.3.5 EUT OPERATING CONDITIONS

The EUT tested system was configured as the statements of 2.3 Unless otherwise a special operating condition is specified in the follows during the testing.

3.3.6 TEST RESULT

	Polar (H/V)	Frequency (MHz)	Meter Reading (dBuV)	Pre-amplifier (dB)	Cable Loss (dB)	Antenna Factor (dB/m)	Emission level (dBuV/m)	Limits (dBuV/m)		Result
							PK	PK	AV	
802.11b	Low Channel 2412MHz									
	H	2390.00	63.18	38.06	7.42	20.15	52.69	74.00	54.00	PASS
	H	2400.00	52.85	38.06	7.42	20.15	42.36	74.00	54.00	PASS
	V	2390.00	60.03	38.06	7.42	20.15	49.54	74.00	54.00	PASS
	V	2400.00	55.09	38.06	7.42	20.15	44.60	74.00	54.00	PASS
	High Channel 2462MHz									
	H	2483.50	62.77	38.17	7.45	20.54	52.59	74.00	54.00	PASS
	H	2485.50	53.89	38.17	7.45	20.54	43.71	74.00	54.00	PASS
	V	2483.50	63.02	38.2	7.45	20.54	52.81	74.00	54.00	PASS
	V	2485.50	52.07	38.2	7.45	20.54	41.86	74.00	54.00	PASS
802.11g	Low Channel 2412MHz									
	H	2390.00	61.14	38.06	7.42	20.15	50.65	74.00	54.00	PASS
	H	2400.00	55.04	38.06	7.42	20.15	44.55	74.00	54.00	PASS
	V	2390.00	60.48	38.06	7.42	20.15	49.99	74.00	54.00	PASS
	V	2400.00	51.91	38.06	7.42	20.15	41.42	74.00	54.00	PASS
	High Channel 2462MHz									
	H	2483.50	62.98	38.17	7.45	20.54	52.80	74.00	54.00	PASS
	H	2485.50	53.19	38.17	7.45	20.54	43.01	74.00	54.00	PASS
	V	2483.50	60.68	38.2	7.45	20.54	50.47	74.00	54.00	PASS
	V	2485.50	52.40	38.2	7.45	20.54	42.19	74.00	54.00	PASS
802.11n20	Low Channel 2412MHz									
	H	2390.00	62.32	38.06	7.42	20.15	51.83	74.00	54.00	PASS
	H	2400.00	50.77	38.06	7.42	20.15	40.28	74.00	54.00	PASS
	V	2390.00	59.68	38.06	7.42	20.15	49.19	74.00	54.00	PASS
	V	2400.00	54.57	38.06	7.42	20.15	44.08	74.00	54.00	PASS
	High Channel 2462MHz									
	H	2483.50	58.99	38.17	7.45	20.54	48.81	74.00	54.00	PASS
	H	2485.50	53.51	38.17	7.45	20.54	43.33	74.00	54.00	PASS
	V	2483.50	61.54	38.2	7.45	20.54	51.33	74.00	54.00	PASS
	V	2485.50	51.92	38.2	7.45	20.54	41.71	74.00	54.00	PASS
802.11n40	Low Channel 2422MHz									
	H	2390.00	59.70	38.06	7.42	20.15	49.21	74.00	54.00	PASS
	H	2400.00	55.48	38.06	7.42	20.15	44.99	74.00	54.00	PASS
	V	2390.00	60.67	38.06	7.42	20.15	50.18	74.00	54.00	PASS
	V	2400.00	52.23	38.06	7.42	20.15	41.74	74.00	54.00	PASS
	High Channel 2452MHz									
	H	2483.50	63.04	38.17	7.45	20.54	52.86	74.00	54.00	PASS
	H	2485.50	54.72	38.17	7.45	20.54	44.54	74.00	54.00	PASS
	V	2483.50	59.00	38.2	7.45	20.54	48.79	74.00	54.00	PASS
	V	2485.50	55.53	38.2	7.45	20.54	45.32	74.00	54.00	PASS

Remark:

1. Emission Level = Meter Reading + Antenna Factor + Cable Loss – Pre-amplifier, Margin= Emission Level - Limit
2. If the PK measured levels comply with average limit, then the average level were deemed to comply with average limit.
3. In restricted bands of operation, The spurious emissions below the permissible value more than 20dB
4. The amplitude of spurious emissions which are attenuated by more than 20dB below the permissible value has no need to be reported.
5. We test Antenna A and B, MIMO mode, the worst Antenna A data recording in the report.



4. POWER SPECTRAL DENSITY TEST

4.1 APPLIED PROCEDURES / LIMIT

FCC Part15 (15.247) , Subpart C				
Section	Test Item	Limit	Frequency Range (MHz)	Result
15.247	Power Spectral Density	8 dBm (in any 3KHz)	2400-2483.5	PASS

4.1.1 TEST PROCEDURE

1. Set analyzer center frequency to DTS channel center frequency.
2. Set the span to 1.5 times the DTS bandwidth.
3. Set the RBW to: $3\text{ kHz} \leq \text{RBW} \leq 100\text{ kHz}$.
4. Set the VBW $\geq 3 \times \text{RBW}$.
5. Detector = peak.
6. Sweep time = auto couple.
7. Trace mode = max hold.
8. Allow trace to fully stabilize.
9. Use the peak marker function to determine the maximum amplitude level within the RBW.
10. If measured value exceeds limit, reduce RBW (no less than 3 kHz) and repeat.

4.1.2 DEVIATION FROM STANDARD

No deviation.

4.1.3 TEST SETUP

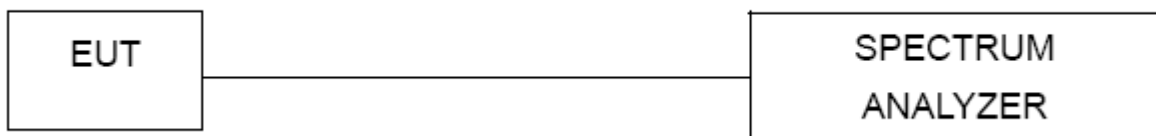

4.1.4 EUT OPERATION CONDITIONS

The EUT tested system was configured as the statements of 2.1 Unless otherwise a special operating condition is specified in the follows during the testing.

Note: Power Spectral Density(dBm)=Reading+Cable Loss

4.1.5 TEST RESULTS

Temperature :	26 °C	Relative Humidity :	54%
Pressure :	101kPa	Test Voltage :	AC 120V/60Hz
Test Mode :	TX b Mode		

Frequency	Power Spectral Density(dBm) ANTA	Power Spectral Density(dBm) ANTB	Total power density (dBm)	Limit (dBm)	Result
2412 MHz	-14.421	-13.162	/	8	PASS
2437 MHz	-13.438	-14.276	/	8	PASS
2462 MHz	-12.668	-12.758	/	8	PASS

Note: A(B) Represent the value of antenna A and B, The worst data is Antenna A ,only shown Antenna A Plot.

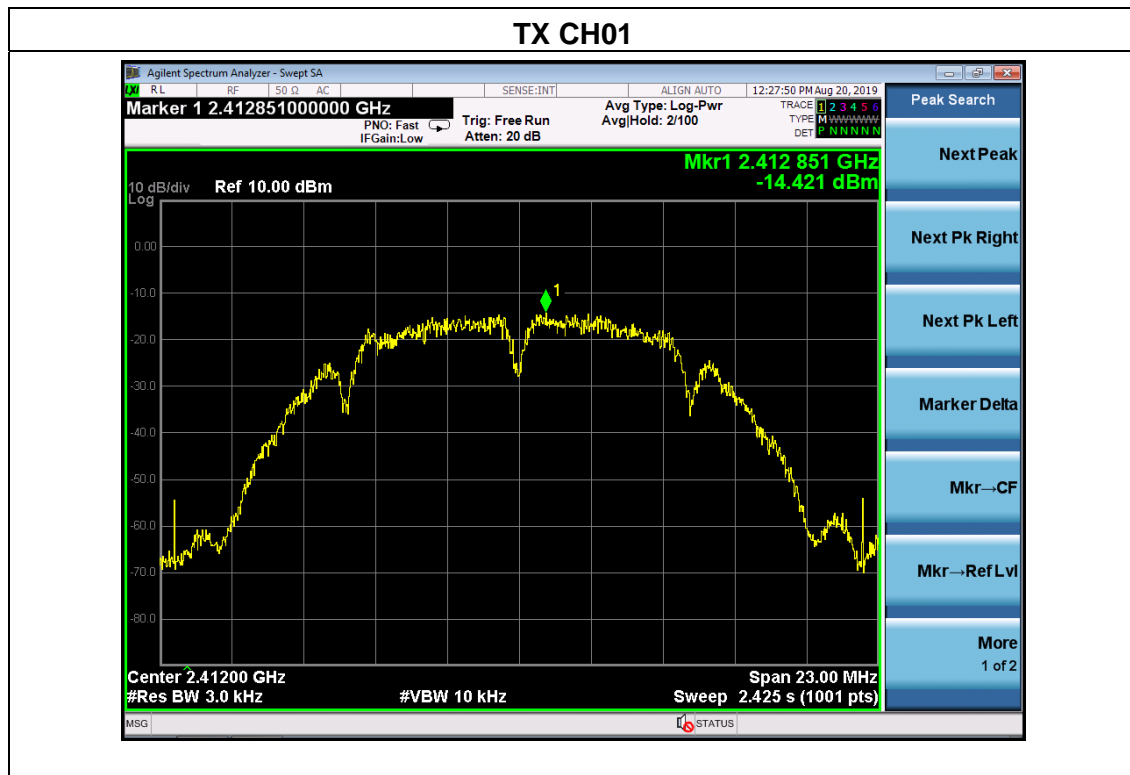

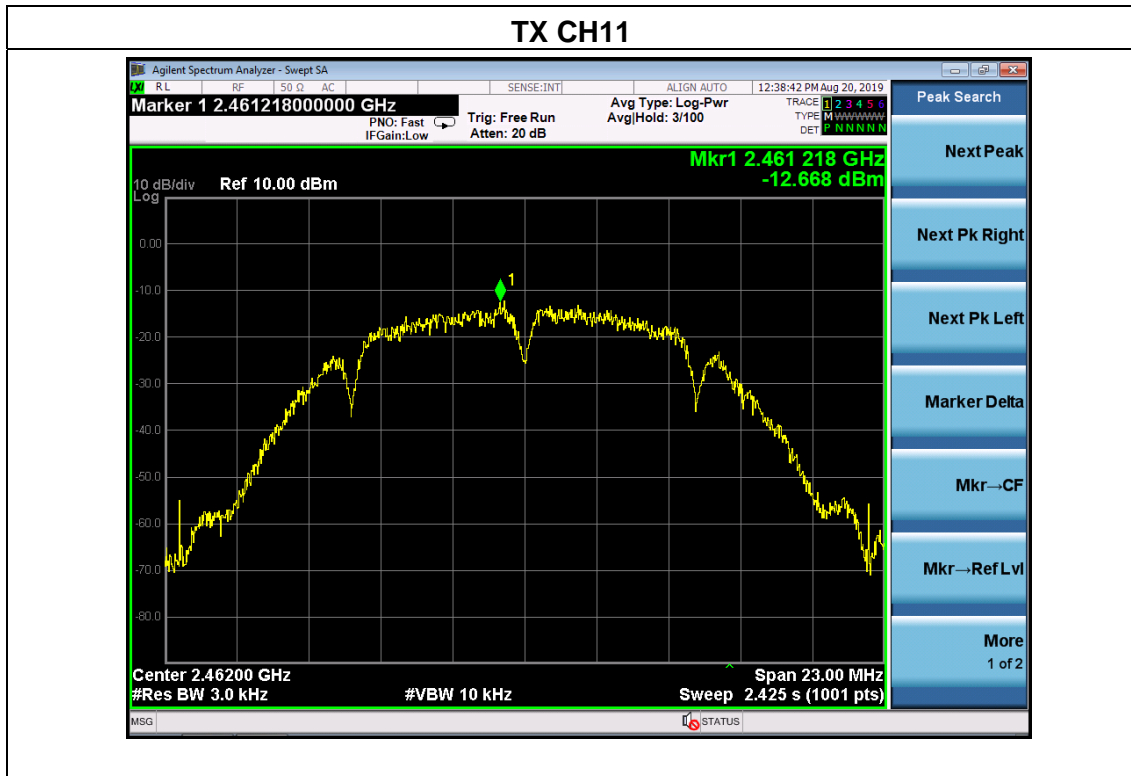



Temperature :	26 °C	Relative Humidity :	54%
Pressure :	101kPa	Test Voltage :	AC 120V/60Hz
Test Mode :	TX g Mode		

Frequency	Power Spectral Density(dBm) ANTA	Power Spectral Density(dBm) ANTB	Total power density (dBm/3KHz)	Limit (dBm/3KHz)	Result
2412 MHz	-13.409	-15.288	/	8	PASS
2437 MHz	-14.315	-13.674	/	8	PASS
2462 MHz	-13.878	-14.035	/	8	PASS

Note: A(B) Represent the value of antenna A and B, The worst data is Antenna A ,only shown Antenna A Plot.

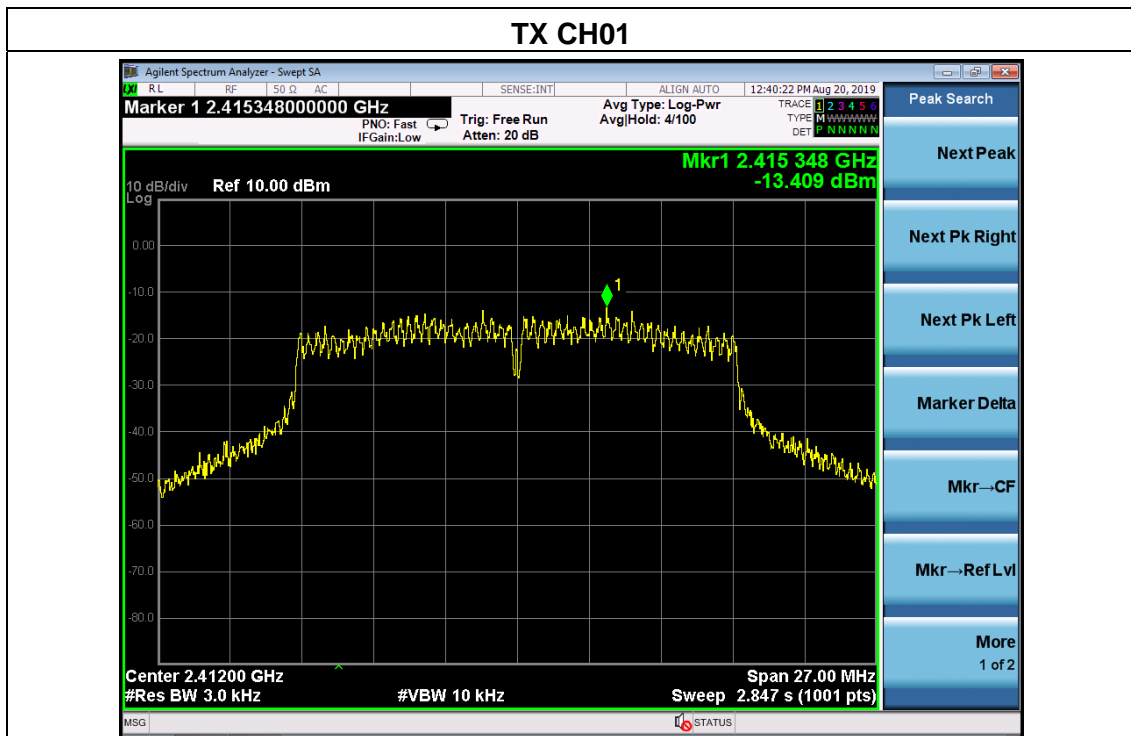

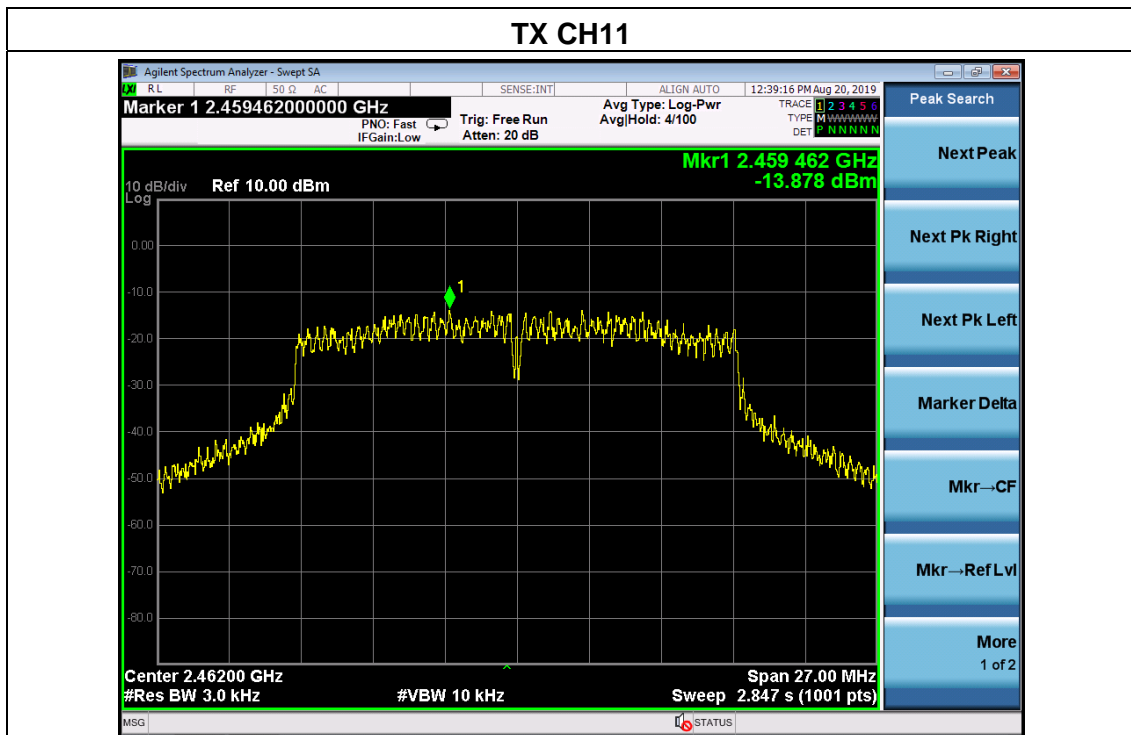
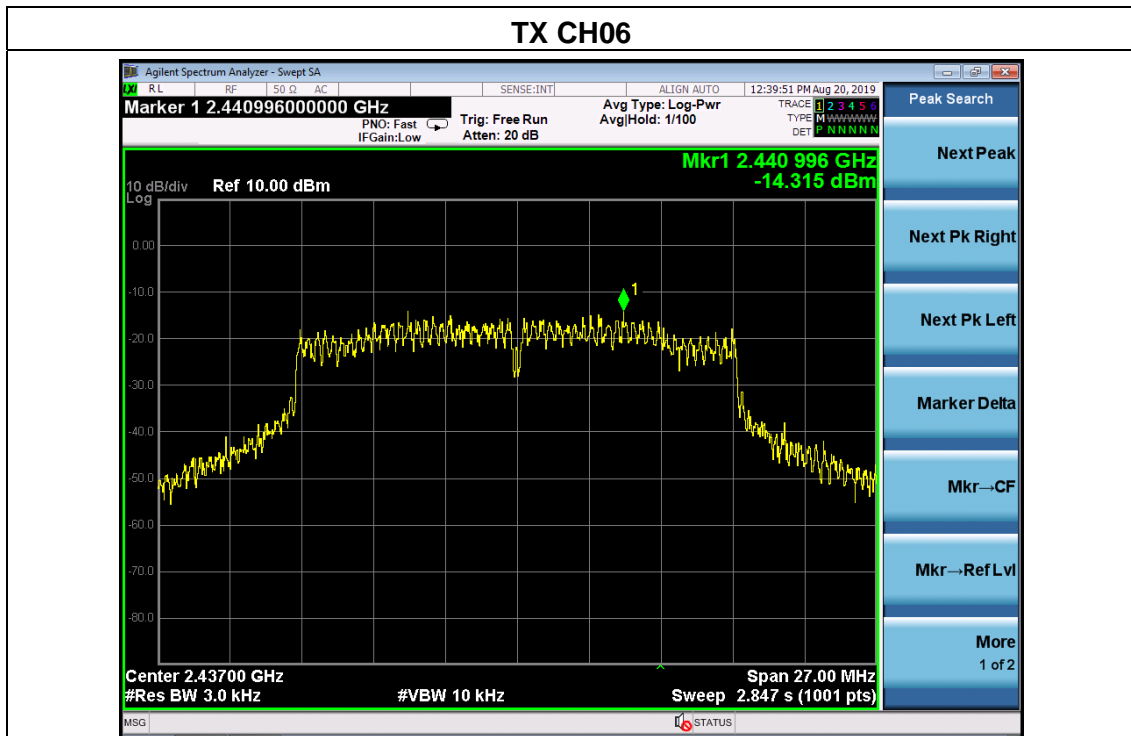

Temperature :	26 °C	Relative Humidity :	54%
Pressure :	101kPa	Test Voltage :	AC 120V/60Hz
Test Mode :	TX n Mode(20M)		

Frequency	Power Spectral Density(dBm) ANTA	Power Spectral Density(dBm) ANTB	Total power density (dBm/3KHz)	Limit (dBm/3KHz)	Result
2412 MHz	-13.266	-14.549	-10.85	7.99	PASS
2437 MHz	-15.014	-12.972	-10.86	7.99	PASS
2462 MHz	-11.067	-13.880	-9.24	7.99	PASS

Note: A(B) Represent the value of antenna A and B, The worst data is Antenna A ,only shown Antenna A Plot.

Antenna A gain: 3dBi, Antenna B gain: 3dBi, Directional gain=[10log(GA+ G B)] dbi =6.01dbi
limit=8-(6.01-6)=7.99

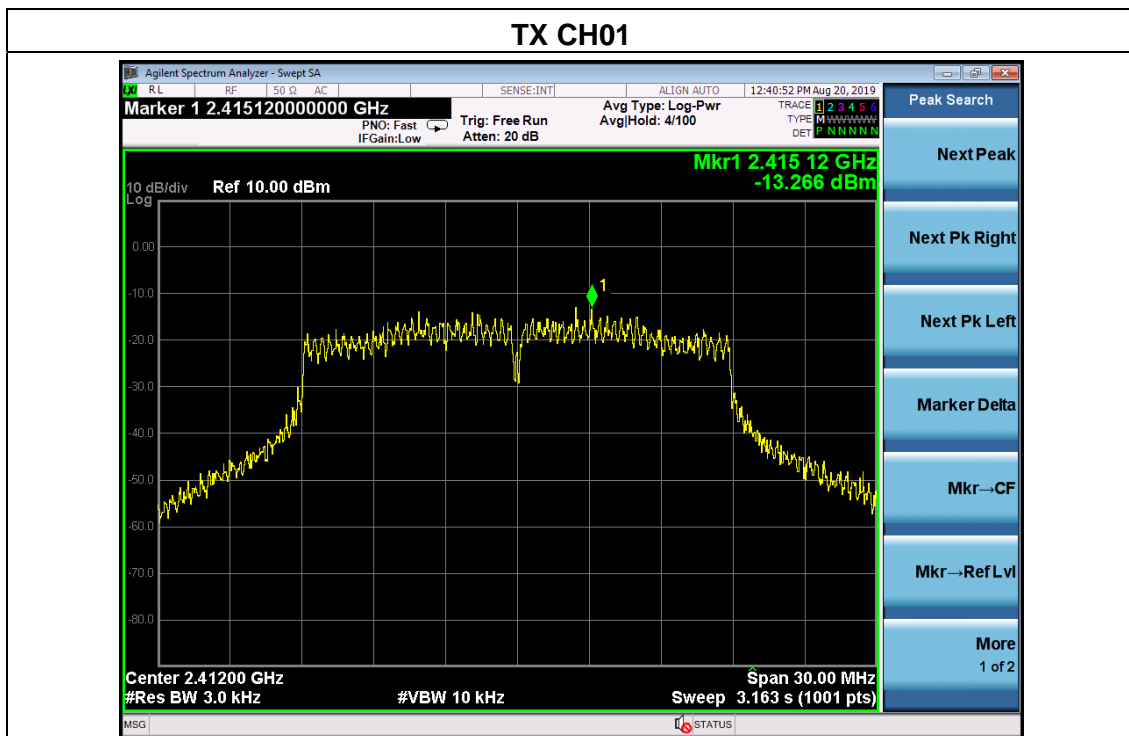

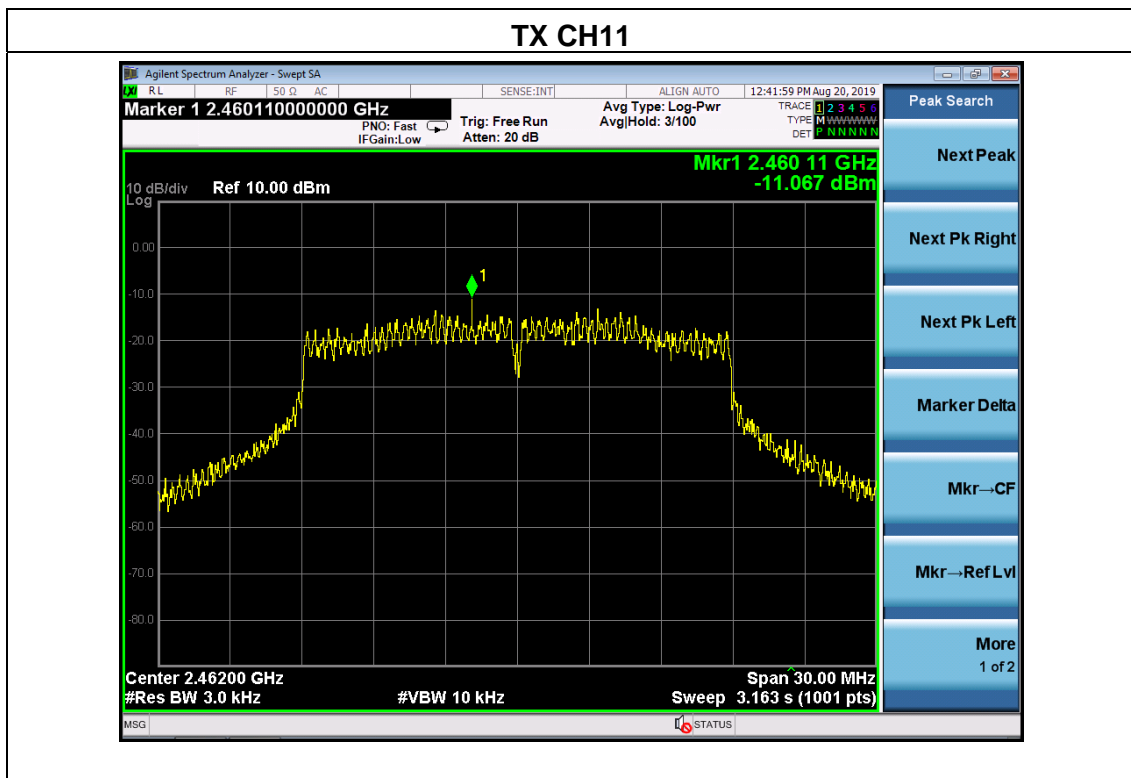
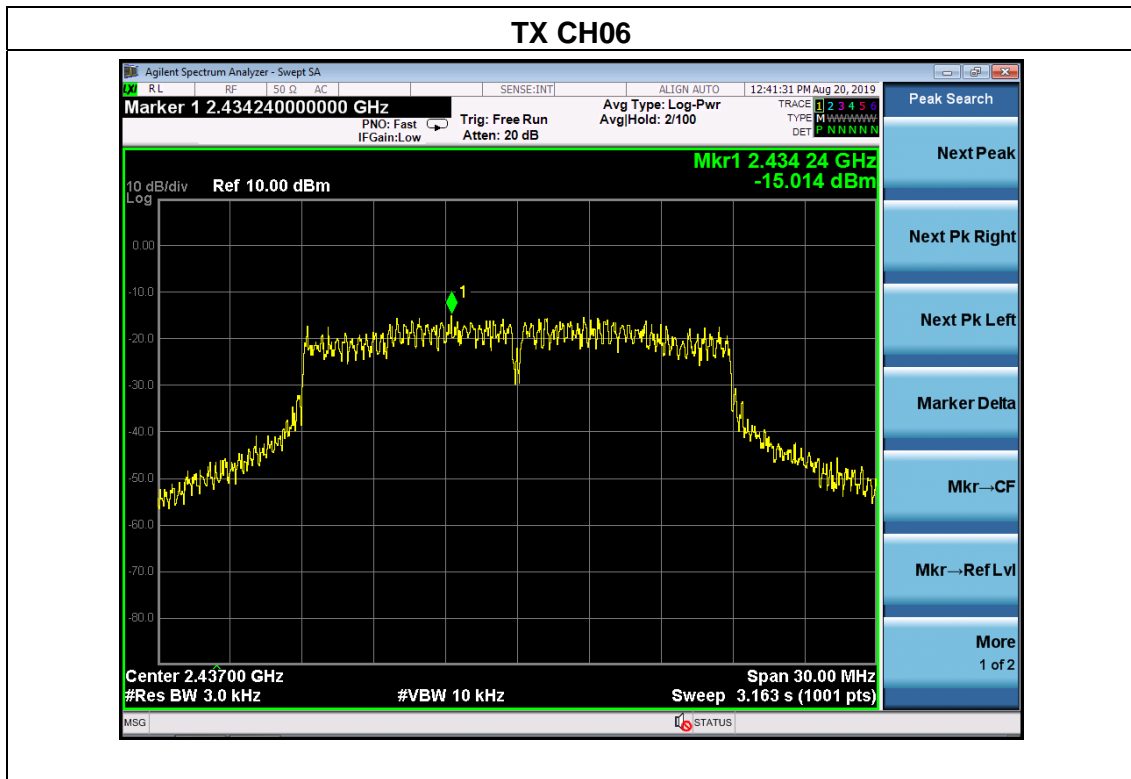



Temperature :	26 °C	Relative Humidity :	54%
Pressure :	101kPa	Test Voltage :	AC 120V/60Hz
Test Mode :	TX n Mode(40M)		

Frequency	Power Spectral Density(dBm) ANTA	Power Spectral Density(dBm) ANTB	Total power density (dBm/3KHz)	Limit (dBm/3KHz)	Result
2422 MHz	-16.008	-18.073	-13.91	7.99	PASS
2437 MHz	-16.609	-17.381	-13.97	7.99	PASS
2452 MHz	-15.734	-15.667	-12.69	7.99	PASS

Note: A(B) Represent the value of antenna A and B, The worst data is Antenna A ,only shown Antenna A Plot.

Antenna A gain: 3dBi, Antenna B gain: 3dBi, Directional gain=[10log(GA+ G B)] dbi =6.01dbi
limit=8-(6.01-6)=7.99

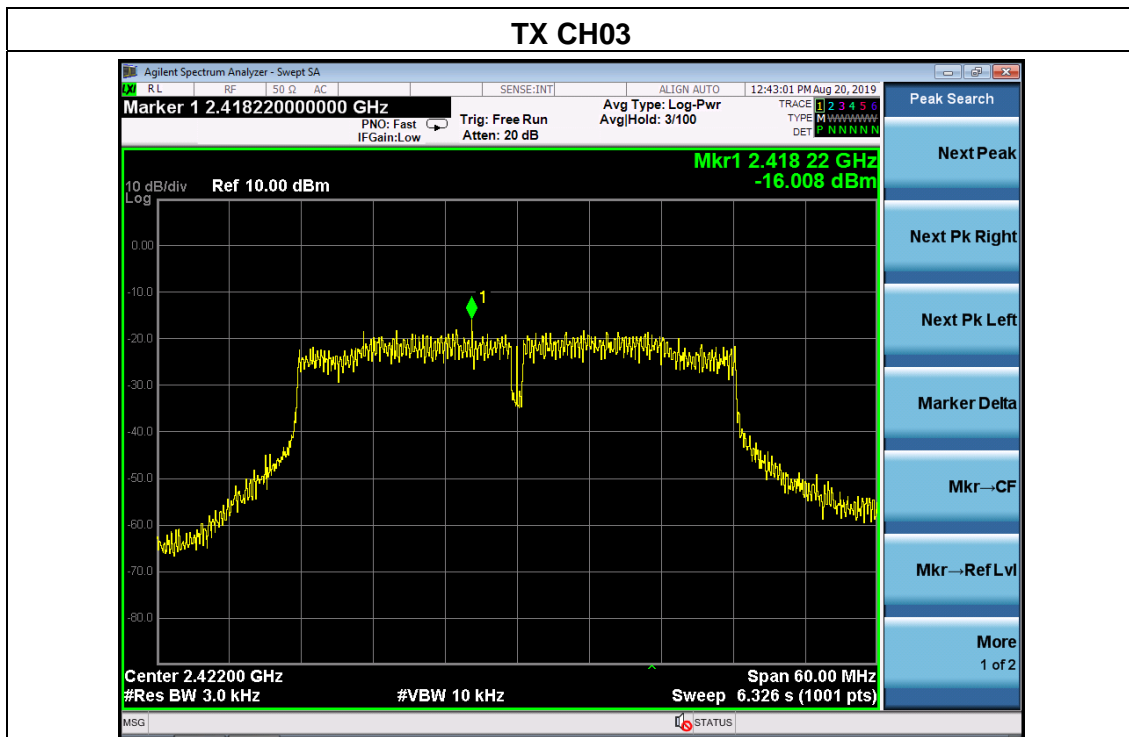



TX CH06

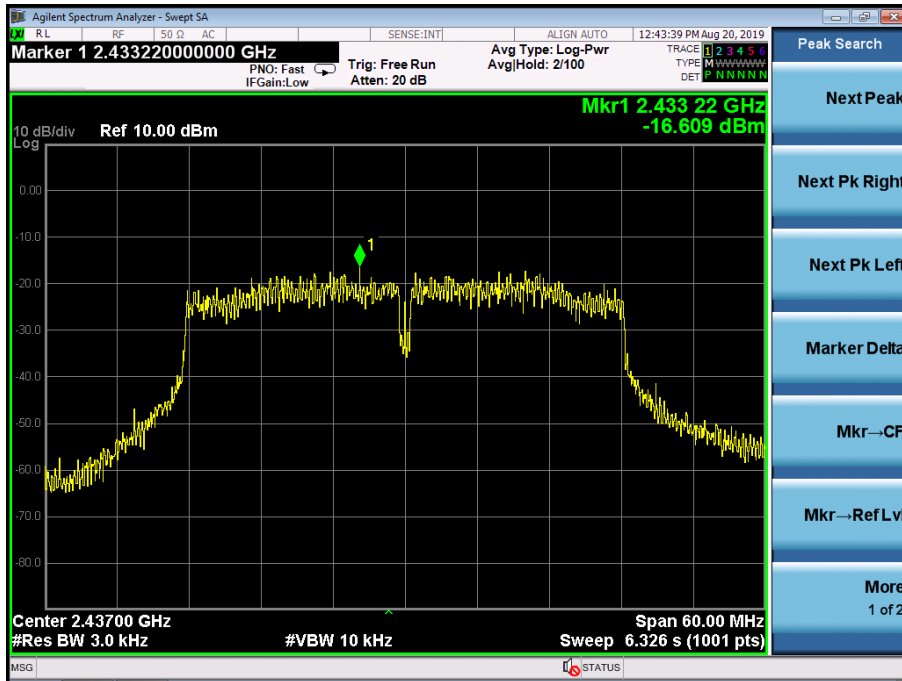

TX CH09

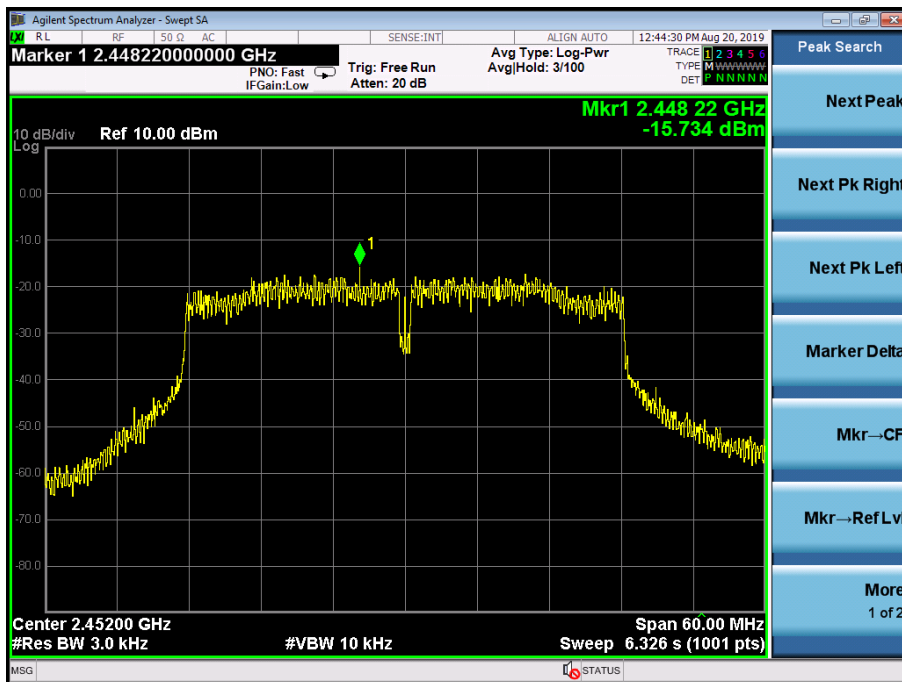

5. BANDWIDTH TEST

5.1 APPLIED PROCEDURES / LIMIT

FCC Part15 (15.247) , Subpart C				
Section	Test Item	Limit	Frequency Range (MHz)	Result
15.247(a)(2)	Bandwidth	$\geq 500\text{KHz}$ (6dB bandwidth)	2400-2483.5	PASS

5.1.1 TEST PROCEDURE

1. Set RBW = 100 kHz.
2. Set the video bandwidth (VBW) $\geq 3 \times$ RBW.
3. Detector = Peak.
4. Trace mode = max hold.
5. Sweep = auto couple.
6. Allow the trace to stabilize.
7. Measure the maximum width of the emission that is constrained by the frequencies associated with the two outermost amplitude points (upper and lower frequencies) that are attenuated by 6 dB relative to the maximum level measured in the fundamental emission.

5.1.2 DEVIATION FROM STANDARD

No deviation.

5.1.3 TEST SETUP



5.1.4 EUT OPERATION CONDITIONS

The EUT tested system was configured as the statements of 2.4 Unless otherwise a special operating condition is specified in the follows during the testing.

5.1.5 TEST RESULTS

Temperature :	26 °C	Relative Humidity :	54%
Pressure :	101kPa	Test Voltage :	AC 120V/60Hz
Test Mode :	TX b Mode		

Frequency (MHz)	6dB bandwidth (MHz) ANTA	6dB bandwidth (MHz) ANTB	Limit (kHz)	Result
2412	9.13	9.45	500	Pass
2437	9.13	9.12	500	Pass
2462	9.36	9.13	500	Pass

Note: A(B) Represent the value of antenna A and B, The worst data is Antenna A ,only shown Antenna A Plot.

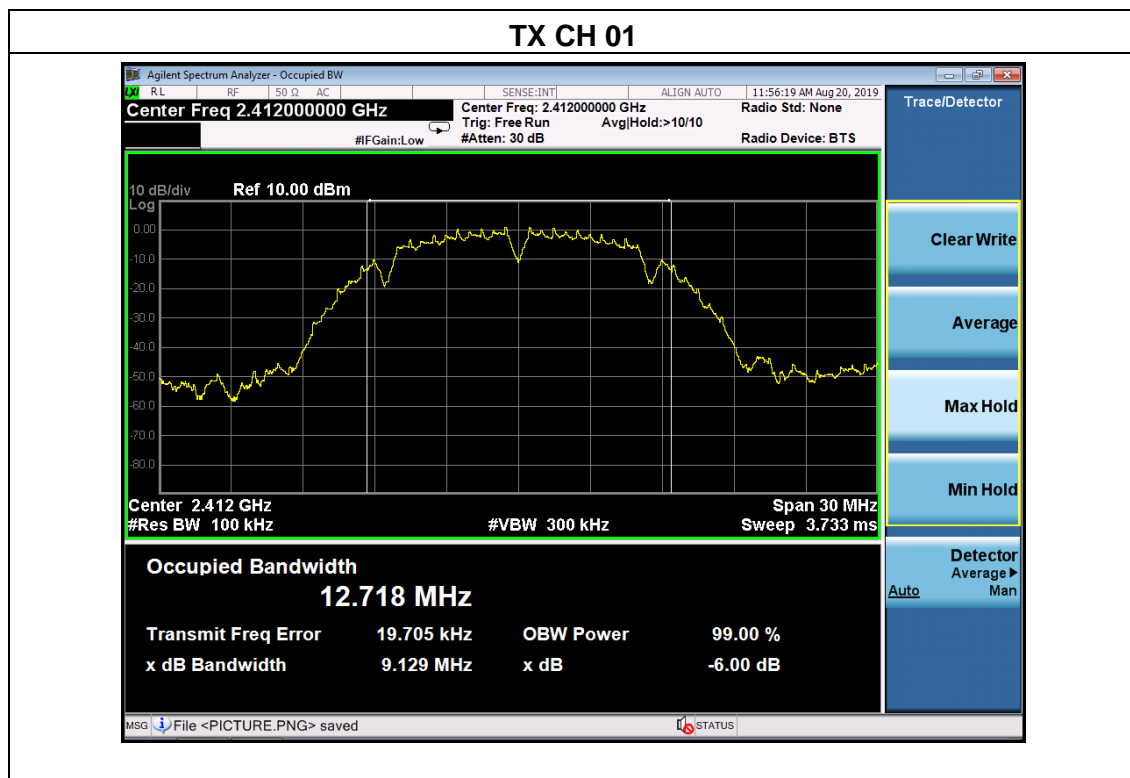



TX CH 06

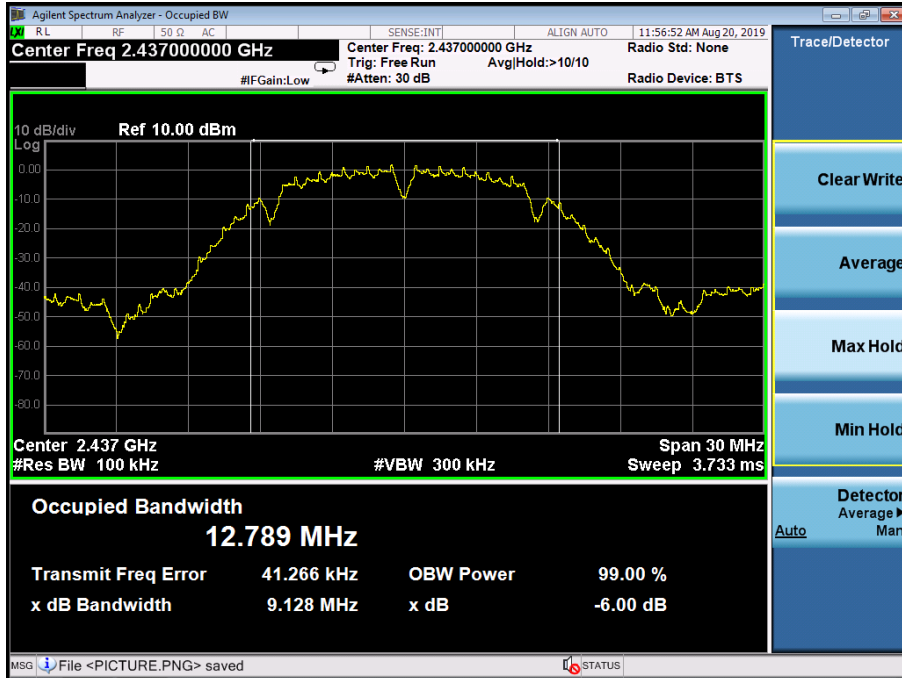

TX CH 11

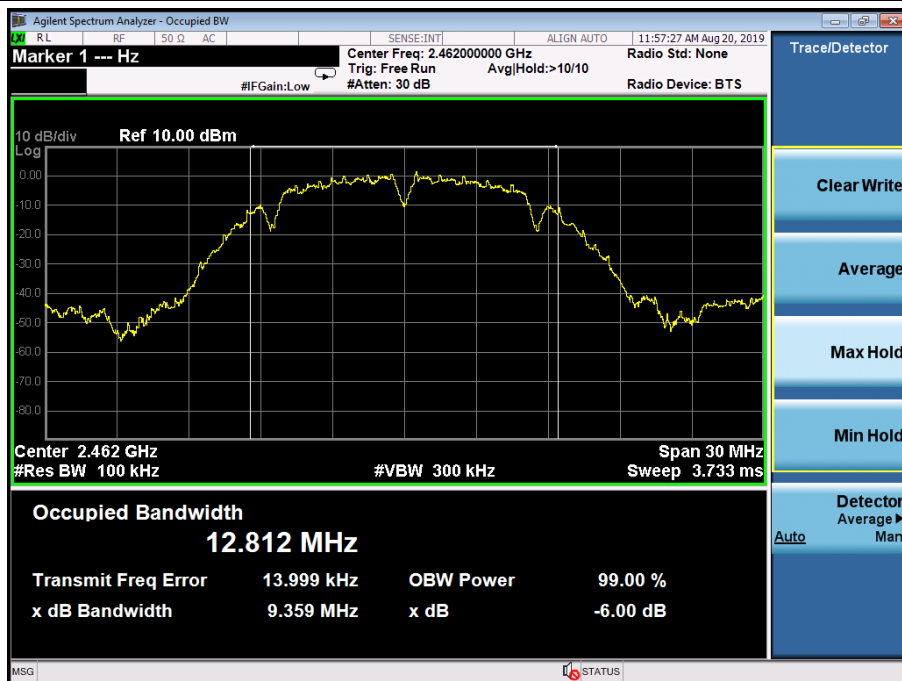



Temperature :	26 °C	Relative Humidity :	54%
Pressure :	101kPa	Test Voltage :	AC 120V/60Hz
Test Mode :	TX g Mode		

Frequency (MHz)	6dB bandwidth (MHz) ANTA	6dB bandwidth (MHz) ANTB	Limit (kHz)	Result
2412	15.12	15.27	500	Pass
2437	15.12	14.70	500	Pass
2462	15.13	15.10	500	Pass

Note: A(B) Represent the value of antenna A and B, The worst data is Antenna A ,only shown Antenna A Plot.

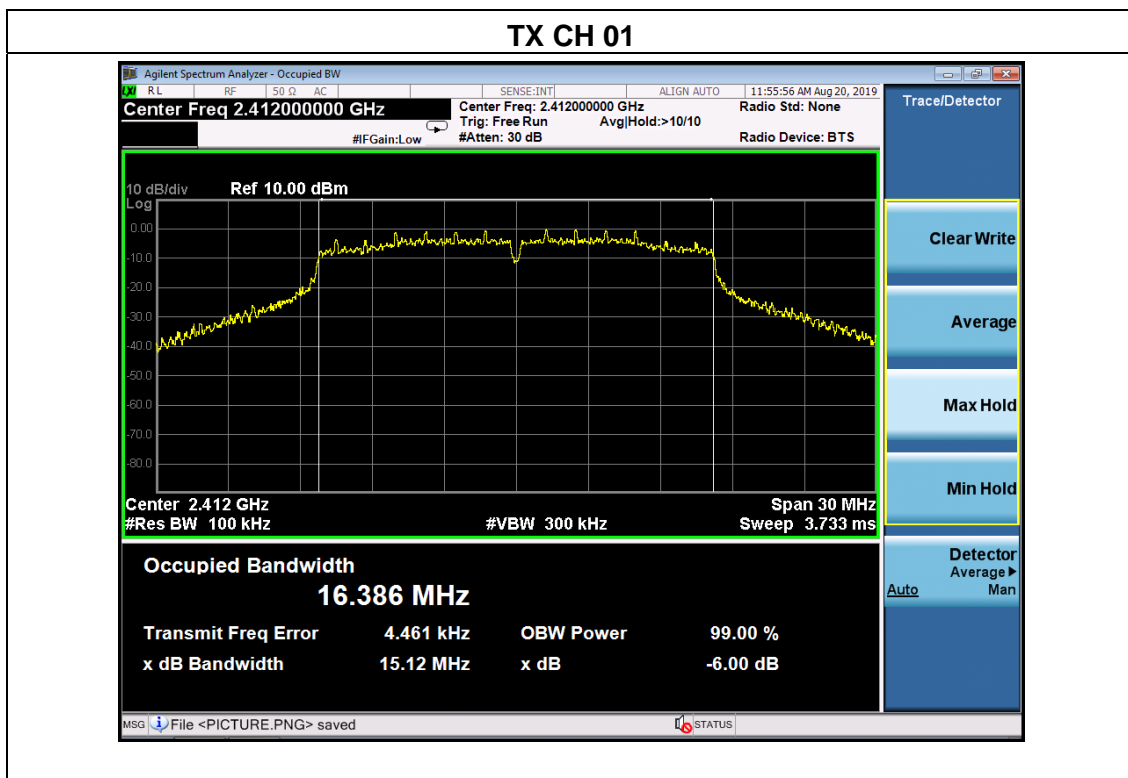



TX CH 06

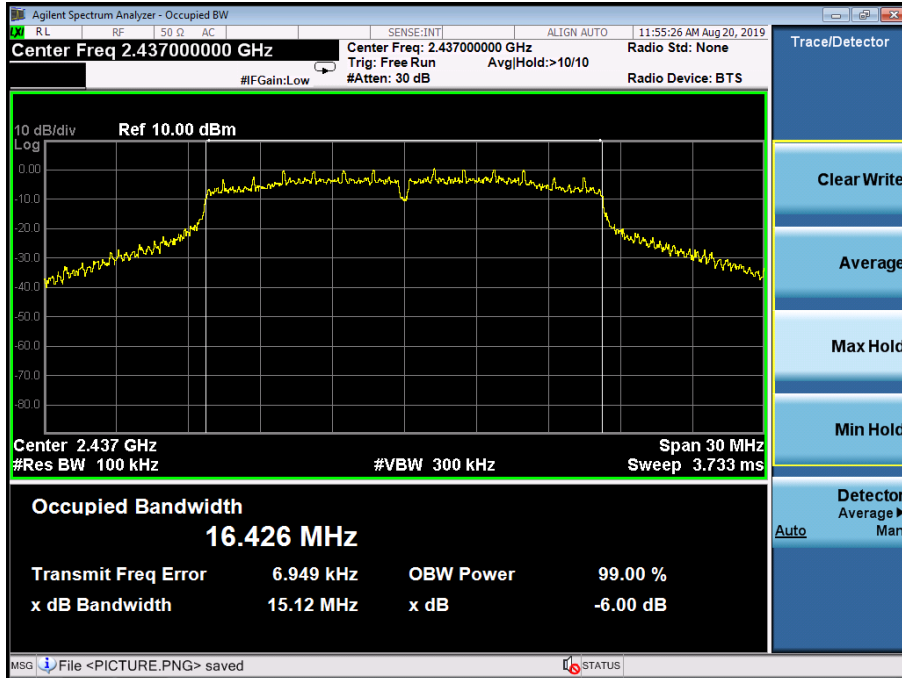

TX CH 11

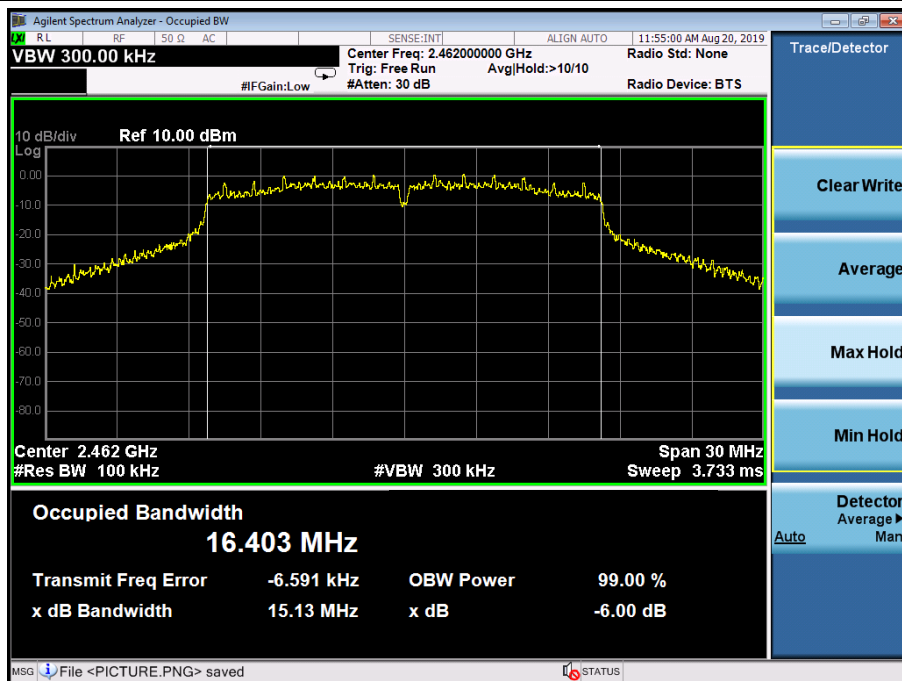



Temperature :	26 °C	Relative Humidity :	54%
Pressure :	101kPa	Test Voltage :	AC 120V/60Hz
Test Mode :	TX n Mode(20M)		

Frequency (MHz)	6dB bandwidth (MHz) ANTA	6dB bandwidth (MHz) ANTB	Limit (kHz)	Result
2412	15.66	15.64	500	Pass
2437	15.07	15.12	500	Pass
2462	15.36	15.04	500	Pass

Note: A(B) Represent the value of antenna A and B, The worst data is Antenna A ,only shown Antenna A Plot.

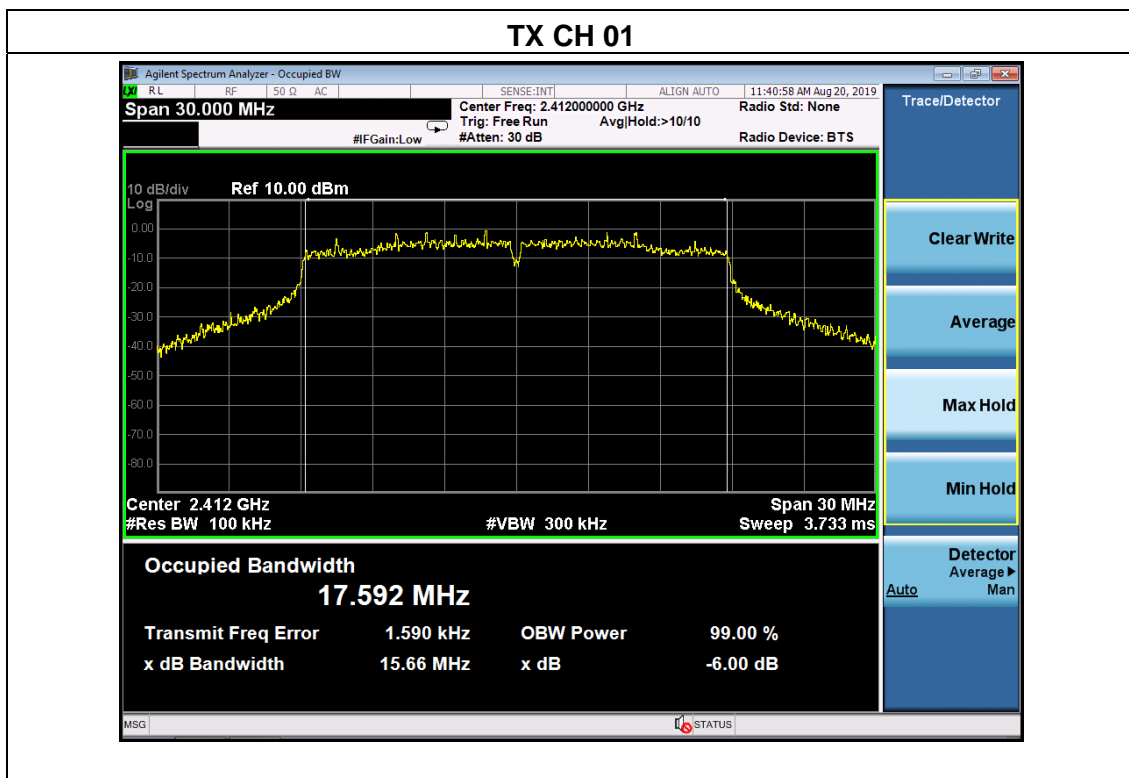



TX CH 06

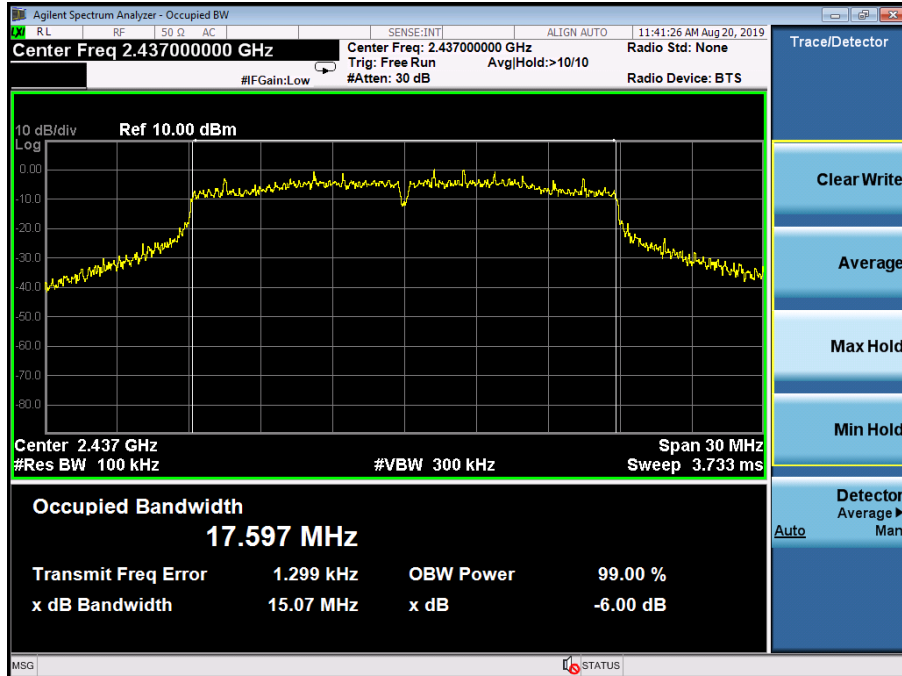

TX CH 11

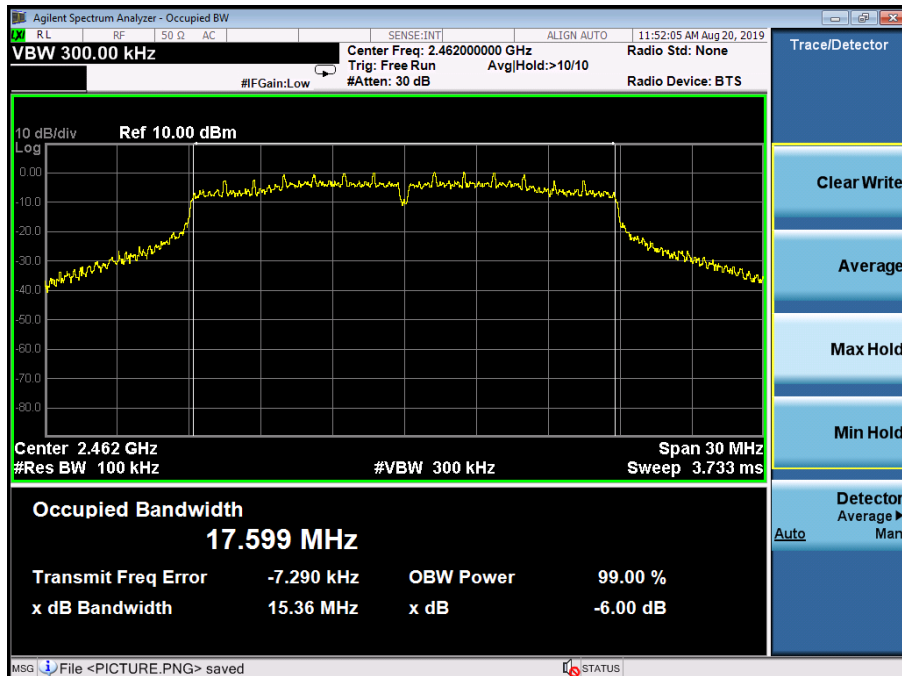



Temperature :	26 °C	Relative Humidity :	54%
Pressure :	101kPa	Test Voltage :	AC 120V/60Hz
Test Mode :	TX n Mode(40M)		

Frequency (MHz)	6dB bandwidth (MHz) ANTA	6dB bandwidth (MHz) ANTB	Limit (kHz)	Result
2422	35.09	35.11	500	Pass
2437	33.80	35.10	500	Pass
2452	35.10	35.04	500	Pass

Note: A(B) Represent the value of antenna A and B, The worst data is Antenna A ,only shown Antenna A Plot.

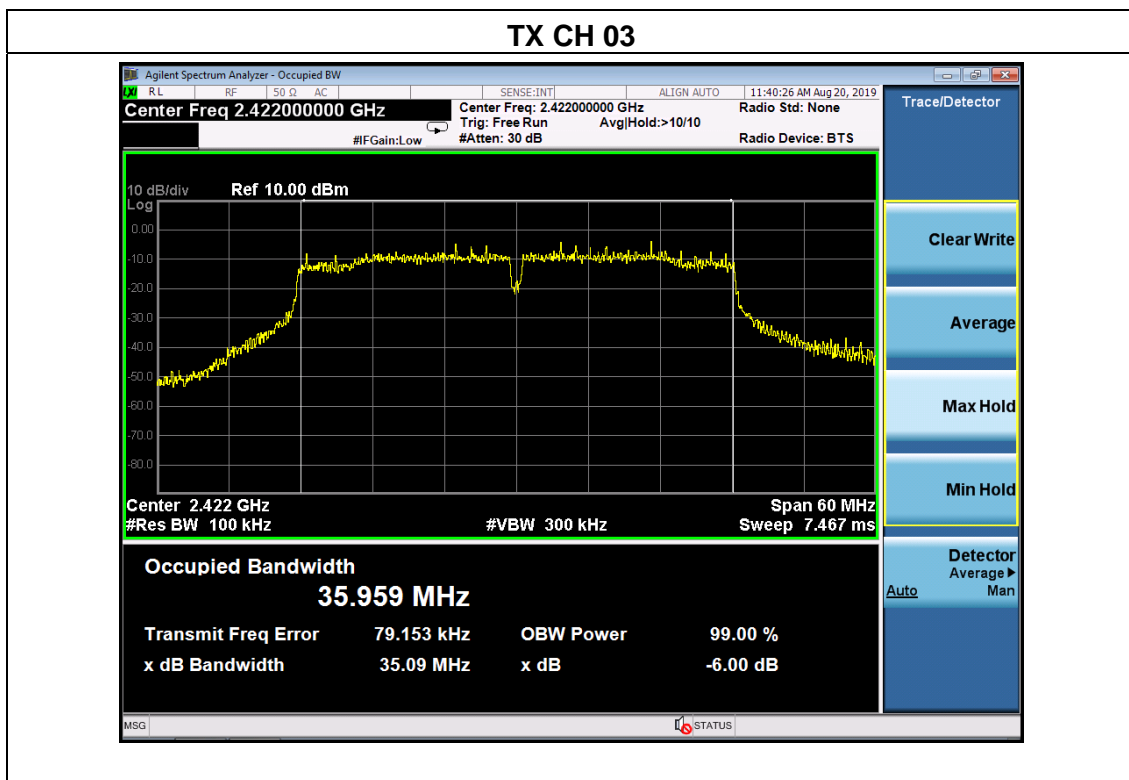

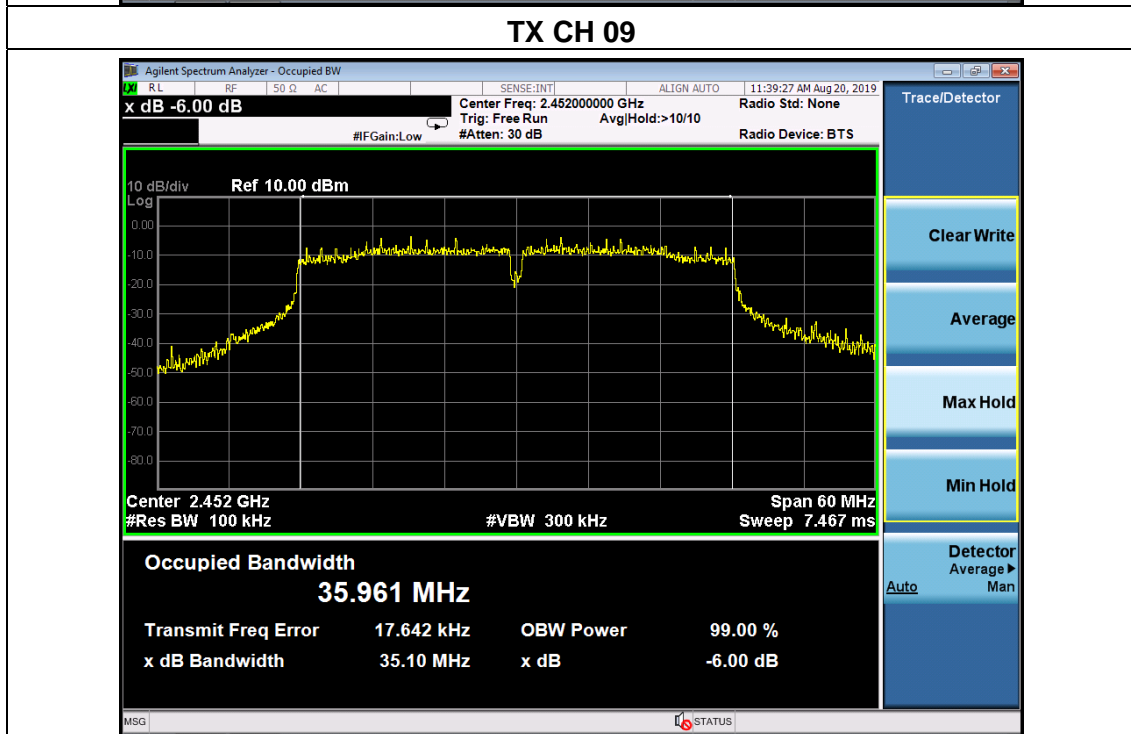
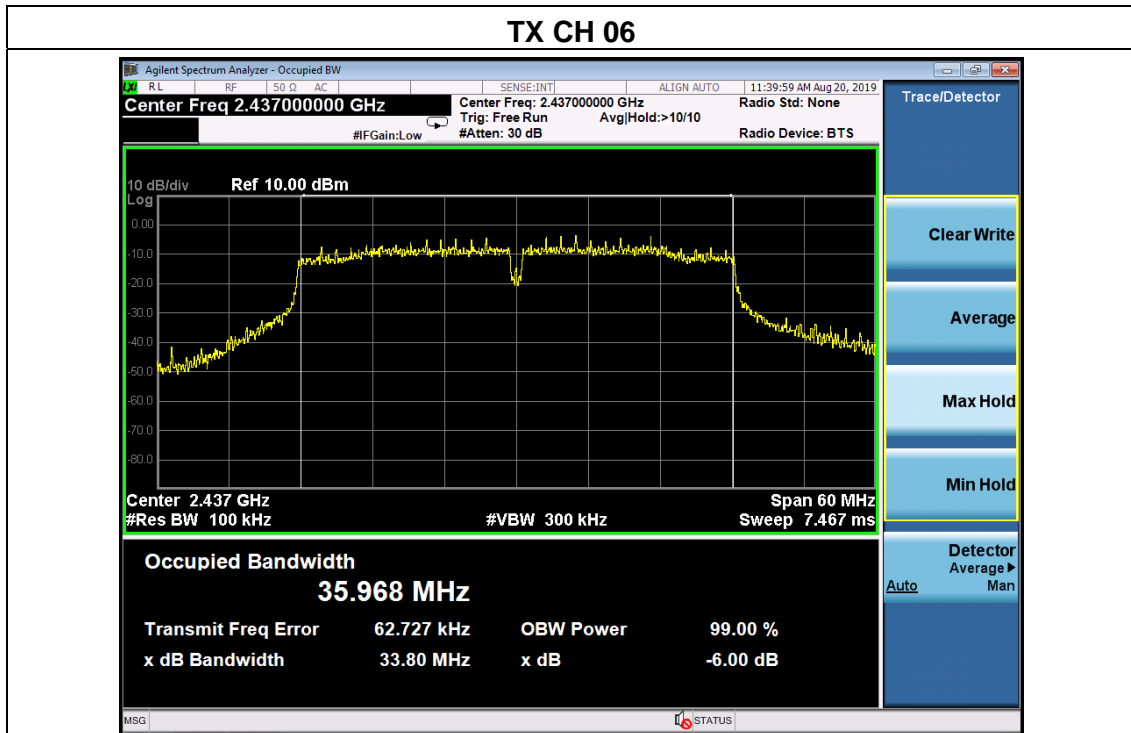

6. PEAK OUTPUT POWER TEST

6.1 APPLIED PROCEDURES/LIMIT

FCC Part15 (15.247) , Subpart C				
Section	Test Item	Limit	Frequency Range (MHz)	Result
15.247(b)(3)	Peak Output Power	1 watt or 30dBm	2400-2483.5	PASS

6.1.1 TEST PROCEDURE

- a. The EUT was directly connected to the Power meter

6.1.2 DEVIATION FROM STANDARD

No deviation.

6.1.3 TEST SETUP



6.1.4 EUT OPERATION CONDITIONS

The EUT tested system was configured as the statements of 2.4 Unless otherwise a special operating condition is specified in the follows during the testing.

6.1.5 TEST RESULTS

Temperature :	26 °C	Relative Humidity :	54%
Pressure :	101kPa	Test Voltage :	AC 120V/60Hz

	Frequency	Maximum Conducted Output Power(PK) ANTA	Maximum Conducted Output Power(PK) ANTB	Total Power Conducted Output Power(PK)	LIMIT
	(MHz)	(dBm)	(dBm)	(dBm)	dBm
802.11b	2412	12.32	13.90	/	30
	2437	13.84	12.92	/	30
	2462	13.06	13.14	/	30
802.11g	2412	13.90	13.31	/	30
	2437	13.18	13.63	/	30
	2462	14.09	13.79	/	30
802.11n 20	2412	13.76	13.06	16.43	29.99
	2437	13.71	13.47	16.60	29.99
	2462	13.46	14.36	16.94	29.99
802.11n 40	2422	11.43	11.39	14.42	29.99
	2437	11.54	11.65	14.61	29.99
	2452	11.65	11.678	14.67	29.99

Antenna A gain: 3dBi, Antenna B gain: 3dBi, Directional gain=[10log(GA+ G B)] dbi =6.01dbi
 limit=30-(6.01-6)=29.99

7. 100 KHZ BANDWIDTH OF FREQUENCY BAND EDGE

7.1 APPLICABLE STANDARD

in any 100 kHz bandwidth outside the frequency bands in which the spread spectrum intentional radiator is operating, the radio frequency power that is produced by the intentional radiator shall be at least 20dB below that in the 100kHz bandwidth within the band that contains the highest level of the desired power, In addition, radiated emissions which fall in the restricted bands, as defined in§15.205(a), must also comply with the radiated emission limits specified in15.209(a).

7.2 TEST PROCEDURE

Using the following spectrum analyzer setting:

- Establish a reference level by using the following procedure:
 - a) Set instrument center frequency to DTS channel center frequency.
 - b) Set the span to 1.5 times the DTS bandwidth.
 - c) Set the RBW = 100 kHz.
 - d) Set the VBW [3 ×RBW].
 - e) Detector = peak.
 - f) Sweep time = auto couple.
 - g) Trace mode = max hold.
 - h) Allow trace to fully stabilize.
 - i) Use the peak marker function to determine the maximum PSD level.
- Note that the channel found to contain the maximum PSD level can be used to establish the reference level.

7.3 DEVIATION FROM STANDARD

No deviation.

7.4 TEST SETUP

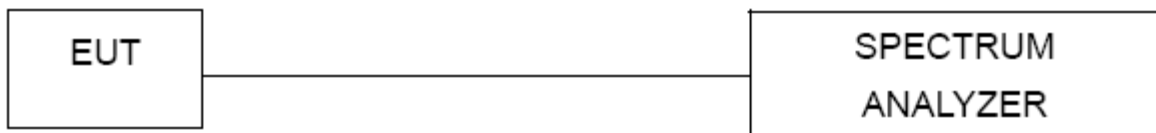

7.5 EUT OPERATION CONDITIONS

The EUT tested system was configured as the statements of 2.4 Unless otherwise a special operating condition is specified in the follows during the testing.

7.1 TEST RESULTS



Note: A(B) Represent the value of antenna A and B, The worst data is Antenna A ,only shown Antenna A Plot.

802.11b: Band Edge, Left Side

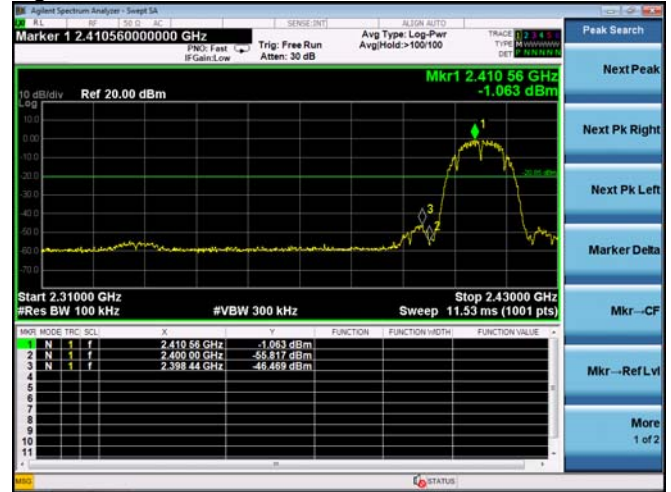
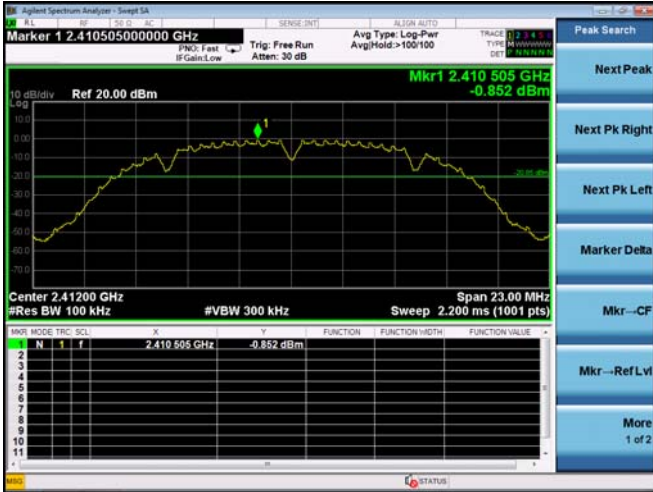

802.11b: Band Edge, Right Side

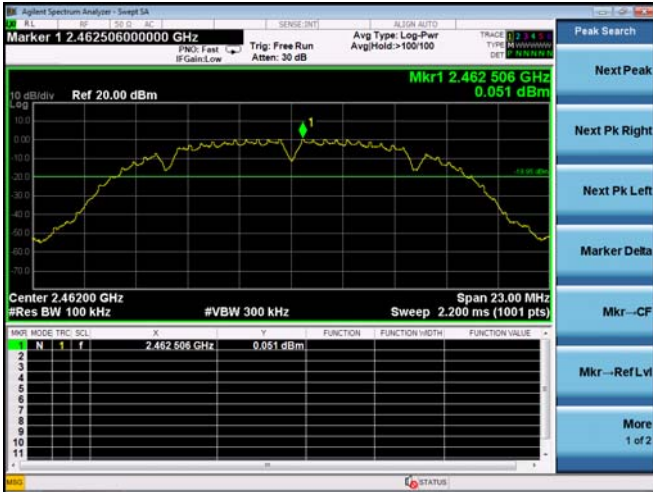



802.11g: Band Edge, Left Side

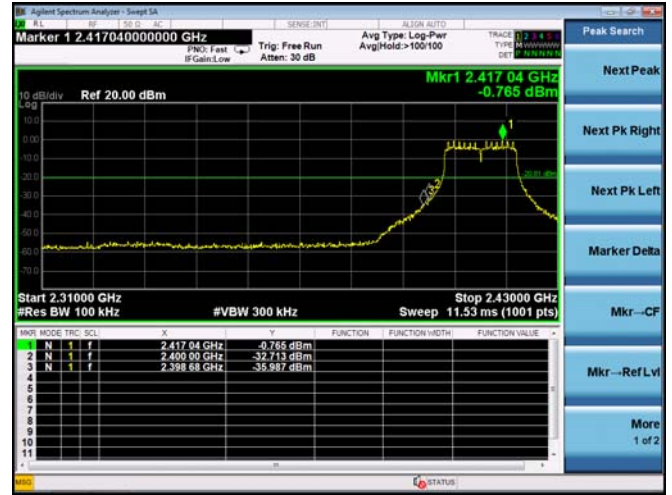
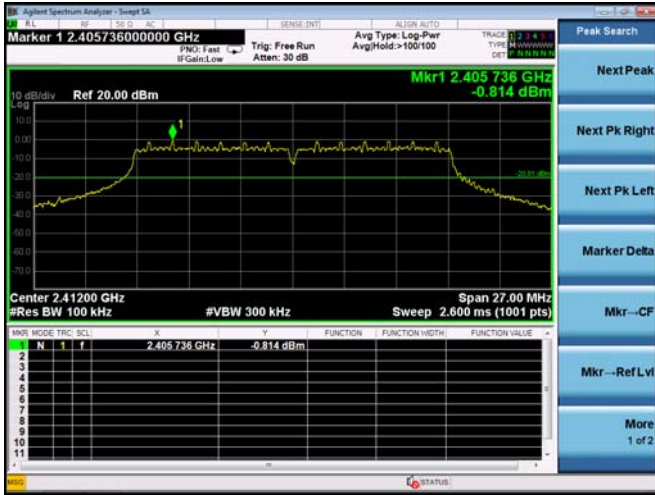

802.11g: Band Edge, Right Side

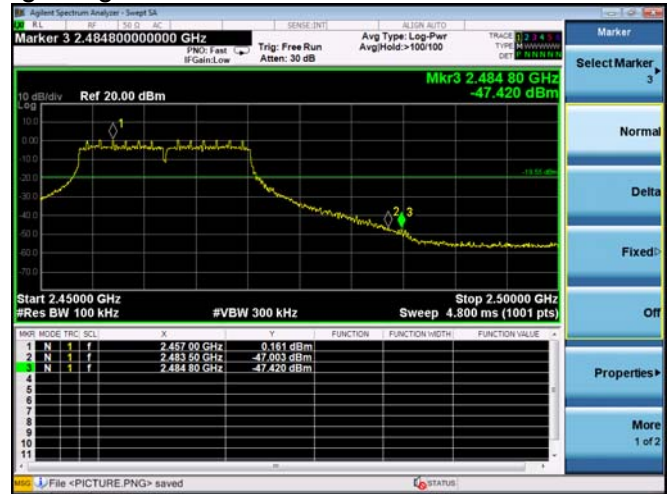
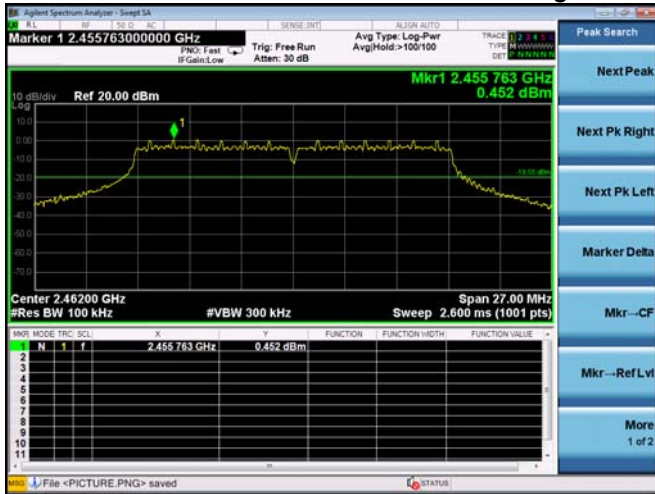



802.11n-HT20: Band Edge, Left Side

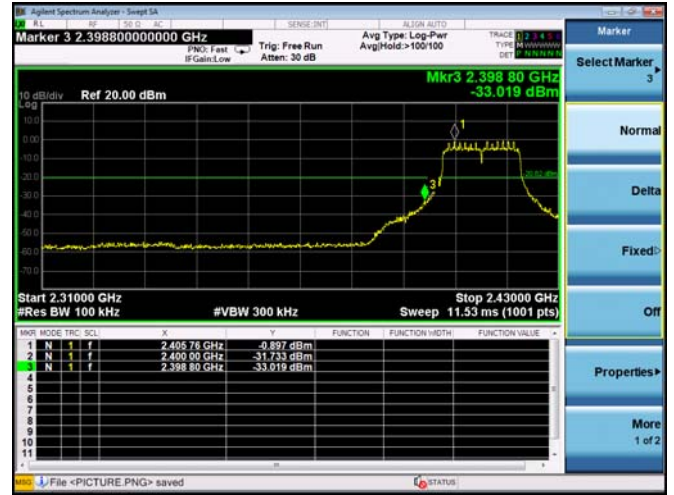
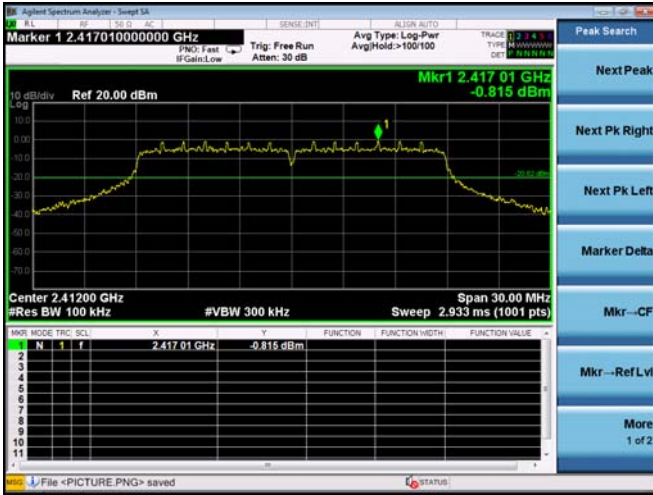

802.11n-HT20: Band Edge, Right Side

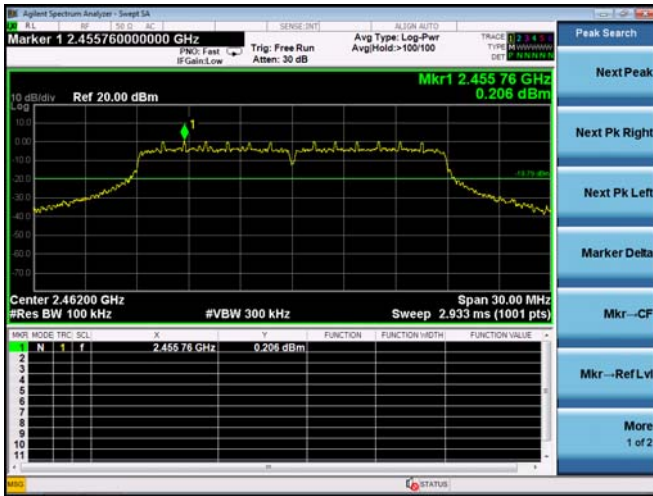



802.11n-HT40: Band Edge, Left Side

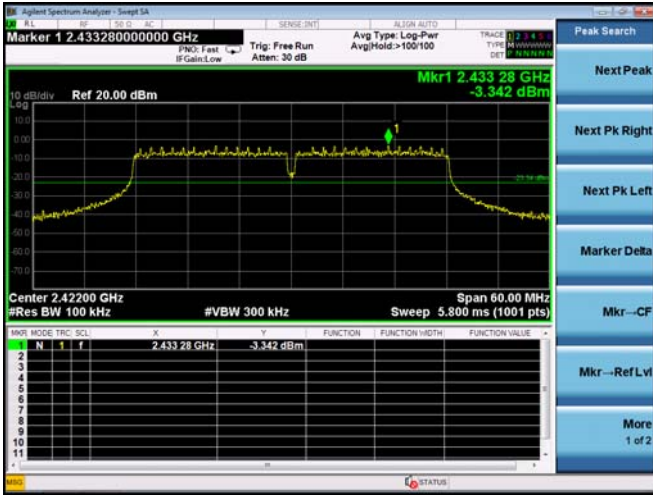

802.11n-HT40: Band Edge, Right Side

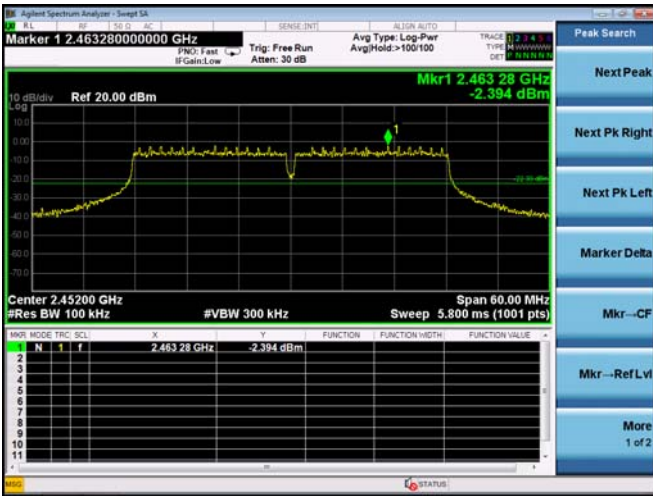



CONDUCTED EMISSION MEASUREMENT

802.11b

Low Channel 2412MHz



Middle Channel 2437MHz

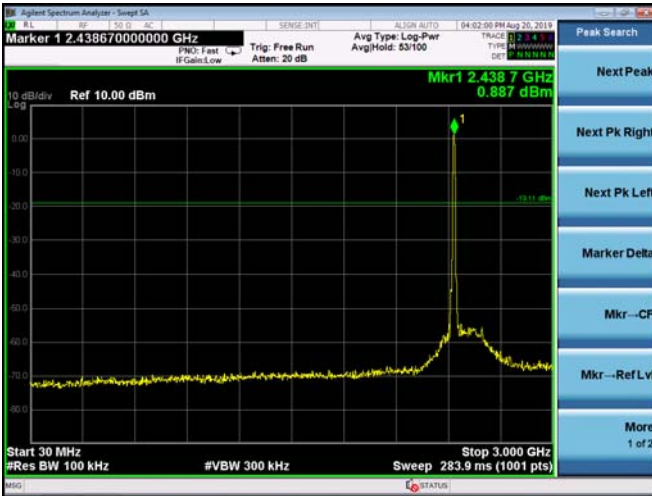

High Channel 2462MHz





802.11g

Low Channel 2412MHz

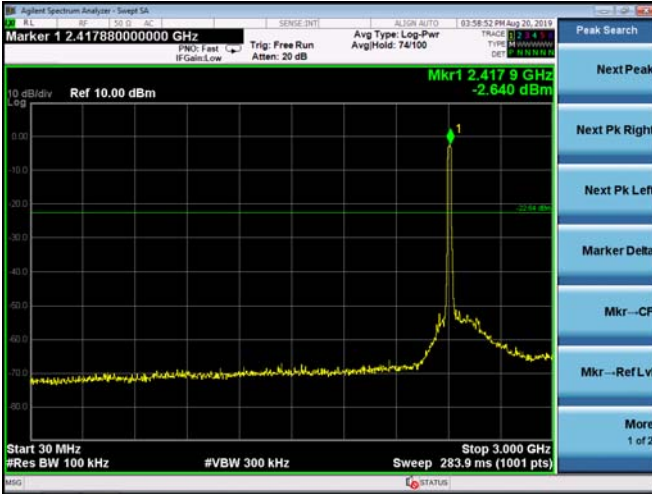

Middle Channel 2437MHz

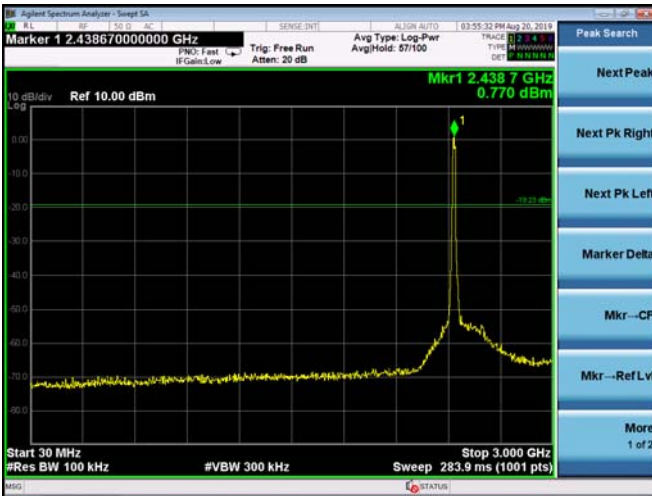

High Channel 2462MHz

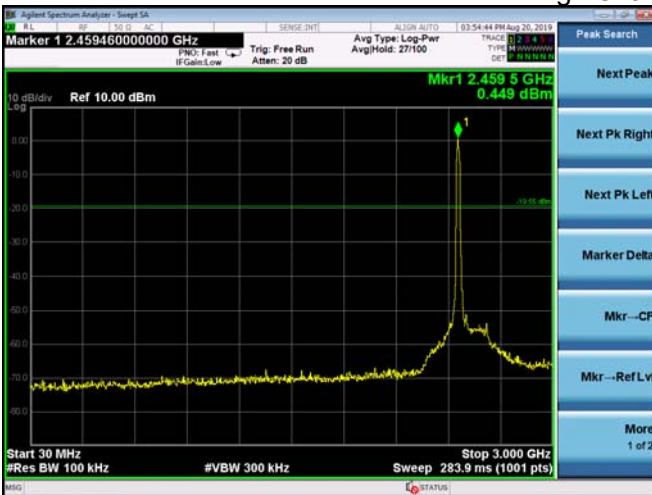



802.11n20

Low Channel 2412MHz

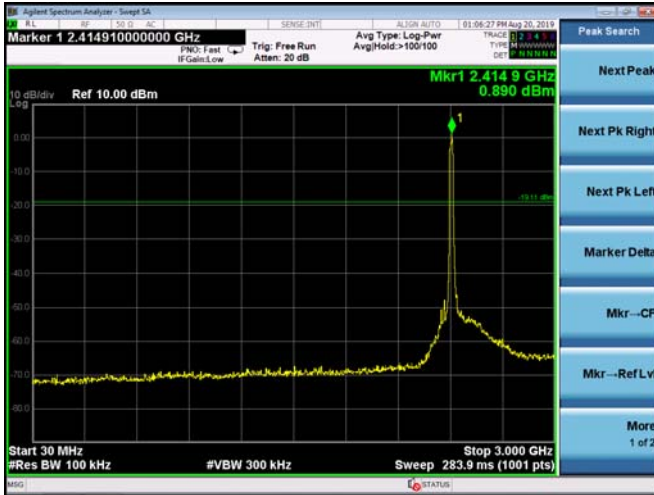

Middle Channel 2437MHz

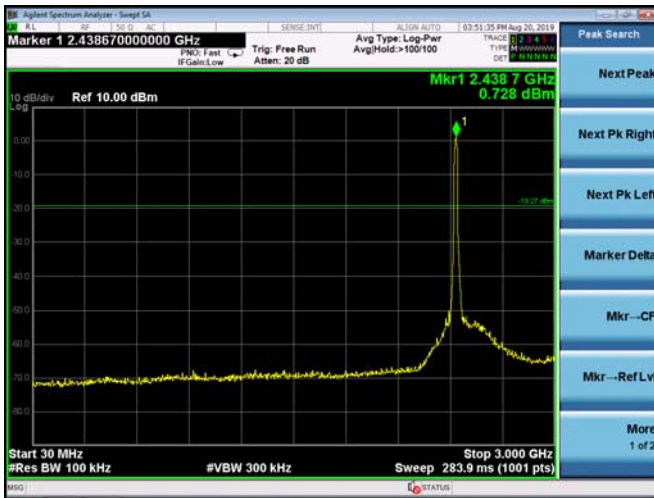

High Channel 2462MHz

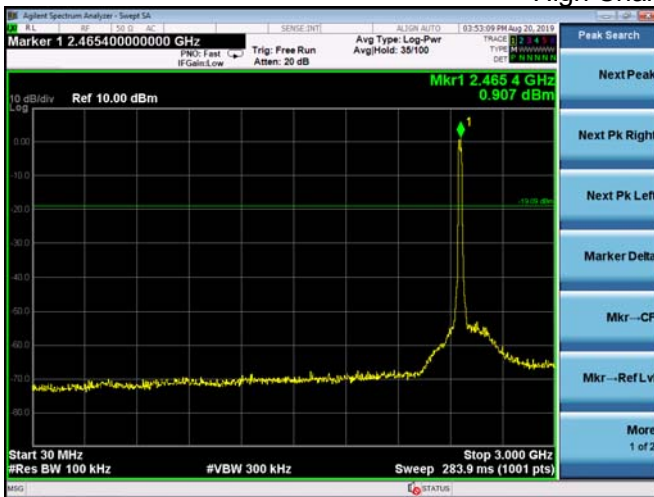



802.11n40

Low Channel 2422MHz

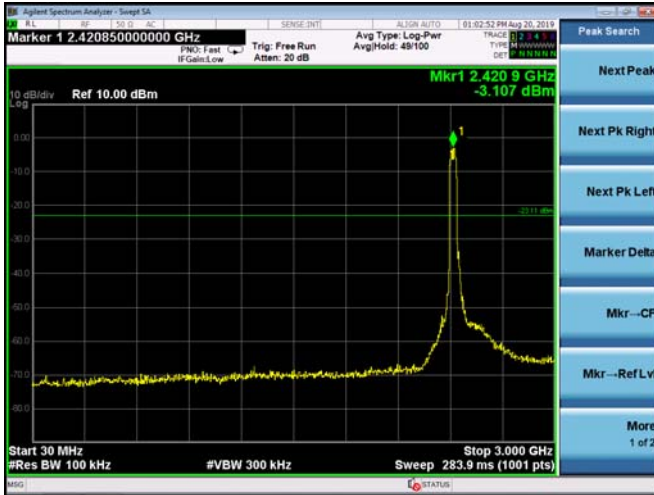

Middle Channel 2437MHz

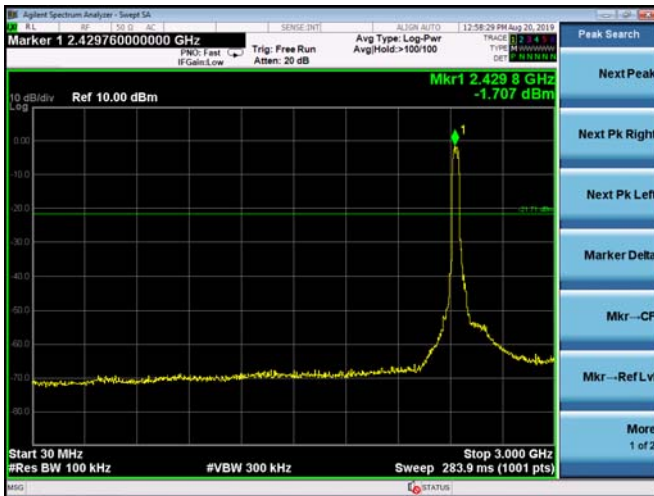

High Channel 2452MHz

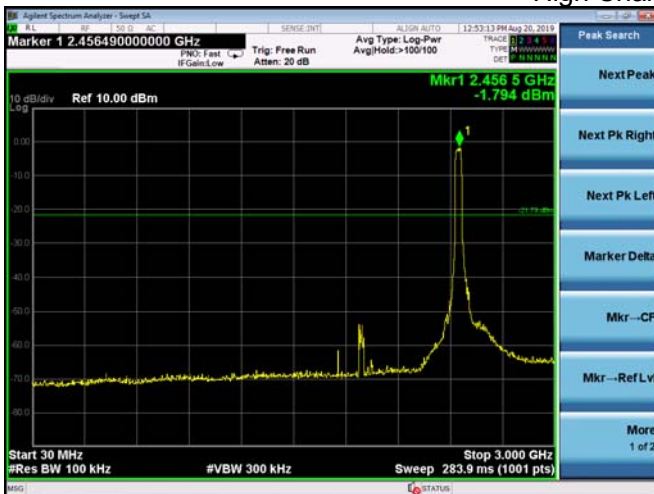



8. DUTY CYCLE OF TEST SIGNAL

8.1 STANDARD REQUIREMENT

Pre-analysis Check: While conducting average power measurement, duty cycle of each mode shall be checked to ensure its duty cycle in order to compensate for the loss due to insufficient ratio of duty cycle.

All duty cycle is pre-scanned, and result as obtained below shows only the most representative ones where duty cycle is conducted as the given transmission with given virtual operation that expresses the percentage.

8.2 FORMULA:

Duty Cycle = $T_{on} / (T_{on} + T_{off})$

Measurement Procedure:

1. Set span = Zero
2. RBW = 8MHz
3. VBW = 8MHz,
4. Detector = Peak

Duty Cycle:

	Duty Cycle	Duty Fator (dB)
802.11b	1	0
802.11g	1	0
802.11n(HT20)	1	0
802.11n(HT40)	1	0



802.11b

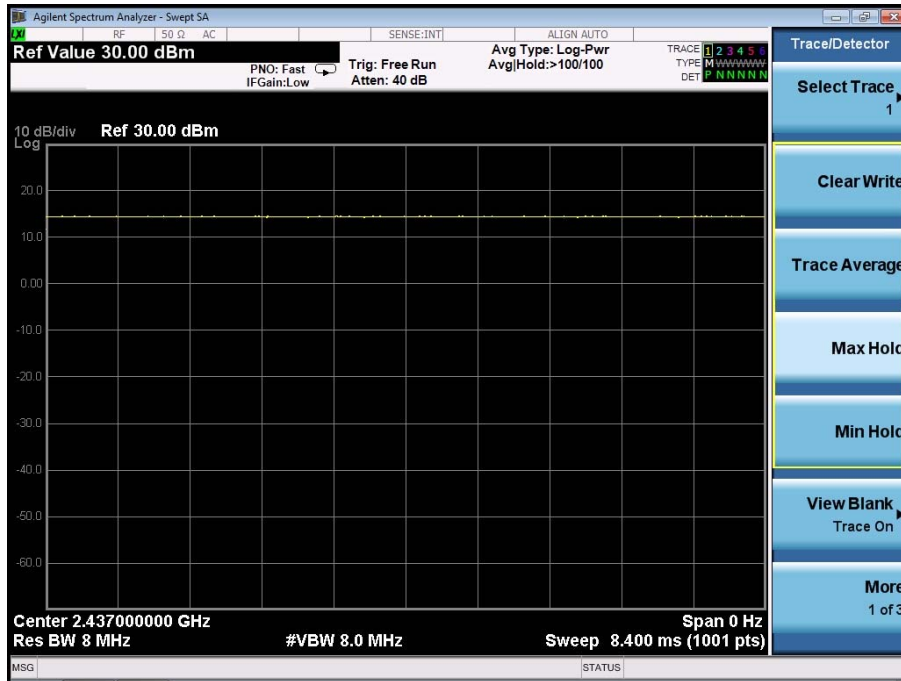

802.11g

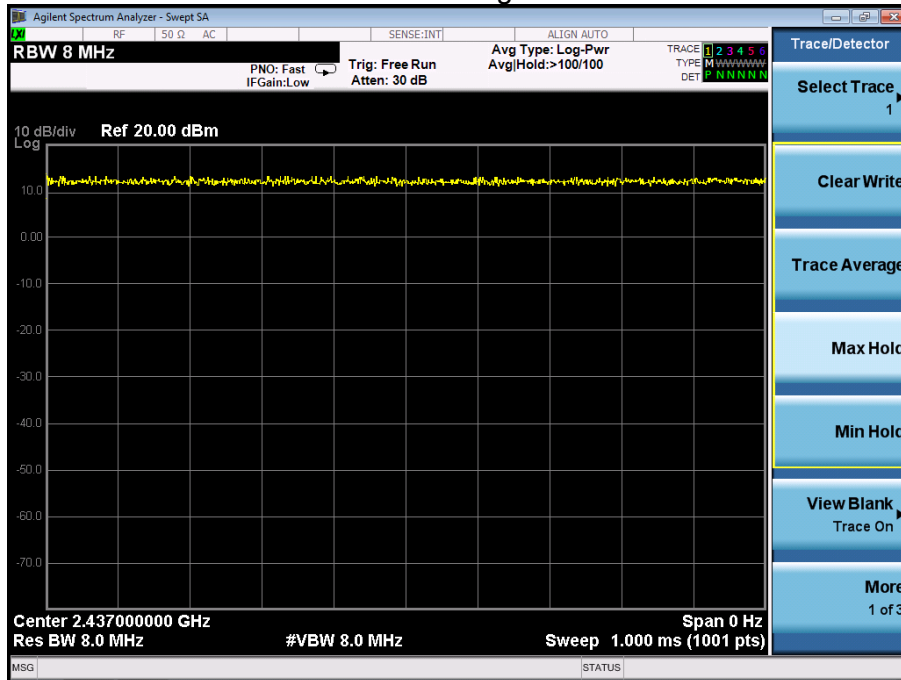



802.11n(HT20)

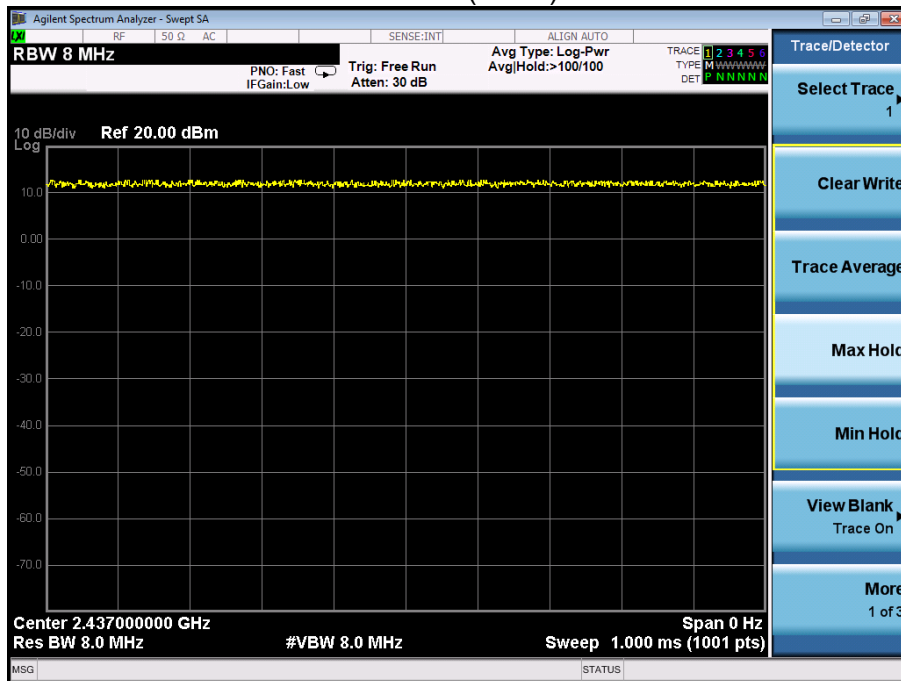

802.11n(HT40)

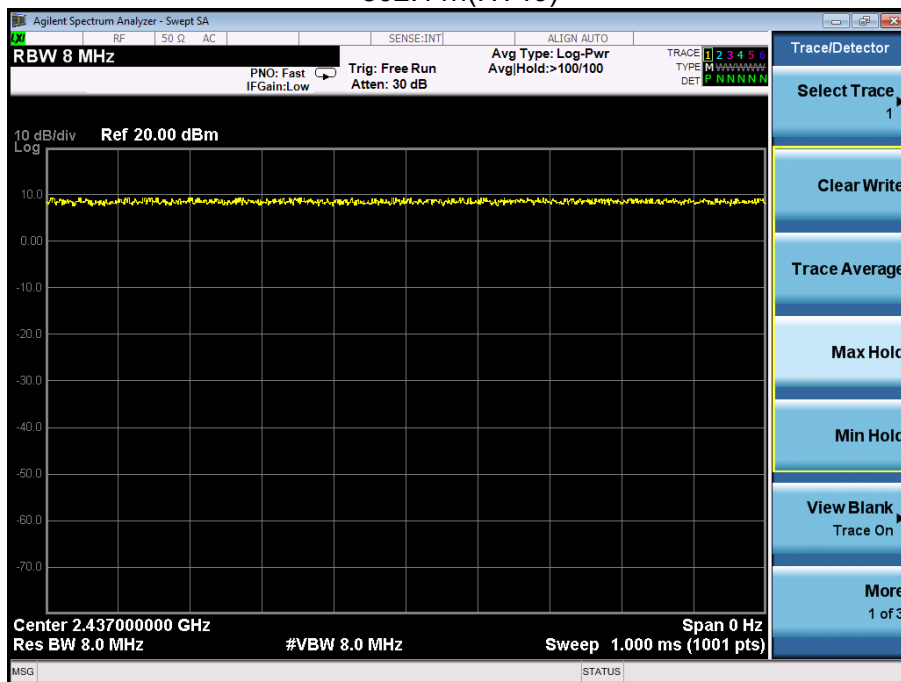



9. ANTENNA REQUIREMENT

9.1 STANDARD REQUIREMENT

15.203 requirement: For intentional device, according to 15.203: an intentional radiator shall be designed to ensure that no antenna other than that furnished by the responsible party shall be used with the device.

9.2 EUT ANTENNA

The EUT antenna is R-SMA antenna*2, antenna Gain 3dBi. It comply with the standard requirement.



10. EUT TEST PHOTO

Conducted Measurement Photos





Radiated Measurement Photos

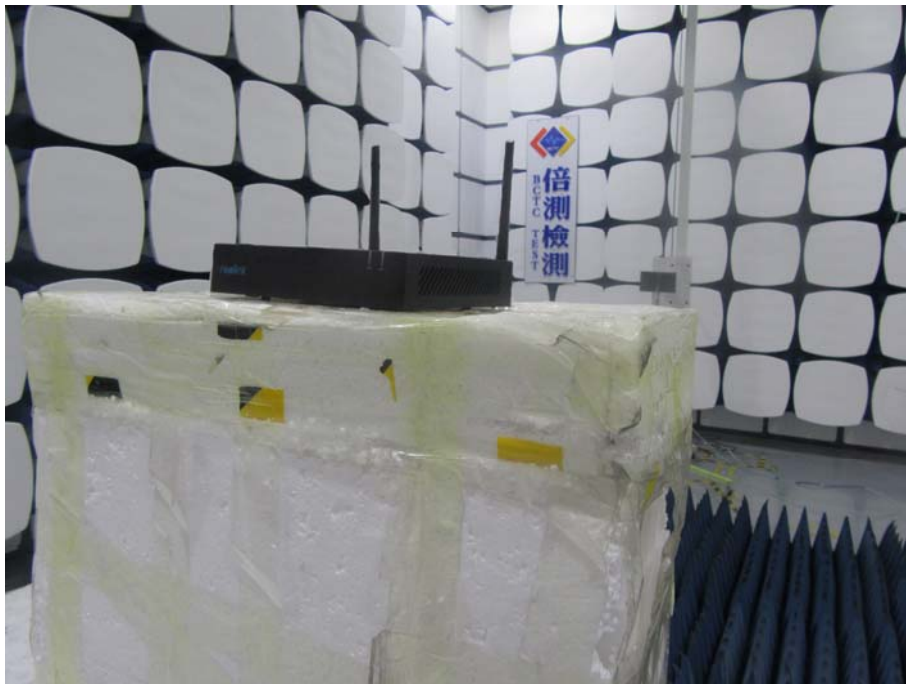
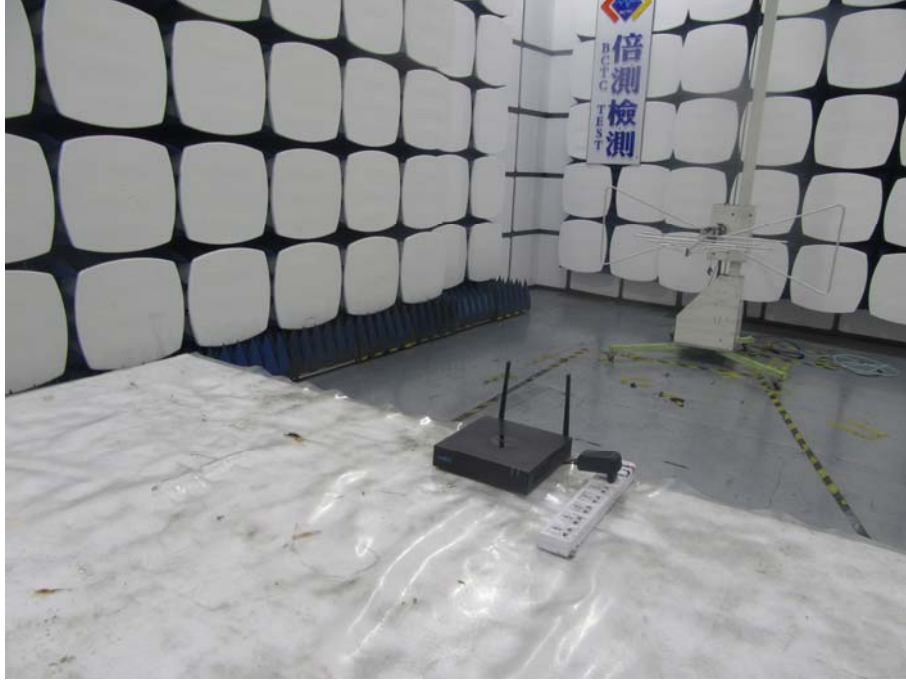



11. EUT PHOTO



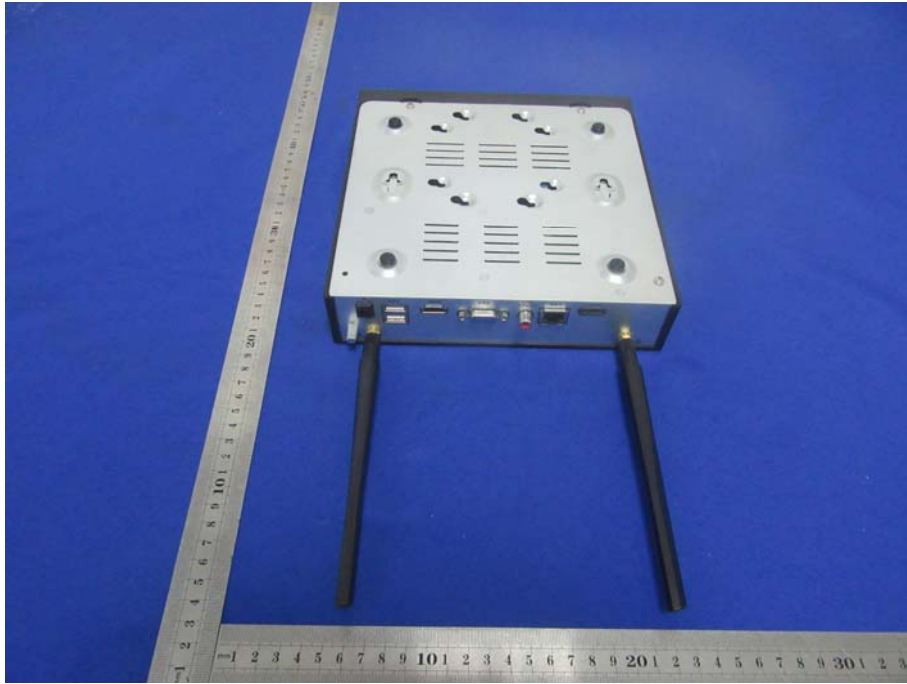

※※※※※ END OF REPORT ※※※※※