



# FCC Part 15C Test Report

## FCC ID: 2AL7VC1PRO

Product Name:	WiFi IP Camera
Trademark:	
Model Name :	C1 Pro
Prepared For :	Shenzhen Reo-link Digital Technology Co., Ltd
Address :	B509 University Town Business Park LiShan Road, NanShan, Shenzhen Guangdong China 518055
Prepared By :	Shenzhen BCTC Testing Co., Ltd.
Address :	BCTC Building & 1-2F, East of B Building, Pengzhou Industrial, Fuyuan 1st Road, Qiaotou Community, Fuyong Street, Bao'an District, Shenzhen, China
Test Date:	Nov. 13, 2017 – Dec. 03, 2017
Date of Report :	Dec. 05, 2017
Report No.:	BCTC-LH171104127E



### TEST RESULT CERTIFICATION

**Applicant's name**..... : Shenzhen Reo-link Digital Technology Co., Ltd  
 Address..... : B509 University Town Business Park LiShan Road,  
 NanShan, Shenzhen Guangdong China 518055  
**Manufacture's Name**..... : SHENZHEN BAICHUAN SECURITY TECHNOLOGY  
 CO.,LTD  
 Address..... : 5th Floor, Building 7, Tangtou 3rd Industrial Area, Shiyan  
 Town, Bao'an District, Shenzhen City, China

#### Product description



Product name.....: WiFi IP Camera  
 Trademark.....: 

Model and/or type reference : C1 Pro

**Standards**..... : FCC Part15.247  
 ANSI C63.10:2013  
 KBD 558074 D01 DTS Meas Guidance v03r05  
 KDB 662911 D01 Multiple Transmitter Output v02r01

This device described above has been tested by BCTC, and the test results show that the equipment under test (EUT) is in compliance with the FCC requirements. And it is applicable only to the tested sample identified in the report.

This report shall not be reproduced except in full, without the written approval of BCTC, this document may be altered or revised by BCTC, personal only, and shall be noted in the revision of the document.

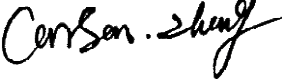
Prepared by(Engineer):	Snow Zeng	
Reviewer(Supervisor):	Jade Yang	
Approved(Manager):	Carson Zhang	





<b>Table of Contents</b>	<b>Page</b>
<b>1 . SUMMARY OF TEST RESULTS</b>	<b>5</b>
1.1 TEST FACILITY	6
1.2 MEASUREMENT UNCERTAINTY	6
<b>2 . GENERAL INFORMATION</b>	<b>7</b>
2.1 GENERAL DESCRIPTION OF EUT	7
2.2 DESCRIPTION OF TEST MODES	8
2.3 BLOCK DIGRAM SHOWING THE CONFIGURATION OF SYSTEM TESTED	9
2.4 DESCRIPTION OF TEST UNITS	9
2.5 EQUIPMENTS LIST FOR ALL TEST ITEMS	10
<b>3 . EMC EMISSION TEST</b>	<b>11</b>
3.1 CONDUCTED EMISSION MEASUREMENT	11
3.1.1 POWER LINE CONDUCTED EMISSION LIMITS	11
3.1.2 TEST PROCEDURE	11
3.1.3 DEVIATION FROM TEST STANDARD	11
3.1.4 TEST SETUP	12
3.1.5 EUT OPERATING CONDITIONS	12
3.1.6 TEST RESULTS	12
3.2 RADIATED EMISSION MEASUREMENT	15
3.2.1 RADIATED EMISSION LIMITS	15
3.2.2 TEST PROCEDURE	16
3.2.3 DEVIATION FROM TEST STANDARD	16
3.2.4 TEST SETUP	16
3.2.5 EUT OPERATING CONDITIONS	17
3.2.6 TEST RESULTS (BETWEEN 9KHZ – 30 MHZ)	18
3.2.7 TEST RESULTS (BETWEEN 30MHZ – 1GHZ)	19
3.2.8 TEST RESULTS (1GHZ~25GHZ)	21
3.3 RADIATED BAND EMISSION MEASUREMENT	26
3.3.1 TEST REQUIREMENT:	26
3.3.2 TEST PROCEDURE	26
3.3.3 DEVIATION FROM TEST STANDARD	27
3.3.4 TEST SETUP	27
3.3.5 EUT OPERATING CONDITIONS	27
<b>4 . POWER SPECTRAL DENSITY TEST</b>	<b>30</b>
4.1 APPLIED PROCEDURES / LIMIT	30



<b>Table of Contents</b>	<b>Page</b>
4.1.1 TEST PROCEDURE	30
4.1.2 DEVIATION FROM STANDARD	30
4.1.3 TEST SETUP	30
4.1.4 EUT OPERATION CONDITIONS	31
4.1.5 TEST RESULTS	32
<b>5 . BANDWIDTH TEST</b>	<b>35</b>
5.1 APPLIED PROCEDURES / LIMIT	35
5.1.1 TEST PROCEDURE	35
5.1.2 DEVIATION FROM STANDARD	35
5.1.3 TEST SETUP	35
5.1.4 EUT OPERATION CONDITIONS	35
5.1.5 TEST RESULTS	36
<b>6 . PEAK OUTPUT POWER TEST</b>	<b>39</b>
6.1 APPLIED PROCEDURES / LIMIT	39
6.1.1 TEST PROCEDURE	39
6.1.2 DEVIATION FROM STANDARD	39
6.1.3 TEST SETUP	39
6.1.4 EUT OPERATION CONDITIONS	39
6.1.5 TEST RESULTS	40
<b>7 . 100 KHZ BANDWIDTH OF FREQUENCY BAND EDGE</b>	<b>41</b>
7.1 APPLICABLE STANDARD	41
7.2 TEST PROCEDURE	41
7.3 DEVIATION FROM STANDARD	41
7.4 TEST SETUP	41
7.5 EUT OPERATION CONDITIONS	41
7.1 TEST RESULTS	41
<b>8 . ANTENNA REQUIREMENT</b>	<b>46</b>
8.1 STANDARD REQUIREMENT	46
8.2 EUT ANTENNA	46
<b>9 . EUT TEST PHOTO</b>	<b>47</b>
<b>10 . EUT PHOTO</b>	<b>49</b>
<b>APPENDIX-PHOTOGRAPHS OF EUT CONSTRUCTIONAL DETAILS</b>	



## 1. SUMMARY OF TEST RESULTS

Test procedures according to the technical standards:

<b>FCC Part15 (15.247) , Subpart C</b>			
Standard Section	Test Item	Judgment	Remark
15.207	Conducted Emission	PASS	
15.247 (a)(2)	6dB Bandwidth	PASS	
15.247 (b)	Peak Output Power	PASS	
15.247 (d)	Radiated Spurious Emission	PASS	
15.247 (e)	Power Spectral Density	PASS	
15.205	Restricted Band of Operation	PASS	
15.247 (d)	Band Edge (Out of Band Emissions)	PASS	
15.203	Antenna Requirement	PASS	

**NOTE:**

(1) "N/A" denotes test is not applicable in this Test Report



## 1.1 TEST FACILITY

Shenzhen BCTC Testing Co., Ltd.

Add. : BCTC Building & 1-2F, East of B Building, Pengzhou Industrial, Fuyuan 1st Road, Qiaotou Community, Fuyong Street, Bao'an District, Shenzhen, China

A2LA Certificate No.: 4474.01

IC Registered No.: 12655A

## 1.2 MEASUREMENT UNCERTAINTY

The reported uncertainty of measurement  $y \pm U$ , where expanded uncertainty  $U$  is based on a standard uncertainty multiplied by a coverage factor of  $k=2$ , providing a level of confidence of approximately **95 %**.

No.	Item	Uncertainty
1	Conducted Emission Test	$\pm 1.38\text{dB}$
2	RF power,conducted	$\pm 0.16\text{dB}$
3	Spurious emissions,conducted	$\pm 0.21\text{dB}$
4	All emissions,radiated(<1G)	$\pm 4.68\text{dB}$
5	All emissions,radiated(>1G)	$\pm 4.89\text{dB}$
6	Temperature	$\pm 0.5^{\circ}\text{C}$
7	Humidity	$\pm 2\%$



## 2. GENERAL INFORMATION

### 2.1 GENERAL DESCRIPTION OF EUT

Equipment	WiFi IP Camera	
Trade Name		
Model Name	C1 Pro	
Model Difference	N/A	
Product Description	The EUT is a WiFi IP Camera	
	Operation Frequency:	802.11b/g/n20MHz:2412~2462 MHz 802.11n40MHz:2422~2452 MHz
	Modulation Type:	WIFI: OFDM/DSSS
	Bit Rate of Transmitter	802.11b:11/5.5/2/1 Mbps 802.11g:54/48/36/24/18/12/9/6Mbps 802.11n Up to 150Mbps
	Number Of Channel	802.11b/g/n20MHz:11 CH 802.11n40MHz: 7 CH
	Antenna Designation:	Please see Note 3.
Based on the application, features, or specification exhibited in User's Manual, the EUT is considered as an ITE/Computing Device. More details of EUT technical specification, please refer to the User's Manual.		
Channel List	Please refer to the Note 2.	
Power	DC 5V from USB port	
adapter	--	
hardware version	--	
Software version	--	
Serial number	--	
Connecting I/O Port(s)	Please refer to the User's Manual	

Note:

1. For a more detailed features description, please refer to the manufacturer's specifications or the User's Manual.



2.

Channel List for 802.11b/g/n(20)							
Channel	Frequency (MHz)	Channel	Frequency (MHz)	Channel	Frequency (MHz)	Channel	Frequency (MHz)
01	2412	04	2427	07	2442	10	2457
02	2417	05	2432	08	2447	11	2462
03	2422	06	2437	09	2452		

Channel List for 802.11n(40)							
Channel	Frequency (MHz)	Channel	Frequency (MHz)	Channel	Frequency (MHz)	Channel	Frequency (MHz)
03	2422	05	2432	07	2442	09	2452
04	2427	06	2437	08	2447		

3.

Table for Filed Antenna

Ant.	Brand	Model Name	Antenna Type	Gain (dBi)	NOTE
1	N/A	N/A	external antenna	2.5dBi	
2	N/A	N/A	external antenna	2.5dBi	

Note1: Directional Gain=2.5dBi+10log(2)=5.51dBi

Note2: The EUT 802.11n (20) and 802.11n(40) is support MIMO mode.

## 2.2 DESCRIPTION OF TEST MODES

Pretest Mode	Description
Mode 1	802.11b CH1/ CH6/ CH11
Mode 2	802.11g CH1/ CH6/ CH11
Mode 3	802.11n20 CH1/ CH6/ CH11
Mode 4	802.11n40 CH3/ CH6/ CH9
Mode 5	Link Mode

Conducted Emission	
Final Test Mode	Description
Mode 5	Link Mode

For Radiated Emission	
Final Test Mode	Description
Mode 1	802.11b CH1/ CH6/ CH11
Mode 2	802.11g CH1/ CH6/ CH11
Mode 3	802.11n20 CH1/ CH6/ CH11
Mode 4	802.11n40 CH3/ CH6/ CH9

Note:

- (1) The measurements are performed at the highest, middle, lowest available channels.
- (2) The measurements are performed at all Bit Rate of Transmitter, the worst data was reported
- (3) According to ANSI C63.10 standards, the test results are both the “worst case” and “worst setup” 11Mbps for 802.11b,6Mbps for 802.11g,13Mbps for 802.11n(H20), 54Mbps for 802.11n(H40).



### 2.3 BLOCK DIGRAM SHOWING THE CONFIGURATION OF SYSTEM TESTED

Conducted & Radiated Emission Test

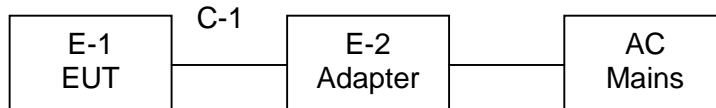

### 2.4 DESCRIPTION OF TEST UNITS

The EUT has been tested as an independent unit together with other necessary accessories or support units. The following support units or accessories were used to form a representative test configuration during the tests.

Item	Equipment	Mfr/Brand	Model/Type No.	Series No.	Note
E-1	WiFi IP Camera		C1 Pro	N/A	EUT
E-2	Adapter	N/A	BCTC006	N/A	Lab Provide

Item	Shielded Type	Ferrite Core	Length	Note
C-1	NO	NO	1.2M	DC cable unshielded

Note:

- (1) For detachable type I/O cable should be specified the length in cm in 『Length』 column.



## 2.5 EQUIPMENTS LIST FOR ALL TEST ITEMS

### Radiation test, Band-edge test and 6db bandwidth test equipment

Item	Equipment	Manufacturer	Type No.	Serial No.	Last calibration	Calibrated until
1	Spectrum Analyzer (9kHz-26.5GHz)	Agilent	E4407B	MY45108040	2017.08.27	2018.08.26
2	Test Receiver (9kHz-7GHz)	R&S	ESPI	101318	2017.08.27	2018.08.26
3	Bilog Antenna (30MHz-1GHz)	R&S	VULB 9168	VULB91 68-438	2017.08.27	2018.08.26
4	Horn Antenna (1GHz-18GHz)	SCHWARZBECK	BBHA9120D	1201	2017.09..03	2018.09.03
5	Horn Antenna (14GHz-40GHz)	SCHWARZBECK	BBHA 9170	9170-181	2017.09..03	2018.09.03
6	Amplifier (9kHz-6GHz)	SCHWARZBECK	BBV9744	9744-0037	2017.08.27	2018.08.26
7	Amplifier (1GHz-18GHz)	SCHWARZBECK	BBV9718	9718-309	2017.08.27	2018.08.26
8	Amplifier (18GHz-40GHz)	SCHWARZBECK	BBV 9721	9721-205	2017.08.27	2018.08.26
9	Loop Antenna (9kHz-30MHz)	SCHWARZBECK	FMZB1519B	00014	2017.09..03	2018.09.03
10	RF cables1 (9kHz-1GHz)	R&S	R203	R20X	2017.08.27	2018.08.26
11	RF cables2 (1GHz-40GHz)	R&S	R204	R21X	2017.08.27	2018.08.26
12	Antenna connector	Florida RF Labs	N/A	RF 01#	2017.08.27	2018.08.26
13	Power Metter	ANRITSU	ML2487A	6K00001568	2017.08.27	2018.08.26
14	Power Sensor (AV)	ANRITSU	ML2491A	030989	2017.08.27	2018.08.26
15	Signal Analyzer 9kHz-26.5GHz	Agilent	N9010A	MY48030494	2017.08.27	2018.08.26
16	Test Receiver 20kHz-40GHz	R&S	ESU 40	100376	2017.08.27	2018.08.26
17	D.C. Power Supply	LongWei	PS-305D	010964729	2017.08.27	2018.08.26

### Conduction Test equipment

Item	Equipment	Manufacturer	Type No.	Serial No.	Last calibration	Calibrated until
1	Test Receiver	R&S	ESCI	1166.5950K03-1 01165-ha	2017.08.27	2018.08.26
2	LISN	SCHWARZBECK	NSLK8127	8127739	2017.08.27	2018.08.26
3	LISN	R&S	NSLK8126	8126487	2017.08.27	2018.08.26
4	RF cables	R&S	R204	R20X	2017.08.27	2018.08.26
5	Attenuator	R&S	ESH3-Z2	143206	2017.08.27	2018.08.26



### 3. EMC EMISSION TEST

#### 3.1 CONDUCTED EMISSION MEASUREMENT

##### 3.1.1 POWER LINE CONDUCTED EMISSION Limits (Frequency Range 150KHz-30MHz)

FREQUENCY (MHz)	Limit(dBuV)		Standard
	Quasi-peak	Average	
0.15 -0.5	66 - 56 *	56 - 46 *	FCC
0.50 -5.0	56.00	46.00	FCC
5.0 -30.0	60.00	50.00	FCC

Note:

- (1) The tighter limit applies at the band edges.
- (2) The limit of " \* " marked band means the limitation decreases linearly with the logarithm of the frequency in the range.

The following table is the setting of the receiver

Receiver Parameters	Setting
Attenuation	10 dB
Start Frequency	0.15 MHz
Stop Frequency	30 MHz
IF Bandwidth	9 kHz

##### 3.1.2 TEST PROCEDURE

- a. The EUT was placed 0.8 meters from the horizontal ground plane with EUT being connected to the power mains through a line impedance stabilization network (LISN). All other support equipments powered from additional LISN(s). The LISN provide 50 Ohm/ 50uH of coupling impedance for the measuring instrument.
- b. Interconnecting cables that hang closer than 40 cm to the ground plane shall be folded back and forth in the center forming a bundle 30 to 40 cm long.
- c. I/O cables that are not connected to a peripheral shall be bundled in the center. The end of the cable may be terminated, if required, using the correct terminating impedance. The overall length shall not exceed 1 m.
- d. LISN at least 80 cm from nearest part of EUT chassis.
- e. For the actual test configuration, please refer to the related Item –EUT Test Photos.

##### 3.1.3 DEVIATION FROM TEST STANDARD

No deviation

### 3.1.4 TEST SETUP

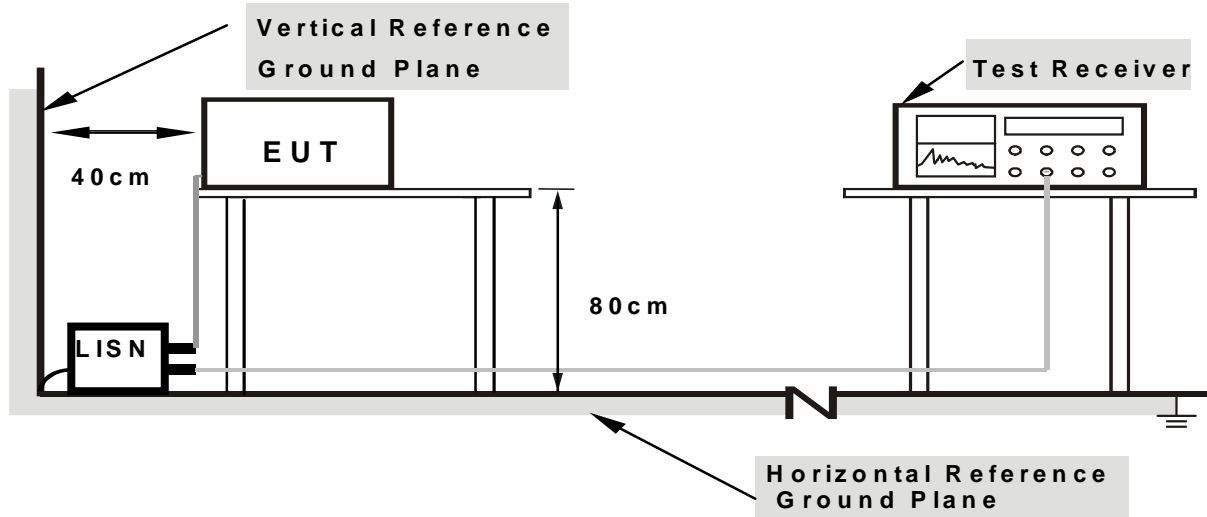

- Note:**
1. Support units were connected to second LISN.
  2. Both of LISNs (AMN) are 80 cm from EUT and at least 80 cm from other units and other metal planes

### 3.1.5 EUT OPERATING CONDITIONS

The EUT was configured for testing in a typical fashion (as a customer would normally use it). The EUT has been programmed to continuously transmit during test. This operating condition was tested and used to collect the included data.

We pretest AC 120V and AC 240V, the worst voltage was AC 120V and the data recording in the report.

### 3.1.6 TEST RESULTS



Temperature :	25 °C	Relative Humidity :	54%
Pressure :	1010hPa	Phase :	L
Test Voltage :	DC 5.0V from adapter(AC 120V/60Hz)	Test Mode :	Mode 5

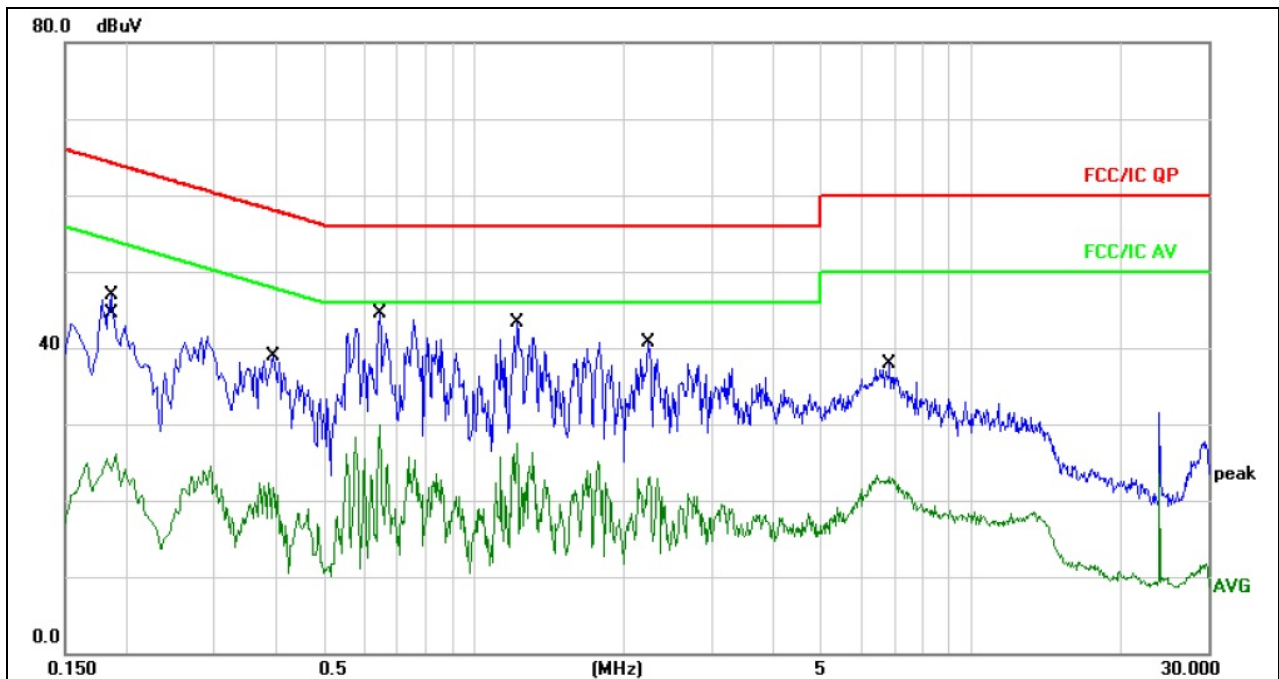

Remark:

1. All readings are Quasi-Peak and Average values.
2. Factor = Insertion Loss + Cable Loss.

No.	Mk.	Freq.	Reading Level	Correct Factor	Measurement	Limit	Over	Detector	Comment
		MHz	dBuV	dB	dBuV	dBuV	dB		
1		0.1860	36.78	10.06	46.84	64.21	-17.37	QP	
2		0.1900	16.01	10.06	26.07	54.03	-27.96	AVG	
3		0.3940	28.80	10.10	38.90	57.98	-19.08	QP	
4		0.3940	11.55	10.10	21.65	47.98	-26.33	AVG	
5	*	0.6460	34.35	10.13	44.48	56.00	-11.52	QP	
6		0.6460	19.73	10.13	29.86	46.00	-16.14	AVG	
7		1.2220	33.22	10.17	43.39	56.00	-12.61	QP	
8		1.2220	17.27	10.17	27.44	46.00	-18.56	AVG	
9		2.2380	30.60	10.18	40.78	56.00	-15.22	QP	
10		2.2380	12.99	10.18	23.17	46.00	-22.83	AVG	
11		6.8660	27.70	10.10	37.80	60.00	-22.20	QP	
12		6.8660	13.05	10.10	23.15	50.00	-26.85	AVG	



Temperature :	25 °C	Relative Humidity :	54%
Pressure :	1010hPa	Phase :	N
Test Voltage :	DC 5.0V from adapter(AC 120V/60Hz)	Test Mode :	Mode 5

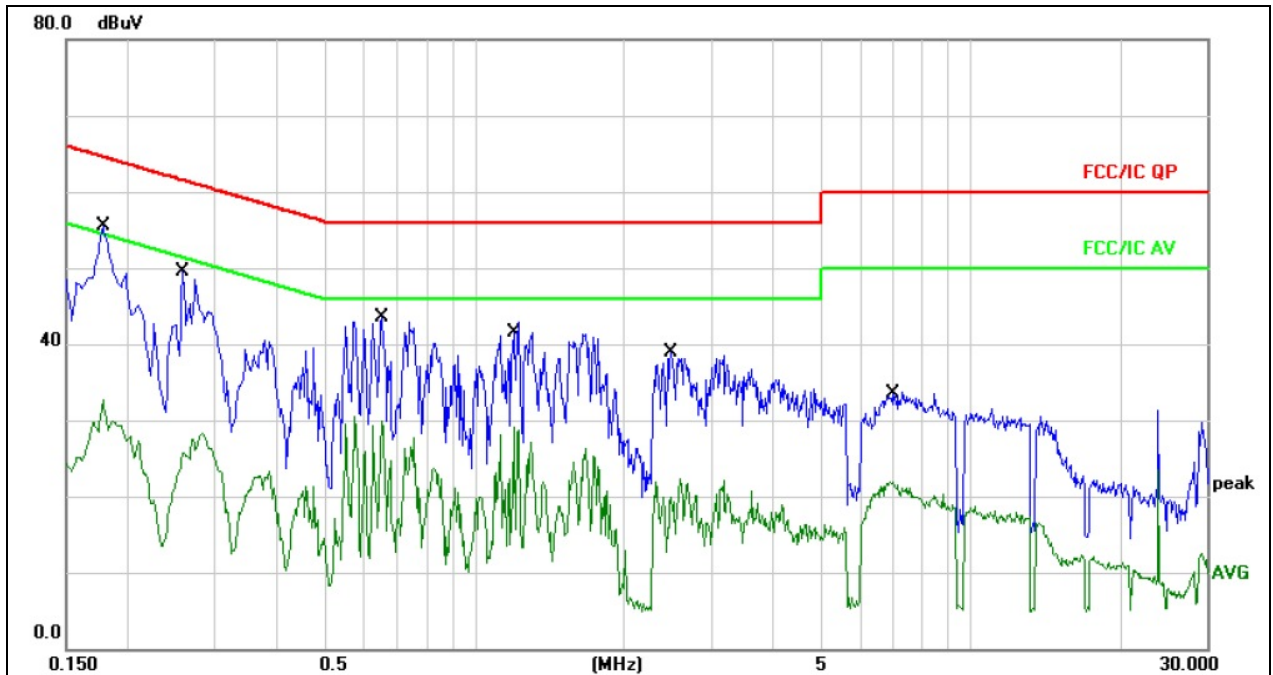

Remark:

1. All readings are Quasi-Peak and Average values.
2. Factor = Insertion Loss + Cable Loss.

No.	Mk.	Freq. MHz	Reading Level dBuV	Correct Factor dB	Measure- ment dBuV	Limit dBuV	Over dB	Detector	Comment
1	*	0.1780	45.45	10.06	55.51	64.57	-9.06	QP	
2		0.1780	22.57	10.06	32.63	54.57	-21.94	AVG	
3		0.2580	39.49	10.08	49.57	61.49	-11.92	QP	
4		0.2580	18.22	10.08	28.30	51.49	-23.19	AVG	
5		0.6500	33.31	10.13	43.44	56.00	-12.56	QP	
6		0.6500	19.85	10.13	29.98	46.00	-16.02	AVG	
7		1.2020	32.80	10.17	42.97	56.00	-13.03	QP	
8		1.2020	19.00	10.17	29.17	46.00	-16.83	AVG	
9		2.4980	28.70	10.18	38.88	56.00	-17.12	QP	
10		2.4980	12.11	10.18	22.29	46.00	-23.71	AVG	
11		7.0180	23.60	10.10	33.70	60.00	-26.30	QP	
12		7.0180	11.88	10.10	21.98	50.00	-28.02	AVG	



### 3.2 RADIATED EMISSION MEASUREMENT

#### 3.2.1 RADIATED EMISSION LIMITS (Frequency Range 9kHz-1000MHz)

20dBc in any 100 kHz bandwidth outside the operating frequency band. In case the emission fall within the restricted band specified on 15.205(a), then the 15.209(a) limit in the table below has to be followed.

Frequencies (MHz)	Field Strength (microrvolts/meter)	Measurement Distance (meters)
0.009~0.490	2400/F(KHz)	300
0.490~1.705	24000/F(KHz)	30
1.705~30.0	30	30
30~88	100	3
88~216	150	3
216~960	200	3
Above 960	500	3

#### LIMITS OF RADIATED EMISSION MEASUREMENT (Above 1000MHz)

FREQUENCY (MHz)	Limit(dBuV/m) (at 3M)	
	PEAK	AVERAGE
Above 1000	74	54

Notes:

- (1) The limit for radiated test was performed according to FCC PART 15C.
- (2) The tighter limit applies at the band edges.
- (3) Emission level (dBuV/m)=20log Emission level (uV/m).

Spectrum Parameter	Setting
Attenuation	Auto
Start Frequency	1000 MHz
Stop Frequency	25GHz
RB / VB (emission in restricted band)	1 MHz / 1 MHz for Peak, 1 MHz / 10Hz for Average

Receiver Parameter	Setting
Attenuation	Auto
Start ~ Stop Frequency	9kHz~150kHz / RB 200Hz for QP
Start ~ Stop Frequency	150kHz~30MHz / RB 9kHz for QP
Start ~ Stop Frequency	30MHz~1000MHz / RB 120kHz for QP

### 3.2.2 TEST PROCEDURE

Below 1GHz test procedure as below:

- a. The EUT was placed on the top of a rotating table 0.8 meters above the ground at a 3 meter semi-anechoic chamber. The table was rotated 360 degrees to determine the position of the highest radiation.
- b. The EUT was set 3 meters away from the interference-receiving antenna, which was mounted on the top of a variable-height antenna tower.
- c. The antenna height is varied from one meter to four meters above the ground to determine the maximum value of the field strength. Both horizontal and vertical polarizations of the antenna are set to make the measurement.
- d. For each suspected emission, the EUT was arranged to its worst case and then the antenna was tuned to heights from 1 meter to 4 meters (for the test frequency of below 30MHz, the antenna was tuned to heights 1 meter) and the rotatable table was turned from 0 degrees to 360 degrees to find the maximum reading.
- e. The test-receiver system was set to Peak Detect Function and Specified Bandwidth with Maximum Hold Mode.
- f. If the emission level of the EUT in peak mode was 10dB lower than the limit specified, then testing could be stopped and the peak values of the EUT would be reported. Otherwise the emissions that did not have 10dB margin would be re-tested one by one using peak, quasi-peak or average method as specified and then reported in a data sheet.

Above 1GHz test procedure as below:

- g. Different between above is the test site, change from Semi- Anechoic Chamber to fully Anechoic Chamber and change form table 0.8 metre to 1.5 metre( Above 18GHz the distance is 1 meter and table is 1.5 metre).
- h. Test the EUT in the lowest channel ,the middle channel ,the Highest channel

Note:

Both horizontal and vertical antenna polarities were tested and performed pretest to three orthogonal axis. The worst case emissions were reported We pretest AC 120V and AC 240V, the worst voltage was AC 120V and the data recording in the report.

### 3.2.3 DEVIATION FROM TEST STANDARD

No deviation

### 3.2.4 TEST SETUP

(A) Radiated Emission Test-Up Frequency Below 30MHz

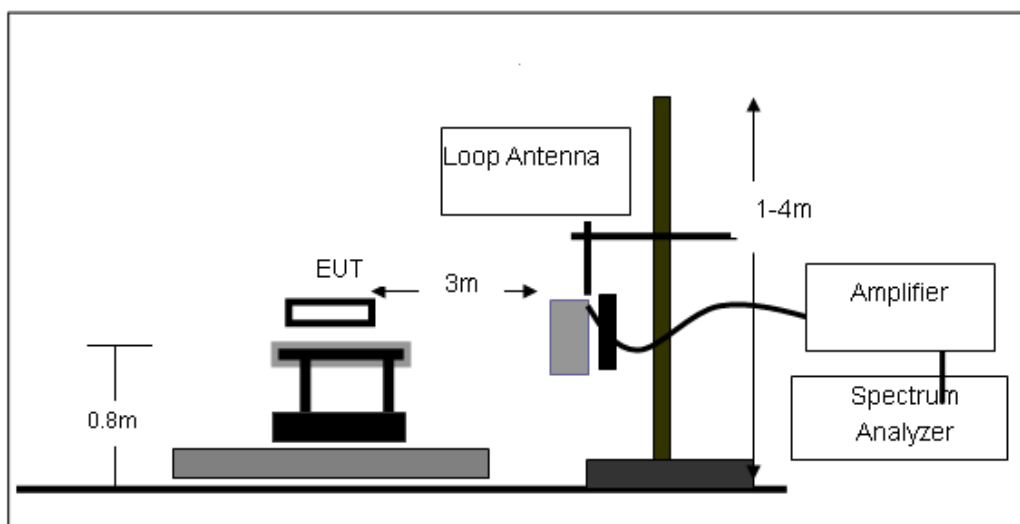



## (B) Radiated Emission Test-Up Frequency 30MHz~1GHz

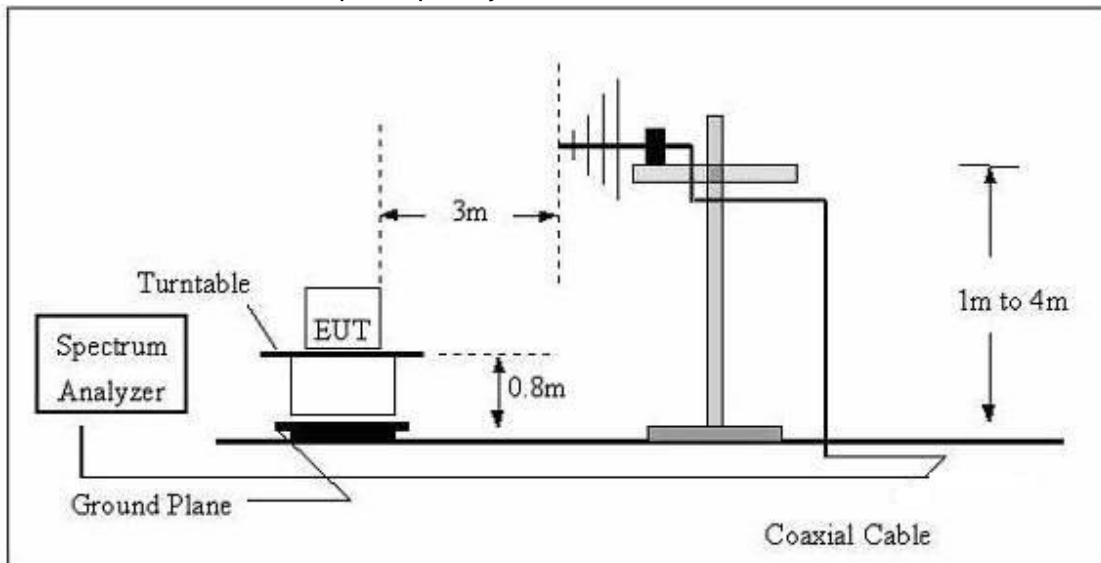

## (C) Radiated Emission Test-Up Frequency Above 1GHz

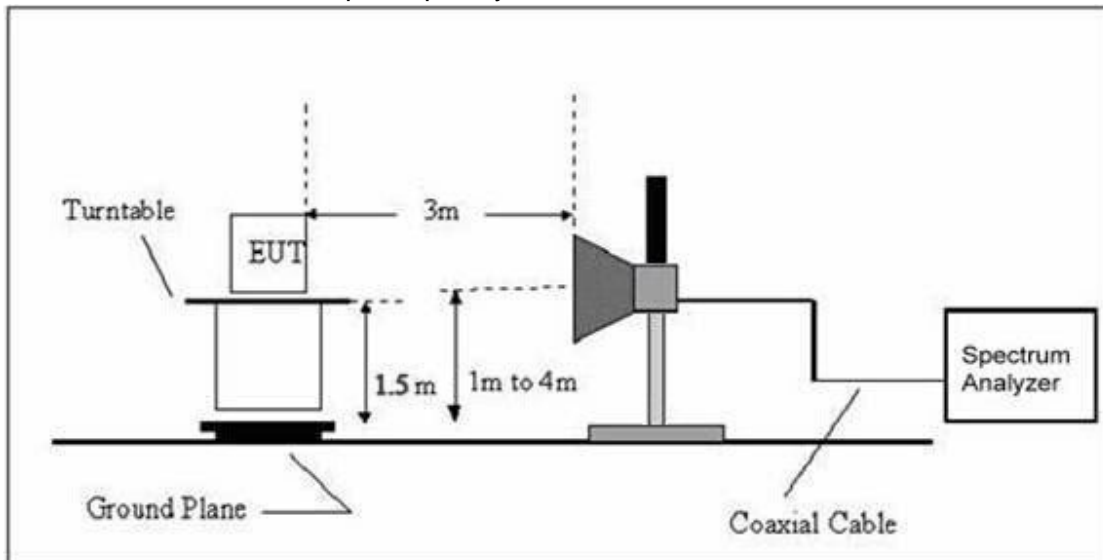

### 3.2.5 EUT OPERATING CONDITIONS

The EUT tested system was configured as the statements of 2.4 Unless otherwise a special operating condition is specified in the follows during the testing.

For 802.11b/g, only the SISO mode was supported. And basing on the pre-scan, only the data for worst case configuration (ant 1 active) was listed below.

For 802.11n, both SISO and MIMO were supported. And basing on the pre-scan, only the data for worst case configuration (MIMO mode) was listed below.

**3.2.6 TEST RESULTS (BETWEEN 9KHZ – 30 MHZ)**

Temperature:	20°C	Relative Humidity:	48%
Pressure:	1010 hPa	Test Voltage :	DC 5.0V from adapter(AC 120V/60Hz)
Test Mode :	Mode 5	Polarization :	--

Freq. (MHz)	Reading (dBuV/m)	Limit (dBuV/m)	Margin (dB)	State P/F
--	--	--	--	PASS
--	--	--	--	PASS

**NOTE:**

The amplitude of spurious emissions which are attenuated by more than 20dB below the permissible value has no need to be reported.

Distance extrapolation factor =  $40 \log(\text{specific distance}/\text{test distance})$ (dB);

Limit line = specific limits(dBuv) + distance extrapolation factor.



**3.2.7 TEST RESULTS (BETWEEN 30MHZ – 1GHZ)**

Temperature :	26°C	Relative Humidity :	54%
Pressure :	1010 hPa	Polarization :	Horizontal
Test Voltage :	DC 5.0V from adapter(AC 120V/60Hz)		
Test Mode :	Mode 5		

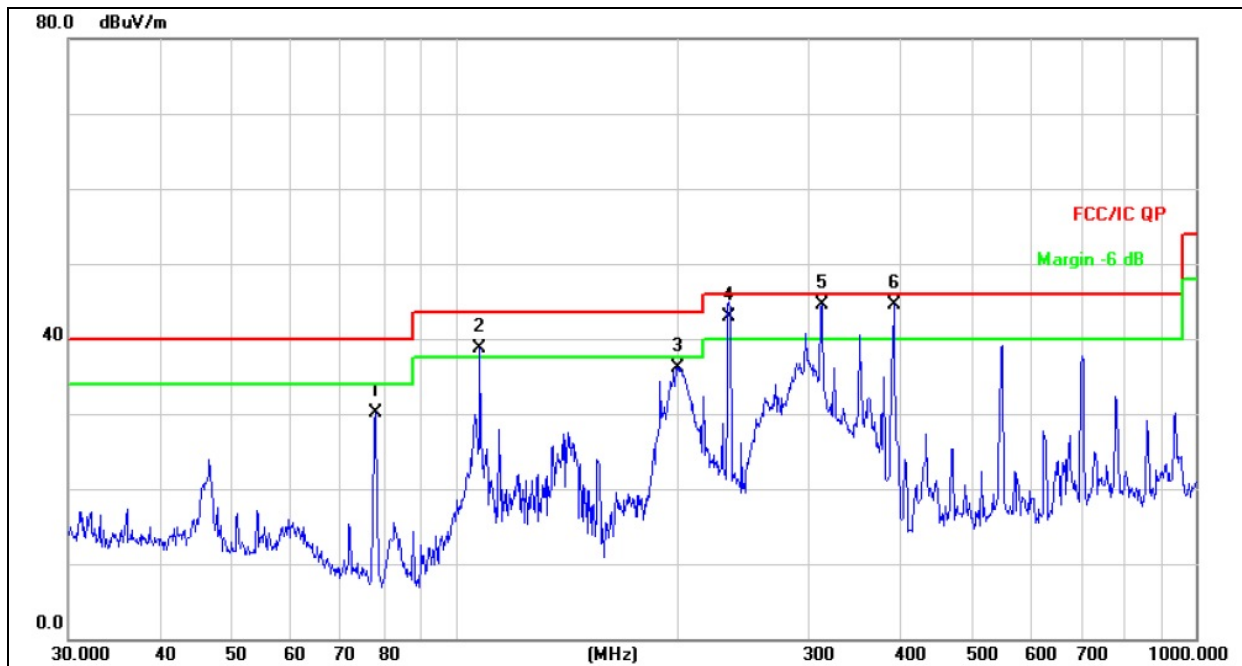

Remark:  
Factor = Antenna Factor + Cable Loss – Pre-amplifier.

No.	Mk.	Freq. MHz	Reading Level dBuV	Correct Factor dB/m	Measure- ment dBuV/m	Limit dBuV/m	Over dB	Detector
1		78.1389	47.52	-17.43	30.09	40.00	-9.91	QP
2	!	107.8876	54.49	-15.83	38.66	43.50	-4.84	QP
3		199.2855	52.34	-16.16	36.18	43.50	-7.32	QP
4	!	234.1683	57.77	-14.82	42.95	46.00	-3.05	QP
5	!	312.1792	56.78	-12.27	44.51	46.00	-1.49	QP
6	*	390.7225	54.94	-10.41	44.53	46.00	-1.47	QP



Temperature :	26°C	Relative Humidity :	54%
Pressure :	1010 hPa	Polarization :	Vertical
Test Voltage :	DC 5.0V from adapter(AC 120V/60Hz)		
Test Mode :	Mode 5		

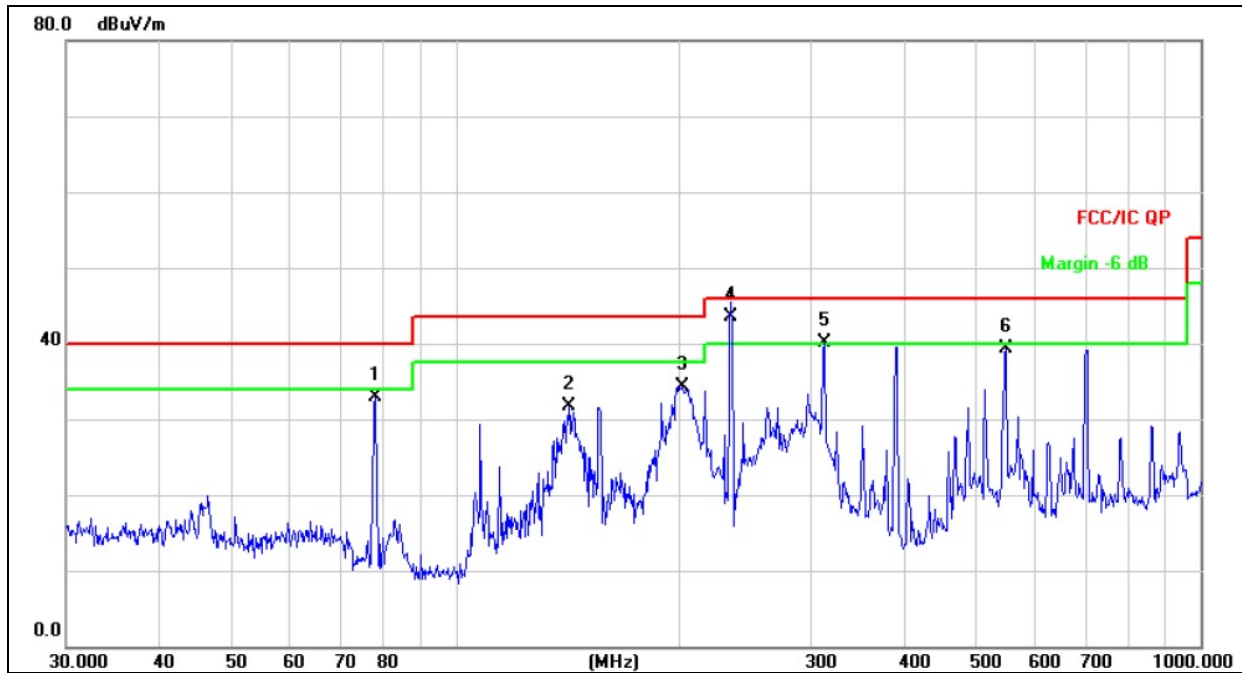

Remark:  
Factor = Antenna Factor + Cable Loss – Pre-amplifier.

No.	Mk.	Freq. MHz	Reading Level dBuV	Correct Factor dB/m	Measure- ment dBuV/m	Limit dBuV/m	Over dB	Detector
1		78.1389	50.30	-17.43	32.87	40.00	-7.13	QP
2		141.8262	44.94	-13.29	31.65	43.50	-11.85	QP
3		201.3930	50.45	-16.16	34.29	43.50	-9.21	QP
4	*	234.1684	58.28	-14.82	43.46	46.00	-2.54	QP
5	!	312.1794	52.40	-12.27	40.13	46.00	-5.87	QP
6		547.0977	46.60	-7.20	39.40	46.00	-6.60	QP



3.2.8 TEST RESULTS (1GHZ-25GHZ)

802.11b

Polar (H/V)	Frequency	Meter Reading	Pre-amplifier	Cable Loss	Antenna Factor	Emission Level	Limits	Margin	Detector Type
	(MHz)	(dBuV)	(dB)	(dB)	(dB/m)	(dBuV/m)	(dBuV/m)	(dB)	
<b>operation frequency:2412</b>									
V	4824.00	65.63	39.55	7.85	25.66	59.59	74	-14.41	PK
V	4824.00	47.80	39.55	7.85	25.66	41.76	54	-12.24	AV
V	7236.00	66.68	38.33	7.52	24.55	60.42	74	-13.58	PK
V	7236.00	47.31	38.33	7.52	24.55	41.05	54	-12.95	AV
V	15448.00	50.31	35.23	6.75	26.59	48.42	74	-25.58	PK
H	4824.00	67.14	39.55	7.85	25.66	61.10	74	-12.90	PK
H	4824.00	48.26	39.55	7.85	25.66	42.22	54	-11.78	AV
H	7236.00	67.87	38.33	7.52	23.55	60.61	74	-13.39	PK
H	7236.00	50.51	38.33	7.52	23.22	42.92	54	-11.08	AV
H	15448.00	45.74	35.45	6.75	27.88	44.92	74	-29.08	PK
<b>operation frequency:2437</b>									
V	4874.00	63.98	38.89	7.57	25.45	58.11	74	-15.89	PK
V	4874.00	47.49	38.89	7.57	25.45	41.62	54	-12.38	AV
V	7311.00	65.06	38.78	7.35	24.78	58.41	74	-15.59	PK
V	7311.00	47.10	38.78	7.35	24.78	40.45	54	-13.55	AV
V	15448.00	51.11	35.89	6.42	26.47	48.11	74	-25.89	PK
H	4874.00	63.33	38.89	7.57	25.45	57.46	74	-16.54	PK
H	4874.00	48.35	38.89	7.57	25.45	42.48	54	-11.52	AV
H	7311.00	68.66	38.78	7.35	24.78	62.01	74	-11.99	PK
H	7311.00	46.73	38.78	7.35	24.78	40.08	54	-13.92	AV
H	15448.00	46.62	36.68	6.45	26.65	43.04	74	-30.96	PK
<b>operation frequency:2462</b>									
V	4924.00	66.72	38.75	7.46	25.45	60.88	74	-13.12	PK
V	4924.00	49.56	38.75	7.46	25.45	43.72	54	-10.28	AV
V	7386.00	66.11	38.65	7.22	24.78	59.46	74	-14.54	PK
V	7386.00	48.17	38.65	7.22	24.78	41.52	54	-12.48	AV
V	15448.00	52.32	35.58	6.35	26.47	49.56	74	-24.44	PK
H	4924.00	64.62	38.75	7.46	25.45	58.78	74	-15.22	PK
H	4924.00	49.17	38.75	7.46	25.45	43.33	54	-10.67	AV
H	7386.00	68.01	38.65	7.22	24.78	61.36	74	-12.64	PK
H	7386.00	46.18	38.65	7.22	24.78	39.53	54	-14.47	AV
H	15448.00	48.31	36.42	6.32	26.65	44.86	74	-29.14	PK

**Remark:**

1. Emission Level = Meter Reading + Antenna Factor + Cable Loss – Pre-amplifier, Margin= Emission Level - Limit
2. If peak below the average limit, the average emission was no test.
3. The amplitude of spurious emissions which are attenuated by more than 20dB below the permissible value has no need to be reported.



802.11g

Polar (H/V)	Frequency	Meter Reading	Pre-amplifier	Cable Loss	Antenna Factor	Emission Level	Limits	Margin	Detector Type
	(MHz)	(dBuV)	(dB)	(dB)	(dB/m)	(dBuV/m)	(dBuV/m)	(dB)	
<b>operation frequency:2412</b>									
V	4824.00	65.95	39.55	7.85	25.66	59.91	74	-14.09	PK
V	4824.00	49.36	39.55	7.85	25.66	43.32	54	-10.68	AV
V	7236.00	66.10	38.33	7.52	24.55	59.84	74	-14.16	PK
V	7236.00	47.48	38.33	7.52	24.55	41.22	54	-12.78	AV
V	15448.00	50.74	35.23	6.75	26.59	48.85	74	-25.15	PK
H	4824.00	62.97	39.55	7.85	25.66	56.93	74	-17.07	PK
H	4824.00	49.27	39.55	7.85	25.66	43.23	54	-10.77	AV
H	7236.00	69.05	38.33	7.52	23.55	61.79	74	-12.21	PK
H	7236.00	49.30	38.33	7.52	23.22	41.71	54	-12.29	AV
H	15448.00	44.72	35.45	6.75	27.88	43.90	74	-30.10	PK
<b>operation frequency:2437</b>									
V	4874.00	66.38	38.89	7.57	25.45	60.51	74	-13.49	PK
V	4874.00	49.04	38.89	7.57	25.45	43.17	54	-10.83	AV
V	7311.00	67.26	38.78	7.35	24.78	60.61	74	-13.39	PK
V	7311.00	47.56	38.78	7.35	24.78	40.91	54	-13.09	AV
V	15448.00	52.61	35.89	6.42	26.47	49.61	74	-24.39	PK
H	4874.00	65.05	38.89	7.57	25.45	59.18	74	-14.82	PK
H	4874.00	49.27	38.89	7.57	25.45	43.40	54	-10.60	AV
H	7311.00	69.02	38.78	7.35	24.78	62.37	74	-11.63	PK
H	7311.00	47.16	38.78	7.35	24.78	40.51	54	-13.49	AV
H	15448.00	48.21	36.68	6.42	26.65	44.60	74	-29.40	PK
<b>operation frequency:2462</b>									
V	4924.00	67.61	38.75	7.46	25.45	61.77	74	-12.23	PK
V	4924.00	48.24	38.75	7.46	25.45	42.40	54	-11.60	AV
V	7386.00	68.28	38.65	7.22	24.78	61.63	74	-12.37	PK
V	7386.00	49.57	38.65	7.22	24.78	42.92	54	-11.08	AV
V	15448.00	53.43	35.58	6.35	26.47	50.67	74	-23.33	PK
H	4924.00	66.26	38.75	7.46	25.45	60.42	74	-13.58	PK
H	4924.00	50.23	38.75	7.46	25.45	44.39	54	-9.61	AV
H	7386.00	69.07	38.65	7.22	24.78	62.42	74	-11.58	PK
H	7386.00	47.74	38.65	7.22	24.78	41.09	54	-12.91	AV
H	15448.00	48.58	36.42	6.32	26.65	45.13	74	-28.87	PK

**Remark:**

1. Emission Level = Meter Reading + Antenna Factor + Cable Loss – Pre-amplifier,  
Margin= Emission Level - Limit
2. If peak below the average limit, the average emission was no test.
3. The amplitude of spurious emissions which are attenuated by more than 20dB below the permissible value has no need to be reported.



**802.11n(20MHz)**

Polar (H/V)	Frequency	Meter Reading	Pre-amplifier	Cable Loss	Antenna Factor	Emission Level	Limits	Margin	Detector Type
	(MHz)	(dBuV)	(dB)	(dB)	(dB/m)	(dBuV/m)	(dBuV/m)	(dB)	
<b>operation frequency:2412</b>									
V	4824.00	67.58	39.55	7.85	25.66	61.54	74	-12.46	PK
V	4824.00	48.54	39.55	7.85	25.66	42.50	54	-11.50	AV
V	7236.00	68.28	38.33	7.52	24.55	62.02	74	-11.98	PK
V	7236.00	48.41	38.33	7.52	24.55	42.15	54	-11.85	AV
V	15448.00	51.64	35.23	6.75	26.59	49.75	74	-24.25	PK
H	4824.00	68.15	39.55	7.85	25.66	62.11	74	-11.89	PK
H	4824.00	49.51	39.55	7.85	25.66	43.47	54	-10.53	AV
H	7236.00	69.17	38.33	7.52	23.55	61.91	74	-12.09	PK
H	7236.00	51.34	38.33	7.52	23.22	43.75	54	-10.25	AV
H	15448.00	46.81	35.45	6.75	27.88	45.99	74	-28.01	PK
<b>operation frequency:2437</b>									
V	4874.00	66.53	38.89	7.57	25.45	60.66	74	-13.34	PK
V	4874.00	49.51	38.89	7.57	25.45	43.64	54	-10.36	AV
V	7311.00	67.19	38.78	7.35	24.78	60.54	74	-13.46	PK
V	7311.00	47.33	38.78	7.35	24.78	40.68	54	-13.32	AV
V	15448.00	52.20	35.89	6.42	26.47	49.20	74	-24.80	PK
H	4874.00	65.39	38.89	7.57	25.45	59.52	74	-14.48	PK
H	4874.00	49.53	38.89	7.57	25.45	43.66	54	-10.34	AV
H	7311.00	69.56	38.78	7.35	24.78	62.91	74	-11.09	PK
H	7311.00	47.75	38.78	7.35	24.78	41.10	54	-12.90	AV
H	15448.00	48.55	36.68	6.42	26.65	44.94	74	-29.06	PK
<b>operation frequency:2462</b>									
V	4924.00	68.59	38.75	7.46	25.45	62.75	74	-11.25	PK
V	4924.00	50.24	38.75	7.46	25.45	44.40	54	-9.60	AV
V	7386.00	67.58	38.65	7.22	24.78	60.93	74	-13.07	PK
V	7386.00	49.44	38.65	7.22	24.78	42.79	54	-11.21	AV
V	15448.00	53.23	35.58	6.35	26.47	50.47	74	-23.53	PK
H	4924.00	66.59	38.75	7.46	25.45	60.75	74	-13.25	PK
H	4924.00	50.37	38.75	7.46	25.45	44.53	54	-9.47	AV
H	7386.00	69.09	38.65	7.22	24.78	62.44	74	-11.56	PK
H	7386.00	47.33	38.65	7.22	24.78	40.68	54	-13.32	AV
H	15448.00	49.07	36.42	6.32	26.65	45.62	74	-28.38	PK

**Remark:**

1. Emission Level = Meter Reading + Antenna Factor + Cable Loss – Pre-amplifier,  
Margin= Emission Level - Limit
2. If peak below the average limit, the average emission was no test.
3. The amplitude of spurious emissions which are attenuated by more than 20dB below the permissible value has no need to be reported.



**802.11n(40MHz)**

Polar (H/V)	Frequency	Meter Reading	Pre-amplifier	Cable Loss	Antenna Factor	Emission Level	Limits	Margin	Detector Type
	(MHz)	(dBuV)	(dB)	(dB)	(dB/m)	(dBuV/m)	(dBuV/m)	(dB)	
<b>operation frequency:2422</b>									
V	4844.000	68.95	39.55	7.77	25.66	62.83	74	-11.17	PK
V	4844.000	48.93	39.55	7.77	25.66	42.81	54	-11.19	AV
V	7266.000	67.93	38.33	7.30	24.55	61.45	74	-12.55	PK
V	7266.000	48.64	38.33	7.30	24.55	42.16	54	-11.84	AV
V	15448.00	52.04	35.23	6.60	26.59	50.00	74	-24.00	PK
H	4844.000	69.16	39.55	7.77	25.66	63.04	74	-10.96	PK
H	4844.000	49.67	39.55	7.77	25.66	43.55	54	-10.45	AV
H	7266.000	70.14	38.33	7.30	23.55	62.66	74	-11.34	PK
H	7266.000	51.83	38.33	7.30	23.22	44.02	54	-9.98	AV
H	15448.00	47.78	35.45	6.60	27.88	46.81	74	-27.19	PK
<b>operation frequency:2437</b>									
V	4874.00	67.05	38.89	7.57	25.45	61.18	74	-12.82	PK
V	4874.00	49.88	38.89	7.57	25.45	44.01	54	-9.99	AV
V	7311.00	67.95	38.78	7.35	24.78	61.30	74	-12.70	PK
V	7311.00	47.95	38.78	7.35	24.78	41.30	54	-12.70	AV
V	15448.00	52.57	35.89	6.42	26.47	49.57	74	-24.43	PK
H	4874.00	65.48	38.89	7.57	25.45	59.61	74	-14.39	PK
H	4874.00	49.88	38.89	7.57	25.45	44.01	54	-9.99	AV
H	7311.00	70.25	38.78	7.35	24.78	63.60	74	-10.40	PK
H	7311.00	47.53	38.78	7.35	24.78	40.88	54	-13.12	AV
H	15448.00	48.72	36.68	6.42	26.65	45.11	74	-28.89	PK
<b>operation frequency:2452</b>									
V	4904.00	68.86	38.75	7.38	25.45	62.94	74	-11.06	PK
V	4904.00	50.56	38.75	7.38	25.45	44.64	54	-9.36	AV
V	7356.00	67.93	38.65	7.15	24.78	61.21	74	-12.79	PK
V	7356.00	50.15	38.65	7.15	24.78	43.43	54	-10.57	AV
V	15448.00	53.68	35.58	6.25	26.47	50.82	74	-23.18	PK
H	4904.00	67.01	38.75	7.38	25.45	61.09	74	-12.91	PK
H	4904.00	51.16	38.75	7.38	25.45	45.24	54	-8.76	AV
H	7356.00	70.06	38.65	7.15	24.78	63.34	74	-10.66	PK
H	7356.00	47.84	38.65	7.15	24.78	41.12	54	-12.88	AV
H	15448.00	49.62	36.42	6.25	26.65	46.10	74	-27.90	PK

**Remark:**

1. Emission Level = Meter Reading + Antenna Factor + Cable Loss – Pre-amplifier,  
Margin= Emission Level - Limit
2. If peak below the average limit, the average emission was no test.
3. The amplitude of spurious emissions which are attenuated by more than 20dB below the permissible value has no need to be reported.





For Conducted

we pretest all mode, the worst mode was 802.11b, and the data only show the worst mode data.

802.11b

2412MHz

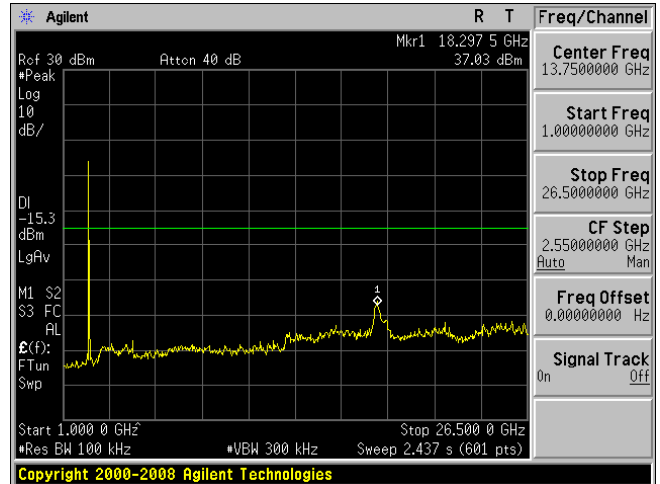
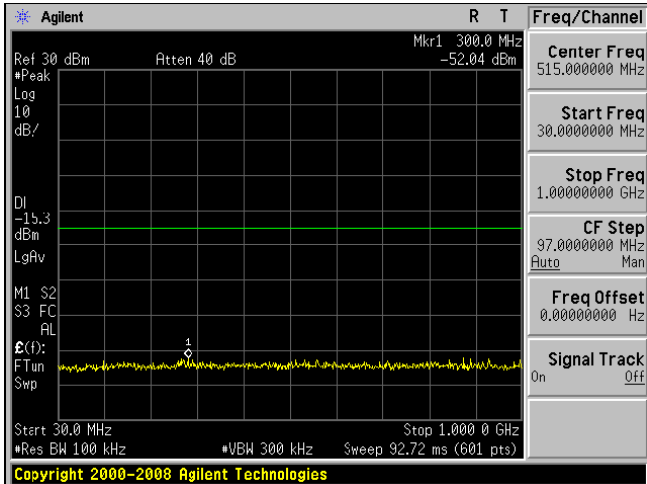

2437MHz

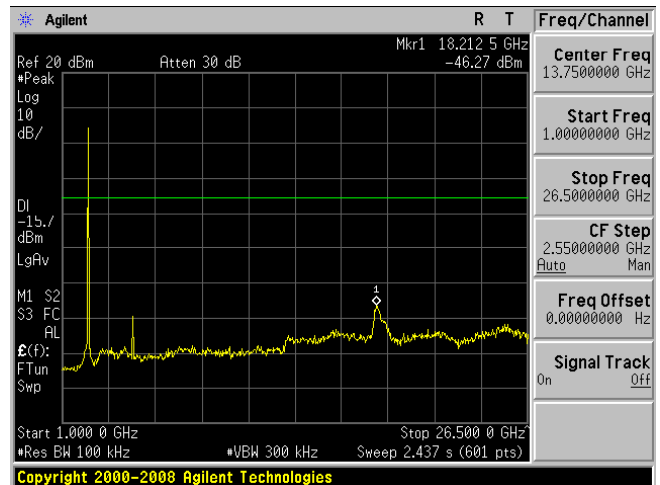
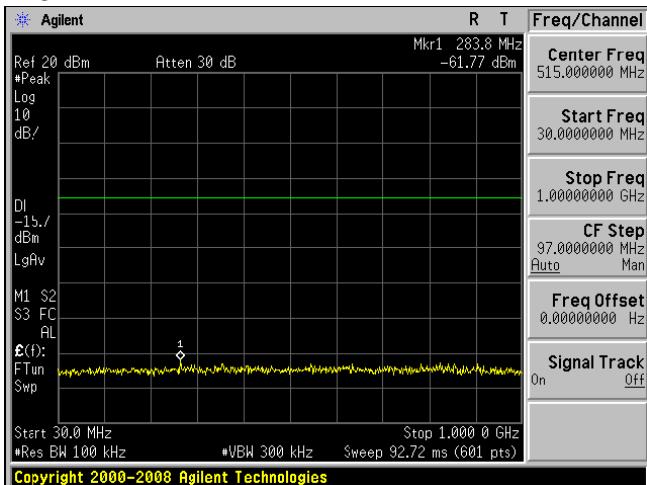

2462MHz

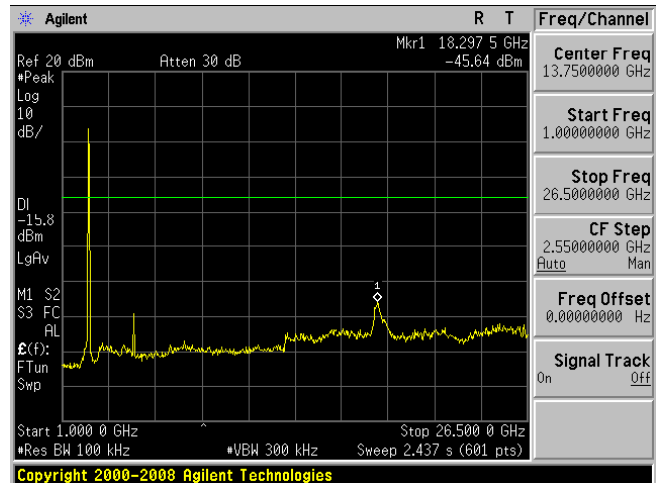
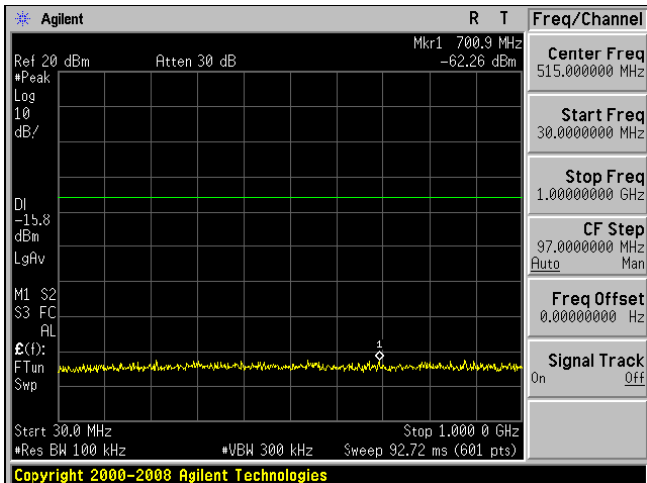



### 3.3 RADIATED BAND EMISSION MEASUREMENT

#### 3.3.1 TEST REQUIREMENT:

FCC Part15 C Section 15.209 and 15.205

LIMITS OF RADIATED EMISSION MEASUREMENT (Above 1000MHz)

FREQUENCY (MHz)	Limit(dBuV/m) (at 3M)	
	PEAK	AVERAGE
Above 1000	74	54

Notes:

- (1) The limit for radiated test was performed according to FCC PART 15C.
- (2) The tighter limit applies at the band edges.
- (3) Emission level (dBuV/m)=20log Emission level (uV/m).

Spectrum Parameter	Setting
Attenuation	Auto
Start Frequency	2300MHz
Stop Frequency	2520
RB / VB (emission in restricted band)	1 MHz / 1 MHz for Peak, 1 MHz / 10Hz for Average

#### 3.3.2 TEST PROCEDURE

Above 1GHz test procedure as below:

- a. 1. The EUT was placed on the top of a rotating table 1.5 meters above the ground at a 3 meter camber. The table was rotated 360 degrees to determine the position of the highest radiation.
- b. The EUT was set 3 meters away from the interference-receiving antenna, which was mounted on the top of a variable-height antenna tower.
- c. The antenna height is varied from one meter to four meters above the ground to determine the maximum value of the field strength. Both horizontal and vertical polarizations of the antenna are set to make the measurement.
- d. For each suspected emission, the EUT was arranged to its worst case and then the antenna was tuned to heights from 1 meter to 4 meters and the rota table was turned from 0 degrees to 360 degrees to find the maximum reading.
- e. The test-receiver system was set to Peak Detect Function and Specified Bandwidth with Maximum Hold Mode.
- f. If the emission level of the EUT in peak mode was 10dB lower than the limit specified, then testing could be stopped and the peak values of the EUT would be reported. Otherwise the emissions that did not have 10dB margin would be re-tested one by one using peak, quasi-peak or average method as specified and then reported in a data sheet.
- g. Test the EUT in the lowest channel,the Highest channel

Note:

Both horizontal and vertical antenna polarities were tested and performed pretest to three orthogonal axis. The worst case emissions were reported

### 3.3.3 DEVIATION FROM TEST STANDARD

No deviation

### 3.3.4 TEST SETUP

Radiated Emission Test-Up Frequency Above 1GHz

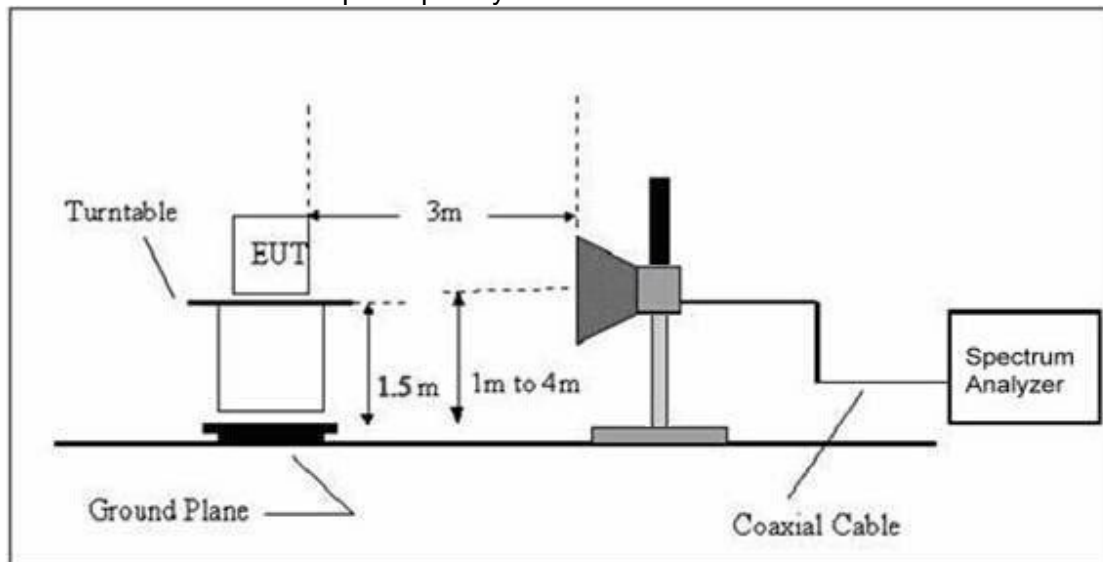

### 3.3.5 EUT OPERATING CONDITIONS

The EUT tested system was configured as the statements of 2.3 Unless otherwise a special operating condition is specified in the follows during the testing.



**3.3.6 TEST RESULT**

Polar (H/V)	Frequency	Meter Reading	Pre-amplifier	Cable Loss	Antenna Factor	Emission level	Limits	Margin	Detector Type
	(MHz)	(dBuV)	(dB)	(dB)	(dB/m)	(dBuV/m)	(dBuV/m)	(dB)	
<b>802.11b operation frequency:2412</b>									
V	2390.00	67.95	38.06	7.42	20.15	57.46	74.00	-16.54	PK
V	2390.00	56.43	38.06	7.42	20.15	45.94	54.00	-8.06	AV
V	2400.00	68.15	38.06	7.42	20.15	57.66	74.00	-16.34	PK
V	2400.00	56.02	38.06	7.42	20.15	45.53	54.00	-8.47	AV
H	2390.00	68.24	38.06	7.42	20.15	57.75	74.00	-16.25	PK
H	2390.00	56.46	38.06	7.42	20.15	45.97	54.00	-8.03	AV
H	2400.00	68.10	38.06	7.42	20.15	57.61	74.00	-16.39	PK
H	2400.00	56.40	38.06	7.42	20.15	45.91	54.00	-8.09	AV
<b>802.11b operation frequency:2462</b>									
V	2483.50	68.31	38.17	7.42	20.51	58.07	74.00	-15.93	PK
V	2483.50	56.82	38.17	7.42	20.51	46.58	54.00	-7.42	AV
V	2500.00	68.25	38.20	7.45	20.54	58.04	74.00	-15.96	PK
V	2500.00	56.26	38.20	7.45	20.54	46.05	54.00	-7.95	AV
H	2483.50	68.44	38.17	7.42	20.51	58.20	74.00	-15.80	PK
H	2483.50	56.86	38.17	7.42	20.51	46.62	54.00	-7.38	AV
H	2500.00	68.05	38.20	7.45	20.54	57.84	74.00	-16.16	PK
H	2500.00	57.14	38.20	7.45	20.54	46.93	54.00	-7.07	AV
<b>802.11g operation frequency:2412</b>									
V	2390.00	68.10	38.06	7.42	20.15	57.61	74.00	-16.39	PK
V	2390.00	56.57	38.06	7.42	20.15	46.08	54.00	-7.92	AV
V	2400.00	68.33	38.06	7.42	20.15	57.84	74.00	-16.16	PK
V	2400.00	56.15	38.06	7.42	20.15	45.66	54.00	-8.34	AV
H	2390.00	68.41	38.06	7.42	20.15	57.92	74.00	-16.08	PK
H	2390.00	56.60	38.06	7.42	20.15	46.11	54.00	-7.89	AV
H	2400.00	68.27	38.06	7.42	20.15	57.78	74.00	-16.22	PK
H	2400.00	56.53	38.06	7.42	20.15	46.04	54.00	-7.96	AV
<b>802.11g operation frequency:2462</b>									
V	2483.50	68.33	38.17	7.42	20.51	58.09	74.00	-15.91	PK
V	2483.50	56.83	38.17	7.42	20.51	46.59	54.00	-7.41	AV
V	2500.00	68.26	38.20	7.45	20.54	58.05	74.00	-15.95	PK
V	2500.00	56.26	38.20	7.45	20.54	46.05	54.00	-7.95	AV
H	2483.50	68.45	38.17	7.42	20.51	58.21	74.00	-15.79	PK
H	2483.50	56.87	38.17	7.42	20.51	46.63	54.00	-7.37	AV
H	2500.00	68.05	38.20	7.45	20.54	57.84	74.00	-16.16	PK
H	2500.00	57.14	38.20	7.45	20.54	46.93	54.00	-7.07	AV
<p><b>Remark:</b></p> <p>1. Emission Level = Meter Reading + Factor, Margin= Emission Level - Limit</p> <p>2. If peak below the average limit, the average emission was no test.</p> <p>3. The amplitude of spurious emissions which are attenuated by more than 20dB below the permissible value has no need to be reported.</p>									



Polar (H/V)	Frequency	Meter Reading	Pre-amplifier	Cable Loss	Antenna Factor	Emission level	Limits	Margin	Detector Type
	(MHz)	(dBuV)	(dB)	(dB)	(dB/m)	(dBuV/m)	(dBuV/m)	(dB)	
<b>802.11n(20MHz) operation frequency:2412</b>									
V	2390.00	68.29	38.06	7.42	20.15	57.80	74.00	-16.20	PK
V	2390.00	56.75	38.06	7.42	20.15	46.26	54.00	-7.74	AV
V	2400.00	68.53	38.06	7.42	20.15	58.04	74.00	-15.96	PK
V	2400.00	56.30	38.06	7.42	20.15	45.81	54.00	-8.19	AV
H	2390.00	68.61	38.06	7.42	20.15	58.12	74.00	-15.88	PK
H	2390.00	56.78	38.06	7.42	20.15	46.29	54.00	-7.71	AV
H	2400.00	68.46	38.06	7.42	20.15	57.97	74.00	-16.03	PK
H	2400.00	56.70	38.06	7.42	20.15	46.21	54.00	-7.79	AV
<b>802.11n(20MHz) operation frequency:2462</b>									
V	2483.50	68.43	38.17	7.42	20.51	58.19	74.00	-15.81	PK
V	2483.50	56.92	38.17	7.42	20.51	46.68	54.00	-7.32	AV
V	2500.00	68.35	38.20	7.45	20.54	58.14	74.00	-15.86	PK
V	2500.00	56.32	38.20	7.45	20.54	46.11	54.00	-7.89	AV
H	2483.50	68.55	38.17	7.42	20.51	58.31	74.00	-15.69	PK
H	2483.50	56.96	38.17	7.42	20.51	46.72	54.00	-7.28	AV
H	2500.00	68.14	38.20	7.45	20.54	57.93	74.00	-16.07	PK
H	2500.00	57.21	38.20	7.45	20.54	47.00	54.00	-7.00	AV
<b>802.11n(40MHz) operation frequency:2422</b>									
V	2390.00	68.15	38.06	7.42	20.15	57.66	74.00	-16.34	PK
V	2390.00	56.61	38.06	7.42	20.15	46.12	54.00	-7.88	AV
V	2400.00	68.38	38.06	7.42	20.15	57.89	74.00	-16.11	PK
V	2400.00	56.19	38.06	7.42	20.15	45.70	54.00	-8.30	AV
H	2390.00	68.46	38.06	7.42	20.15	57.97	74.00	-16.03	PK
H	2390.00	56.64	38.06	7.42	20.15	46.15	54.00	-7.85	AV
H	2400.00	68.33	38.06	7.42	20.15	57.84	74.00	-16.16	PK
H	2400.00	56.57	38.06	7.42	20.15	46.08	54.00	-7.92	AV
<b>802.11n(40MHz) operation frequency:2452</b>									
V	2483.50	68.28	38.17	7.42	20.51	58.04	74.00	-15.96	PK
V	2483.50	56.78	38.17	7.42	20.51	46.54	54.00	-7.46	AV
V	2500.00	68.22	38.20	7.45	20.54	58.01	74.00	-15.99	PK
V	2500.00	56.22	38.20	7.45	20.54	46.01	54.00	-7.99	AV
H	2483.50	68.40	38.17	7.42	20.51	58.16	74.00	-15.84	PK
H	2483.50	56.82	38.17	7.42	20.51	46.58	54.00	-7.42	AV
H	2500.00	68.02	38.20	7.45	20.54	57.81	74.00	-16.19	PK
H	2500.00	57.10	38.20	7.45	20.54	46.89	54.00	-7.11	AV

**Remark:**

1. Emission Level = Meter Reading + Factor, Margin= Emission Level - Limit
2. If peak below the average limit, the average emission was no test.
3. The amplitude of spurious emissions which are attenuated by more than 20dB below the permissible value has no need to be reported.



## 4. POWER SPECTRAL DENSITY TEST

### 4.1 APPLIED PROCEDURES / LIMIT

FCC Part15 (15.247) , Subpart C				
Section	Test Item	Limit	Frequency Range (MHz)	Result
15.247	Power Spectral Density	8 dBm (in any 3KHz)	2400-2483.5	PASS

#### 4.1.1 TEST PROCEDURE

For Average Power (Duty cycle  $\geq 98\%$ )

- Set instrument center frequency to DTS channel center frequency.
- Set span to at least 1.5 times the OBW.
- Set RBW to:  $3 \text{ kHz} \leq \text{RBW} \leq 100 \text{ kHz}$ .
- Set VBW  $\geq 3 \times \text{RBW}$ .
- Detector = power averaging (RMS) or sample detector (when RMS not available).
- Ensure that the number of measurement points in the sweep  $\geq 2 \times \text{span}/\text{RBW}$ .
- Sweep time = auto couple.
- Employ trace averaging (RMS) mode over a minimum of 100 traces.
- Use the peak marker function to determine the maximum amplitude level.

For Average Power (Duty cycle  $< 98\%$ )

- Measure the duty cycle (x).
- Set instrument center frequency to DTS channel center frequency.
- Set span to at least 1.5 times the OBW.
- Set RBW to:  $3 \text{ kHz} \leq \text{RBW} \leq 100 \text{ kHz}$ .
- Set VBW  $\geq 3 \times \text{RBW}$ .
- Detector = power averaging (RMS) or sample detector (when RMS not available).
- Ensure that the number of measurement points in the sweep  $\geq 2 \times \text{span}/\text{RBW}$ .
- Sweep time = auto couple.
- Do not use sweep triggering. Allow sweep to "free run".
- Employ trace averaging (RMS) mode over a minimum of 100 traces.
- Use the peak marker function to determine the maximum amplitude level.
- Add  $10 \log(1/x)$ , where x is the duty cycle measured in step (a), to the measured PSD to compute the average PSD during the actual transmission time.

#### 4.1.2 DEVIATION FROM STANDARD

No deviation.

#### 4.1.3 TEST SETUP

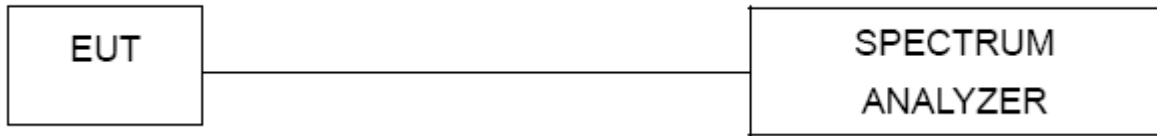

#### 4.1.4 EUT OPERATION CONDITIONS

The EUT tested system was configured as the statements of 2.1 Unless otherwise a special operating condition is specified in the follows during the testing.  
we test all antenna's data, the data only show the antenna1 worst mode



**4.1.5 TEST RESULTS**

	Frequency	Power Spectral Density (dBm)		Total Power Spectral Density (dBm)	Limit (dBm)	Result
		ANT1	ANT2			
<b>802.11b</b>	2412 MHz	-7.52	-7.69	/	<8	PASS
	2437 MHz	-6.65	-7.84	/	<8	PASS
	2462 MHz	-7.49	-7.71	/	<8	PASS
<b>802.11g</b>	2412 MHz	-10.81	-10.84	/	<8	PASS
	2437 MHz	-9.52	-10.86	/	<8	PASS
	2462 MHz	-10.53	-10.73	/	<8	PASS
<b>802.11n (20MHz)</b>	2412 MHz	-8.53	-9.86	-6.13	<8	PASS
	2437 MHz	-10.40	-9.97	-7.17	<8	PASS
	2462 MHz	-8.43	-10.63	-6.38	<8	PASS
<b>802.11n (40MHz)</b>	2422 MHz	-11.05	-13.95	-9.25	<8	PASS
	2437 MHz	-13.66	-14.82	-11.19	<8	PASS
	2452 MHz	-14.28	-14.72	-11.48	<8	PASS

Method 1 of power density measurement of KDB 662911 is using for calculating total power density. Total power density is summing entire spectra across corresponding frequency bins on the various outputs by computer.





(802.11b) channel 1

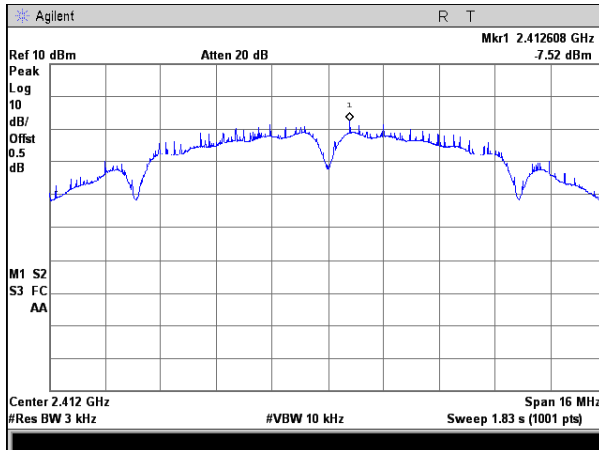

(802.11g) channel 1

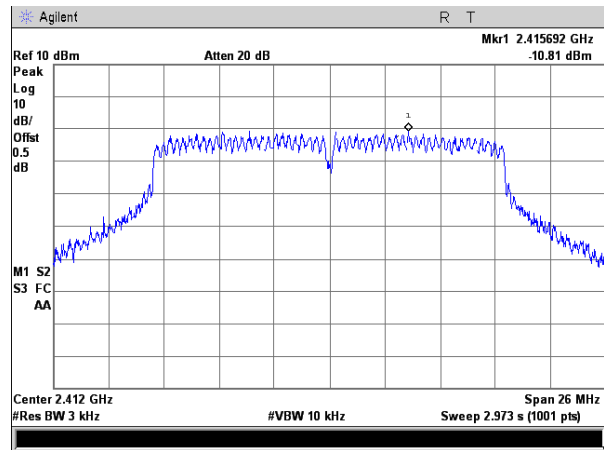

(802.11b) channel 6

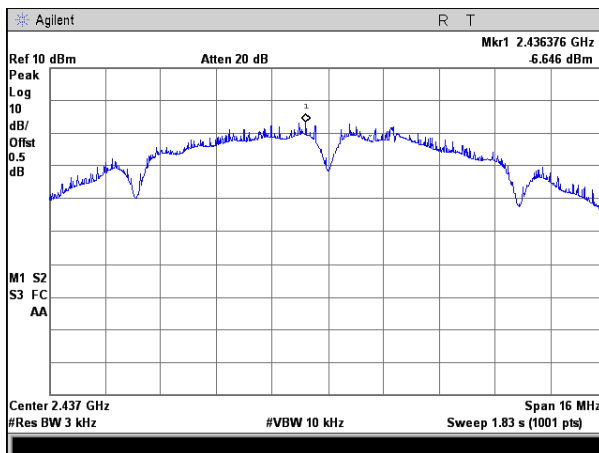

(802.11g) channel 6

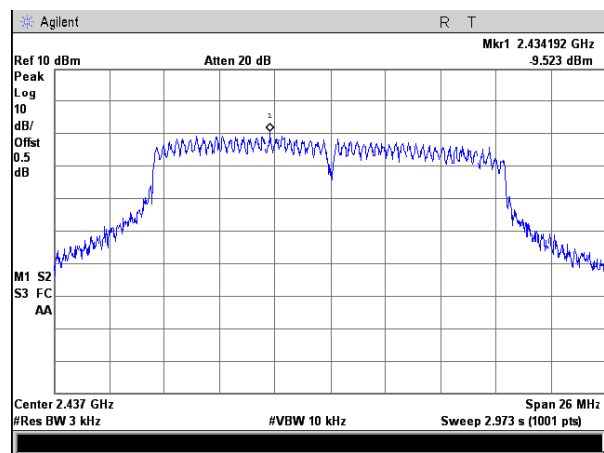

(802.11b) channel 11

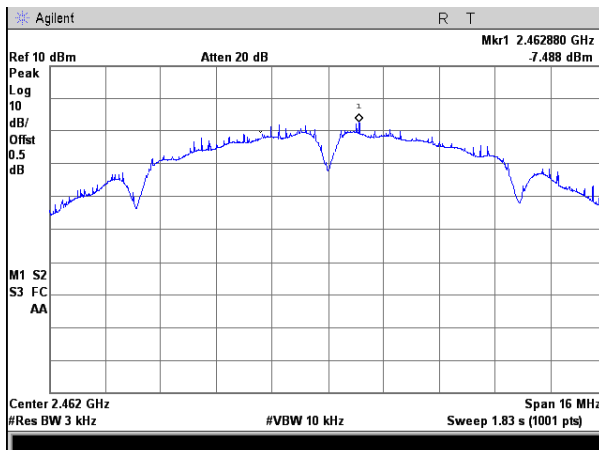

(802.11g) channel 11

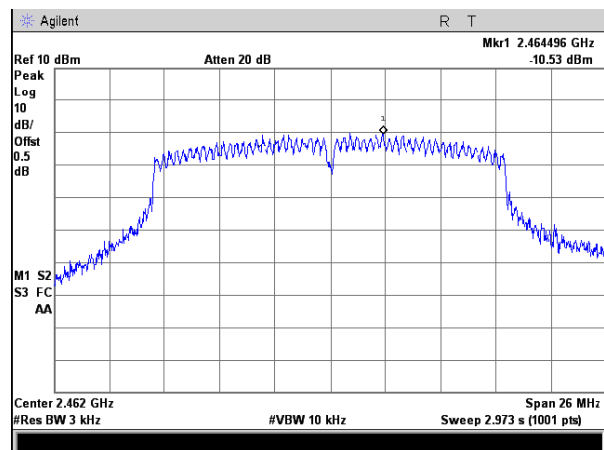



(802.11n20) channel 1

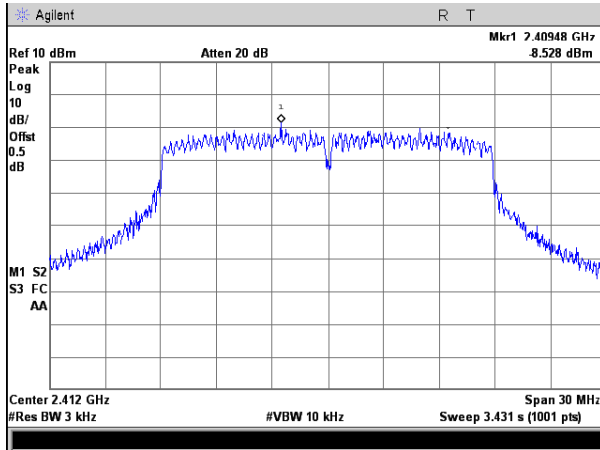

(802.11n40) channel 3

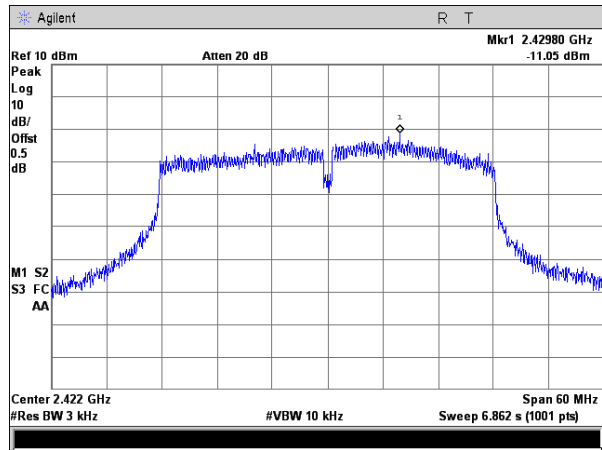

(802.11n20) channel 6

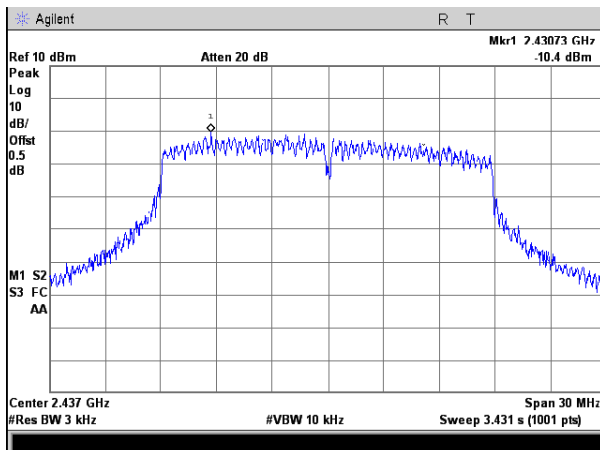

(802.11n40) channel 6

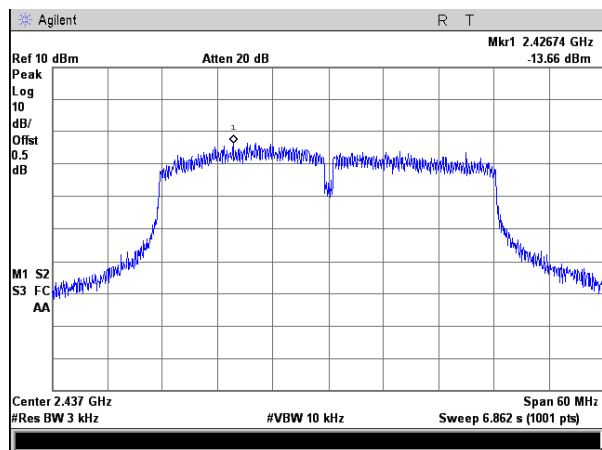

(802.11n20) channel 11

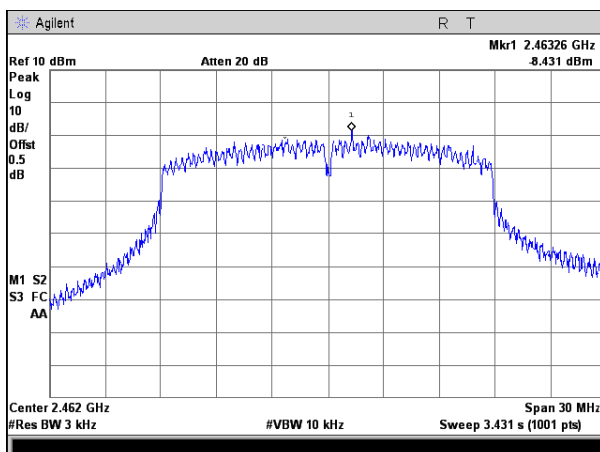

(802.11n40) channel 9

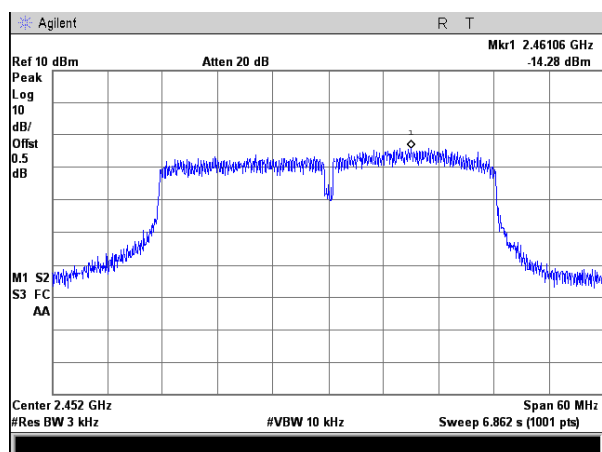

## 5. BANDWIDTH TEST

### 5.1 APPLIED PROCEDURES / LIMIT

FCC Part15 (15.247) , Subpart C				
Section	Test Item	Limit	Frequency Range (MHz)	Result
15.247(a)(2)	Bandwidth	$\geq 500\text{KHz}$ (6dB bandwidth)	2400-2483.5	PASS

#### 5.1.1 TEST PROCEDURE

1. Set RBW = 100 kHz.
2. Set the video bandwidth (VBW)  $\geq 3 \times$  RBW.
3. Detector = Peak.
4. Trace mode = max hold.
5. Sweep = auto couple.
6. Allow the trace to stabilize.
7. Measure the maximum width of the emission that is constrained by the frequencies associated with the two outermost amplitude points (upper and lower frequencies) that are attenuated by 6 dB relative to the maximum level measured in the fundamental emission.

#### 5.1.2 DEVIATION FROM STANDARD

No deviation.

#### 5.1.3 TEST SETUP



#### 5.1.4 EUT OPERATION CONDITIONS

The EUT tested system was configured as the statements of 2.4 Unless otherwise a special operating condition is specified in the follows during the testing. we test all antenna's data, the data only show the antenna1 worst mode



### 5.1.5 TEST RESULTS

	Frequency (MHz)	6dB bandwidth (MHz)		Limit (kHz)	Result
		ANT1	ANT2		
802.11b	2412	8.12	7.86	>500	Pass
	2437	7.61	7.92	>500	Pass
	2462	7.56	7.82	>500	Pass
802.11g	2412	15.96	15.86	>500	Pass
	2437	15.43	15.92	>500	Pass
	2462	15.08	16.06	>500	Pass
802.11n20	2412	16.93	16.38	>500	Pass
	2437	15.97	16.48	>500	Pass
	2462	15.15	16.43	>500	Pass
802.11n40	2422	32.64	34.52	>500	Pass
	2437	34.02	35.03	>500	Pass
	2452	35.24	35.34	>500	Pass



(802.11b) channel 1

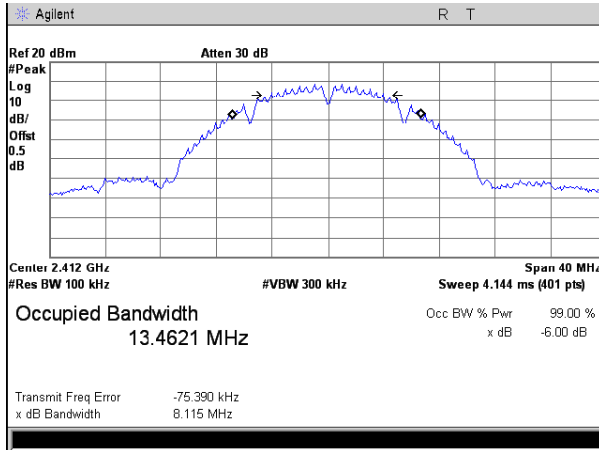

(802.11g) channel 1

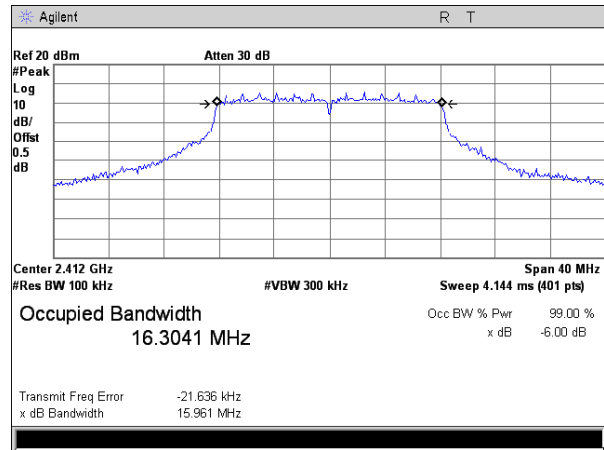

(802.11b) channel 6

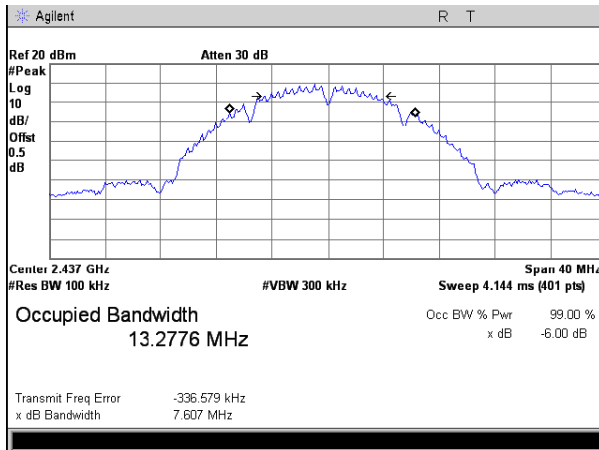

(802.11g) channel 6

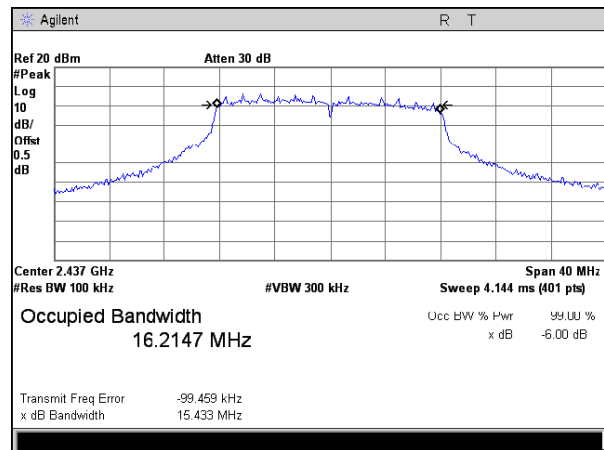

(802.11b) channel 11

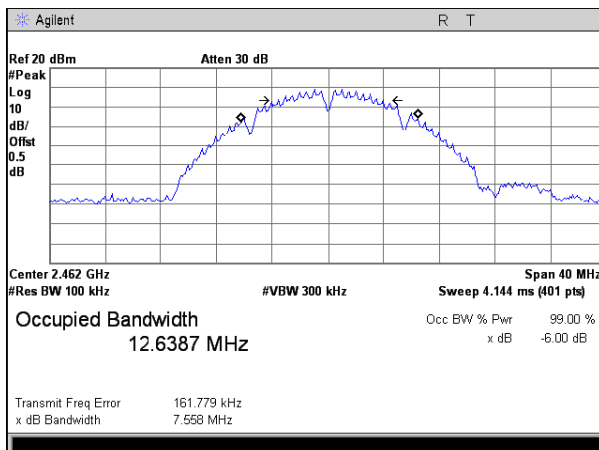

(802.11g) channel 11

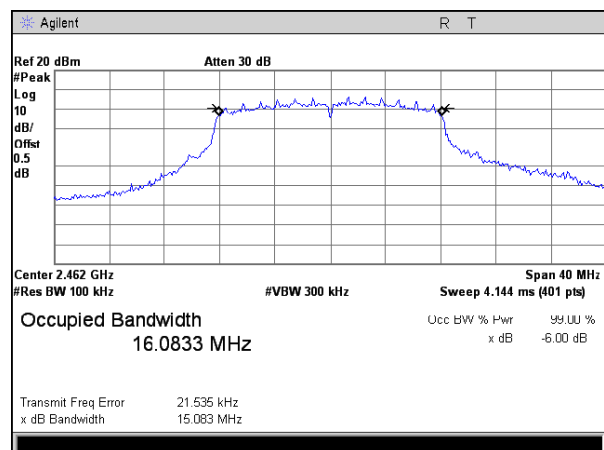



(802.11n20) channel 1

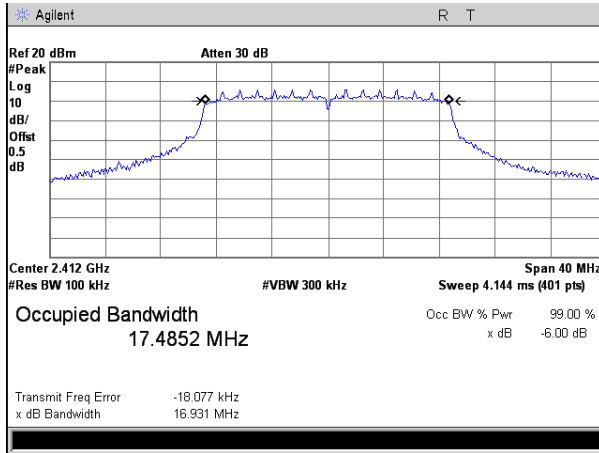

(802.11n40) channel 3

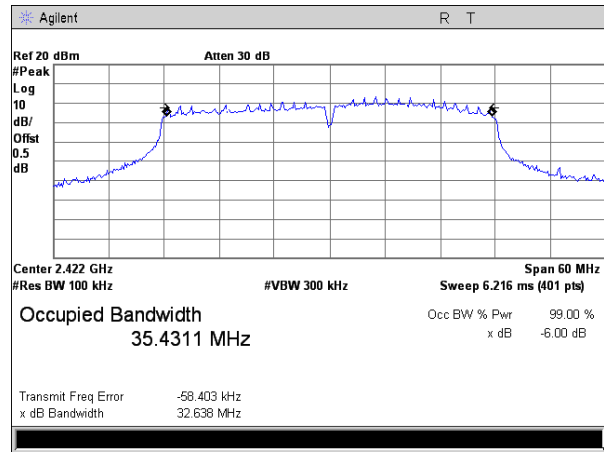

(802.11n20) channel 6

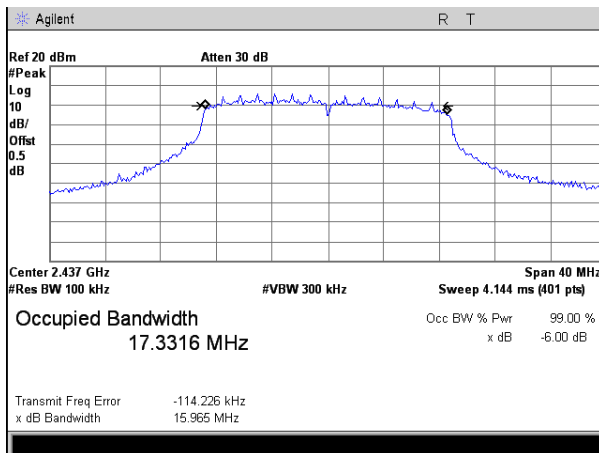

(802.11n40) channel 6

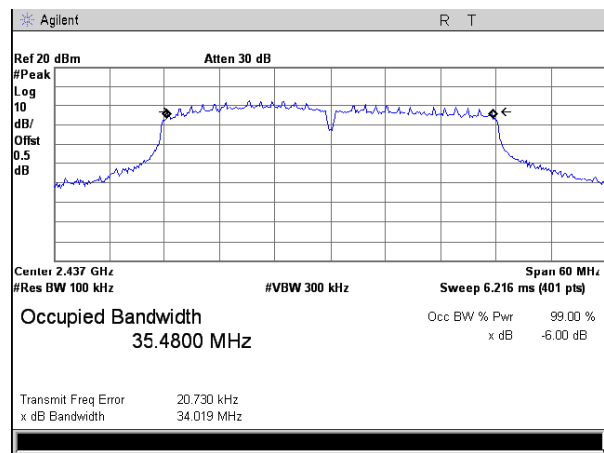

(802.11n20) channel 11

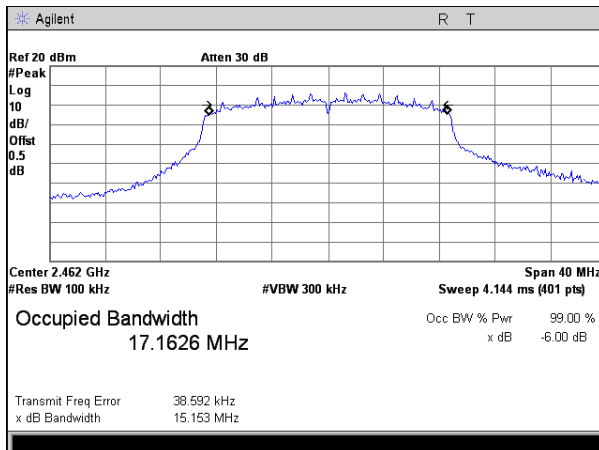

(802.11n40) channel 9

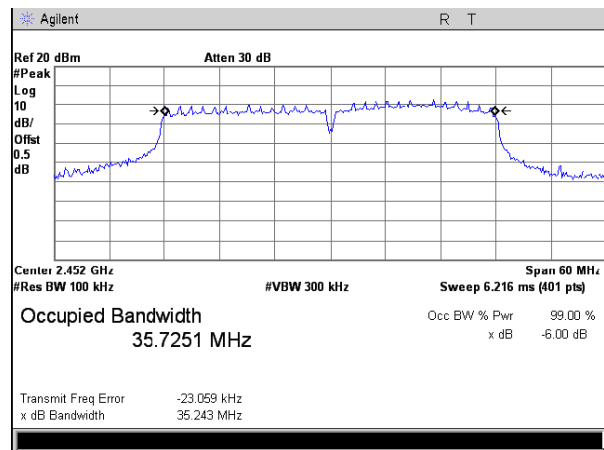

## 6. PEAK OUTPUT POWER TEST

### 6.1 APPLIED PROCEDURES / LIMIT

FCC Part15 (15.247) , Subpart C				
Section	Test Item	Limit	Frequency Range (MHz)	Result
15.247(b)(3)	Peak Output Power	1 watt or 30dBm	2400-2483.5	PASS
Per KDB 662911 D01 Multiple Transmitter Output Method of conducted output power measurement on IEEE 802.11 devices, Array Gain = 0 dB (i.e., no array gain) for NANT $\leq$ 4; Array Gain = 0 dB (i.e., no array gain) for channel widths $\geq$ 40 MHz for any NANT; Array Gain = 5 log(NANT/NSS) dB or 3 dB, whichever is less for 20-MHz channel widths with NANT $\geq$ 5. For power measurements on all other devices: Array Gain = 10 log(NANT/NSS) dB.				

#### 6.1.1 TEST PROCEDURE

- a. The EUT was directly connected to the Power meter

#### 6.1.2 DEVIATION FROM STANDARD

No deviation.

#### 6.1.3 TEST SETUP



#### 6.1.4 EUT OPERATION CONDITIONS

The EUT tested system was configured as the statements of 2.4 Unless otherwise a special operating condition is specified in the follows during the testing.

**6.1.5 TEST RESULTS**

	Frequency (MHz)	Maximum Conducted Output Power(PK)(dBm)		Total Output Power (dBm)	LIMIT dBm
		ANT1	ANT2		
802.11b	2412	17.57	17.50	/	30
	2437	17.63	17.54	/	30
	2462	17.59	17.45	/	30
802.11g	2412	15.63	15.48	/	30
	2437	15.51	15.43	/	30
	2462	15.59	15.36	/	30
802.11n20	2412	11.49	11.40	14.46	30
	2437	11.51	11.37	14.45	30
	2462	11.47	11.42	14.46	30
802.11n40	2422	10.19	10.14	13.18	30
	2437	10.23	10.19	13.22	30
	2452	10.17	10.29	13.24	30





## 7. 100 KHZ BANDWIDTH OF FREQUENCY BAND EDGE

### 7.1 APPLICABLE STANDARD

In any 100 kHz bandwidth outside the frequency band in which the spread spectrum intentional radiator is operating, the radio frequency power that is produced by the intentional radiator shall be at least 20 dB below that in the 100 kHz bandwidth within the band that contains the highest level of the desired power, based on either an RF conducted or a radiated measurement.

### 7.2 TEST PROCEDURE

- a) Check the calibration of the measuring instrument using either an internal calibrator or a known signal from an external generator.
- b) Position the EUT without connection to measurement instrument. Turn on the EUT and connect its antenna terminal to measurement instrument via a low loss cable. Then set it to any one measured frequency within its operating range, and make sure the instrument is operated in its linear range.
- c) Set RBW to 100 kHz and VBW of spectrum analyzer to 100 kHz with a convenient frequency span including 100 kHz bandwidth from band edge.
- d) Measure the highest amplitude appearing on spectral display and set it as a reference level. Plot the graph with marking the highest point and edge frequency.
- e) Repeat above procedures until all measured frequencies were complete.

### 7.3 DEVIATION FROM STANDARD

No deviation.

### 7.4 TEST SETUP



### 7.5 EUT OPERATION CONDITIONS

The EUT tested system was configured as the statements of 2.4 Unless otherwise a special operating condition is specified in the follows during the testing. we test all antenna's data, the data only show the antenna1 worst mode

### 7.1 TEST RESULTS



802.11b: Band Edge, Left Side

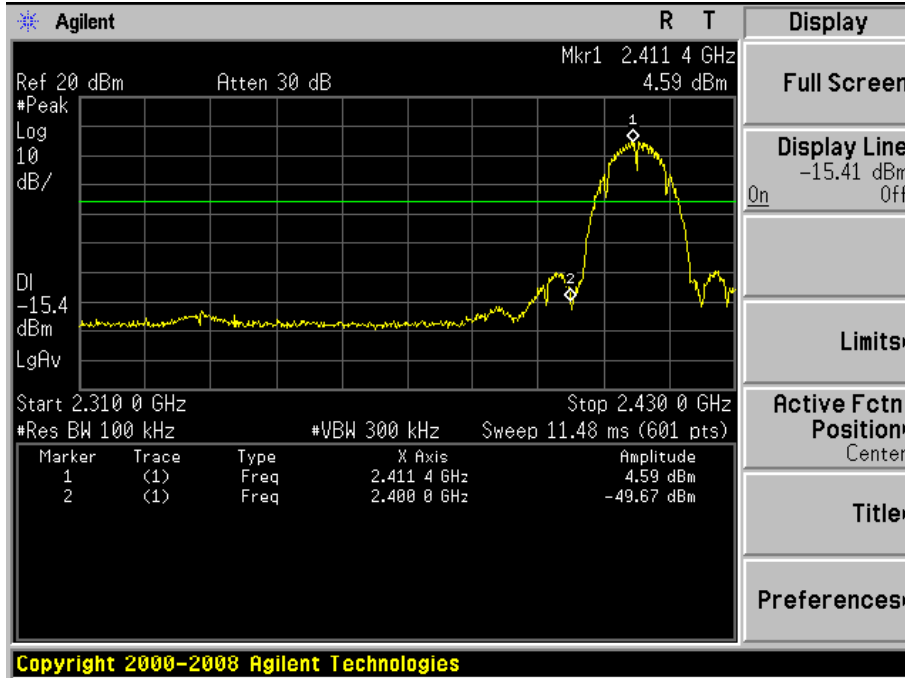

802.11b: Band Edge, Right Side

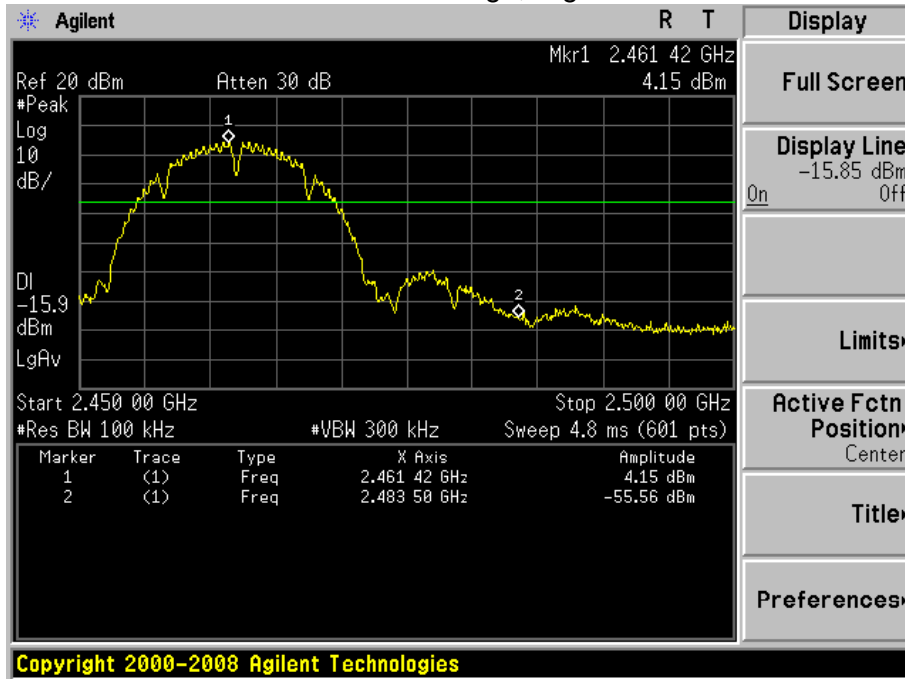



802.11g: Band Edge, Left Side

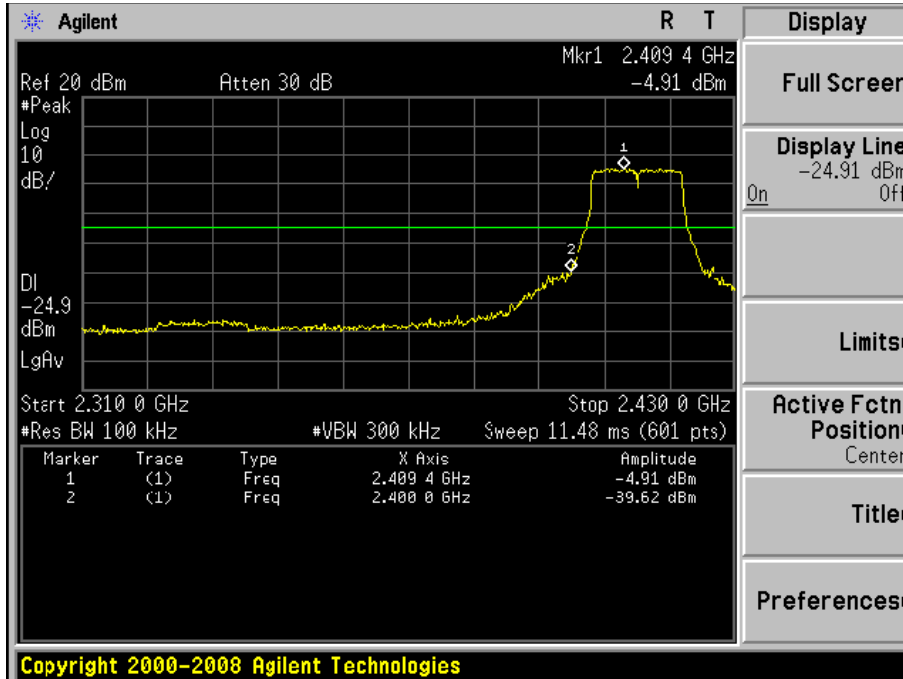

802.11g: Band Edge, Right Side

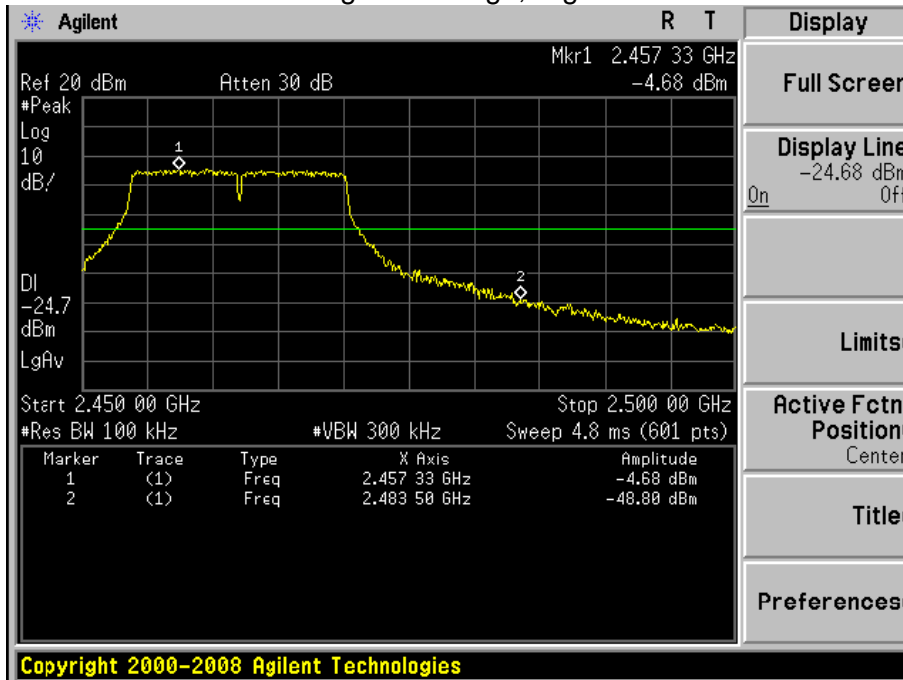



802.11n-HT20: Band Edge, Left Side

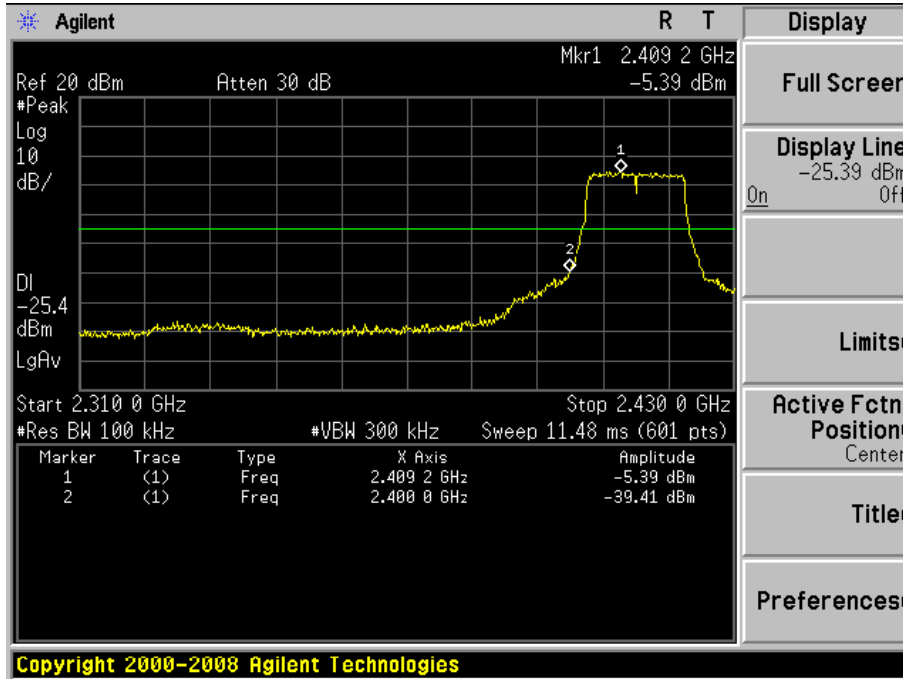

802.11n-HT20: Band Edge, Right Side

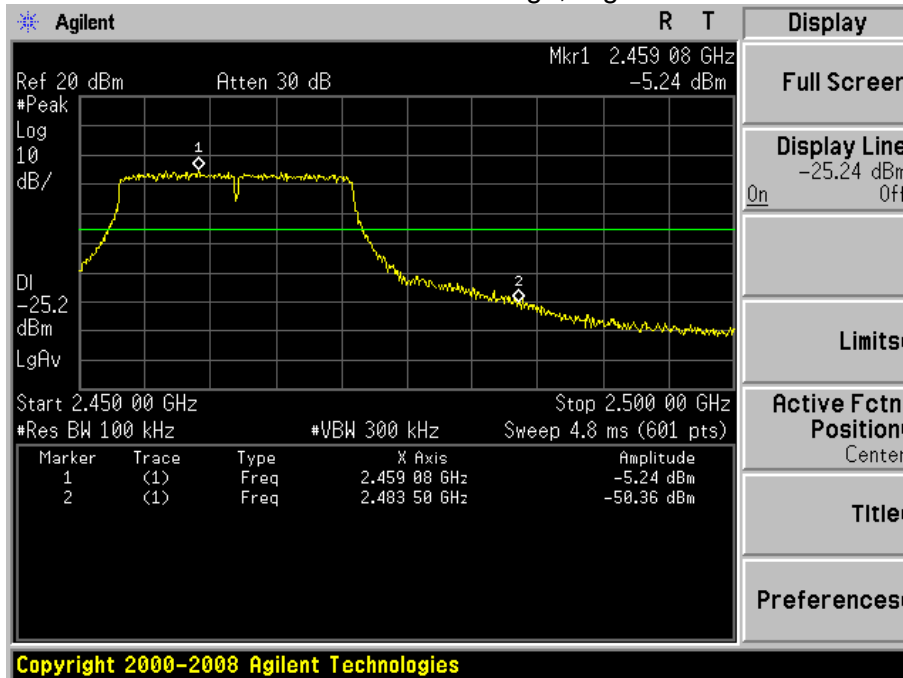



802.11n-HT40: Band Edge, Left Side

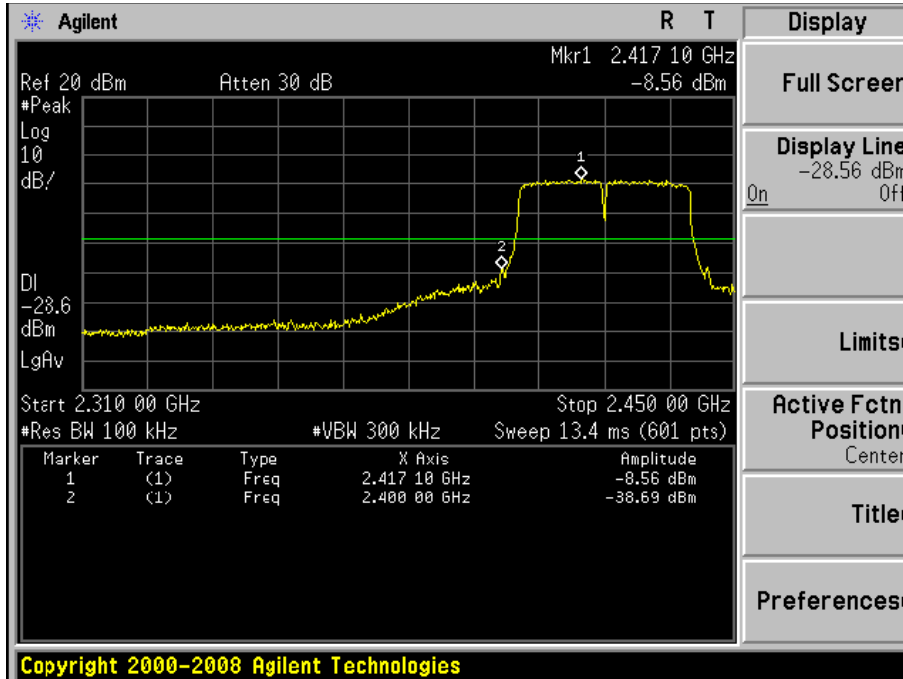

802.11n-HT40: Band Edge, Right Side

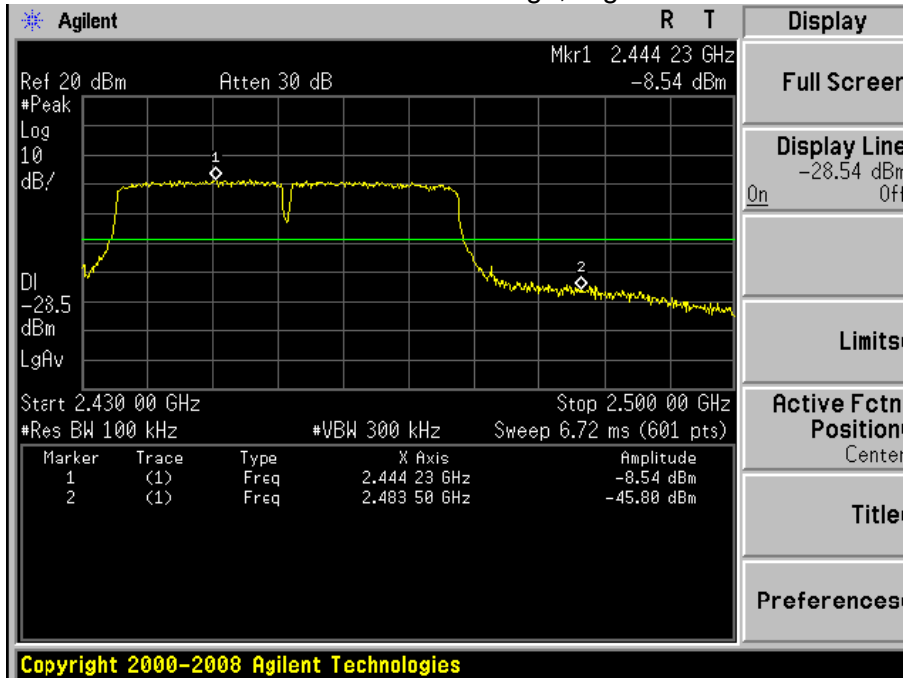



## **8. ANTENNA REQUIREMENT**

### **8.1 STANDARD REQUIREMENT**

15.203 requirement: For intentional device, according to 15.203: an intentional radiator shall be designed to ensure that no antenna other than that furnished by the responsible party shall be used with the device.

### **8.2 EUT ANTENNA**

The EUT antenna is permanent connection external antenna, It comply with the standard requirement.

## 9. EUT TEST PHOTO

### Radiated Measurement Photos

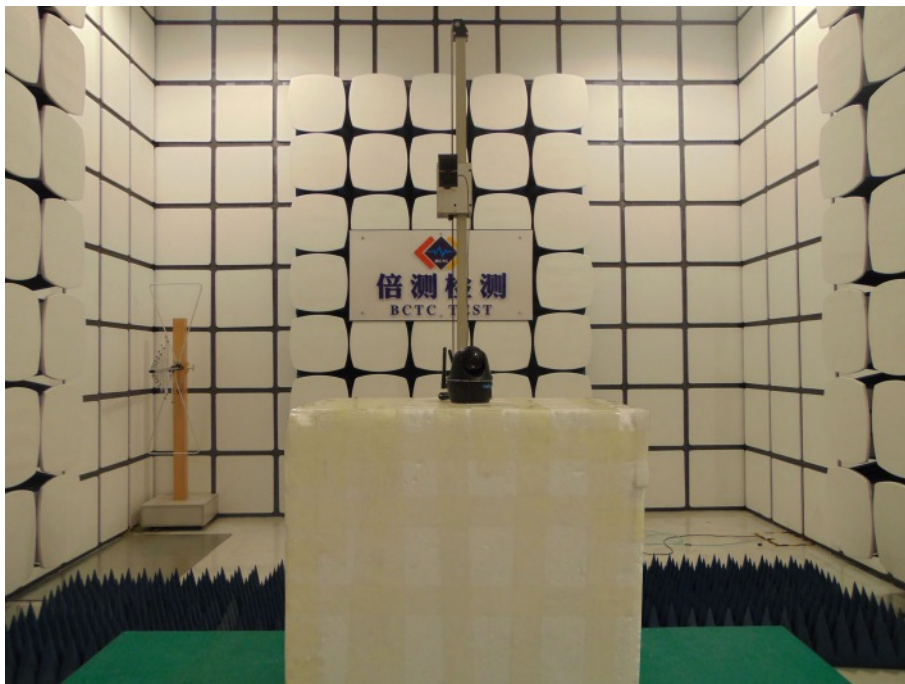
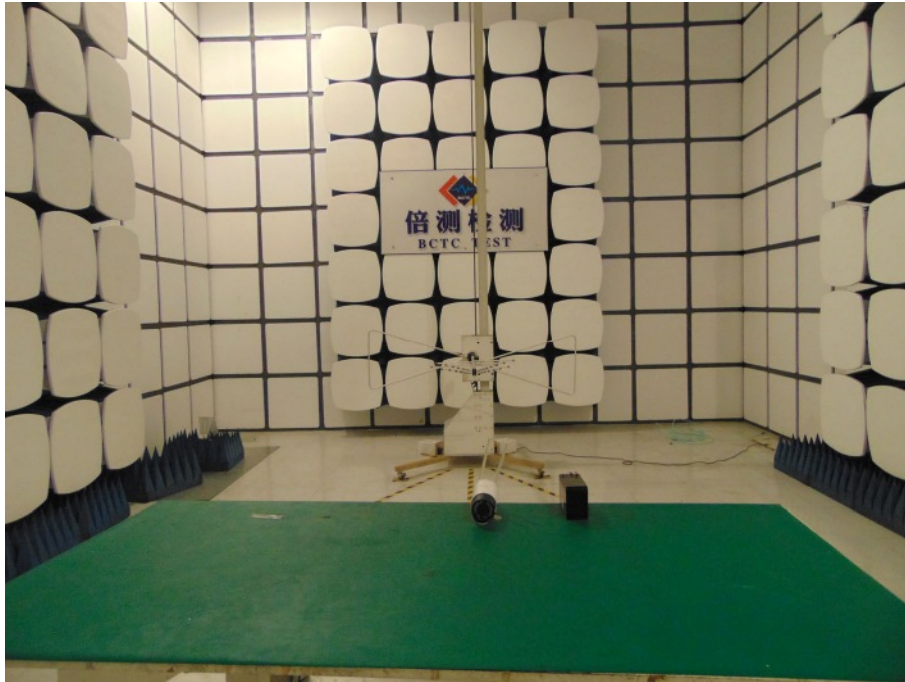

### Conducted Measurement Photos





## 10. EUT PHOTO

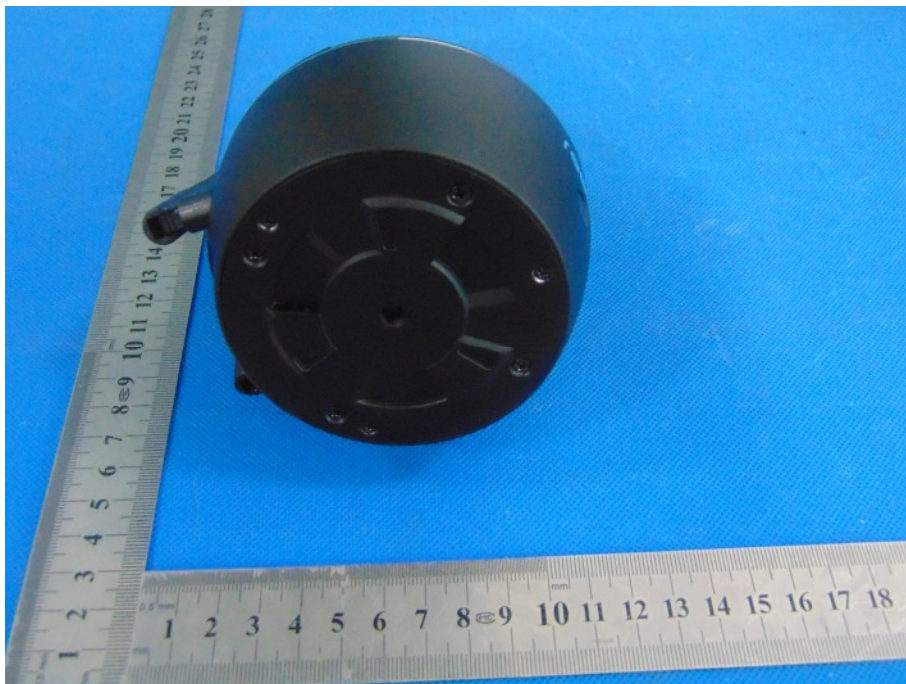



\*\*\*\*\* END OF REPORT \*\*\*\*\*