



# FCC Part 15E Test Report

## FCC ID: 2AL7V-E1PRO

Product Name:	WiFi IP Camera
Trademark:	N/A
Model Name :	E1 Pro E1, E2
Prepared For :	Shenzhen Reo-link Digital Technology Co., Ltd
Address :	11th Floor, Building C, Unisplendour Information Harbour, North High-Tech Zone Nanshan District, Shenzhen 518057, China
Prepared By :	Shenzhen BCTC Testing Co., Ltd.
Address :	BCTC Building & 1-2F, East of B Building, Pengzhou Industrial, Fuyuan 1st Road, Qiaotou Community, Fuyong Street, Bao'an District, Shenzhen, China
Test Date:	Jun. 25, 2019 – Jul. 09, 2019
Date of Report :	Jul. 09, 2019
Report No.:	BCTC-FY190603177E



### TEST RESULT CERTIFICATION

**Applicant's name** ..... : Shenzhen Reo-link Digital Technology Co., Ltd  
**Address** ..... : 11th Floor, Building C, Unisplendour Information Harbour,  
North High-Tech Zone Nanshan District, Shenzhen 518057,  
China

**Manufacture's Name**..... : SHENZHEN BAICHUAN SECURITY TECHNOLOGY  
CO.,LTD  
**Address** ..... : 2-4th Floor, Building 2, YuanLing Industrial Park, ShangWu,  
Shiyan Street, Bao' an District, Shenzhen , China

**Product description**

**Product name**..... : WiFi IP Camera  
**Trademark** ..... :  
N/A

**Model and/or type reference** : E1 Pro  
E1, E2

**Standards** ..... : FCC Part15 15.407  
ANSI C63.10-2013  
KDB 662911 D01 v02r01  
KDB 789033 D02 v01r02

This device described above has been tested by BCTC, and the test results show that the equipment under test (EUT) is in compliance with the FCC requirements. And it is applicable only to the tested sample identified in the report.

This report shall not be reproduced except in full, without the written approval of BCTC, this document may be altered or revised by BCTC, personal only, and shall be noted in the revision of the document.

**Prepared by(Engineer):** Willem Wang  
**Reviewer(Supervisor):** Eric Yang  
**Approved(Manager):** Zero Zhou

*Willem Wang*  



Table of Contents

	Page
<b>1 . SUMMARY OF TEST RESULTS</b>	<b>6</b>
1.1 TEST FACILITY	7
1.2 MEASUREMENT UNCERTAINTY	7
<b>2 . GENERAL INFORMATION</b>	<b>8</b>
<b>3 . EMC EMISSION TEST</b>	<b>14</b>
3.1 CONDUCTED EMISSION MEASUREMENT	14
3.1.1 POWER LINE CONDUCTED EMISSION LIMITS	14
3.1.2 TEST PROCEDURE	15
3.1.3 DEVIATION FROM TEST STANDARD	15
3.1.4 TEST SETUP	15
3.1.5 EUT OPERATING CONDITIONS	15
3.2 RADIATED EMISSION MEASUREMENT	18
3.2.1 APPLICABLE STANDARD	18
3.2.2 CONFORMANCE LIMIT	18
3.2.3 MEASURING INSTRUMENTS	18
3.2.4 TEST CONFIGURATION	19
3.2.5 TEST PROCEDURE	20
3.2.6 TEST RESULTS (9KHZ – 30 MHZ)	21
3.2.7 TEST RESULTS (30MHZ – 1GHZ)	22
3.2.8 TEST RESULTS (1GHZ-40GHZ)	24
<b>4 . POWER SPECTRAL DENSITY TEST</b>	<b>26</b>
4.1 APPLIED PROCEDURES / LIMIT	26
4.2 TEST PROCEDURE	27
4.3 DEVIATION FROM STANDARD	27
4.4 TEST SETUP	27
4.5 EUT OPERATION CONDITIONS	27
4.6 TEST RESULTS	28
<b>5 . 26DB &amp; 99% &amp; 6DB EMISSION BANDWIDTH</b>	<b>42</b>
5.1 APPLIED PROCEDURES / LIMIT	42
5.2 TEST PROCEDURE	42
5.3 EUT OPERATION CONDITIONS	42
5.4 TEST RESULTS	43
Antenna A:	43



**Table of Contents**

	<b>Page</b>
<b>6 . MAXIMUM CONDUCTED OUTPUT POWER</b>	<b>58</b>
6.1 PPLIED PROCEDURES / LIMIT	58
6.2 TEST PROCEDURE	58
6.3 DEVIATION FROM STANDARD	59
6.4 TEST SETUP	59
6.5 EUT OPERATION CONDITIONS	60
6.6 TEST RESULTS	61
<b>7 . OUT OF BAND EMISSIONS</b>	<b>63</b>
7.1 APPLICABLE STANDARD	63
7.2 TEST PROCEDURE	63
7.3 DEVIATION FROM STANDARD	63
7.4 TEST SETUP	63
7.5 EUT OPERATION CONDITIONS	64
7.6 TEST RESULTS	65
<b>8.SPURIOUS RF CONDUCTED EMISSIONS</b>	<b>85</b>
8.1CONFORMANCE LIMIT	85
8.2MEASURING INSTRUMENTS	85
8.3TEST SETUP	85
8.4TEST PROCEDURE	85
8.5TEST RESULTS	85
<b>9. FREQUENCY STABILITY MEASUREMENT</b>	<b>102</b>
9.1 LIMIT	102
9.2 TEST PROCEDURES	102
9.3 TEST SETUP LAYOUT	102
9.4 EUT OPERATION DURING TEST	102
9.5 TEST RESULTS	103
<b>10. ANTENNA REQUIREMENT</b>	<b>109</b>
10.1 STANDARD REQUIREMENT	109
10.2 EUT ANTENNA	109
<b>11. EUT TEST PHOTO</b>	<b>110</b>
<b>12. EUT PHOTO</b>	<b>112</b>



**Revision History**

Report No.	Version	Description	Issued Date
BCTC-FY190603177E	Rev.01	Initial issue of report	Jul. 09, 2019



**1. SUMMARY OF TEST RESULTS**

Test procedures according to the technical standards:

<b>FCC Part15 (15.407) , Subpart E</b>			
Standard Section	Test Item	Judgment	Remark
15.209(a), 15.407 (b)(1) 15.407 (b)(4) 15.407 (b)(6)	Spurious Radiated Emissions	PASS	
15.407 (a)(1) 15.407 (a)(3) 15.1049	26 dB and 99% Emission Bandwidth	PASS	
15.407(e)	Minimum 6 dB bandwidth	PASS	
15.407 (a)(1) 15.407 (a)(3)	Maximum Conducted Output Power	PASS	
2.1051, 15.407(b)(1) 15.407(b)(4)	Band Edge	PASS	
15.407 (a)(1) 15.407 (a)(3)	Power Spectral Density	PASS	
2.1051, 15.407(b)	Spurious Emissions at Antenna Terminals	PASS	
15.203	Antenna Requirement	PASS	

**NOTE:**

(1) "N/A" denotes test is not applicable in this Test Report

Outsourcing: The 26G-40G Spurious Radiated Emissions in this test were outsourced to the Shenzhen Academy of Metrology & Quality Inspection



## 1.1 TEST FACILITY

Shenzhen BCTC Testing Co., Ltd.

Add. : BCTC Building & 1-2F, East of B Building, Pengzhou Industrial, Fuyuan 1st Road, Qiaotou Community, Fuyong Street, Bao'an District, Shenzhen, China

FCC Test Firm Registration Number: 712850

IC Registered No.: 23583

## 1.2 MEASUREMENT UNCERTAINTY

The reported uncertainty of measurement  $y \pm U$  · where expanded uncertainty  $U$  is based on a standard uncertainty multiplied by a coverage factor of  $k=2$  · providing a level of confidence of approximately **95 %** ·

No.	Item	Uncertainty
1	3m chamber Radiated spurious emission(30MHz-1GHz)	U=4.3dB
2	3m chamber Radiated spurious emission(1GHz-18GHz)	U=4.5dB
3	3m chamber Radiated spurious emission(18GHz-40GHz)	U=3.34dB
4	Conducted Adjacent channel power	U=1.38dB
5	Conducted output power uncertainty Above 1G	U=1.576dB
6	Conducted output power uncertainty below 1G	U=1.28dB
7	humidity uncertainty	U=5.3%
8	Temperature uncertainty	U=0.59 °C



## 2. GENERAL INFORMATION

### 2.1 GENERAL DESCRIPTION OF EUT

Equipment	WiFi IP Camera	
Trade Name	N/A	
Model Name	E1 Pro E1, E2	
Model Difference	All the model are the same circuit and RF module, except model names .	
Product Description	IEEE 802.11 WLAN Mode Supported	<input checked="" type="checkbox"/> 802.11a/n(20MHz channel bandwidth) <input checked="" type="checkbox"/> 802.11n(40MHz channel bandwidth)
	Data Rate	802.11a: 6,9,12,18,24,36,48,54Mbps; 802.11n(HT20/HT40):MCS0-MCS15;
	Modulation	OFDM with BPSK/QPSK/16QAM/64QAM for 802.11a/n;
	Frequency Range	5150-5250MHz; 5725-5850MHz
	Number of Channels	<input checked="" type="checkbox"/> 4 channels for 802.11a/n20 in the 5150-5250MHz band ; <input checked="" type="checkbox"/> 2 channels for 802.11 n40 in the 5150-5250MHz band ; <input checked="" type="checkbox"/> 5 channels for 802.11a/n20 in the 5725-5850MHz band ; <input checked="" type="checkbox"/> 2 channels for 802.11 n40 in the 5725-5850MHz band ;
	Antenna Type	Antenna A&B:FPCB Antenna
	Antenna Gain	Antenna A/B:8.23dBi
	Based on the application, features, or specification exhibited in User's Manual, the EUT is considered as an ITE/Computing Device. More details of EUT technical specification, please refer to the User's Manual.	
	Channel List	Please refer to the Note 2.
Type of device	Indoor Access device	
Power	Model: DCT12W050100US-B0 Input: 100-240V~50/60Hz 0.3A max. Output: 5.0V 1.0A	
hardware version	N/A	
Software version	N/A	
Serial number	N/A	
Connecting I/O Port(s)	Please refer to the User's Manual	

Note:

1. For a more detailed features description, please refer to the manufacturer's specifications or the User's Manual.
- 2 The Testing software is "adb command", The power level set "--txpwr 14".





Frequency and Channel list for 802.11a/n(20MHz) band I (5180-5240MHz):

3.

802.11a/n ( 20MHz) Carrier Frequency Channel							
Channel	Frequency (MHz)	Channel	Frequency (MHz)	Channel	Frequency (MHz)	Channel	Frequency (MHz)
36	5180	44	5220	-	-	-	-
40	5200	48	5240	-	-	-	-

802.11n (40MHz) Carrier Frequency Channel							
Channel	Frequency (MHz)	Channel	Frequency (MHz)	Channel	Frequency (MHz)	Channel	Frequency (MHz)
38	5190	-	-	-	-	-	-
46	5230	-	-	-	-	-	-

Frequency and Channel list for 802.11a/n(20 MHz) band IV (5745-5825MHz):

802.11a/n ( 20 MHz) Carrier Frequency Channel							
Channel	Frequency (MHz)	Channel	Frequency (MHz)	Channel	Frequency (MHz)	Channel	Frequency (MHz)
149	5745	153	5765	157	5785	161	5805
165	5825	-	-	-	-	-	-

802.11n 40MHz Carrier Frequency Channel					
Channel	Frequency (MHz)	Channel	Frequency (MHz)	Channel	Frequency (MHz)
151	5755	159	5795	-	-

Antenna A gain: 5.05dBi, Antenna B gain: 5.38dBi, For MIMO mode for 802.11a20, 802.11n20, 802.11n40, Directional gain=[10log(GA+ G B)] dbi =8.23dbi

Tx Antenna

Antenna	Antenna Type	Antenna Gain(dBi)
A	FPCB antenna	5.05
B	FPCB antenna	5.38



**2.2 DESCRIPTION OF TEST MODES**

Pretest Mode	Description
Mode 1	802.11a / n CH36/ CH40/ CH 48 802.11a /n CH149/ CH157/ CH 165
Mode 2	802.11n40 CH38/ CH 46 802.11n40 CH 151 / CH 159
Mode 3	802.11a / n CH36/ CH40/ CH 48 802.11a /n CH149/ CH157/ CH 165
Mode 4	Link Mode

<b>Conducted Emission</b>	
Final Test Mode	Description
Mode 4	Link Mode

<b>For Radiated Emission</b>	
Final Test Mode	Description
Mode 1	802.11a / n CH36/ CH40/ CH 48 802.11a /n CH149/ CH157/ CH 165
Mode 2	802.11n40 CH38/ CH 46 802.11n40 CH 151 / CH 159
Mode 3	802.11a / n CH36/ CH40/ CH 48 802.11a /n CH149/ CH157/ CH 165

Note:

(1) The measurements are performed at all Bit Rate of Transmitter, the worst data was reported.

**2.3 BLOCK DIGRAM SHOWING THE CONFIGURATION OF SYSTEM TESTED**

Conducted Emission Test

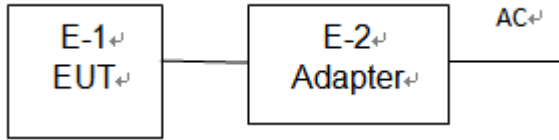

Radiated Spurious Emission

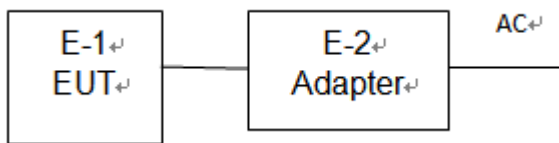

**2.4 DESCRIPTION OF SUPPORT UNITS(CONDUCTED MODE)**

The EUT has been tested as an independent unit together with other necessary accessories or support units. The following support units or accessories were used to form a representative test configuration during the tests.

Item	Equipment	Mfr/Brand	Model/Type No.	Series No.	Note
E-1	WiFi IP Camera	N/A	E1 Pro	N/A	EUT
E-2	Adapter	N/A	DCT12W050100ZZ-D0	N/A	EUT

Note:

- (1) The support equipment was authorized by Declaration of Confirmation.
- (2) For detachable type I/O cable should be specified the length in cm in 『Length』 column.



**2.5 EQUIPMENTS LIST FOR ALL TEST ITEMS**

Radiation Test equipment

Item	Equipment	Manufacturer	Type No.	Serial No.	Last calibration	Calibrated until
1	Spectrum Analyzer (9kHz-26.5GHz)	Agilent	E4407B	MY45109572	2019.06.13	2020.06.12
2	Test Receiver (9kHz-7GHz)	R&S	ESR7	101154	2019.06.13	2020.06.12
3	Bilog Antenna (30MHz-3GHz)	SCHWARZBECK	VULB9163	VULB9163-942	2019.06.22	2020.06.21
4	Horn Antenna (1GHz-18GHz)	SCHWARZBECK	BBHA9120D	1541	2019.06.22	2020.06.21
5	Horn Antenna (18GHz-40GHz)	SCHWARZBECK	BBHA9170	822	2019.06.22	2020.06.21
6	Amplifier (9KHz-6GHz)	SCHWARZBECK	BBV9744	9744-0037	2019.06.25	2020.06.24
7	Amplifier (0.5GHz-18GHz)	SCHWARZBECK	BBV9718	9718-309	2019.06.25	2020.06.24
8	Amplifier (18GHz-40GHz)	MITEQ	TTA1840-35-HG	2034381	2019.06.17	2020.06.16
9	Loop Antenna (9KHz-30MHz)	SCHWARZBECK	FMZB1519B	014	2019.06.25	2020.06.24
10	RF cables1 (9kHz-30MHz)	Huber+Suhnar	9kHz-30MHz	B1702988-0008	2019.06.25	2020.06.24
11	RF cables2 (30MHz-1GHz)	Huber+Suhnar	30MHz-1GHz	1486150	2019.06.25	2020.06.24
12	RF cables3 (1GHz-40GHz)	Huber+Suhnar	1GHz-40GHz	1607106	2019.06.25	2020.06.24
13	Power Metter	Keysight	E4419	\	2019.06.17	2020.06.16
14	Power Sensor (AV)	Keysight	E9 300A	\	2019.06.17	2020.06.16
15	Spectrum Analyzer 20kHz-26.5GHz	KEYSIGHT	N9020A	MY49100060	2019.06.13	2020.06.12
16	Spectrum Analyzer 9kHz-40GHz	R&S	FSP40	100363	2019.06.13	2020.06.12
17	D.C. Power Supply	LongWei	TPR-6405D	\	\	\
18	Software	Frad	EZ-EMC	FA-03A2 RE	\	\



Conduction Test equipment

Item	Equipment	Manufacturer	Type No.	Serial No.	Last calibration	Calibrated until
1	Test Receiver	R&S	ESR3	102075	2019.06.13	2020.06.12
2	LISN	SCHWARZBEC K	NSLK8127	8127739	2019.06.13	2020.06.12
3	LISN	R&S	ENV216	101375	2019.06.13	2020.06.12
4	RF cables	Huber+Suhnar	9kHz-30MHz	B1702988-00 08	2019.06.25	2020.06.24
5	Software	Frad	EZ-EMC	EMC-CON 3A1	\	\



### 3. EMC EMISSION TEST

#### 3.1 CONDUCTED EMISSION MEASUREMENT

##### 3.1.1 POWER LINE CONDUCTED EMISSION Limits (Frequency Range 150KHz-30MHz)

FREQUENCY (MHz)	Class B (dBuV)		Standard
	Quasi-peak	Average	
0.15 -0.5	66 - 56 *	56 - 46 *	CISPR
0.50 -5.0	56.00	46.00	CISPR
5.0 -30.0	60.00	50.00	CISPR

0.15 -0.5	66 - 56 *	56 - 46 *	FCC/ RSS-247
0.50 -5.0	56.00	46.00	FCC/ RSS-247
5.0 -30.0	60.00	50.00	FCC/ RSS-247

Note:

- (1) The tighter limit applies at the band edges.
- (2) The limit of " \* " marked band means the limitation decreases linearly with the logarithm of the frequency in the range.

The following table is the setting of the receiver

Receiver Parameters	Setting
Attenuation	10 dB
Start Frequency	0.15 MHz
Stop Frequency	30 MHz
IF Bandwidth	9 kHz

### 3.1.2 TEST PROCEDURE

- a. The EUT was placed 0.8 meters from the horizontal ground plane with EUT being connected to the power mains through a line impedance stabilization network (LISN). All other support equipments powered from additional LISN(s). The LISN provide 50 Ohm/ 50uH of coupling impedance for the measuring instrument.
- b. Interconnecting cables that hang closer than 40 cm to the ground plane shall be folded back and forth in the center forming a bundle 30 to 40 cm long.
- c. I/O cables that are not connected to a peripheral shall be bundled in the center. The end of the cable may be terminated, if required, using the correct terminating impedance. The overall length shall not exceed 1 m.
- d. LISN at least 80 cm from nearest part of EUT chassis.
- e. For the actual test configuration, please refer to the related Item –EUT Test Photos.

### 3.1.3 DEVIATION FROM TEST STANDARD

No deviation

### 3.1.4 TEST SETUP

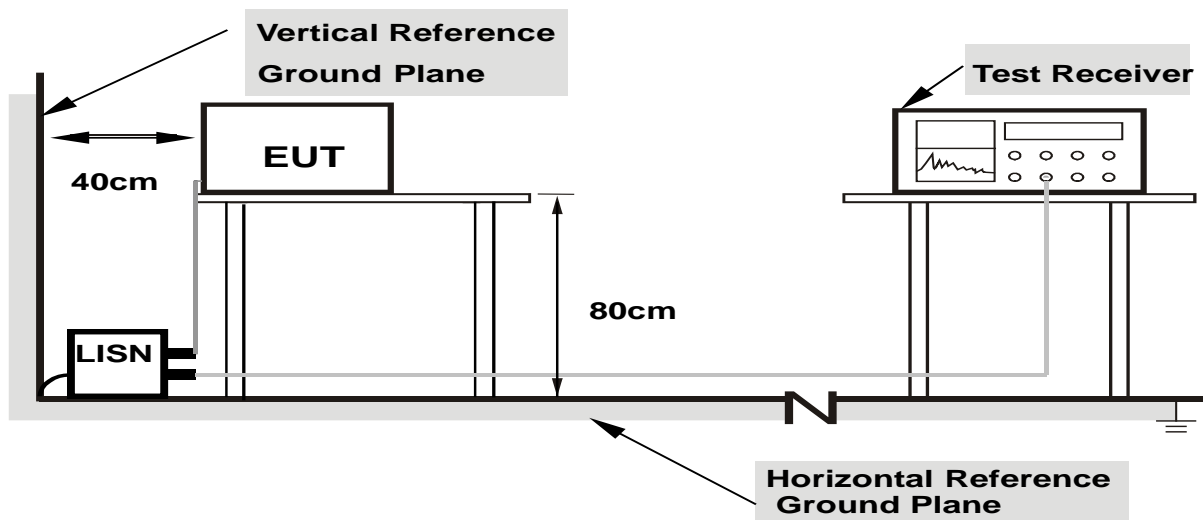

**Note: 1.Support units were connected to second LISN.**

**2.Both of LISNs (AMN) are 80 cm from EUT and at least 80 from other units and other metal planes**

### 3.1.5 EUT OPERATING CONDITIONS

The EUT was configured for testing in a typical fashion (as a customer would normally use it). The EUT has been programmed to continuously transmit during test. This operating condition was tested and used to collect the included data.



Temperature :	26 °C	Relative Humidity :	54%
Pressure :	101kPa	Phase :	L
Test Voltage :	AC 120V/60Hz	Test Mode :	Mode 4

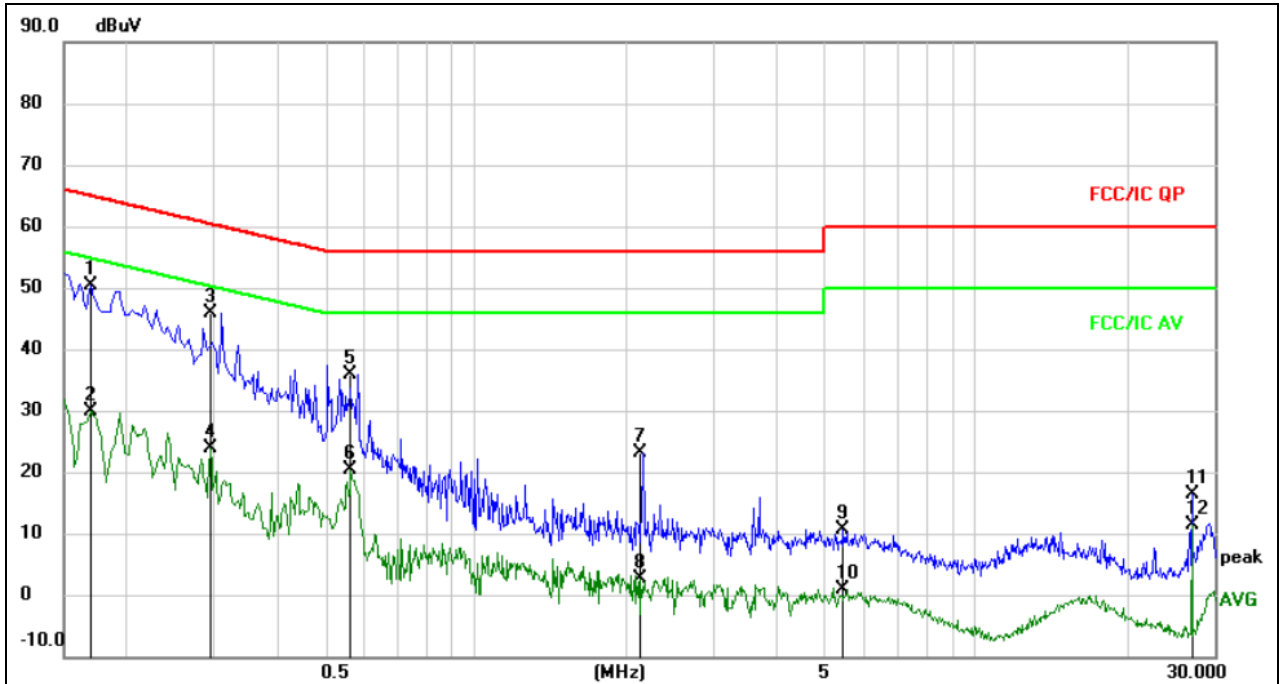

Remark:

1. All readings are Quasi-Peak and Average values.
2. Factor = Insertion Loss + Cable Loss.

No.	Mk.	Freq. MHz	Reading Level dBuV	Correct Factor	Measure- ment dBuV	Limit dBuV	Over dB	Detector	Comment
1	*	0.1700	40.84	9.50	50.34	64.96	-14.62	QP	
2		0.1700	20.42	9.50	29.92	54.96	-25.04	AVG	
3		0.2940	36.22	9.57	45.79	60.41	-14.62	QP	
4		0.2940	14.29	9.57	23.86	50.41	-26.55	AVG	
5		0.5620	25.95	9.84	35.79	56.00	-20.21	QP	
6		0.5620	10.42	9.84	20.26	46.00	-25.74	AVG	
7		2.1380	13.58	9.60	23.18	56.00	-32.82	QP	
8		2.1380	-7.04	9.60	2.56	46.00	-43.44	AVG	
9		5.4340	0.96	9.78	10.74	60.00	-49.26	QP	
10		5.4340	-8.95	9.78	0.83	50.00	-49.17	AVG	
11		27.0020	6.57	9.73	16.30	60.00	-43.70	QP	
12		27.0020	1.55	9.73	11.28	50.00	-38.72	AVG	





Temperature :	26 °C	Relative Humidity :	54%
Pressure :	101kPa	Phase :	N
Test Voltage :	AC 120V/60Hz	Test Mode :	Mode 4

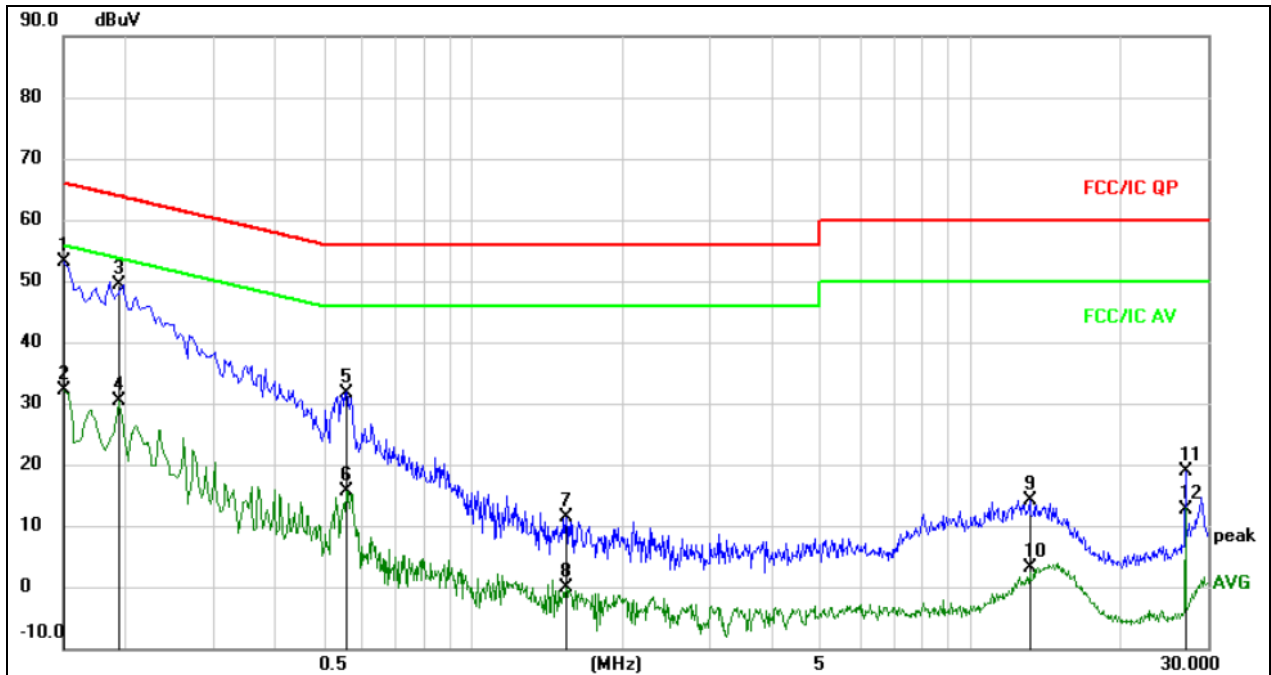

Remark:

1. All readings are Quasi-Peak and Average values.
2. Factor = Insertion Loss + Cable Loss.

No.	Mk.	Freq. MHz	Reading Level dBuV	Correct Factor	Measure- ment dBuV	Limit dBuV	Over dB	Detector	Comment
1	*	0.1500	43.68	9.52	53.20	66.00	-12.80	QP	
2		0.1500	22.65	9.52	32.17	56.00	-23.83	AVG	
3		0.1940	39.96	9.47	49.43	63.86	-14.43	QP	
4		0.1940	20.96	9.47	30.43	53.86	-23.43	AVG	
5		0.5580	21.92	9.83	31.75	56.00	-24.25	QP	
6		0.5580	5.78	9.83	15.61	46.00	-30.39	AVG	
7		1.5380	1.77	9.58	11.35	56.00	-44.65	QP	
8		1.5380	-9.76	9.58	-0.18	46.00	-46.18	AVG	
9		13.1380	4.33	9.70	14.03	60.00	-45.97	QP	
10		13.1380	-6.62	9.70	3.08	50.00	-46.92	AVG	
11		26.9980	9.25	9.73	18.98	60.00	-41.02	QP	
12		26.9980	3.02	9.73	12.75	50.00	-37.25	AVG	



### 3.2 RADIATED EMISSION MEASUREMENT

#### 3.2.1 APPLICABLE STANDARD

According to FCC Part 15.407(d) and 15.209

#### 3.2.2 CONFORMANCE LIMIT

According to FCC Part 15.407(b)(7): radiated emissions which fall in the restricted bands, as defined in §15.205(a), must also comply with the radiated emission limits specified in §15.209(a) (see §15.205(c)).  
According to FCC Part 15.205, Restricted bands

MHz	MHz	MHz	GHz
0.090-0.110	16.42-16.423	399.9-410	4.5-5.15
10.495-0.505	16.69475-16.69525	608-614	5.35-5.46
2.1735-2.1905	16.80425-16.80475	960-1240	7.25-7.75
4.125-4.128	25.5-25.67	1300-1427	8.025-8.5
4.17725-4.17775	37.5-38.25	1435-1626.5	9.0-9.2
4.20725-4.20775	73-74.6	1645.5-1646.5	9.3-9.5
6.215-6.218	74.8-75.2	1660-1710	10.6-12.7
6.26775-6.26825	123-138	2200-2300	14.47-14.5
8.291-8.294	149.9-150.05	2310-2390	15.35-16.2
8.362-8.366	156.52475-156.52525	2483.5-2500	17.7-21.4
8.37625-8.38675	156.7-156.9	2690-2900	22.01-23.12
8.41425-8.41475	162.0125-167.17	3260-3267	23.6-24.0
12.29-12.293	167.72-173.2	3332-3339	31.2-31.8
12.51975-12.52025	240-285	3345.8-3358	36.43-36.5
12.57675-12.57725	322-335.4	3600-4400	(2)
13.36-13.41			

20dBc in any 100 kHz bandwidth outside the operating frequency band. In case the emission fall within the restricted band specified on 15.205(a), then the 15.209(a) limit in the table below has to be followed.

Restricted Frequency(MHz)	Field Strength (µV/m)	Field Strength (dBµV/m)	Measurement Distance
0.009~0.490	2400/F(KHz)	20 log (uV/m)	300
0.490~1.705	2400/F(KHz)	20 log (uV/m)	30
1.705~30.0	30	29.5	30
30-88	100	40	3
88-216	150	43.5	3
216-960	200	46	3
Above 960	500	54	3

#### Limits of Radiated Emission Measurement(Above 1000MHz)

Frequency(MHz)	Class B (dBuV/m) (at 3M)	
	PEAK	AVERAGE
Above 1000	74	54

Remark :1. Emission level in dBuV/m=20 log (uV/m)

2. Measurement was performed at an antenna to the closed point of EUT distance of meters.

3. Distance extrapolation factor =40log(Specific distance/ test distance)( dB);

Limit line=Specific limits(dBuV) + distance extrapolation factor.

#### 3.2.3 MEASURING INSTRUMENTS

The Measuring equipment is listed in the section 6.3 of this test report.

### 3.2.4 TEST CONFIGURATION

(a) For radiated emissions below 30MHz

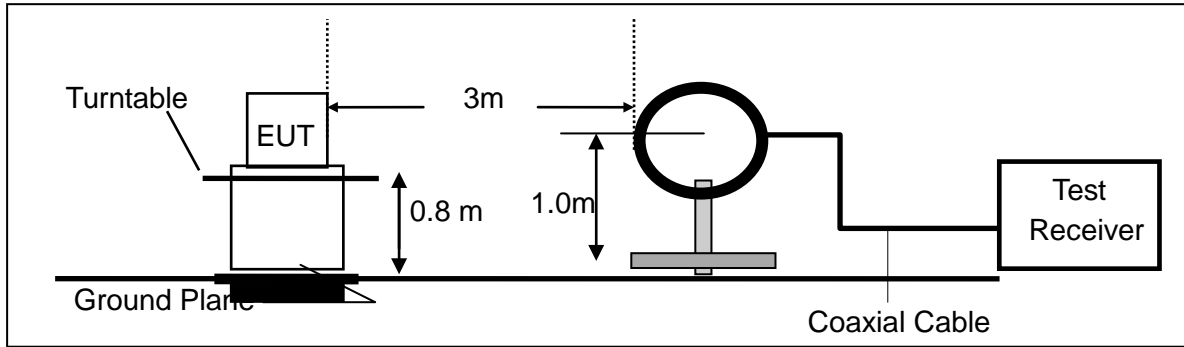

(b) For radiated emissions from 30MHz to 1000MHz

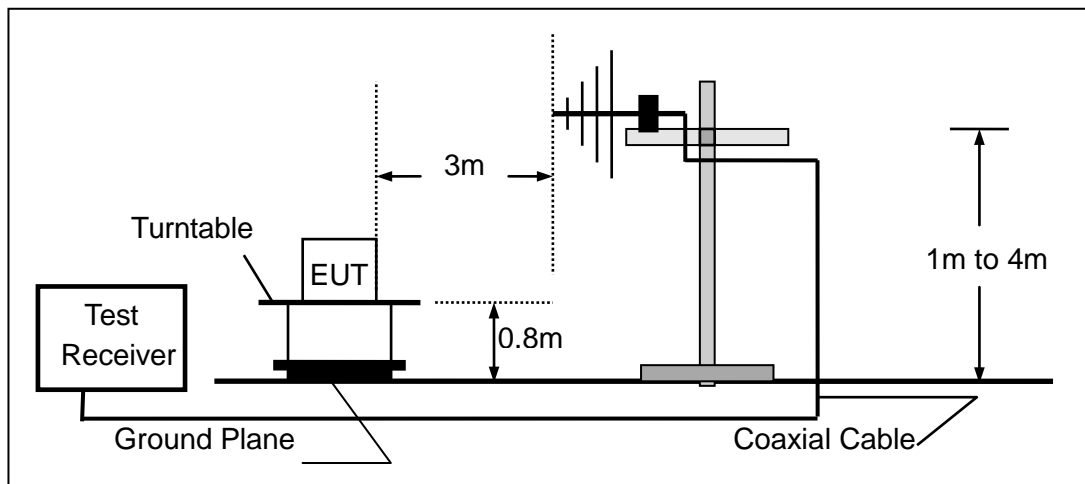

(c) For radiated emissions above 1000MHz

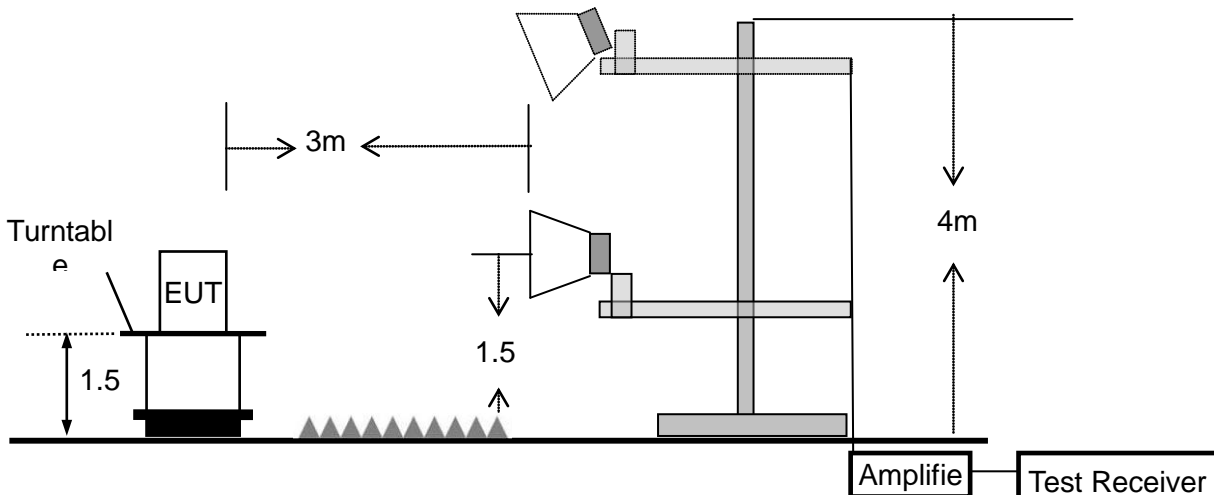



### 3.2.5 TEST PROCEDURE

The test site semi-anechoic chamber has met the requirement of NSA tolerance 4 dB according to the standards: ANSI C63.10-2013. The test distance is 3m. The setup is according to the requirements in Section 13.1.4.1 of ANSI C63.10-2013 and CAN/CSA-CEI/IEC CISPR 22.

This test is required for any spurious emission that falls in a Restricted Band, as defined in Section 15.205. It must be performed with the highest gain of each type of antenna proposed for use with the EUT.

Use the following spectrum analyzer settings:

Spectrum Parameter	Setting
Attenuation	Auto
Start Frequency	1000 MHz
Stop Frequency	10th carrier harmonic
RB / VB (emission in restricted band)	1 MHz / 1 MHz for Peak, 1 MHz / 10Hz for Average

Receiver Parameter	Setting
Attenuation	Auto
Start ~ Stop Frequency	9kHz~150kHz / RB 200Hz for QP
Start ~ Stop Frequency	150kHz~30MHz / RB 9kHz for QP
Start ~ Stop Frequency	30MHz~1000MHz / RB 120kHz for QP

- The measuring distance of at 3 m shall be used for measurements at frequency up to 1GHz. For frequencies above 1GHz, any suitable measuring distance may be used.
- The EUT was placed on the top of a rotating table 0.8 m for below 1GHz and 1.5m for above 1GHz the ground at a 3 meter. The table was rotated 360 degrees to determine the position of the highest radiation.
- The height of the equipment or of the substitution antenna shall be 0.8 m for below 1GHz and 1.5m for above 1GHz; the height of the test antenna shall vary between 1 m to 4 m. Both horizontal and vertical polarizations of the antenna are set to make the measurement.
- The initial step in collecting conducted emission data is a spectrum analyzer peak detector mode pre-scanning the measurement frequency range. Significant peaks are then marked and then Quasi Peak detector mode re-measured.
- If the Peak Mode measured value compliance with and lower than Quasi Peak Mode Limit, the EUT shall be deemed to meet QP Limits and then no additional QP Mode measurement performed.
- For the actual test configuration, please refer to the related Item –EUT Test Photos.

Note:

Both horizontal and vertical antenna polarities were tested and performed pretest to three orthogonal axis. The worst case emissions were reported

During the radiated emission test, the Spectrum Analyzer was set with the following configurations:

Frequency Band (MHz)	Function	Resolution bandwidth	Video Bandwidth
30 to 1000	QP	120 kHz	300 kHz
Above 1000	Peak	1 MHz	1 MHz
	Average	3 MHz	10 Hz

Note: for the frequency ranges below 30 MHz, a narrower RBW is used for these ranges but the measured value should add a RBW correction factor (RBWCF) where  $RBWCF [dB] = 10 * \lg(100 [kHz] / \text{narrower RBW [kHz]})$ . , the narrower RBW is 1 kHz and RBWCF is 20 dB for the frequency 9 kHz to 150 kHz, and the narrower RBW is 10 kHz and RBWCF is 10 dB for the frequency 150 kHz to 30 MHz.



**3.2.6 TEST RESULTS (9KHZ – 30 MHZ)**

Temperature:	26℃	Relative Humidity:	54%
Pressure:	101 kPa	Test Voltage :	AC 120V/60Hz
Test Mode :	Mode 4	Polarization :	--

Freq.	Reading	Limit	Margin	State
(MHz)	(dBuV/m)	(dBuV/m)	(dB)	P/F
--	--	--	--	N/A
--	--	--	--	N/A

**NOTE:**

The amplitude of spurious emissions which are attenuated by more than 20dB below the permissible value has no need to be reported.

Distance extrapolation factor =  $40 \log (\text{specific distance}/\text{test distance})(\text{dB})$ ;

Limit line = specific limits(dBuv) + distance extrapolation factor.



3.2.7 TEST RESULTS (30MHZ – 1GHZ)

Temperature :	26°C	Relative Humidity :	54%
Pressure :	101 kPa	Test Voltage :	AC 120V/60Hz
Test Mode :	Mode 4		

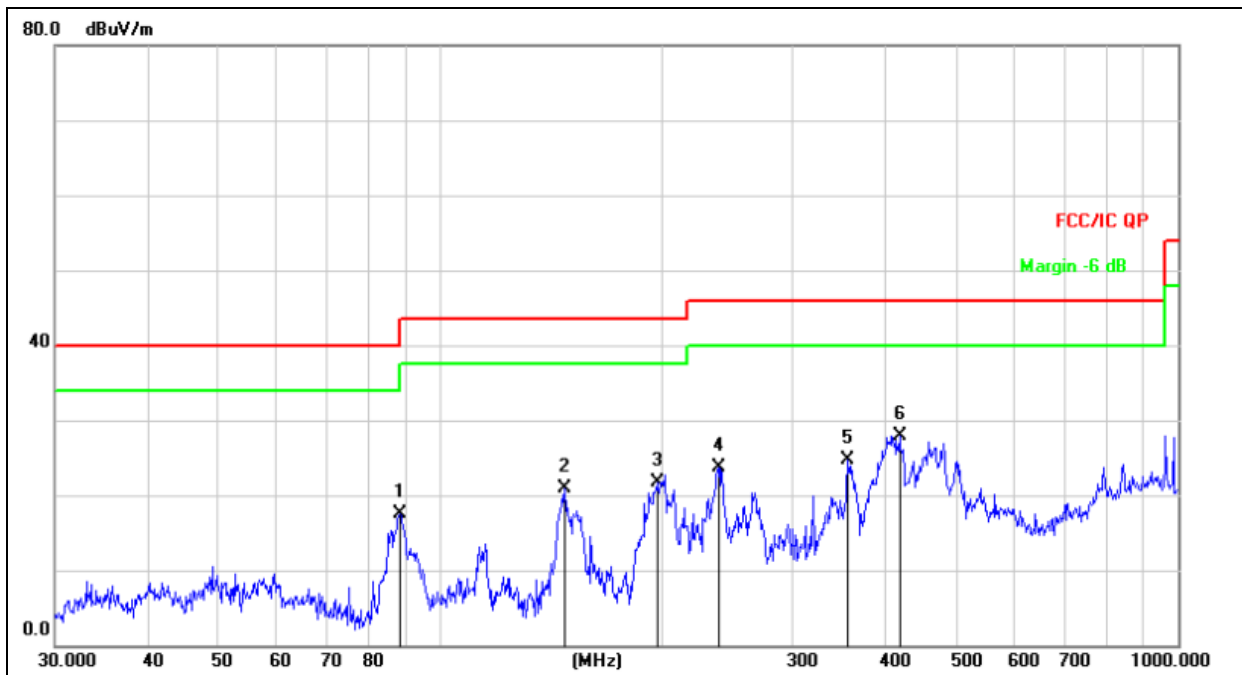

Remark:  
Factor = Antenna Factor + Cable Loss – Pre-amplifier.

No.	Mk.	Freq. MHz	Reading Level dBuV	Correct Factor dB	Measure- ment dBuV/m	Limit dB/m	Over dB	Detector
1		88.0329	36.08	-18.55	17.53	43.50	-25.97	QP
2		147.4036	40.25	-19.33	20.92	43.50	-22.58	QP
3		196.5098	38.24	-16.52	21.72	43.50	-21.78	QP
4		238.3102	39.15	-15.42	23.73	46.00	-22.27	QP
5		356.6758	36.87	-12.08	24.79	46.00	-21.21	QP
6	*	419.1081	38.64	-10.66	27.98	46.00	-18.02	QP



Temperature :	26°C	Relative Humidity :	54%
Pressure :	101kPa	Polarization :	Vertical
Test Voltage :	AC 120V/60Hz		
Test Mode :	Mode 4		

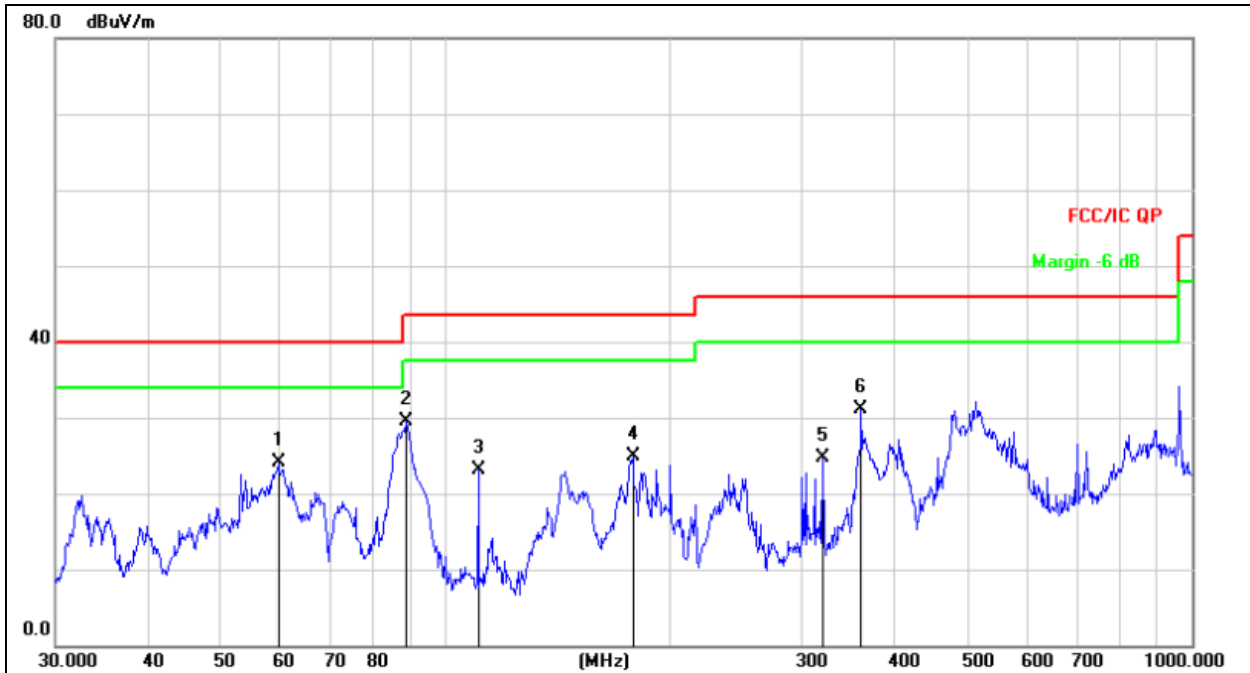

Remark:  
Factor = Antenna Factor + Cable Loss – Pre-amplifier.

No.	Mk.	Freq. MHz	Reading Level dBuV	Correct Factor dB	Measure- ment dBuV/m	Limit dB/m	Over dB	Detector
1		59.6493	39.94	-15.87	24.07	40.00	-15.93	QP
2	*	88.3421	47.90	-18.48	29.42	43.50	-14.08	QP
3		110.5687	40.01	-16.96	23.05	43.50	-20.45	QP
4		178.1327	42.63	-17.70	24.93	43.50	-18.57	QP
5		319.9370	37.69	-13.05	24.64	46.00	-21.36	QP
6		360.4476	43.06	-11.99	31.07	46.00	-14.93	QP



**3.2.8 TEST RESULTS (1GHz-40GHz)**

Test Mode :	TX(5.2G) - 802.11a
-------------	--------------------

Polar	Frequency	Meter Reading	Cable loss	Antenna Factor	Preamp Factor	Emission Level	Limits	Margin	Detector Type
(H/V)	(MHz)	(dBuV)	(dB)	dB/m	(dB)	(dBuV/m)	(dBuV/m)	(dB)	
Low Channel (5180 MHz)-Above 1G									
Vertical	4434.157	62.24	5.94	35.40	44.00	59.58	74.00	-14.42	Pk
Vertical	4434.157	46.52	5.94	35.40	44.00	43.86	54.00	-10.14	AV
Vertical	10370.362	60.41	8.46	39.75	44.50	64.12	74.00	-9.88	Pk
Vertical	10370.362	42.94	8.46	39.75	44.50	46.65	54.00	-7.35	AV
Vertical	15540.196	61.45	10.12	38.80	44.10	66.27	74.00	-7.73	Pk
Vertical	15540.196	37.51	10.12	38.80	42.70	43.73	54.00	-10.27	AV
Horizontal	4434.521	66.55	5.94	35.18	44.00	63.67	74.00	-10.33	Pk
Horizontal	4434.521	44.11	5.94	35.18	44.00	41.23	54.00	-12.77	AV
Horizontal	10370.623	58.94	8.46	38.71	44.50	61.61	74.00	-12.39	Pk
Horizontal	10370.623	41.02	8.46	38.71	44.50	43.69	54.00	-10.31	AV
Horizontal	10540.865	56.96	10.12	38.38	44.10	61.36	74.00	-12.64	Pk
Horizontal	10540.865	38.81	10.12	38.38	44.10	43.21	54.00	-10.79	AV
middle Channel (5200 MHz)-Above 1G									
Vertical	4592.093	60.22	6.48	36.35	44.05	59	74.00	-15	Pk
Vertical	4592.093	41.91	6.48	36.35	44.05	40.69	54.00	-13.31	AV
Vertical	10401.424	59.64	8.47	37.88	44.51	61.48	74.00	-12.52	Pk
Vertical	10401.424	42.72	8.47	37.88	44.51	44.56	54.00	-9.44	AV
Vertical	15600.218	56.53	10.12	38.8	44.10	61.35	74.00	-12.65	Pk
Vertical	15600.218	36.61	10.12	38.8	42.70	42.83	54.00	-11.17	AV
Horizontal	4592.691	59.82	6.48	36.37	44.05	58.62	74.00	-15.38	Pk
Horizontal	4592.691	43.11	6.48	36.37	44.05	41.91	54.00	-12.09	AV
Horizontal	10400.114	58.82	8.47	38.64	44.50	61.43	74.00	-12.57	Pk
Horizontal	10400.114	42.21	8.47	38.64	44.50	44.82	54.00	-9.18	AV
Horizontal	15600.187	59.83	10.12	38.38	44.10	64.23	74.00	-9.77	Pk
Horizontal	15600.187	38.72	10.12	38.38	44.10	43.12	54.00	-10.88	AV
High Channel (5240 MHz)-Above 1G									
Vertical	4739.246	61.24	7.10	37.24	43.50	62.08	74.00	-11.92	Pk
Vertical	4739.246	44.46	7.10	37.24	43.50	45.3	54.00	-8.7	AV
Vertical	10480.371	60.53	8.46	37.68	44.50	62.17	74.00	-11.83	Pk
Vertical	10480.371	40.35	8.46	37.68	44.50	41.99	54.00	-12.01	AV
Vertical	15720.359	61.76	10.12	38.8	44.10	66.58	74.00	-7.42	Pk
Vertical	15720.359	39.64	10.12	38.8	42.70	45.86	54.00	-8.14	AV
Horizontal	4739.352	62.22	7.10	37.24	43.50	63.06	74.00	-10.94	Pk
Horizontal	4739.352	43.27	7.10	37.24	43.50	44.11	54.00	-9.89	AV
Horizontal	10481.111	62.53	8.46	38.57	44.50	65.06	74.00	-8.94	Pk
Horizontal	10481.111	43.36	8.46	38.57	44.50	45.89	54.00	-8.11	AV
Horizontal	15720.357	60.74	10.12	38.38	44.10	65.14	74.00	-8.86	Pk
Horizontal	15720.357	42.26	10.12	38.38	44.10	46.66	54.00	-7.34	AV

Note:"802.11n(5G)" mode is the worst mode. PK value is lower than the Average value limit, So average didn't record.  
 The amplitude of spurious emissions that are attenuated by more than 20dB below the permissible value has no need to be reported.  
 Emission level (dBuV/m) = 20 log Emission level (uV/m).  
 Corrected Reading: Antenna Factor + Cable Loss + Read Level - Preamp Factor = Level.





Test Mode :	TX (5.8G) -- 802.11a
-------------	----------------------

Polar	Frequency	Meter Reading	Cable loss	Antenna Factor	Preamp Factor	Emission Level	Limits	Margin	Detector Type
(H/V)	(MHz)	(dBuV)	(dB)	dB/m	(dB)	(dBuV/m)	(dBuV/m)	(dB)	
Low Channel (5745 MHz)-Above 1G									
Vertical	4679.195	59.95	5.94	35.40	44.00	57.29	74.00	-16.71	Pk
Vertical	4679.195	39.63	5.94	35.40	44.00	36.97	54.00	-17.03	AV
Vertical	11490.364	59.55	8.46	39.75	44.50	63.26	74.00	-10.74	Pk
Vertical	11490.364	42.13	8.46	39.75	44.50	45.84	54.00	-8.16	AV
Vertical	17235.101	55.55	10.12	38.80	44.10	60.37	74.00	-13.63	Pk
Vertical	17235.101	38.63	10.12	38.80	42.70	44.85	54.00	-9.15	AV
Horizontal	4679.332	57.95	5.94	35.18	44.00	55.07	74.00	-18.93	Pk
Horizontal	4679.332	44.53	5.94	35.18	44.00	41.65	54.00	-12.35	AV
Horizontal	11490.164	56.64	8.46	38.71	44.50	59.31	74.00	-14.69	Pk
Horizontal	11490.164	40.13	8.46	38.71	44.50	42.8	54.00	-11.2	AV
Horizontal	17235.196	58.65	10.12	38.38	44.10	63.05	74.00	-10.95	Pk
Horizontal	17235.196	42.21	10.12	38.38	44.10	46.61	54.00	-7.39	AV
middle Channel (5785 MHz)-Above 1G									
Vertical	4592.228	59.85	6.48	36.35	44.05	58.63	74.00	-15.37	Pk
Vertical	4592.228	43.33	6.48	36.35	44.05	42.11	54.00	-11.89	AV
Vertical	11570.203	61.14	8.47	37.88	44.51	62.98	74.00	-11.02	Pk
Vertical	11570.203	43.22	8.47	37.88	44.51	45.06	54.00	-8.94	AV
Vertical	17355.147	61.19	10.12	38.8	44.10	66.01	74.00	-7.99	Pk
Vertical	17355.147	44.21	10.12	38.8	42.70	50.43	54.00	-3.57	AV
Horizontal	4592.526	52.62	6.48	36.37	44.05	51.42	74.00	-22.58	Pk
Horizontal	4592.526	46.32	6.48	36.37	44.05	45.12	54.00	-8.88	AV
Horizontal	11570.123	64.04	8.47	38.64	44.50	66.65	74.00	-7.35	Pk
Horizontal	11570.123	45.22	8.47	38.64	44.50	47.83	54.00	-6.17	AV
Horizontal	17355.269	53.52	10.12	38.38	44.10	57.92	74.00	-16.08	Pk
Horizontal	17355.269	41.23	10.12	38.38	44.10	45.63	54.00	-8.37	AV
High Channel (5825 MHz)-Above 1G									
Vertical	6039.199	55.61	7.10	37.24	43.50	56.45	74.00	-17.55	Pk
Vertical	6039.199	43.24	7.10	37.24	43.50	44.08	54.00	-9.92	AV
Vertical	11652.562	52.95	8.46	37.68	44.50	54.59	74.00	-19.41	Pk
Vertical	11652.562	43.11	8.46	37.68	44.50	44.75	54.00	-9.25	AV
Vertical	17473.128	54.52	10.12	38.8	44.10	59.34	74.00	-14.66	Pk
Vertical	17473.128	45.32	10.12	38.8	42.70	51.54	54.00	-2.46	AV
Horizontal	6039.232	55.91	7.10	37.24	43.50	56.75	74.00	-17.25	Pk
Horizontal	6039.232	43.33	7.10	37.24	43.50	44.17	54.00	-9.83	AV
Horizontal	11652.319	52.26	8.46	38.57	44.50	54.79	74.00	-19.21	Pk
Horizontal	11652.319	40.12	8.46	38.57	44.50	42.65	54.00	-11.35	AV
Horizontal	17474.062	57.77	10.12	38.38	44.10	62.17	74.00	-11.83	Pk
Horizontal	17474.062	40.33	10.12	38.38	44.10	44.73	54.00	-9.27	AV

Note:"802.11a(5G)" mode is the worst mode. PK value is lower than the Average value limit, So average didn't record.

The amplitude of spurious emissions that are attenuated by more than 20dB below the permissible value has no need to be reported.

Emission level (dBuV/m) = 20 log Emission level (uV/m).

Corrected Reading: Antenna Factor + Cable Loss + Read Level - Preamp Factor = Level.



## 4. POWER SPECTRAL DENSITY TEST

### 4.1 APPLIED PROCEDURES / LIMIT

#### According to FCC §15.407(a)(3)

For the band 5.15-5.25 GHz,

(i) For an outdoor access point operating in the band 5.15-5.25 GHz, the maximum power spectral density shall not exceed 17 dBm in any 1 megahertz band. If transmitting antennas of directional gain greater than 6 dBi are used, both the maximum conducted output power and the maximum power spectral density shall be reduced by the amount in dB that the directional gain of the antenna exceeds 6 dBi. The maximum e.i.r.p. at any elevation angle above 30 degrees as measured from the horizon must not exceed 125 mW (21 dBm).

(ii) For an indoor access point operating in the band 5.15-5.25 GHz, the maximum power spectral density shall not exceed 17 dBm in any 1 megahertz band. If transmitting antennas of directional gain greater than 6 dBi are used, both the maximum conducted output power and the maximum power spectral density shall be reduced by the amount in dB that the directional gain of the antenna exceeds 6 dBi.

(iii) For fixed point-to-point access points operating in the band 5.15-5.25 GHz, the maximum power spectral density shall not exceed 17 dBm in any 1 megahertz band. Fixed point-to-point U-NII devices may employ antennas with directional gain up to 23 dBi without any corresponding reduction in the maximum conducted output power or maximum power spectral density. For fixed point-to-point transmitters that employ a directional antenna gain greater than 23 dBi, a 1 dB reduction in maximum conducted output power and maximum power spectral density is required for each 1 dB of antenna gain in excess of 23 dBi. Fixed, point-to-point operations exclude the use of point-to-multipoint systems, omnidirectional applications, and multiple collocated transmitters transmitting the same information. The operator of the U-NII device, or if the equipment is professionally installed, the installer, is responsible for ensuring that systems employing high gain directional antennas are used exclusively for fixed, point-to-point operations.

(iv) For client devices in the 5.15-5.25 GHz band, the maximum power spectral density shall not exceed 11 dBm in any 1 megahertz band. If transmitting antennas of directional gain greater than 6 dBi are used, both the maximum conducted output power and the maximum power spectral density shall be reduced by the amount in dB that the directional gain of the antenna exceeds 6 dBi.

For the band 5.725-5.85 GHz

(3) For the band 5.725-5.85 GHz, the maximum power spectral density shall not exceed 30 dBm in any 500-kHz band. If transmitting antennas of directional gain greater than 6 dBi are used, both the maximum conducted output power and the maximum power spectral density shall be reduced by the amount in dB that the directional gain of the antenna exceeds 6 dBi.

,

## 4.2 TEST PROCEDURE

For devices operating in the bands 5.15-5.25 GHz, 5.25-5.35 GHz, and 5.47-5.725 GHz, the above procedures make use of 1 MHz RBW to satisfy directly the 1 MHz reference bandwidth specified in § 15.407(a)(5). For devices operating in the band 5.725-5.85 GHz, the rules specify a measurement bandwidth of 500 kHz. Many spectrum analyzers do not have 500 kHz RBW, thus a narrower RBW may need to be used. The rules permit the use of a RBWs less than 1 MHz, or 500 kHz, “provided that the measured power is integrated over the full reference bandwidth” to show the total power over the specified measurement bandwidth (i.e., 1 MHz, or 500 kHz). If measurements are performed using a reduced resolution bandwidth (< 1 MHz, or < 500 kHz) and integrated over 1 MHz, or 500 KHz bandwidth, the following adjustments to the procedures apply:

- a) Set  $RBW \geq 1/T$ , where T is defined in section II.B.I.a).
- b) Set  $VBW \geq 3 RBW$ .
- c) If measurement bandwidth of Maximum PSD is specified in 500 kHz, add  $10\log(500\text{kHz}/RBW)$  to the measured result, whereas RBW (< 500 KHz) is the reduced resolution bandwidth of the spectrum analyzer set during measurement.
- d) If measurement bandwidth of Maximum PSD is specified in 1 MHz, add  $10\log(1\text{MHz}/RBW)$  to the measured result, whereas RBW (< 1 MHz) is the reduced resolution bandwidth of spectrum analyzer set during measurement.
- e) Care must be taken to ensure that the measurements are performed during a period of continuous transmission or are corrected upward for duty cycle.

Note: As a practical matter, it is recommended to use reduced RBW of 100 KHz for the sections 5.c) and 5.d) above, since RBW=100 KHZ is available on nearly all spectrum analyzers.

## 4.3 DEVIATION FROM STANDARD

No deviation.

## 4.4 TEST SETUP



## 4.5 EUT OPERATION CONDITIONS

The EUT tested system was configured as the statements of 2.1 Unless otherwise a special operating condition is specified in the follows during the testing.



**4.6 TEST RESULTS**

Temperature :	26 °C	Relative Humidity :	54%
Pressure :	101kPa	Test Voltage :	AC 120V/60Hz
Test Mode :	TX Frequency Band I, TX Frequency Band IV		

TX Frequency Band I (5150-5250MHz)					
Operating mode	Test Channel MHz	Power Spectral Density dBm/MHz			Limit (dBm/MHz)
		Chain A	Chain B	Total	
802.11a	5180	4.208	4.692	/	17
	5200	4.785	4.680	/	17
	5240	4.049	3.773	/	17
802.11n-HT20	5180	2.531	2.404	5.48	14.77
	5200	1.612	1.901	4.77	14.77
	5240	1.784	2.122	4.97	14.77
802.11n-HT40	5190	2.318	1.913	5.13	14.77
	5230	1.919	1.563	4.75	14.77

Antenna A gain: 5.05dBi, Antenna B gain: 5.38dBi, Directional gain=[10log(GA+ G B)] dbi =8.23dbi  
limit=17-(8.23-6)=14.77

Note 2: 802.11n-HT20 and 802.11n-HT40 support MIMO.



TX Frequency Band IV (5725-5850MHz)						
802.11a						
Test Channel	Power Spectral Density*					Limit dBm/500kHz
	ANT A		ANT B		Total dBm/500kHz	
	dBm/300kHz	dBm/500kHz	dBm/300kHz	dBm/500kHz		
5745	-2.541	-0.74	-2.160	-0.36	/	30
5785	-2.717	-0.91	-2.758	-0.95	/	30
5825	-1.980	-0.18	-2.366	-0.56	/	30
802.11n-HT20						
5745	-2.519	-0.71	-2.462	-0.66	2.33	27.77
5785	-3.621	-1.82	-3.301	-1.50	1.35	27.77
5825	-3.619	-1.81	-3.251	-1.45	1.38	27.77
802.11n-HT40						
5755	-3.715	-1.91	-4.258	-0.24	1.01	27.77
5795	-3.890	-2.09	-3.990	0.03	2.91	27.77

Antenna A gain: 5.05dBi, Antenna B gain: 5.38dBi, Directional gain=[10log(GA+ G B)] dbi =8.23dbi  
limit=30-(8.23-6)=27.77

Note 2: If measurement bandwidth of Maximum PSD is specified in 500 kHz, add 10 log (500 kHz/RBW) to the measured result, whereas RBW (<500 kHz) is the reduced resolution bandwidth of the spectrum analyzer set during measurement.



Antenna A: 5150-5250MHz

Mode:		802.11a
5180MHz		
5200MHz		
5240MHz		

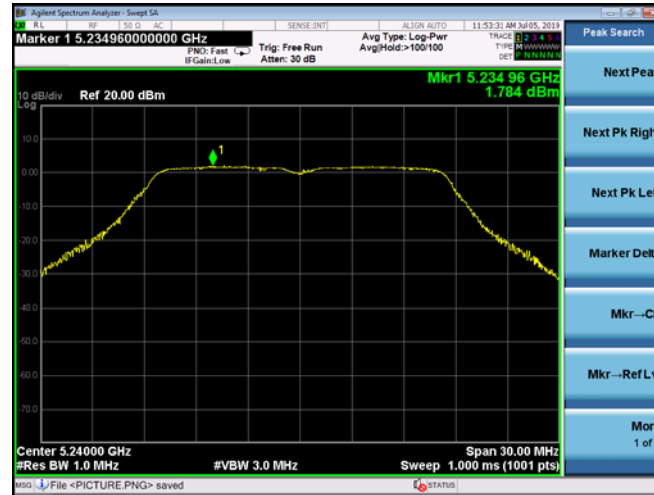

Mode:	802.11n-HT20
5180MHz	
5200MHz	
5240MHz	



Mode:	802.11n-HT40
5190 MHz	
5230 MHz	



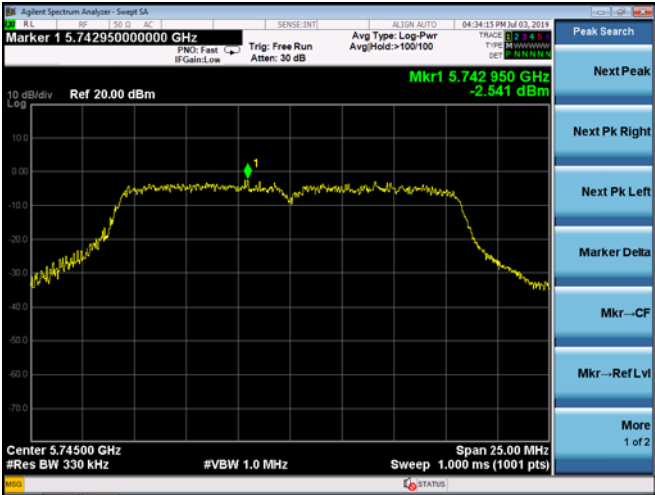
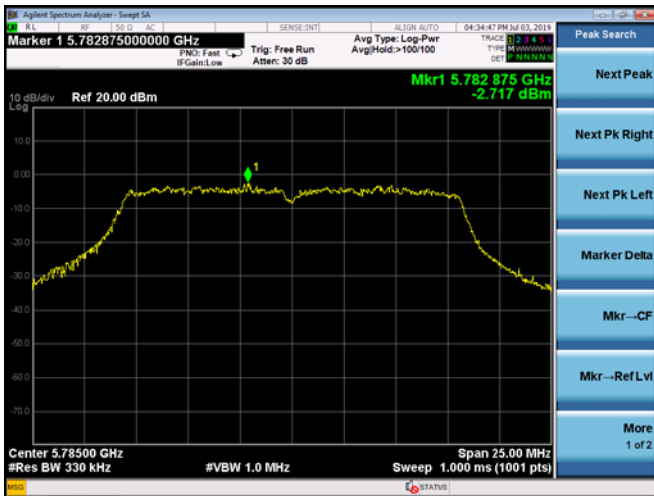
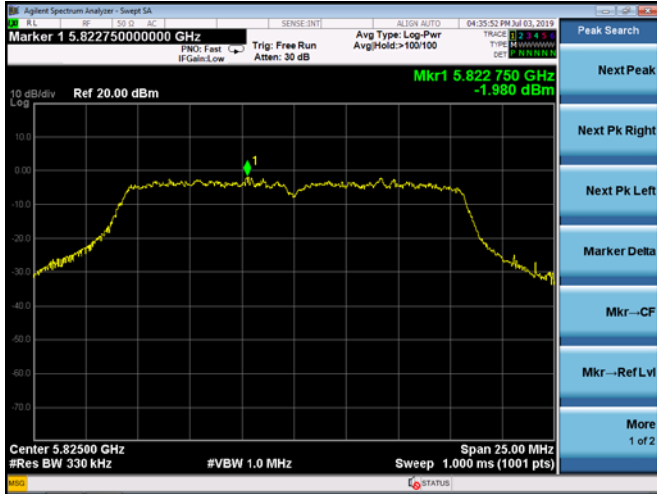

Antenna A: 5725-5850MHz

Mode:	802.11a
5745MHz	
5785MHz	
5825MHz	



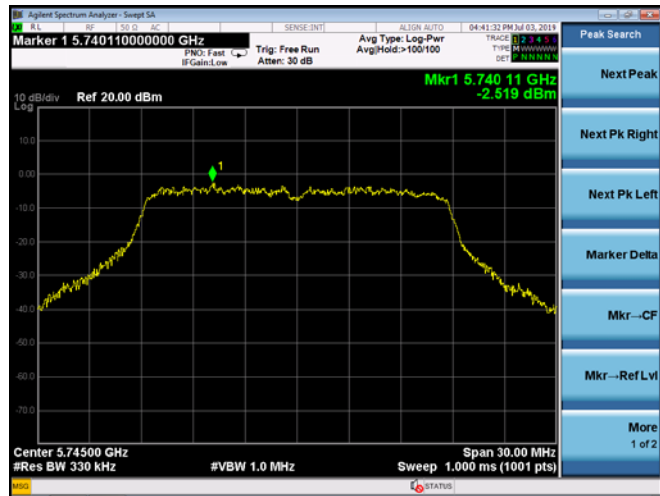
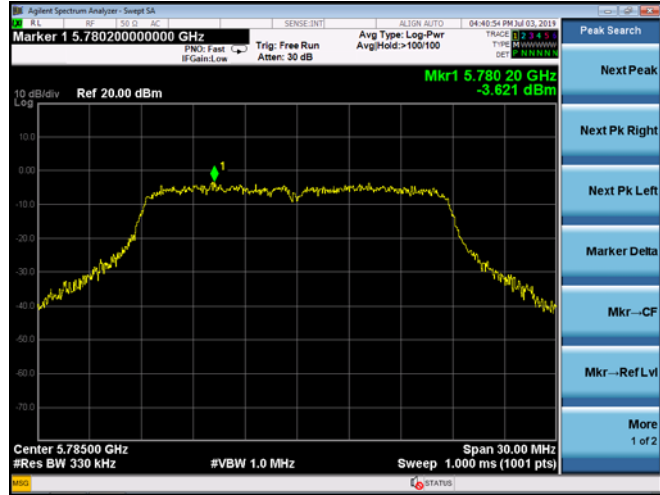
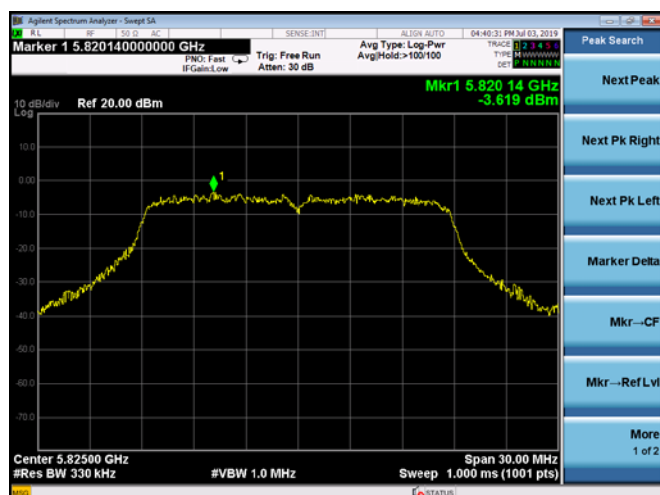

Mode:	802.11n-HT20
5745MHz	
5785MHz	
5825MHz	



Mode:		802.11n-HT40
5755MHz		
5795MHz		

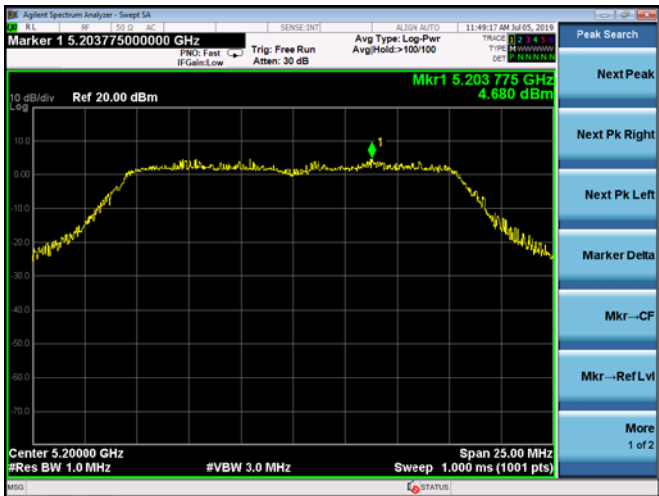

Antenna B: 5150-5250MHz

Mode:	802.11a
5180MHz	
5200MHz	
5240MHz	

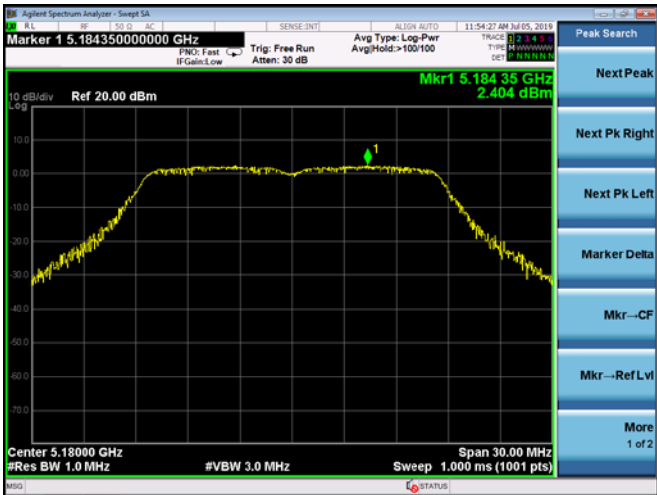
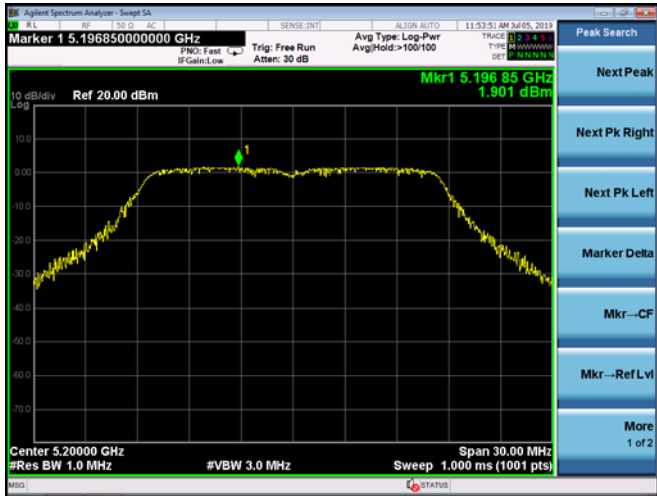
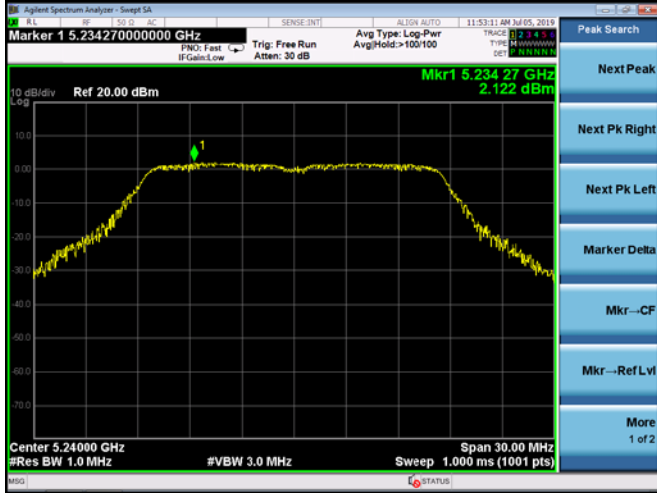

Mode:	802.11n-HT20
5180MHz	
5200MHz	
5240MHz	



Mode:	802.11n-HT40
5190 MHz	
5230 MHz	

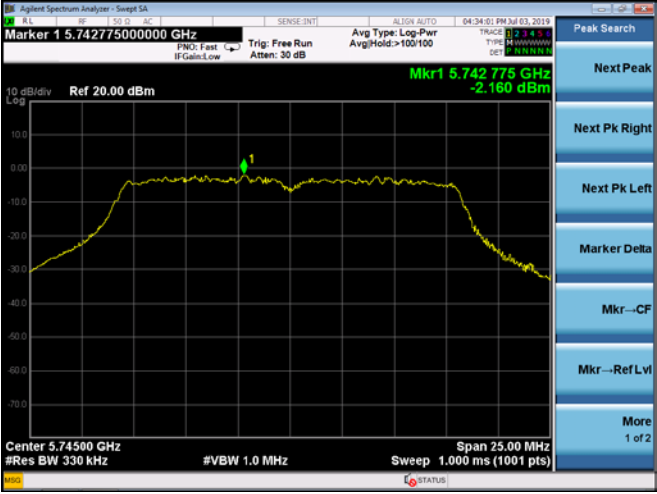
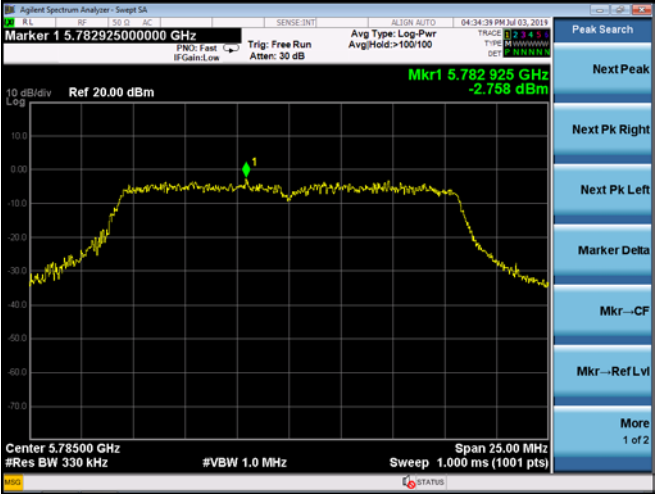
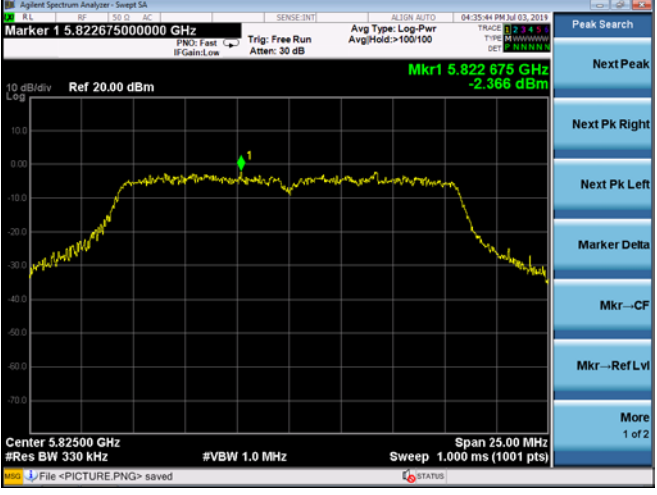

Antenna B: 5725-5850MHz

Mode:	802.11a
5745MHz	
5785MHz	
5825MHz	

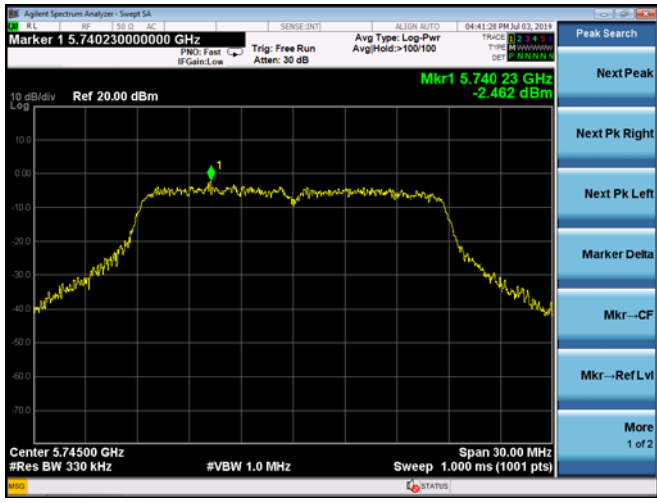
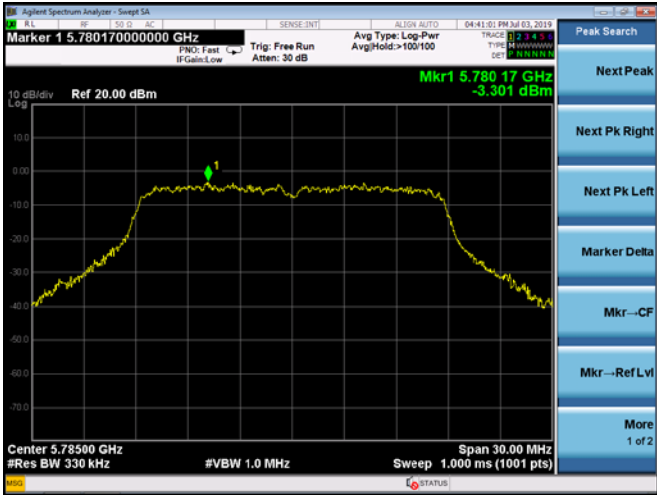
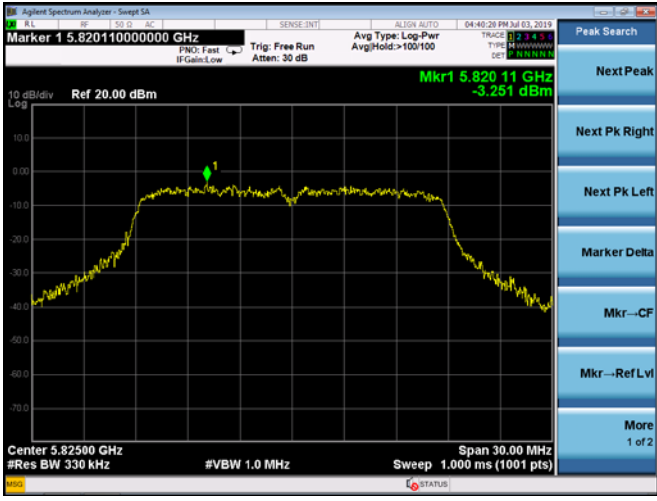

Mode:	802.11n-HT20
5745MHz	
5785MHz	
5825MHz	





Mode: 802.11n-HT40

5755MHz

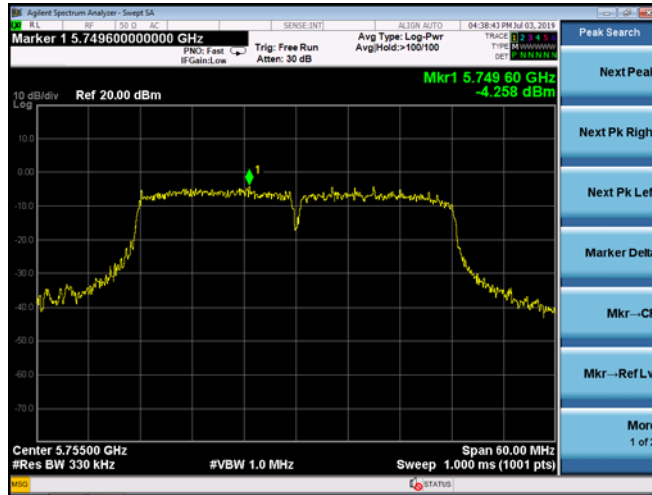

5795MHz

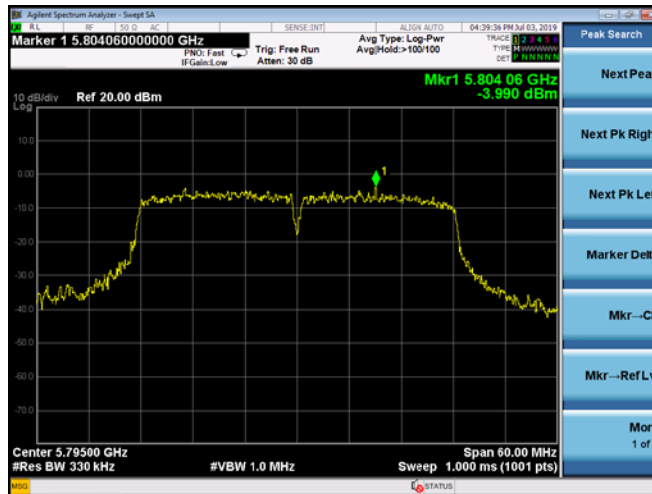

## 5. 26DB & 99% & 6DB EMISSION BANDWIDTH

### 5.1 APPLIED PROCEDURES / LIMIT

The maximum power spectral density is measured as a conducted emission by direct connection of a calibrated test instrument to the equipment under test. If the device cannot be connected directly, alternative techniques acceptable to the Commission may be used. Measurements in the 5.725-5.85 GHz band are made over a reference bandwidth of 500 kHz or the 26 dB emission bandwidth of the device, whichever is less. Measurements in the 5.15-5.25 GHz, 5.25-5.35 GHz, and the 5.47-5.725 GHz bands are made over a bandwidth of 1 MHz or the 26 dB emission bandwidth of the device, whichever is less. A narrower resolution bandwidth can be used, provided that the measured power is integrated over the full reference bandwidth.

### 5.2 TEST PROCEDURE

- a) Set RBW = approximately 1% of the emission bandwidth.
- b) Set the VBW > RBW.
- c) Detector = Peak.
- d) Trace mode = max hold.
- e) Measure the maximum width of the emission that is 26 dB down from the maximum of the emission. Compare this with the RBW setting of the analyzer. Readjust RBW and repeat measurement as needed until the RBW/EBW ratio is approximately 1%.

The following procedure shall be used for measuring (99 %) power bandwidth:

1. Set center frequency to the nominal EUT channel center frequency.
2. Set span = 1.5 times to 5.0 times the OBW.
3. Set RBW = 1 % to 5 % of the OBW
4. Set VBW  $\geq 3 \cdot$  RBW
5. Video averaging is not permitted. Where practical, a sample detection and single sweep mode shall be used. Otherwise, peak detection and max hold mode (until the trace stabilizes) shall be used.
6. Use the 99 % power bandwidth function of the instrument (if available).
7. If the instrument does not have a 99 % power bandwidth function, the trace data points are recovered and directly summed in power units. The recovered amplitude data points, beginning at the lowest frequency, are placed in a running sum until 0.5 % of the total is reached; that frequency is recorded as the lower frequency. The process is repeated until 99.5 % of the total is reached; that frequency is recorded as the upper frequency. The 99% occupied bandwidth is the difference between these two frequencies.

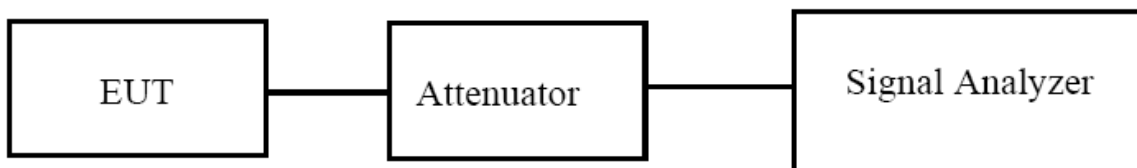

### 5.3 EUT OPERATION CONDITIONS

The EUT tested system was configured as the statements of 2.4 Unless otherwise a special operating condition is specified in the follows during the testing.



5.4 TEST RESULTS

Antenna A:

5150-5250MHz				
Test Mode	Test Channel MHz	26 dB Bandwidth MHz	99% Bandwidth MHz	Limit MHz
802.11a	5180	21.59	16.658	Pass
	5200	21.30	16.578	Pass
	5240	22.15	16.641	Pass
802.11n-HT20	5180	22.60	17.785	Pass
	5200	22.75	17.777	Pass
	5240	22.57	17.807	Pass
802.11n-HT40	5190	47.28	36.604	Pass
	5230	48.55	36.879	Pass

Antenna A:

5725-5850MHz				
Test Mode	Test Channel MHz	6 dB Bandwidth MHz	99% Bandwidth MHz	Limit MHz
802.11a	5745	16.30	16.642	≥500
	5785	16.28	16.682	≥500
	5825	16.29	16.659	≥500
802.11n-HT20	5745	17.50	17.767	≥500
	5785	17.53	17.786	≥500
	5825	17.54	17.791	≥500
802.11n-HT40	5755	36.17	36.645	≥500
	5795	36.25	36.541	≥500



Antenna B:

5150-5250MHz				
Test Mode	Test Channel MHz	26 dB Bandwidth MHz	99% Bandwidth MHz	Limit MHz
802.11a	5180	21.68	16.636	Pass
	5200	16.624	21.08	Pass
	5240	16.648	21.70	Pass
802.11n-HT20	5180	22.72	17.769	Pass
	5200	22.32	17.794	Pass
	5240	22.64	17.799	Pass
802.11n-HT40	5190	45.96	36.704	Pass
	5230	48.09	36.924	Pass

Antenna B:

5725-5850MHz				
Test Mode	Test Channel MHz	6 dB Bandwidth MHz	99% Bandwidth MHz	Limit MHz
802.11a	5745	16.33	16.673	≥500
	5785	16.28	16.600	≥500
	5825	16.35	16.652	≥500
802.11n-HT20	5745	17.54	17.777	≥500
	5785	17.35	17.756	≥500
	5825	17.49	17.765	≥500
802.11n-HT40	5755	36.04	36.594	≥500
	5795	36.29	36.544	≥500



Antenna A: 5150-5250MHz

Mode:		802.11a
5180MHz	<p>Agilent Spectrum Analyzer - Occupied BW</p> <p>Center Freq 5.18000000 GHz Center Freq: 5.180000000 GHz Radio Std: None        Trig: Free Run Avg/Hold: &gt;10/10 #F Gains: Low #Atten: 20 dB Radio Device: BTS</p> <p>10 dB/div Ref 20.00 dBm</p> <p>Center 5.18 GHz Span 30 MHz        #Res BW 300 kHz #VBW 1 MHz Sweep 1 ms</p> <p><b>Occupied Bandwidth 16.658 MHz</b> Total Power 5.89 dBm</p> <p>Transmit Freq Error -41.923 kHz OBW Power 99.00 %        x dB Bandwidth 21.59 MHz x dB -26.00 dB</p>	
5200MHz	<p>Agilent Spectrum Analyzer - Occupied BW</p> <p>Center Freq 5.20000000 GHz Center Freq: 5.200000000 GHz Radio Std: None        Trig: Free Run Avg/Hold: &gt;10/10 #F Gains: Low #Atten: 20 dB Radio Device: BTS</p> <p>10 dB/div Ref 20.00 dBm</p> <p>Center 5.2 GHz Span 30 MHz        #Res BW 300 kHz #VBW 1 MHz Sweep 1 ms</p> <p><b>Occupied Bandwidth 16.578 MHz</b> Total Power 4.68 dBm</p> <p>Transmit Freq Error 9.573 kHz OBW Power 99.00 %        x dB Bandwidth 21.30 MHz x dB -26.00 dB</p>	



5240MHz

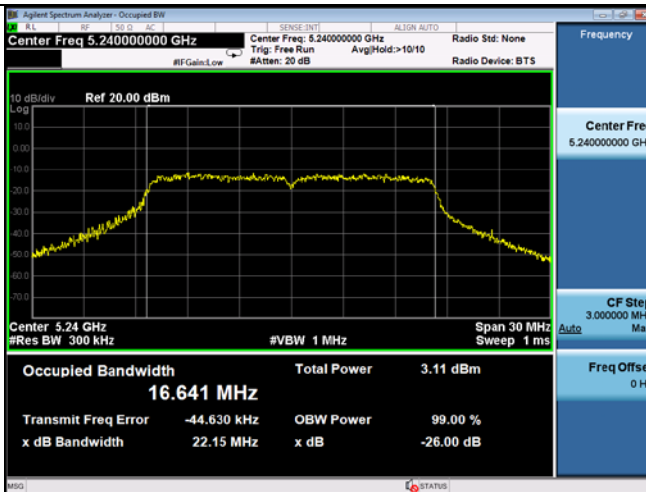



Mode:		802.11n-HT20
5180MHz	<p>Agilent Spectrum Analyzer - Occupied BW</p> <p>Center Freq 5.180000000 GHz</p> <p>Center Freq: 5.180000000 GHz</p> <p>Ref 20.00 dBm</p> <p>Occupied Bandwidth: 17.785 MHz</p> <p>Total Power: 5.13 dBm</p> <p>Transmit Freq Error: 15.232 kHz</p> <p>OBW Power: 99.00 %</p> <p>x dB Bandwidth: 22.60 MHz</p> <p>x dB: -26.00 dB</p>	
5200MHz	<p>Agilent Spectrum Analyzer - Occupied BW</p> <p>Center Freq 5.200000000 GHz</p> <p>Center Freq: 5.200000000 GHz</p> <p>Ref 20.00 dBm</p> <p>Occupied Bandwidth: 17.777 MHz</p> <p>Total Power: 4.84 dBm</p> <p>Transmit Freq Error: 9.268 kHz</p> <p>OBW Power: 99.00 %</p> <p>x dB Bandwidth: 22.75 MHz</p> <p>x dB: -26.00 dB</p>	
5240MHz	<p>Agilent Spectrum Analyzer - Occupied BW</p> <p>Center Freq 5.240000000 GHz</p> <p>Center Freq: 5.240000000 GHz</p> <p>Ref 20.00 dBm</p> <p>Occupied Bandwidth: 17.807 MHz</p> <p>Total Power: 2.79 dBm</p> <p>Transmit Freq Error: -11.288 kHz</p> <p>OBW Power: 99.00 %</p> <p>x dB Bandwidth: 22.57 MHz</p> <p>x dB: -26.00 dB</p>	

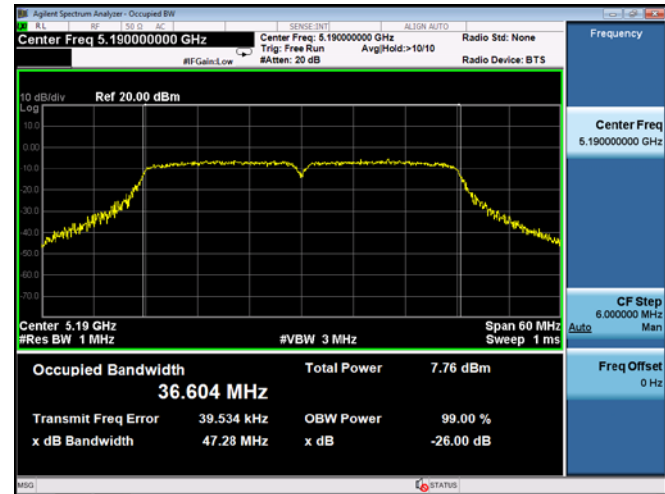
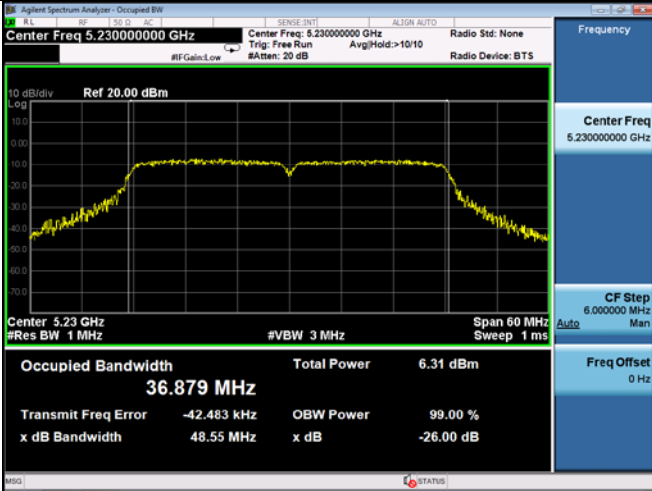

<p>Mode:</p> <p>5190 MHz</p>	<p>802.11n-HT40</p> 
<p>5230 MHz</p>	





Antenna A: 5725-5850MHz

Mode:		802.11a
5745MHz	<p>Center Freq 5.74500000 GHz</p> <p>Center Freq 5.74500000 GHz</p> <p>Occupied Bandwidth: 16.642 MHz</p> <p>Total Power: 5.45 dBm</p> <p>Transmit Freq Error: -62.587 kHz</p>	
5785MHz	<p>Center Freq 5.78500000 GHz</p> <p>Center Freq: 5.78500000 GHz</p> <p>Occupied Bandwidth: 16.682 MHz</p> <p>Total Power: 5.31 dBm</p> <p>Transmit Freq Error: -45.455 kHz</p>	
5825MHz	<p>Center Freq 5.82500000 GHz</p> <p>Center Freq: 5.82500000 GHz</p> <p>Occupied Bandwidth: 16.659 MHz</p> <p>Total Power: 6.01 dBm</p> <p>Transmit Freq Error: -60.039 kHz</p>	



Mode:		802.11n-HT20
5745MHz	<p>Agilent Spectrum Analyzer - Occupied BW</p> <p>Center Freq 5.745000000 GHz Center Freq: 5.745000000 GHz Radio Std: None</p> <p>Ref 20.00 dBm</p> <p>Center 5.745 GHz #Res BW 300 kHz #VBW 1 MHz Span 30 MHz Sweep 1 ms</p> <p>Occupied Bandwidth 17.767 MHz Total Power 4.84 dBm</p> <p>Transmit Freq Error -26.487 kHz OBW Power 99.00 %</p> <p>x dB Bandwidth 17.50 MHz x dB -6.00 dB</p>	
5785MHz	<p>Agilent Spectrum Analyzer - Occupied BW</p> <p>Center Freq 5.785000000 GHz Center Freq: 5.785000000 GHz Radio Std: None</p> <p>Ref 20.00 dBm</p> <p>Center 5.785 GHz #Res BW 300 kHz #VBW 1 MHz Span 30 MHz Sweep 1 ms</p> <p>Occupied Bandwidth 17.786 MHz Total Power 5.22 dBm</p> <p>Transmit Freq Error -3.708 kHz OBW Power 99.00 %</p> <p>x dB Bandwidth 17.53 MHz x dB -6.00 dB</p>	
5825MHz	<p>Agilent Spectrum Analyzer - Occupied BW</p> <p>Center Freq 5.825000000 GHz Center Freq: 5.825000000 GHz Radio Std: None</p> <p>Ref 20.00 dBm</p> <p>Center 5.825 GHz #Res BW 300 kHz #VBW 1 MHz Span 30 MHz Sweep 1 ms</p> <p>Occupied Bandwidth 17.791 MHz Total Power 5.67 dBm</p> <p>Transmit Freq Error -27.734 kHz OBW Power 99.00 %</p> <p>x dB Bandwidth 17.54 MHz x dB -6.00 dB</p>	



Mode:		802.11n-HT40
5755 MHz	<p>Agilent Spectrum Analyzer - Occupied BW</p> <p>Center Freq: 5.755000000 GHz    Center Freq: 5.755000000 GHz    Radio Std: None</p> <p>Trig: Free Run    Avg/Hold: &gt;10/10    Radio Device: BTS</p> <p>#IF Gain: Low    #Atten: 20 dB</p> <p>10 dB/div    Ref 20.00 dBm</p> <p>Center 5.755 GHz    Span 60 MHz</p> <p>#Res BW 1 MHz    #VBW 3 MHz    Sweep 1 ms</p> <p>Occupied Bandwidth    Total Power    7.82 dBm</p> <p><b>36.645 MHz</b></p> <p>Transmit Freq Error    -94.552 kHz    OBW Power    99.00 %</p> <p>x dB Bandwidth    36.17 MHz    x dB    -6.00 dB</p>	
5795 MHz	<p>Agilent Spectrum Analyzer - Occupied BW</p> <p>Center Freq: 5.795000000 GHz    Center Freq: 5.795000000 GHz    Radio Std: None</p> <p>Trig: Free Run    Avg/Hold: &gt;10/10    Radio Device: BTS</p> <p>#IF Gain: Low    #Atten: 20 dB</p> <p>10 dB/div    Ref 20.00 dBm</p> <p>Center 5.795 GHz    Span 60 MHz</p> <p>#Res BW 1 MHz    #VBW 3 MHz    Sweep 1 ms</p> <p>Occupied Bandwidth    Total Power    8.17 dBm</p> <p><b>36.541 MHz</b></p> <p>Transmit Freq Error    -29.788 kHz    OBW Power    99.00 %</p> <p>x dB Bandwidth    36.25 MHz    x dB    -6.00 dB</p>	



Antenna B: 5150-5250MHz

Mode:		802.11a
5180MHz	<p>Center Freq: 5.18000000 GHz</p> <p>Center Freq: 5.18000000 GHz</p> <p>Center: 5.18 GHz</p> <p>Occupied Bandwidth: <b>16.636 MHz</b></p> <p>Total Power: 5.29 dBm</p> <p>Transmit Freq Error: -13.321 kHz</p> <p>OBW Power: 99.00 %</p>	
5200MHz	<p>Center Freq: 5.20000000 GHz</p> <p>Center Freq: 5.20000000 GHz</p> <p>Center: 5.2 GHz</p> <p>Occupied Bandwidth: <b>16.624 MHz</b></p> <p>Total Power: 4.37 dBm</p> <p>Transmit Freq Error: -19.667 kHz</p> <p>OBW Power: 99.00 %</p>	
5240MHz	<p>Center Freq: 5.24000000 GHz</p> <p>Center Freq: 5.24000000 GHz</p> <p>Center: 5.24 GHz</p> <p>Occupied Bandwidth: <b>16.648 MHz</b></p> <p>Total Power: 2.73 dBm</p> <p>Transmit Freq Error: -61.559 kHz</p> <p>OBW Power: 99.00 %</p>	



Mode:		802.11n-HT20
5180MHz	<p>Agilent Spectrum Analyzer - Occupied BW</p> <p>Center Freq 5.180000000 GHz</p> <p>Center Freq: 5.180000000 GHz</p> <p>Ref 20.00 dBm</p> <p>Occupied Bandwidth: 17.769 MHz</p> <p>Total Power: 5.10 dBm</p> <p>Transmit Freq Error: 15.087 kHz</p> <p>OBW Power: 99.00 %</p> <p>x dB Bandwidth: 22.72 MHz</p> <p>x dB: -26.00 dB</p>	
5200MHz	<p>Agilent Spectrum Analyzer - Occupied BW</p> <p>Center Freq 5.200000000 GHz</p> <p>Center Freq: 5.200000000 GHz</p> <p>Ref 20.00 dBm</p> <p>Occupied Bandwidth: 17.794 MHz</p> <p>Total Power: 4.40 dBm</p> <p>Transmit Freq Error: 17.964 kHz</p> <p>OBW Power: 99.00 %</p> <p>x dB Bandwidth: 22.32 MHz</p> <p>x dB: -26.00 dB</p>	
5240MHz	<p>Agilent Spectrum Analyzer - Occupied BW</p> <p>Center Freq 5.240000000 GHz</p> <p>Center Freq: 5.240000000 GHz</p> <p>Ref 20.00 dBm</p> <p>Occupied Bandwidth: 17.799 MHz</p> <p>Total Power: 2.72 dBm</p> <p>Transmit Freq Error: -15.571 kHz</p> <p>OBW Power: 99.00 %</p> <p>x dB Bandwidth: 22.64 MHz</p> <p>x dB: -26.00 dB</p>	



Mode:	802.11n-HT40
5190 MHz	 <p>Agilent Spectrum Analyzer - Occupied BW</p> <p>Center Freq: 5.190000000 GHz</p> <p>Center Freq: 5.190000000 GHz</p> <p>Radio Std: None</p> <p>Frequency: 5.190000000 GHz</p> <p>Ref: 20.00 dBm</p> <p>Center: 5.19 GHz</p> <p>#Res BW: 1 MHz</p> <p>#VBW: 3 MHz</p> <p>Span: 60 MHz</p> <p>Sweep: 1 ms</p> <p>Occupied Bandwidth: 36.704 MHz</p> <p>Total Power: 7.95 dBm</p> <p>Transmit Freq Error: 274 Hz</p> <p>OBW Power: 99.00 %</p> <p>x dB Bandwidth: 45.96 MHz</p> <p>x dB: -26.00 dB</p>
5230 MHz	 <p>Agilent Spectrum Analyzer - Occupied BW</p> <p>Center Freq: 5.230000000 GHz</p> <p>Center Freq: 5.230000000 GHz</p> <p>Radio Std: None</p> <p>Frequency: 5.230000000 GHz</p> <p>Ref: 20.00 dBm</p> <p>Center: 5.23 GHz</p> <p>#Res BW: 1 MHz</p> <p>#VBW: 3 MHz</p> <p>Span: 60 MHz</p> <p>Sweep: 1 ms</p> <p>Occupied Bandwidth: 36.924 MHz</p> <p>Total Power: 6.24 dBm</p> <p>Transmit Freq Error: -51.584 kHz</p> <p>OBW Power: 99.00 %</p> <p>x dB Bandwidth: 48.09 MHz</p> <p>x dB: -26.00 dB</p>



Antenna B: 5725-5850MHz

Mode:		802.11a
5745MHz	<p>Center Freq: 5.745 GHz Total Power: 5.97 dBm Occupied Bandwidth: 16.673 MHz Transmit Freq Error: -88.554 kHz OBW Power: 99.00 %</p>	
5785MHz	<p>Center Freq: 5.785 GHz Total Power: 5.28 dBm Occupied Bandwidth: 16.600 MHz Transmit Freq Error: -18.408 kHz OBW Power: 99.00 %</p>	
5825MHz	<p>Center Freq: 5.825 GHz Total Power: 6.27 dBm Occupied Bandwidth: 16.652 MHz Transmit Freq Error: -71.733 kHz OBW Power: 99.00 %</p>	



Mode:		802.11n-HT20
5745MHz	<p>Agilent Spectrum Analyzer - Occupied BW Center Freq 5.745000000 GHz Center Freq: 5.745000000 GHz #Res BW 300 kHz #VBW 1 MHz Span 30 MHz Sweep 1 ms Occupied Bandwidth 17.777 MHz Total Power 5.24 dBm Transmit Freq Error -43.611 kHz OBW Power 99.00 % x dB Bandwidth 17.54 MHz x dB -6.00 dB</p>	
5785MHz	<p>Agilent Spectrum Analyzer - Occupied BW Center Freq 5.785000000 GHz Center Freq: 5.785000000 GHz #Res BW 300 kHz #VBW 1 MHz Span 30 MHz Sweep 1 ms Occupied Bandwidth 17.756 MHz Total Power 5.04 dBm Transmit Freq Error 4.582 kHz OBW Power 99.00 % x dB Bandwidth 17.35 MHz x dB -6.00 dB</p>	
5825MHz	<p>Agilent Spectrum Analyzer - Occupied BW Center Freq 5.825000000 GHz Center Freq: 5.825000000 GHz #Res BW 300 kHz #VBW 1 MHz Span 30 MHz Sweep 1 ms Occupied Bandwidth 17.765 MHz Total Power 5.81 dBm Transmit Freq Error -33.394 kHz OBW Power 99.00 % x dB Bandwidth 17.49 MHz x dB -6.00 dB</p>	





Mode:		802.11n-HT40
5755 MHz	<p>Center Freq 5.75500000 GHz</p> <p>Center Freq: 5.755000000 GHz</p> <p>Occupied Bandwidth: 36.594 MHz</p> <p>Total Power: 7.65 dBm</p> <p>Transmit Freq Error: -103.49 kHz</p> <p>OBW Power: 99.00 %</p>	
5795 MHz	<p>Center Freq 5.79500000 GHz</p> <p>Center Freq: 5.795000000 GHz</p> <p>Occupied Bandwidth: 36.544 MHz</p> <p>Total Power: 8.33 dBm</p> <p>Transmit Freq Error: -38.081 kHz</p> <p>OBW Power: 99.00 %</p>	