

FLYABILITY  
RANGE  
EXTENDER

**USER MANUAL**

VERSION 0.3.9

MARCH 2018

# DISCLAIMER

---

Terms with initial capital letters shall have the following meanings:

"Agreement"	means the conditions of use of this Original Instructions and any other agreement between You and Flyability per which the Product has been delivered to You, including but not limited to Flyability's General Terms and Conditions.
"Flyability"	means Flyability SA, a company incorporated in the Canton of Vaud in Switzerland under federal number CH-550.1.156.670-6 (IDE CHE-348.376.646) having its registered offices at EPFL Innovation Park BLDC C, 1015 Lausanne, Switzerland
"Product"	means all goods and services described in this document.
"You"	means the person or legal entity to which the Product is delivered or who is operating the aircraft

All rights related to this document and all information it contained are the property of Flyability. REPRODUCTION, USE OR DISCLOSURE TO THIRD PARTIES WITHOUT PRIOR WRITTEN PERMISSION FROM FLYABILITY IS STRICTLY PROHIBITED.

By using the Products, software and systems of Flyability, You fully accept and consent, without reserve, Flyability's warranty and liability terms stated below and all other terms and conditions agreed between You and Flyability.

## 1. Product limited warranty

By using the Product, You hereby signify that you have read, fully understood and agreed this disclaimer and the original instructions, and You agree that the Product:

- (i) May be unfitted to Your needs and purposes; and
- (ii) Should not be used under influence of alcohol, drugs or any substances that may impair cognitive abilities; and
- (iii) Is subject to local regulations that could prevent its use.

You shall pursue available remedies to You according to the Agreement. The warranty shall exclude defects due to misuse, non-observation of the Original Instructions, moisture or liquids, explosive gas, proximity or exposure to heat at temperatures exceeding the Operating temperature, excessive strain, abuse, neglect, misapplication, repairs or modifications made by anyone other than Flyability or certified by Flyability. There are no express or implied warranties, representations or conditions other than those stated in this limited warranty and the Agreement. The remedy set forth herein and in the Agreement shall be the sole, exclusive remedy with respect to the Product.

## 2. Product liability

IN NO EVENT OR UNDER ANY CIRCUMSTANCE, UNLESS EXPRESSLY STATED IN THE AGREEMENT, SHALL FLYABILITY SA, ITS DIRECTORS, OFFICERS OR EMPLOYEES BE LIABLE TO YOU OR TO ANY THIRD PERSON CLAIMING RIGHTS DERIVED FROM YOUR RIGHTS, IN CONTRACT, TORT OR OTHERWISE, FOR INDIRECT, SPECIAL, INCIDENTAL, EXEMPLARY, PUNITIVE OR CONSEQUENTIAL DAMAGES OF ANY KIND WHATSOEVER EVEN IF ADVISED OF THE POSSIBILITY OF SUCH DAMAGES INCLUDING, BUT NOT LIMITED TO, ANY DAMAGES CAUSED BY YOU OR A THIRD PARTY WHILE OPERATING OR USING THE PRODUCT, ANY DAMAGES CAUSED BY FAILURE OF THE ELECTRONICS OR SOFTWARE, ANY LOSS OF REVENUE, LOSS OF PROFIT, OR LOSS OF DATA WHETHER BASED UPON ANY ALLEGED BREACH OF WARRANTY, REPRESENTATION OR CONDITION, CONTRACT, OR ANY OTHER CONDUCT INCLUDING NEGLIGENCE (INTENTIONAL OR OTHERWISE), GIVING RISE TO SUCH CLAIM. A Party who relies on a breach of the other Party's obligations under this Agreement, shall take any and all reasonable measures in the circumstances to mitigate the consequences, including loss of profit, resulting from the breach. If it fails to take such measures, the Party in breach may claim a reduction in the damages in the amount by which the consequences should have been mitigated.

YOU SHALL NOT OPERATE THE PRODUCT IN AREAS OR UNDER CIRCUMSTANCES WHERE A FAILURE COULD CAUSE DAMAGES AND/OR HARM TO OBJECTS AND/OR PEOPLE. YOU SHOULD HAVE READ AND UNDERSTOOD THE ORIGINAL INSTRUCTIONS COMPLETELY BEFORE OPERATING THE PRODUCT. ANY DAMAGE AND/OR HARM ARISING FROM NOT ACCURATELY FOLLOWING THE PROCESSES AND GUIDANCE FROM THE ORIGINAL INSTRUCTIONS SHALL BE THE SOLE RESPONSIBILITY OF THE OPERATOR OF THE PRODUCT.

ALL USE OF THE PRODUCTS IS UNDER YOUR SOLE RESPONSIBILITY, INCLUDING BUT NOT LIMITED TO, THE COMPLIANCE WITH APPLICABLE LAW AND REGULATIONS OF THE COUNTRY IN WHICH THE PRODUCT IS OPERATED.

## *Authorizations and regulations*

SOME COUNTRIES MAY HAVE LAWS THAT LIMIT OR PROHIBIT THE USE OF RADIO FREQUENCY EQUIPMENT. YOU ARE SOLE RESPONSIBLE FOR SECURING ALL AUTHORIZATIONS, CERTIFICATIONS AND LICENSES REQUIRED FOR THE USE OF THE PRODUCT. FLYABILITY SA DOES NOT PROVIDE ANY LEGAL ADVICE OR COUNSELING AND UNDER NO EVENT SHALL BE LIABLE FOR ANY INFRINGEMENT OF ANY APPLICABLE LAW BY YOU.

The Range extender opens new applications for the most demanding indoor drone inspection and exploration missions, where communication between the drone and the pilot is particularly difficult.

**“Since we released Elios, we performed many field trials and experienced multiple use cases where having an extended reach is not only beneficial for the safety of the operator, but also provides access beyond what was previously reachable”**

Dr. Adrien Briod, CTO of Flyability

## Using this manual

### LEGEND

 Warning

 Important

 Hints and Tips

 Reference

### READ BEFORE FIRST USE

Read the following document before using the Range Extender:

1. Range Extender Disclaimer and Safety Guidelines
2. Range Extender Quick Start Guide

We recommend you that you check all tutorial videos and articles on the official Flyability website and read the Disclaimer before you fly. Prepare for the equipment's first use by reviewing the Range Extender Quick Start Guide, referring to the User Manual for further details.

### VIDEO TUTORIAL

Please watch the tutorial accessible through the below link. This demonstrates how to use the Range Extender safely: [www.my.flyability.com](http://www.my.flyability.com)

# Getting Started

## WHAT'S IN THIS DOCUMENT

This manual gets you started with setting up, packing up and maintaining your Range Extender. The following sections ensure that you use the Range Extender optimally. As soon as setup is complete you are ready to use your drone.

The manual walks you through every function of the Range Extender and explains how to maintain it in case you need to change one of its components. A printable version of the manual is also available online at <https://my.flyability.com>.

## PRODUCT DESCRIPTION

The Range Extender is composed of 6 different elements:

1. **Modified RC** - RC (Remote Controller) compatible with standard antennas and with the Range Extender. Both configurations allow a stable connection with the aircraft built by Flyability.
2. **Removable Antennas** - The removable antennas can be placed directly on the modified RC if the Range Extender is not needed.
3. **RC Cable** - 2m long and transmits the signals between the modified RC and the Power Module.
4. **Power Module** - Houses the Range Extender battery and gives an audio/visual indication of the battery's state of charge.
5. **Module Cable** - 20m long with marks every meter and red marks every 5m. The cable transmits the signal between the Power Module and the Antenna Module.
6. **Antenna Module** - Module contains the two system antennas and signal amplification circuitry. Housing features highly reflective stickers to increase the device's visibility in low light conditions.

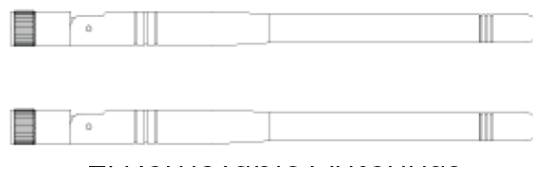

1. Modified RC

5. Module Cable

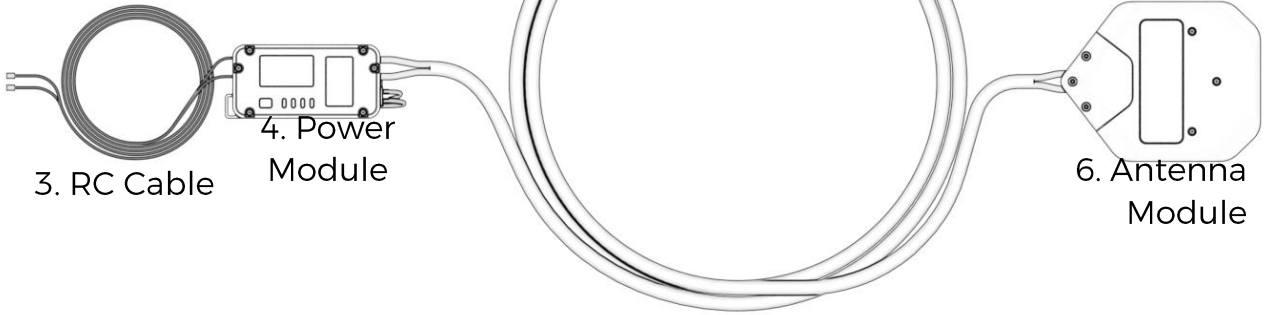

3. RC Cable

4. Power  
Module

6. Antenna  
Module

 POWER MODULE OVERVIEW

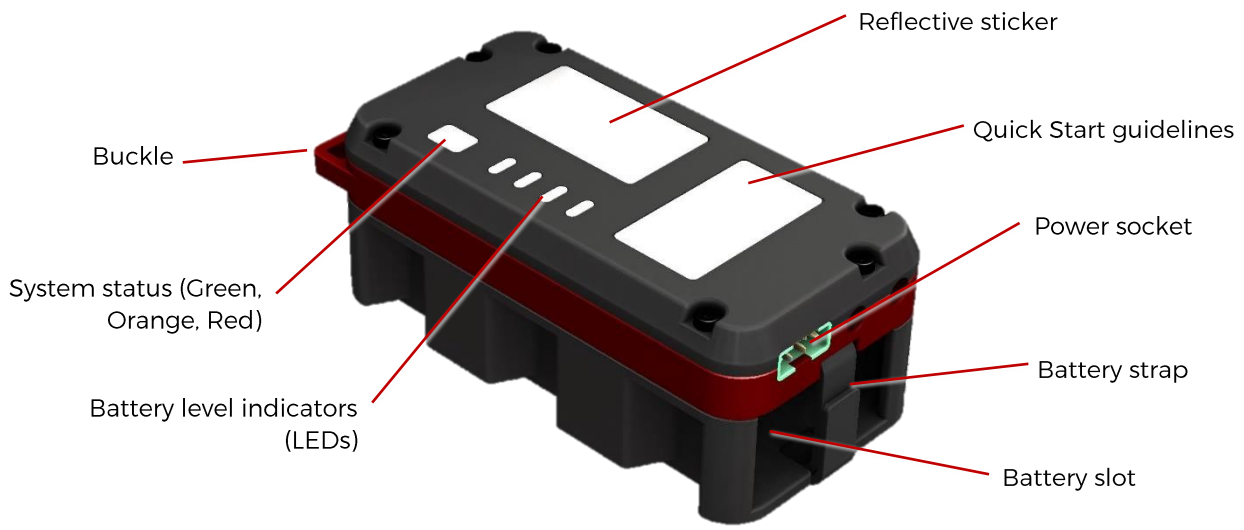

# Safety notices



## GENERAL GUIDELINES

1. The pilot (operator) should always act according to his or her best judgment, focusing on the safety of the people and the environment he/she is flying (operating) in.
2. Operating the Elios (Range Extender) system can be stressing, tiring and can cause muscular fatigue. The remote controller is equipped with a loop on which to attach a neck strap, use this to relieve your muscles.
3. The power module is equipped with an anchoring clip, this can be attached to objects in the environment to prevent the system being lost when deployed into voids.
4. DO NOT use Elios (the Range Extender) under influence of alcohol, drugs or any other substances that may impair cognitive abilities.
5. A risk assessment MUST be performed before every flight (deploying the Range Extender).
6. Use only provided Flyability parts, genuine Flyability parts, or parts certified by Flyability. Using other devices or parts combination with the Range Extender (e.g. batteries, antennas, etc.) or performing unauthorized modifications may result in system malfunctioning and/or compromise safety.
7. It is recommended to use only transport cases approved by Flyability.
8. DO NOT over torque the connectors when plugging in the removable antennas or the RC cables.
9. ONLY use the antennas provided by Flyability or an approved reseller.
10. The remote controller MUST be turned on ONLY AFTER connecting the removable antennas or the cables. The remote controller MUST be turned off PRIOR TO disconnecting the removable antennas or the cables. Not following this recommendation could severely damage the RC. Flyability is not responsible for any damages to the RC caused through improper use.
11. DO NOT use any other battery than the ones provided by Flyability for use in Elios. Use of other batteries may damage the product and/or affect its performance.
12. It is recommended to not bend the RC cable over a minimum 1cm radius and the Module cable over a minimum 6.5cm radius. Not respecting this can change the cables electrical properties and lower their longevity.
13. After usage, protective caps should be placed back on the RC connector and RC cable connectors
14. Read carefully the Battery Safety Guidelines and the Quick Start Guide before using the Elios system.

## ENVIRONMENTAL AWARENESS

Always use the Range extender within the listed conditions. Doing so will reduce incidents and damage to the product.

1. Range extender is not waterproof. Do not use it in heavy rain/snow or in humid environments. Moisture can seriously damage the electronics of Elios.
2. Store the Range Extender system in a dry environment between 0°C and 30°C and protected from direct sunlight.

3. Avoid flying Using in dusty or sandy environments and avoid subjection to vapor or gas. . Do not forget this topic in your risk assessment. Note that, mechanical parts may deteriorate more rapidly in dusty or sandy environments.
4. Very cold temperatures lead to reduced utilisation times. Do not use in temperatures below 0°C. If you need to fly in temperatures below 10°C, heat the batteries prior to usage using a battery warmer bag and observe safe practices as described in the Battery Safety Guidelines.
5. Flyability cannot guarantee the Range Extender capability if not used in temperatures from 0°C to 50°C.
6. It is not recommended to use the Range Extender close to power lines, power transformers or other areas with large electromagnetic disturbances. These may cause severe effects Radio frequency communication and range.
7. The Range Extender should not be used in or near explosive or flammable environments.
8. The removable antennas provided by Flyability, as well as the antennas contained in the antenna module of the range extender, are made to emit radiation equally in all the directions, regardless of their orientation. To ensure the best performance, Flyability recommends using the system in a dry environment, with a minimum of 5cm between the antennas and surrounding surfaces. If in the antenna module is in direct contact with metallic structures, the quality of the signal and range can seriously be diminished. Ensure proper separation.
9. Liquids have serious effects on the Range Extender. The range extender does not work if in contact, half or completely submerged in water. Moreover, if the module is wet, its performances can slightly decrease
10. Avoid any water contact or humidity with the RC cable connect, the RC connectors or the removable antenna connectors, it may decrease their electrical and mechanical properties



# Use

Two configurations are possible:

- Remote controller with the standard antennas
- Remote controller with the range extender

In both configurations, do not turn on the Remote Controller before completing the following setting-up procedures. Not following these guidelines can seriously damage the remote controller and decrease the performance of the product.

## CONFIGURATION WITH STANDARD ANTENNAS

### SET UP



*Reminder: Turn on the Remote Controller only after connecting the antennas.*

- Remove the connector caps from the antennas and the remote controller
- Screw the Removable Antennas on to the remote controller
- Place the antennas at a 90° angle to each other for optimal performance

### PACK UP



*Reminder: Turn off the Remote Controller prior to unplugging the antennas.*

- Unscrew the Removable Antennas
- Put the protective caps back in place on both the antennas and the Modified RC Connectors

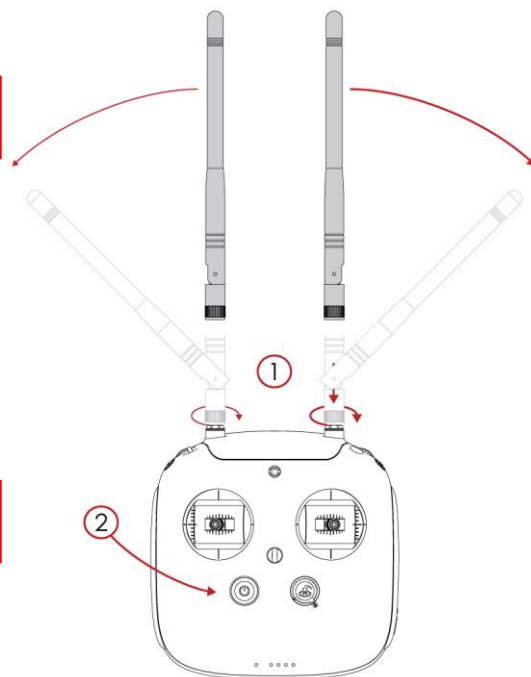

# CONFIGURATION WITH RANGE EXTENDER

## SET UP



*Reminder: Turn on the Remote Controller only after connecting the cables. However the battery can be connected to the Power Module at any time.*

- A. Remove the connector caps from the cables and the remote controller.
- B. Connect the cables to the Remote Controller.
- C. Attach the Power Module to the surrounding environment or to yourself with the strap.
- D. Deploy the Power Module Cable first avoiding any twists or knots.
- E. Deploy the Antenna Module to the desired length.
- F. Place and secure a battery in the Power Module.
- G. Connect the battery power connector to power the system.
- H. Wait for the system to initialize. If after 5 seconds the status LED is not green, please refer to the trouble shooting section hereinafter.



*Additional marks are placed on the cable. The white ones are placed every meter whereas red marks are placed every 5 meters.*

## PACK UP



*Reminder: Turn off the Remote Controller prior to unplugging the cables. However the battery can be connected to the Power Module at any time.*

- A. Disconnect the battery power connector
- B. Remove the battery from the battery slot
- C. Roll the Antenna Module Cable.
- D. Detach the Power Module from the surrounding environment
- E. Unscrew the RC Cables connectors from the RC



*To roll the cable to the correct diameter, align all marks placed on the cable to within 10cm.*

# CHECKLIST



If using the remote controller with standard antennas:







- Confirm both antennas are properly screwed on to the remote controller.
- Make sure the two antennas are orientated at 90° to each other (see illustration).
- Make sure a steady green status LED is shown on the Power Module prior to start the mission.

If using the remote controller with the range extender:



- Check for any damage to the cables (e.g. deep cuts in the plastic jacket).
- Check that both connector are well screwed into the remote controller.
- Check that the cables are functional. To do so, set up the range extender and ensure that a connection is established with the drone AND that you can control it (e.g. turning the LEDs on, tilting the camera). Then, turn off the RC and swap the cables prior to turning the RC on again. Check again if the connection is established with the robot AND if you can control it.
  - o If a connection can be established in both configurations, the range extender is fully functional.
  - o If a connection is not established during one or both configurations, the cables need to be replaced. To do so, contact Flyability or check the online shop at [www.my.flyability.com](http://www.my.flyability.com)
- Check that all LEDs and the buzzer are functioning correctly. Connect a charged battery and refer to the trouble shooting section hereinafter.

## POWER MODULE LED AND SOUND INTERFACE

LED status	Signification
	LED steady
	LED blinks
	LED off

LED Pattern	Battery Level
	100% - 80%
	80% - 60%
	60% - 40%
	40% - 20%
	20% - 15%
	15% - 0%

## TROUBLE SHOOTING

LED action	Sound	Signification
	Beeps (indicating the number of LEDs illuminated) every 10 min	The system is working perfectly.
	... – BB – BB – ... Beeps 2 times every 1 seconds	<u>Connectivity issue</u> Some cables might be disconnected inside the Power Module or the Antenna Module. Refer to the maintenance section to solve this problem.

If a partially used battery (not 100% fully charged) is connected to the Power Module, the system is usable, however the battery state of charge estimation, as provided by the white LEDs, can be inaccurate. For security reasons, Flyability recommends to always use a fully charged battery.

If the 4 white LEDs are blinking, the battery state of charge is at a critical level and the system will shortly power down. After bringing the drone back to the operation site, change the Range Extender battery for a new one.

# Maintenance

## CLEANING

Do not use any solvents or abrasive

## MODULE

With a humid piece of cloth,

## MODULE ANTENNA

## REPLACE COMPONENT

To be check with FPS and Alex P

## RETURN POLICY AND WARRANTY

## HELP & SUPPORT

Visit [my.flyability.com](https://my.flyability.com) for more information.



Online Training



Contact us



Shop: Spares & Co.



Safety & Method



Elios Instruction & Description



Battery



Software & Data processing



Accessories



Traveling & Shipping



Training



Support & Maintenance



Downloads

# Technical and specifications

## GENERAL

USE	Possible to be stored in the Elios case Deployment / Packing time < 5 min
ERGONOMY	Lightweight (less than 2.5 kg) Battery change time < 1 min
MAINTENANCE	Possible to change independently some components of the system

## POWER MODULE

FUNCTIONS	Buckle can be attached to the surrounding environment Display battery state of charge Audible warning when battery low Houses the battery and provides power to the Range Extender system (NOT the RC)
RUGGEDIZATION LEVEL	Shock resistant (1.2 m free-fall) Temperature: 0 °C - 40 °C

## ANTENNA MODULE

FUNCTION	Transmits/Receives data to/from the drone
RUGGEDIZATION LEVEL	Water splash and dust resistant Temperature: 0 °C - 40 °C
ATTACHEMENT	Thread compatible with most standard tripods (1/4-20 UNC)
VISIBILITY	Reflective surfaces visible from Elios up to 10 meters away
SHAPE	Teardrop-shaped Compatible with Elios protection cage (can't enter the cage) Easy to extract / recover
WEIGHT & DIMENSIONS	400 g (without cable) 350 mm x 150 mm x 50 mm
MAINTENANCE	Easy to clean

## CABLES

CABLE 20m single strand with 15kg resist  
2m standard RF cable

## BATTERY

BATTERY Compatible with batteries 5C & 8C  
Operation time 2 h, charging time 1h

## REMOTE CONTROLLER

USEABILITY Custom Lightbridge 2 controller  
Can be used with/without Range Extender  
Connected to Range Extender's casing through two 2m cables  
Controls payload settings and aircraft movements

CONNECTORS HDMI, SDI and USB output ports

WEIGHT 810 g

OPERATING TEMPERATURE -10 °C to 40 °C

BATTERY LiPo battery, 2 cells, 6000 mAh

## FCC Compliance Notice

This device complies with Part 15 of the FCC Rules. Operation is subject to the following two conditions: (1) This device may not cause harmful interference, and (2) This device must accept any interference received, including interference that may cause undesired operation.

Any changes or modifications not expressly approved by the party responsible for compliance could void the user's authority to operate the equipment.

This equipment has been tested and found to comply with the limits for a Class B digital device, pursuant to part 15 of the FCC Rules. These limits are designed to provide reasonable protection against harmful interference in a residential installation. This equipment generates, uses and can radiate radio frequency energy and, if not installed and used in accordance with the instructions, may cause harmful interference to radio communications. However, there is no guarantee that interference will not occur in a particular installation. If this equipment does cause harmful interference to radio or television reception, which can be determined by turning the equipment off and on, the user is encouraged to try to correct the interference by one or more of the following measures:

- Reorient or relocate the receiving antenna.
- Increase the separation between the equipment and receiver.
- Connect the equipment into an outlet on a circuit different from that to which the receiver is connected.
- Consult the dealer or an experienced radio/TV technician for help.

### RSS warning

This device complies with ISED licence-exempt RSS standard (s). Operation is subject to the following two conditions: (1) this device may not cause interference, and (2) this device must accept any interference, including interference that may cause undesired operation of the device.

Le présent appareil est conforme aux CNR d'ISED licenciables aux appareils radio exempts de licence.

L'exploitation est autorisée aux deux conditions suivantes:

- (1) l'appareil ne doit pas produire de brouillage, et
- (2) l'utilisateur de l'appareil doit accepter tout brouillage radioélectrique subi, même si le brouillage est susceptible d'en compromettre le fonctionnement.

### RF Exposure Information

This equipment complies with FCC/ISED radiation exposure limits set forth for an uncontrolled environment. In order to avoid the possibility of exceeding the FCC/ISED radio frequency exposure limits, human proximity to the antenna shall not be less than 20cm during normal operation.

Cet équipement est conforme aux limites d'exposition aux radiations FCC / ISED définies pour un environnement non contrôlé. Afin d'éviter la possibilité de dépasser les limites d'exposition aux radiofréquences FCC / ISED, la proximité humaine à l'antenne ne doit pas être inférieure à 20 cm pendant le fonctionnement normal.

This radio transmitter [IC:22887-MAGICREX] has been approved by Innovation, Science and Economic Development Canada to operate with the antenna types listed below, with the maximum permissible gain indicated. Antenna types not included in this list that have a gain greater than the maximum gain indicated for any type listed are strictly prohibited for use with this device.

Frequency Band	Antenna type	Max Gain(dBi)
5.8G	PCB	1.5
2.4G	monopole	3.5