

Prüfbericht - Nr.: 19660350 001		Seite 1 von 56	
<i>Test Report No.:</i>		<i>Page 1 of 56</i>	
Auftraggeber: <i>Client:</i>		Nokia Solutions and Networks Oy Karaportti 3 02610, ESPOO FINLAND	
Gegenstand der Prüfung: <i>Test item:</i>		Home Outdoor Modem	
Bezeichnung: <i>Identification:</i>		Serien-Nr.: <i>Serial No.</i>	LC173300127 LC173300112
Wareneingangs-Nr.: <i>Receipt No.:</i>		Eingangsdatum: <i>Date of receipt:</i>	30.10.2017
Prüfart: <i>Testing location:</i>		Refer Page 3 of 56 for test facilities	
Prüfgrundlage: <i>Test specification:</i>		FCC Part 27 & ANSI C63.26- 2015	
Prüfergebnis: <i>Test Result:</i>		Der Prüfgegenstand entspricht oben genannter Prüfgrundlage(n). <i>The test items passed the test specification(s).</i> FCC Test Firm Registration Number: 496599	
Prüflaboratorium: <i>Testing Laboratory:</i>		TÜV Rheinland (India) Pvt. Ltd. 82/A, 3rd Main, West Wing, Electronic City Phase 1 Hosur Road, Bangalore – 560 100. India	
geprüft / tested by:		kontrolliert / reviewed by:	
04.11.2017	Mahammadgouse Kaladagi Senior Engineer	21.11.2017	Saibaba Siddapur Assistant Manager
Datum <i>Date</i>	Name/Stellung <i>Name/Position</i>	Unterschrift <i>Signature</i>	Datum <i>Date</i>
			Name/Stellung <i>Name/Position</i>
			Unterschrift <i>Signature</i>
Sonstiges / Other Aspects: FCC ID:2AL7J-FMHOMN0041			
Abkürzungen: P(ass) = entspricht Prüfgrundlage F(ail) = entspricht nicht Prüfgrundlage N/A = nicht anwendbar N/T = nicht getestet		Abbreviations: P(ass) = passed F(ail) = failed N/A = not applicable N/T = not tested	
<p>Dieser Prüfbericht bezieht sich nur auf das o.g. Prüfmuster und darf ohne Genehmigung der Prüfstelle nicht auszugsweise vervielfältigt werden. Dieser Bericht berechtigt nicht zur Verwendung eines Prüfzeichens.</p> <p><i>This test report relates to the a. m. test sample. Without permission of the test center this test report is not permitted to be duplicated in extracts.</i></p> <p><i>This test report does not entitle to carry any safety mark on this or similar products.</i></p>			

Contents

1	Test Result Summary	3
2	List of Test and Measurement Instruments	3
3	General Product Information	4
3.1	Product Function and Intended Use	4
3.2	Ratings and System Details	4
3.3	Measurement Uncertainty:	6
4	Operational Description	6
5	Test Set-up and Operation Mode	7
5.1	Principle of Configuration Selection	7
5.2	Test Operation and Test Software	7
5.3	Test Modes – Data Rates and Modulations	7
6	Test Methodology	8
7	Test Results	10
7.1	RF Output Power – Conducted Mode	10
7.2	Occupied Bandwidth and 26 dB Bandwidth	13
8	Band Edge Compliance	27
8.1	Conducted Spurious Emission	36
8.2	Frequency Stability	50
8.3	RF Power (ERP/EIRP) – Radiated Mode	52
8.4	Field Strength of Spurious Radiation	53
9	List of Tables	56

Appendix 1: Test Setup Photos

Appendix 2: EUT External Photos

Appendix 3: EUT Internal Photos

Appendix 4: FCC & IC Label and Location

Appendix 5: Block Diagram

Appendix 6: Specification of EUT

Appendix 7: Schematic Diagrams

Appendix 8: Bill of Materials

Appendix 9: User Manual

Appendix 10: Maximum Permissible Exposure Information

1 Test Result Summary

Table 1: Test result summary

Test Item	Test Clause	Results
RF power conducted mode	§2.1046 §27.50 (h)(2)	Pass
Occupied bandwidth	§2.1049	Pass
Band edge compliance	§2.1051 §27.53(m)(2)(V)	Pass
Conducted spurious emission	§2.1051 §27.53(m)(2)(V)	Pass
Frequency stability	§2.1055 §27.54	Pass
RF power (ERP/EIRP) – radiated mode	§2.1046	Pass
Field strength of spurious radiation	§2.1053 §27.53(m)(2)(V)	Pass

2 List of Test and Measurement Instruments

Table 2: List of Test and Measurement Instruments

Equipment	Manufacturer	Model	Serial Number	Calibration Due Date
EMI Test Receiver	Rohde & Schwarz	ESU 40	100288	24.10.2018
Biconical Antenna	Schwarzbeck mess-elektronik	VHBB-9124 / BBA-9106	9124-656	09.01.2018
Broadband Antenna	Frankonia	ALX-4000	ALX-4000-806	09.01.2018
Horn Antenna	Frankonia	HAX-18	HAX18-802	16.03.2018
Active loop antenna	Frankonia	LAX-10	LAX-10-800	22.12.2017
Signal Generator	Agilent	E8257D	MY51110514	18.02.2018
Semi Anechoic Chamber	Frankonia	-	-	-
Spectrum Analyzer	Agilent	E4407B	US41192772	13.02.2018
Environmental Chamber	Envisys	EM80-40H	ET/022/14-15	19.06.2018
Unidirectional Coupler	AAMCS	0.5G-18G-10dB	000580	11.01.2018
Radio Communication Tester	Rohde & Schwarz	CMW500	126635	05.05.2018

Testing Facilities:

TUV Rheinland (India) Private Limited
 No. 108, Beside ISBR Business School,
 Electronic city Phase I
 Bangalore – 560 100

3 General Product Information

3.1 Product Function and Intended Use

The LTTH CPE outdoor unit (ODU) includes high-gain beam forming antenna and LTE modem providing the LTE broadband access to the network. ODU is connected to the indoor unit (IDU) through 10/100/100Mbps tri-speed ethernet PHY that provides power from the IDU to the ODU as well as the high speed data connection. ODU is LTE CAT4 capable and supports non-CA LTE band 41.

3.2 Ratings and System Details

Table 3: Ratings and System Details

Operating Frequency	Refer page 6 of 56
Power Class	3 (23dBm)
Release	10
Modulation Type	QPSK , 16-QAM
Number of Antenna – Two	Primary Antenna – One Diversity Antenna - One
Antenna Gain	14.5dBi
Antenna type	High gain cross polarized antenna PCBA mounted internal to enclosure with co-axial cable connection to the main board
Supply Voltage to Product	54V DC via PoE from IDU (Indoor Unit)
Environmental	Operating Temperature: -20 °C to +65 °C (Normal) -30 °C to +65 °C (Arctic) Storage Temperature : -40 °C to +85 °C

Test Conditions:

Supply Voltage: PoE Adaptor

Environmental conditions:

Temperature: +24.7 °C RH: 57.2 %

NTC	Normal Voltage (from POE), Normal Temperature(+25°C)
HT	High Temperature (+65 °C)
LT	Low Temperature (-30 °C)

Equipment used for testing

Table 4: Equipment used for Testing

Equipment Used for	S/N Number	IMEI No & ISMI No.	Hardware Version	Software version
Conducted Measurement on Antenna Port	LC173300112	359020070001388 & 001010123456063	02	1.4.47
Radiated Mode Test	LC173300127	359020070003160 & 001010123456063	02	1.4.47

Summary of Measured Power & Emission Designator:

Table 5: Summary of Measured Power & Emission Designator

TDD Band	Bandwidth	Maximum Power - Conducted Mode - QPSK (Pk)		Maximum Power - Conducted Mode - 16-QAM (Pk)		Output Power (dBm) - Radiated Mode -QPSK
		dBm	Watt	dBm	Watt	
41	5	26.95	0.50	26.97	0.50	35.97
	10	26.87	0.49	26.91	0.49	36.32
	15	26.49	0.45	26.95	0.50	35.98
	20	26.36	0.43	26.75	0.47	35.42

Emission Designator Details

Table 6: Emission Designator Details

TDD Band	Bandwidth	Emission Designator (QPSK)	Emission Designator (16-QAM)
41	5	4M51G7W	4M51D7W
	10	8M91G7W	8M91D7W
	15	13M4G7W	13M4D7W
	20	17M8G7W	17M8D7W

TDD bands Frequency Details:

Table 7: Operating frequency details

TDD Band	Transmitter Frequency (Uplink) (MHz)	Receiver Frequency (Downlink) (MHz)
41	2496 - 2690	2496 - 2690

Frequency List of Low/Mid/High channel

Table 8: Frequency List of Low/Mid/High channel

LTE TDD Band 41				
Bandwidth	Channel/Frequency (MHz)	Low	Mid	High
5	Channel No.	39675	40620	41565
	Frequency	2498.5	2593	2687.5
10	Channel No.	39700	40620	41540
	Frequency	2501	2593	2685
15	Channel No.	39725	40620	41515
	Frequency	2503.5	2593	2682.5
20	Channel No.	39750	40620	41490
	Frequency	2506	2593	2680

3.3 Measurement Uncertainty:

Table 9: Measurement Uncertainty

Parameter	Uncertainty
Occupied Channel Bandwidth	±5 %
RF output power, conducted	±1.5 dB
Power Spectral Density, conducted	±3 dB
Unwanted Emissions, conducted	±3 dB
All emissions, radiated	±6 dB
Temperature	±3 °C
Supply Voltages	±3 %
Time	±5 %

4 Operational Description

The ODU is installed on the wall/pole outside the house and is connected to the IDU through PoE+ interface. The ODU is connected to a eNodeB that has pre-allocated capacity to the CPE. The end user devices in the house are connected to the IDU over Wi-Fi or Ethernet. The LTE CPE supports max throughput of DL / UL speeds of 150/50 Mbps. It supports bandwidths of 5/10/15/20 MHz.

ODU has only LTE Feature.

5 Test Set-up and Operation Mode

5.1 Principle of Configuration Selection

Transmission was enabled with help of CMW500 on low, mid and high channel

5.2 Test Operation and Test Software

No Special Test software used for enabling the Transmission, SIM inserted in EUT to communicate with CMW500 simulator

Special Accessories and Auxiliary Equipment

- None

Countermeasures to achieve EMC Compliance

- None

5.3 Test Modes – Data Rates and Modulations

For Radiated spurious emissions, the tests were performed for all RB's & 2 modulations on Low, Mid & High channels and only worst case results are reported in this report.

6 Test Methodology

Radiated Emission Test

Frequency Range 9 kHz - 30 MHz

Test performed as per ANSI C63.4-2014 section 8.3

The loop Antenna was placed at 1m above the ground plane & EUT is 3 meters far from the measuring antenna. With 3m measurement distance, correction data were applied to the measured results. The test arrangement, measuring antenna guidelines and operational configurations in 8.2.1 and 8.2.2, shall be followed. The measurement antenna shall be positioned with its plane perpendicular to the ground at the Specified distance, when perpendicular to the ground plane, the lowest height of the magnetic antenna shall be 1 m above the ground and shall be positioned at the specified distance from the EUT. EUT & its associates are placed on non-conducting table of 0.8m height which is placed on the turn table, For each measurement antenna alignment, the EUT shall be rotated through 0° to 360° on a turntable. The report shall list worst case emission results, for each of the parallel & perpendicular orientations.

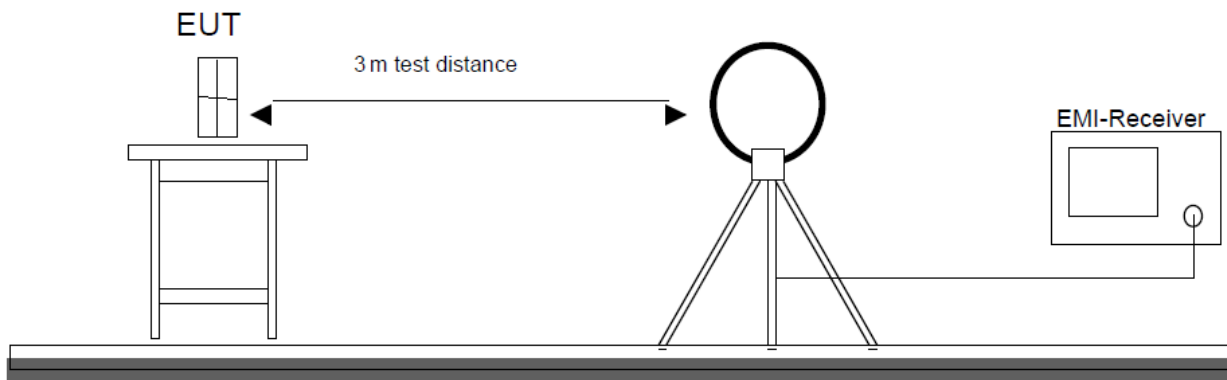

Frequency Range 30MHz to 10th harmonics of the highest fundamental frequency

Test performed as per ANSI C63.26-2015

ERP/EIRP Radiated Power & Radiated spurious emission test are performed as below.

The equipment under test is placed on non-conductive table at 3m away from the receive antenna in accordance with above mentioned standard. Turn table is rotated through 360 degree, and receiver antenna height is varied in order to determine the level of maximum emission. The maximum emission level and position of the maximized emission is recorded with use of spectrum analyzer.

The EUT is substituted by a substitution antenna. The substitute antenna is connected to a signal generator. Adjust the output level of the signal generator to get the same power recorded in with EUT and record the power level of Signal Generator. The cable loss at the test frequency should be compensated

The Power is calculated by the following formula

$$P_e = P_s(\text{dBm}) - \text{cable loss (dB)} + \text{antenna gain (dBd)}$$

Where

P_e = equivalent emission power in dBm

P_s = source (signal generator) power in dBm

These steps are repeated with the receiving antenna in the both vertical & horizontal polarization

Measurement Method

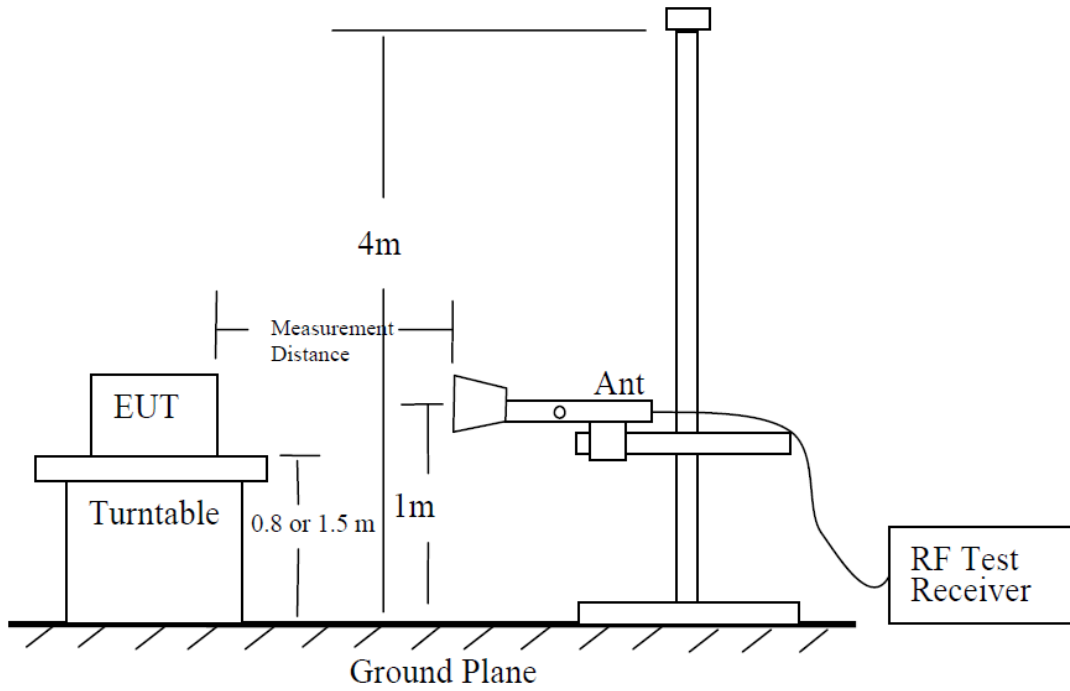

Substitute measurement method

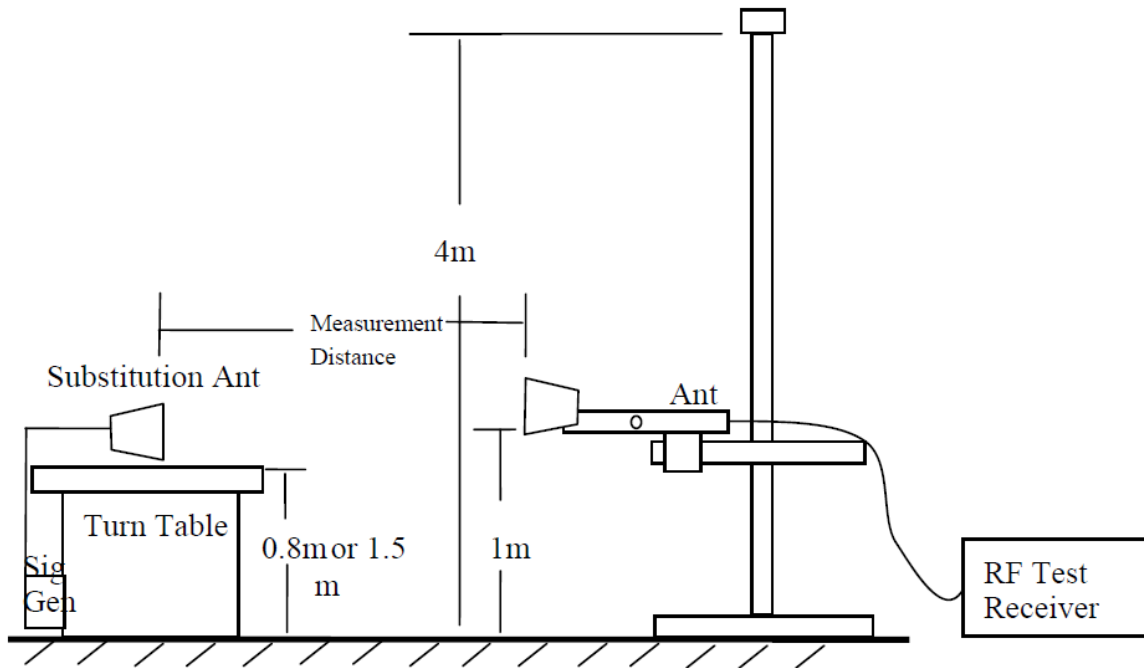

7 Test Results

7.1 RF Output Power – Conducted Mode

Result

Pass

Specification FCC Part §2.1046, §27.50 (h)(2)
 Measurement Bandwidth (RBW) ≥ OBW
 Detector Function Peak/Average

Test Setup:

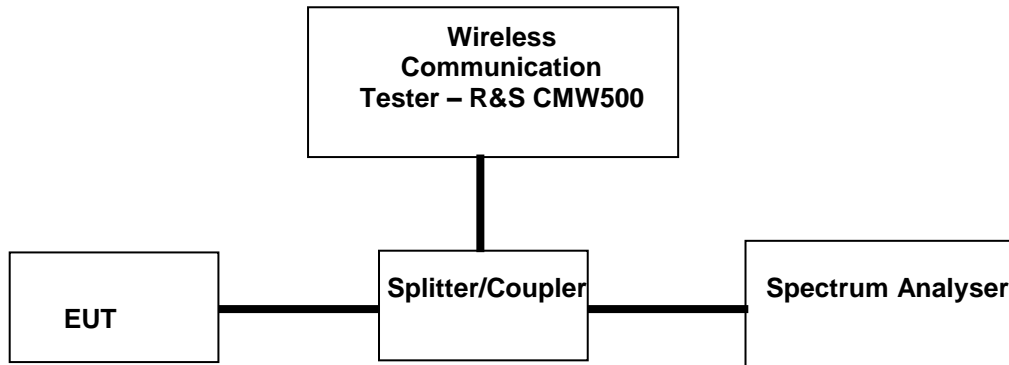

Note: For measurement of RF Output Power, sub clause 5.1.2 & 5.2.3.2 & Measurement of Peak to Average Power Ratio (PAPR), sub clause 5.7.3 of “971168 D01 Power Meas License Digital Systems v03” was used. Attenuator & Cable loss is included in the test results

PAPR – Peak to Average Power Ratio
 1RBL – 1 RB Low
 1RBH – 1RB High

Test Results

Table 10: QPSK Modulation RF Out Put Power Conducted ModeTest results

TDD Band 41, Modulation- QPSK						
Channel Bandwidth (MHz)	Resource Block Allocation	Channel	Peak Output Power (dBm)	Average Output Power (dBm)	PAPR (dB)	PAPR Limit (dB)
5	1L	Low	26.68	20.01	6.67	≤13
		Mid	26.62	20.21	6.41	≤13
		High	25.71	20.43	5.28	≤13
	1H	Low	26.36	20.72	5.64	≤13
		Mid	26.38	20.46	5.92	≤13
		High	25.17	20.51	4.66	≤13
	50%	Low	26.96	20.81	6.15	≤13
		Mid	26.77	21.11	5.66	≤13
		High	25.70	20.53	5.17	≤13
	100%	Low	26.13	20.84	5.29	≤13
		Mid	26.06	21.17	4.89	≤13
		High	25.08	20.45	4.63	≤13
10	1L	Low	26.54	19.98	6.56	≤13

		Mid	26.89	19.64	7.25	≤13	
		High	25.92	19.90	6.02	≤13	
		Low	26.29	20.39	5.90	≤13	
	1H	Mid	26.41	20.38	6.03	≤13	
		High	25.08	19.88	5.20	≤13	
		Low	26.64	21.05	5.59	≤13	
	50%	Mid	26.68	21.41	5.27	≤13	
		High	26.03	20.85	5.18	≤13	
		Low	26.22	21.03	5.19	≤13	
	100%	Mid	26.10	21.26	4.84	≤13	
		High	25.22	20.76	4.46	≤13	
		Low	25.45	20.02	5.43	≤13	
	15	1L	Mid	25.64	21.01	4.63	≤13
			High	24.91	20.15	4.76	≤13
			Low	24.98	19.86	5.12	≤13
1H		Mid	24.85	19.43	5.42	≤13	
		High	23.94	19.40	4.54	≤13	
		Low	26.33	21.11	5.22	≤13	
50%		Mid	26.35	21.24	5.11	≤13	
		High	25.74	20.89	4.85	≤13	
		Low	26.49	20.81	5.68	≤13	
100%		Mid	26.38	21.03	5.35	≤13	
		High	25.84	20.76	5.08	≤13	
		Low	24.37	18.83	5.54	≤13	
20		1L	Mid	24.96	18.43	6.53	≤13
			High	24.42	18.26	6.16	≤13
			Low	24.13	20.13	4.00	≤13
	1H	Mid	23.67	18.91	4.76	≤13	
		High	22.93	17.80	5.13	≤13	
		Low	26.23	21.35	4.88	≤13	
	50%	Mid	26.36	21.15	5.21	≤13	
		High	25.95	21.03	4.92	≤13	
		Low	26.12	20.96	5.16	≤13	
	100%	Mid	26.10	19.60	6.50	≤13	
		High	25.75	20.98	4.77	≤13	
		Low	26.01	19.77	6.24	≤13	

Table 11: 16-QAM Modulation RF Out Put Power Conducted ModeTest results

TDD Band 41, Modulation- 16-QAM						
Channel Bandwidth (MHz)	Resource Block Allocation	Channel	Peak Output Power (dBm)	Average Output Power (dBm)	PAPR (dB)	PAPR Limit (dB)
5	1L	Low	26.75	20.47	6.28	≤13
		Mid	26.16	20.26	5.90	≤13
		High	25.61	21.15	4.46	≤13
	1H	Low	26.53	19.70	6.83	≤13
		Mid	26.01	19.77	6.24	≤13

	50%	High	26.39	20.42	5.97	≤13	
		Low	26.95	20.40	6.55	≤13	
		Mid	26.72	20.38	6.34	≤13	
	100%	High	25.92	19.64	6.28	≤13	
		Low	26.97	19.99	6.98	≤13	
		Mid	26.54	20.19	6.35	≤13	
	10	1L	High	25.37	19.58	5.79	≤13
			Low	26.82	18.94	7.88	≤13
			Mid	26.54	19.42	7.12	≤13
1H		High	26.02	18.42	7.60	≤13	
		Low	26.27	17.95	8.32	≤13	
		Mid	26.11	19.22	6.89	≤13	
50%		High	25.40	19.21	6.19	≤13	
		Low	26.91	20.15	6.76	≤13	
		Mid	26.91	20.45	6.46	≤13	
100%		High	26.21	20.05	6.16	≤13	
		Low	26.45	20.12	6.33	≤13	
		Mid	26.62	20.36	6.26	≤13	
15		1L	High	25.59	19.88	5.71	≤13
			Low	25.70	19.85	5.85	≤13
			Mid	25.82	19.38	6.44	≤13
	1H	High	24.84	20.26	4.58	≤13	
		Low	25.14	18.29	6.85	≤13	
		Mid	25.21	18.70	6.51	≤13	
	50%	High	23.95	19.57	4.38	≤13	
		Low	26.64	20.34	6.30	≤13	
		Mid	26.95	20.24	6.71	≤13	
	100%	High	25.99	19.97	6.02	≤13	
		Low	26.62	20.04	6.58	≤13	
		Mid	26.60	20.12	6.48	≤13	
	20	1L	High	26.20	19.91	6.29	≤13
			Low	24.66	18.31	6.35	≤13
			Mid	24.60	18.50	6.10	≤13
1H		High	24.64	17.39	7.25	≤13	
		Low	26.04	19.08	6.96	≤13	
		Mid	23.62	17.75	5.87	≤13	
50%		High	22.97	17.96	5.01	≤13	
		Low	26.28	20.42	5.86	≤13	
		Mid	26.75	20.15	6.60	≤13	
100%		High	26.07	21.21	4.86	≤13	
		Low	26.38	19.98	6.40	≤13	
		Mid	26.57	20.02	6.55	≤13	
			High	26.24	20.14	6.10	≤13

7.2 Occupied Bandwidth and 26 dB Bandwidth

Result

Pass

Specification FCC Part §2.1049

Measurement Bandwidth (RBW) ≥ OBW

Detector Function Peak

Test Setup:

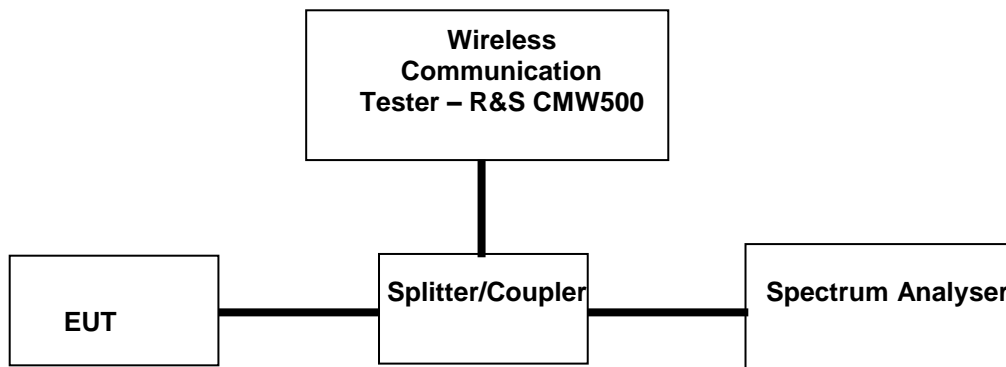

Note: For measurement of occupied bandwidth, sub clause 4.1 & 4.3 of “971168 D01 Power Meas License Digital Systems v03” was used.

Test Results

Table 12: QPSK Modulation Occupied Bandwidth and -26dB Bandwidth Test results

Modulation: QPSK				
TDD Band	Bandwidth	Channel	99% Occupied Bandwidth (MHz)	-26dB Bandwidth(MHz)
41	5	Low	4.507	5.010
		Mid	4.507	4.974
		High	4.518	5.024
	10	Low	8.925	9.758
		Mid	8.923	9.702
		High	8.921	9.646
	15	Low	13.418	16.275
		Mid	13.473	15.412
		High	13.412	14.767
	20	Low	17.866	19.279
		Mid	17.877	19.378
		High	17.818	19.262

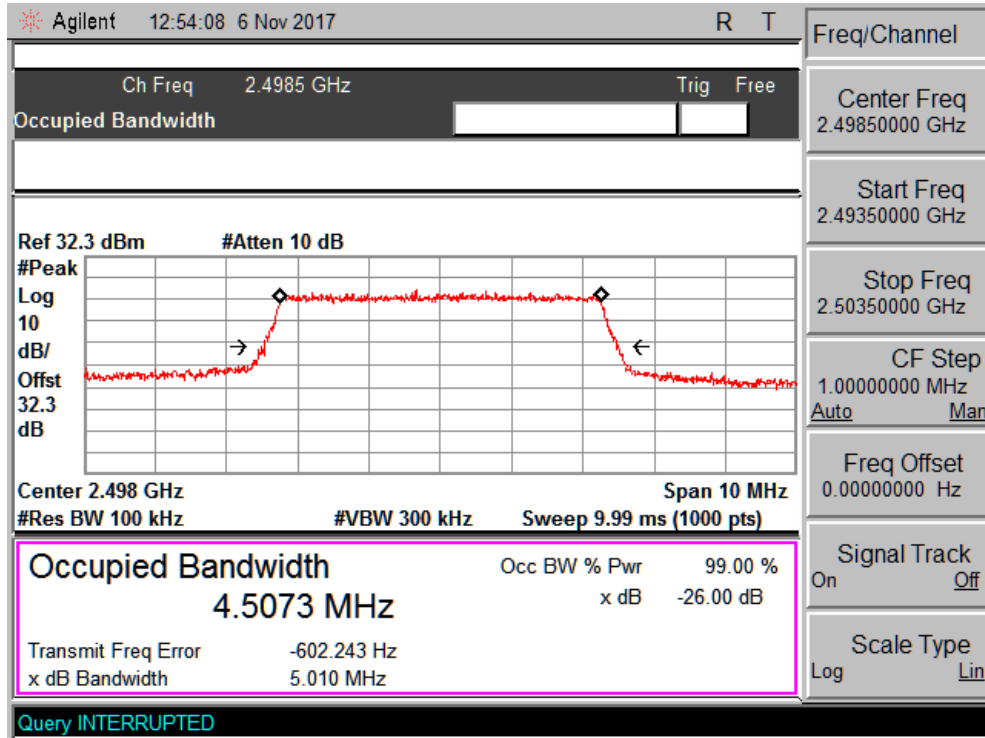

Channel Low_5MHz Bandwidth

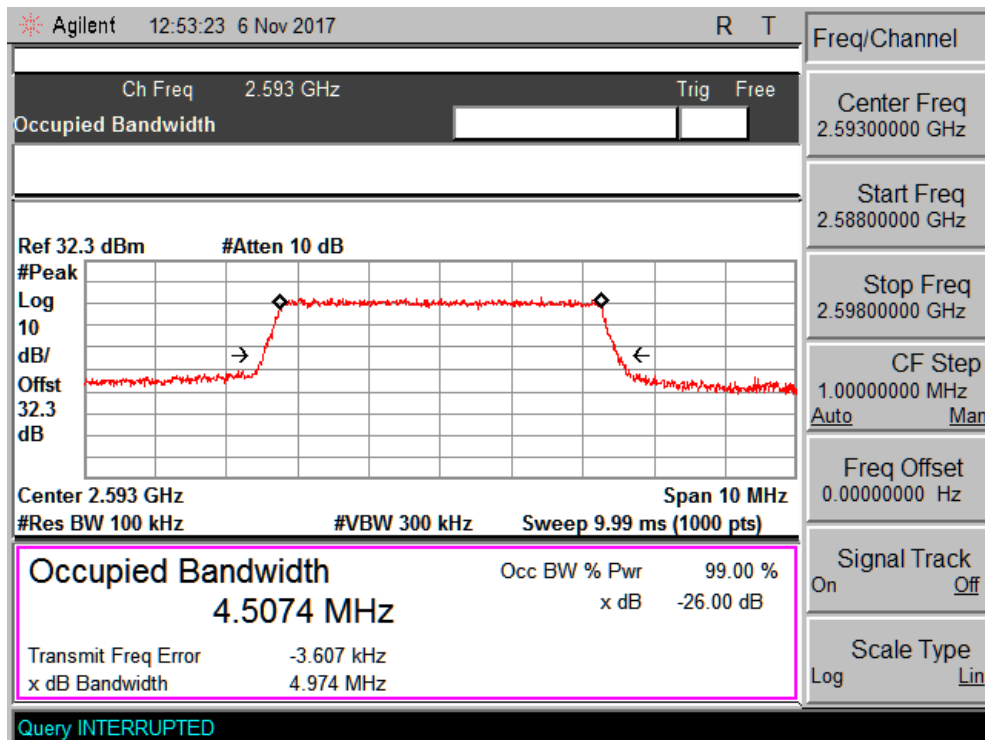

Channel Mid_5MHz Bandwidth

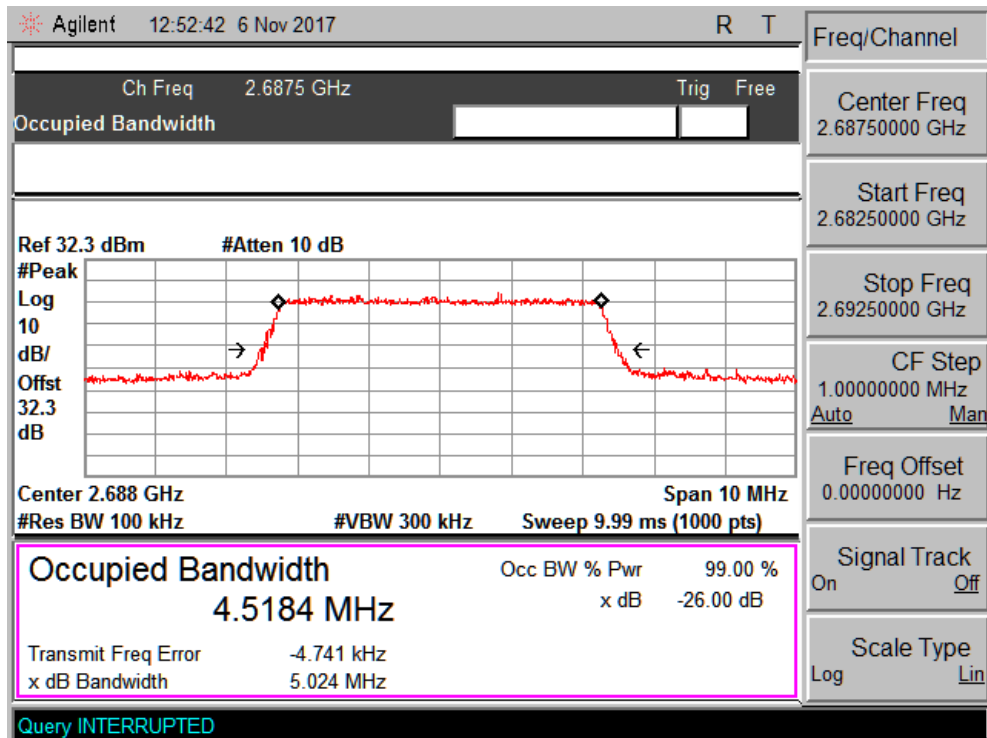

Channel High_5MHz Bandwidth

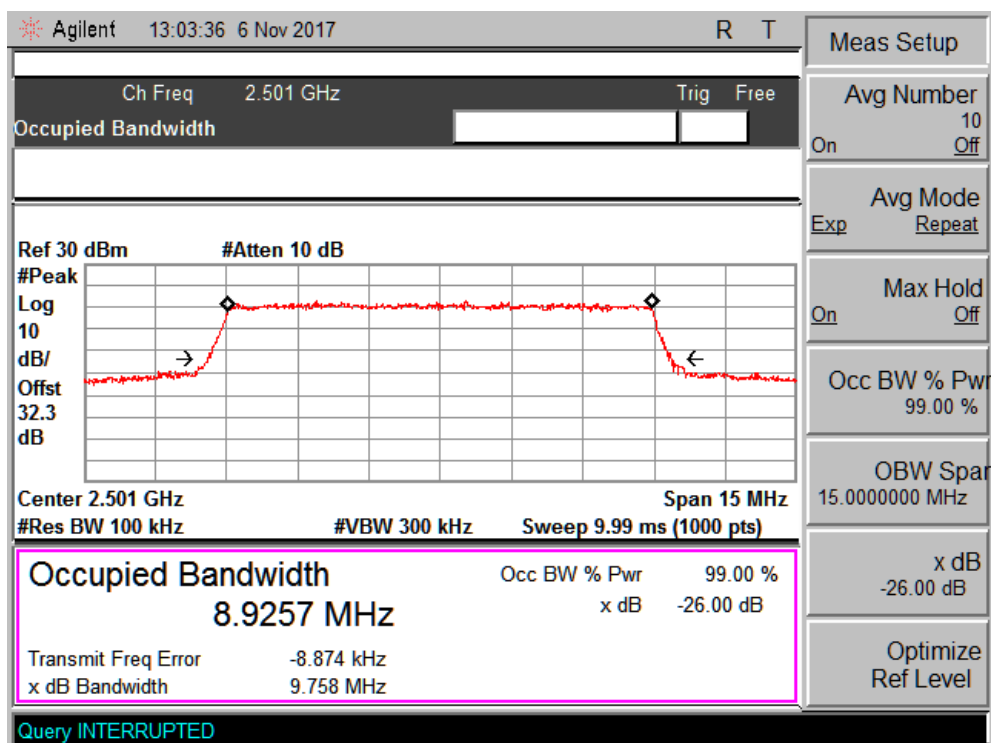

Channel Low_10MHz Bandwidth

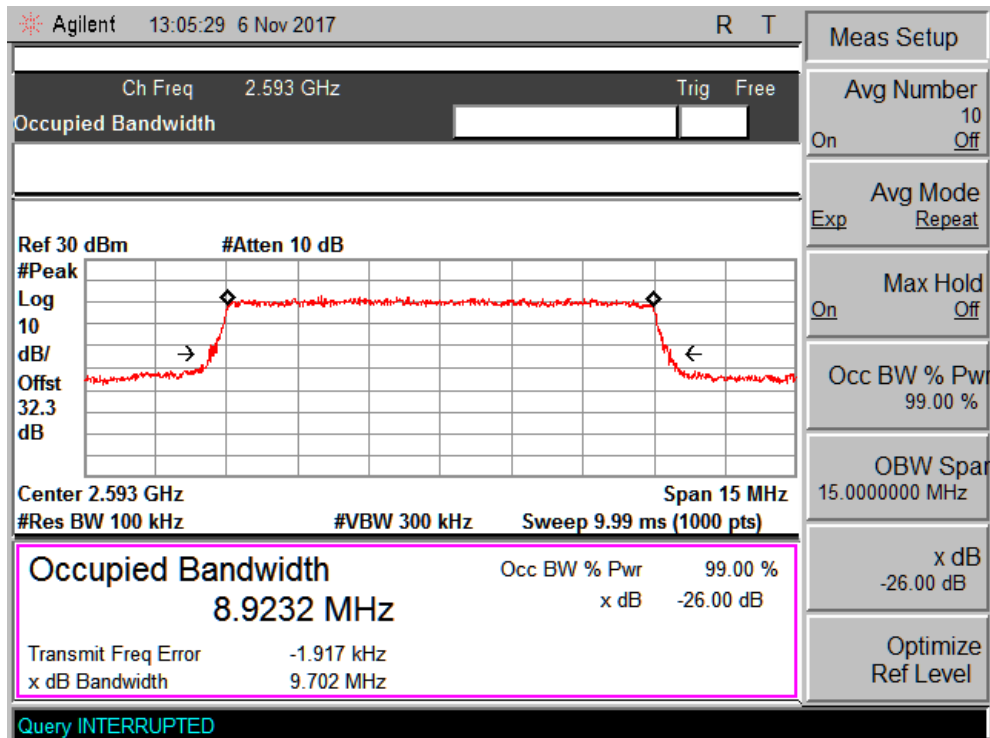

Channel Mid_10MHz Bandwidth

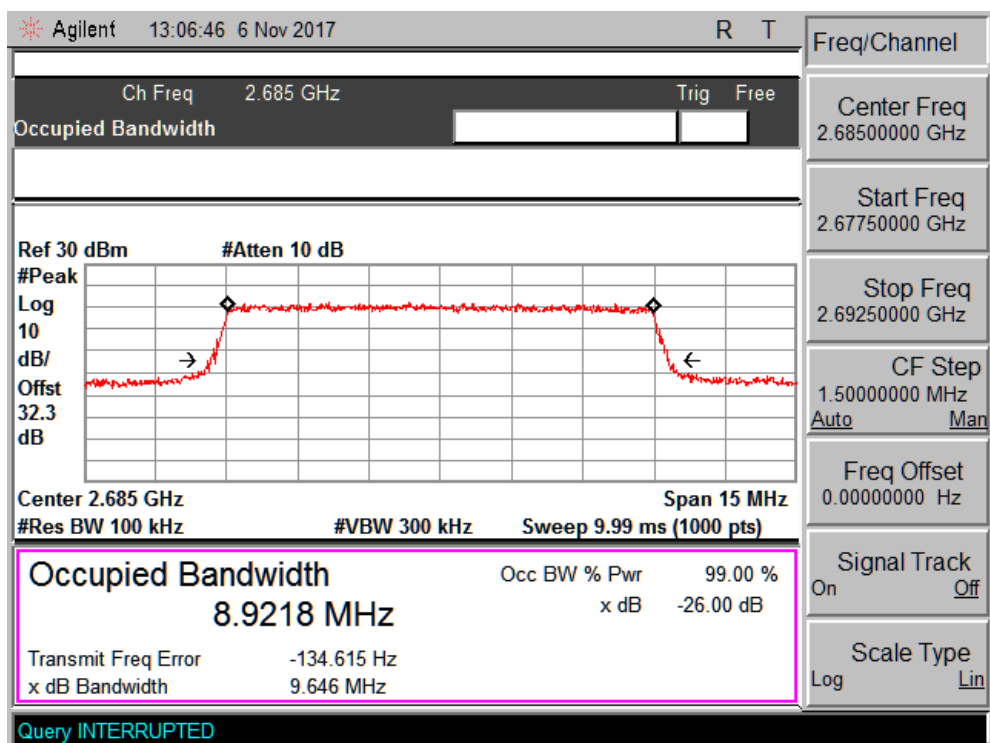

Channel High_10MHz Bandwidth

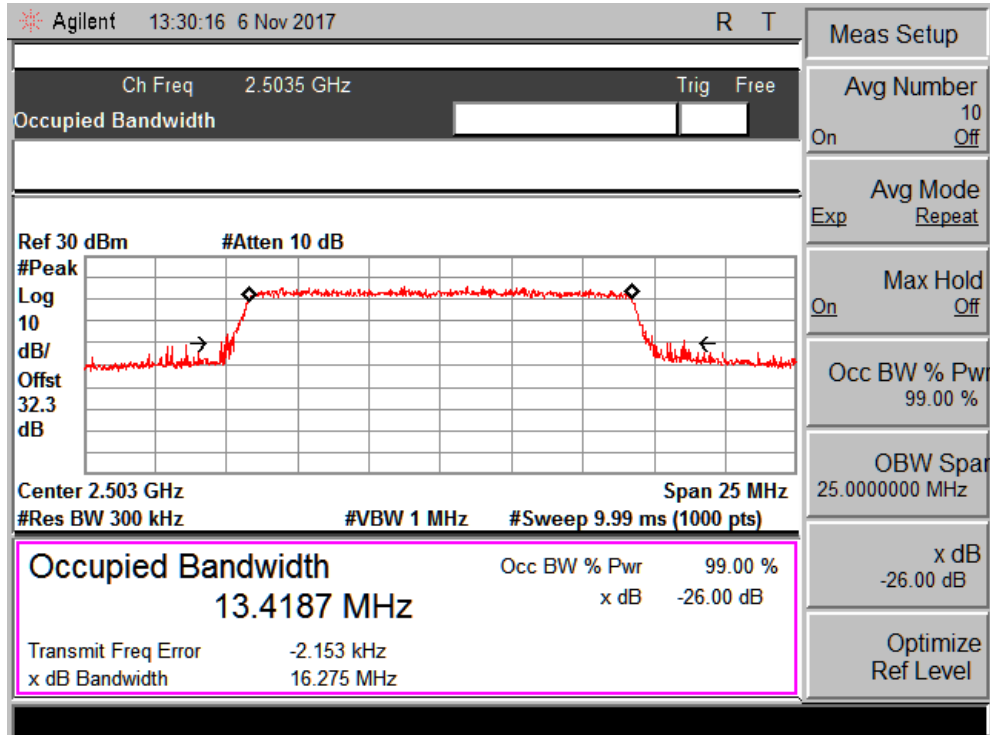

Channel Low_15MHz Bandwidth

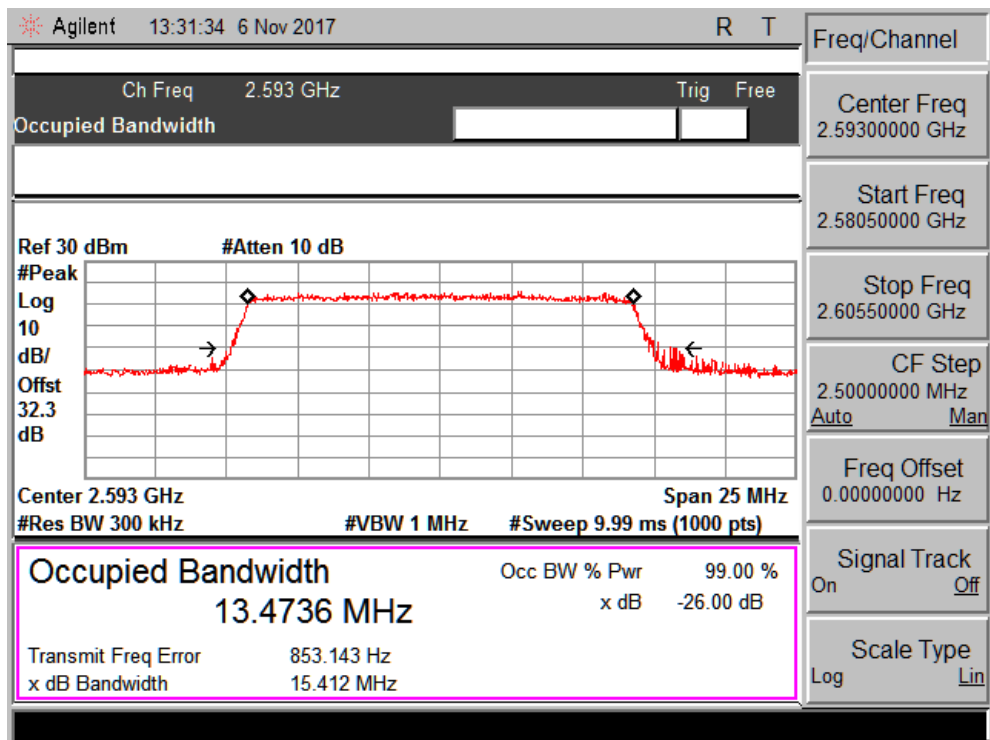

Channel Mid_15MHz Bandwidth

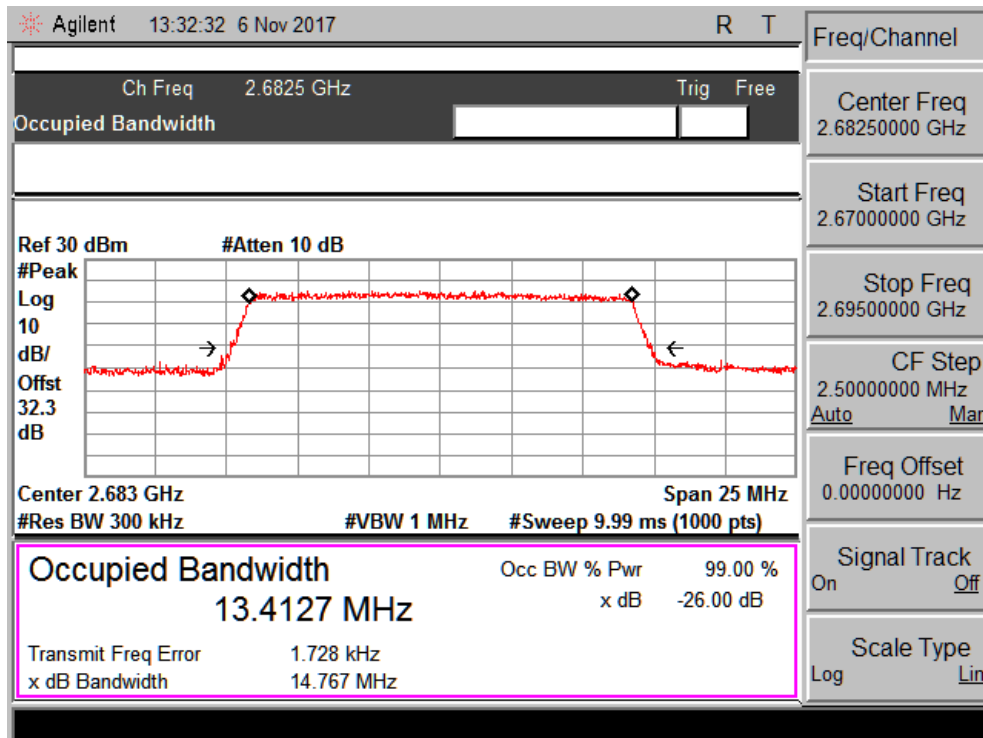

Channel High_15MHz Bandwidth

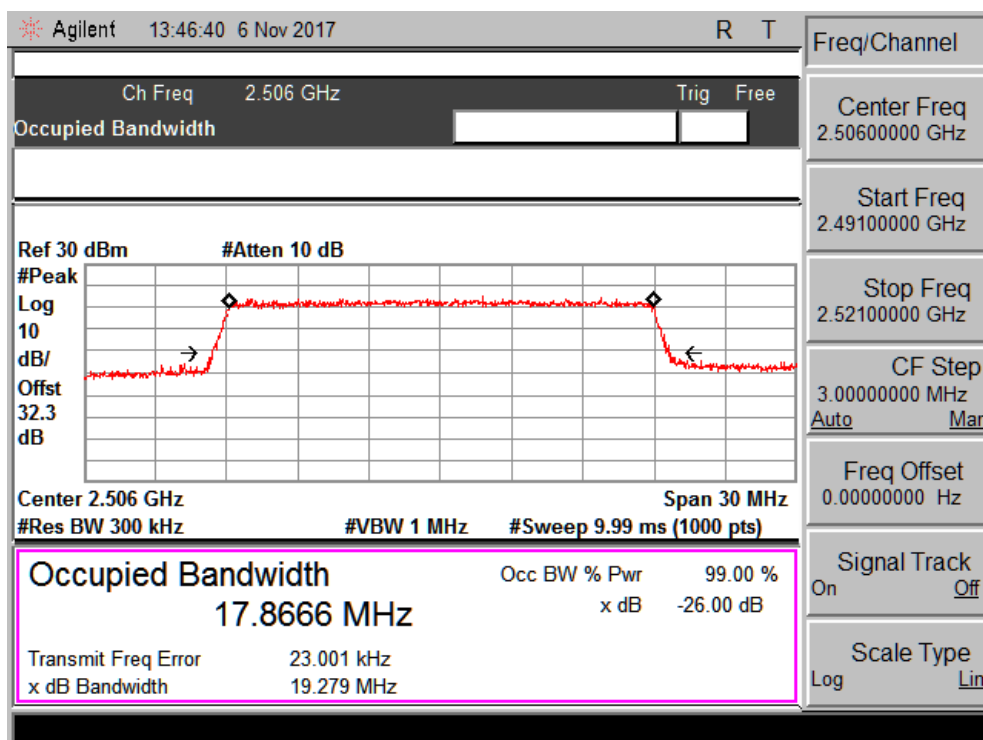

Channel Low_20MHz Bandwidth

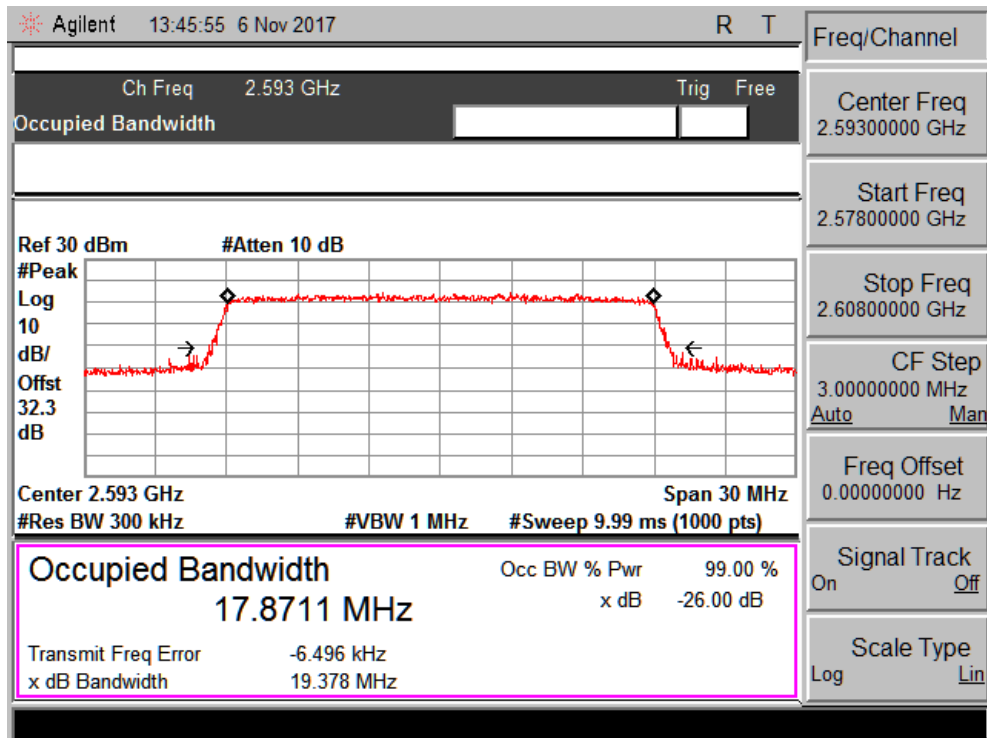

Channel Mid_20MHz Bandwidth

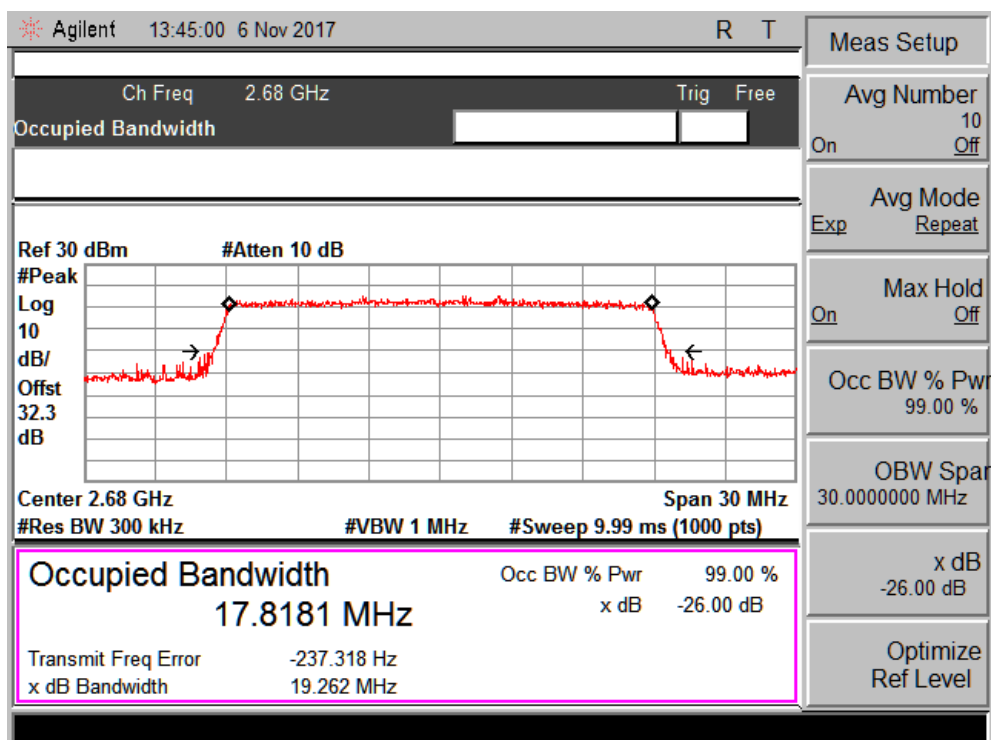

Channel High_20MHz Bandwidth

Table 13: QPSK Modulation Occupied Bandwidth and -26dB Bandwidth Test results

Modulation: 16-QAM				
TDD Band	Bandwidth	Channel	99% Occupied Bandwidth (MHz)	-26dB Bandwidth(MHz)
41	5	Low	4.504	4.972
		Mid	4.506	5.018
		High	4.508	5.033
	10	Low	8.914	9.650
		Mid	8.909	9.593
		High	8.919	9.650
	15	Low	14.458	15.307
		Mid	13.437	14.782
		High	13.466	14.829
	20	Low	17.856	20.149
		Mid	17.843	19.836
		High	17.856	21.417

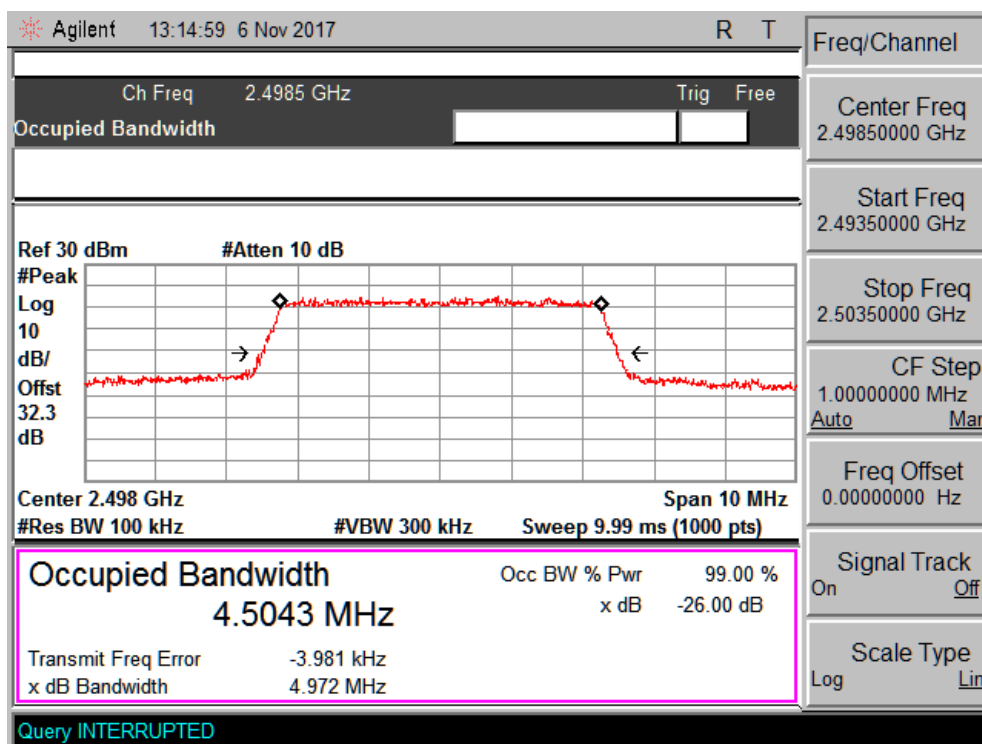

Channel Low_5MHz Bandwidth

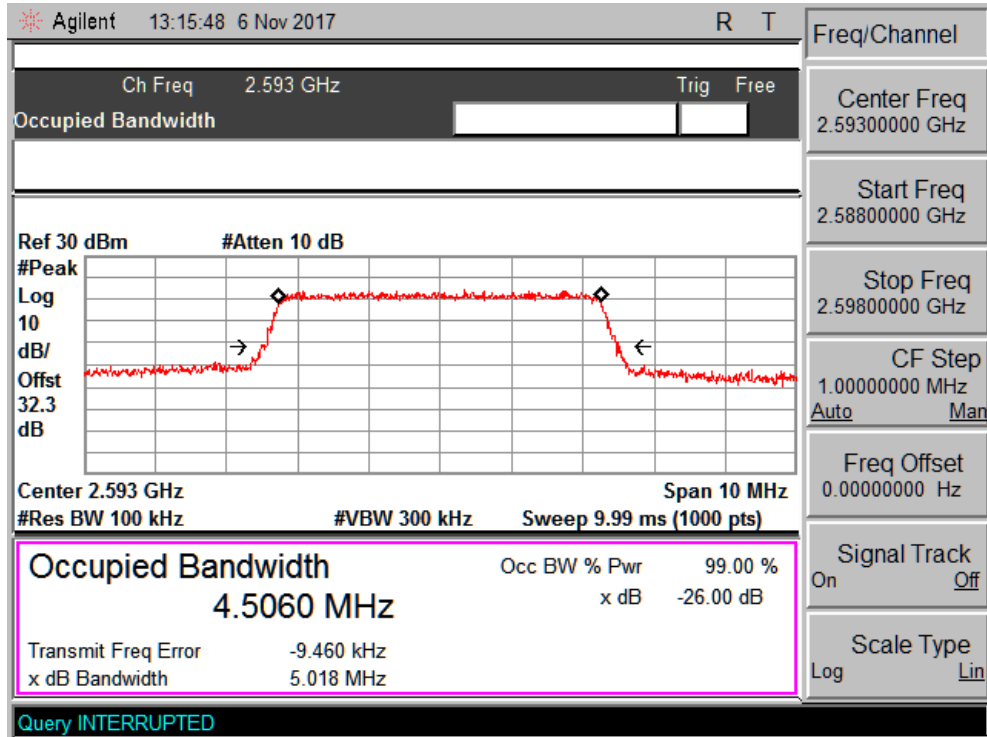

Channel Mid_5MHz Bandwidth

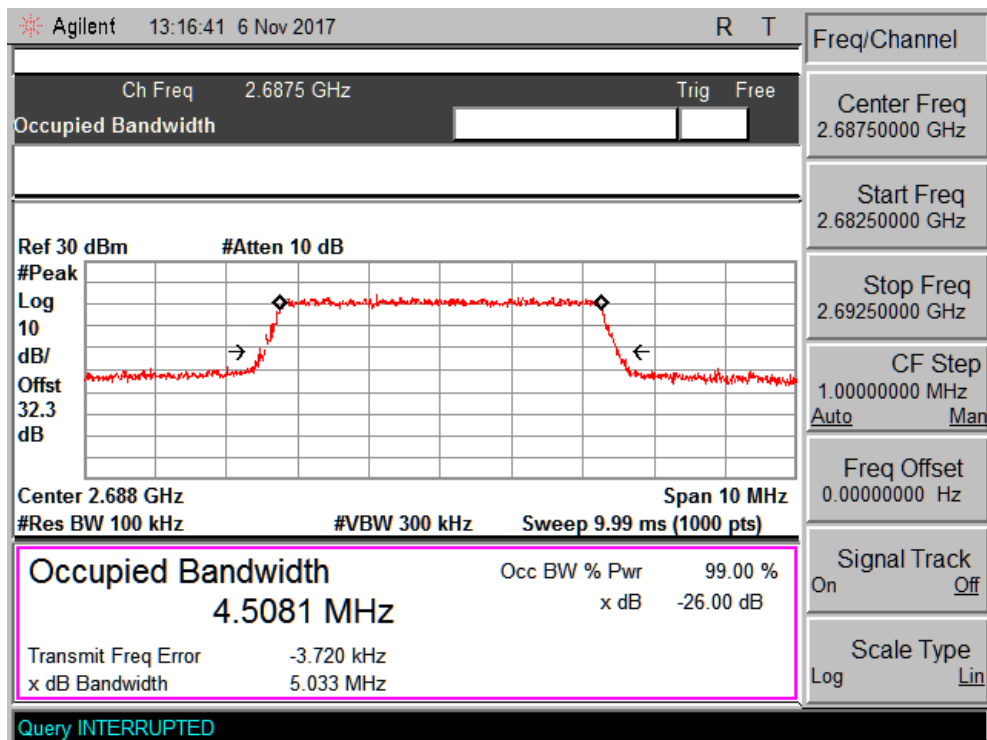

Channel High_5MHz Bandwidth

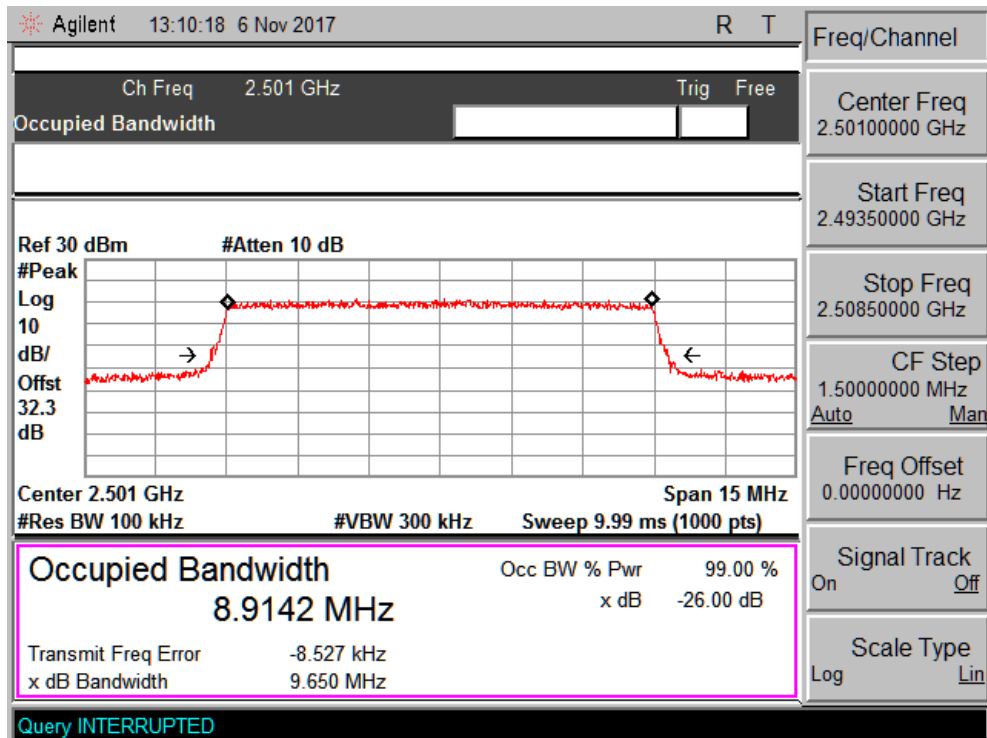

Channel Low_10MHz Bandwidth

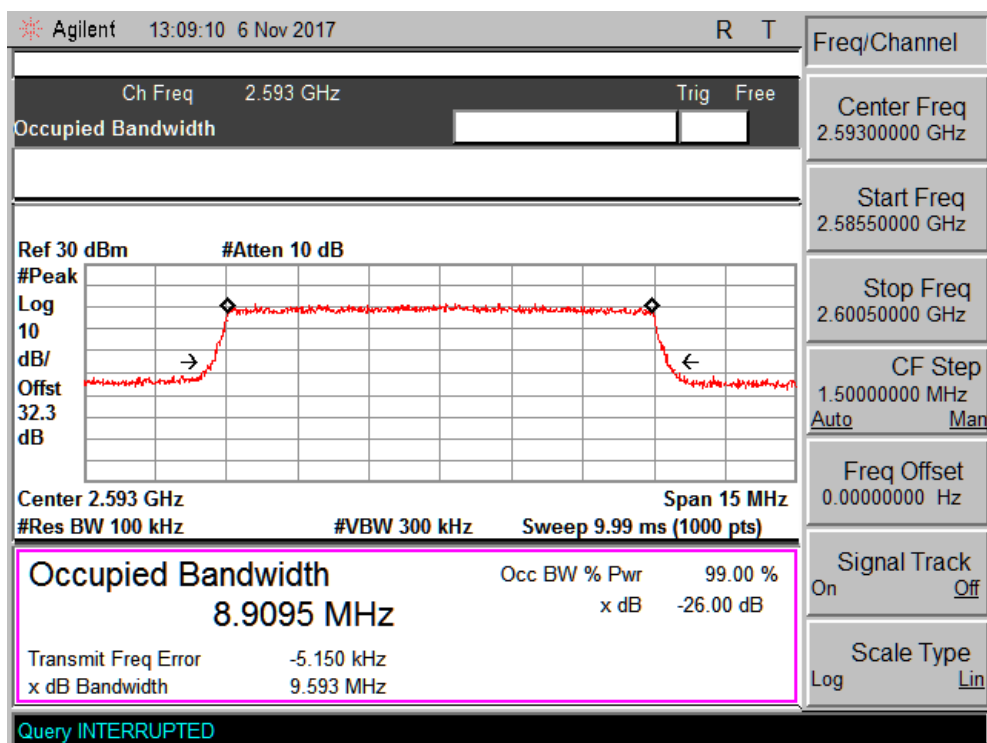

Channel Mid_10MHz Bandwidth

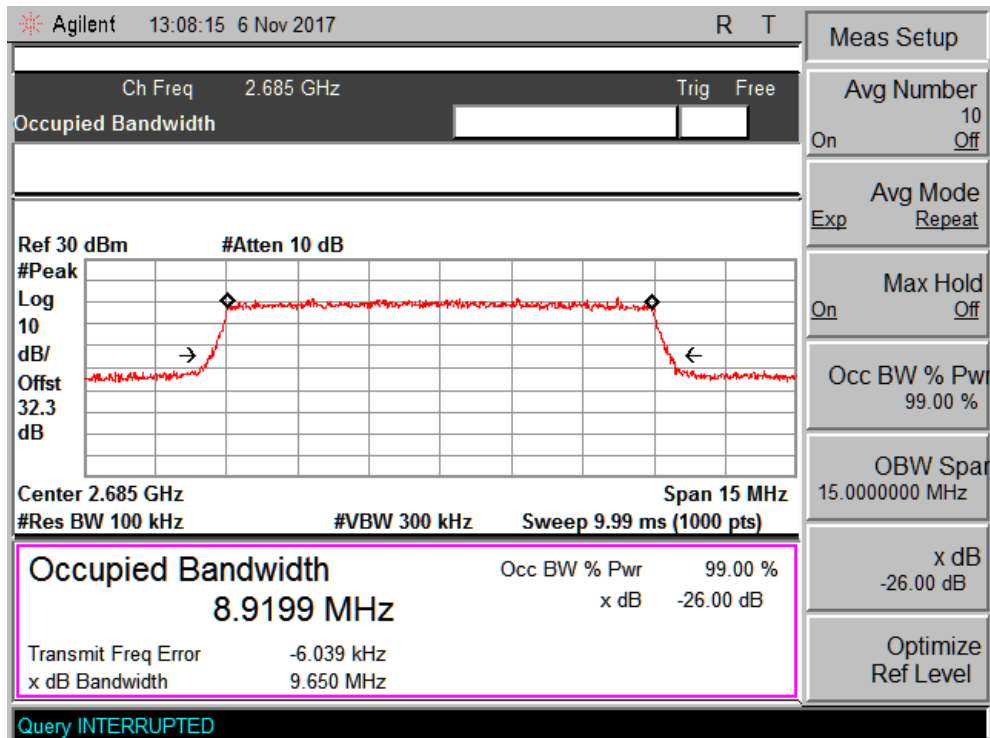

Channel High_10MHz Bandwidth

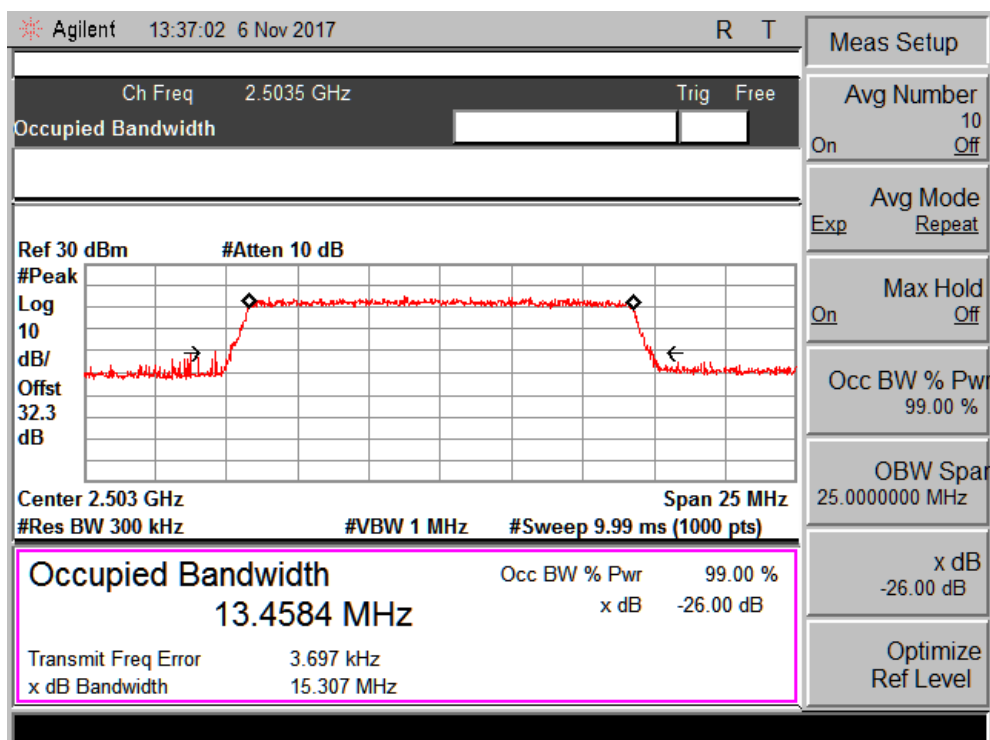

Channel Low_15MHz Bandwidth

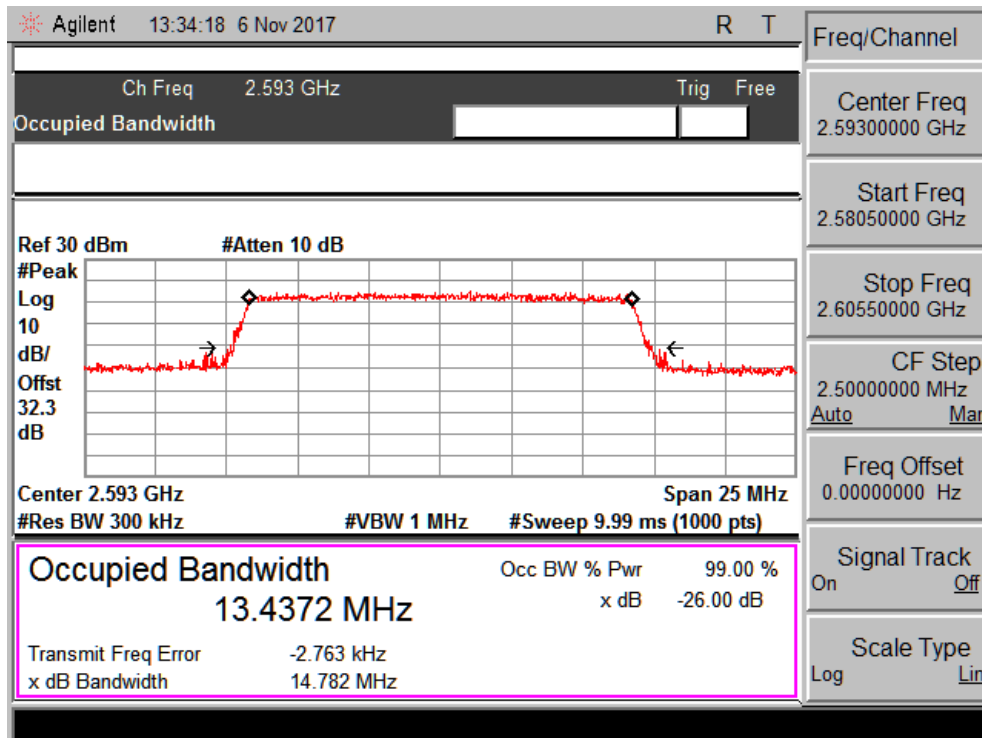

Channel Mid_15MHz Bandwidth

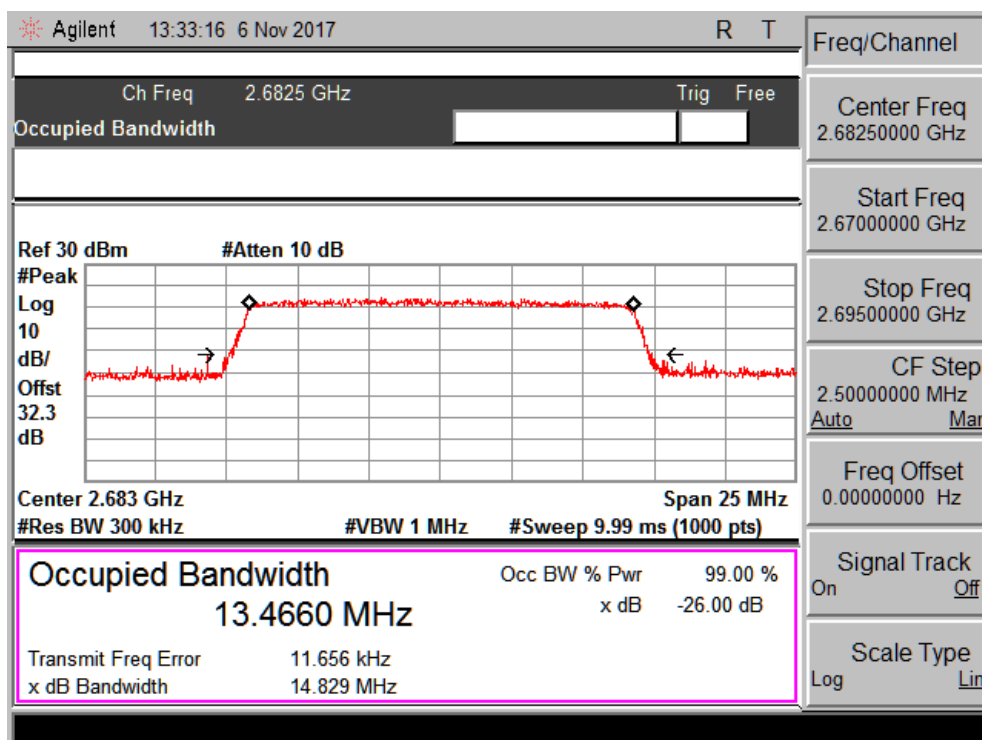

Channel High_15MHz Bandwidth

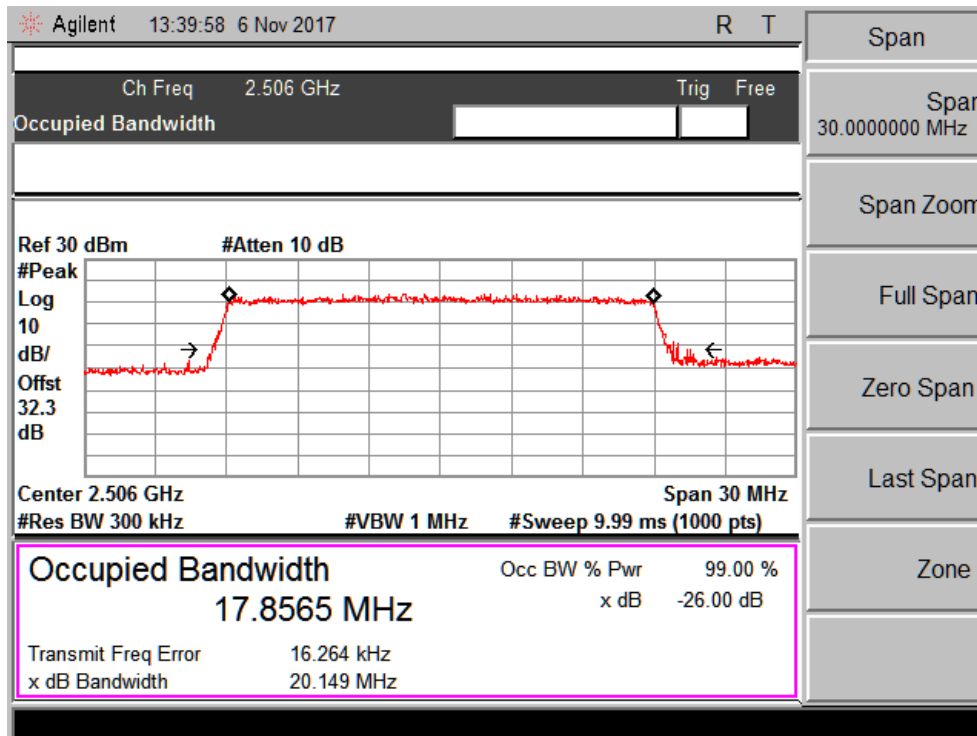

Channel Low_20MHz Bandwidth

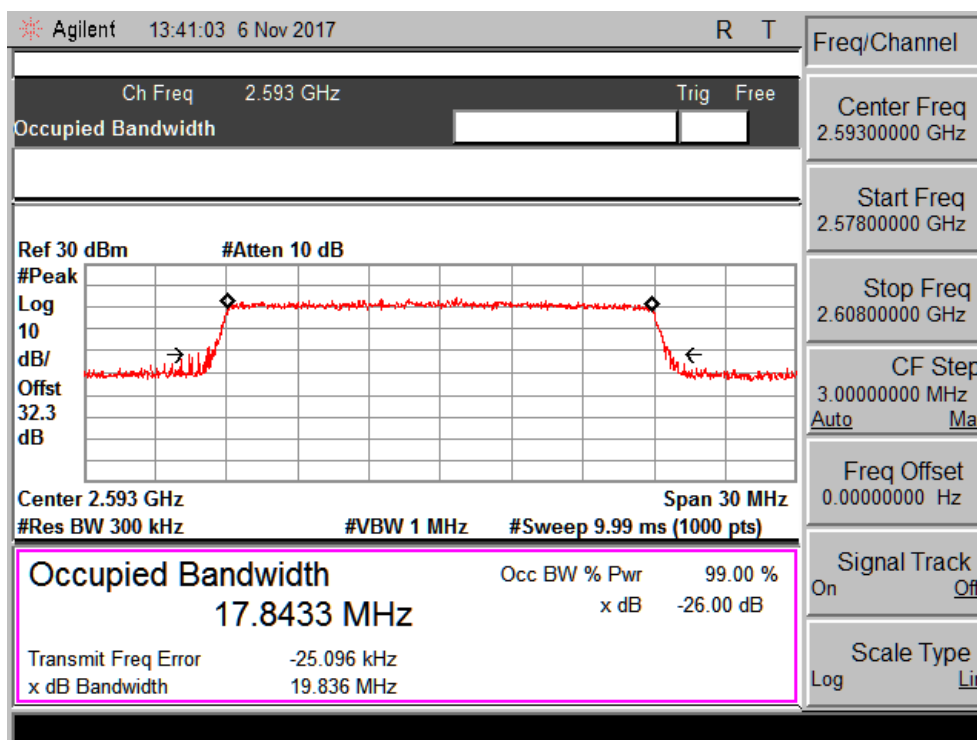

Channel Mid_20MHz Bandwidth

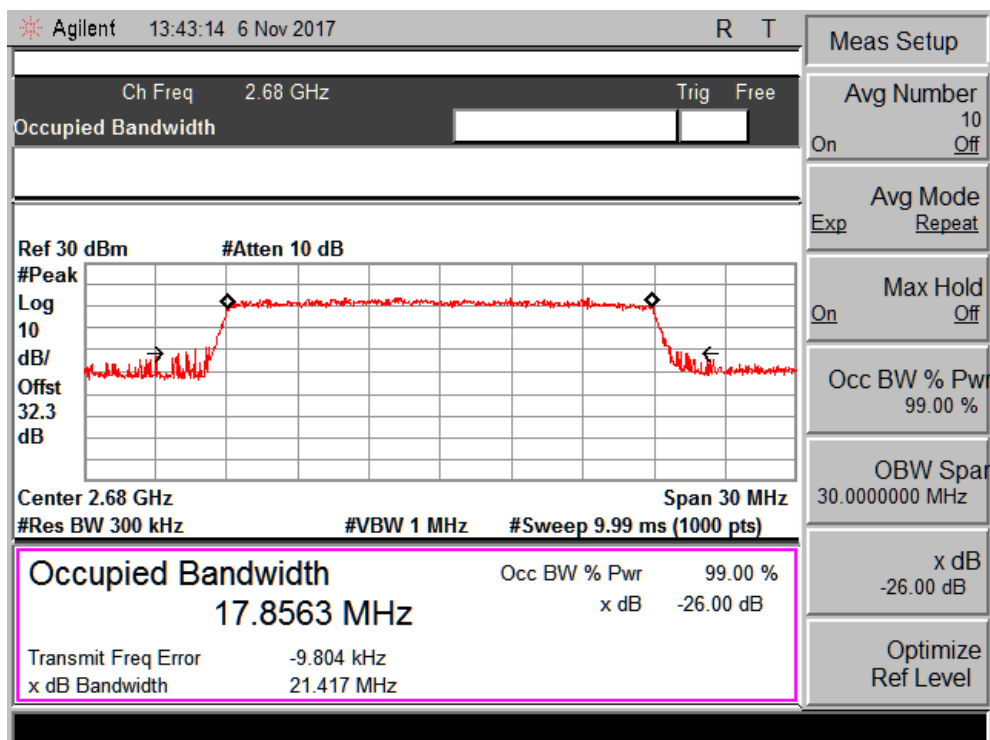

Channel High_20MHz Bandwidth

8 Band Edge Compliance

Result

Pass

Specification	FCC Part §2.1051, §27.53(m)(2)(V)
Measurement Bandwidth (RBW)	1% of the OBW
Detector Function	Average

Test Setup:

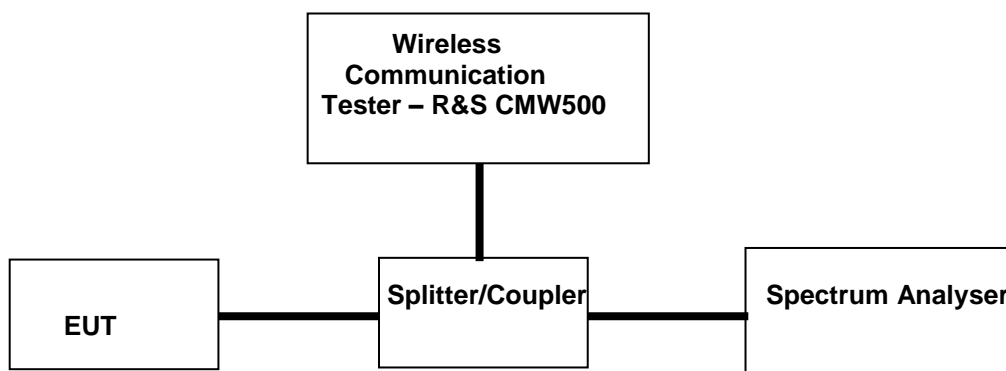

Note: For measurement of Band Edge compliance, sub clause 6.0 of “971168 D01 Power Meas License Digital Systems v03” & 971168 D02 Misc Rev Approv License Devices v02r01 was used. Attenuator & Cable loss included in the test results.

Test Results:

QPSK results

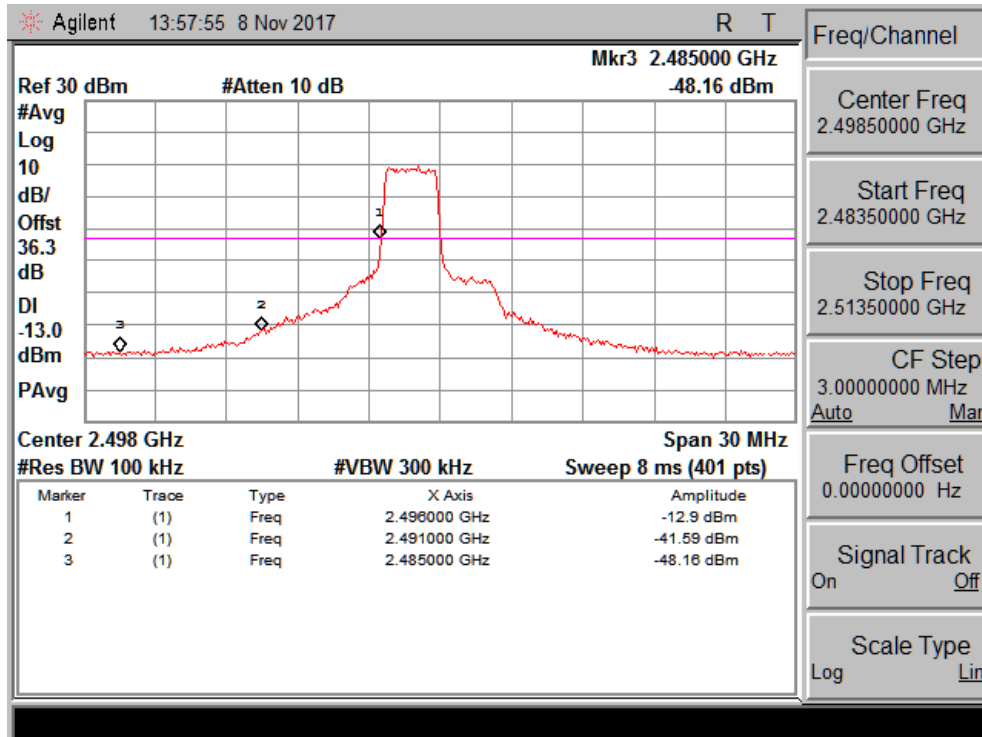

Channel Low_5MHz Bandwidth

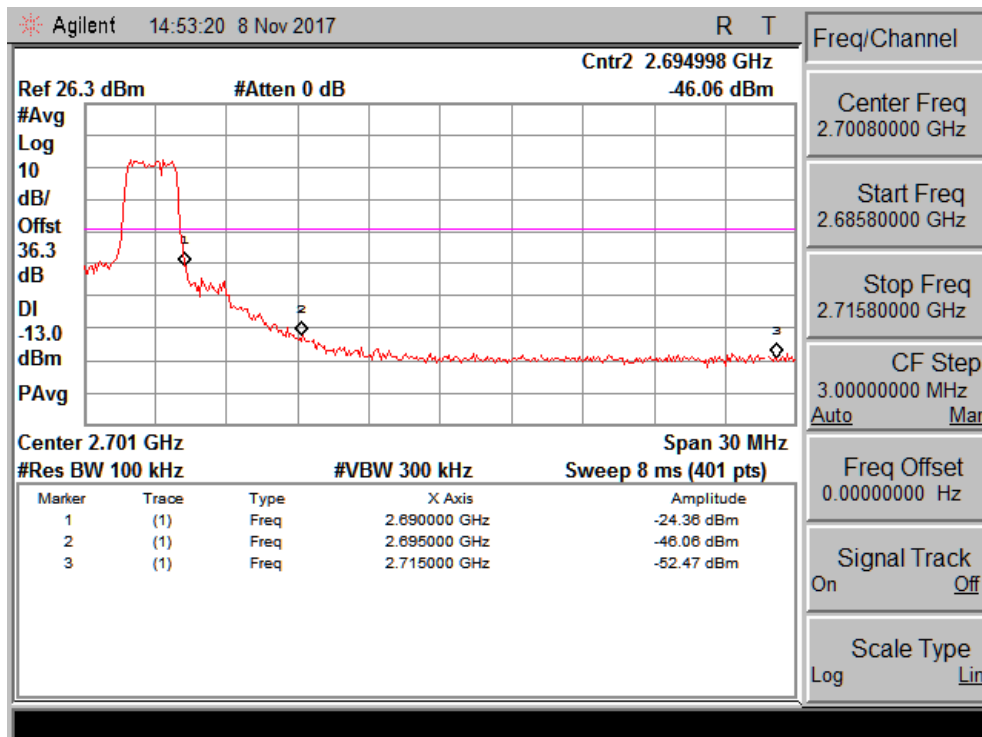

Channel High_5MHz Bandwidth

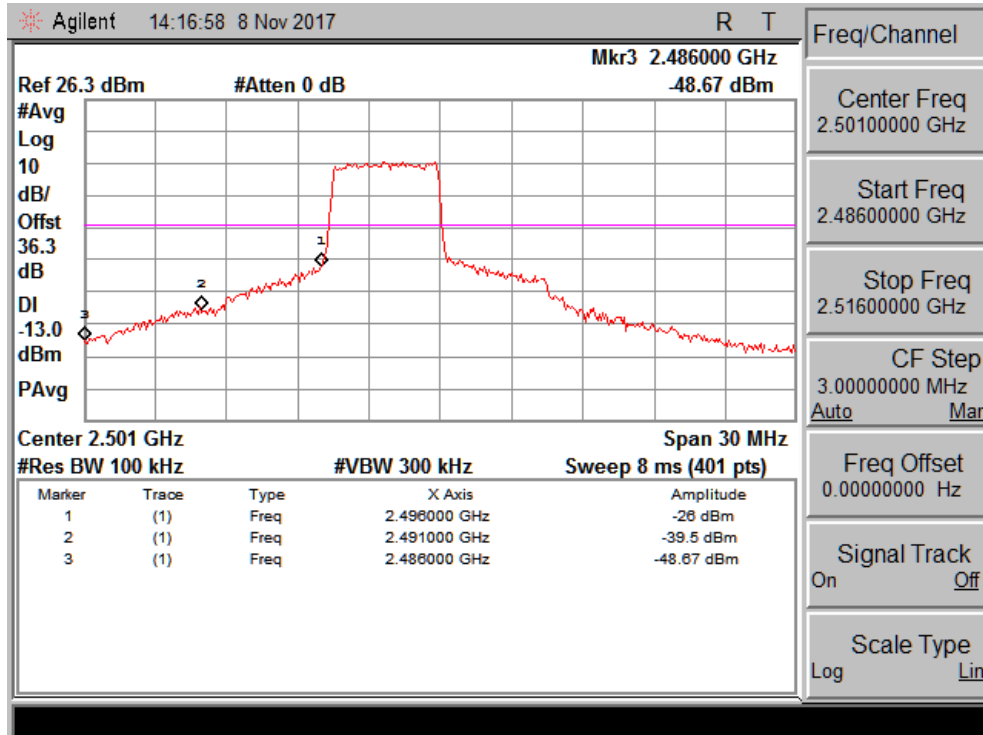

Channel Low_10MHz Bandwidth

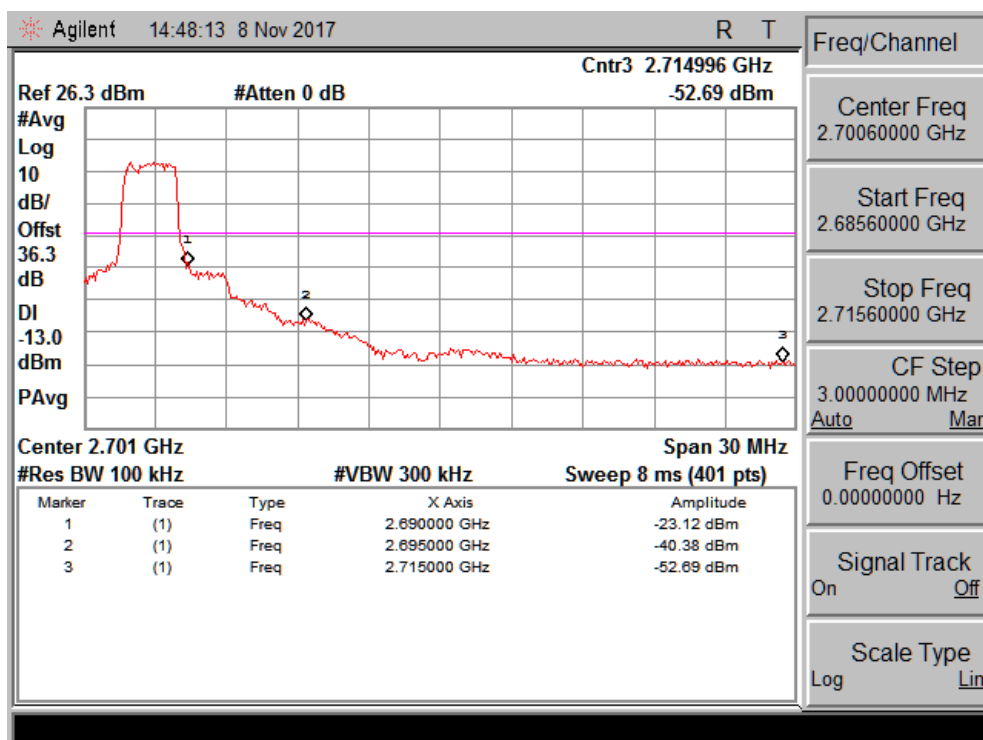

Channel High_10MHz Bandwidth

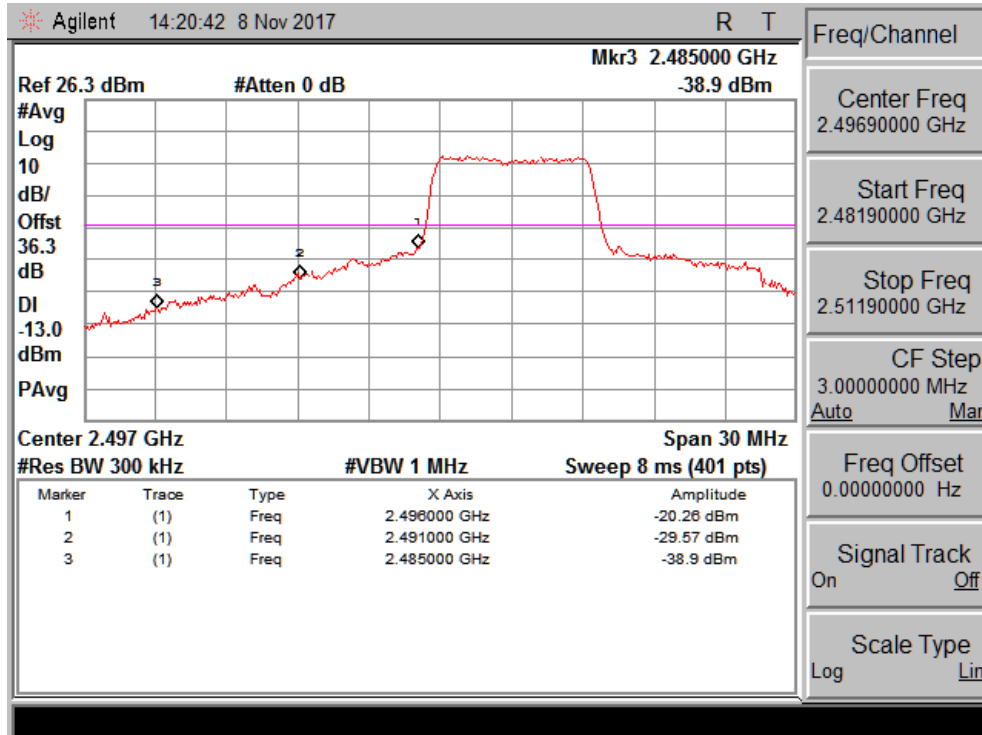

Channel Low_15MHz Bandwidth

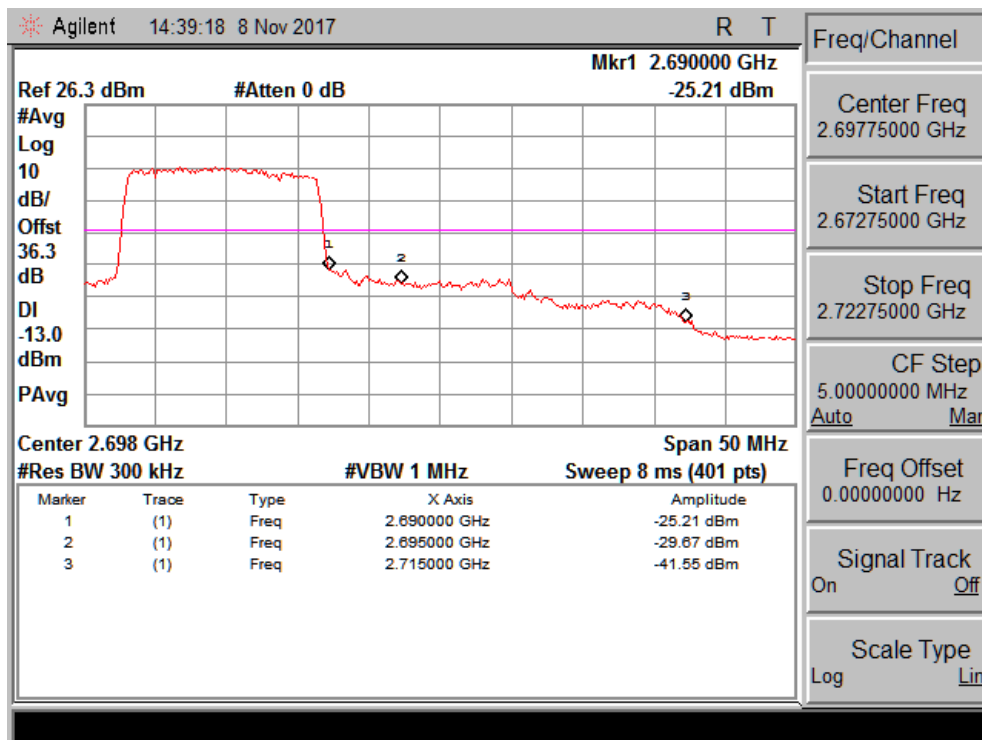

Channel High_15MHz Bandwidth

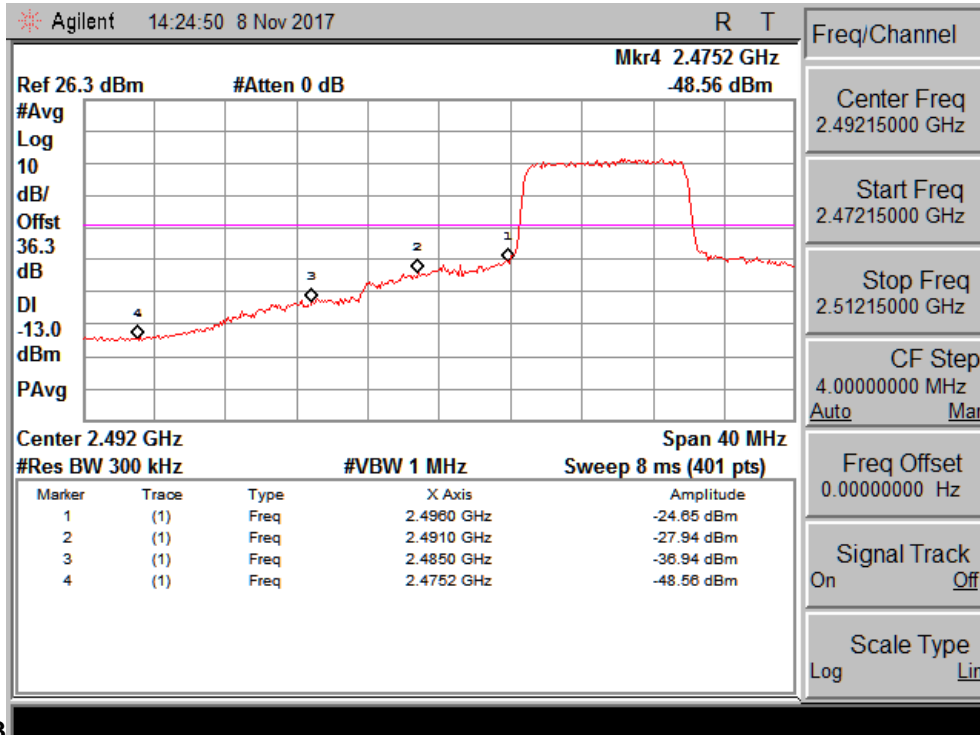

13

Channel Low_20MHz Bandwidth

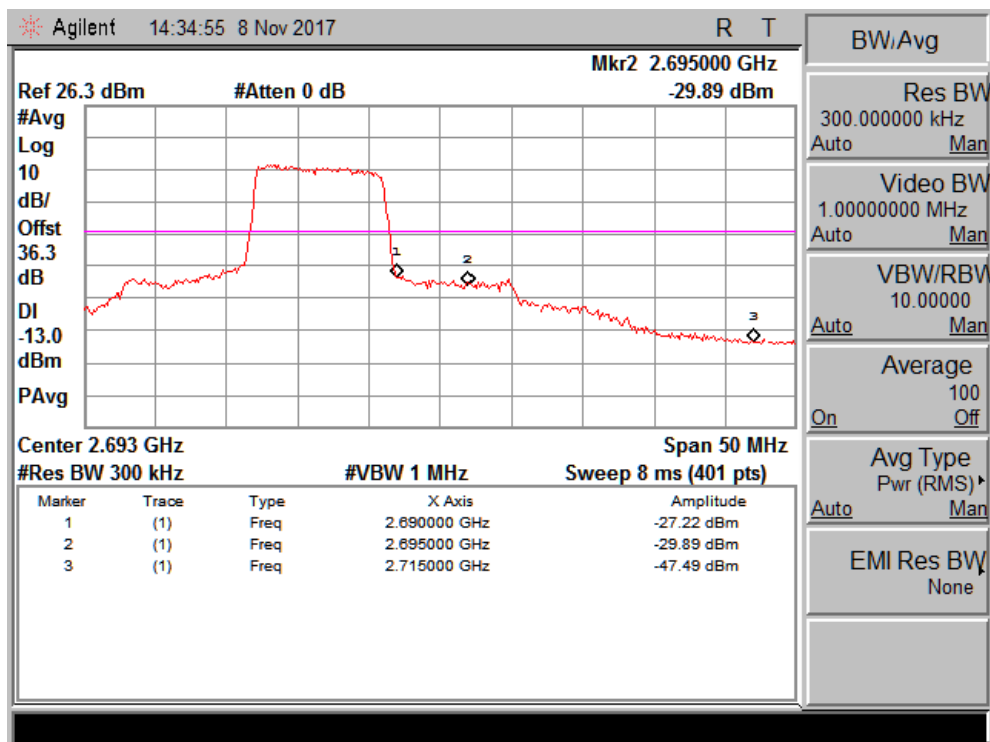

Channel High_20MHz Bandwidth

16-QAM Results

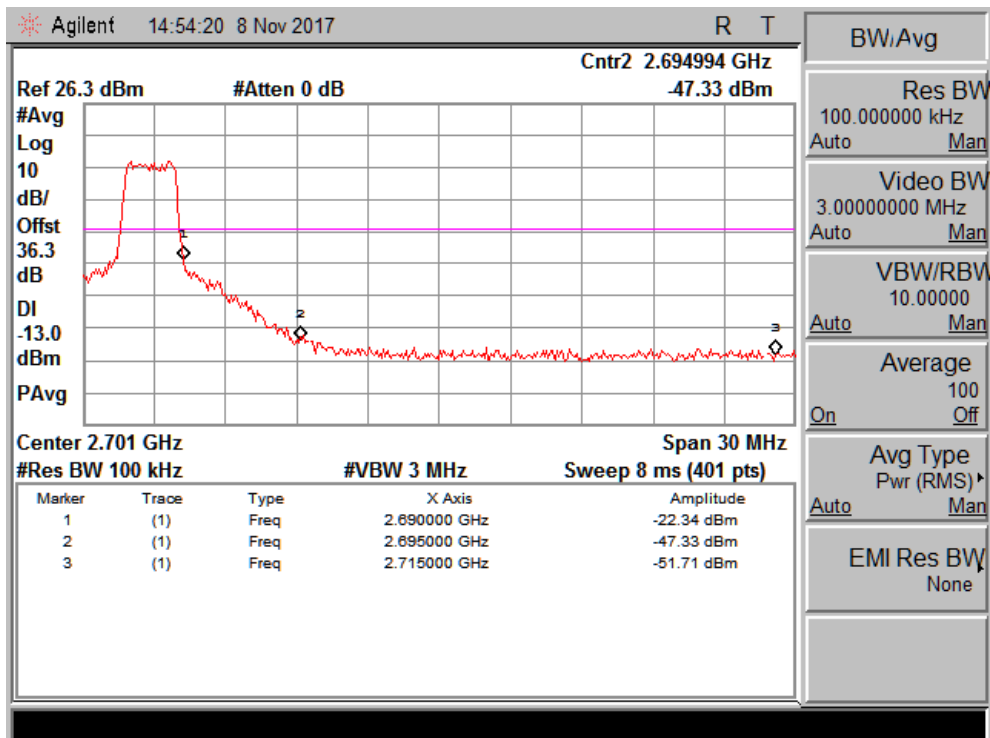
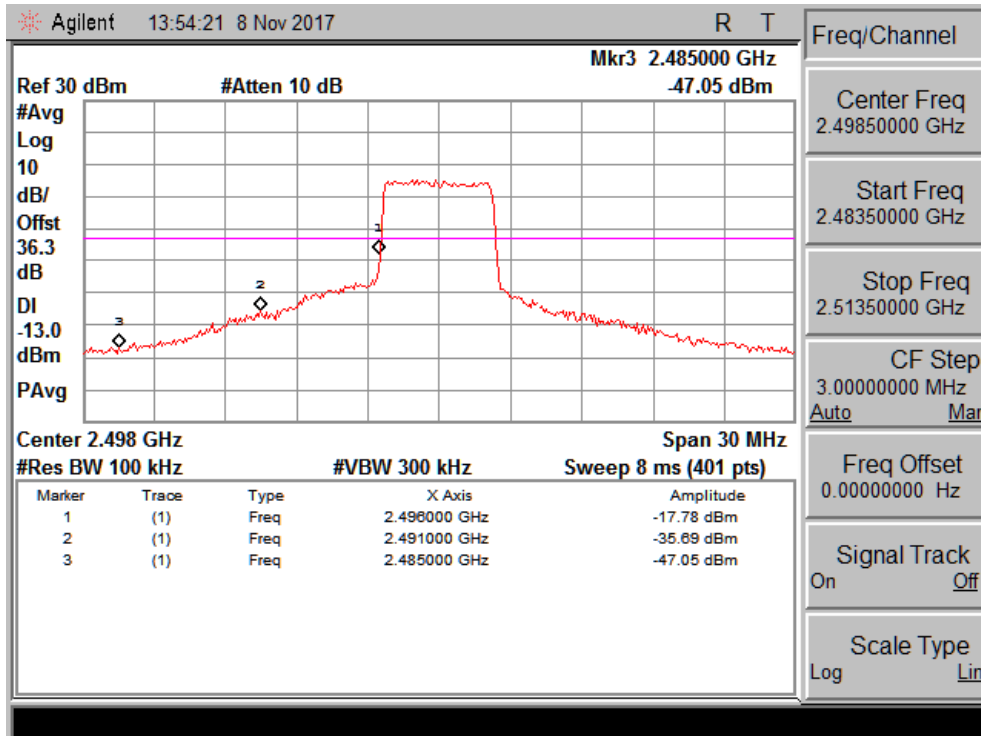

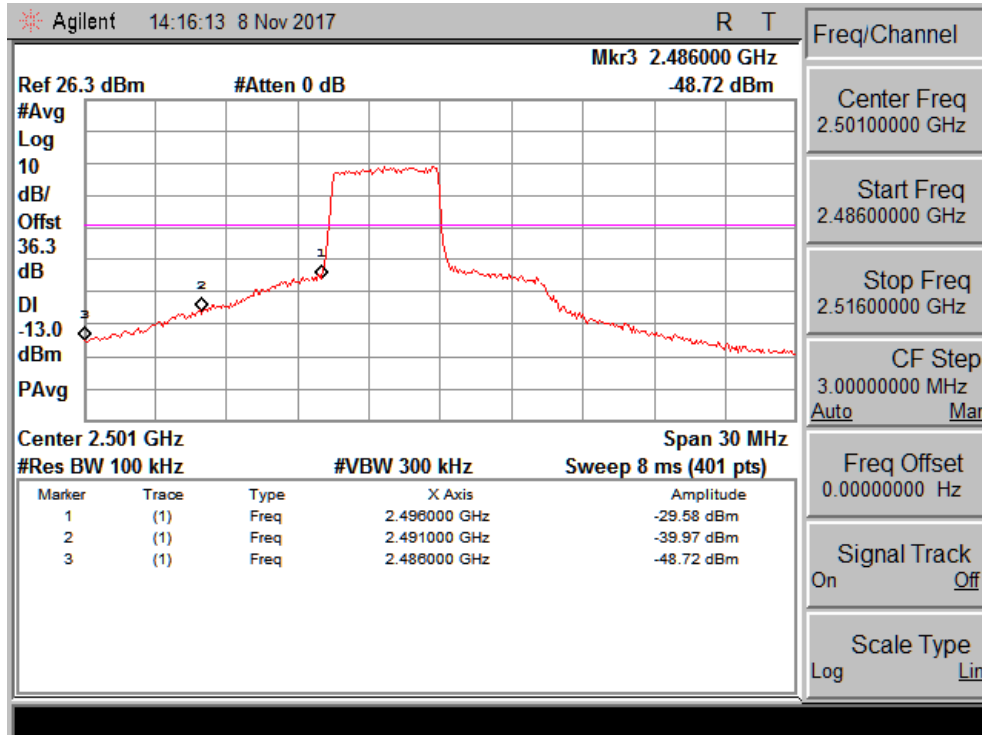

Channel Low_10MHz Bandwidth

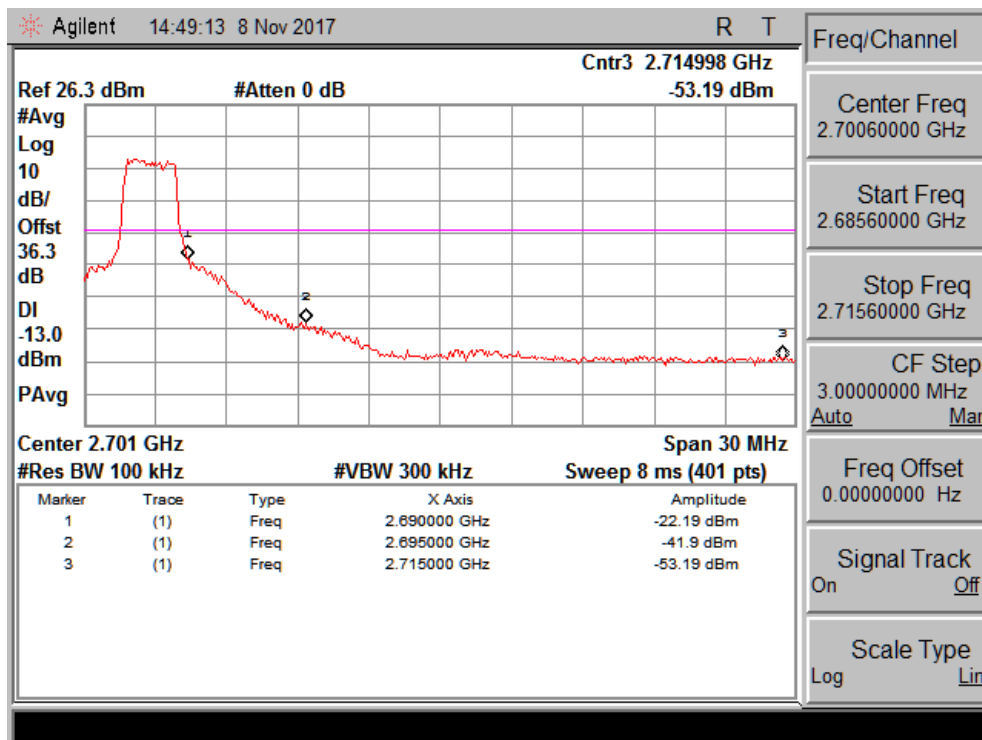

Channel High_10MHz Bandwidth

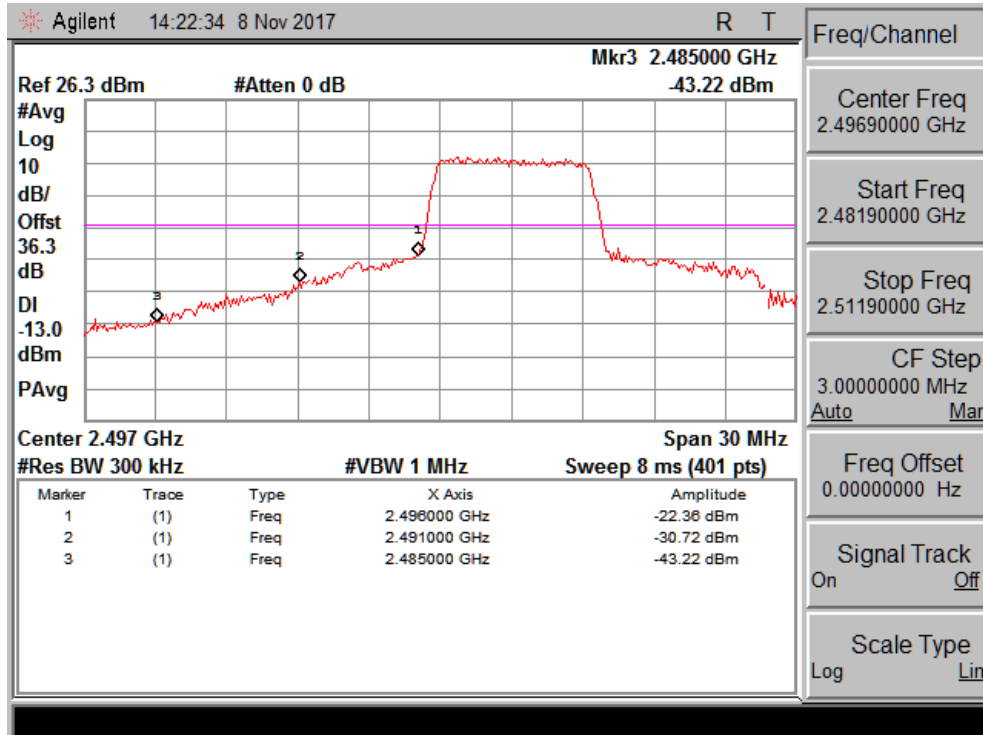

Channel Low_15MHz Bandwidth

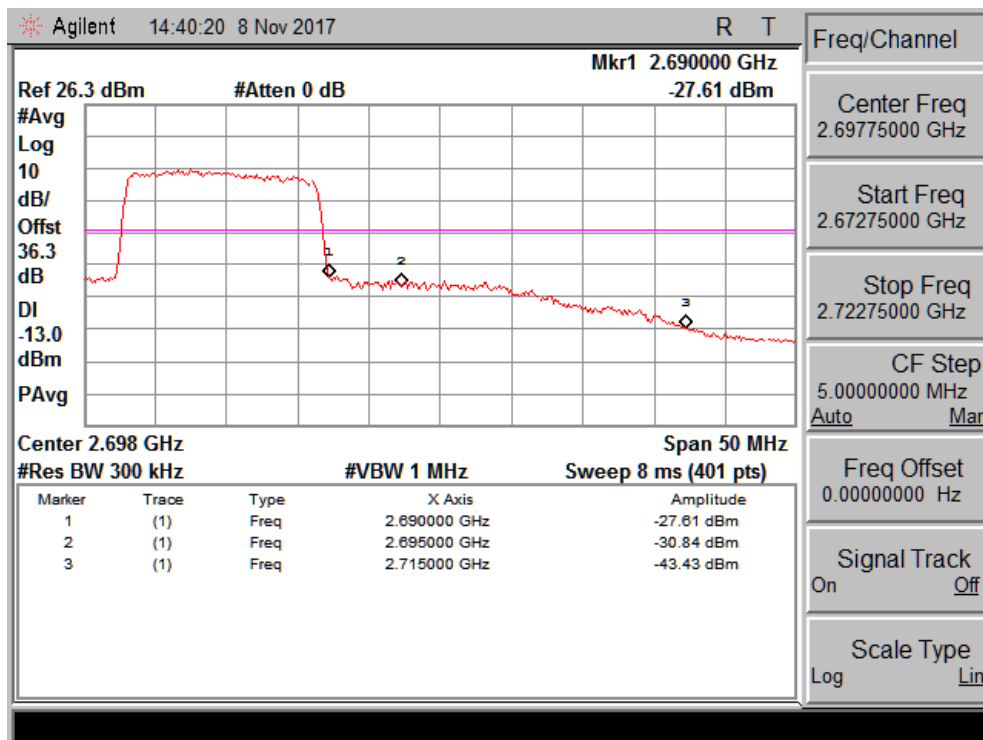

Channel High_15MHz Bandwidth

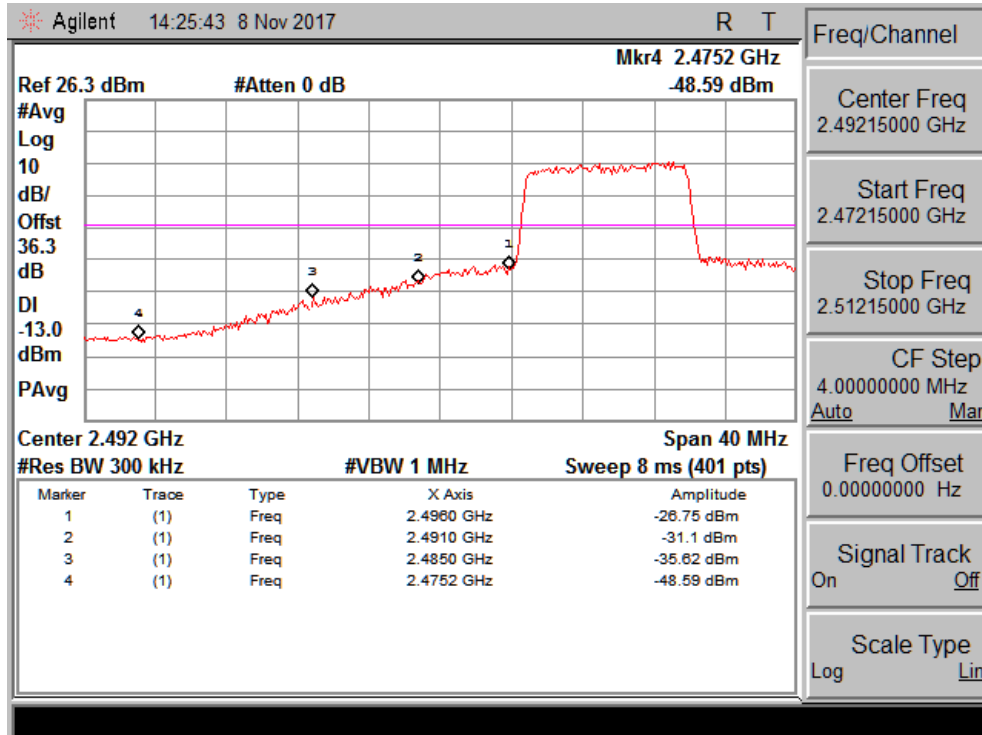

Channel Low_20MHz Bandwidth

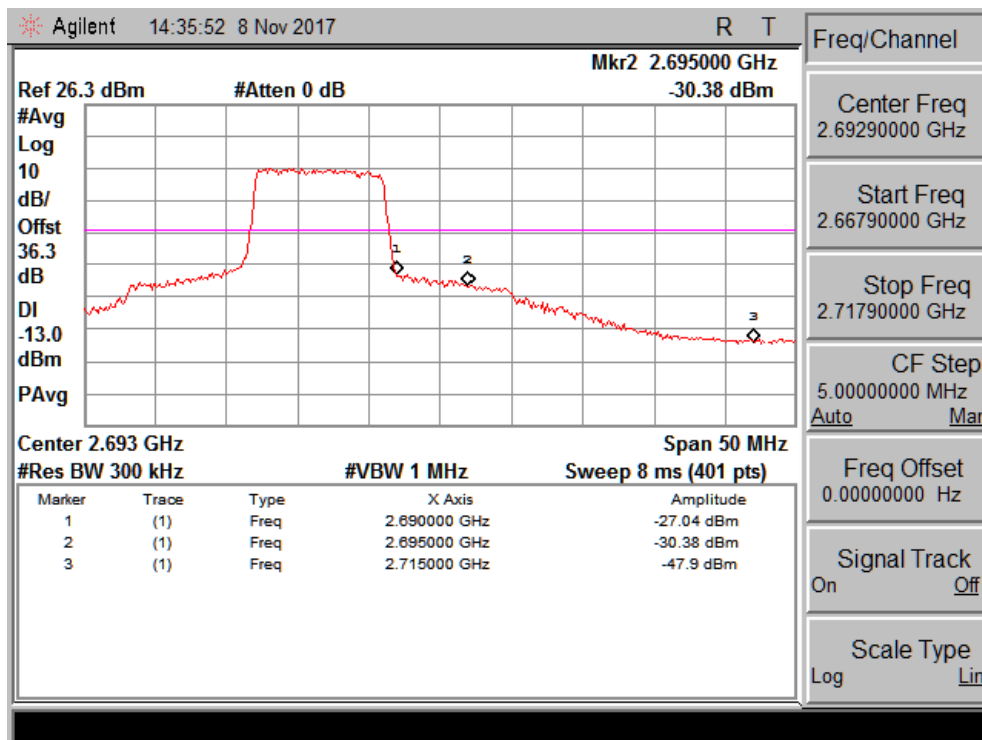

Channel High_20MHz Bandwidth

8.1 Conducted Spurious Emission

Result

Pass

Specification	FCC Part §2.1051, §27.53(m)(2)(V)
Measurement Bandwidth (RBW)	100KHz/ 1MHz
Detector Function	Peak

Test Setup:

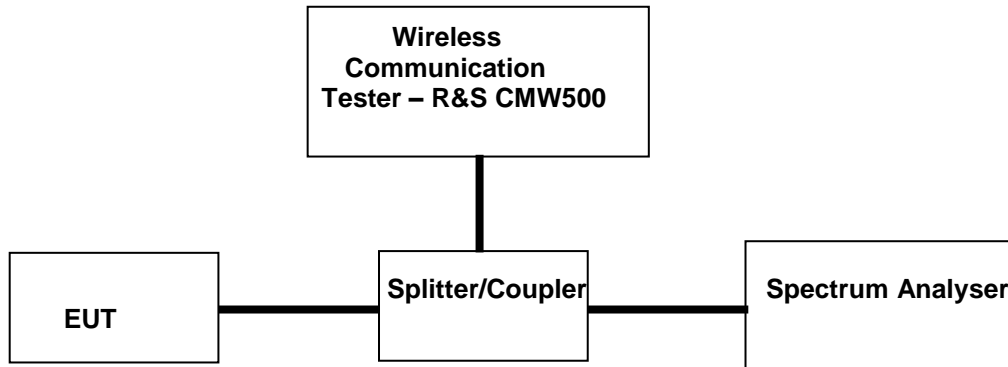

Note: For measurement of Conducted Spurious Emission, sub clause 6.0 of “971168 D01 Power Meas License Digital Systems v03” was used. Attenuator & Cable loss included in the test results.

Test Results for QPSK Modulation

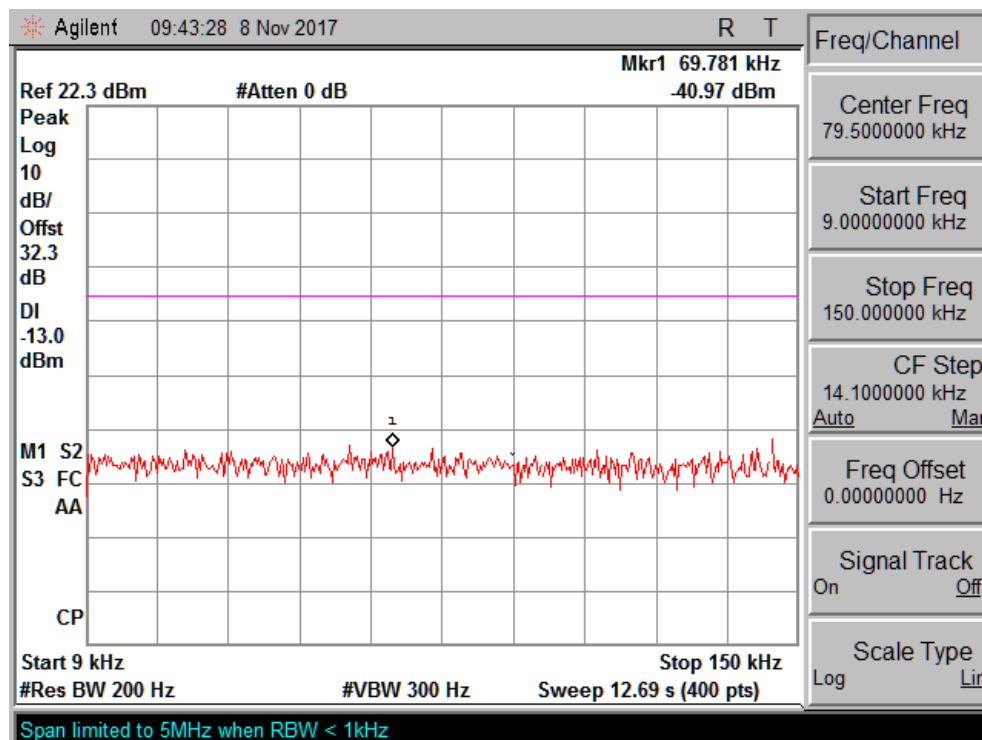

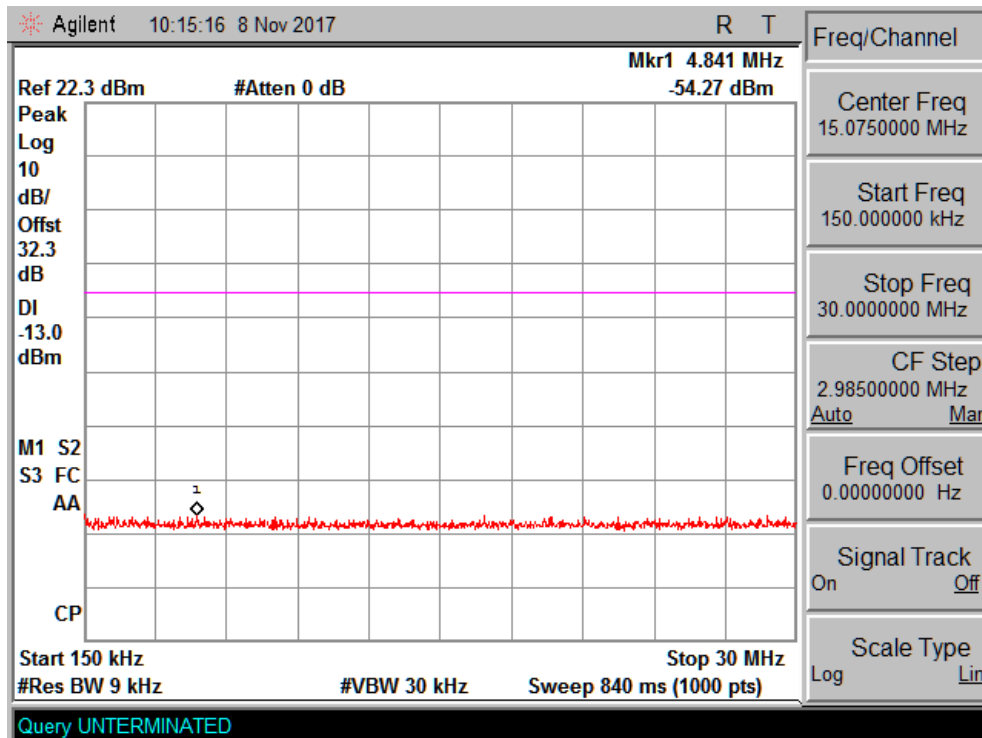

150 kHz to 30 MHz

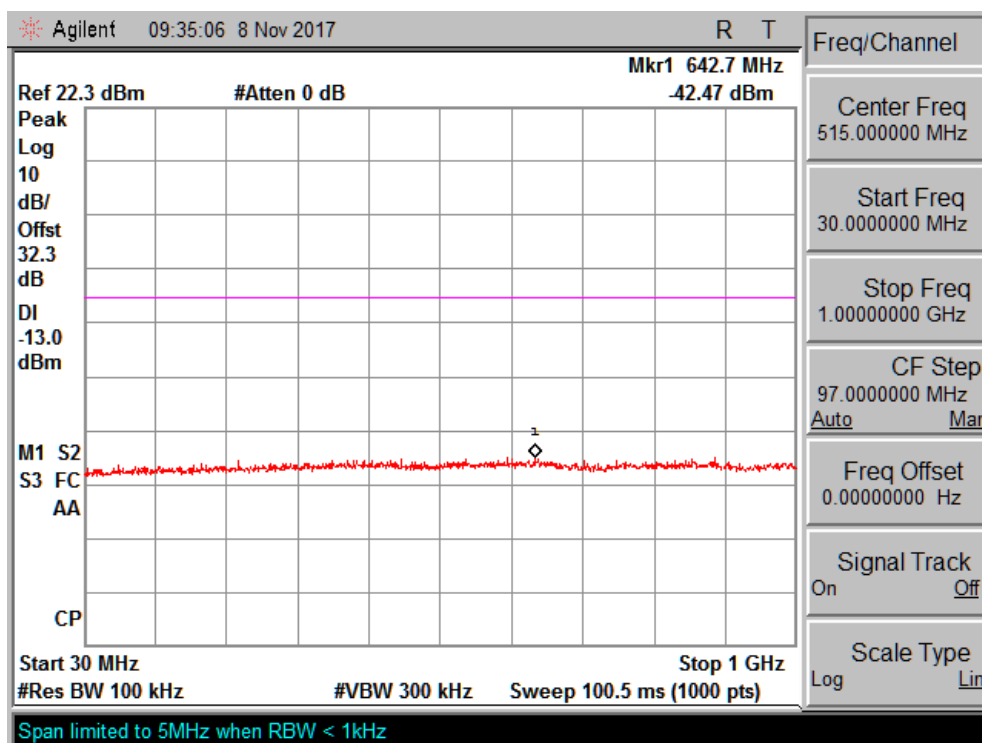

30 MHz to 1 GHz

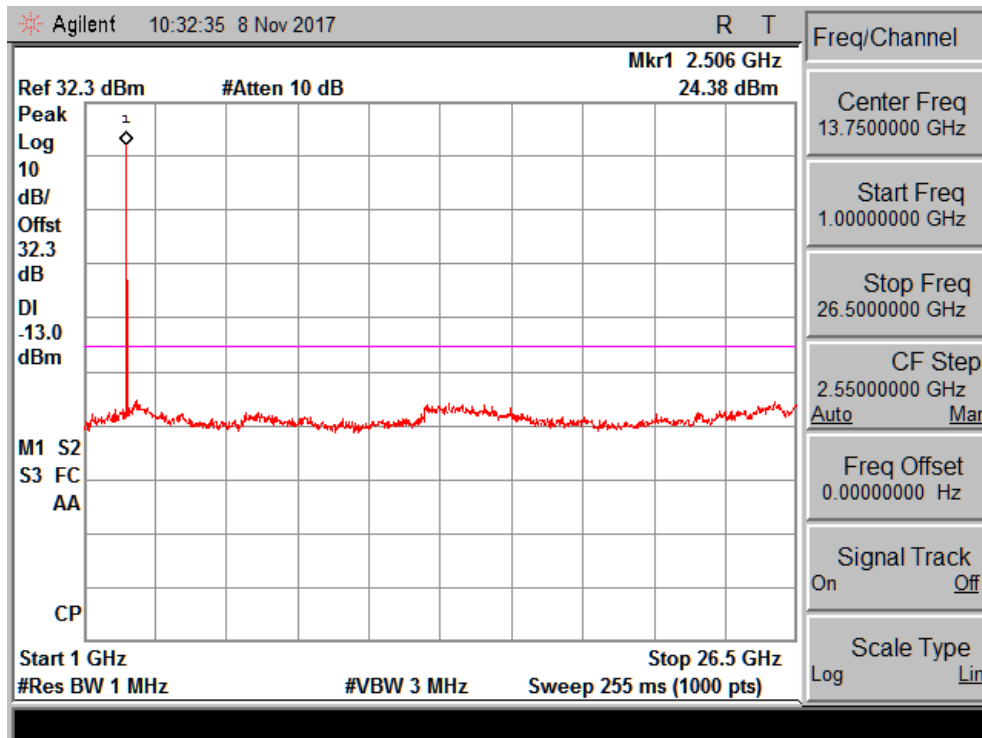

Channel Low_5MHz Bandwidth

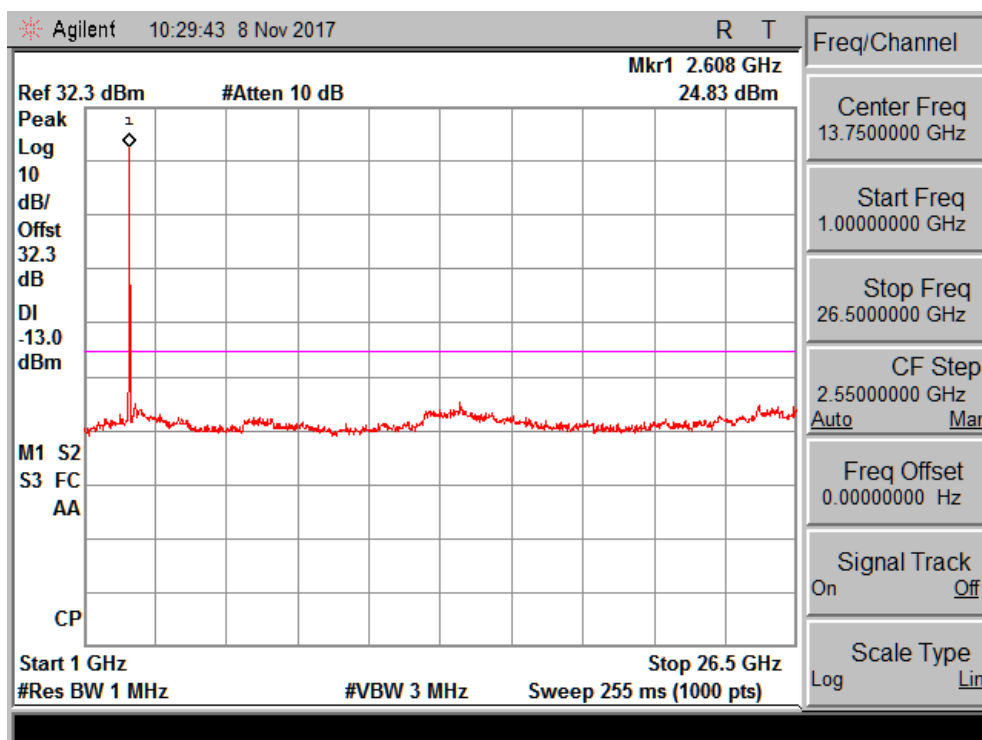

Channel Mid_5MHz Bandwidth

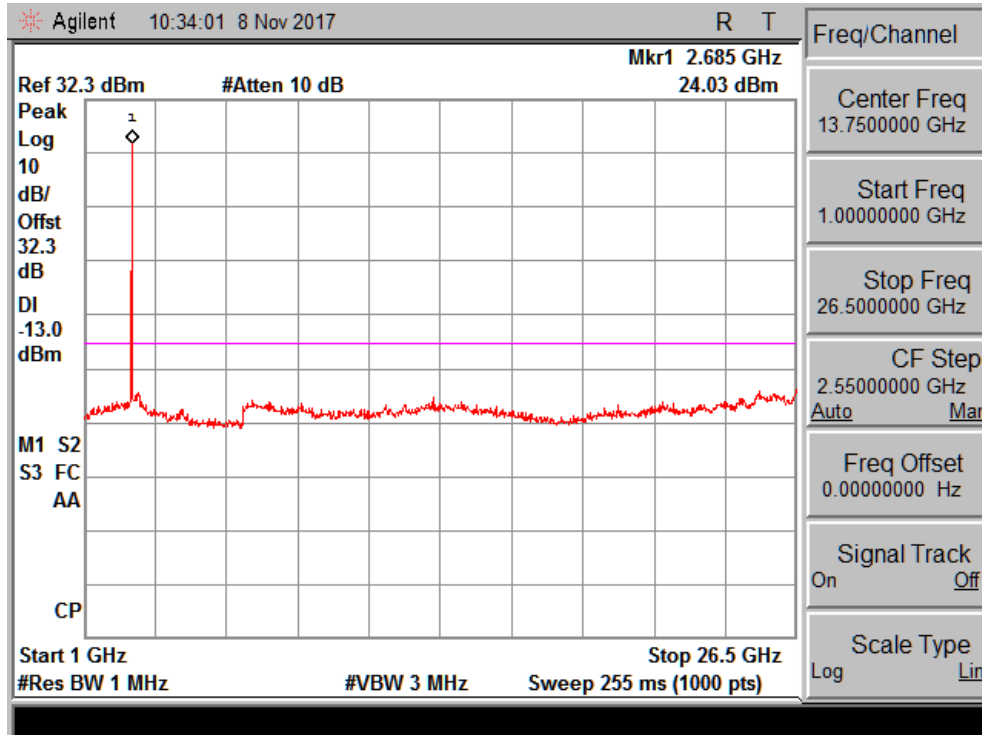

Channel High_5MHz Bandwidth

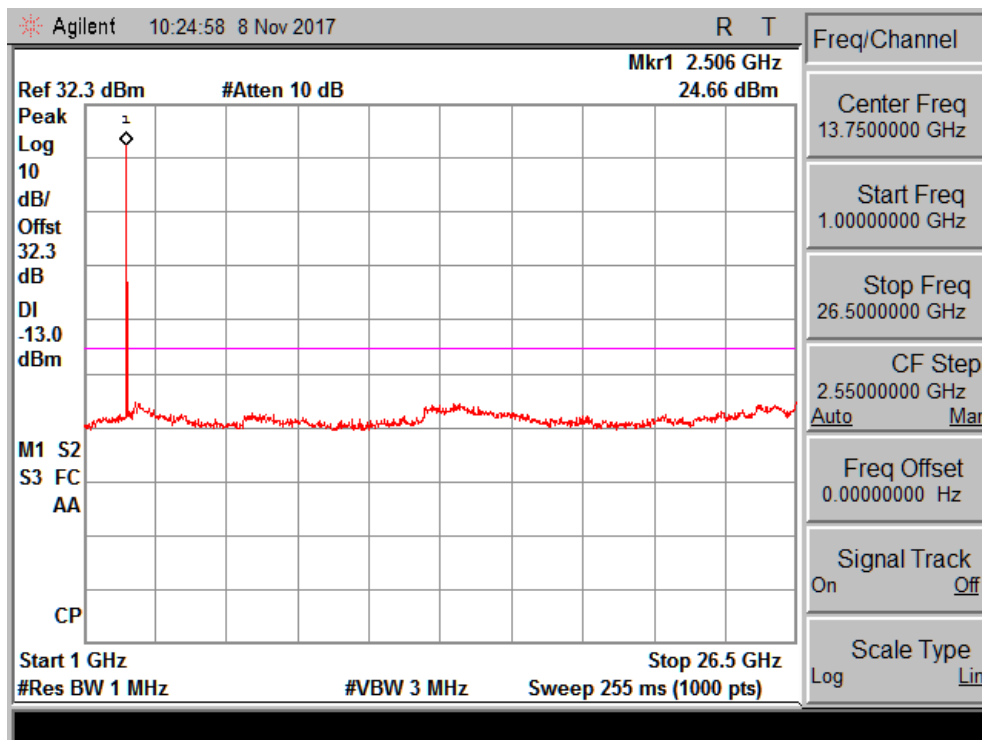

Channel Low_10MHz Bandwidth

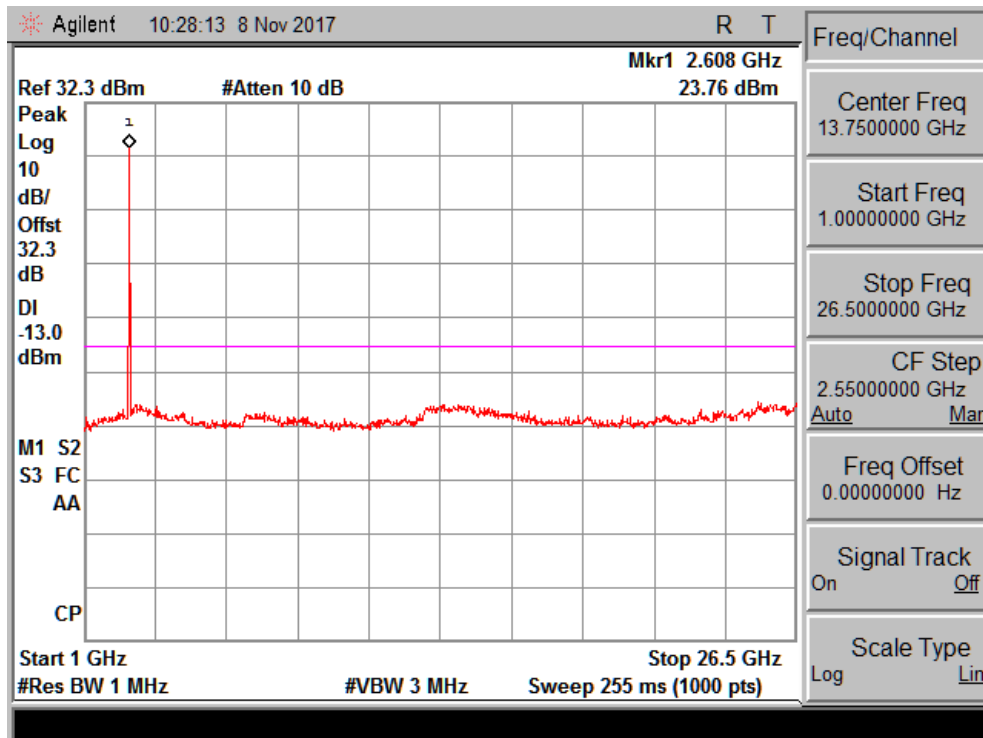

Channel Mid_10MHz Bandwidth

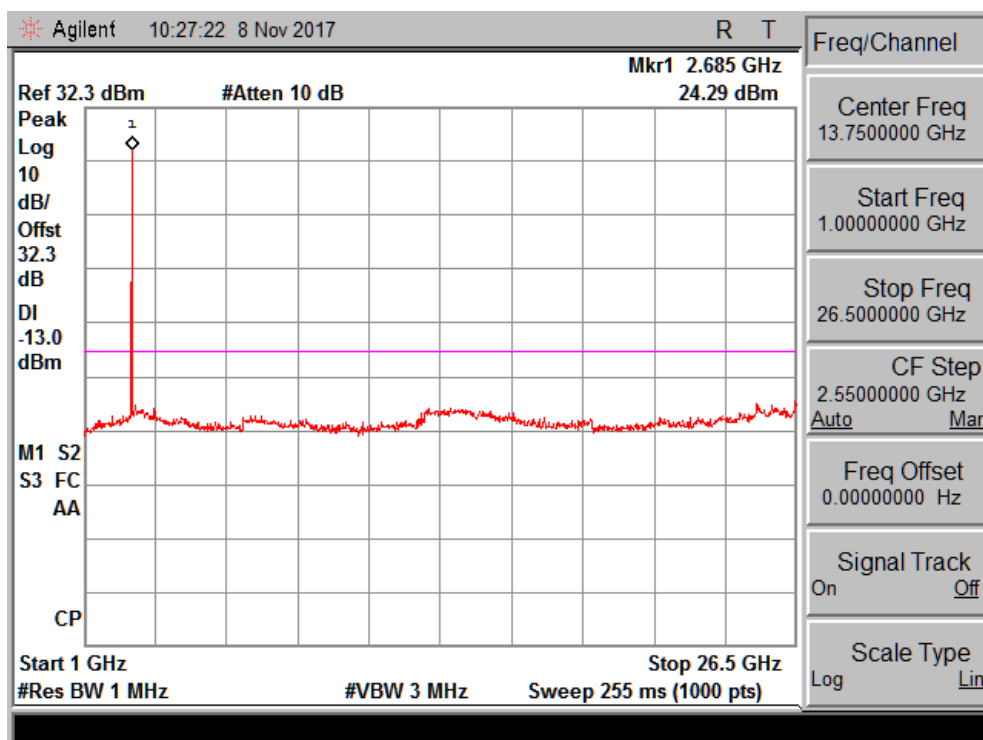

Channel High_10MHz Bandwidth

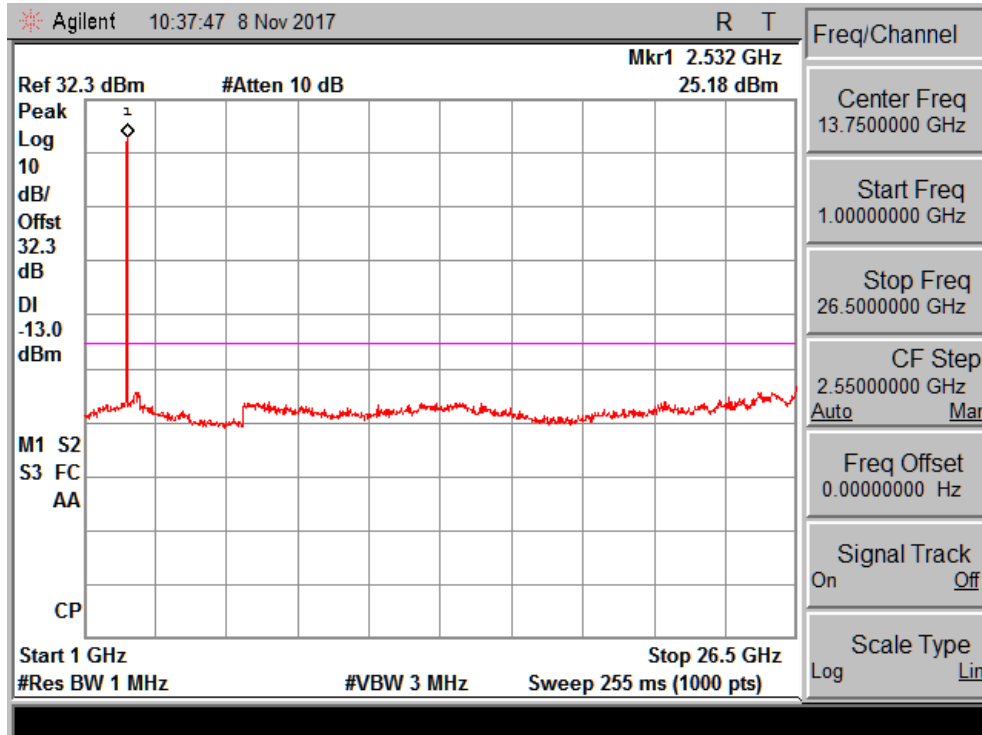

Channel Low_15MHz Bandwidth

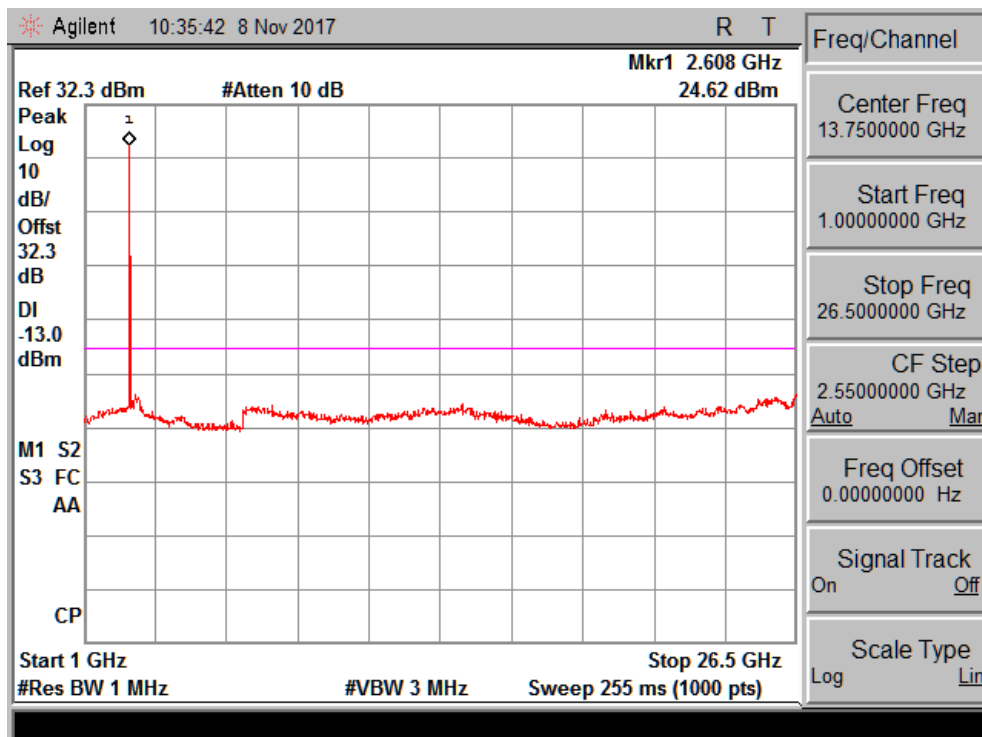

Channel Mid_15MHz Bandwidth

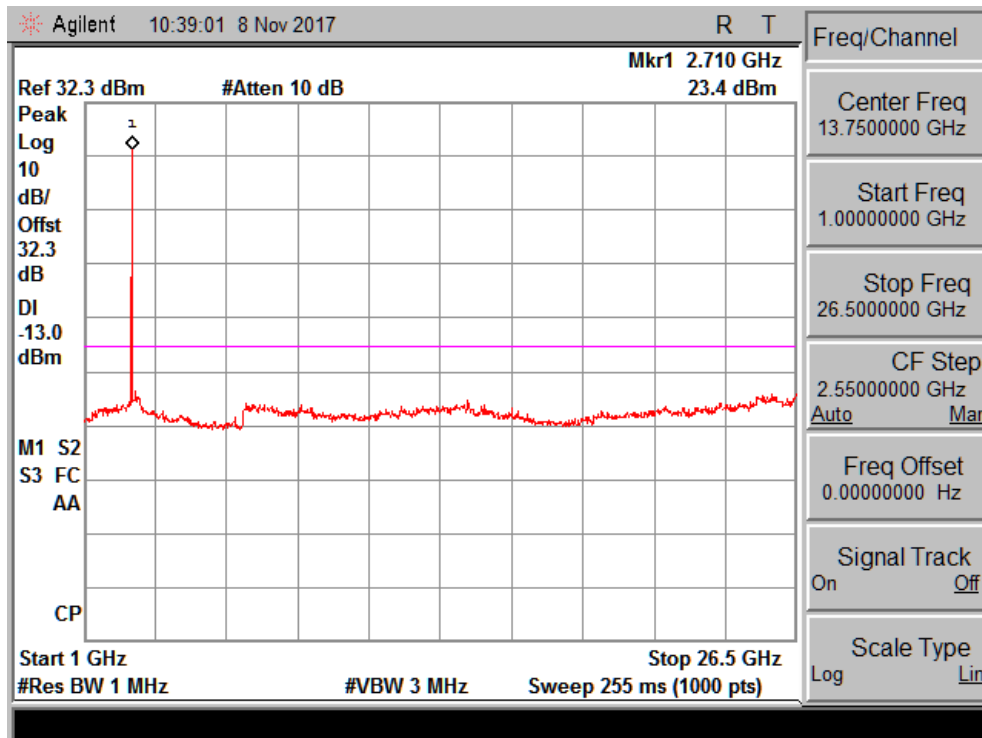

Channel High_15MHz Bandwidth

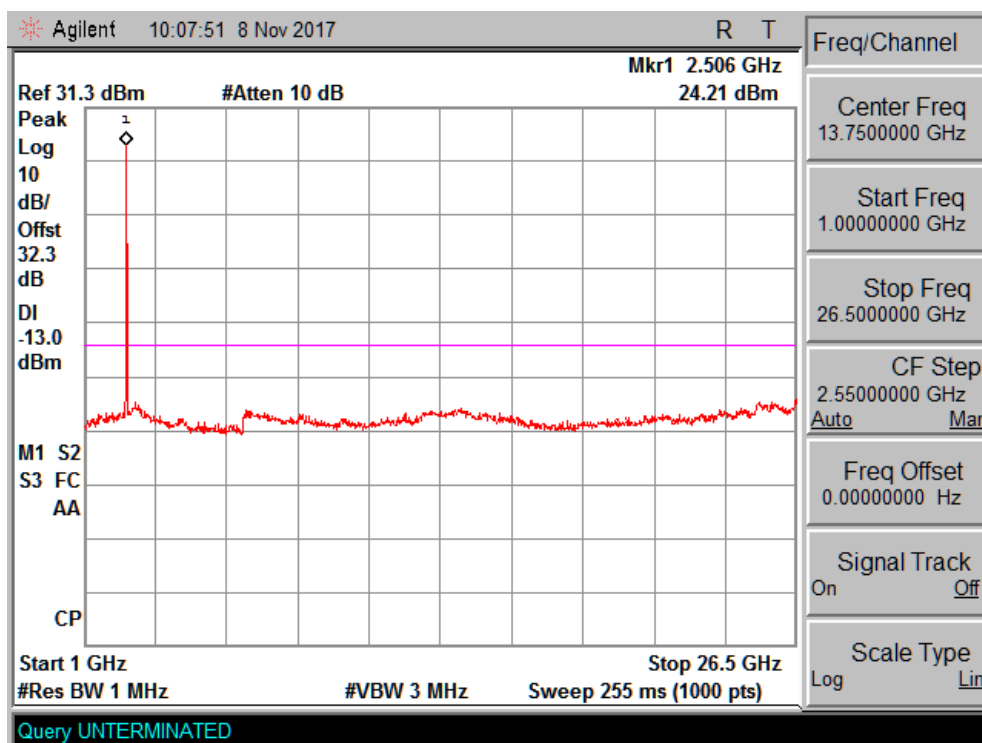

Channel Low_20MHz Bandwidth

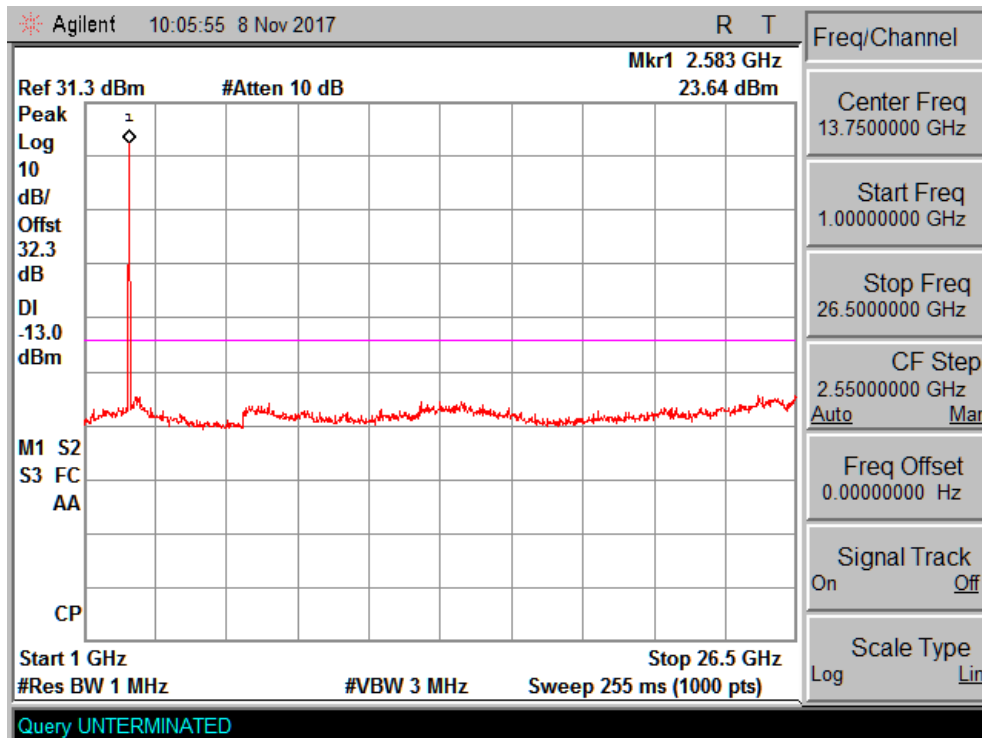

Channel Mid_20MHz Bandwidth

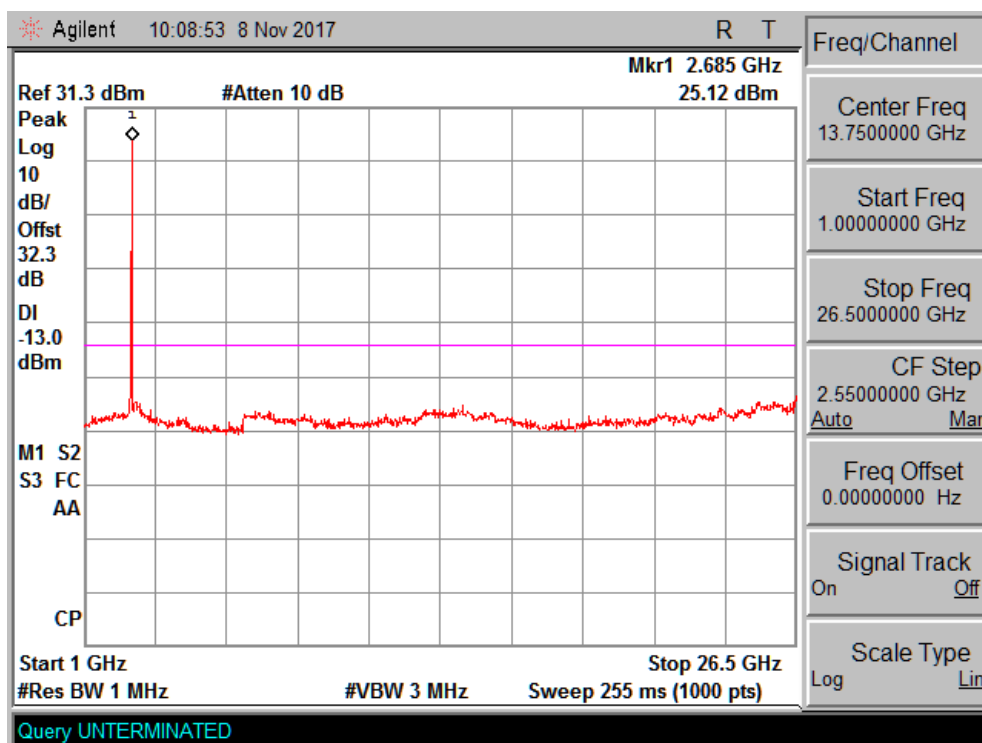

Channel High_20MHz Bandwidth

Test Results for 16QAM modulation

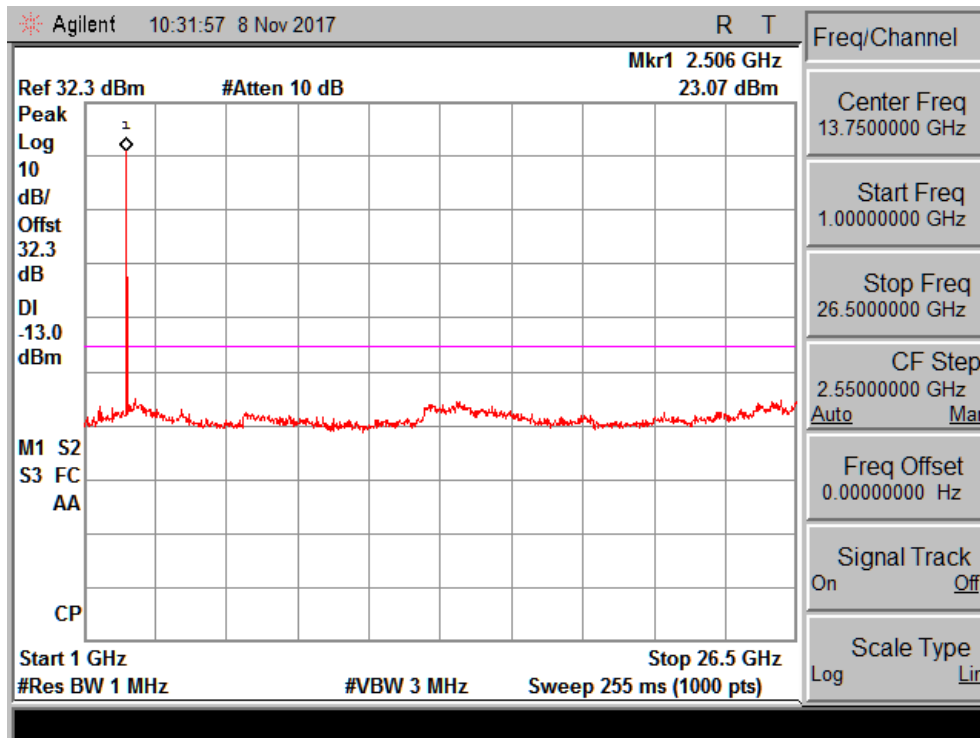

Channel Low_5MHz Bandwidth

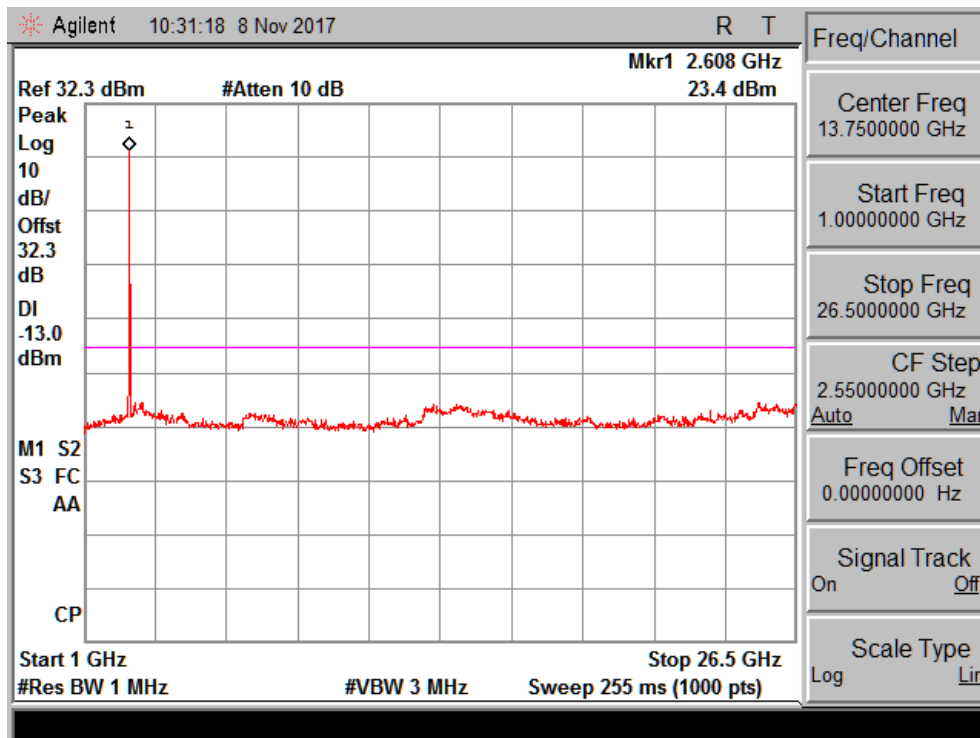

Channel Mid_5MHz Bandwidth

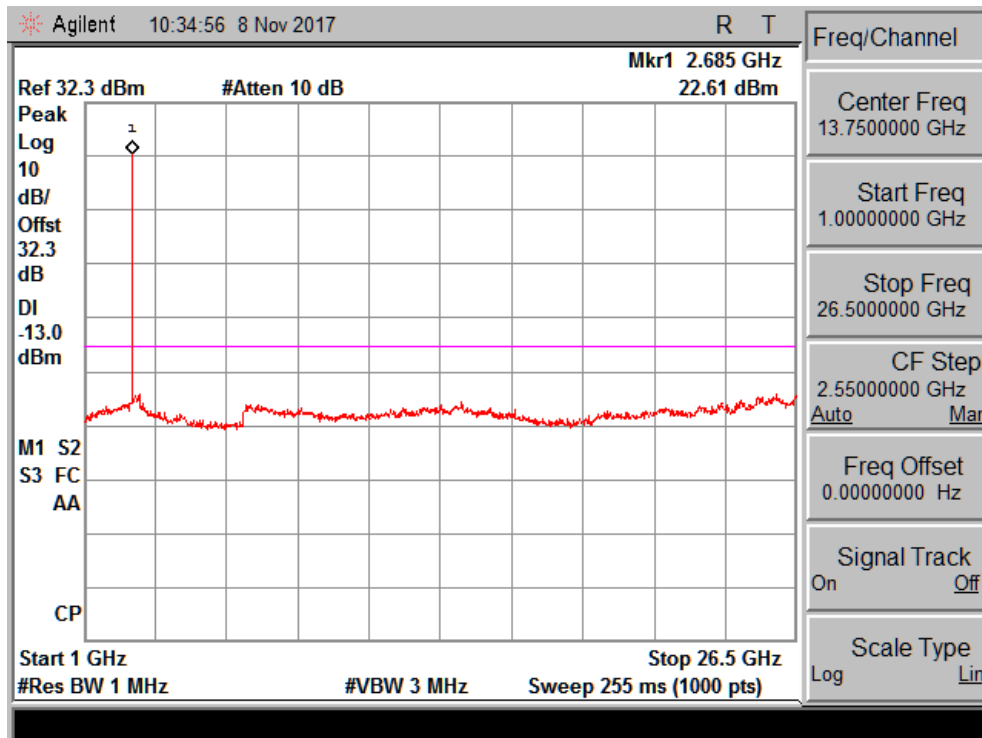

Channel High_5MHz Bandwidth

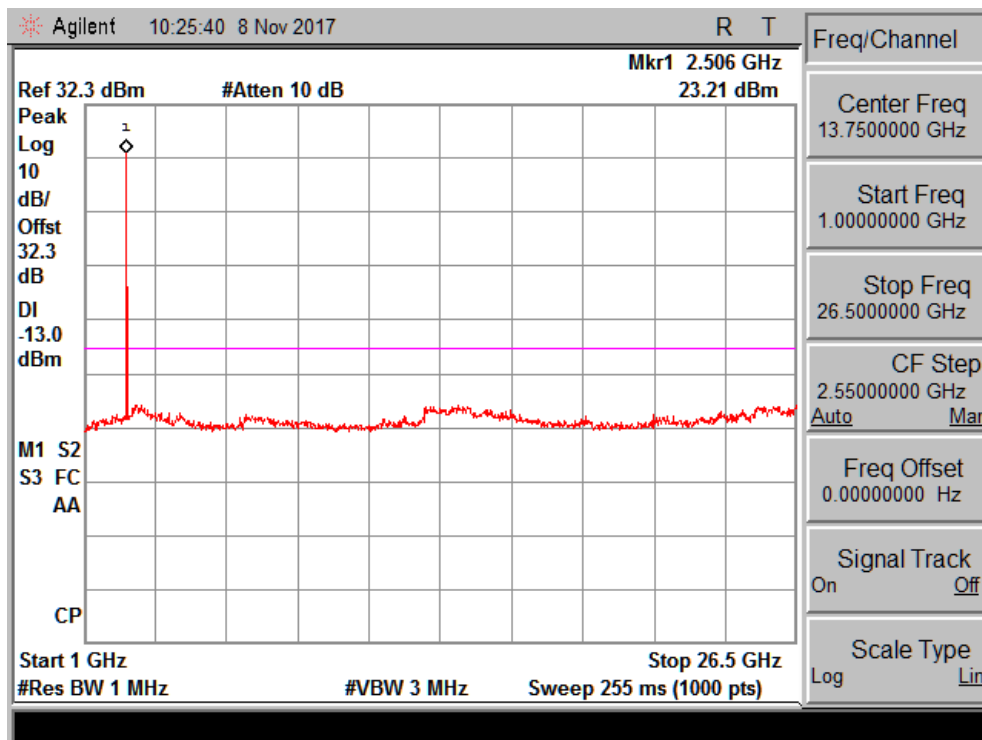

Channel Low_10MHz Bandwidth

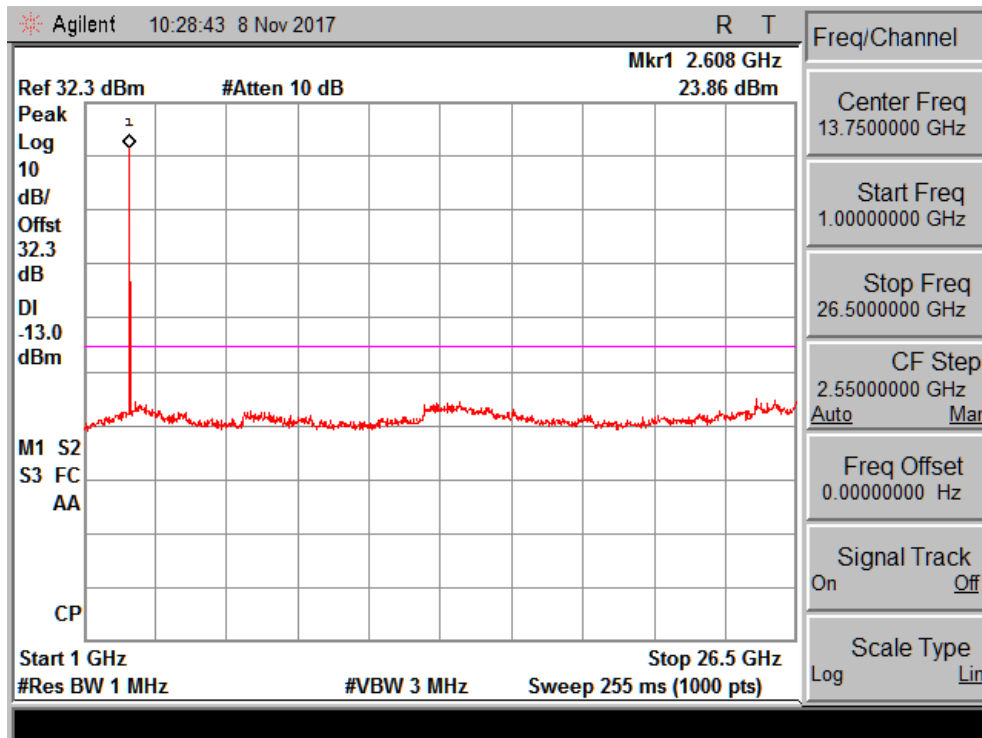

Channel Mid_10MHz Bandwidth

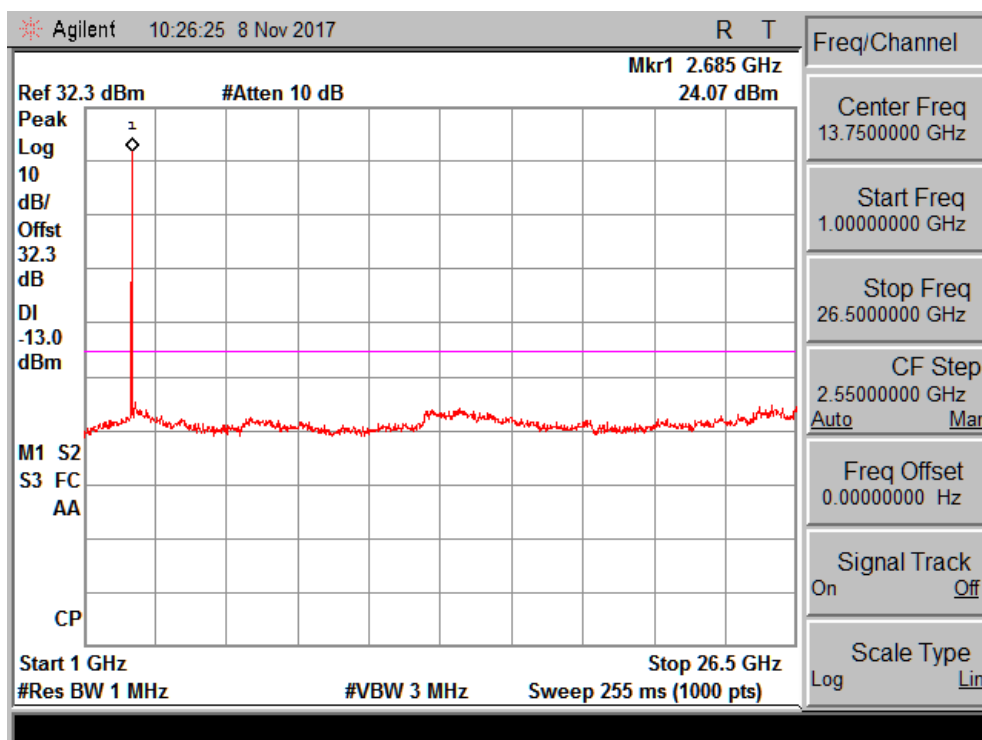

Channel High_10MHz Bandwidth

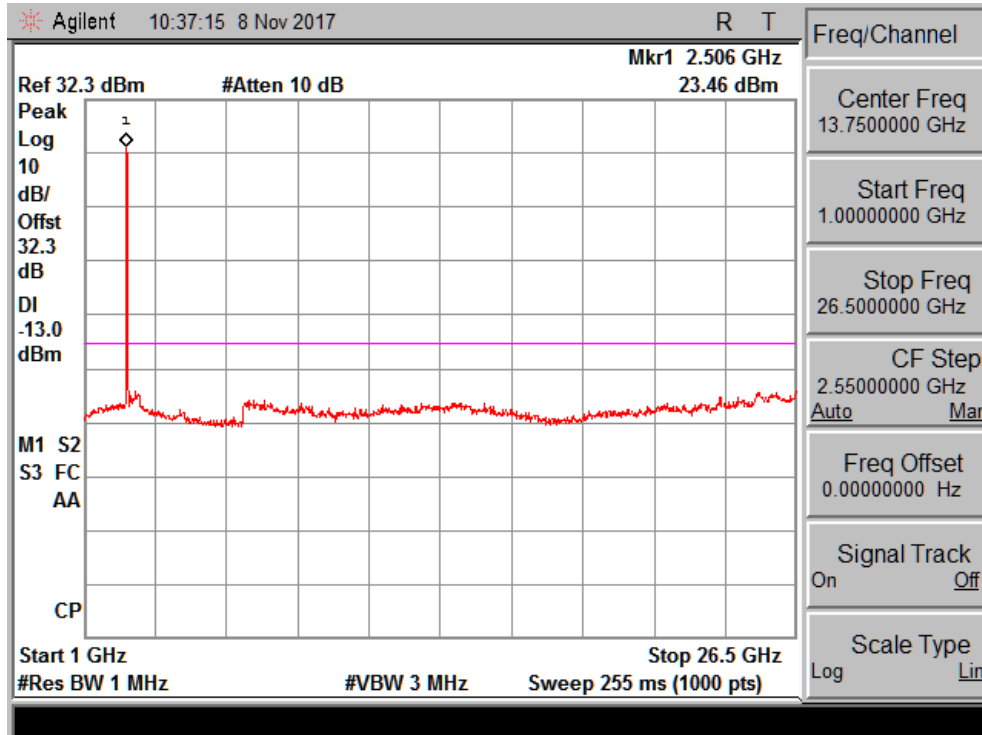

Channel Low_15MHz Bandwidth

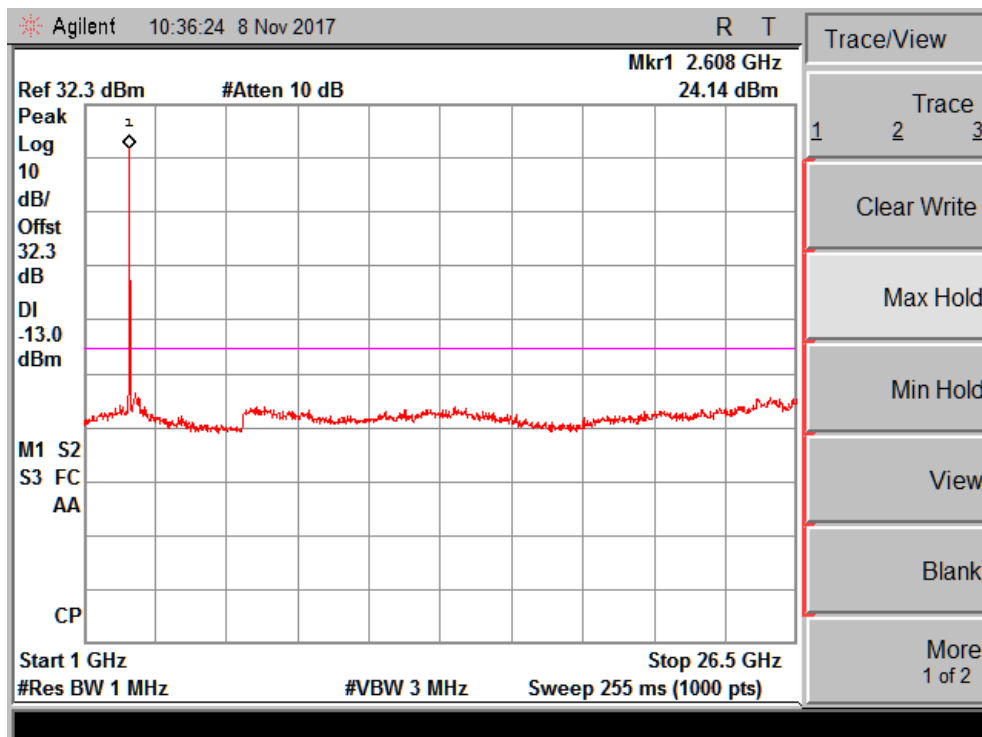

Channel Mid_15MHz Bandwidth

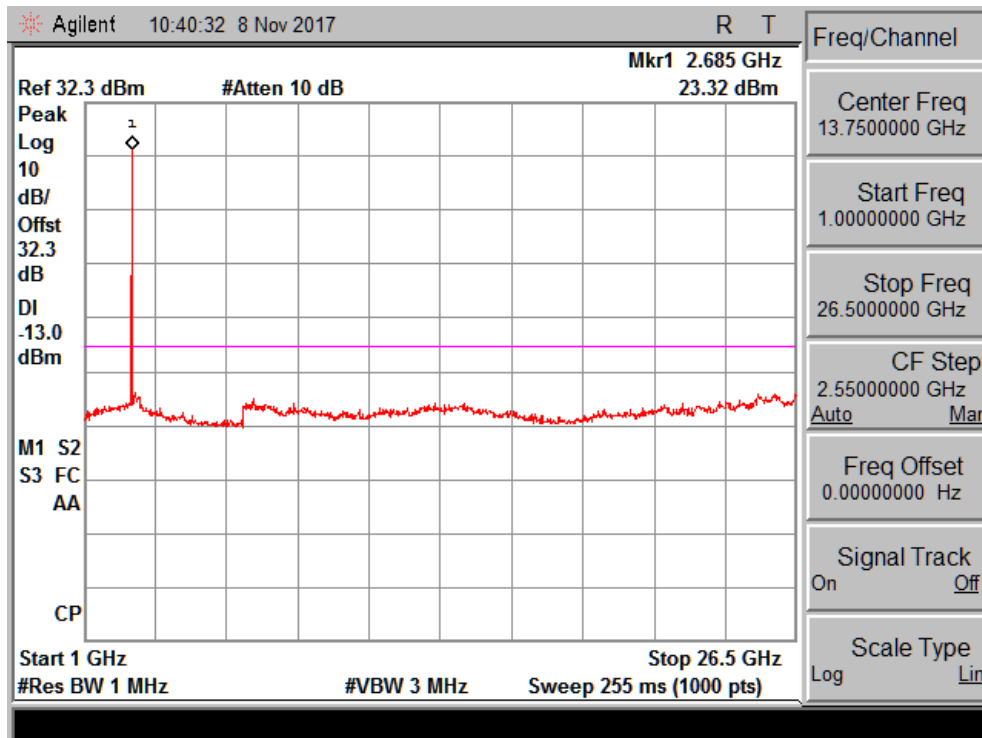

Channel High_15MHz Bandwidth

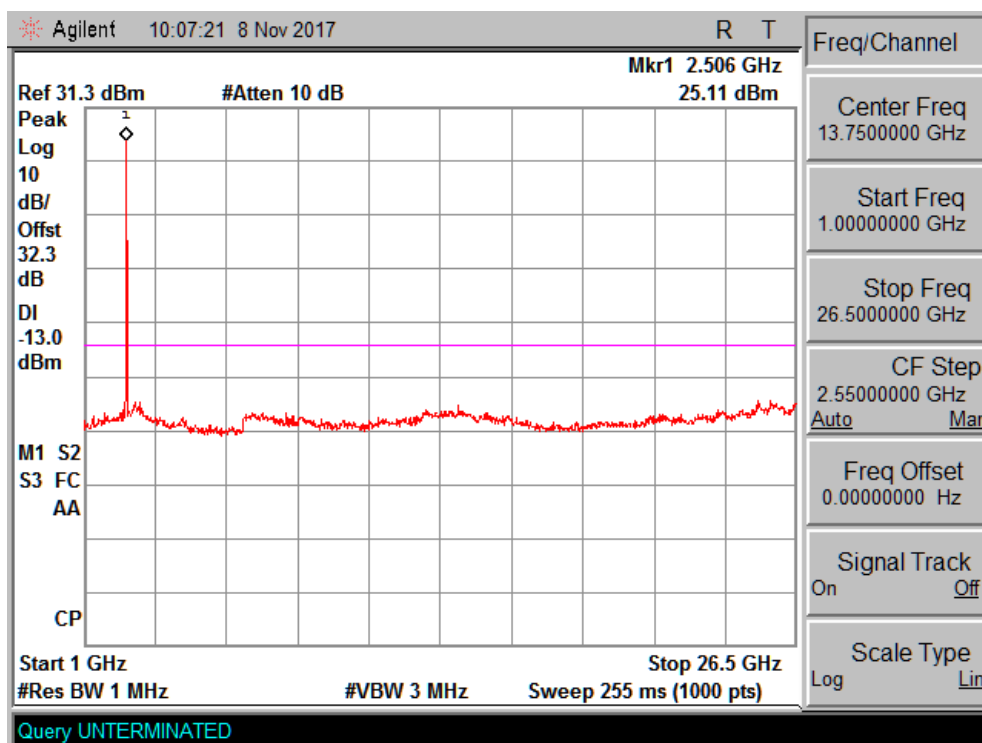

Channel Low_20MHz Bandwidth

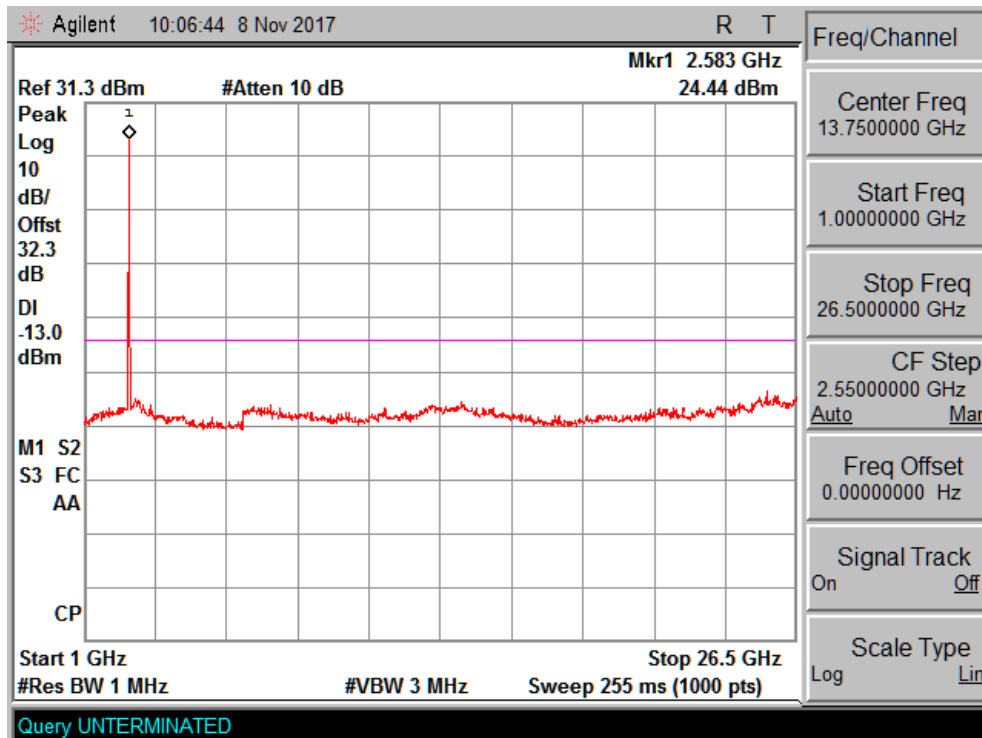

Channel Mid_20MHz Bandwidth

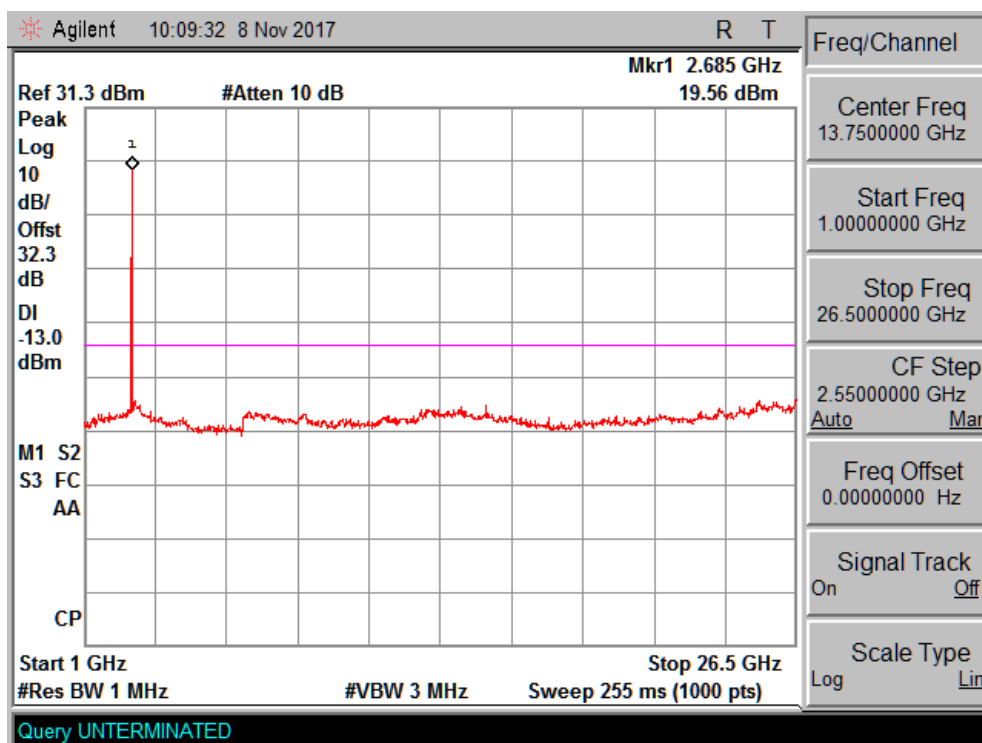

Channel High_20MHz Bandwidth

8.2 Frequency Stability

Result

Pass

Specification FCC Part §2.1055 & §27.54

Requirement Frequency Stability shall be sufficient to ensure that the fundamental emission stay within the authorised frequency block.

Test Setup:

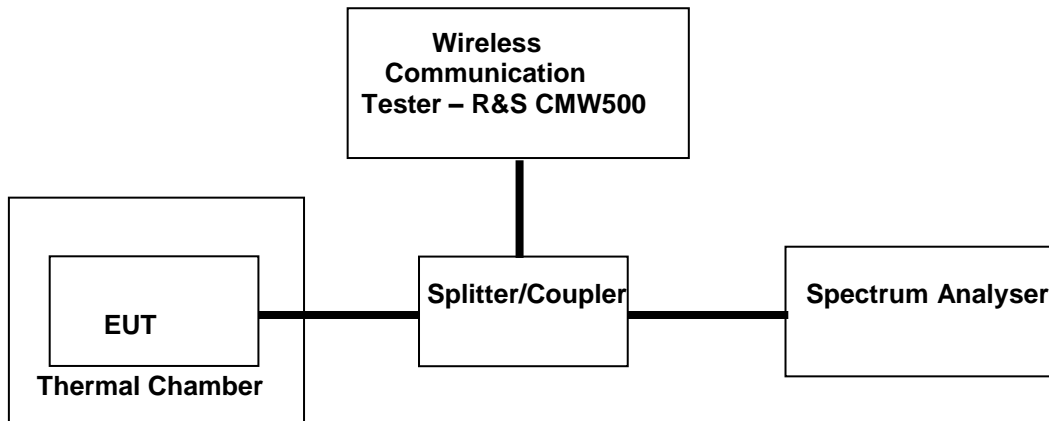

Note: For measurement of Frequency Stability, sub clause 9.0 of “971168 D01 Power Meas License Digital Systems v03” was used. Attenuator & Cable loss included in the test results.

Test Results

Table 14: Frequency Stability on Temperature variation Test results

TDD Band	Bandwidth (MHz)	Channel Frequency (MHz)	Temperature (°C)	Maximum Frequency Error		Limit
				(Hz)	(ppm)	
41	5	2593	-30	21.51	0.008295	Fundamental emissions stay within the authorized bands of operation
		2593	-20	21.30	0.008214	
		2593	-10	17.45	0.006730	
		2593	0	17.41	0.006714	
		2593	10	16.77	0.006467	
		2593	20	16.49	0.006359	
		2593	30	15.13	0.005835	
		2593	40	19.54	0.007536	
	2593	50	18.87	0.007277		
	10	2593	-30	22.70	0.008754	
		2593	-20	20.34	0.007844	
		2593	-10	22.39	0.008635	
		2593	0	20.46	0.007890	
		2593	10	22.93	0.008843	
		2593	20	19.41	0.007486	
		2593	30	17.91	0.006907	
2593		40	20.26	0.007813		
2593	50	22.19	0.008558			

	15	2593	-30	17.09	0.006591
		2593	-20	21.23	0.008187
		2593	-10	18.30	0.007057
		2593	0	20.56	0.007929
		2593	10	22.30	0.008600
		2593	20	17.47	0.006737
		2593	30	11.20	0.004319
		2593	40	26.80	0.010336
		2593	50	24.35	0.009391
	20	2593	-30	22.51	0.008681
		2593	-20	16.68	0.006433
		2593	-10	19.88	0.007667
		2593	0	21.80	0.008407
		2593	10	18.77	0.007239
		2593	20	17.47	0.006737
		2593	30	14.06	0.005422
		2593	40	24.30	0.009371
		2593	50	21.43	0.008265

8.3 RF Power (ERP/EIRP) – Radiated Mode

Result

Pass

Specification	FCC Part §2.1046(a), §27.50 (a)(3)
Measurement Bandwidth (RBW)	1MHz
Detector Function	Peak

Test Setup:

Refer section 6 of the test report.

Note: For measurement of RF Output Power, test procedure as per “ANSI C63.26-2015 sub clause 5.2.7” was used.

Note: Only Worst Case test results are reported

Table 15: RF Power(ERP/EIRP) –Radiated Mode Test results

TDD Band	Bandwidth	Channel	Polarization	Radiated Output Power (dBm)
41	5	Low	Vertical	35.972
			Horizontal	35.862
		Mid	Vertical	33.046
			Horizontal	33.186
		High	Vertical	34.231
			Horizontal	35.061
	10	Low	Vertical	36.142
			Horizontal	36.322
		Mid	Vertical	33.006
			Horizontal	34.046
		High	Vertical	34.731
			Horizontal	35.051
	15	Low	Vertical	35.982
			Horizontal	33.652
		Mid	Vertical	32.686
			Horizontal	33.786
		High	Vertical	34.751
			Horizontal	35.611
	20	Low	Vertical	33.572
			Horizontal	34.432
		Mid	Vertical	33.572
			Horizontal	33.906
		High	Vertical	34.611
			Horizontal	35.421

8.4 Field Strength of Spurious Radiation

Result

Pass

Specification	FCC Part §2.1053, §27.53(m)(2)(V)
Measurement Bandwidth (RBW)	100 kHz (for frequency ≤1GHz) & 1 MHz (for Frequency ≥ 1GHz)
Detector Function	Peak
Requirement	Attenuation below transmitter power shall not be more than -13 dBm

Test Setup:

Refer section 6 of the test report.

Note: For measurement of Field strength spurious radiation, test procedure as per “ANSI C63.26-2015, sub clause 5.2.7” and KDB “971168 D02 Misc Rev Approv License Devices v02r01, sub clause IV” was used.

Test Results:

No Emission found in the frequency range from 9kHz to 30 MHz

Table 16: Field strength of spurious radiation below 1 GHz

Antenna Polarization	Measured Frequency (MHz)	Field strength of Spurious Emission (dBm)	Limit (dBm)	Margin (dB)
Vertical	37.42	-74.64	-13.00	-61.64
	56.24	-78.78	-13.00	-65.78
	71.99	-66.71	-13.00	-53.71
	87.42	-73.17	-13.00	-60.17
	134.7	-63.95	-13.00	-50.95
Horizontal	71.99	-76.17	-13.00	-63.17
	152.8	-71.20	-13.00	-58.20

Table 17: Field Strength of Spurious Radiation above 1 GHz

TDD Band 41							
Channel Bandwidth (MHz)	Channel	Channel Frequency (MHz)	Polarization	Frequency (MHz)	Emission (dBm)	Limit (dBm)	Margin (dB)
5	Low	2498.5	Vertical	4997	-32.99	-13	-19.99
			Horizontal	4997	-33.31	-13	-20.31
			Vertical	7495.5	-33.34	-13	-20.34
			Horizontal	7495.5	-33.20	-13	-20.20
	Mid	2593	Vertical	5186	-33.31	-13	-20.31
			Horizontal	5186	-34.21	-13	-21.21
			Vertical	7779	-32.53	-13	-19.53
			Horizontal	7779	-32.88	-13	-19.88
	High	2687.5	Vertical	5375	-22.81	-13	-9.81
			Horizontal	5375	-21.26	-13	-8.26
			Vertical	8062.5	-33.01	-13	-20.01
			Horizontal	8062.5	-31.54	-13	-18.54
10	Low	2501	Vertical	5002	-32.82	-13	-19.82
			Horizontal	5002	-35.45	-13	-22.45
			Vertical	7503	-37.93	-13	-24.93
			Horizontal	7503	-37.96	-13	-24.96
	Mid	2593	Vertical	5186	-35.32	-13	-22.32
			Horizontal	5186	-35.22	-13	-22.22
			Vertical	7779	-36.07	-13	-23.07
			Horizontal	7779	-36.32	-13	-23.32
	High	2685	Vertical	5370	-25.15	-13	-12.15
			Horizontal	5370	-23.41	-13	-10.41
			Vertical	8055	-38.47	-13	-25.47
			Horizontal	8055	-35.79	-13	-22.79
15	Low	2503.5	Vertical	5007	-33.74	-13	-20.74
			Horizontal	5007	-32.46	-13	-19.46
			Vertical	7510.5	-35.59	-13	-22.59
			Horizontal	7510.5	-37.18	-13	-24.18
	Mid	2593	Vertical	5186	-36.36	-13	-23.36
			Horizontal	5186	-35.12	-13	-22.12
			Vertical	7779	-38.28	-13	-25.28
			Horizontal	7779	-39.11	-13	-26.11
	High	2682.5	Vertical	5365	-26.92	-13	-13.92
			Horizontal	5365	-26.67	-13	-13.67
			Vertical	8047.5	-38.96	-13	-25.96
			Horizontal	8047.5	-38.33	-13	-25.33

20	Low	2506	Vertical	5012	-35.06	-13	-22.06
			Horizontal	5012	-33.46	-13	-20.46
			Vertical	7518	-39.67	-13	-26.67
			Horizontal	7518	-38.69	-13	-25.69
	Mid	2593	Vertical	5186	-36.80	-13	-23.80
			Horizontal	5186	-35.03	-13	-22.03
			Vertical	7779	-40.60	-13	-27.60
			Horizontal	7779	-39.56	-13	-26.56
	High	2680	Vertical	5360	-26.13	-13	-13.13
			Horizontal	5360	-27.01	-13	-14.01
			Vertical	8040	-38.75	-13	-25.75
			Horizontal	8040	-38.95	-13	-25.95

9 List of Tables

Table 1: Test result summary.....	3
Table 2: List of Test and Measurement Instruments	3
Table 3: Ratings and System Details	4
Table 4: Equipment used for Testing	5
Table 5: Summary of Measured Power & Emission Designator	5
Table 6: Emission Designator Details	5
Table 7: Operating frequency details	5
Table 8: Frequency List of Low/Mid/High channel.....	6
Table 9: Measurement Uncertainty	6
Table 10: QPSK Modulation RF Out Put Power Conducted ModeTest results	10
Table 11: 16-QAM Modulation RF Out Put Power Conducted ModeTest results	11
Table 12: QPSK Modulation Occupied Bandwidth and -26dB Bandwidth Test results	13
Table 13: QPSK Modulation Occupied Bandwidth and -26dB Bandwidth Test results	20
Table 14: Frequency Stability on Temperature variation Test results	50
Table 15: RF Power(ERP/EIRP) –Radiated Mode Test results.....	52
Table 16: Field strength of spurious radiation below 1 GHz	53
Table 17: Field Strength of Spurious Radiation above 1 GHz	54

END OF TEST REPORT