

RF Test Report

Applicant : Emplus Technologies, Inc
Product Type : 4x4 AX Dual-band AP
Trade Name : emplus
Model Number : WAP380
Applicable Standard : FCC 47 CFR PART 15 SUBPART E
ANSI C63.10:2013
Received Date : May 13, 2020
Test Period : Jun. 03 ~ Jul. 10, 2020
Issued Date : Aug. 19, 2020

Issued by

A Test Lab Techno Corp.
No. 140-1, Changan Street, Bade District,
Taoyuan City 33465, Taiwan (R.O.C.)
Tel : +86-3-2710188 / Fax : +86-3-2710190



Taiwan Accreditation Foundation accreditation number: 1330
Frequency Range : 9 kHz to 40 GHz
Test Firm MRA designation number: TW0010

Note:

- 1.The test results are valid only for samples provided by customers and under the test conditions described in this report.
- 2.This report shall not be reproduced except in full, without the written approval of A Test Lab Technology Corporation.
- 3.The relevant information is provided by customers in this test report. According to the correctness, appropriateness or completeness of the information provided by the customer, if there is any doubt or error in the information which affects the validity of the test results, the laboratory does not take the responsibility.



Revision History

Rev.	Issued Date	Revisions	Revised By
00	Jul. 23, 2020	Initial Issue	Snow Wang
01	Aug. 19, 2020	Update model number and model description (P.1/P.3/P.7/P.8/P.10) Update chapter 3.3 (P.21~P.22) Update Test Results (P.40~P.45/P.228~P.229) Update Test Setup Photographs	Snow Wang

Verification of Compliance

Applicant : Emplus Technologies, Inc
Product Type : 4x4 AX Dual-band AP
Trade Name : emplus
Model Number : WAP380
FCC ID : 2AL6XWAP380
EUT Rated Voltage : DC 12 V, 2.5 A (DC Power Adapter)
DC 54 V, 0.6 A (PoE injector (802.3af/at))
Test Voltage : 120 Vac / 60 Hz
Applicable Standard : FCC 47 CFR PART 15 SUBPART E
ANSI C63.10:2013
Test Result : Complied

Performing Lab. : A Test Lab Techno Corp.
No. 140-1, Changan Street, Bade District,
Taoyuan City 33465, Taiwan (R.O.C.)
Tel : +86-3-2710188 / Fax : +86-3-2710190



Taiwan Accreditation Foundation accreditation number: 1330

<http://www.atl-lab.com.tw/e-index.htm>

A Test Lab Techno Corp. tested the above equipment in accordance with the requirements set forth in the above standards. All indications of Pass/Fail in this report are opinions expressed by A Test Lab Techno Corp. based on interpretations and/or observations of test results. The test results show that the equipment tested is capable of demonstrating compliance with the requirements as documented in this report.

Approved By

:

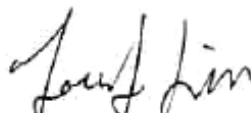

(Manager)

(Jeremy Lin)

TABLE OF CONTENTS

1	General Information	5
1.1.	Summary of Test Result	5
1.2.	Measurement Uncertainty	6
2	EUT Description	7
3	Test Methodology	10
3.1.	Mode of Operation.....	10
3.2.	EUT Test Step.....	20
3.3.	Configuration of Test System Details.....	21
3.4.	Test Instruments	23
3.5.	Test Site Environment	24
4	Measurement Procedure	25
4.1.	AC Power Conducted Emission Measurement	25
4.2.	Transmitter Radiated Emissions Measurement.....	27
4.3.	Maximum Conducted Output Power Measurement	32
4.4.	26 dB RF Bandwidth Measurement & 99 % Occupied Bandwidth Measurement	33
4.5.	6 dB RF Bandwidth Measurement	34
4.6.	Maximum Power Spectral Density Measurement.....	35
4.7.	Automatically discontinue transmission.....	37
4.8.	Antenna Requirement	37
5	Test Results	40
	Annex A. Conducted Emission.....	40
	Annex B. Radiated Emission Measurement.....	44
	Annex C. Conducted Test Results.....	376



1 General Information

1.1. Summary of Test Result

Standard	Item	Result	Remark
15.407(b)(6) 15.207	AC Power Conducted Emission	PASS	---
15.407(b) 15.205 / 15.209	Transmitter Radiated Emissions	PASS	---
15.407(a)	Maximum Conducted Output Power	PASS	---
15.407(a)	26 dB RF Bandwidth & 99 % Occupied Bandwidth	Reference	---
15.407(e)	6 dB RF Bandwidth	PASS	----
15.407(a)	Maximum Power Spectral Density	PASS	---
15.407(c)	Automatically discontinue transmission	PASS	---
15.407(a) 15.203	Antenna Requirement	PASS	---

Decision Rule

- Uncertainty is not included.
- Uncertainty is included.

Standard	Description
CFR47, Part 15, Subpart C §15.247	Intentional Radiators
ANSI C63. 10: 2013	American National Standard of Procedures for Compliance Testing of Unlicensed Wireless Devices
KDB 558074 D01 v05	GUIDANCE FOR COMPLIANCE MEASUREMENTS ON DIGITAL TRANSMISSION SYSTEM, FREQUENCY HOPPING SPREAD SPECTRUM SYSTEM, AND HYBRID SYSTEM DEVICES OPERATING UNDER SECTION 15.247 OF THE FCC RULES

1.2. Measurement Uncertainty

Test Item	Frequency Range	Uncertainty (dB)
Conducted Emission	150 kHz ~ 30 MHz	2.68
Radiated Emission	9 kHz ~ 30 MHz	2.14
	30 MHz ~ 1000 MHz	4.99
	1000 MHz ~ 18000 MHz	4.99
	18000 MHz ~ 26500 MHz	4.23
	26500 MHz ~ 40000 MHz	4.39
Conducted Output Power		0.92 dB
RF Bandwidth		4.79 %
Power Spectral Density		0.92 dB
Frequency Stability		4.1×10^{-8}
Duty Cycle		1.06 %
Time Occupancy		1.40 %



2 EUT Description

Applicant	Emplus Technologies, Inc Bld B, 10F, No.209 Nangang Rd., Taipei City, Taiwan				
Manufacturer	Emplus Technologies., Inc. 10F., Building B, No.209, Sec. 1, Nangang Rd., Nangang Dist., Taipei City 115, Taiwan (R.O.C.)				
Product Type	4x4 AX Dual-band AP				
Trade Name	emplus				
Model Number	WAP380				
FCC ID	2AL6XWAP380				
Operate Frequency	Frequency Band		Frequency Range (MHz)	Number of Channels	
	IEEE 802.11a	U-NII Band I	5180 – 5240	4	
		U-NII Band III	5745 – 5825	5	
	IEEE 802.11n 5 GHz 20 MHz / IEEE 802.11ac 20 MHz/ IEEE 802.11ax 20 MHz	U-NII Band I	5180 – 5240	4	
		U-NII Band III	5745 – 5825	5	
	IEEE 802.11n 5 GHz 40 MHz / IEEE 802.11ac 40 MHz/ IEEE 802.11ax 40 MHz	U-NII Band I	5190 – 5230	2	
		U-NII Band III	5755 – 5795	2	
	IEEE 802.11ac 80 MHz/ IEEE 802.11ax 80 MHz	U-NII Band I	5210	1	
U-NII Band III		5775	1		
Modulation Type	OFDM/OFDMA				
Antenna information	Antenna	Model	Type	Max. Gain (dBi)	
	ANT-0	5718A0518300	PIFA Antenna	U-NII Band I	5.13
				U-NII Band III	5.19
	ANT-1	5718A0522300	PIFA Antenna	U-NII Band I	4.26
				U-NII Band III	3.81
	ANT-2	5718A0520300	PIFA Antenna	U-NII Band I	4.03
				U-NII Band III	4.56
	ANT-3	5718A0521300	PIFA Antenna	U-NII Band I	5.04
U-NII Band III				5.04	
Antenna Delivery	Reference section 3.1				
Operate Temp. Range	0 ~ 40 °C				



Frequency Band		RF Output Power (W)
IEEE 802.11a	U-NII Band I	0.189
	U-NII Band III	0.351
IEEE 802.11ac 20 MHz	U-NII Band I	0.342
	U-NII Band III	0.338
IEEE 802.11ac 40 MHz	U-NII Band I	0.362
	U-NII Band III	0.359
IEEE 802.11ac 80 MHz	U-NII Band I	0.176
	U-NII Band III	0.344
IEEE 802.11ax 20 MHz	U-NII Band I	0.361
	U-NII Band III	0.359
IEEE 802.11ax 40 MHz	U-NII Band I	0.377
	U-NII Band III	0.369
IEEE 802.11ax 80 MHz	U-NII Band I	0.164
	U-NII Band III	0.356

Beamforming on

Frequency Band		RF Output Power (W)
IEEE 802.11ac 20 MHz	U-NII Band I	0.084
	U-NII Band III	0.083
IEEE 802.11ac 40 MHz	U-NII Band I	0.086
	U-NII Band III	0.085
IEEE 802.11ac 80 MHz	U-NII Band I	0.040
	U-NII Band III	0.081
IEEE 802.11ax 20 MHz	U-NII Band I	0.089
	U-NII Band III	0.088
IEEE 802.11ax 40 MHz	U-NII Band I	0.087
	U-NII Band III	0.087
IEEE 802.11ax 80 MHz	U-NII Band I	0.038
	U-NII Band III	0.086



Equipment Type		
Outdoor access point	point-to-point	---
	point-to-multipoint	---
Indoor access point		V
Fixed point-to-point access points		---
Client devices		---

3 Test Methodology

3.1. Mode of Operation

Decision of Test ATL has verified the construction and function in typical operation. All the test modes were carried out with the EUT in normal operation, which was shown in this test report and defined as:

Test Mode
Mode 1: Transmit mode
Mode 2: IEEE 802.11a Continuous TX mode
Mode 3: IEEE 802.11ac 20 MHz Continuous TX mode
Mode 4: IEEE 802.11ac 40 MHz Continuous TX mode
Mode 5: IEEE 802.11ac 80 MHz Continuous TX mode
Mode 6: IEEE 802.11ax 20 MHz Continuous TX mode
Mode 7: IEEE 802.11ax 40 MHz Continuous TX mode
Mode 8: IEEE 802.11ax 80 MHz Continuous TX mode

Software used to control the EUT for staying in continuous transmitting mode was programmed. After verification, all tests were carried out with the worst case test modes.

Note : EUT only supports Full RU ◦

Test Mode	ANT-0	ANT-1	ANT-2	ANT-3	ANT-0+1+2+3
Mode 2	V	V	V	V	V
Mode 3	V	V	V	V	V
Mode 4	V	V	V	V	V
Mode 5	V	V	V	V	V
Mode 6	V	V	V	V	V
Mode 7	V	V	V	V	V
Mode 8	V	V	V	V	V



Test Mode	Antenna Delivery	Data Rate (Mbps)	Band	Test Channel
Mode 2	4TX (CDD)	6	U-NII Band I	36, 40, 48
			U-NII Band III	149, 157, 165
Mode 3	4TX (STBC/Beamforming on)	26	U-NII Band I	36, 40, 48
			U-NII Band III	149, 157, 165
Mode 4	4TX (STBC/Beamforming on)	54	U-NII Band I	38, 46
			U-NII Band III	151,159
Mode 5	4TX (STBC/Beamforming on)	117.2	U-NII Band I	42
			U-NII Band III	155
Mode 6	4TX (STBC/Beamforming on)	MCS 0	U-NII Band I	36, 40, 48
			U-NII Band III	149, 157, 165
Mode 7	4TX (STBC/Beamforming on)	MCS 0	U-NII Band I	38, 46
			U-NII Band III	151,159
Mode 8	4TX (STBC/Beamforming on)	MCS 0	U-NII Band I	42
			U-NII Band III	155



Duty cycle

Test Mode	Frequency (MHz)	on time (ms)	on+off time (ms)	Duty cycle	Duty Factor (dB)	1/T Minimum VBW (kHz)
Mode 2	5180.0	1.992	2.096	0.950	0.221	0.502
Mode 3	5180.0	5.490	5.706	0.962	0.168	0.182
Mode 4	5190.0	5.460	5.760	0.948	0.232	0.183
Mode 5	5210.0	5.460	5.775	0.945	0.244	0.183
Mode 6	5180.0	5.500	5.660	0.972	0.125	0.182
Mode 7	5190.0	5.500	5.740	0.958	0.185	0.182
Mode 8	5210.0	5.460	5.740	0.951	0.217	0.183

Beamforming on

Test Mode	Frequency (MHz)	on time (ms)	on+off time (ms)	Duty cycle	Duty Factor (dB)	1/T Minimum VBW (kHz)
Mode 3	5180.0	5.490	5.706	0.962	0.168	0.182
Mode 4	5190.0	5.460	5.760	0.948	0.232	0.183
Mode 5	5210.0	5.460	5.775	0.945	0.244	0.183
Mode 6	5180.0	5.500	5.660	0.972	0.125	0.182
Mode 7	5190.0	5.500	5.740	0.958	0.185	0.182
Mode 8	5210.0	5.460	5.740	0.951	0.217	0.183

Duty Cycle Graphs

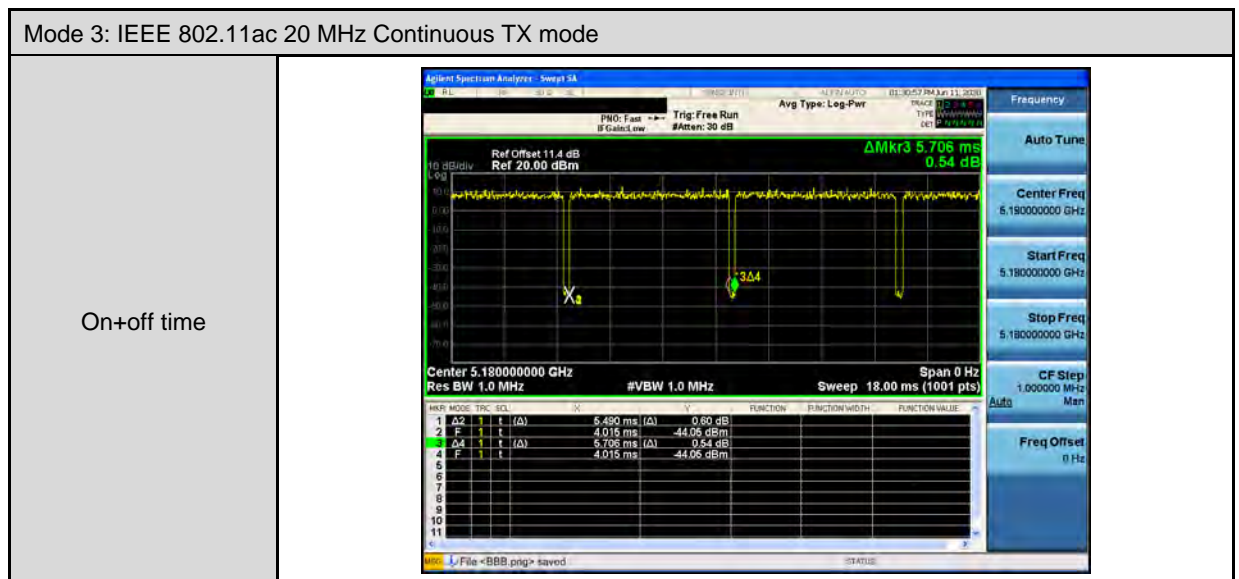
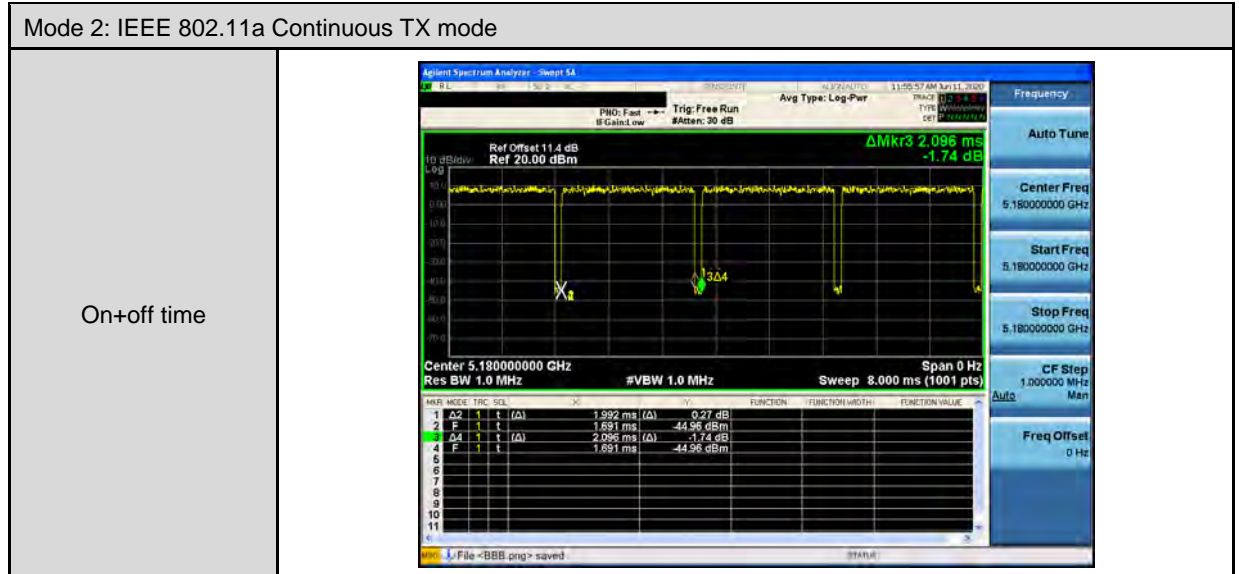

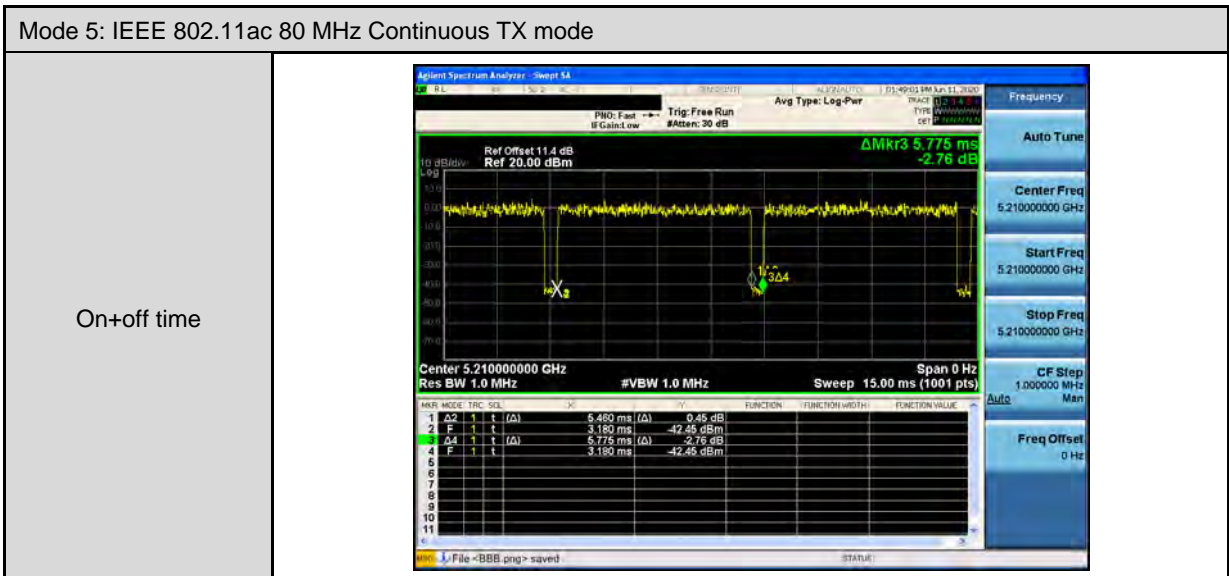
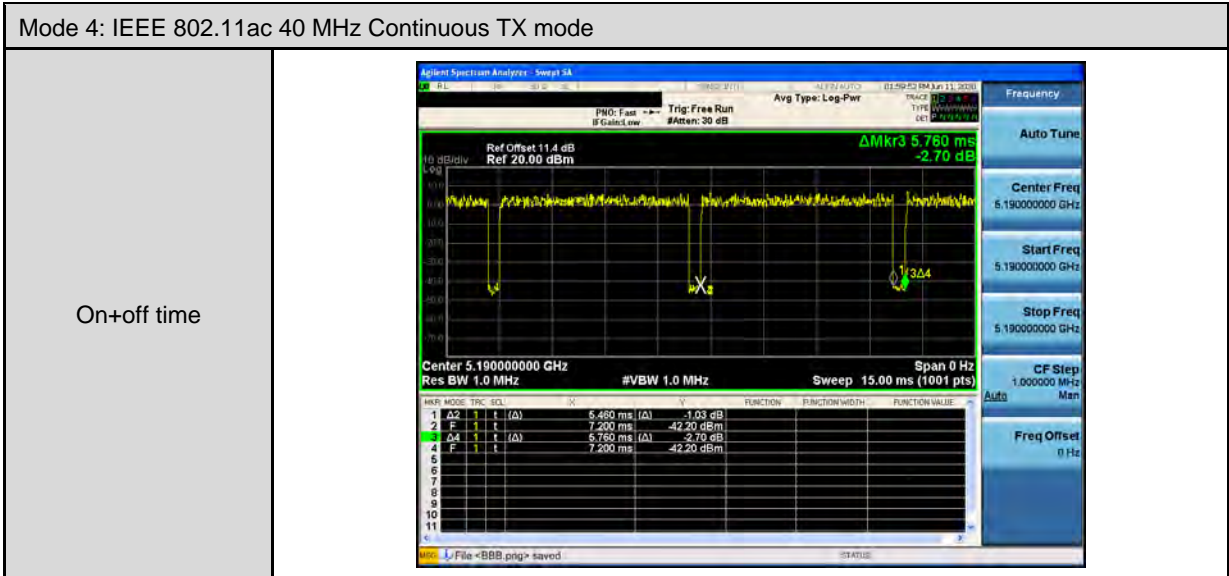

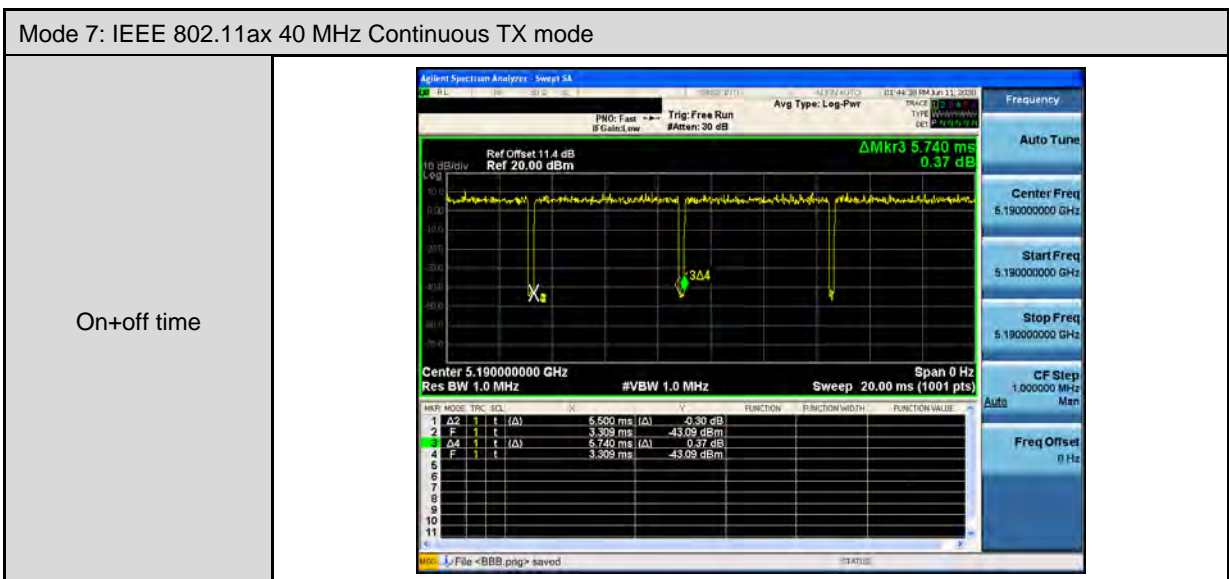
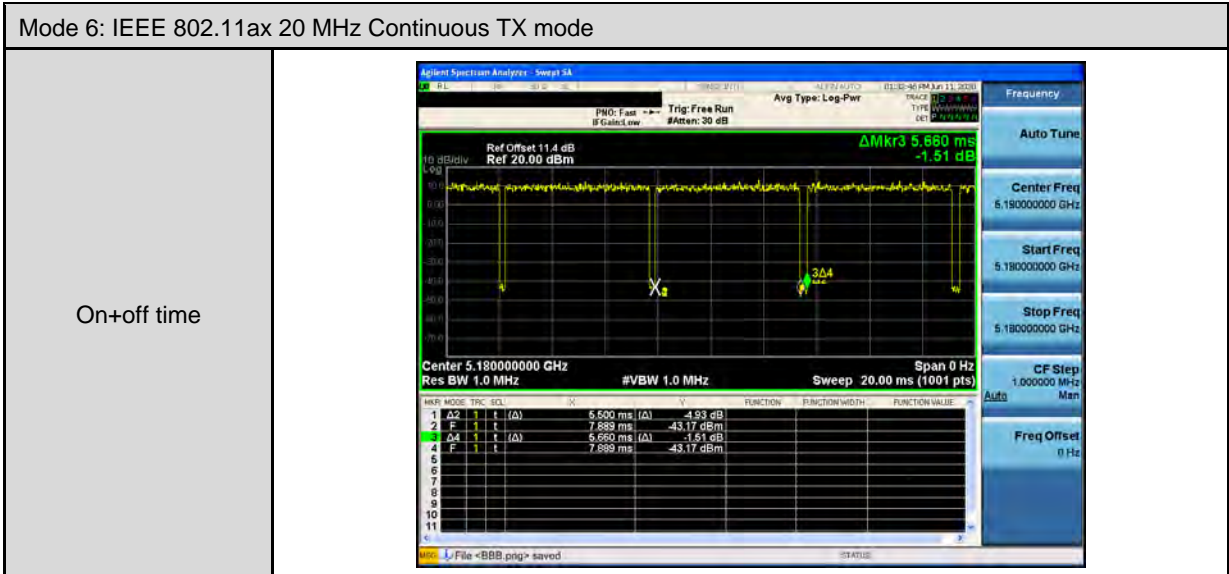

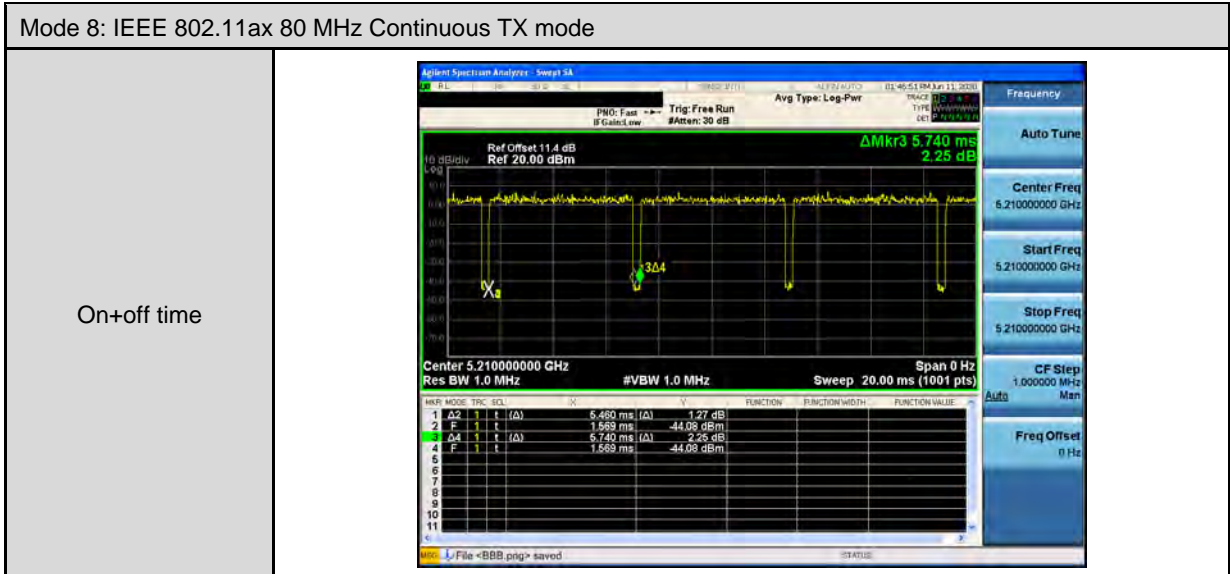

Beamforming on

Mode 3: IEEE 802.11ac 20 MHz Continuous TX mode

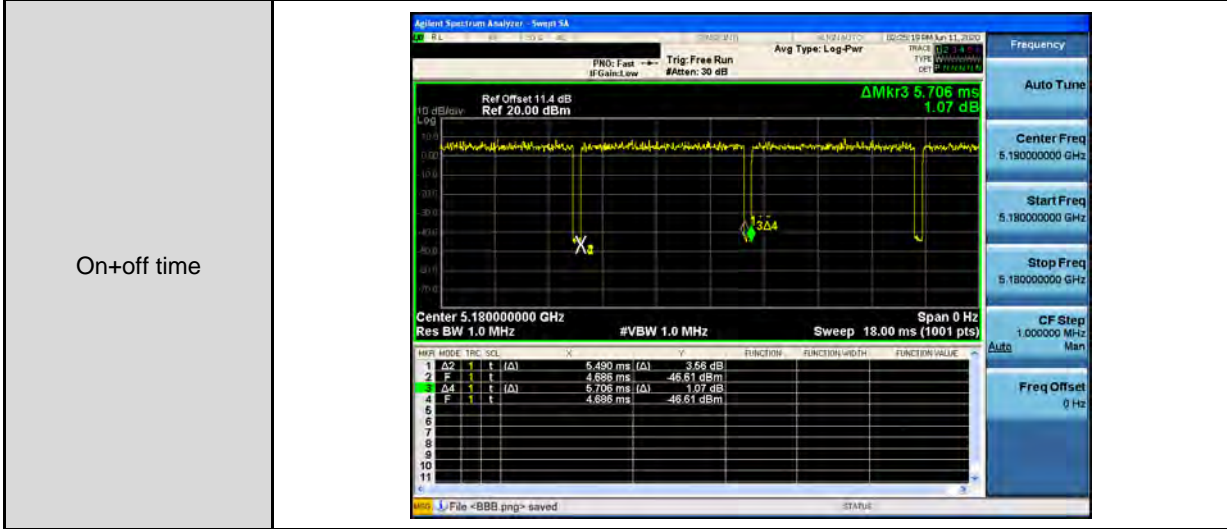

Mode 4: IEEE 802.11ac 40 MHz Continuous TX mode

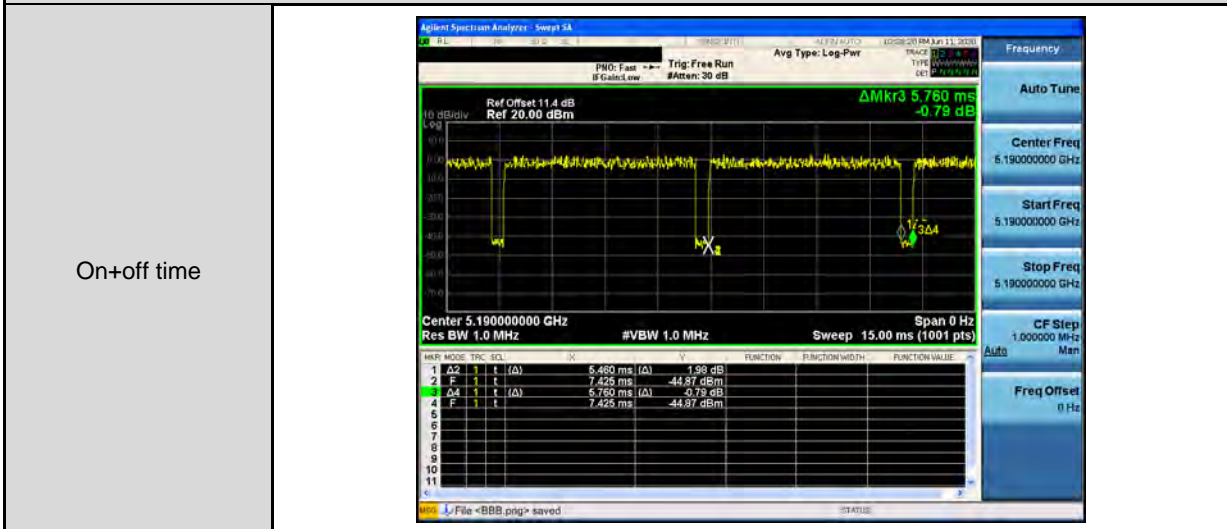

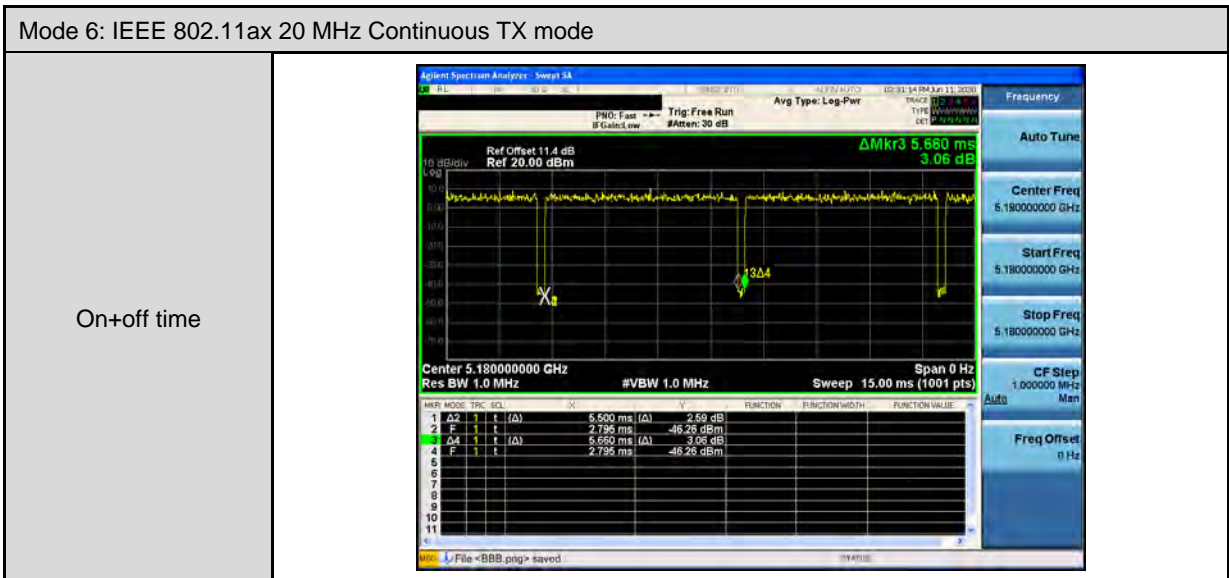
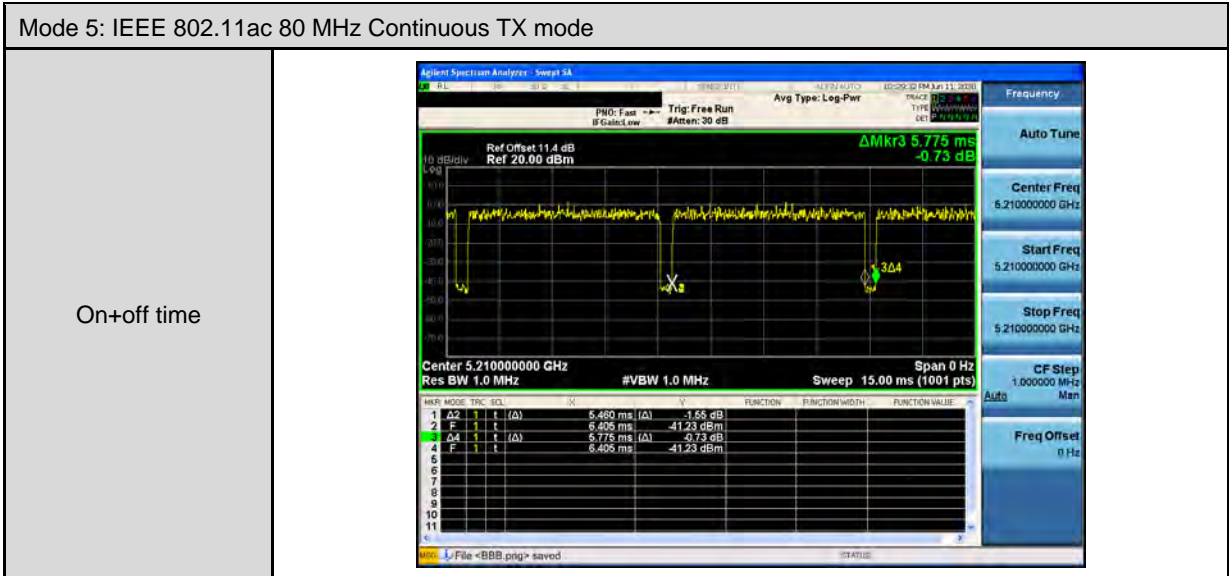

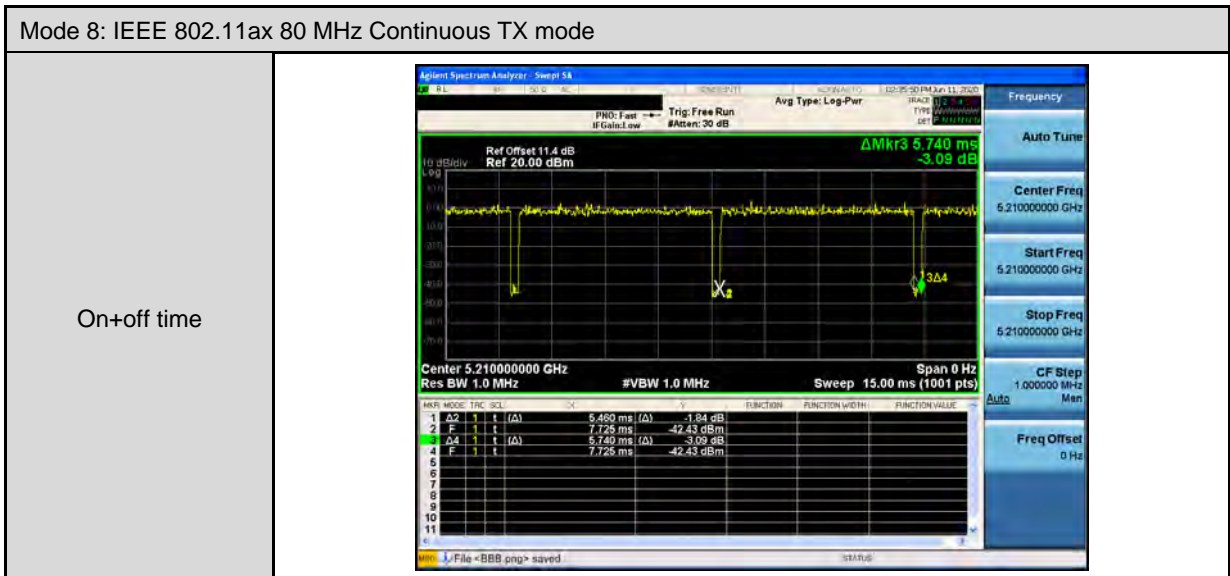
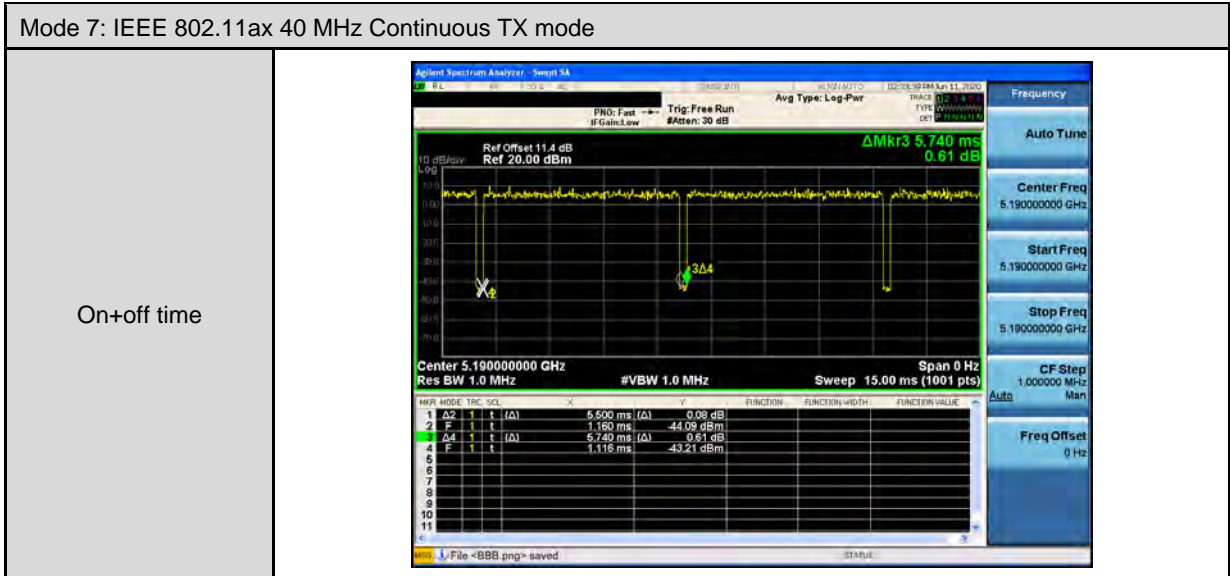



3.2. EUT Test Step

The EUT is operated in the engineering mode to fix the TX frequency for the purposes of measurement. According to its specifications, the EUT must comply with the requirements of Section 15.407 under the FCC Rules Part 15 Subpart E.

1.	Setup the EUT shown on "Configuration of Test System Details".
2.	Turn on the power of all equipment.
3.	Turn on TX function.
4.	EUT run test program.

Measurement Software			
No.	Description	Software	Version
1	Conducted Emission	EZ EMC	1.1.4.3
2	Radiated Emission	EZ EMC	1.1.4.4

3.3. Configuration of Test System Details

Conducted Emission

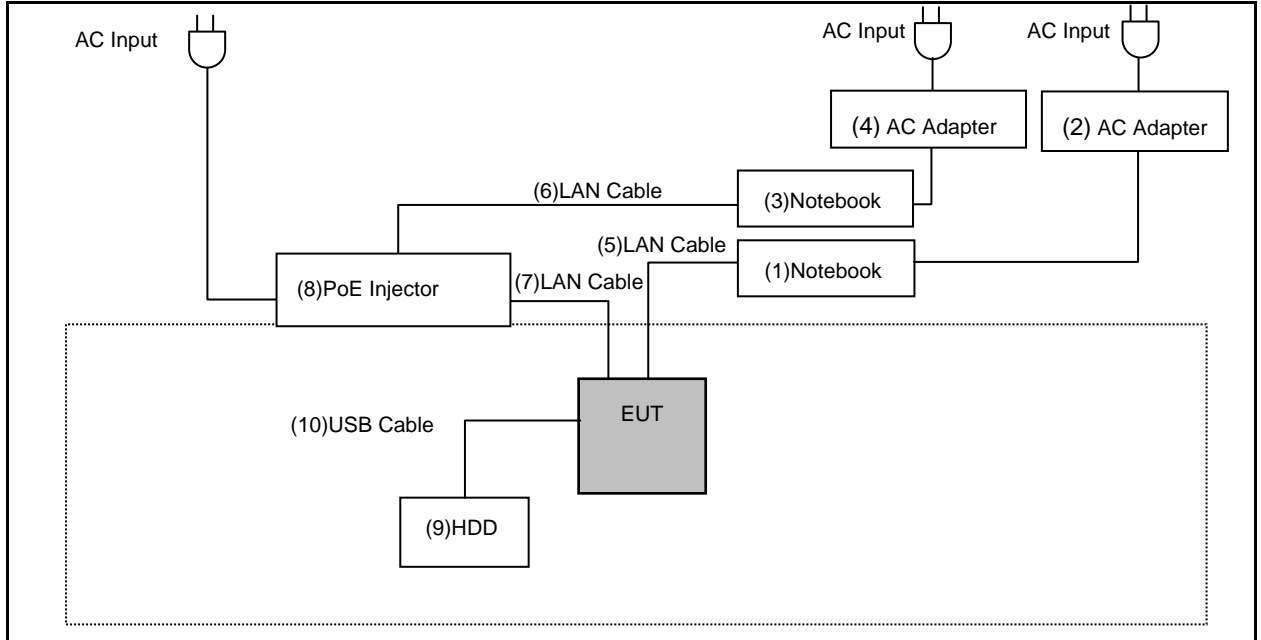

Radiated Emissions

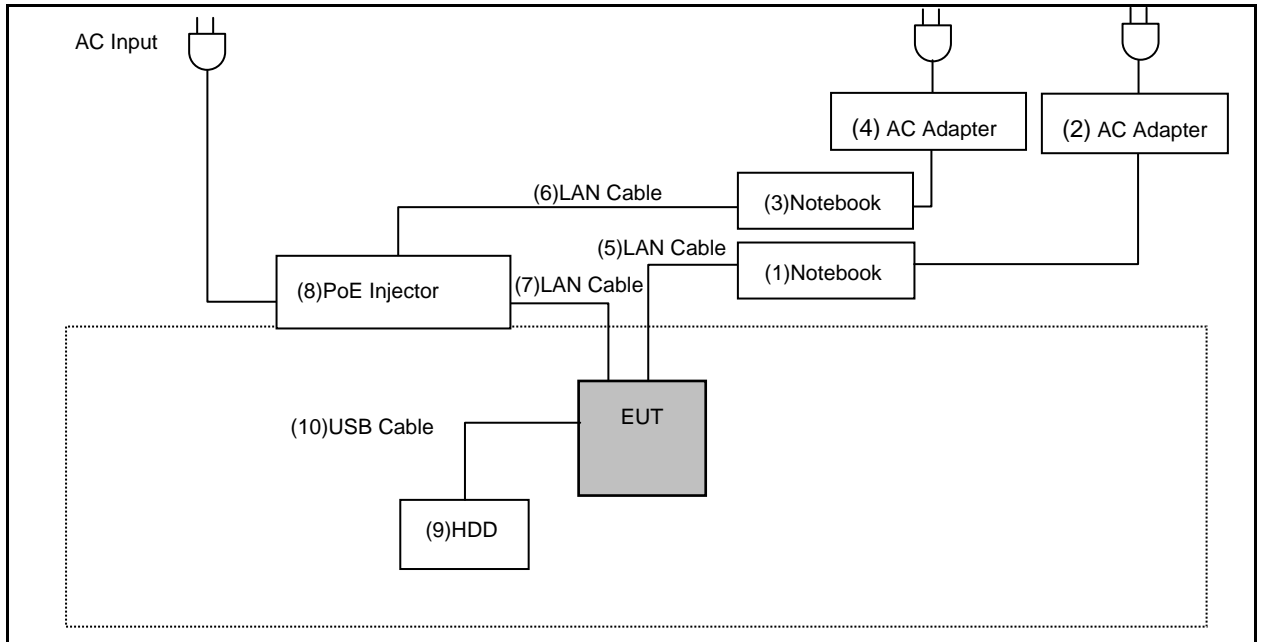



Devices Description					
	Product	Manufacturer	Model Number	Serial Number	Remark
(1)	Notebook	DELL	LATITUDE E6440	5HZBD72	---
(2)	AC Adapter	DELL	HA65NM130	---	INPUT : 100-240 VAC, 50/60 Hz, 1.7 A OUTPUT : 19.5 VDC, 3.34 A Non-Shielded, 1.7 m
(3)	Notebook	DELL	LATITUDE E6440	48GBD72	---
(4)	AC Adapter	DELL	HA65NM130	---	INPUT : 100-240 VAC, 50/60 Hz, 1.7 A OUTPUT : 19.5 VDC, 3.34 A Non-Shielded, 1.7 m
(5)	LAN Cable	WINKEY ENTERPRISE CO., LTD.	CY-SZ-141224	---	---
(6)	LAN Cable	WINKEY ENTERPRISE CO., LTD.	CY-SZ-141224	---	---
(7)	LAN Cable	HUAWEI	UL2464	---	---
(8)	PoE Injector	emplus	EPA5006GAT	---	INPUT : 100-240 VAC, 50-60 Hz, 0.8 A OUTPUT : 54 VDC, 0.6 A
(9)	HDD	Transend	TS1TSJ25A3K-RU	D72654-0611	---
(10)	USB Cable	Transend	TS1TSJ25A3K-RU	D72654-0611	---
(11)	AC Adapter	SPC	ZZU1588-250120-2A	---	INPUT : 100-240 VAC, 50-60 Hz, 1.5 A OUTPUT : 12.0 VDC, 2.5 A

Note: The device used (11)AC Adapter and (8)PoE Injector to evaluation AC Power line Conducted Emission, (8)POE Injector is worst case to perform testing.



3.4. Test Instruments

For Conducted Emission

Test Period: Jul. 10, 2020

Testing Engineer: Paul Chiu

Equipment	Manufacturer	Model Number	Serial Number	Cal. Date	Cal. Period
Test Receiver	R&S	ESCI	100367	05/25/2020	1 year
LISN	R&S	ENV216	101040	03/23/2020	1 year
LISN	R&S	ENV216	101041	04/06/2020	1 year
RF Cable	Woken	00100D1380194M	TE-02-03	05/25/2020	1 year

For Radiated Emissions

Test Period: Jun. 03 ~ Jul. 04, 2020

Testing Engineer: Ricky Liu / J.S. Liao / Marc Yeh

Equipment	Manufacturer	Model Number	Serial Number	Cal. Date	Cal. Period
Spectrum Analyzer (10 Hz~44 GHz)	Keysight	N9010A	MY52221312	01/13/2020	1 year
Pre Amplifier (1~26.5 GHz)	Agilent	8449B	3008A02237	10/18/2019	1 year
Pre Amplifier (100 kHz~1.3 GHz)	Agilent	8447D	2944A11119	01/15/2020	1 year
Broadband Antenna	Schwarzbeck	VULB9168	416	10/23/2019	1 year
Horn Antenna (1~18 GHz)	SCHWARZBECK MESS-ELEKTRONIK	BBHA9120D	9120D-550	08/22/2019	1 year
Horn Antenna (18~40 GHz)	SCHWARZBECK MESS-ELEKTRONIK	BBHA9170	9170-320	08/14/2019	1 year
Loop Antenna	COM-POWER CORPORATION	AL-130	121014	03/27/2020	1 year
RF Cable	EMCI	EMC104-N-N-6000	TE01-1	02/20/2020	1 year
Microwave Cable	EMCI	EMC104-SM-SM-1 3000	170814	10/29/2019	1 year
Microwave Cable	EMCI	EMC102-KM-KM-1 4000	151001	02/20/2020	1 year

Note: N.C.R. = No Calibration Request.



For Conducted

Test Period: Jun. 10 ~ Jun. 20, 2020

Testing Engineer: Peter Shui

Equipment	Manufacturer	Model Number	Serial Number	Cal. Date	Cal. Period
Power Sensor	Anritsu	MA2411B	1126022	09/02/2019	1 year
Power Meter	Anritsu	ML2495A	1135009	09/02/2019	1 year
Spectrum Analyzer (20 Hz~26.5 GHz)	Agilent	N9020A	US47520902	09/18/2019	1 year

Note: N.C.R. = No Calibration Request.

3.5. Test Site Environment

Items	Required (IEC 60068-1)	Actual
Temperature (°C)	15-35	20-30
Humidity (%RH)	25-75	45-75

4 Measurement Procedure

4.1. AC Power Conducted Emission Measurement

■ Limit

Frequency (MHz)	Quasi-peak	Average
0.15 - 0.5	66 to 56	56 to 46
0.50 - 5.0	56	46
5.0 - 30.0	60	50

■ Test Setup

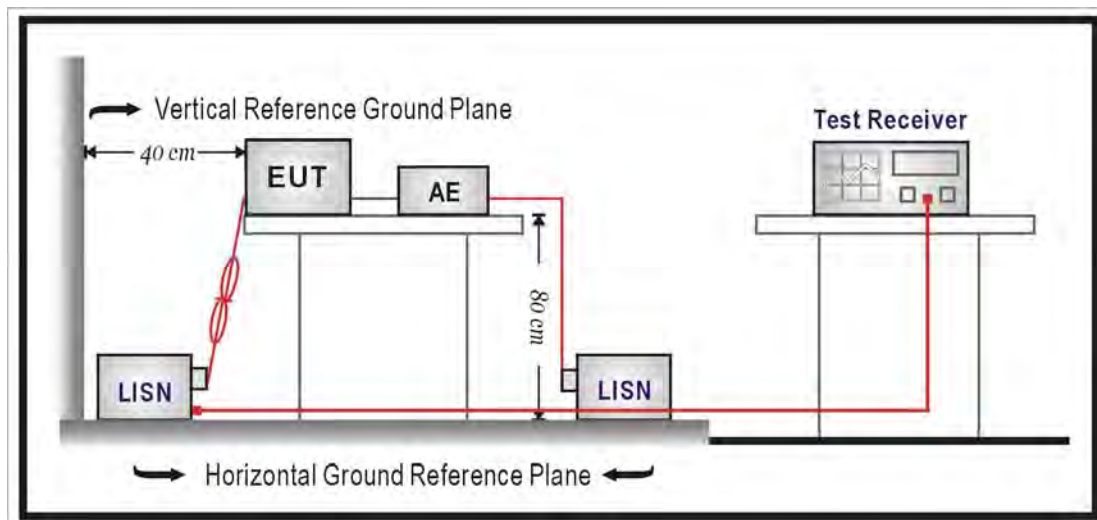

■ Test Procedure

The EUT and simulators are connected to the main power through a line impedance stabilization network (L.I.S.N.). This provides a $50 \Omega // 50 \mu\text{H}$ coupling impedance for the measuring equipment. The peripheral devices are also connected to the main power through a LISN that provides a $50 \Omega // 50 \mu\text{H}$ coupling impedance with 50 ohm termination.

Tabletop device shall be placed on a non-conducting platform, of nominal size 1 m by 1.5 m, raised 80 cm above the reference ground plane. The wall of screened room shall be located 40 cm to the rear of the EUT. Other surfaces of tabletop or floor standing EUT shall be at least 80 cm from any other ground conducting surface including one or more LISNs. For floor-standing device shall be placed under the EUT with a 12 mm insulating material.

Conducted emissions were investigated over the frequency range from 0.15 MHz to 30 MHz using a resolution bandwidth of 9 kHz. The equipment under test (EUT) shall be meet the limits in section 4.1, as applicable, including the average limit and the quasi-peak limit when using respectively, an average detector and quasi-peak detector measured in accordance with the methods described of related standard. When all of peak value were complied with quasi-peak and average limit from 150 kHz to 30 MHz then quasi-peak and average measurement was unnecessary.

The AMN shall be placed 0.8 m from the boundary of the unit under test and bonded to a ground reference plane for AMNs mounted on top of the ground reference plane. This distance is between the closest points of the AMN and the EUT. All other units of the EUT and associated equipment shall be at least 0.8 m from the AMN. If the mains power cable is longer than 1 m then the cable shall be folded back and forth at the centre of the lead to form a bundle no longer than 0.4 m. All of interconnecting cables that hang closer than 40 cm to the ground plane shall be folded back and forth in the center forming a bundle 30 cm to 40 cm long. All of EUT and AE shall be separate place more than 0.1 m. All 50Ω ports of the LISN shall be resistively terminated into 50Ω loads when not connected to the measuring instrument.

If the reading of the measuring receiver shows fluctuations close to the limit, the reading shall be observed for at least 15 s at each measurement frequency; the higher reading shall be recorded with the exception of any brief isolated high reading which shall be ignored

4.2. Transmitter Radiated Emissions Measurement

■ Limit

(1) Undesirable emission limits. Except as shown in paragraph (b)(7) of this section, the maximum emissions outside of the frequency bands of operation shall be attenuated in accordance with the following limits:

(a) For transmitters operating in the 5.15-5.25 GHz band: All emissions outside of the 5.15-5.35 GHz band shall not exceed an e.i.r.p. of -27 dBm/MHz.

(b) For transmitters operating in the 5.25-5.35 GHz band: All emissions outside of the 5.15-5.35 GHz band shall not exceed an e.i.r.p. of -27 dBm/MHz.

(c) For transmitters operating in the 5.47-5.725 GHz band: All emissions outside of the 5.47-5.725 GHz band shall not exceed an e.i.r.p. of -27 dBm/MHz.

(d) For transmitters operating in the 5.725-5.85 GHz band:

(i) All emissions shall be limited to a level of -27 dBm/MHz at 75 MHz or more above or below the band edge increasing linearly to 10 dBm/MHz at 25 MHz above or below the band edge, and from 25 MHz above or below the band edge increasing linearly to a level of 15.6 dBm/MHz at 5 MHz above or below the band edge, and from 5 MHz above or below the band edge increasing linearly to a level of 27 dBm/MHz at the band edge.

(2) Limits of Radiated Emission Measurement

Emissions radiated outside of the specified bands, shall be according to the general radiated limits in 15.209 as following:

Frequency Range (MHz)	Field Strength (microvolts/meter)	Measurement Distance (meters)
0.009 ~ 0.490	2400/F(kHz)	300
0.490 ~ 1.705	24000/F(kHz)	30
1.705 ~ 30.0	30	30
30 ~ 88	10	3
88 ~ 216	150	3
216 ~ 960	200	3
Above 960	500	3

- Note:
1. The lower limit shall apply at the transition frequencies.
 2. Emission level (dBuV/m) = 20 log Emission level (uV/m).
 3. As shown in 15.35(b), for frequencies above 1000 MHz, the field strength limits are based on average detector, however, the peak field strength of any emission shall not exceed the maximum permitted average limits, specified above by more than 20 dB under any condition of modulation.

■ Setup

9 kHz ~ 30 MHz

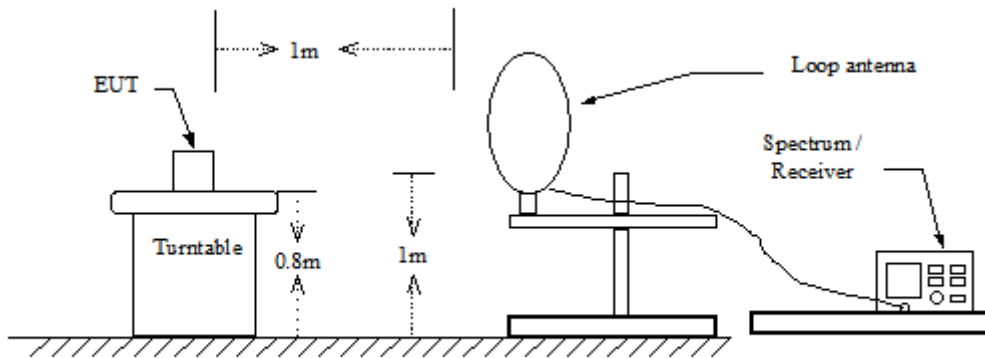

30 MHz ~ 1 GHz

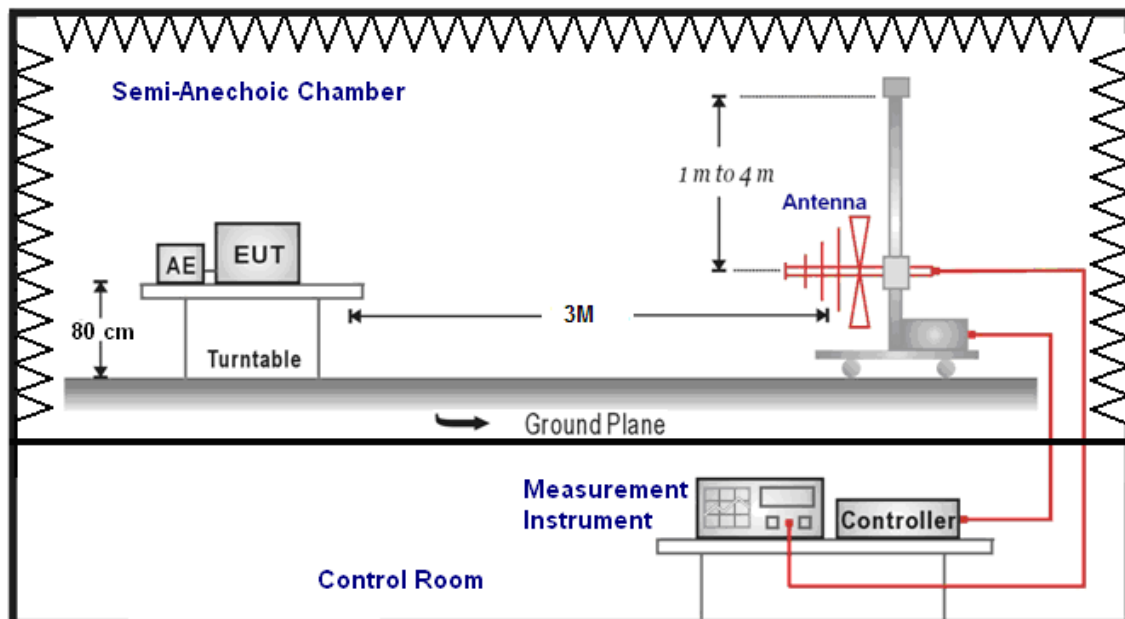

Above 1 GHz

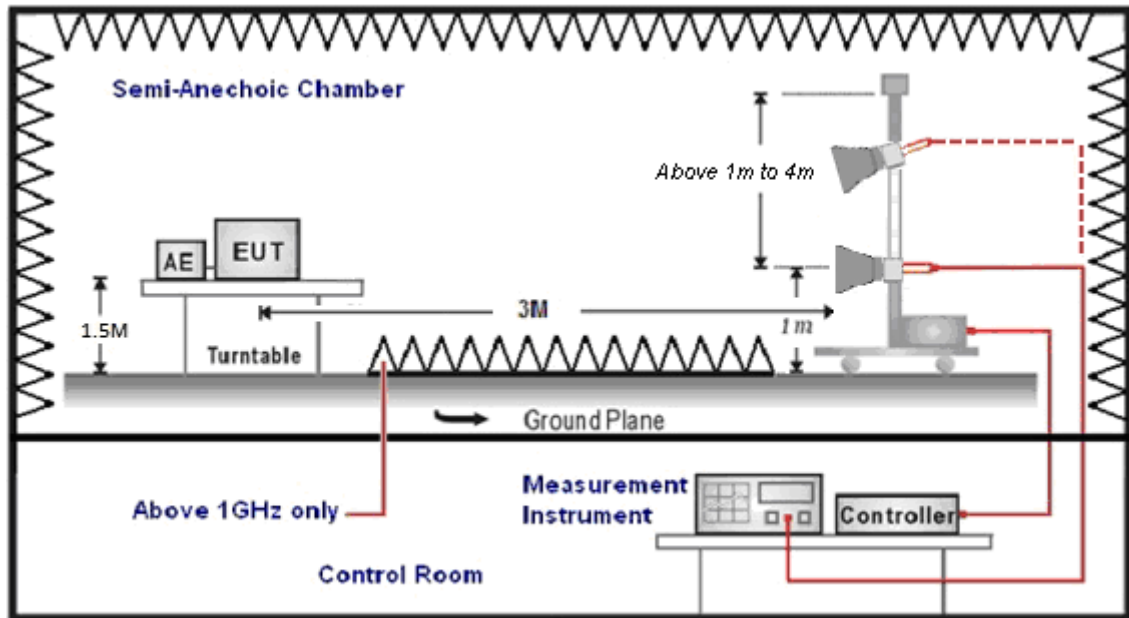

■ Test Procedure

Final radiation measurements were made on a three-meter, Semi Anechoic Chamber. The EUT system was placed on a nonconductive turntable which is 0.8 or 1.5 meters height (below 1 GHz use 0.8 m turntable / above 1 GHz use 1.5 m turntable), top surface 1.0 x 1.5 meter. The spectrum was examined from 250 MHz to 2.5 GHz in order to cover the whole spectrum below 10th harmonic which could generate from the EUT. During the test, EUT was set to transmit continuously & Measurements spectrum range from 9 kHz to 40 GHz is investigated.

For measurements below 1 GHz the resolution bandwidth is set to 100 kHz for peak detection measurements or 120 kHz for quasi-peak detection measurements. Peak detection is used unless otherwise noted as quasi-peak.

For restricted measurements above 1 GHz the resolution bandwidth is set to 1 MHz, and then the video bandwidth is set to 3 MHz for peak measurements and 10 Hz for average measurements when Duty cycle > 0.98 / 1/T for average measurements when Duty cycle < 0.98.

For out of band measurements above 1 GHz the resolution bandwidth is set to 1 MHz, and then the video bandwidth is set to 3 MHz for peak measurements.

A nonconductive material surrounded the EUT to supporting the EUT for standing on three orthogonal planes. At each condition, the EUT was rotated 360 degrees, and the antenna was raised and lowered from one to four meters to find the maximum emission levels. Measurements were taken using both horizontal and vertical antenna polarization.

SCHWARZBECK MESS-ELEKTRONIK Trilog-Broadband Antenna at 3 Meter and the ETS-Lindgren Double-Ridged Waveguide Horn antenna Schwarzbeck Mess-Elektronik Broadband Horn Antenna was used in frequencies 1 – 40 GHz at a distance of 3 meter. The antenna at an angle toward the source of the emission. All test results were extrapolated to equivalent signal at 3 meters utilizing an inverse linear distance extrapolation Factor (20 dB/decade).

For testing above 1 GHz, the emission level of the EUT in peak mode was 20 dB lower than average limit (that means the emission level in peak mode also complies with the limit in average mode), then testing will be stopped and peak values of EUT will be reported, otherwise, the emissions will be measured in average mode again and reported.

Appropriate preamplifiers were used for improving sensitivity and precautions were taken to avoid overloading or desensitizing the spectrum analyzer. No post – detector video filters were used in the test.

The spectrum analyzer's 6 dB bandwidth was set to 1 MHz, and the analyzer was operated in the peak detection mode, for frequencies both below and up 1 GHz. The average levels were obtained by subtracting the duty cycle correction factor from the peak readings.

The following procedures were used to convert the emission levels measured in decibels referenced to 1 microvolt (dBuV) into field intensity in micro volts per meter (uV/m).

The actual field intensity in decibels referenced to 1 microvolt in to field intensity in micro volts per meter (dBuV/m).



The actual field is intensity in referenced to 1 microvolt per meter (dBuV/m) is determined by algebraically adding the measured reading in dBuV, the antenna factor (dB), and cable loss (dB) and Subtracting the gain of preamplifier (dB) is auto calculate in spectrum analyzer.

(1) $\text{Amplitude (dBuV/m)} = \text{FI (dBuV)} + \text{AF (dBuV)} + \text{CL (dBuV)} - \text{Gain (dB)}$

FI= Reading of the field intensity.

AF= Antenna factor.

CL= Cable loss.

P.S Amplitude is auto calculate in spectrum analyzer.

(2) $\text{Actual Amplitude (dBuV/m)} = \text{Amplitude (dBuV)} - \text{Dis(dB)}$

The FCC specified emission limits were calculated according the EUT operating frequency and by following linear interpolation equations:

(a) For fundamental frequency : Transmitter Output < +30 dBm

(b) For spurious frequency : Spurious emission limits = fundamental emission limit /10

Measuring Instruments and setting

The following table is the setting of spectrum analyzer and receiver.

Spectrum Parameter	Setting
Attenuation	Auto
Start Frequency	1000 MHz
Stop Frequency	40 GHz
RBW/VBW(Emission in restricted band)	1 MHz / 3 MHz for Peak 1 MHz / (1/T) for Average
RBW/VBW(Emission in non-restricted band)	1 MHz / 3 MHz for Peak

4.3. Maximum Conducted Output Power Measurement

■ **Limit**

Frequency Range (MHz)	FCC Maximum Conducted Output Power Limit
	Master
5.150 ~ 5.250 GHz	The lesser of 1 W (30 dBm)
5.725 ~ 5.850 GHz	The lesser of 1 W (30 dBm)

According FCC KDB 662911 D01 v02r01 – for power measurements on IEEE802.11 devices,

CDD and STBC mode:

5.150 ~ 5.250 GHz

Directional = $G_{ANT}=10*\log\{[10^{(G1/10)}+10^{(G2/10)}+\dots+10^{(Gn/10)}]/NANT\}$ = 4.64 dBi < 6dBi

5.725 ~ 5.850 GHz

Directional = $G_{ANT}=10*\log\{[10^{(G1/10)}+10^{(G2/10)}+\dots+10^{(Gn/10)}]/NANT\}$ = 4.68 dBi < 6dBi

BF mode:

5.150 ~ 5.250 GHz

Directional Gain = $10*\log\{[10^{(G1/20)}+10^{(G2/20)}+\dots+10^{(Gn/20)}]^2/NANT\}$ = 10.65 dBi > 6dBi

* power limit shall be reduced = 30 - 4.65 = 25.35 dBm

5.725 ~ 5.850 GHz

Directional Gain = $10*\log\{[10^{(G1/20)}+10^{(G2/20)}+\dots+10^{(Gn/20)}]^2/NANT\}$ = 10.69 dBi > 6dBi

* power limit shall be reduced = 30 - 4.69 = 25.31 dBm

■ **Test Setup**

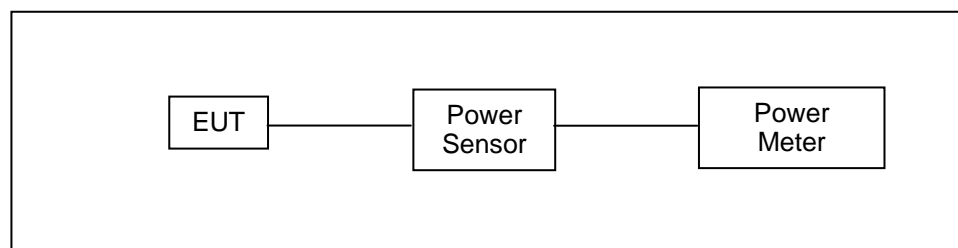

■ **Test Procedure**

The test is performed in accordance with ANSI C63.10:2013 section 12.3.3.2, Guidelines for Compliance Testing of Unlicensed National Information Infrastructure (U-NII) Devices

Section (E) Maximum Conducted Output Power

3. Measurement using a Power Meter (PM)

b) Method PM-G (Measurement using a gated RF average power meter)

4.4. 26 dB RF Bandwidth Measurement & 99 % Occupied Bandwidth Measurement

■ **Limit**

N/A

■ **Test Setup**

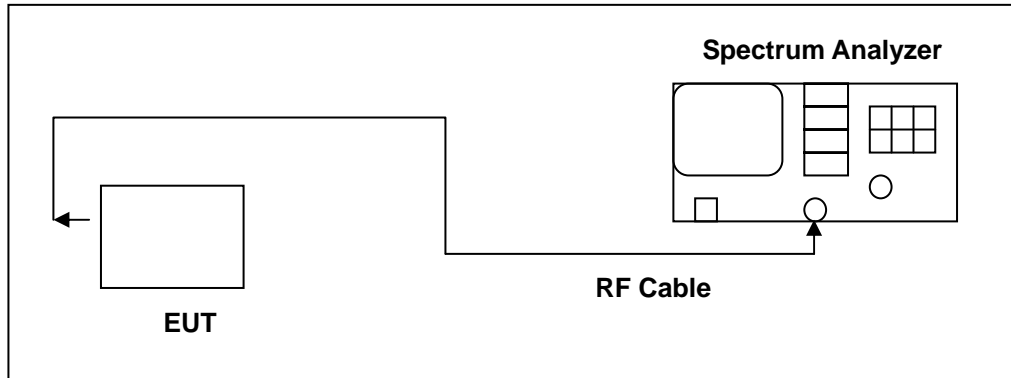

■ **Test Procedure**

The test is performed in accordance with ANSI C63.10:2013 section 12.4, Guidelines for Compliance Testing of Unlicensed National Information Infrastructure (U-NII) Devices - Part 15, Subpart E.

Spectrum Parameter	Setting
Attenuation	Auto
Span Frequency	>26 dB Bandwidth
RBW	Approximately 1 % of the emission bandwidth
VBW	VBW > RBW
Detector	Peak
Trace	Max Hold
Sweep Time	Auto

4.5. 6 dB RF Bandwidth Measurement

- **Limit**

- **6 dB RF Bandwidth**

Systems using digital modulation techniques may operate in the 5725~5850 MHz bands. The minimum 6 dB band-width shall be at least 500 kHz.

- **Test Setup**

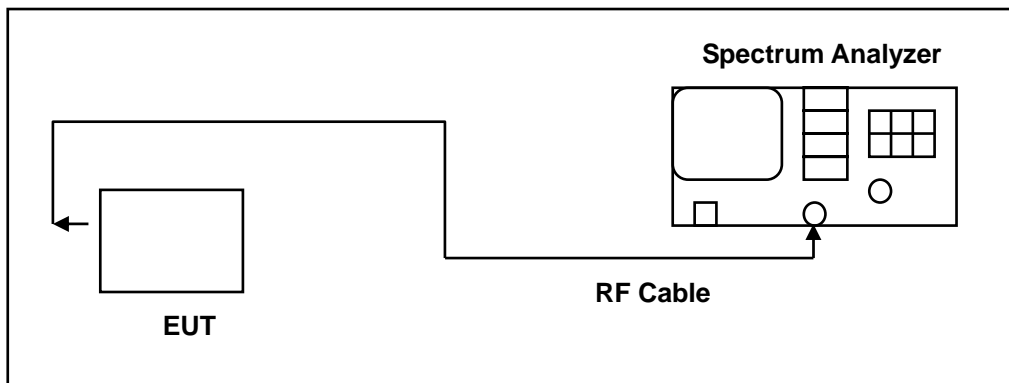

- **Test Procedure**

- **6 dB RF Bandwidth**

The EUT tested to UNII test procedure of ANSI C63.10:2013 section 6.9.2 for compliance to FCC 47CFR 15.407 requirements.

The antenna port of the EUT was connected to the input of a spectrum analyzer. Analyzer RES BW was set to 100 kHz. For each RF output channel investigated, the spectrum analyzer center frequency was set to the channel carrier. A peak output reading was taken, a DISPLAY line was drawn 6 dB lower than peak level. The 6 dB bandwidth was determined from where the channel output spectrum intersected the display line.

The test was performed at 3 channels.

4.6. Maximum Power Spectral Density Measurement

■ Limit

Frequency Range (MHz)	FCC Limit
	Master
5.150 ~ 5.250 GHz	17 dBm/MHz
5.725 ~ 5.850 GHz	30 dBm/500 kHz

According FCC KDB 662911 D01 v02r01 – for power spectral density measurements on IEEE802.11 devices,

STBC mode:

5.150 ~ 5.250 GHz

Directional = $G_{ANT}=10*\log\{[10^{(G1/10)}+10^{(G2/10)}+\dots+10^{(Gn/10)}]/NANT\}$ = 4.64 dBi < 6dBi

5.725 ~ 5.850 GHz

Directional = $G_{ANT}=10*\log\{[10^{(G1/10)}+10^{(G2/10)}+\dots+10^{(Gn/10)}]/NANT\}$ = 4.68 dBi < 6dBi

CDD/BF mode:

5.150 ~ 5.250 GHz

Directional Gain = $10*\log\{[10^{(G1/20)}+10^{(G2/20)}+\dots+10^{(Gn/20)}]^2/NANT\}$ = 10.65 dBi > 6dBi

* power spectral density limit shall be reduced = 17 – 4.65 = 12.35 dBm/MHz

5.725 ~ 5.850 GHz

Directional Gain = $10*\log\{[10^{(G1/20)}+10^{(G2/20)}+\dots+10^{(Gn/20)}]^2/NANT\}$ = 10.69 dBi > 6dBi

* power spectral density limit shall be reduced = 30 – 4.69 = 25.31 dBm/500 kHz

■ Test Setup

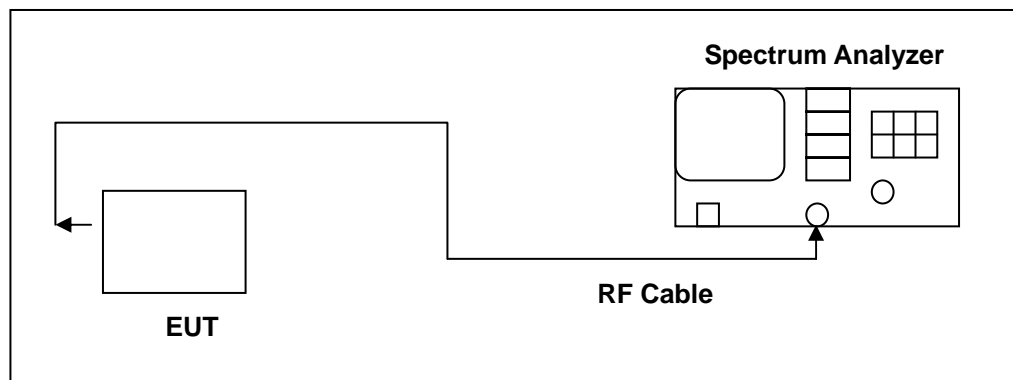



■ **Test Procedure**

The test is performed in accordance with ANSI C63.10:2013 section 12.5, Guidelines for Compliance Testing of Unlicensed National Information Infrastructure (U-NII) Devices - Part 15, Subpart E.

Spectrum Parameter	Setting
Attenuation	Auto
Span Frequency	Encompass the entire emissions bandwidth (EBW) of the signal
RBW	1 MHz (5725 ~ 5850 MHz use 100 kHz)
VBW	3 MHz (5725 ~ 5850 MHz use 300 kHz)
Detector	RMS
Trace	AVERAGE
Sweep Time	Auto
Trace Average	100 times
Note: If measurement bandwidth of Maximum PSD is specified in 500 kHz, add $10 \log(500 \text{ kHz}/100 \text{ kHz})$ to the measured result.	



4.7. Automatically discontinue transmission

The device shall automatically discontinue transmission in case of either absence of information to transmit or operational failure. These provisions are not intended to preclude the transmission of control or signalling information or the use of repetitive codes used by certain digital technologies to complete frame or burst intervals. Applicants shall include in their application for equipment authorization a description of how this requirement is met.

- **Declare**

While the EUT is not transmitting any information, the EUT can automatically discontinue transmission and become standby mode for power saving.

The EUT can detect the controlling signal of ACK message transmitting from remote device and verify whether it shall resend or discontinue transmission.

4.8. Antenna Requirement

- **Limit**

For intentional device, according to 15.203, an intentional radiator shall be designed to ensure that no antenna other than that furnished by the responsible party shall be used with the device.

And According to 15.407 (a), if transmitting antennas of directional gain greater than 6 dBi are used, the power shall be reduced by the amount in dB that the directional gain of the antenna exceeds 6 dBi.

- **Antenna Connector Construction**

See section 2 – antenna information.



■ **Directional Gain Calculated**

For Maximum Conducted Output Power

Operate Freq. Band		Directional Gain (dBi)
IEEE 802.11a	U-NII Band I	4.64
	U-NII Band III	4.68
IEEE 802.11ac 20 MHz	U-NII Band I	4.64
	U-NII Band III	4.68
IEEE 802.11ac 40 MHz	U-NII Band I	4.64
	U-NII Band III	4.68
IEEE 802.11ac 80 MHz	U-NII Band I	4.64
	U-NII Band III	4.68
IEEE 802.11ax 20 MHz	U-NII Band I	4.64
	U-NII Band III	4.68
IEEE 802.11ax 40 MHz	U-NII Band I	4.64
	U-NII Band III	4.68
IEEE 802.11ax 80 MHz	U-NII Band I	4.64
	U-NII Band III	4.68

For Maximum Power Density

Operate Freq. Band		Directional Gain (dBi)
IEEE 802.11a	U-NII Band I	10.65
	U-NII Band III	10.69
IEEE 802.11ac 20 MHz	U-NII Band I	4.64
	U-NII Band III	4.68
IEEE 802.11ac 40 MHz	U-NII Band I	4.64
	U-NII Band III	4.68
IEEE 802.11ac 80 MHz	U-NII Band I	4.64
	U-NII Band III	4.68
IEEE 802.11ax 20 MHz	U-NII Band I	4.64
	U-NII Band III	4.68
IEEE 802.11ax 40 MHz	U-NII Band I	4.64
	U-NII Band III	4.68
IEEE 802.11ax 80 MHz	U-NII Band I	4.64
	U-NII Band III	4.68



Beamforming on

For Maximum Conducted Output Power

Operate Freq. Band		Directional Gain (dBi)
IEEE 802.11ac 20 MHz	U-NII Band I	10.65
	U-NII Band III	10.69
IEEE 802.11ac 40 MHz	U-NII Band I	10.65
	U-NII Band III	10.69
IEEE 802.11ac 80 MHz	U-NII Band I	10.65
	U-NII Band III	10.69
IEEE 802.11ax 20 MHz	U-NII Band I	10.65
	U-NII Band III	10.69
IEEE 802.11ax 40 MHz	U-NII Band I	10.65
	U-NII Band III	10.69
IEEE 802.11ax 80 MHz	U-NII Band I	10.65
	U-NII Band III	10.69

For Maximum Power Density

Operate Freq. Band		Directional Gain (dBi)
IEEE 802.11ac 20 MHz	U-NII Band I	10.65
	U-NII Band III	10.69
IEEE 802.11ac 40 MHz	U-NII Band I	10.65
	U-NII Band III	10.69
IEEE 802.11ac 80 MHz	U-NII Band I	10.65
	U-NII Band III	10.69
IEEE 802.11ax 20 MHz	U-NII Band I	10.65
	U-NII Band III	10.69
IEEE 802.11ax 40 MHz	U-NII Band I	10.65
	U-NII Band III	10.69
IEEE 802.11ax 80 MHz	U-NII Band I	10.65
	U-NII Band III	10.69

5 Test Results

Annex A. Conducted Emission

POE Injector

Standard:	FCC Part 15.407	Line:	L1
Test item:	Conducted Emission	Power:	AC 120 V/60 Hz
Mode:	Mode 1		
Description:			

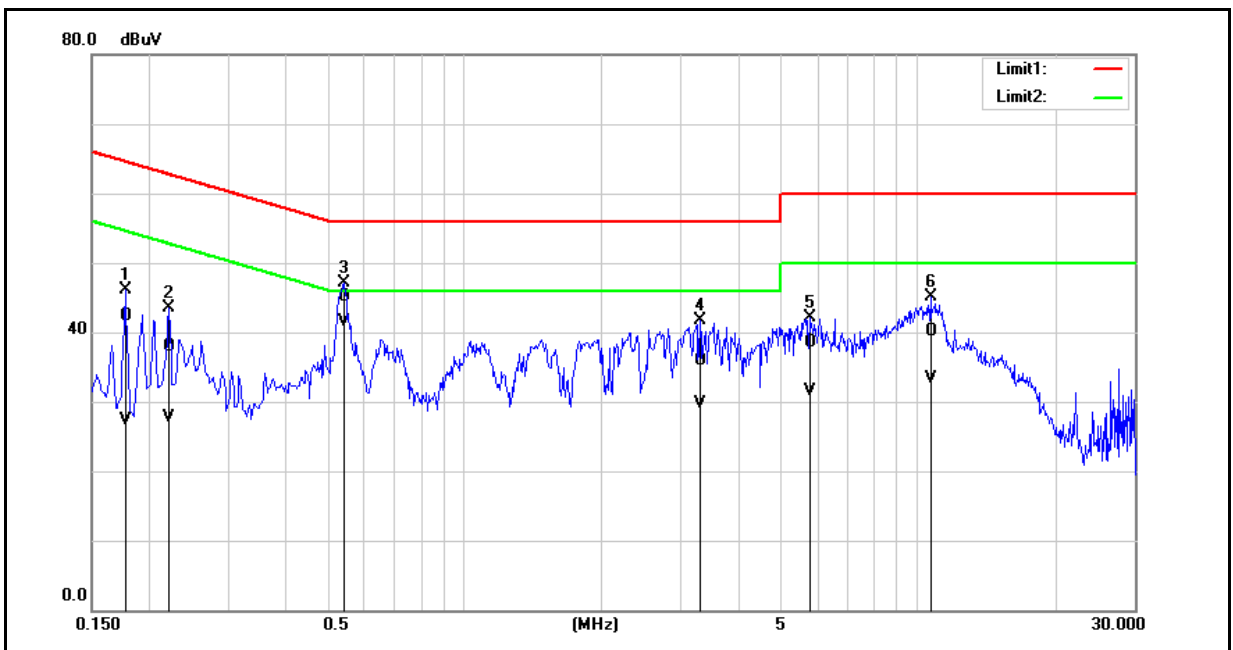

No.	Frequency (MHz)	QP reading (dBuV)	AVG reading (dBuV)	Correction factor (dB)	QP result (dBuV)	AVG result (dBuV)	QP limit (dBuV)	AVG limit (dBuV)	QP margin (dB)	AVG margin (dB)	Remark
1	0.1780	32.67	17.64	9.64	42.31	27.28	64.58	54.58	-22.27	-27.30	Pass
2	0.2220	28.26	18.15	9.64	37.90	27.79	62.74	52.74	-24.84	-24.95	Pass
3	0.5420	35.44	31.94	9.66	45.10	41.60	56.00	46.00	-10.90	-4.40	Pass
4	3.3020	26.16	20.01	9.75	35.91	29.76	56.00	46.00	-20.09	-16.24	Pass
5	5.7660	28.66	21.65	9.82	38.48	31.47	60.00	50.00	-21.52	-18.53	Pass
6	10.6380	30.13	23.49	9.91	40.04	33.40	60.00	50.00	-19.96	-16.60	Pass

Note: 1. Result (dBuV) = Correction factor (dB) + Reading(dBuV).

2. Correction factor (dB) = Cable loss (dB) + L.I.S.N. factor (dB).



Standard:	FCC Part 15.407	Line:	N
Test item:	Conducted Emission	Power:	AC 120 V/60 Hz
Mode:	Mode 1		
Description:			

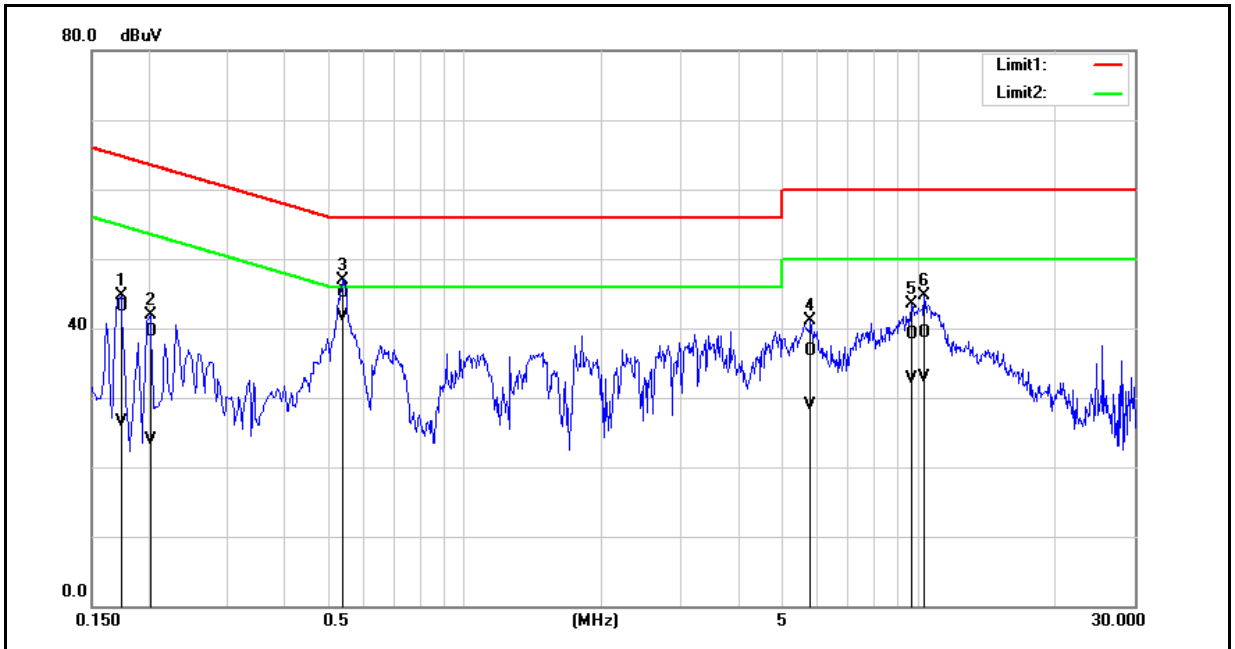

No.	Frequency (MHz)	QP reading (dBuV)	AVG reading (dBuV)	Correction factor (dB)	QP result (dBuV)	AVG result (dBuV)	QP limit (dBuV)	AVG limit (dBuV)	QP margin (dB)	AVG margin (dB)	Remark
1	0.1740	33.43	16.75	9.68	43.11	26.43	64.77	54.77	-21.66	-28.34	Pass
2	0.2020	29.76	14.19	9.67	39.43	23.86	63.53	53.53	-24.10	-29.67	Pass
3	0.5380	35.36	31.92	9.69	45.05	41.61	56.00	46.00	-10.95	-4.39	Pass
4	5.7900	26.82	19.10	9.86	36.68	28.96	60.00	50.00	-23.32	-21.04	Pass
5	9.6820	29.06	22.82	9.96	39.02	32.78	60.00	50.00	-20.98	-17.22	Pass
6	10.3060	29.28	22.92	9.96	39.24	32.88	60.00	50.00	-20.76	-17.12	Pass

Note: 1. Result (dBuV) = Correction factor (dB) + Reading(dBuV).
2. Correction factor (dB) = Cable loss (dB) + L.I.S.N. factor (dB).

AC Adapter

Standard:	FCC Part 15.407	Line:	L1
Test item:	Conducted Emission	Power:	AC 120 V/60 Hz
Mode:	Mode 1		
Description:			

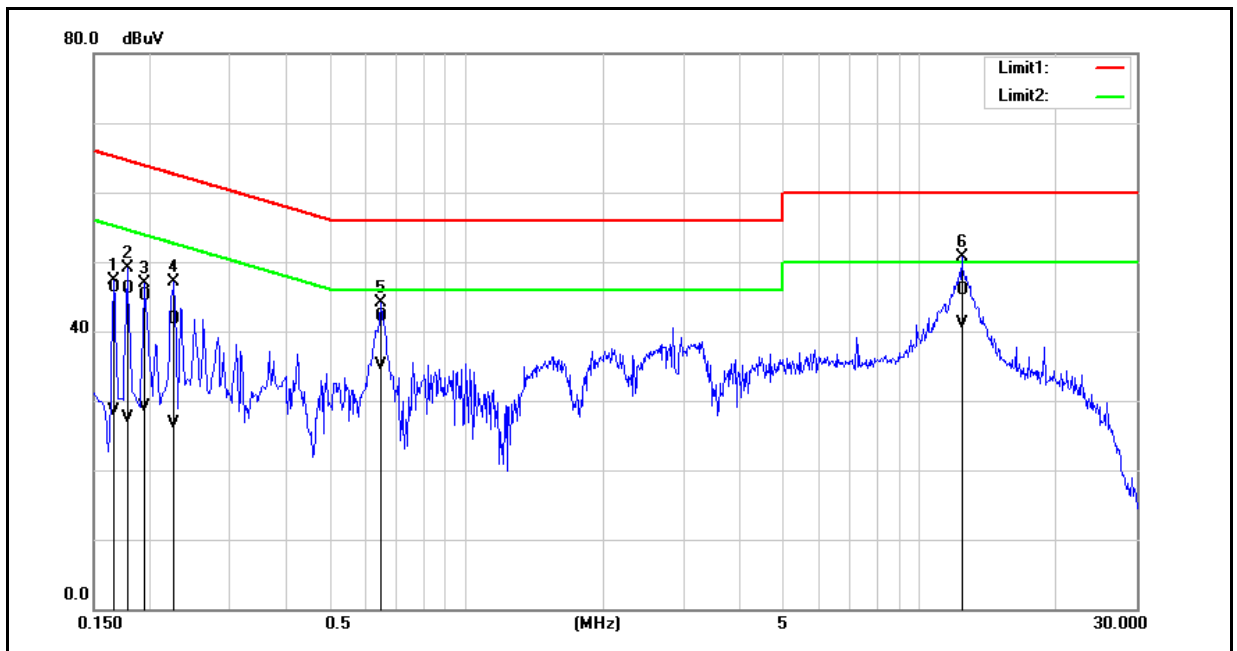

No.	Frequency (MHz)	QP reading (dBuV)	AVG reading (dBuV)	Correction factor (dB)	QP result (dBuV)	AVG result (dBuV)	QP limit (dBuV)	AVG limit (dBuV)	QP margin (dB)	AVG margin (dB)	Remark
1	0.1660	36.57	18.79	9.65	46.22	28.44	65.16	55.16	-18.94	-26.72	Pass
2	0.1780	36.43	17.95	9.64	46.07	27.59	64.58	54.58	-18.51	-26.99	Pass
3	0.1940	35.56	19.43	9.64	45.20	29.07	63.86	53.86	-18.66	-24.79	Pass
4	0.2260	32.07	17.05	9.64	41.71	26.69	62.60	52.60	-20.89	-25.91	Pass
5	0.6460	32.38	25.49	9.66	42.04	35.15	56.00	46.00	-13.96	-10.85	Pass
6	12.3380	35.92	31.13	9.93	45.85	41.06	60.00	50.00	-14.15	-8.94	Pass

Note: 1. Result (dBuV) = Correction factor (dB) + Reading(dBuV).

2. Correction factor (dB) = Cable loss (dB) + L.I.S.N. factor (dB).

Standard:	FCC Part 15.407	Line:	N
Test item:	Conducted Emission	Power:	AC 120 V/60 Hz
Mode:	Mode 1		
Description:			

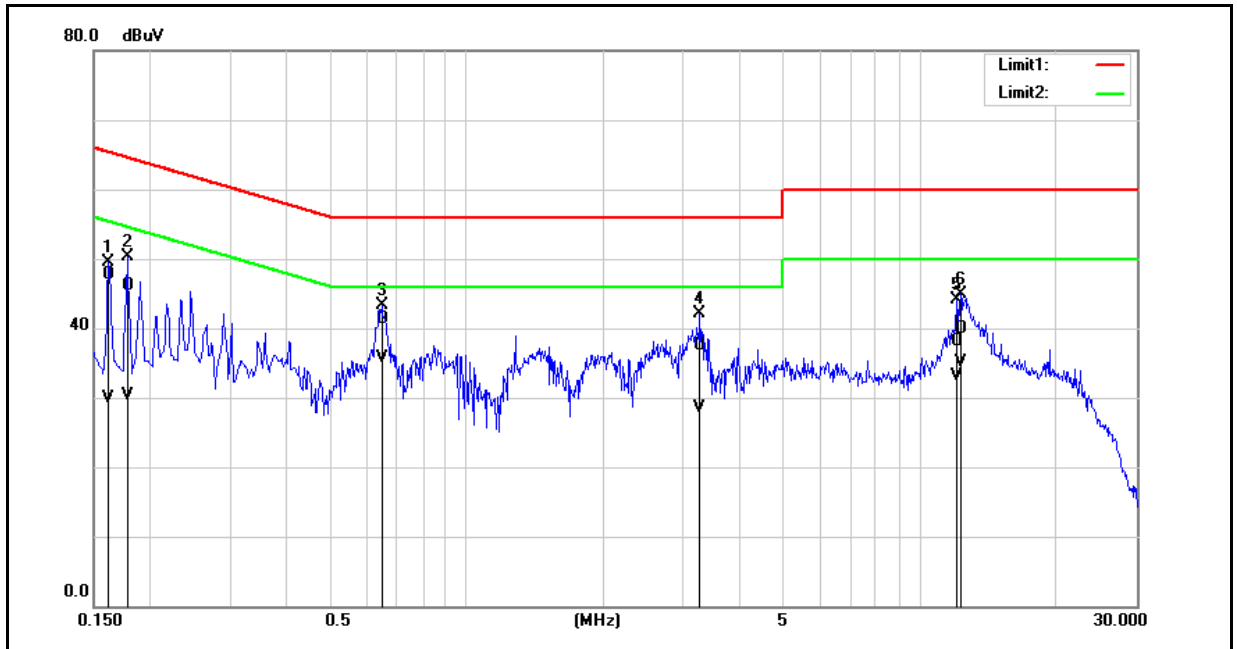

No.	Frequency (MHz)	QP reading (dBuV)	AVG reading (dBuV)	Correction factor (dB)	QP result (dBuV)	AVG result (dBuV)	QP limit (dBuV)	AVG limit (dBuV)	QP margin (dB)	AVG margin (dB)	Remark
1	0.1620	38.09	20.30	9.68	47.77	29.98	65.36	55.36	-17.59	-25.38	Pass
2	0.1780	36.35	20.62	9.67	46.02	30.29	64.58	54.58	-18.56	-24.29	Pass
3	0.6500	31.63	26.05	9.69	41.32	35.74	56.00	46.00	-14.68	-10.26	Pass
4	3.2700	27.77	18.72	9.78	37.55	28.50	56.00	46.00	-18.45	-17.50	Pass
5	12.0580	28.12	23.17	10.02	38.14	33.19	60.00	50.00	-21.86	-16.81	Pass
6	12.2780	29.91	25.02	10.02	39.93	35.04	60.00	50.00	-20.07	-14.96	Pass

Note: 1. Result (dBuV) = Correction factor (dB) + Reading(dBuV).
2. Correction factor (dB) = Cable loss (dB) + L.I.S.N. factor (dB).

Annex B. Radiated Emission Measurement

Below 1 GHz

Standard:	FCC Part 15.407	Test Distance:	3m
Test item:	Radiated Emission		
Frequency:	5745 MHz		
Mode:	Mode 2		
Ant.Polar.:	Horizontal		

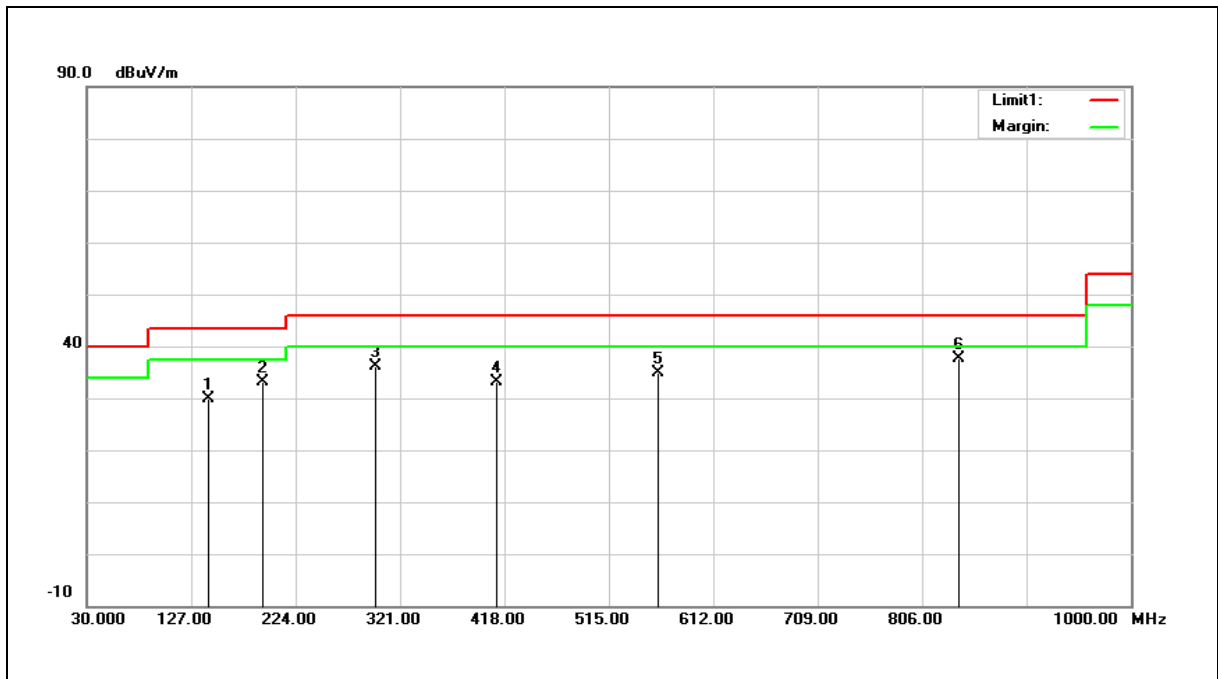

No.	Frequency (MHz)	Reading (dBuV)	Correct Factor (dB/m)	Result (dBuV/m)	Limit (dBuV/m)	Margin (dB)	Remark
1	143.4900	35.85	-6.04	29.81	43.50	-13.69	QP
2	192.9600	40.64	-7.45	33.19	43.50	-10.31	QP
3	297.7200	40.46	-4.26	36.20	46.00	-9.80	QP
4	410.2400	35.02	-1.81	33.21	46.00	-12.79	QP
5	560.5900	33.52	1.35	34.87	46.00	-11.13	QP
6	839.9500	31.09	6.48	37.57	46.00	-8.43	QP

Note:1.Result (dBuV/m) = Correct Factor (dB/m) + Reading(dBuV).

Example: 29.81= -6.04+35.85.

2.Correction factor (dB/m) = Antenna Factor (dB/m) + Cable loss (dB) – Pre-Amplifier gain (dB).

3.When the peak results are less than average limit, so not need to evaluate the average.



Standard:	FCC Part 15.407	Test Distance:	3m
Test item:	Radiated Emission		
Frequency:	5745 MHz		
Mode:	Mode 2		
Ant.Polar.:	Vertical		

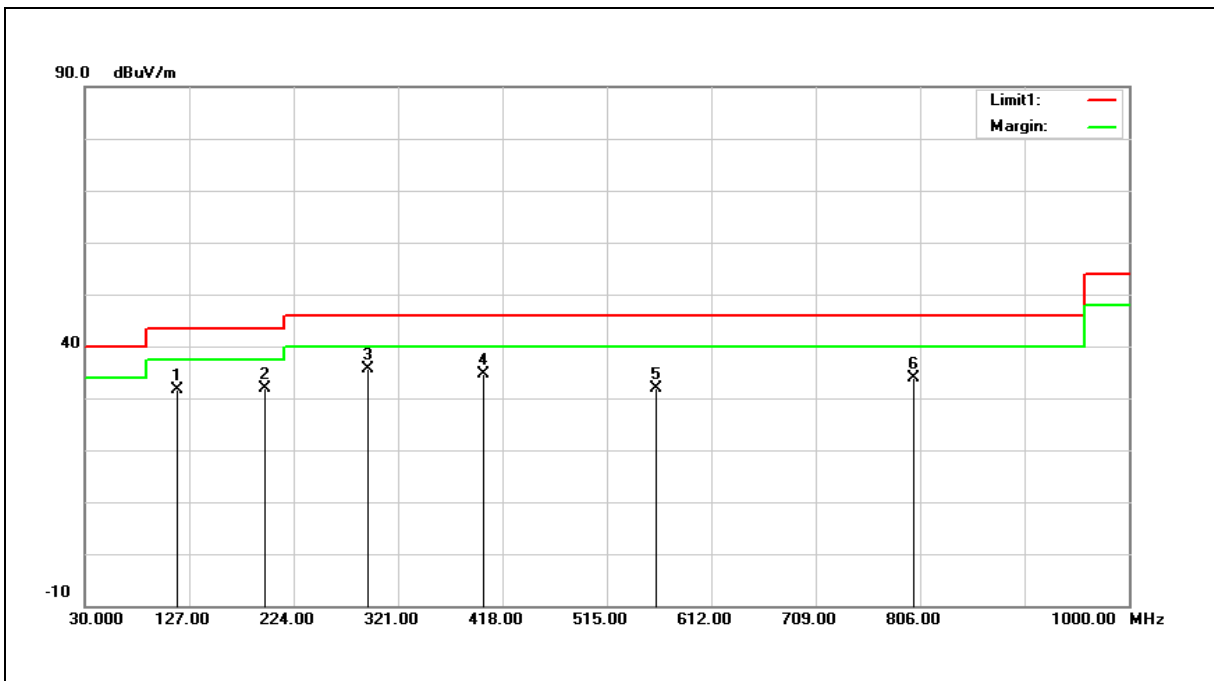

No.	Frequency (MHz)	Reading (dBuV)	Correct Factor (dB/m)	Result (dBuV/m)	Limit (dBuV/m)	Margin (dB)	Remark
1	116.3300	40.42	-8.74	31.68	43.50	-11.82	QP
2	197.8100	39.46	-7.68	31.78	43.50	-11.72	QP
3	292.8700	39.97	-4.37	35.60	46.00	-10.40	QP
4	400.5400	36.81	-2.08	34.73	46.00	-11.27	QP
5	560.5900	30.45	1.35	31.80	46.00	-14.20	QP
6	800.1800	28.09	5.82	33.91	46.00	-12.09	QP

Note:1.Result (dBuV/m) = Correct Factor (dB/m) + Reading(dBuV).

Example: 31.68= -8.74+40.42.

2.Correction factor (dB/m) = Antenna Factor (dB/m) + Cable loss (dB) – Pre-Amplifier gain (dB).

3.When the peak results are less than average limit, so not need to evaluate the average.



Harmonic

Above 1 GHz

Standard:	FCC Part 15.407	Test Distance:	3m
Test item:	Harmonic		
Frequency:	5180MHz		
Mode:	Mode 2		
Ant.Polar.:	Horizontal		

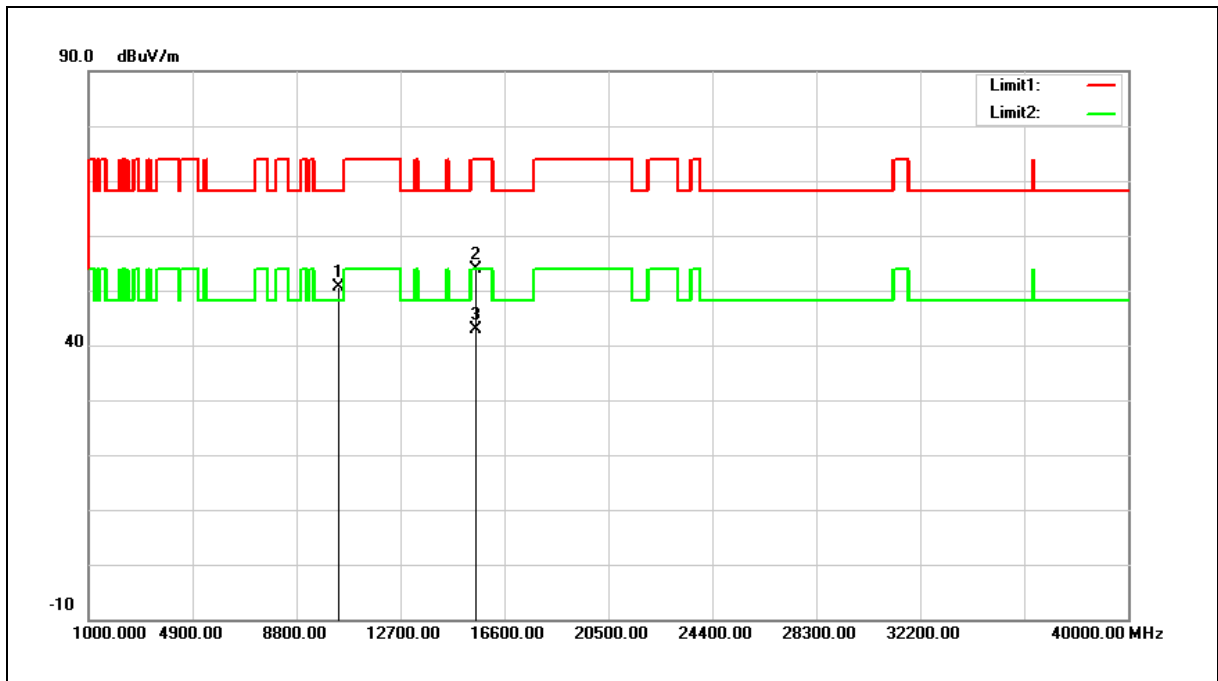

No.	Frequency (MHz)	Reading (dBuV)	Correct Factor (dB/m)	Result (dBuV/m)	Limit (dBuV/m)	Margin (dB)	Remark
1	10360.000	33.25	17.29	50.54	68.20	-17.66	peak
2	15540.000	33.09	20.75	53.84	74.00	-20.16	peak
3	15540.000	22.20	20.75	42.95	54.00	-11.05	AVG

Note:1.Result (dBuV/m) = Correct Factor (dB/m) + Reading(dBuV).

Example: 50.54= 17.29+33.25.

2.Correction factor (dB/m) = Antenna Factor (dB/m) + Cable loss (dB) – Pre-Amplifier gain (dB).

3.When the peak results are less than average limit, so not need to evaluate the average.



Standard:	FCC Part 15.407	Test Distance:	3m
Test item:	Harmonic		
Frequency:	5180MHz		
Mode:	Mode 2		
Ant.Polar.:	Vertical		

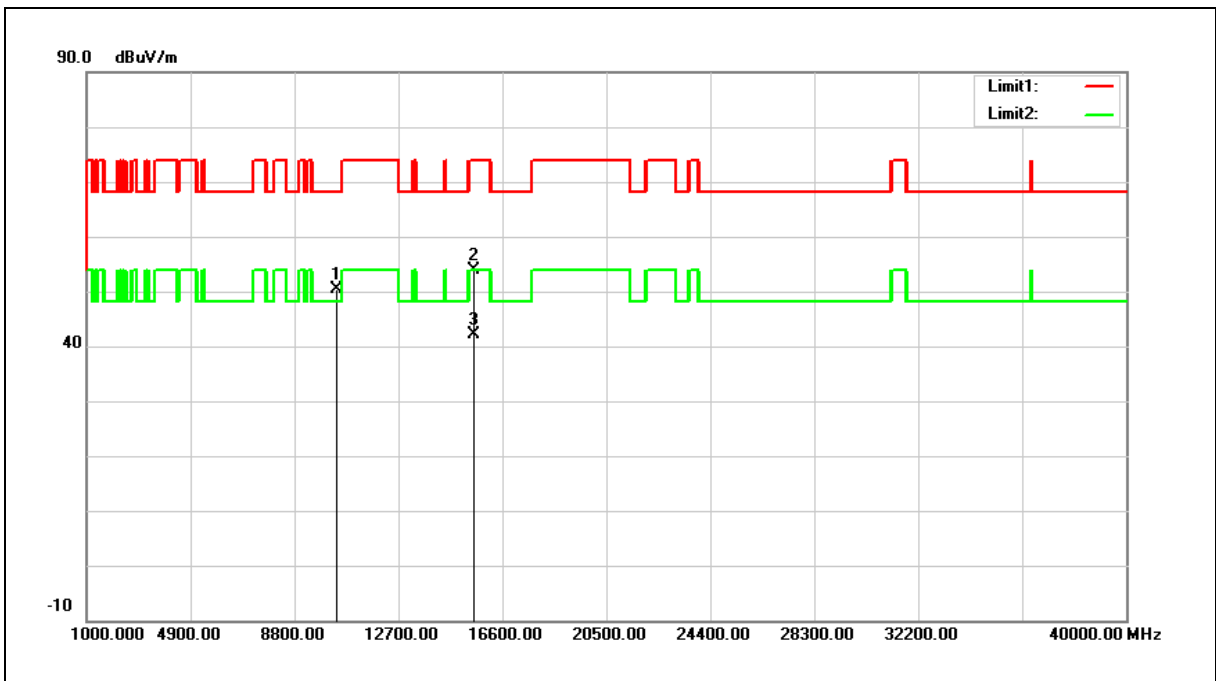

No.	Frequency (MHz)	Reading (dBuV)	Correct Factor (dB/m)	Result (dBuV/m)	Limit (dBuV/m)	Margin (dB)	Remark
1	10360.000	33.07	17.29	50.36	68.20	-17.84	peak
2	15540.000	33.24	20.75	53.99	74.00	-20.01	peak
3	15540.000	21.27	20.75	42.02	54.00	-11.98	AVG

Note:1.Result (dBuV/m) = Correct Factor (dB/m) + Reading(dBuV).

Example: 50.36= 17.29+33.07.

2.Correction factor (dB/m) = Antenna Factor (dB/m) + Cable loss (dB) – Pre-Amplifier gain (dB).

3.When the peak results are less than average limit, so not need to evaluate the average.



Standard:	FCC Part 15.407	Test Distance:	3m
Test item:	Harmonic		
Frequency:	5200MHz		
Mode:	Mode 2		
Ant.Polar.:	Horizontal		

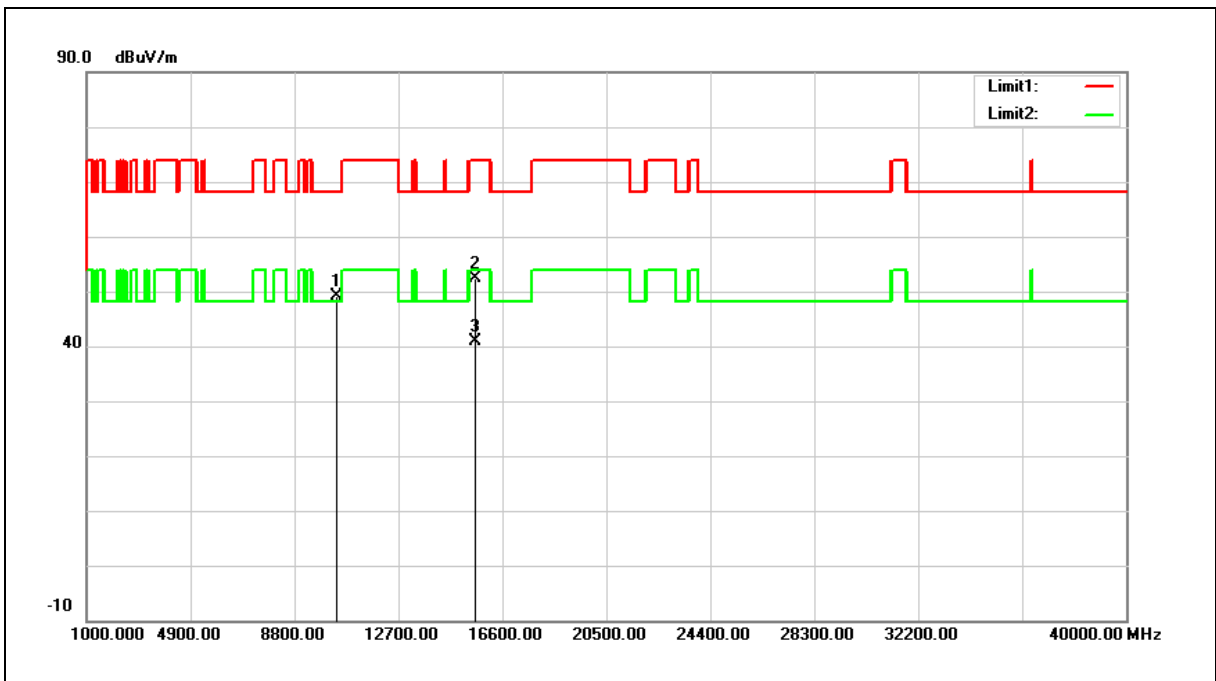

No.	Frequency (MHz)	Reading (dBuV)	Correct Factor (dB/m)	Result (dBuV/m)	Limit (dBuV/m)	Margin (dB)	Remark
1	10400.000	31.77	17.40	49.17	68.20	-19.03	peak
2	15600.000	31.78	20.60	52.38	74.00	-21.62	peak
3	15600.000	20.17	20.60	40.77	54.00	-13.23	AVG

Note:1.Result (dBuV/m) = Correct Factor (dB/m) + Reading(dBuV).

2.Correction factor (dB/m) = Antenna Factor (dB/m) + Cable loss (dB) – Pre-Amplifier gain (dB).

3.When the peak results are less than average limit, so not need to evaluate the average.



Standard:	FCC Part 15.407	Test Distance:	3m
Test item:	Harmonic		
Frequency:	5200MHz		
Mode:	Mode 2		
Ant.Polar.:	Vertical		

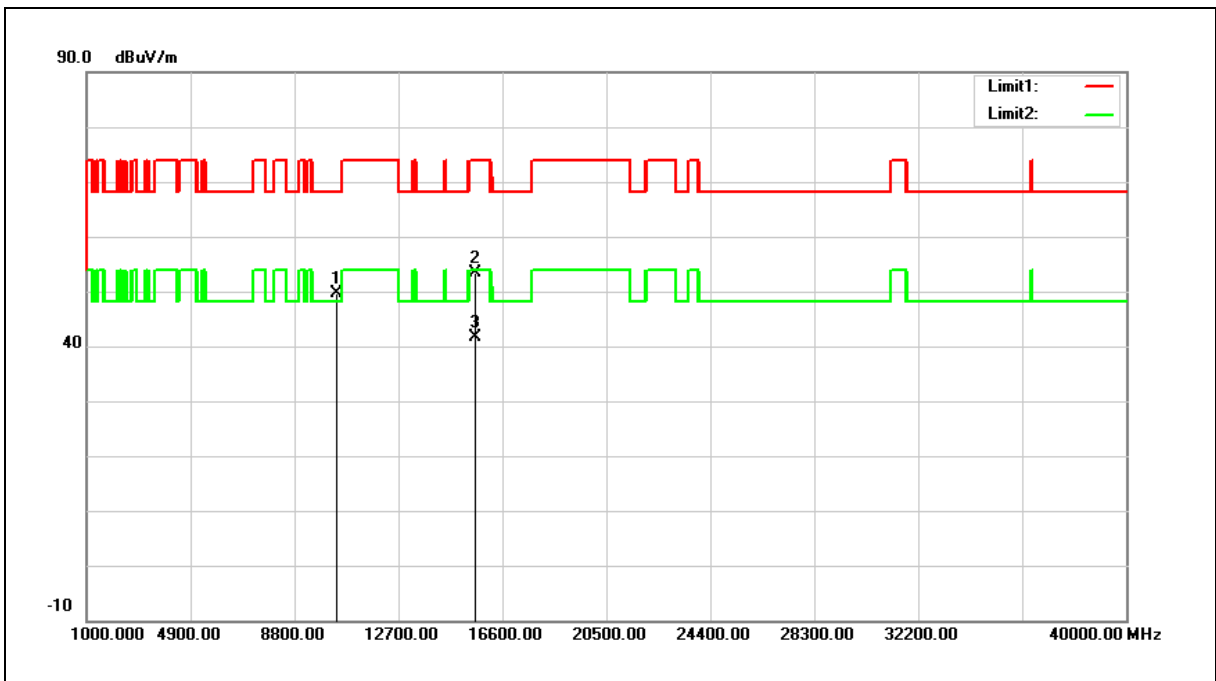

No.	Frequency (MHz)	Reading (dBuV)	Correct Factor (dB/m)	Result (dBuV/m)	Limit (dBuV/m)	Margin (dB)	Remark
1	10400.000	32.17	17.40	49.57	68.20	-18.63	peak
2	15600.000	32.69	20.60	53.29	74.00	-20.71	peak
3	15600.000	20.91	20.60	41.51	54.00	-12.49	AVG

Note:1.Result (dBuV/m) = Correct Factor (dB/m) + Reading(dBuV).

2.Correction factor (dB/m) = Antenna Factor (dB/m) + Cable loss (dB) – Pre-Amplifier gain (dB).

3.When the peak results are less than average limit, so not need to evaluate the average.



Standard:	FCC Part 15.407	Test Distance:	3m
Test item:	Harmonic		
Frequency:	5240MHz		
Mode:	Mode 2		
Ant.Polar.:	Horizontal		

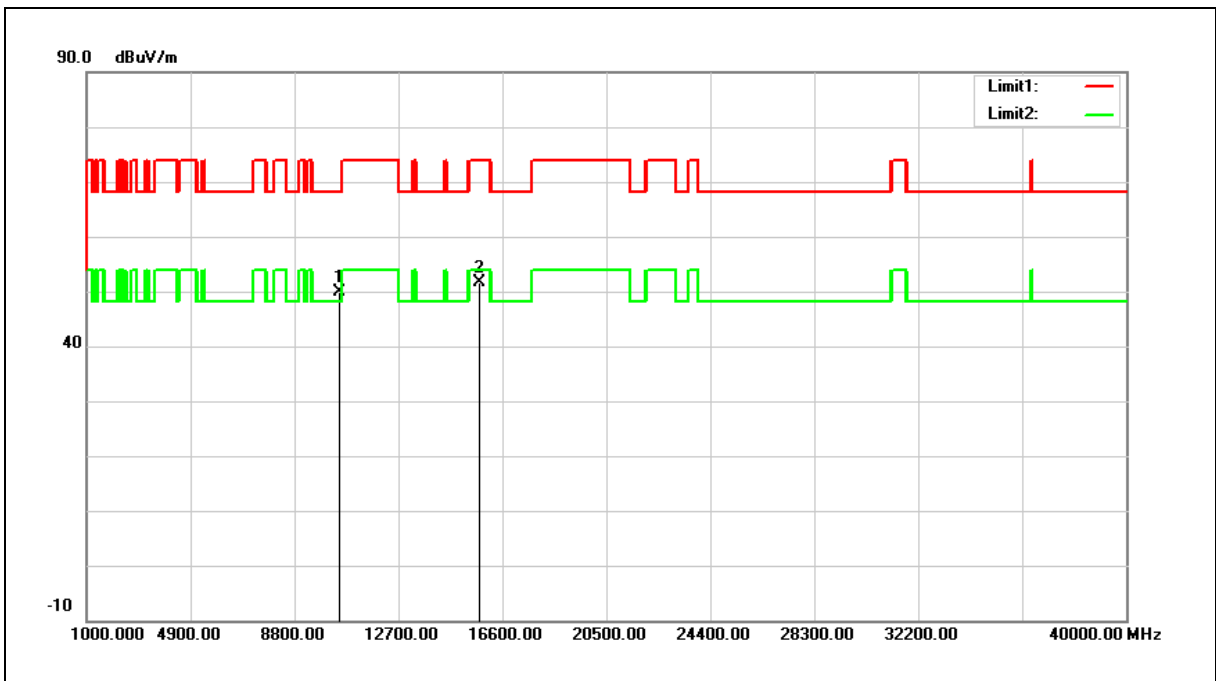

No.	Frequency (MHz)	Reading (dBuV)	Correct Factor (dB/m)	Result (dBuV/m)	Limit (dBuV/m)	Margin (dB)	Remark
1	10480.000	32.21	17.64	49.85	68.20	-18.35	peak
2	15720.000	31.41	20.30	51.71	74.00	-22.29	peak

Note:1.Result (dBuV/m) = Correct Factor (dB/m) + Reading(dBuV).

2.Correction factor (dB/m) = Antenna Factor (dB/m) + Cable loss (dB) – Pre-Amplifier gain (dB).

3.When the peak results are less than average limit, so not need to evaluate the average.



Standard:	FCC Part 15.407	Test Distance:	3m
Test item:	Harmonic		
Frequency:	5240MHz		
Mode:	Mode 2		
Ant.Polar.:	Vertical		

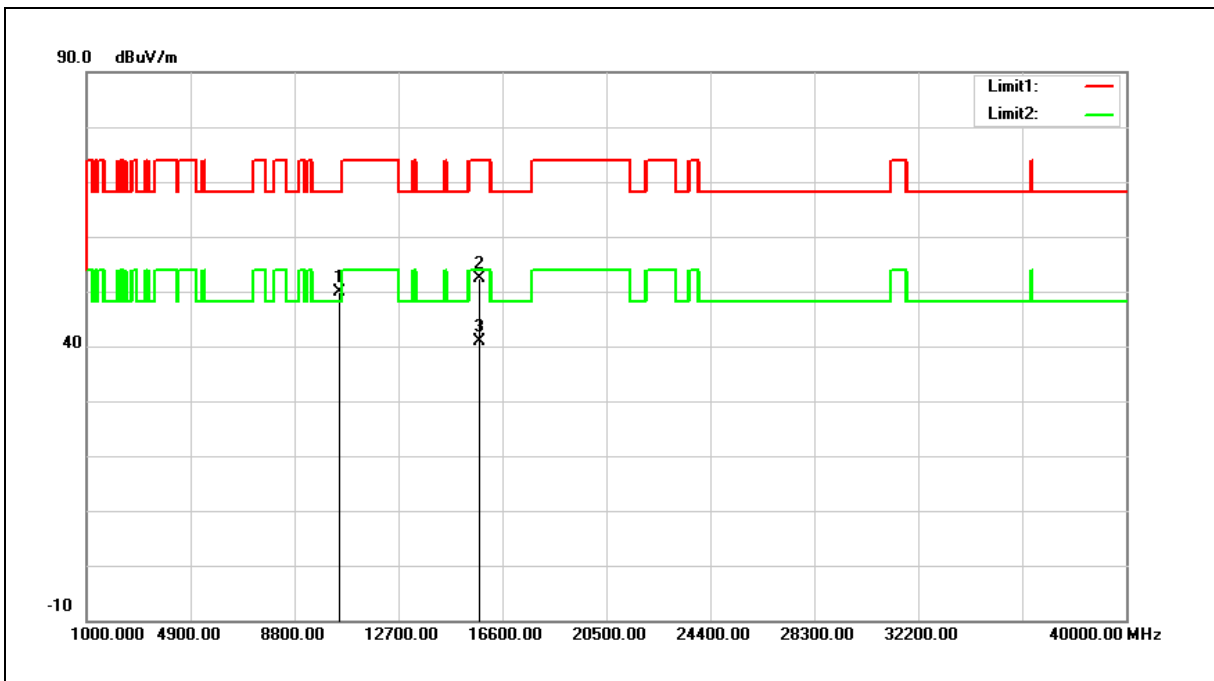

No.	Frequency (MHz)	Reading (dBuV)	Correct Factor (dB/m)	Result (dBuV/m)	Limit (dBuV/m)	Margin (dB)	Remark
1	10480.000	32.21	17.64	49.85	68.20	-18.35	peak
2	15720.000	31.96	20.30	52.26	74.00	-21.74	peak
3	15720.000	20.52	20.30	40.82	54.00	-13.18	AVG

Note:1.Result (dBuV/m) = Correct Factor (dB/m) + Reading(dBuV).

2.Correction factor (dB/m) = Antenna Factor (dB/m) + Cable loss (dB) – Pre-Amplifier gain (dB).

3.When the peak results are less than average limit, so not need to evaluate the average.



Standard:	FCC Part 15.407	Test Distance:	3m
Test item:	Harmonic		
Frequency:	5745MHz		
Mode:	Mode 2		
Ant.Polar.:	Horizontal		

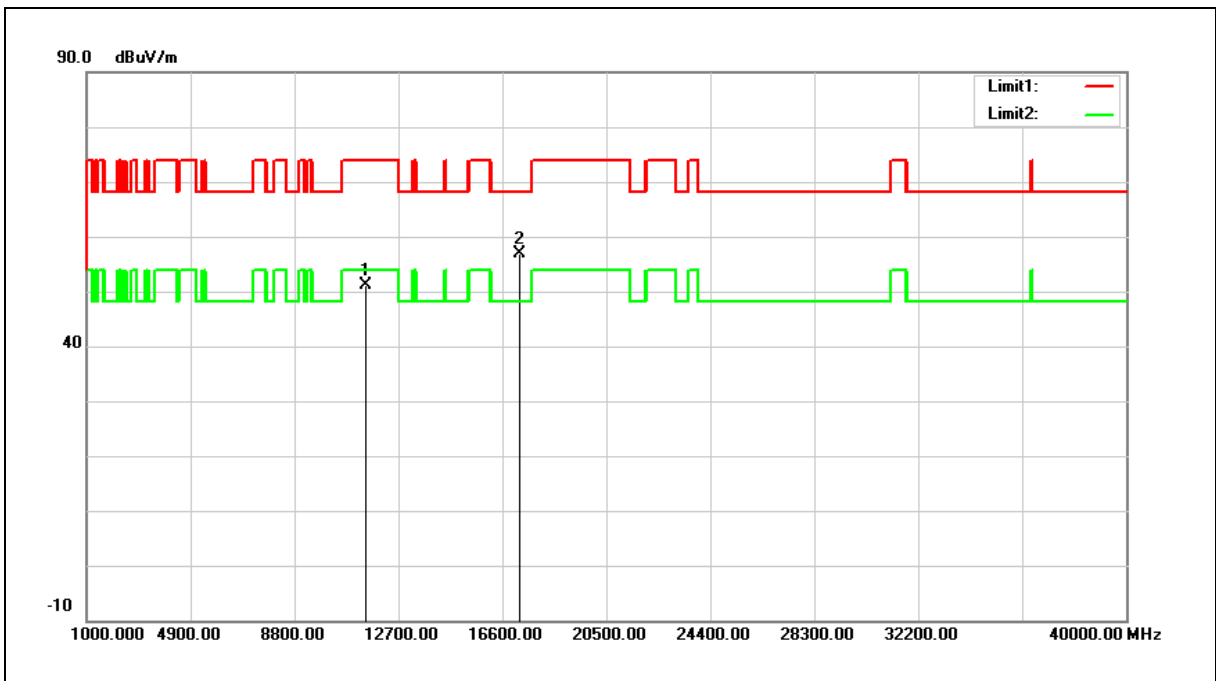

No.	Frequency (MHz)	Reading (dBuV)	Correct Factor (dB/m)	Result (dBuV/m)	Limit (dBuV/m)	Margin (dB)	Remark
1	11490.000	31.80	19.45	51.25	74.00	-22.75	peak
2	17235.000	31.99	25.01	57.00	68.20	-11.20	peak

Note:1.Result (dBuV/m) = Correct Factor (dB/m) + Reading(dBuV).

2.Correction factor (dB/m) = Antenna Factor (dB/m) + Cable loss (dB) – Pre-Amplifier gain (dB).

3.When the peak results are less than average limit, so not need to evaluate the average.



Standard:	FCC Part 15.407	Test Distance:	3m
Test item:	Harmonic		
Frequency:	5745MHz		
Mode:	Mode 2		
Ant.Polar.:	Vertical		

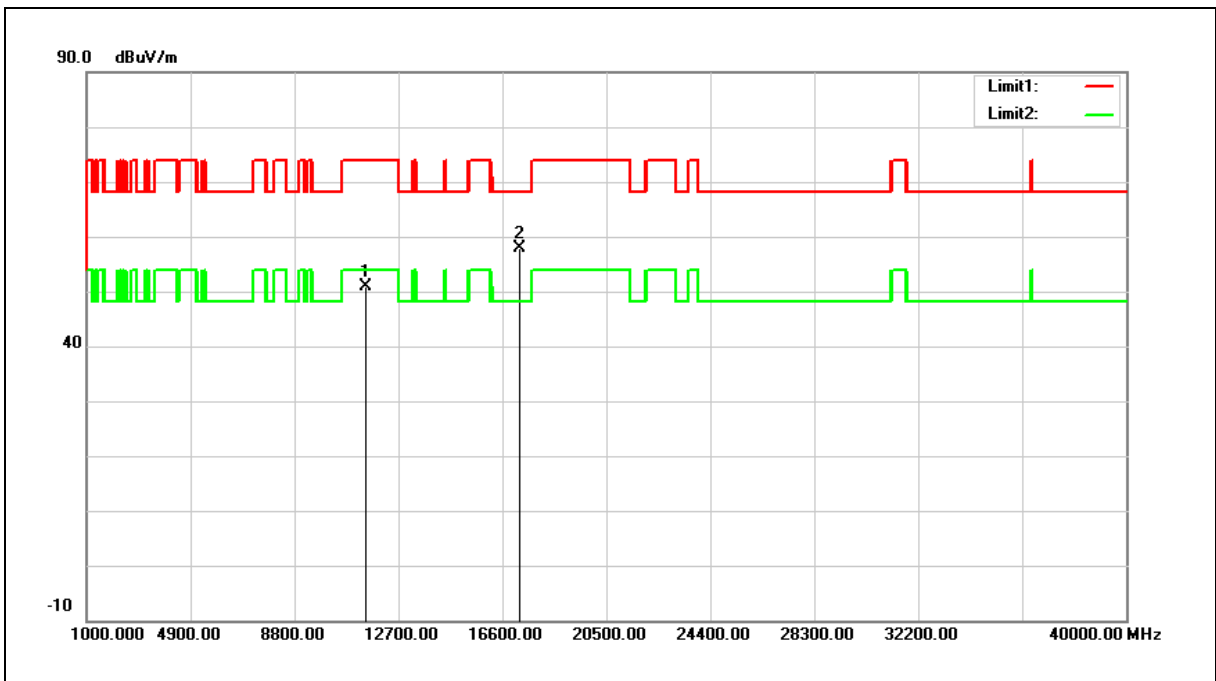

No.	Frequency (MHz)	Reading (dBuV)	Correct Factor (dB/m)	Result (dBuV/m)	Limit (dBuV/m)	Margin (dB)	Remark
1	11490.000	31.42	19.45	50.87	74.00	-23.13	peak
2	17235.000	32.85	25.01	57.86	68.20	-10.34	peak

Note:1.Result (dBuV/m) = Correct Factor (dB/m) + Reading(dBuV).

2.Correction factor (dB/m) = Antenna Factor (dB/m) + Cable loss (dB) – Pre-Amplifier gain (dB).

3.When the peak results are less than average limit, so not need to evaluate the average.



Standard:	FCC Part 15.407	Test Distance:	3m
Test item:	Harmonic		
Frequency:	5785MHz		
Mode:	Mode 2		
Ant.Polar.:	Horizontal		

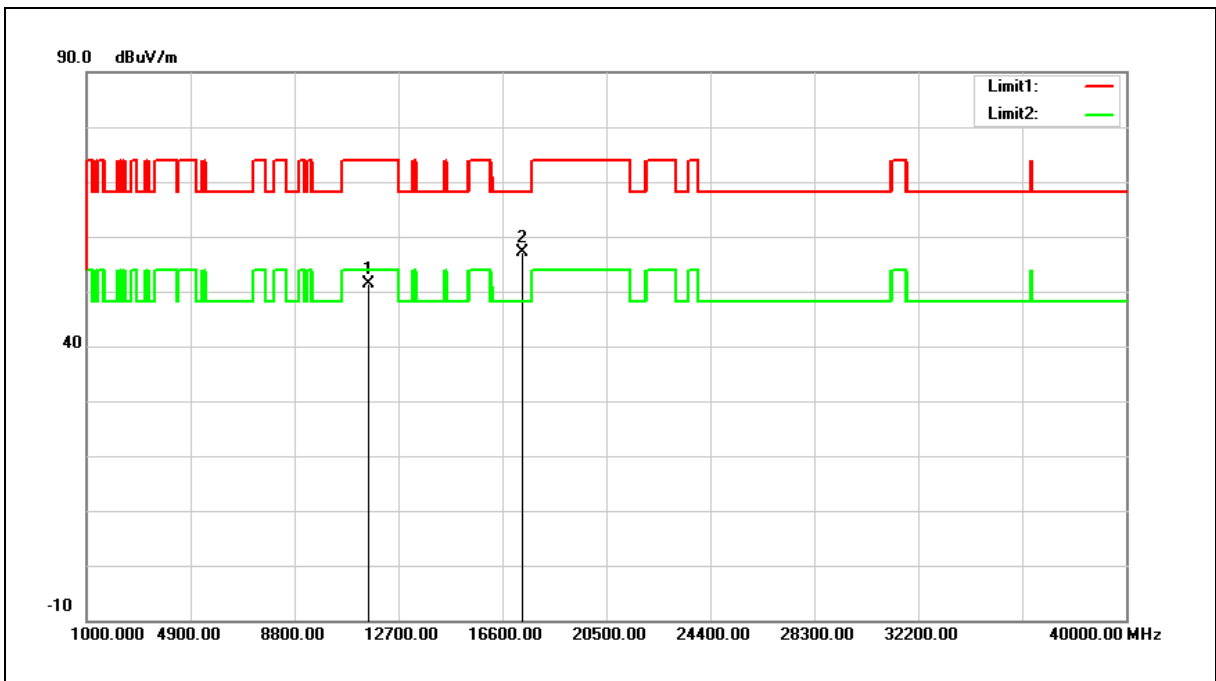

No.	Frequency (MHz)	Reading (dBuV)	Correct Factor (dB/m)	Result (dBuV/m)	Limit (dBuV/m)	Margin (dB)	Remark
1	11570.000	32.03	19.39	51.42	74.00	-22.58	peak
2	17355.000	31.67	25.34	57.01	68.20	-11.19	peak

Note:1.Result (dBuV/m) = Correct Factor (dB/m) + Reading(dBuV).

2.Correction factor (dB/m) = Antenna Factor (dB/m) + Cable loss (dB) – Pre-Amplifier gain (dB).

3.When the peak results are less than average limit, so not need to evaluate the average.



Standard:	FCC Part 15.407	Test Distance:	3m
Test item:	Harmonic		
Frequency:	5785MHz		
Mode:	Mode 2		
Ant.Polar.:	Vertical		

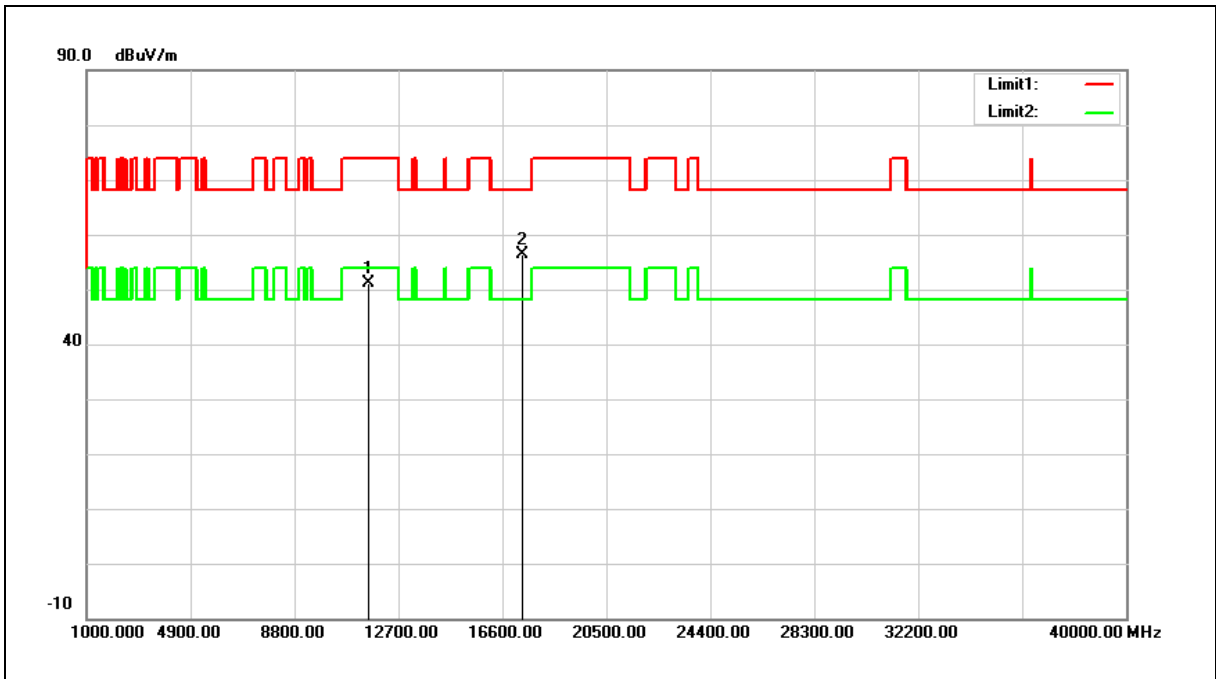

No.	Frequency (MHz)	Reading (dBuV)	Correct Factor (dB/m)	Result (dBuV/m)	Limit (dBuV/m)	Margin (dB)	Remark
1	11570.000	31.78	19.39	51.17	74.00	-22.83	peak
2	17355.000	30.99	25.34	56.33	68.20	-11.87	peak

Note:1.Result (dBuV/m) = Correct Factor (dB/m) + Reading(dBuV).

2.Correction factor (dB/m) = Antenna Factor (dB/m) + Cable loss (dB) – Pre-Amplifier gain (dB).

3.When the peak results are less than average limit, so not need to evaluate the average.



Standard:	FCC Part 15.407	Test Distance:	3m
Test item:	Harmonic		
Frequency:	5825MHz		
Mode:	Mode 2		
Ant.Polar.:	Horizontal		

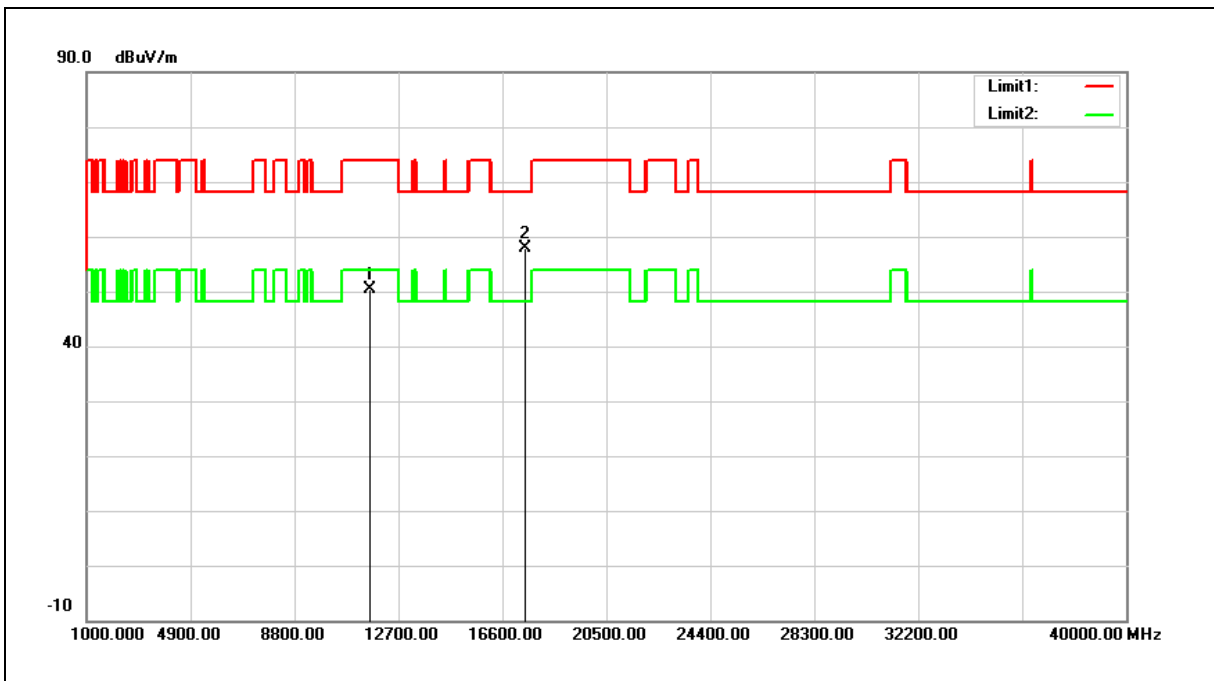

No.	Frequency (MHz)	Reading (dBuV)	Correct Factor (dB/m)	Result (dBuV/m)	Limit (dBuV/m)	Margin (dB)	Remark
1	11650.000	31.18	19.32	50.50	74.00	-23.50	peak
2	17475.000	32.18	25.65	57.83	68.20	-10.37	peak

Note:1.Result (dBuV/m) = Correct Factor (dB/m) + Reading(dBuV).

2.Correction factor (dB/m) = Antenna Factor (dB/m) + Cable loss (dB) – Pre-Amplifier gain (dB).

3.When the peak results are less than average limit, so not need to evaluate the average.



Standard:	FCC Part 15.407	Test Distance:	3m
Test item:	Harmonic		
Frequency:	5825MHz		
Mode:	Mode 2		
Ant.Polar.:	Vertical		

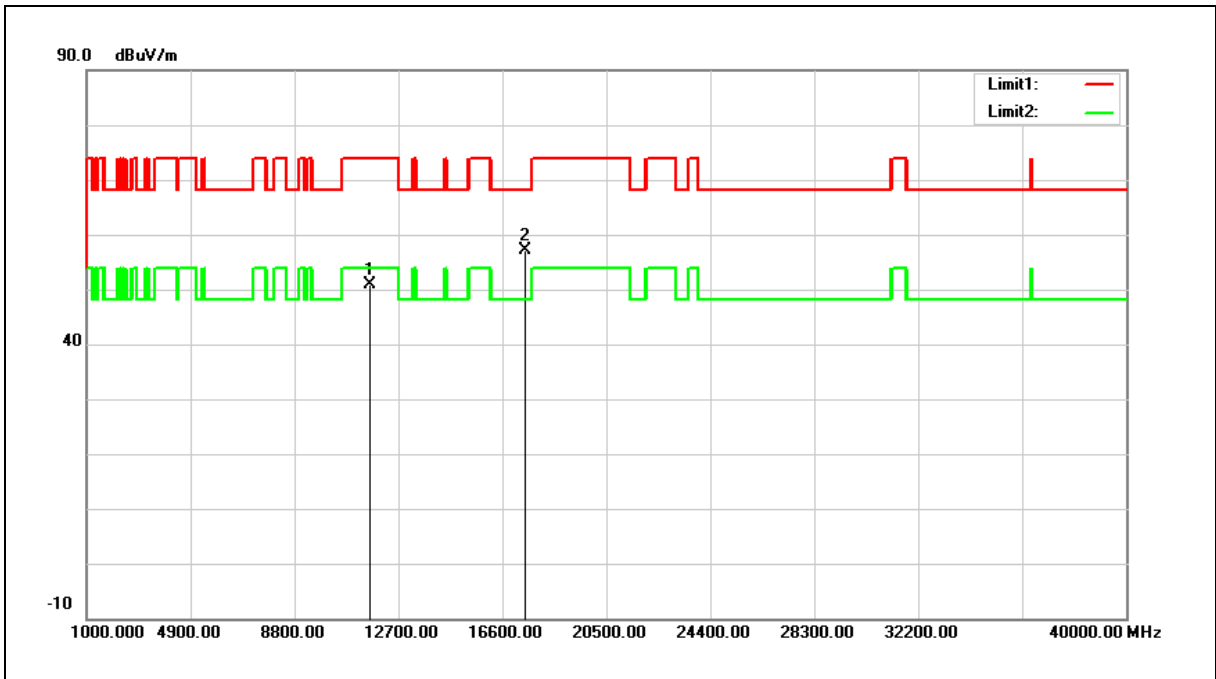

No.	Frequency (MHz)	Reading (dBuV)	Correct Factor (dB/m)	Result (dBuV/m)	Limit (dBuV/m)	Margin (dB)	Remark
1	11650.000	31.53	19.32	50.85	74.00	-23.15	peak
2	17475.000	31.46	25.65	57.11	68.20	-11.09	peak

- Note:1.Result (dBuV/m) = Correct Factor (dB/m) + Reading(dBuV).
 2.Correction factor (dB/m) = Antenna Factor (dB/m) + Cable loss (dB) – Pre-Amplifier gain (dB).
 3.When the peak results are less than average limit, so not need to evaluate the average.



Standard:	FCC Part 15.407	Test Distance:	3m
Test item:	Harmonic		
Frequency:	5180MHz		
Mode:	Mode 3		
Ant.Polar.:	Horizontal		

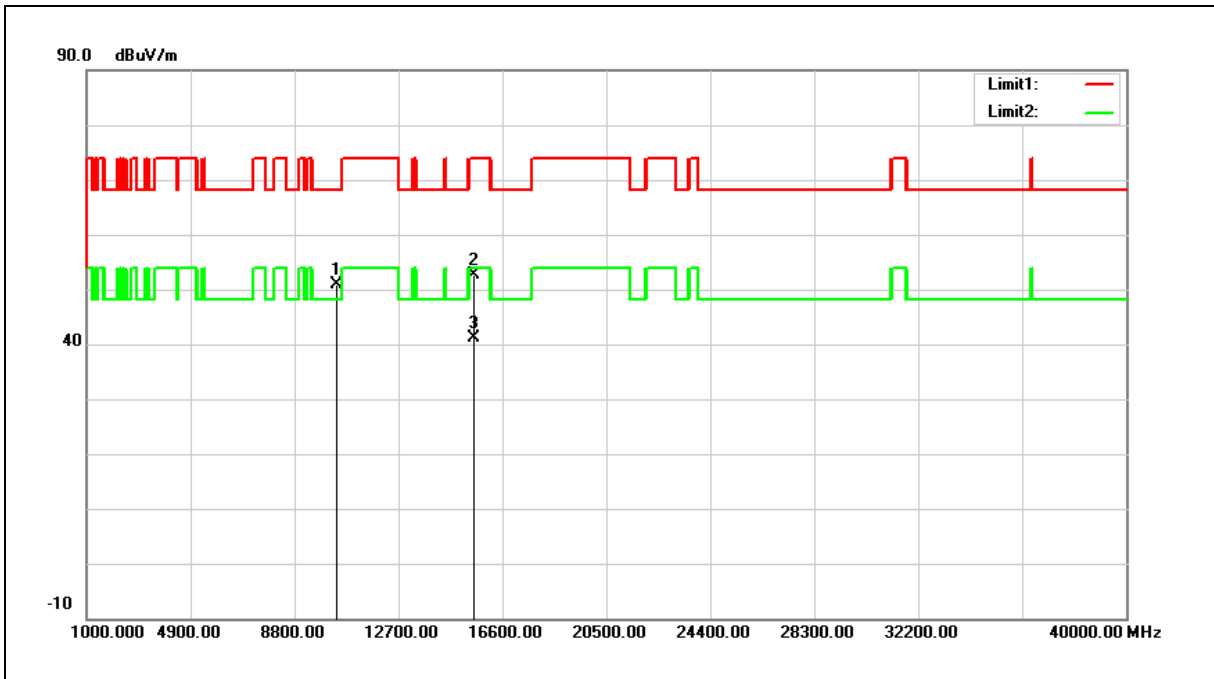

No.	Frequency (MHz)	Reading (dBuV)	Correct Factor (dB/m)	Result (dBuV/m)	Limit (dBuV/m)	Margin (dB)	Remark
1	10360.000	33.56	17.29	50.85	68.20	-17.35	peak
2	15540.000	31.90	20.75	52.65	74.00	-21.35	peak
3	15540.000	20.44	20.75	41.19	54.00	-12.81	AVG

Note:1.Result (dBuV/m) = Correct Factor (dB/m) + Reading(dBuV).

2.Correction factor (dB/m) = Antenna Factor (dB/m) + Cable loss (dB) – Pre-Amplifier gain (dB).

3.When the peak results are less than average limit, so not need to evaluate the average.



Standard:	FCC Part 15.407	Test Distance:	3m
Test item:	Harmonic		
Frequency:	5180MHz		
Mode:	Mode 3		
Ant.Polar.:	Vertical		

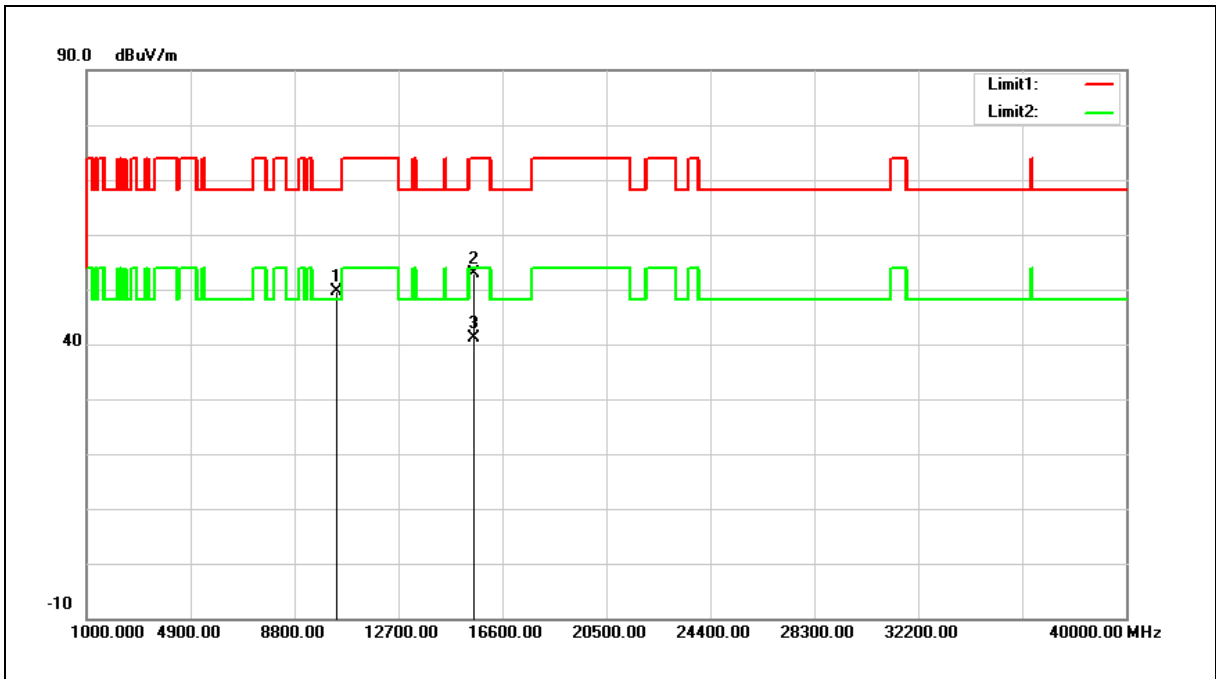

No.	Frequency (MHz)	Reading (dBuV)	Correct Factor (dB/m)	Result (dBuV/m)	Limit (dBuV/m)	Margin (dB)	Remark
1	10360.000	32.23	17.29	49.52	68.20	-18.68	peak
2	15540.000	32.16	20.75	52.91	74.00	-21.09	peak
3	15540.000	20.40	20.75	41.15	54.00	-12.85	AVG

Note:1.Result (dBuV/m) = Correct Factor (dB/m) + Reading(dBuV).

2.Correction factor (dB/m) = Antenna Factor (dB/m) + Cable loss (dB) – Pre-Amplifier gain (dB).

3.When the peak results are less than average limit, so not need to evaluate the average.



Standard:	FCC Part 15.407	Test Distance:	3m
Test item:	Harmonic		
Frequency:	5200MHz		
Mode:	Mode 3		
Ant.Polar.:	Horizontal		

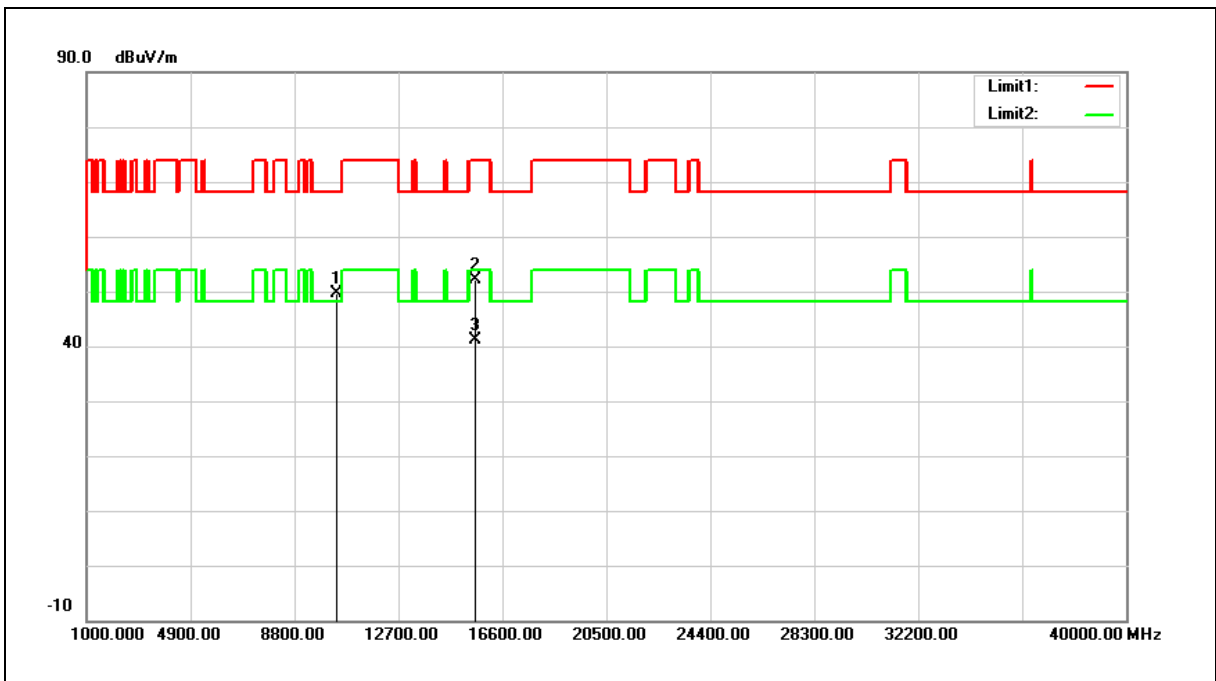

No.	Frequency (MHz)	Reading (dBuV)	Correct Factor (dB/m)	Result (dBuV/m)	Limit (dBuV/m)	Margin (dB)	Remark
1	10400.000	32.22	17.40	49.62	68.20	-18.58	peak
2	15600.000	31.63	20.60	52.23	74.00	-21.77	peak
3	15600.000	20.59	20.60	41.19	54.00	-12.81	AVG

Note:1.Result (dBuV/m) = Correct Factor (dB/m) + Reading(dBuV).

2.Correction factor (dB/m) = Antenna Factor (dB/m) + Cable loss (dB) – Pre-Amplifier gain (dB).

3.When the peak results are less than average limit, so not need to evaluate the average.



Standard:	FCC Part 15.407	Test Distance:	3m
Test item:	Harmonic		
Frequency:	5200MHz		
Mode:	Mode 3		
Ant.Polar.:	Vertical		

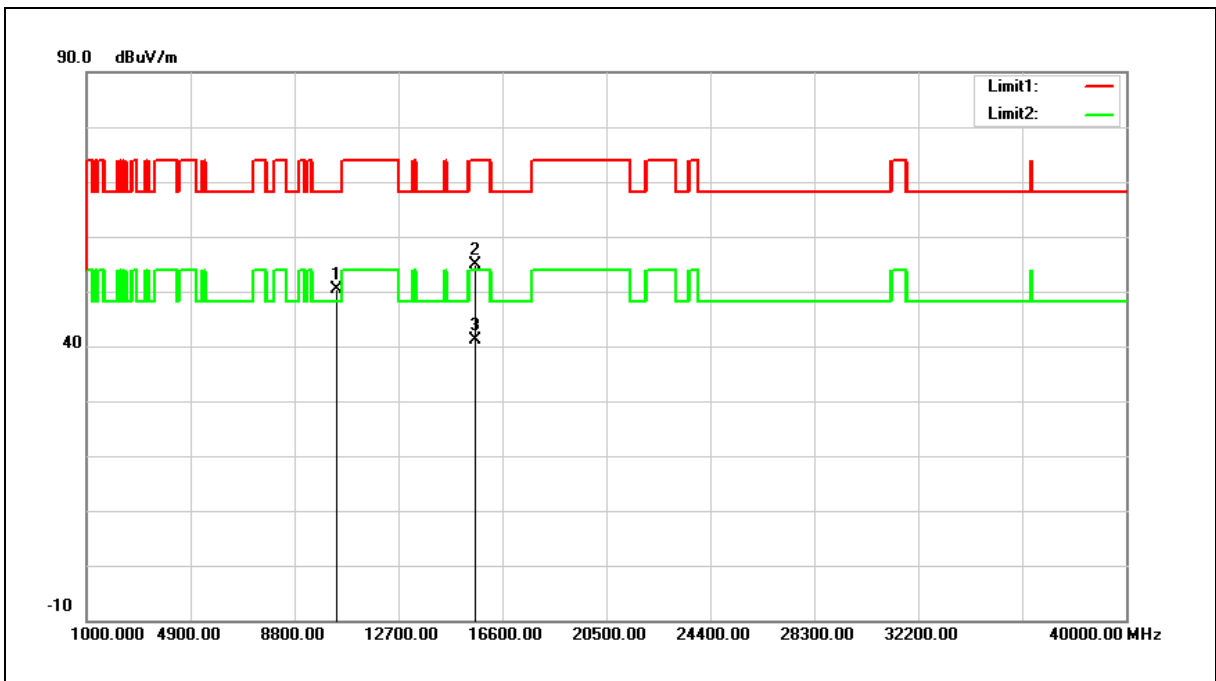

No.	Frequency (MHz)	Reading (dBuV)	Correct Factor (dB/m)	Result (dBuV/m)	Limit (dBuV/m)	Margin (dB)	Remark
1	10400.000	32.87	17.40	50.27	68.20	-17.93	peak
2	15600.000	34.31	20.60	54.91	74.00	-19.09	peak
3	15600.000	20.57	20.60	41.17	54.00	-12.83	AVG

Note:1.Result (dBuV/m) = Correct Factor (dB/m) + Reading(dBuV).

2.Correction factor (dB/m) = Antenna Factor (dB/m) + Cable loss (dB) – Pre-Amplifier gain (dB).

3.When the peak results are less than average limit, so not need to evaluate the average.



Standard:	FCC Part 15.407	Test Distance:	3m
Test item:	Harmonic		
Frequency:	5240MHz		
Mode:	Mode 3		
Ant.Polar.:	Horizontal		

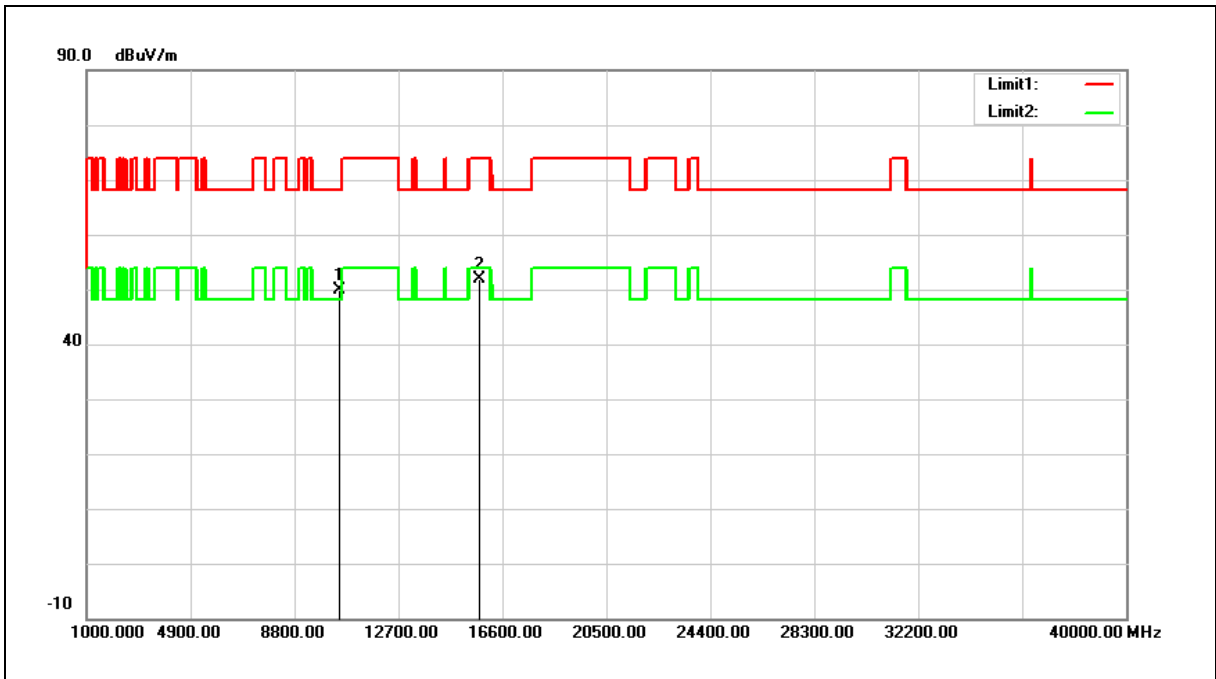

No.	Frequency (MHz)	Reading (dBuV)	Correct Factor (dB/m)	Result (dBuV/m)	Limit (dBuV/m)	Margin (dB)	Remark
1	10480.000	32.30	17.64	49.94	68.20	-18.26	peak
2	15720.000	31.48	20.30	51.78	74.00	-22.22	peak

Note:1.Result (dBuV/m) = Correct Factor (dB/m) + Reading(dBuV).

2.Correction factor (dB/m) = Antenna Factor (dB/m) + Cable loss (dB) – Pre-Amplifier gain (dB).

3.When the peak results are less than average limit, so not need to evaluate the average.



Standard:	FCC Part 15.407	Test Distance:	3m
Test item:	Harmonic		
Frequency:	5240MHz		
Mode:	Mode 3		
Ant.Polar.:	Vertical		

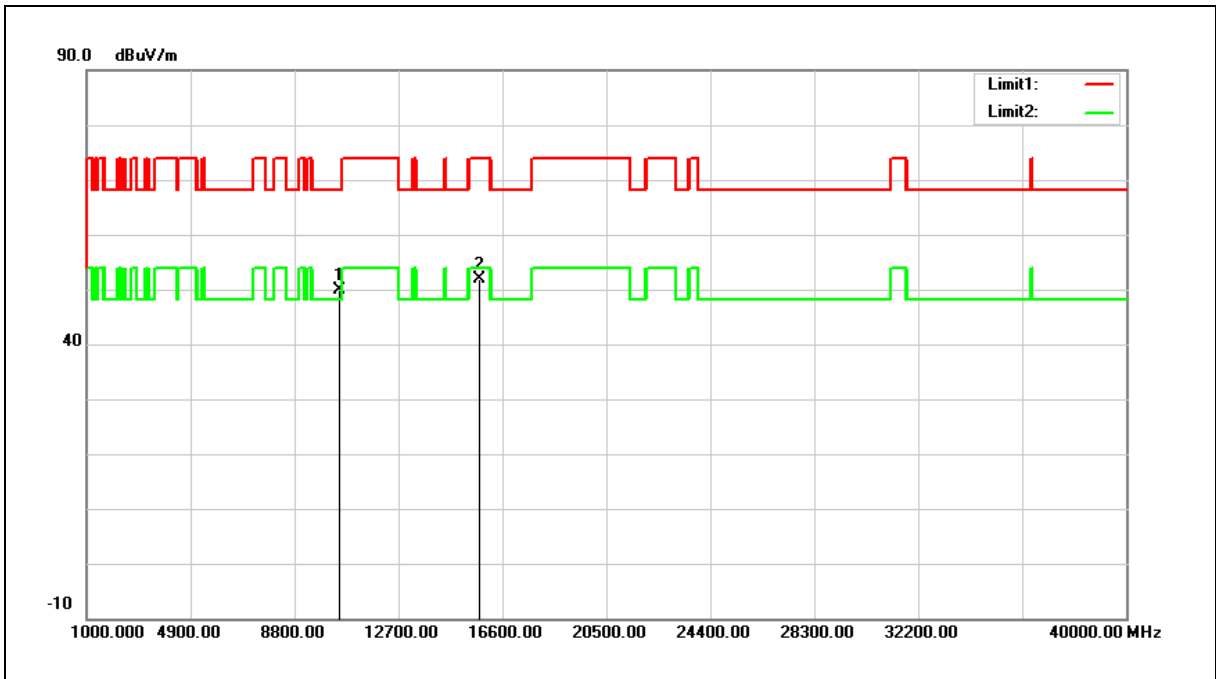

No.	Frequency (MHz)	Reading (dBuV)	Correct Factor (dB/m)	Result (dBuV/m)	Limit (dBuV/m)	Margin (dB)	Remark
1	10480.000	32.18	17.64	49.82	68.20	-18.38	peak
2	15720.000	31.67	20.30	51.97	74.00	-22.03	peak

Note:1.Result (dBuV/m) = Correct Factor (dB/m) + Reading(dBuV).

2.Correction factor (dB/m) = Antenna Factor (dB/m) + Cable loss (dB) – Pre-Amplifier gain (dB).

3.When the peak results are less than average limit, so not need to evaluate the average.



Standard:	FCC Part 15.407	Test Distance:	3m
Test item:	Harmonic		
Frequency:	5745MHz		
Mode:	Mode 3		
Ant.Polar.:	Horizontal		

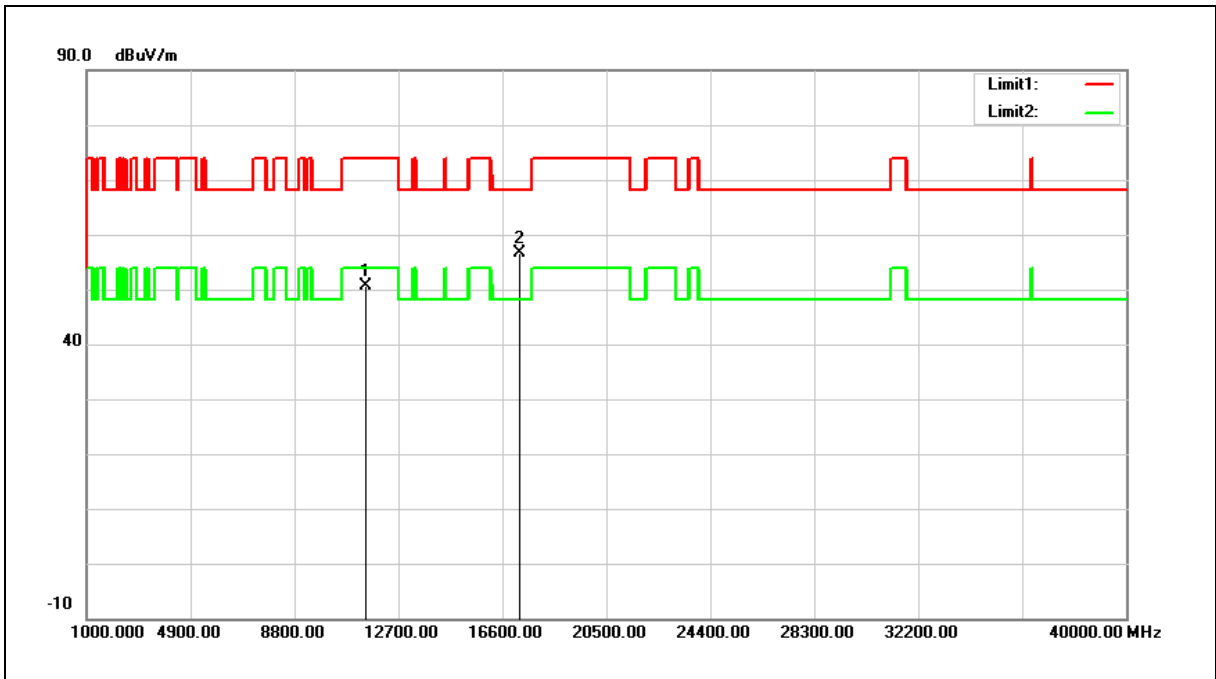

No.	Frequency (MHz)	Reading (dBuV)	Correct Factor (dB/m)	Result (dBuV/m)	Limit (dBuV/m)	Margin (dB)	Remark
1	11490.000	31.29	19.45	50.74	74.00	-23.26	peak
2	17235.000	31.53	25.01	56.54	68.20	-11.66	peak

Note:1.Result (dBuV/m) = Correct Factor (dB/m) + Reading(dBuV).

2.Correction factor (dB/m) = Antenna Factor (dB/m) + Cable loss (dB) – Pre-Amplifier gain (dB).

3.When the peak results are less than average limit, so not need to evaluate the average.



Standard:	FCC Part 15.407	Test Distance:	3m
Test item:	Harmonic		
Frequency:	5745MHz		
Mode:	Mode 3		
Ant.Polar.:	Vertical		

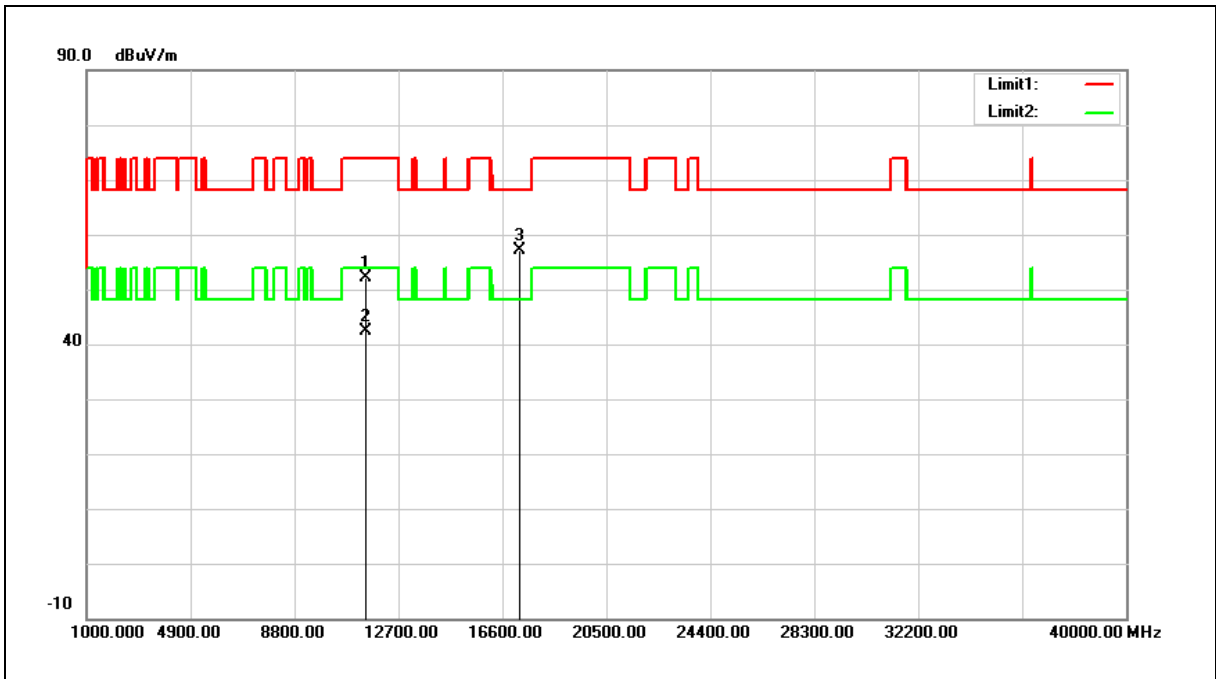

No.	Frequency (MHz)	Reading (dBuV)	Correct Factor (dB/m)	Result (dBuV/m)	Limit (dBuV/m)	Margin (dB)	Remark
1	11490.000	32.65	19.45	52.10	74.00	-21.90	peak
2	11490.000	22.85	19.45	42.30	54.00	-11.70	AVG
3	17235.000	32.02	25.01	57.03	68.20	-11.17	peak

Note:1.Result (dBuV/m) = Correct Factor (dB/m) + Reading(dBuV).

2.Correction factor (dB/m) = Antenna Factor (dB/m) + Cable loss (dB) – Pre-Amplifier gain (dB).

3.When the peak results are less than average limit, so not need to evaluate the average.



Standard:	FCC Part 15.407	Test Distance:	3m
Test item:	Harmonic		
Frequency:	5785MHz		
Mode:	Mode 3		
Ant.Polar.:	Horizontal		

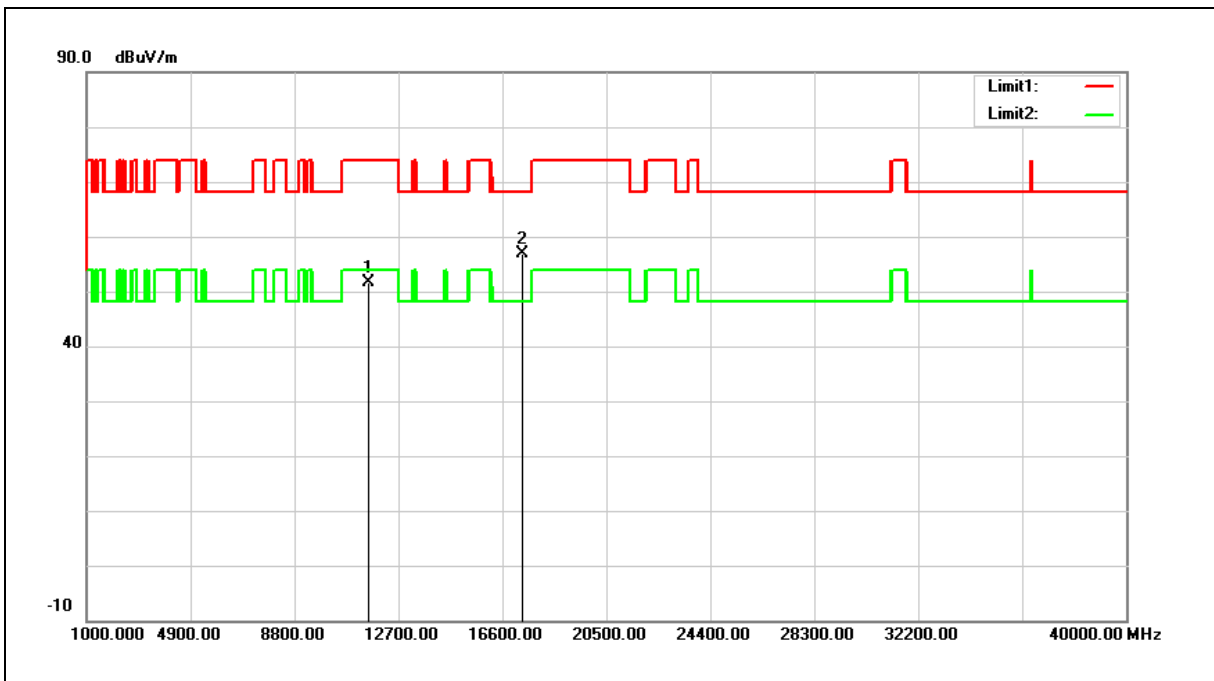

No.	Frequency (MHz)	Reading (dBuV)	Correct Factor (dB/m)	Result (dBuV/m)	Limit (dBuV/m)	Margin (dB)	Remark
1	11570.000	32.16	19.39	51.55	74.00	-22.45	peak
2	17355.000	31.54	25.34	56.88	68.20	-11.32	peak

Note:1.Result (dBuV/m) = Correct Factor (dB/m) + Reading(dBuV).

2.Correction factor (dB/m) = Antenna Factor (dB/m) + Cable loss (dB) – Pre-Amplifier gain (dB).

3.When the peak results are less than average limit, so not need to evaluate the average.



Standard:	FCC Part 15.407	Test Distance:	3m
Test item:	Harmonic		
Frequency:	5785MHz		
Mode:	Mode 3		
Ant.Polar.:	Vertical		

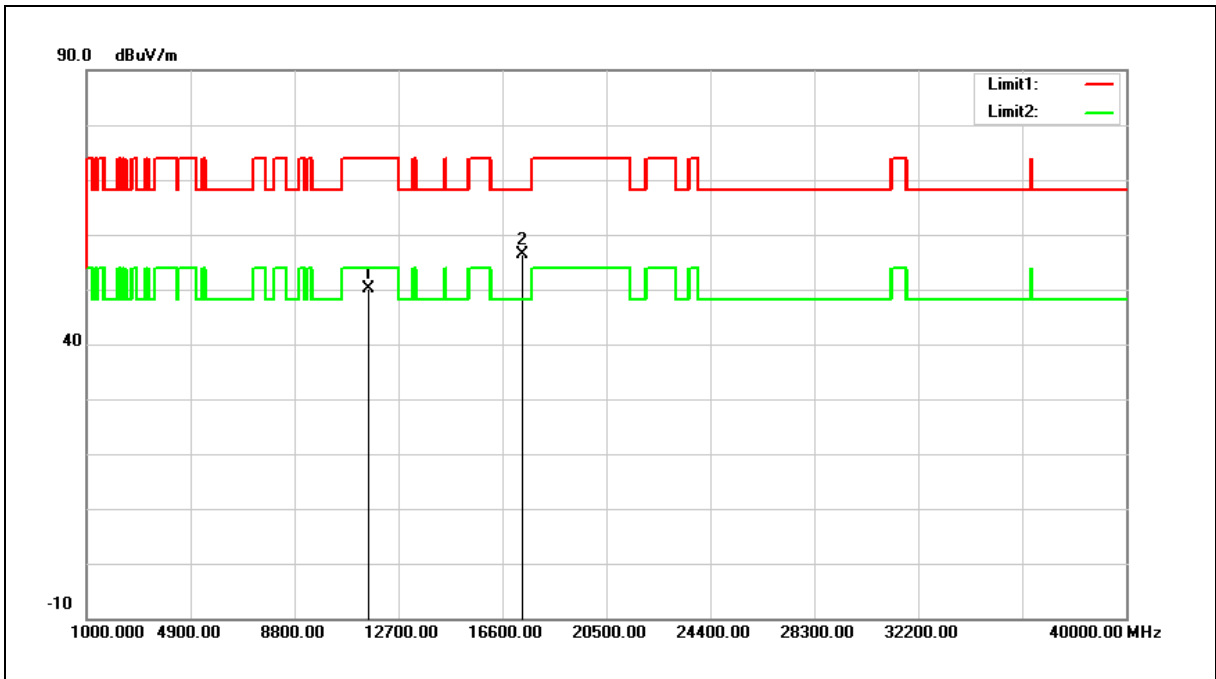

No.	Frequency (MHz)	Reading (dBuV)	Correct Factor (dB/m)	Result (dBuV/m)	Limit (dBuV/m)	Margin (dB)	Remark
1	11570.000	30.85	19.39	50.24	74.00	-23.76	peak
2	17355.000	30.92	25.34	56.26	68.20	-11.94	peak

Note:1.Result (dBuV/m) = Correct Factor (dB/m) + Reading(dBuV).

2.Correction factor (dB/m) = Antenna Factor (dB/m) + Cable loss (dB) – Pre-Amplifier gain (dB).

3.When the peak results are less than average limit, so not need to evaluate the average.



Standard:	FCC Part 15.407	Test Distance:	3m
Test item:	Harmonic		
Frequency:	5825MHz		
Mode:	Mode 3		
Ant.Polar.:	Horizontal		

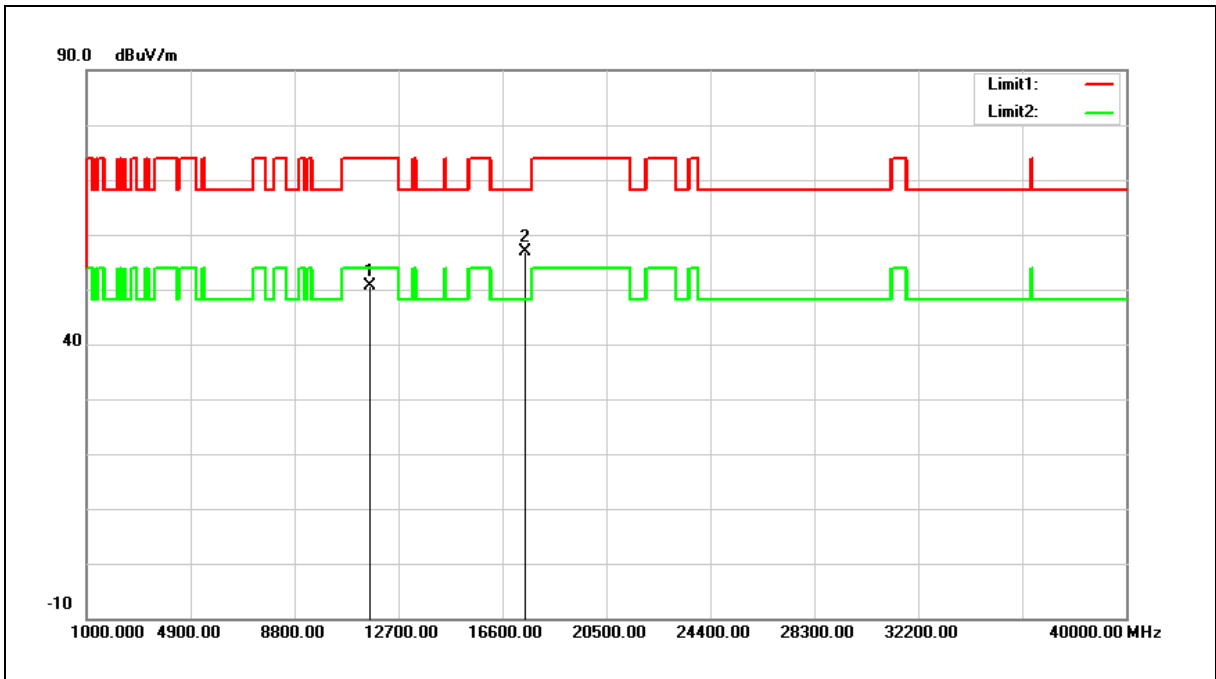

No.	Frequency (MHz)	Reading (dBuV)	Correct Factor (dB/m)	Result (dBuV/m)	Limit (dBuV/m)	Margin (dB)	Remark
1	11650.000	31.20	19.32	50.52	74.00	-23.48	peak
2	17475.000	31.19	25.65	56.84	68.20	-11.36	peak

Note:1.Result (dBuV/m) = Correct Factor (dB/m) + Reading(dBuV).

2.Correction factor (dB/m) = Antenna Factor (dB/m) + Cable loss (dB) – Pre-Amplifier gain (dB).

3.When the peak results are less than average limit, so not need to evaluate the average.



Standard:	FCC Part 15.407	Test Distance:	3m
Test item:	Harmonic		
Frequency:	5825MHz		
Mode:	Mode 3		
Ant.Polar.:	Vertical		

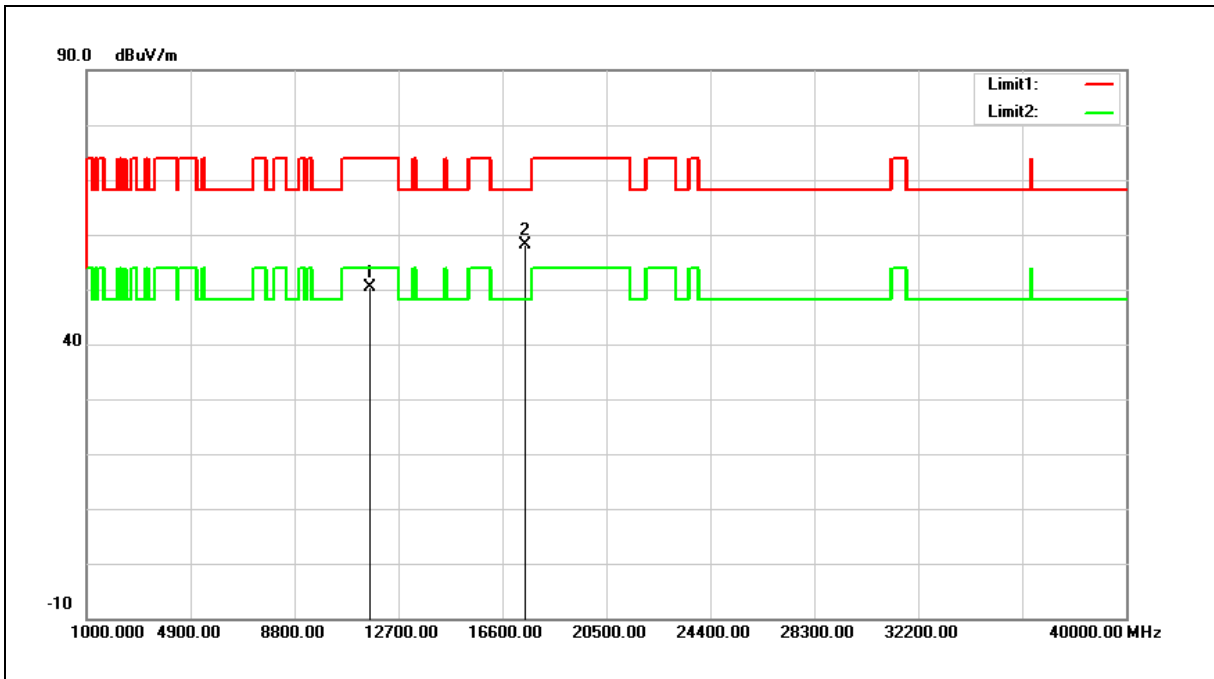

No.	Frequency (MHz)	Reading (dBuV)	Correct Factor (dB/m)	Result (dBuV/m)	Limit (dBuV/m)	Margin (dB)	Remark
1	11650.000	31.16	19.32	50.48	74.00	-23.52	peak
2	17475.000	32.42	25.65	58.07	68.20	-10.13	peak

Note:1.Result (dBuV/m) = Correct Factor (dB/m) + Reading(dBuV).

2.Correction factor (dB/m) = Antenna Factor (dB/m) + Cable loss (dB) – Pre-Amplifier gain (dB).

3.When the peak results are less than average limit, so not need to evaluate the average.



Standard:	FCC Part 15.407	Test Distance:	3m
Test item:	Harmonic		
Frequency:	5190MHz		
Mode:	Mode 4		
Ant.Polar.:	Horizontal		

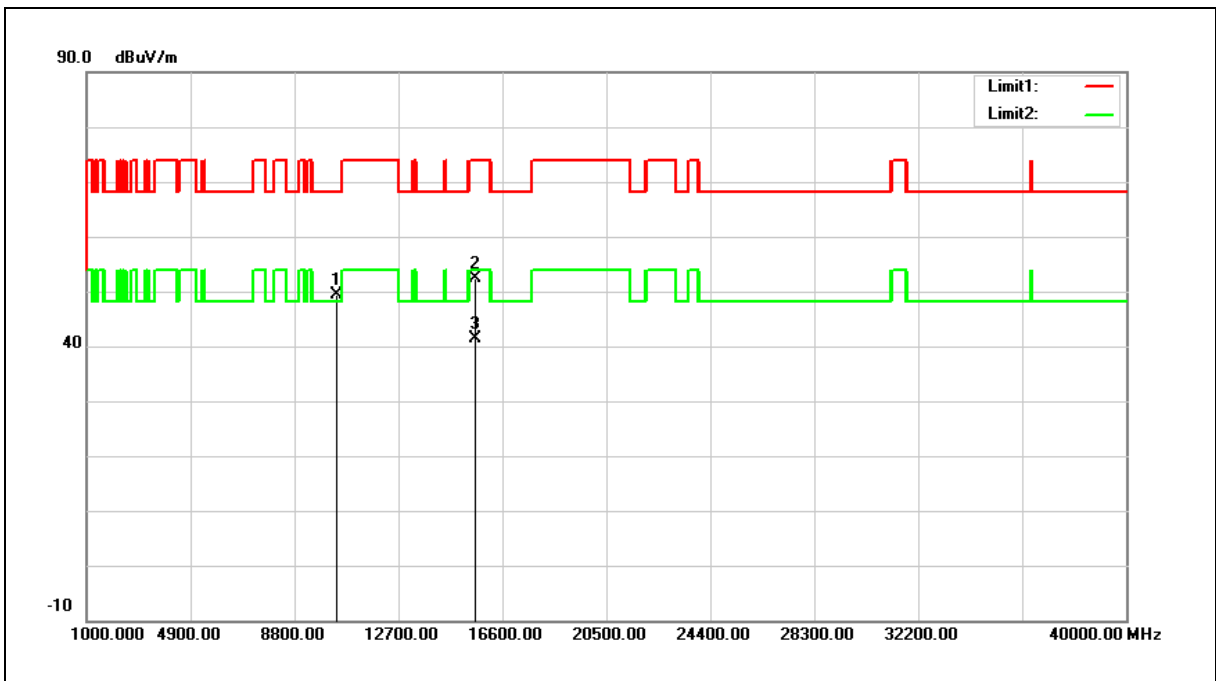

No.	Frequency (MHz)	Reading (dBuV)	Correct Factor (dB/m)	Result (dBuV/m)	Limit (dBuV/m)	Margin (dB)	Remark
1	10380.000	31.98	17.35	49.33	68.20	-18.87	peak
2	15570.000	31.65	20.68	52.33	74.00	-21.67	peak
3	15570.000	20.61	20.68	41.29	54.00	-12.71	AVG

Note:1.Result (dBuV/m) = Correct Factor (dB/m) + Reading(dBuV).

2.Correction factor (dB/m) = Antenna Factor (dB/m) + Cable loss (dB) – Pre-Amplifier gain (dB).

3.When the peak results are less than average limit, so not need to evaluate the average.



Standard:	FCC Part 15.407	Test Distance:	3m
Test item:	Harmonic		
Frequency:	5190MHz		
Mode:	Mode 4		
Ant.Polar.:	Vertical		

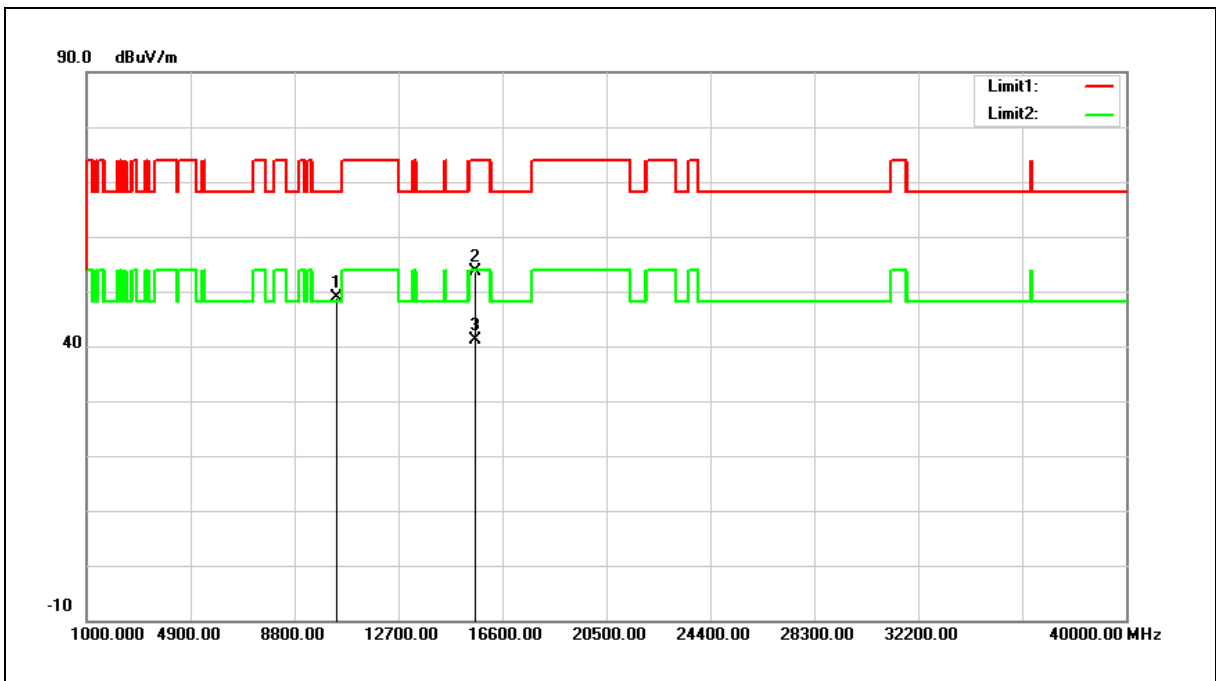

No.	Frequency (MHz)	Reading (dBuV)	Correct Factor (dB/m)	Result (dBuV/m)	Limit (dBuV/m)	Margin (dB)	Remark
1	10380.000	31.61	17.35	48.96	68.20	-19.24	peak
2	15570.000	33.02	20.68	53.70	74.00	-20.30	peak
3	15570.000	20.55	20.68	41.23	54.00	-12.77	AVG

Note:1.Result (dBuV/m) = Correct Factor (dB/m) + Reading(dBuV).

2.Correction factor (dB/m) = Antenna Factor (dB/m) + Cable loss (dB) – Pre-Amplifier gain (dB).

3.When the peak results are less than average limit, so not need to evaluate the average.



Standard:	FCC Part 15.407	Test Distance:	3m
Test item:	Harmonic		
Frequency:	5230MHz		
Mode:	Mode 4		
Ant.Polar.:	Horizontal		

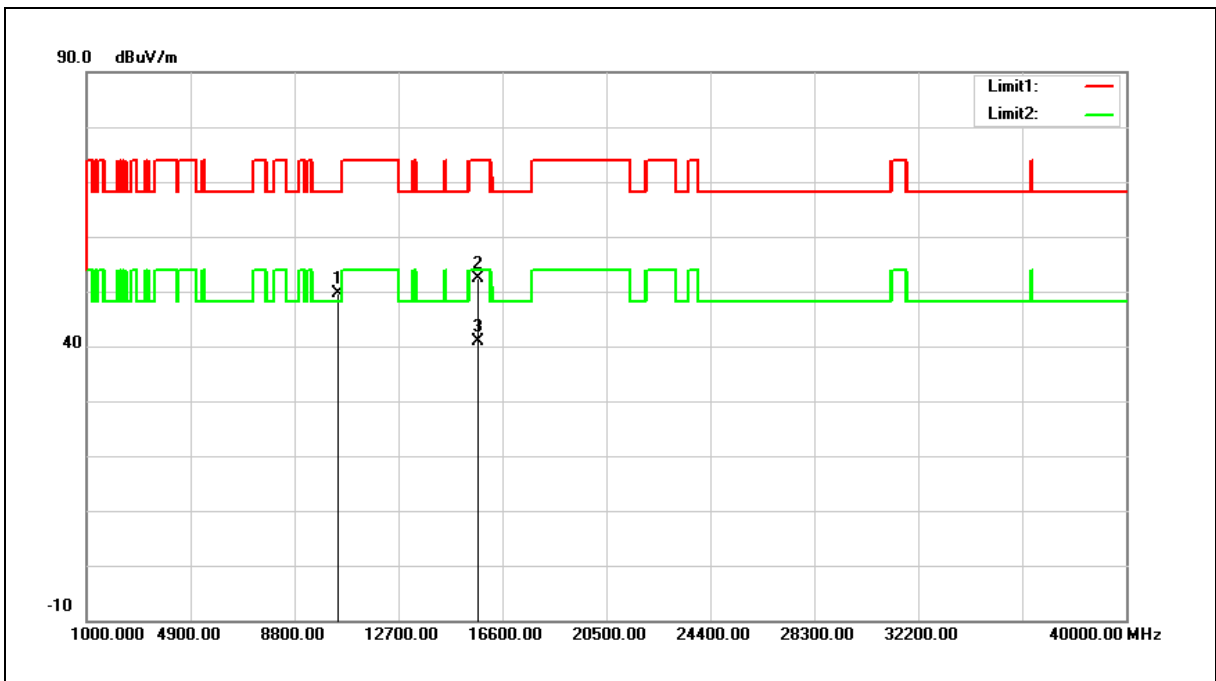

No.	Frequency (MHz)	Reading (dBuV)	Correct Factor (dB/m)	Result (dBuV/m)	Limit (dBuV/m)	Margin (dB)	Remark
1	10460.000	32.10	17.59	49.69	68.20	-18.51	peak
2	15690.000	32.10	20.37	52.47	74.00	-21.53	peak
3	15690.000	20.55	20.37	40.92	54.00	-13.08	AVG

Note:1.Result (dBuV/m) = Correct Factor (dB/m) + Reading(dBuV).

2.Correction factor (dB/m) = Antenna Factor (dB/m) + Cable loss (dB) – Pre-Amplifier gain (dB).

3.When the peak results are less than average limit, so not need to evaluate the average.



Standard:	FCC Part 15.407	Test Distance:	3m
Test item:	Harmonic		
Frequency:	5230MHz		
Mode:	Mode 4		
Ant.Polar.:	Vertical		

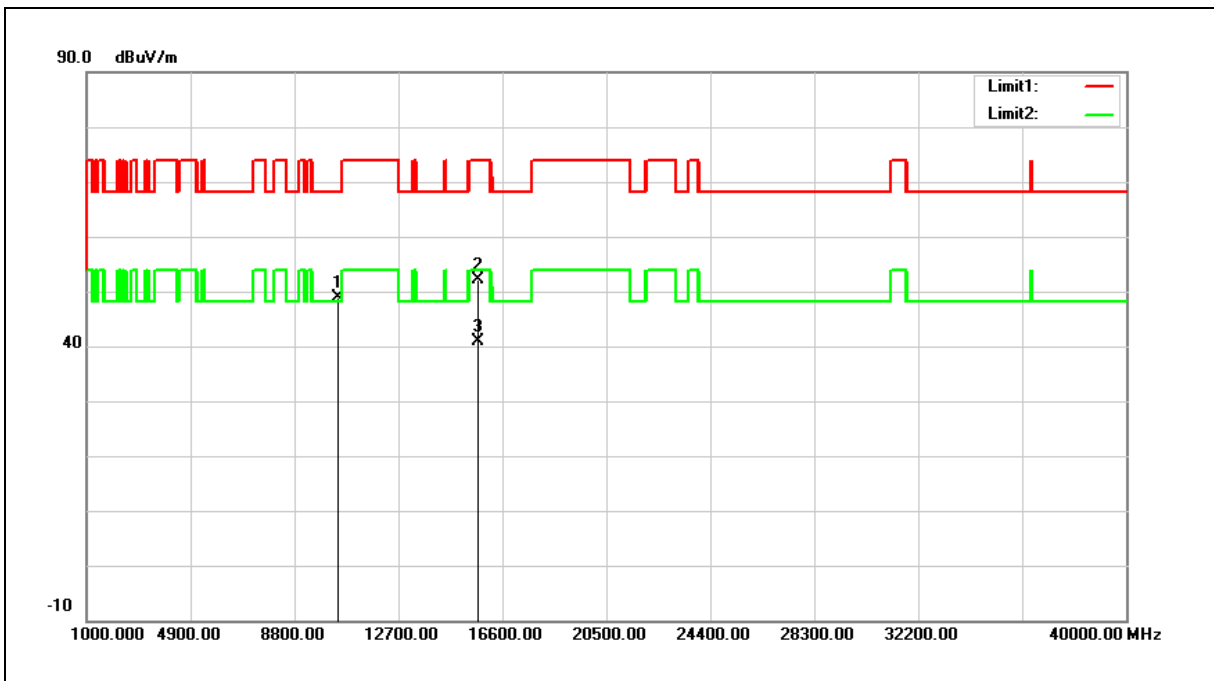

No.	Frequency (MHz)	Reading (dBuV)	Correct Factor (dB/m)	Result (dBuV/m)	Limit (dBuV/m)	Margin (dB)	Remark
1	10460.000	31.30	17.59	48.89	68.20	-19.31	peak
2	15690.000	31.70	20.37	52.07	74.00	-21.93	peak
3	15690.000	20.50	20.37	40.87	54.00	-13.13	AVG

Note:1.Result (dBuV/m) = Correct Factor (dB/m) + Reading(dBuV).

2.Correction factor (dB/m) = Antenna Factor (dB/m) + Cable loss (dB) – Pre-Amplifier gain (dB).

3.When the peak results are less than average limit, so not need to evaluate the average.



Standard:	FCC Part 15.407	Test Distance:	3m
Test item:	Harmonic		
Frequency:	5755MHz		
Mode:	Mode 4		
Ant.Polar.:	Horizontal		

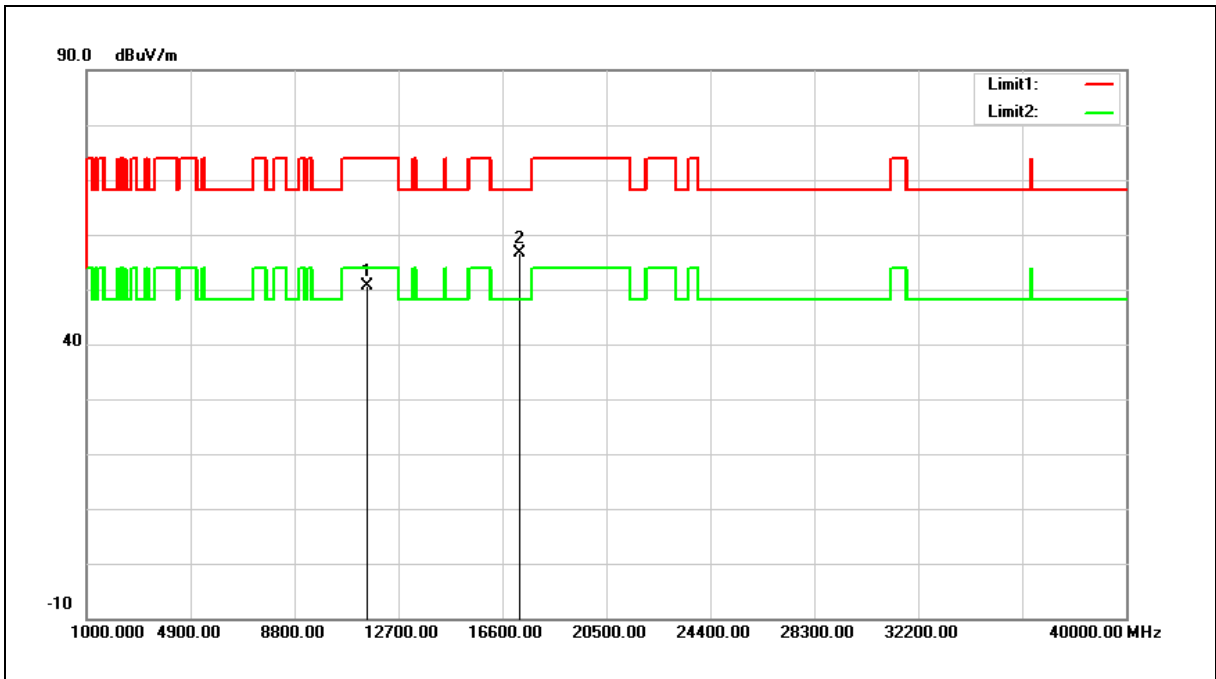

No.	Frequency (MHz)	Reading (dBuV)	Correct Factor (dB/m)	Result (dBuV/m)	Limit (dBuV/m)	Margin (dB)	Remark
1	11510.000	31.22	19.46	50.68	74.00	-23.32	peak
2	17265.000	31.52	25.09	56.61	68.20	-11.59	peak

Note:1.Result (dBuV/m) = Correct Factor (dB/m) + Reading(dBuV).

2.Correction factor (dB/m) = Antenna Factor (dB/m) + Cable loss (dB) – Pre-Amplifier gain (dB).

3.When the peak results are less than average limit, so not need to evaluate the average.



Standard:	FCC Part 15.407	Test Distance:	3m
Test item:	Harmonic		
Frequency:	5755MHz		
Mode:	Mode 4		
Ant.Polar.:	Vertical		

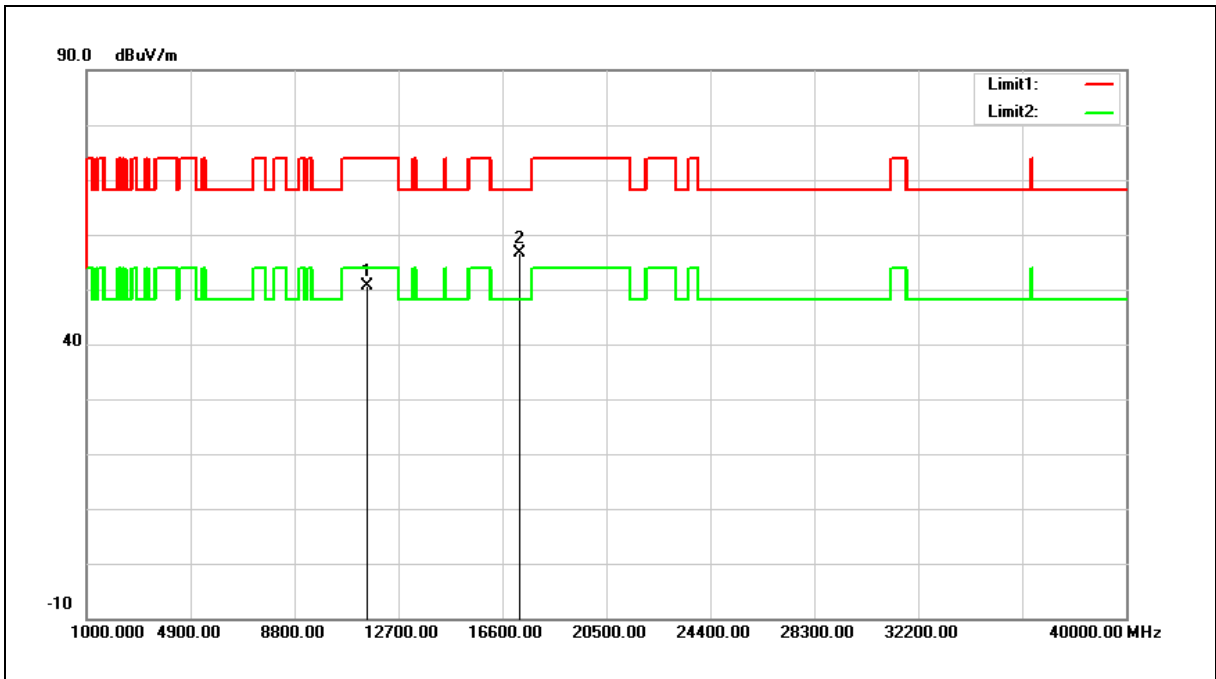

No.	Frequency (MHz)	Reading (dBuV)	Correct Factor (dB/m)	Result (dBuV/m)	Limit (dBuV/m)	Margin (dB)	Remark
1	11510.000	31.26	19.46	50.72	74.00	-23.28	peak
2	17265.000	31.58	25.09	56.67	68.20	-11.53	peak

Note:1.Result (dBuV/m) = Correct Factor (dB/m) + Reading(dBuV).

2.Correction factor (dB/m) = Antenna Factor (dB/m) + Cable loss (dB) – Pre-Amplifier gain (dB).

3.When the peak results are less than average limit, so not need to evaluate the average.



Standard:	FCC Part 15.407	Test Distance:	3m
Test item:	Harmonic		
Frequency:	5795MHz		
Mode:	Mode 4		
Ant.Polar.:	Horizontal		

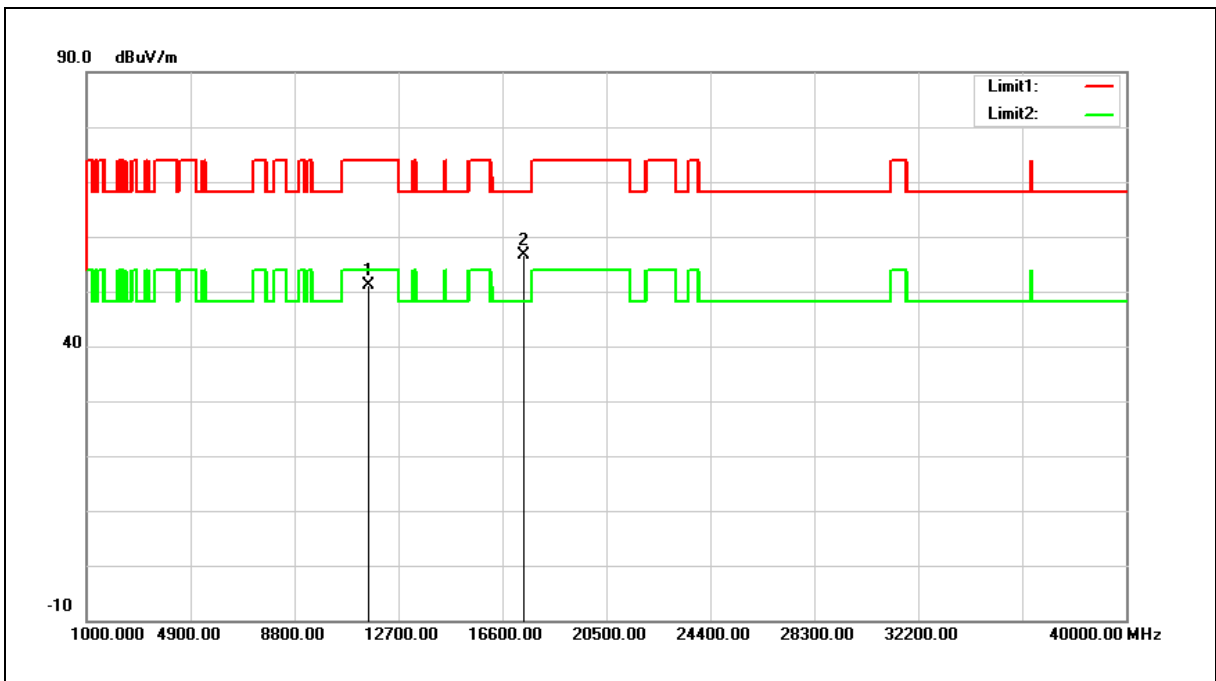

No.	Frequency (MHz)	Reading (dBuV)	Correct Factor (dB/m)	Result (dBuV/m)	Limit (dBuV/m)	Margin (dB)	Remark
1	11590.000	31.65	19.38	51.03	74.00	-22.97	peak
2	17385.000	31.30	25.41	56.71	68.20	-11.49	peak

Note:1.Result (dBuV/m) = Correct Factor (dB/m) + Reading(dBuV).

2.Correction factor (dB/m) = Antenna Factor (dB/m) + Cable loss (dB) – Pre-Amplifier gain (dB).

3.When the peak results are less than average limit, so not need to evaluate the average.



Standard:	FCC Part 15.407	Test Distance:	3m
Test item:	Harmonic		
Frequency:	5795MHz		
Mode:	Mode 4		
Ant.Polar.:	Vertical		

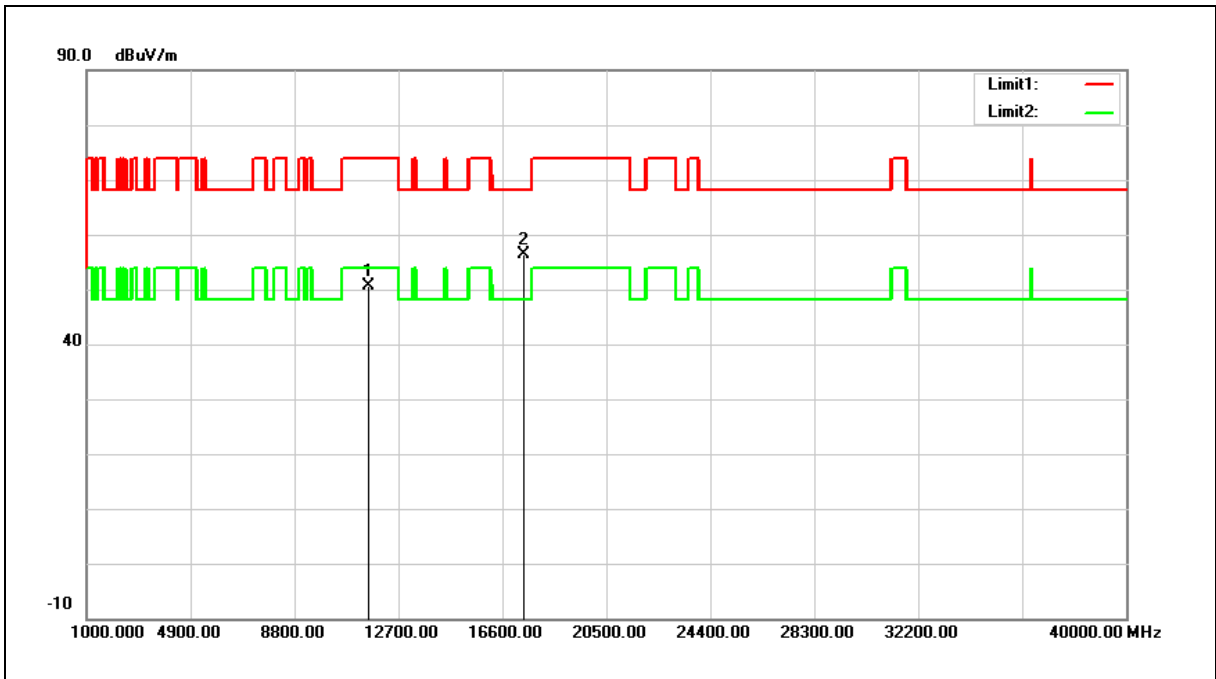

No.	Frequency (MHz)	Reading (dBuV)	Correct Factor (dB/m)	Result (dBuV/m)	Limit (dBuV/m)	Margin (dB)	Remark
1	11590.000	31.20	19.38	50.58	74.00	-23.42	peak
2	17385.000	31.06	25.41	56.47	68.20	-11.73	peak

Note:1.Result (dBuV/m) = Correct Factor (dB/m) + Reading(dBuV).

2.Correction factor (dB/m) = Antenna Factor (dB/m) + Cable loss (dB) – Pre-Amplifier gain (dB).

3.When the peak results are less than average limit, so not need to evaluate the average.



Standard:	FCC Part 15.407	Test Distance:	3m
Test item:	Harmonic		
Frequency:	5210MHz		
Mode:	Mode 5		
Ant.Polar.:	Horizontal		

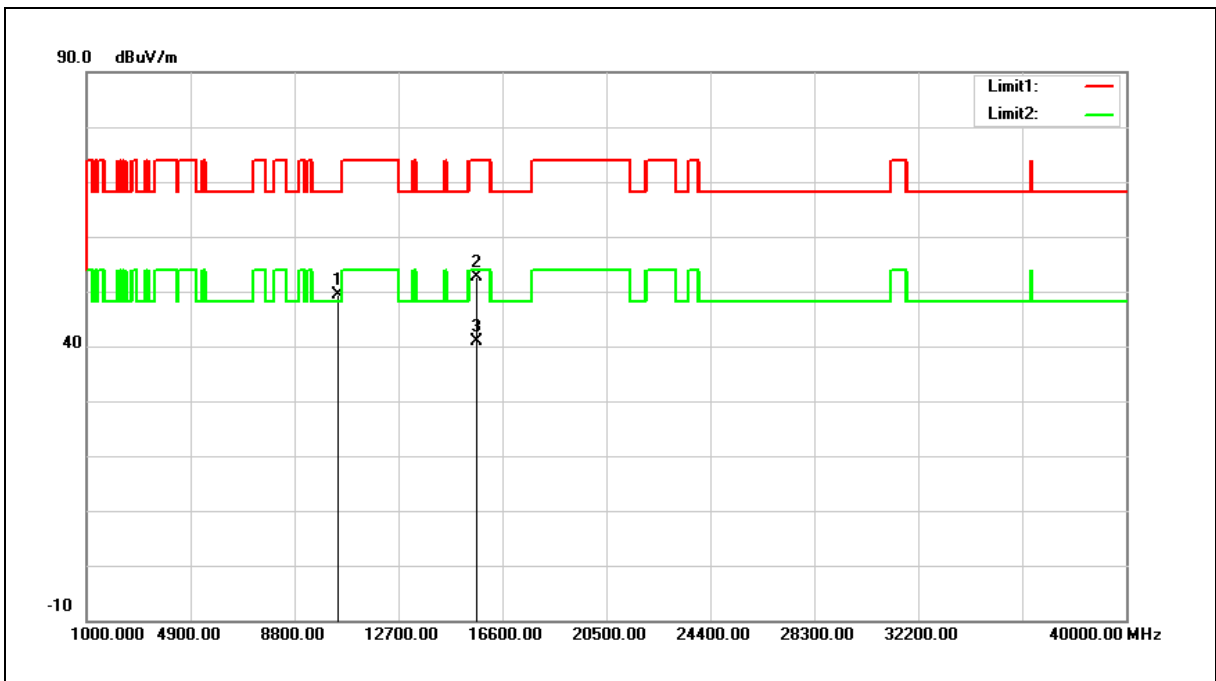

No.	Frequency (MHz)	Reading (dBuV)	Correct Factor (dB/m)	Result (dBuV/m)	Limit (dBuV/m)	Margin (dB)	Remark
1	10420.000	31.89	17.46	49.35	68.20	-18.85	peak
2	15630.000	32.12	20.53	52.65	74.00	-21.35	peak
3	15630.000	20.37	20.53	40.90	54.00	-13.10	AVG

Note:1.Result (dBuV/m) = Correct Factor (dB/m) + Reading(dBuV).

2.Correction factor (dB/m) = Antenna Factor (dB/m) + Cable loss (dB) – Pre-Amplifier gain (dB).

3.When the peak results are less than average limit, so not need to evaluate the average.



Standard:	FCC Part 15.407	Test Distance:	3m
Test item:	Harmonic		
Frequency:	5210MHz		
Mode:	Mode 5		
Ant.Polar.:	Vertical		

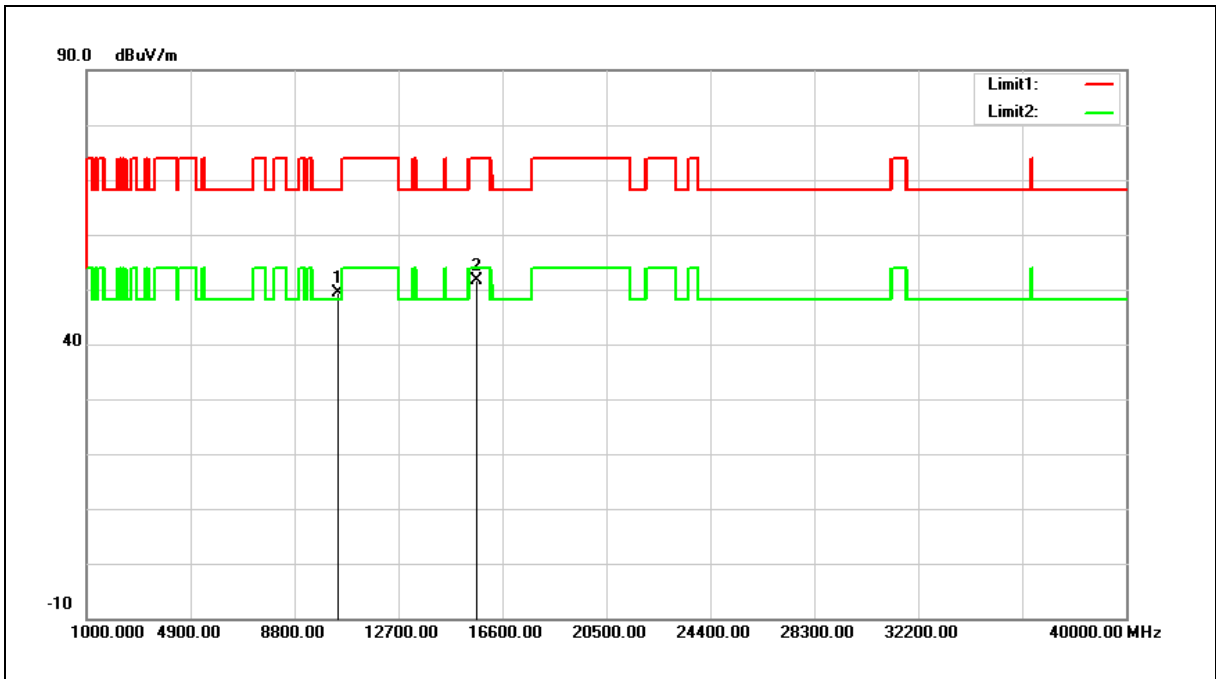

No.	Frequency (MHz)	Reading (dBuV)	Correct Factor (dB/m)	Result (dBuV/m)	Limit (dBuV/m)	Margin (dB)	Remark
1	10420.000	31.85	17.46	49.31	68.20	-18.89	peak
2	15630.000	31.15	20.53	51.68	74.00	-22.32	peak

Note:1.Result (dBuV/m) = Correct Factor (dB/m) + Reading(dBuV).

2.Correction factor (dB/m) = Antenna Factor (dB/m) + Cable loss (dB) – Pre-Amplifier gain (dB).

3.When the peak results are less than average limit, so not need to evaluate the average.



Standard:	FCC Part 15.407	Test Distance:	3m
Test item:	Harmonic		
Frequency:	5775MHz		
Mode:	Mode 5		
Ant.Polar.:	Horizontal		

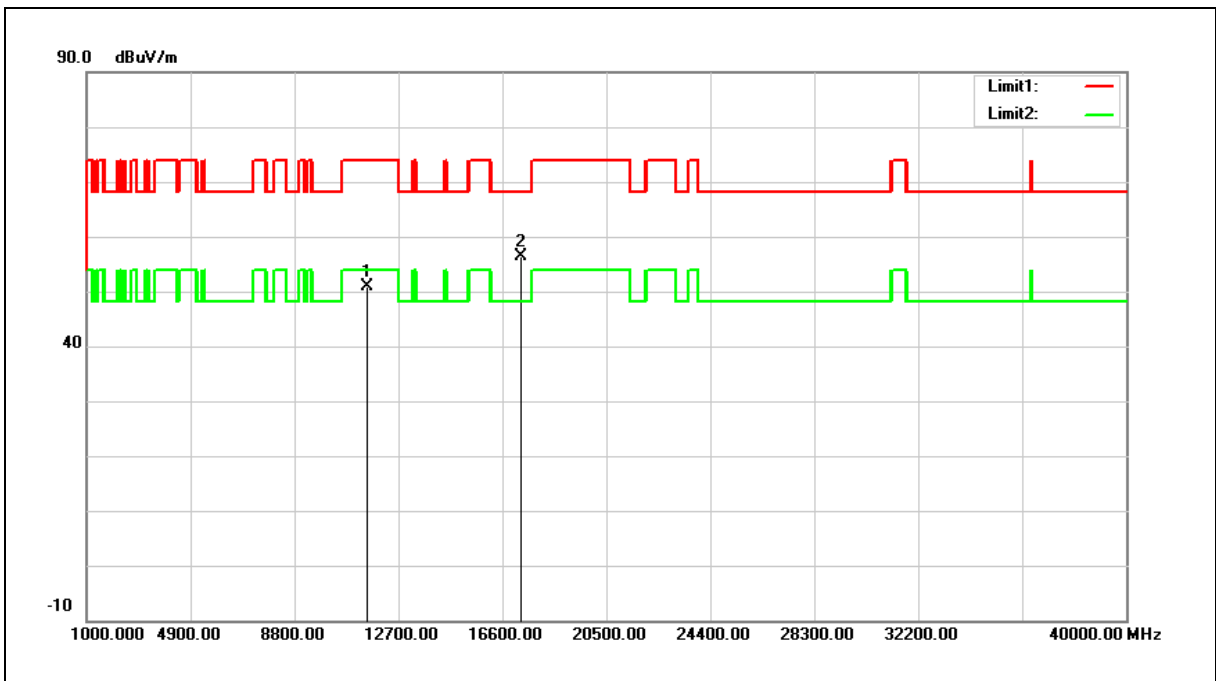

No.	Frequency (MHz)	Reading (dBuV)	Correct Factor (dB/m)	Result (dBuV/m)	Limit (dBuV/m)	Margin (dB)	Remark
1	11550.000	31.41	19.42	50.83	74.00	-23.17	peak
2	17325.000	31.20	25.25	56.45	68.20	-11.75	peak

Note:1.Result (dBuV/m) = Correct Factor (dB/m) + Reading(dBuV).

2.Correction factor (dB/m) = Antenna Factor (dB/m) + Cable loss (dB) – Pre-Amplifier gain (dB).

3.When the peak results are less than average limit, so not need to evaluate the average.



Standard:	FCC Part 15.407	Test Distance:	3m
Test item:	Harmonic		
Frequency:	5775MHz		
Mode:	Mode 5		
Ant.Polar.:	Vertical		

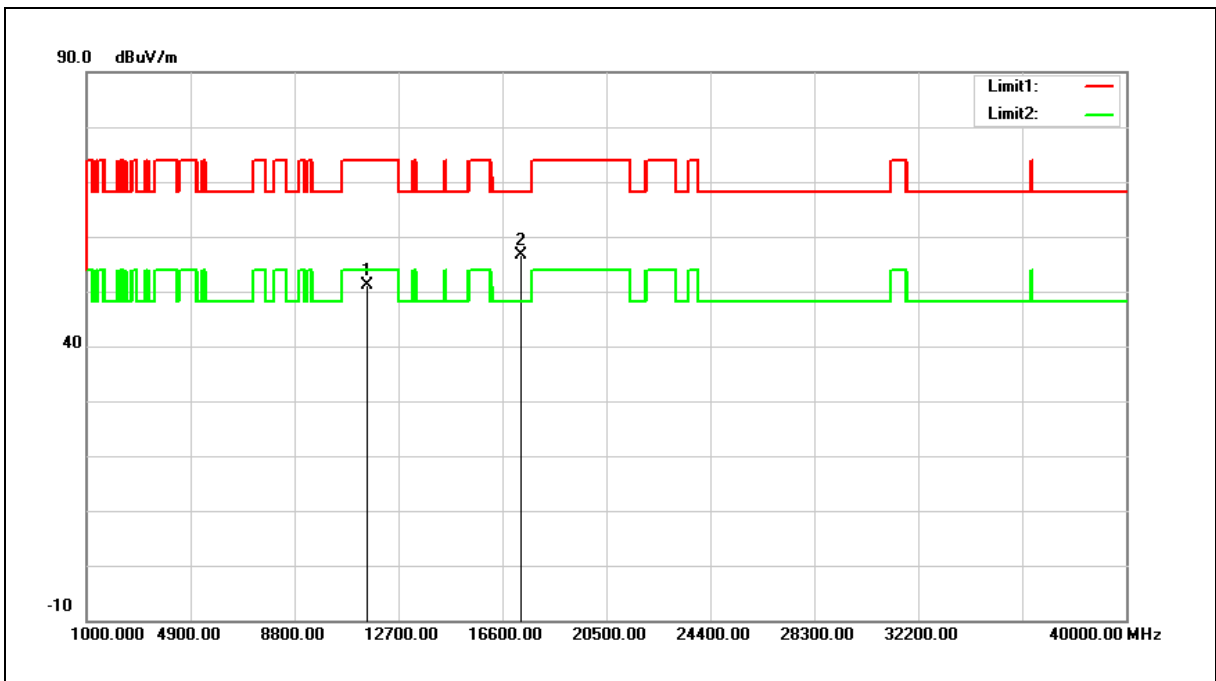

No.	Frequency (MHz)	Reading (dBuV)	Correct Factor (dB/m)	Result (dBuV/m)	Limit (dBuV/m)	Margin (dB)	Remark
1	11550.000	31.74	19.42	51.16	74.00	-22.84	peak
2	17325.000	31.34	25.25	56.59	68.20	-11.61	peak

Note:1.Result (dBuV/m) = Correct Factor (dB/m) + Reading(dBuV).

2.Correction factor (dB/m) = Antenna Factor (dB/m) + Cable loss (dB) – Pre-Amplifier gain (dB).

3.When the peak results are less than average limit, so not need to evaluate the average.



Standard:	FCC Part 15.407	Test Distance:	3m
Test item:	Harmonic		
Frequency:	5180MHz		
Mode:	Mode 6		
Ant.Polar.:	Horizontal		

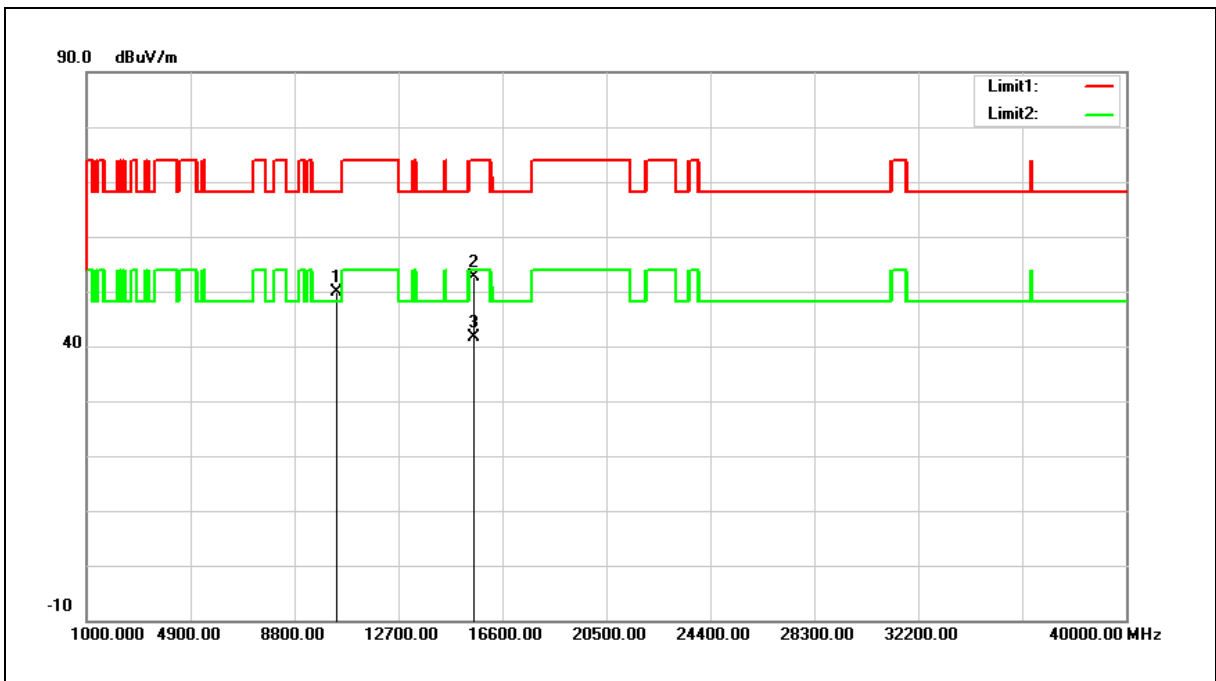

No.	Frequency (MHz)	Reading (dBuV)	Correct Factor (dB/m)	Result (dBuV/m)	Limit (dBuV/m)	Margin (dB)	Remark
1	10360.000	32.56	17.29	49.85	68.20	-18.35	peak
2	15540.000	31.99	20.75	52.74	74.00	-21.26	peak
3	15540.000	20.84	20.75	41.59	54.00	-12.41	AVG

Note:1.Result (dBuV/m) = Correct Factor (dB/m) + Reading(dBuV).

2.Correction factor (dB/m) = Antenna Factor (dB/m) + Cable loss (dB) – Pre-Amplifier gain (dB).

3.When the peak results are less than average limit, so not need to evaluate the average.



Standard:	FCC Part 15.407	Test Distance:	3m
Test item:	Harmonic		
Frequency:	5180MHz		
Mode:	Mode 6		
Ant.Polar.:	Vertical		

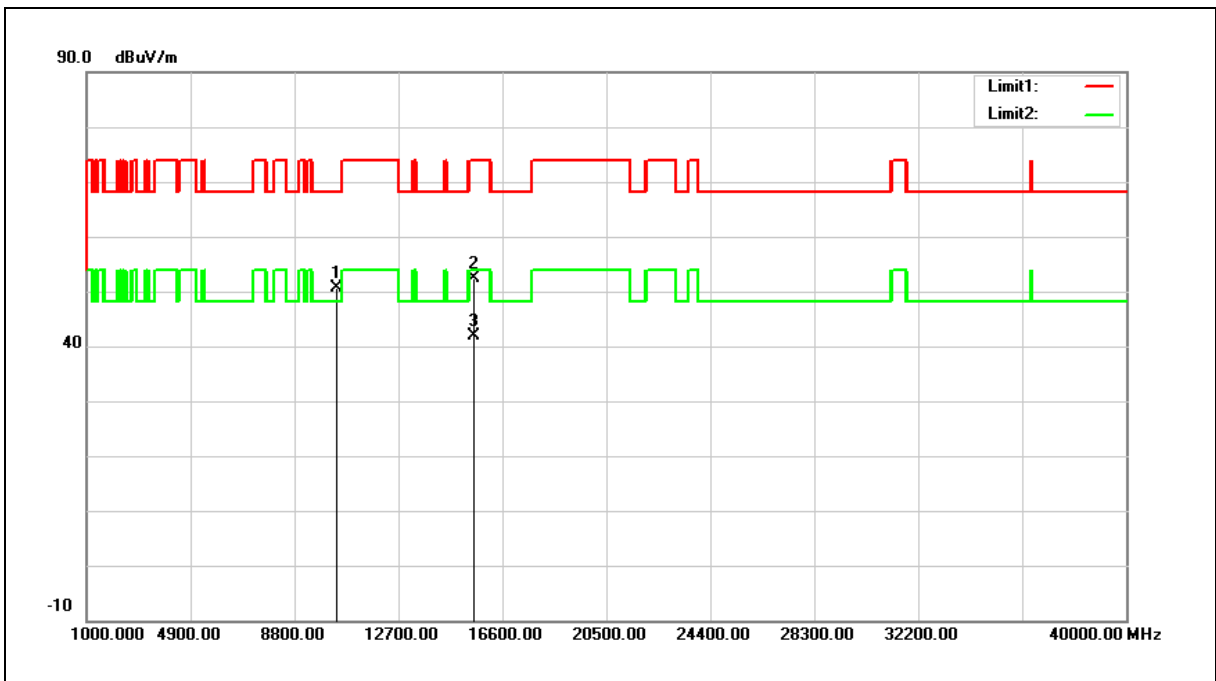

No.	Frequency (MHz)	Reading (dBuV)	Correct Factor (dB/m)	Result (dBuV/m)	Limit (dBuV/m)	Margin (dB)	Remark
1	10360.000	33.38	17.29	50.67	68.20	-17.53	peak
2	15540.000	31.55	20.75	52.30	74.00	-21.70	peak
3	15540.000	21.07	20.75	41.82	54.00	-12.18	AVG

Note:1.Result (dBuV/m) = Correct Factor (dB/m) + Reading(dBuV).

2.Correction factor (dB/m) = Antenna Factor (dB/m) + Cable loss (dB) – Pre-Amplifier gain (dB).

3.When the peak results are less than average limit, so not need to evaluate the average.



Standard:	FCC Part 15.407	Test Distance:	3m
Test item:	Harmonic		
Frequency:	5200MHz		
Mode:	Mode 6		
Ant.Polar.:	Horizontal		

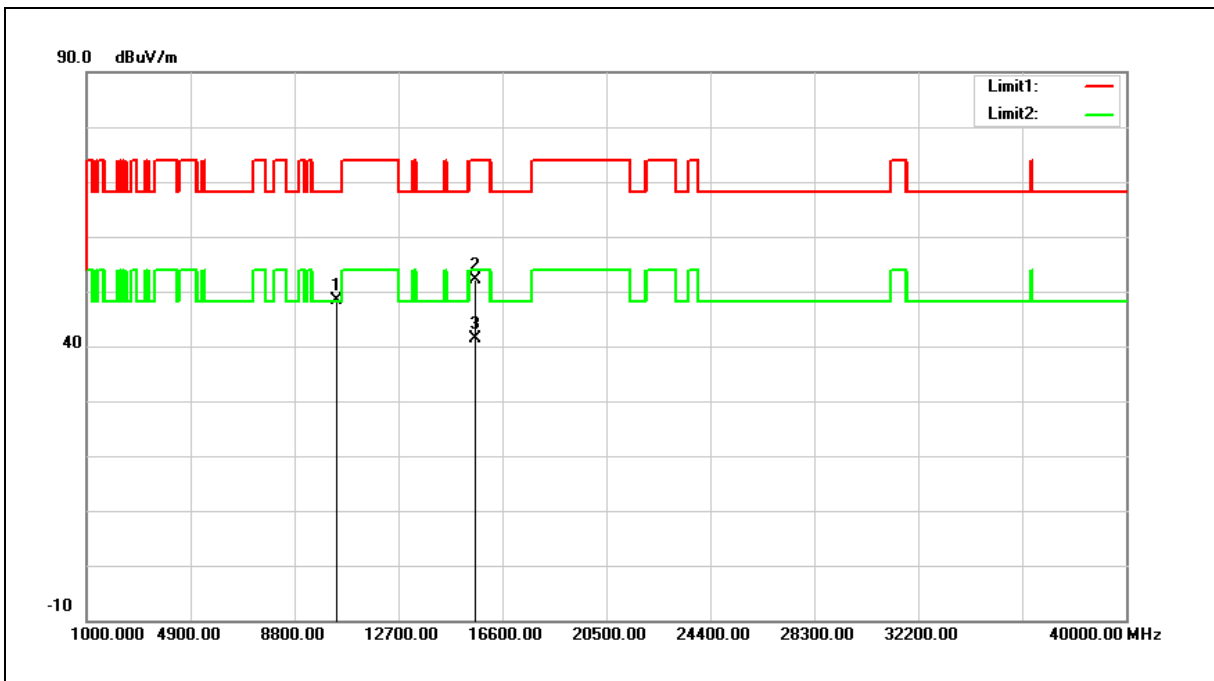

No.	Frequency (MHz)	Reading (dBuV)	Correct Factor (dB/m)	Result (dBuV/m)	Limit (dBuV/m)	Margin (dB)	Remark
1	10400.000	30.90	17.40	48.30	68.20	-19.90	peak
2	15600.000	31.50	20.60	52.10	74.00	-21.90	peak
3	15600.000	20.89	20.60	41.49	54.00	-12.51	AVG

Note:1.Result (dBuV/m) = Correct Factor (dB/m) + Reading(dBuV).

2.Correction factor (dB/m) = Antenna Factor (dB/m) + Cable loss (dB) – Pre-Amplifier gain (dB).

3.When the peak results are less than average limit, so not need to evaluate the average.



Standard:	FCC Part 15.407	Test Distance:	3m
Test item:	Harmonic		
Frequency:	5200MHz		
Mode:	Mode 6		
Ant.Polar.:	Vertical		

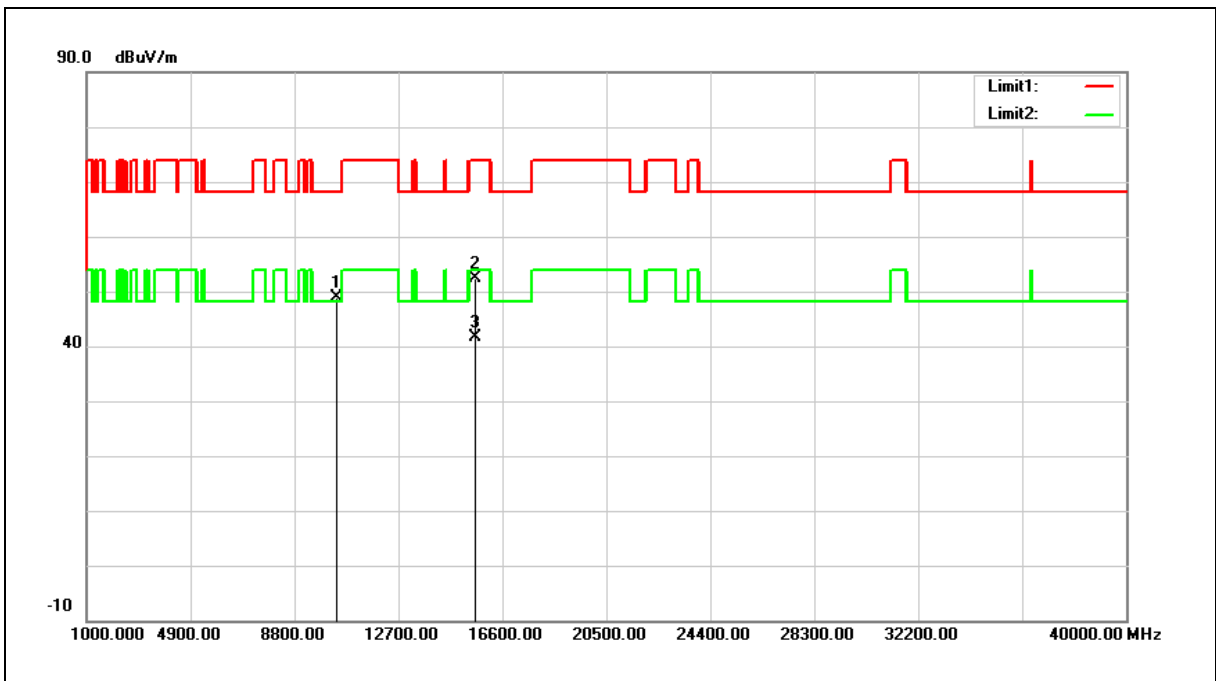

No.	Frequency (MHz)	Reading (dBuV)	Correct Factor (dB/m)	Result (dBuV/m)	Limit (dBuV/m)	Margin (dB)	Remark
1	10400.000	31.56	17.40	48.96	68.20	-19.24	peak
2	15600.000	31.68	20.60	52.28	74.00	-21.72	peak
3	15600.000	21.06	20.60	41.66	54.00	-12.34	AVG

Note:1.Result (dBuV/m) = Correct Factor (dB/m) + Reading(dBuV).

2.Correction factor (dB/m) = Antenna Factor (dB/m) + Cable loss (dB) – Pre-Amplifier gain (dB).

3.When the peak results are less than average limit, so not need to evaluate the average.



Standard:	FCC Part 15.407	Test Distance:	3m
Test item:	Harmonic		
Frequency:	5240MHz		
Mode:	Mode 6		
Ant.Polar.:	Horizontal		

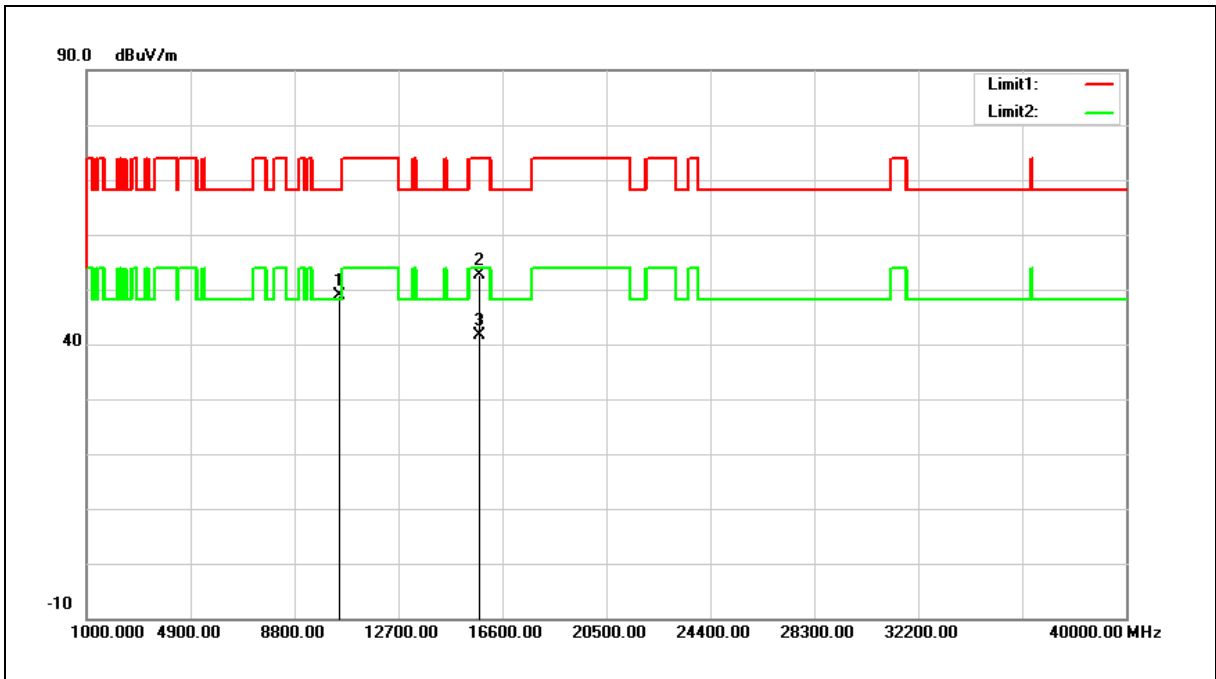

No.	Frequency (MHz)	Reading (dBuV)	Correct Factor (dB/m)	Result (dBuV/m)	Limit (dBuV/m)	Margin (dB)	Remark
1	10480.000	31.35	17.64	48.99	68.20	-19.21	peak
2	15720.000	32.24	20.30	52.54	74.00	-21.46	peak
3	15720.000	21.41	20.30	41.71	54.00	-12.29	AVG

Note:1.Result (dBuV/m) = Correct Factor (dB/m) + Reading(dBuV).

2.Correction factor (dB/m) = Antenna Factor (dB/m) + Cable loss (dB) – Pre-Amplifier gain (dB).

3.When the peak results are less than average limit, so not need to evaluate the average.



Standard:	FCC Part 15.407	Test Distance:	3m
Test item:	Harmonic		
Frequency:	5240MHz		
Mode:	Mode 6		
Ant.Polar.:	Vertical		

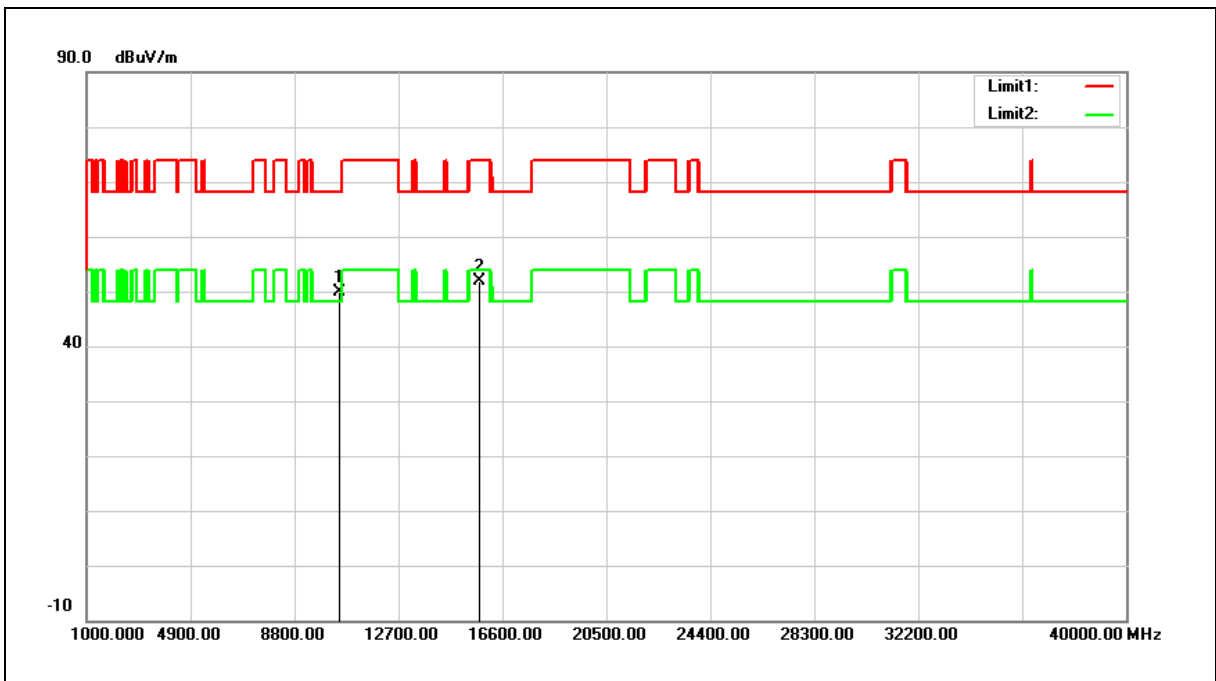

No.	Frequency (MHz)	Reading (dBuV)	Correct Factor (dB/m)	Result (dBuV/m)	Limit (dBuV/m)	Margin (dB)	Remark
1	10480.000	32.15	17.64	49.79	68.20	-18.41	peak
2	15720.000	31.64	20.30	51.94	74.00	-22.06	peak

Note:1.Result (dBuV/m) = Correct Factor (dB/m) + Reading(dBuV).

2.Correction factor (dB/m) = Antenna Factor (dB/m) + Cable loss (dB) – Pre-Amplifier gain (dB).

3.When the peak results are less than average limit, so not need to evaluate the average.



Standard:	FCC Part 15.407	Test Distance:	3m
Test item:	Harmonic		
Frequency:	5745MHz		
Mode:	Mode 6		
Ant.Polar.:	Horizontal		

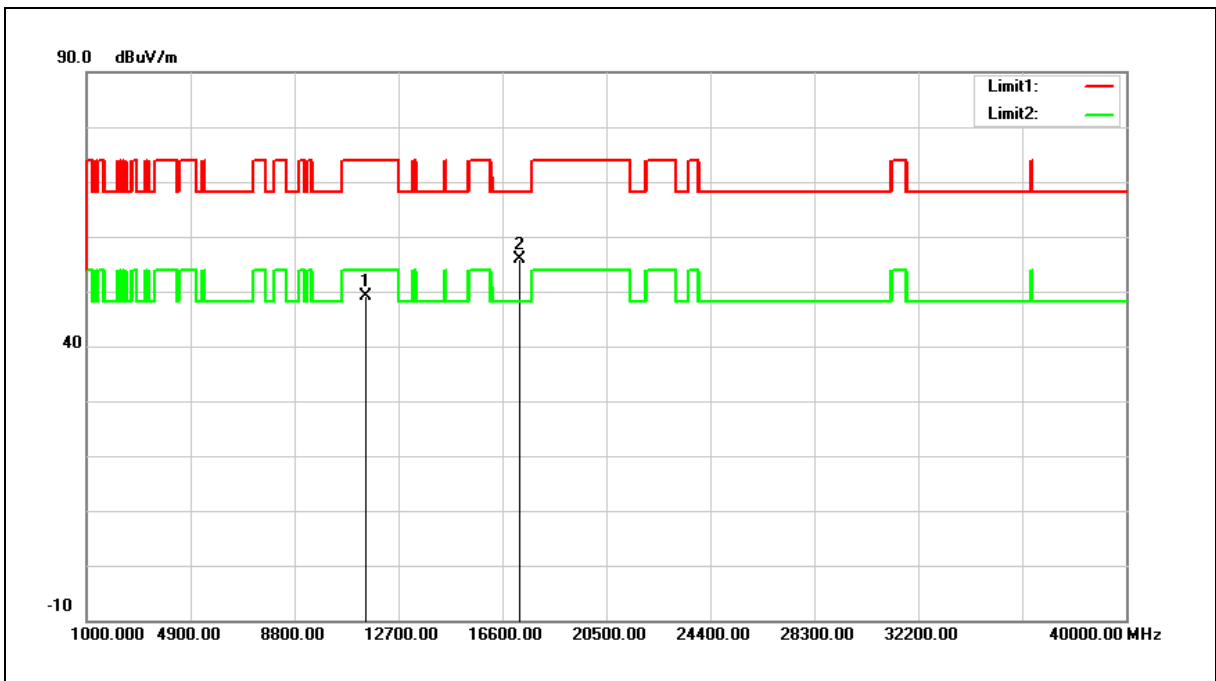

No.	Frequency (MHz)	Reading (dBuV)	Correct Factor (dB/m)	Result (dBuV/m)	Limit (dBuV/m)	Margin (dB)	Remark
1	11490.000	29.76	19.45	49.21	74.00	-24.79	peak
2	17235.000	30.78	25.01	55.79	68.20	-12.41	peak

Note:1.Result (dBuV/m) = Correct Factor (dB/m) + Reading(dBuV).

2.Correction factor (dB/m) = Antenna Factor (dB/m) + Cable loss (dB) – Pre-Amplifier gain (dB).

3.When the peak results are less than average limit, so not need to evaluate the average.



Standard:	FCC Part 15.407	Test Distance:	3m
Test item:	Harmonic		
Frequency:	5745MHz		
Mode:	Mode 6		
Ant.Polar.:	Vertical		

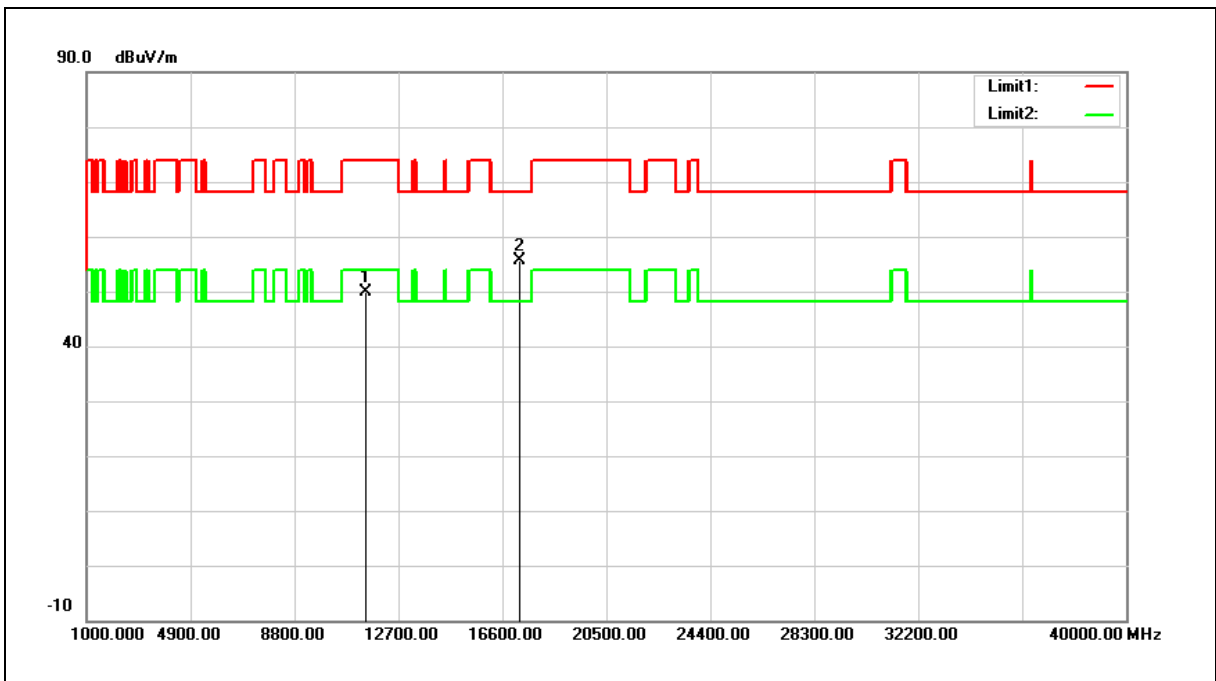

No.	Frequency (MHz)	Reading (dBuV)	Correct Factor (dB/m)	Result (dBuV/m)	Limit (dBuV/m)	Margin (dB)	Remark
1	11490.000	30.47	19.45	49.92	74.00	-24.08	peak
2	17235.000	30.57	25.01	55.58	68.20	-12.62	peak

Note:1.Result (dBuV/m) = Correct Factor (dB/m) + Reading(dBuV).

2.Correction factor (dB/m) = Antenna Factor (dB/m) + Cable loss (dB) – Pre-Amplifier gain (dB).

3.When the peak results are less than average limit, so not need to evaluate the average.



Standard:	FCC Part 15.407	Test Distance:	3m
Test item:	Harmonic		
Frequency:	5785MHz		
Mode:	Mode 6		
Ant.Polar.:	Horizontal		

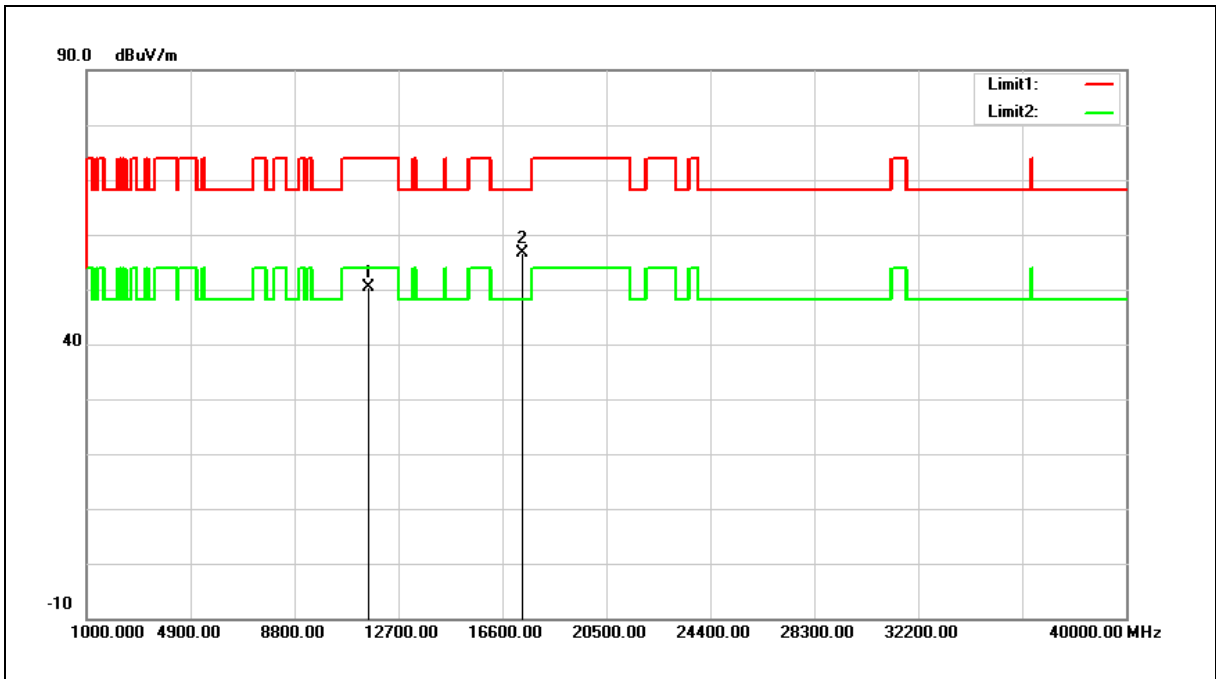

No.	Frequency (MHz)	Reading (dBuV)	Correct Factor (dB/m)	Result (dBuV/m)	Limit (dBuV/m)	Margin (dB)	Remark
1	11570.000	30.90	19.39	50.29	74.00	-23.71	peak
2	17355.000	31.35	25.34	56.69	68.20	-11.51	peak

Note:1.Result (dBuV/m) = Correct Factor (dB/m) + Reading(dBuV).

2.Correction factor (dB/m) = Antenna Factor (dB/m) + Cable loss (dB) – Pre-Amplifier gain (dB).

3.When the peak results are less than average limit, so not need to evaluate the average.

Standard:	FCC Part 15.407	Test Distance:	3m
Test item:	Harmonic		
Frequency:	5785MHz		
Mode:	Mode 6		
Ant.Polar.:	Vertical		

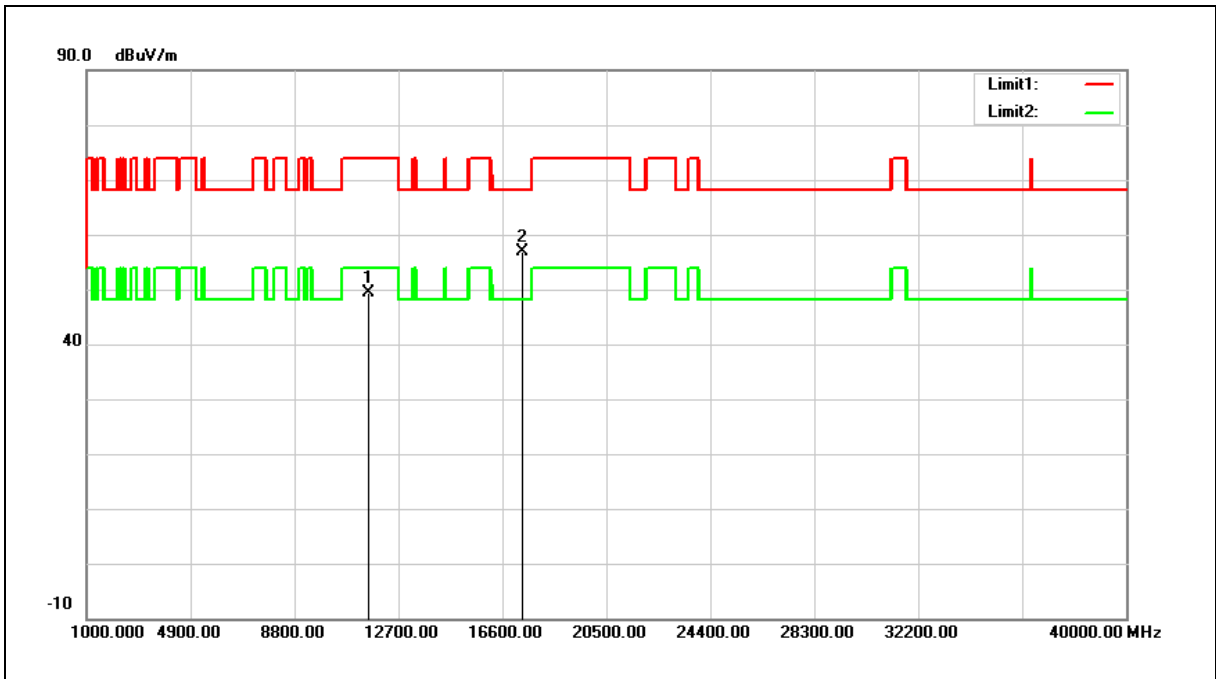

No.	Frequency (MHz)	Reading (dBuV)	Correct Factor (dB/m)	Result (dBuV/m)	Limit (dBuV/m)	Margin (dB)	Remark
1	11570.000	29.92	19.39	49.31	74.00	-24.69	peak
2	17355.000	31.43	25.34	56.77	68.20	-11.43	peak

Note:1.Result (dBuV/m) = Correct Factor (dB/m) + Reading(dBuV).

2.Correction factor (dB/m) = Antenna Factor (dB/m) + Cable loss (dB) – Pre-Amplifier gain (dB).

3.When the peak results are less than average limit, so not need to evaluate the average.



Standard:	FCC Part 15.407	Test Distance:	3m
Test item:	Harmonic		
Frequency:	5825MHz		
Mode:	Mode 6		
Ant.Polar.:	Horizontal		

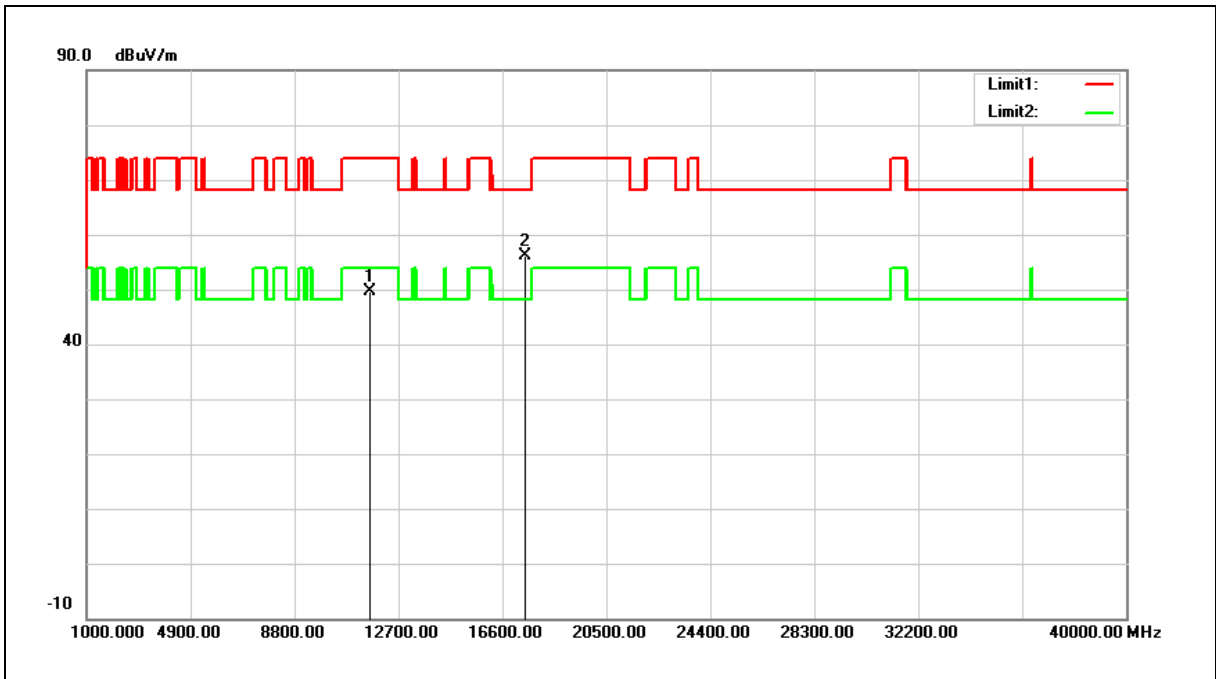

No.	Frequency (MHz)	Reading (dBuV)	Correct Factor (dB/m)	Result (dBuV/m)	Limit (dBuV/m)	Margin (dB)	Remark
1	11650.000	30.23	19.32	49.55	74.00	-24.45	peak
2	17475.000	30.59	25.65	56.24	68.20	-11.96	peak

Note:1.Result (dBuV/m) = Correct Factor (dB/m) + Reading(dBuV).

2.Correction factor (dB/m) = Antenna Factor (dB/m) + Cable loss (dB) – Pre-Amplifier gain (dB).

3.When the peak results are less than average limit, so not need to evaluate the average.

Standard:	FCC Part 15.407	Test Distance:	3m
Test item:	Harmonic		
Frequency:	5825MHz		
Mode:	Mode 6		
Ant.Polar.:	Vertical		

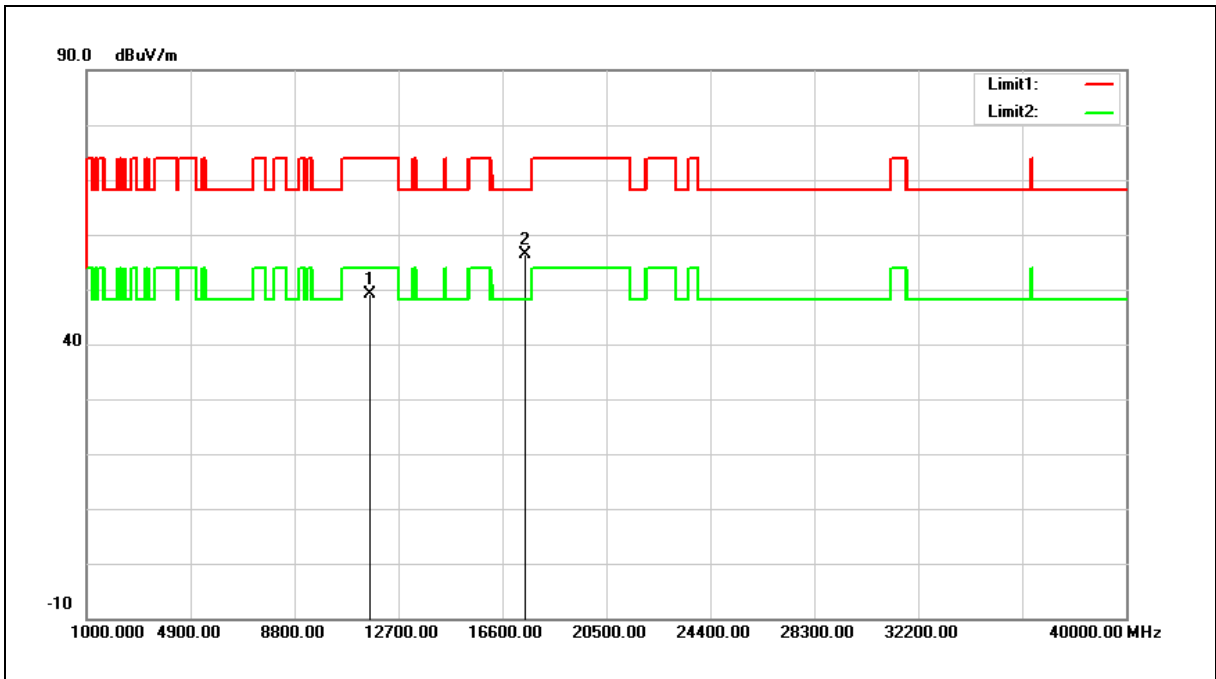

No.	Frequency (MHz)	Reading (dBuV)	Correct Factor (dB/m)	Result (dBuV/m)	Limit (dBuV/m)	Margin (dB)	Remark
1	11650.000	29.93	19.32	49.25	74.00	-24.75	peak
2	17475.000	30.65	25.65	56.30	68.20	-11.90	peak

Note:1.Result (dBuV/m) = Correct Factor (dB/m) + Reading(dBuV).

2.Correction factor (dB/m) = Antenna Factor (dB/m) + Cable loss (dB) – Pre-Amplifier gain (dB).

3.When the peak results are less than average limit, so not need to evaluate the average.



Standard:	FCC Part 15.407	Test Distance:	3m
Test item:	Harmonic		
Frequency:	5190MHz		
Mode:	Mode 7		
Ant.Polar.:	Horizontal		

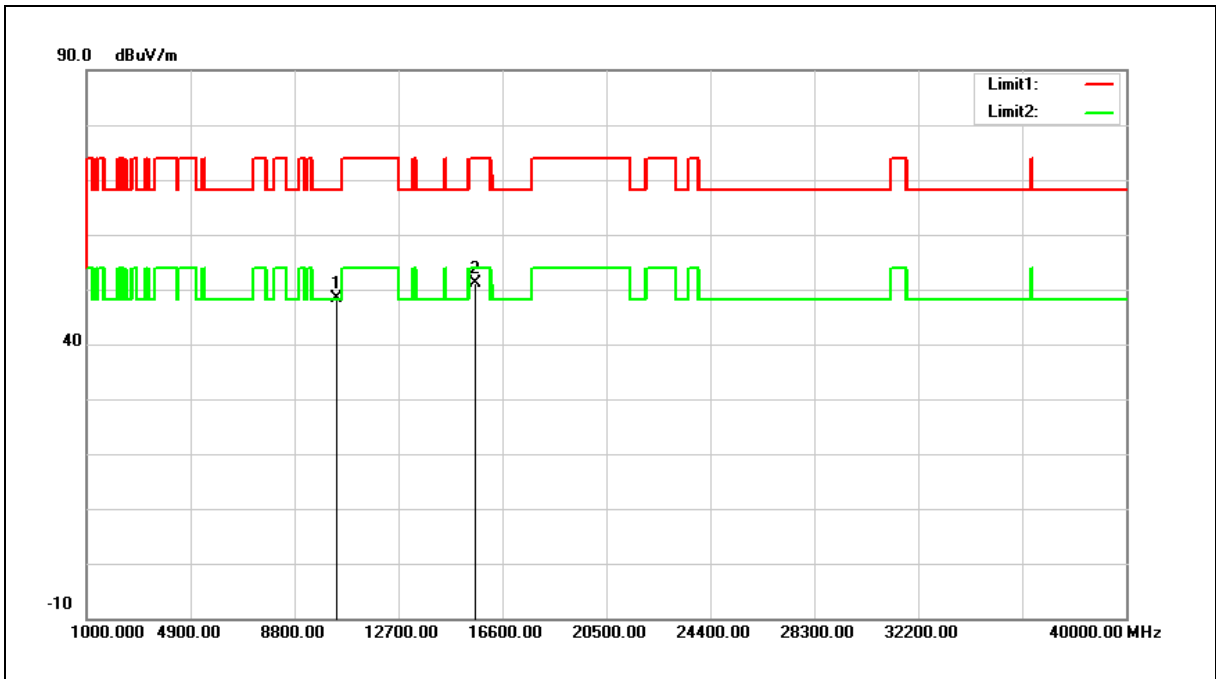

No.	Frequency (MHz)	Reading (dBuV)	Correct Factor (dB/m)	Result (dBuV/m)	Limit (dBuV/m)	Margin (dB)	Remark
1	10380.000	30.93	17.35	48.28	68.20	-19.92	peak
2	15570.000	30.50	20.68	51.18	74.00	-22.82	peak

Note:1.Result (dBuV/m) = Correct Factor (dB/m) + Reading(dBuV).

2.Correction factor (dB/m) = Antenna Factor (dB/m) + Cable loss (dB) – Pre-Amplifier gain (dB).

3.When the peak results are less than average limit, so not need to evaluate the average.



Standard:	FCC Part 15.407	Test Distance:	3m
Test item:	Harmonic		
Frequency:	5190MHz		
Mode:	Mode 7		
Ant.Polar.:	Vertical		

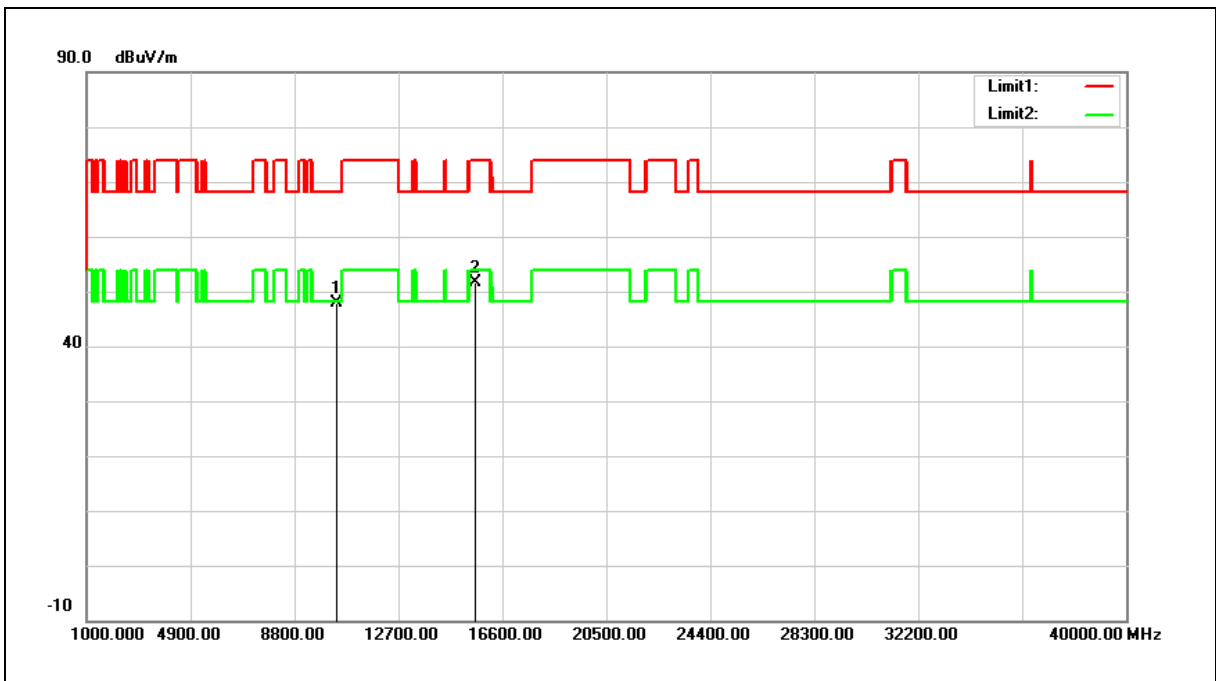

No.	Frequency (MHz)	Reading (dBuV)	Correct Factor (dB/m)	Result (dBuV/m)	Limit (dBuV/m)	Margin (dB)	Remark
1	10380.000	30.44	17.35	47.79	68.20	-20.41	peak
2	15570.000	31.03	20.68	51.71	74.00	-22.29	peak

Note:1.Result (dBuV/m) = Correct Factor (dB/m) + Reading(dBuV).

2.Correction factor (dB/m) = Antenna Factor (dB/m) + Cable loss (dB) – Pre-Amplifier gain (dB).

3.When the peak results are less than average limit, so not need to evaluate the average.



Standard:	FCC Part 15.407	Test Distance:	3m
Test item:	Harmonic		
Frequency:	5230MHz		
Mode:	Mode 7		
Ant.Polar.:	Horizontal		

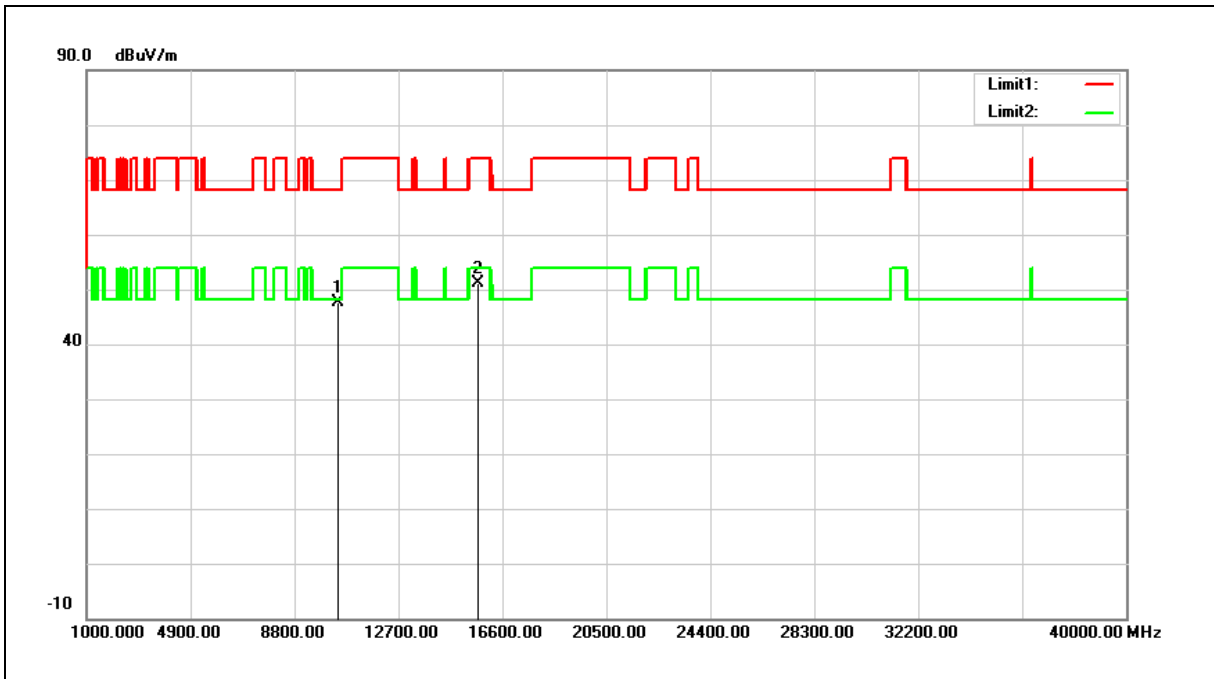

No.	Frequency (MHz)	Reading (dBuV)	Correct Factor (dB/m)	Result (dBuV/m)	Limit (dBuV/m)	Margin (dB)	Remark
1	10460.000	29.98	17.59	47.57	68.20	-20.63	peak
2	15690.000	30.75	20.37	51.12	74.00	-22.88	peak

Note:1.Result (dBuV/m) = Correct Factor (dB/m) + Reading(dBuV).

2.Correction factor (dB/m) = Antenna Factor (dB/m) + Cable loss (dB) – Pre-Amplifier gain (dB).

3.When the peak results are less than average limit, so not need to evaluate the average.



Standard:	FCC Part 15.407	Test Distance:	3m
Test item:	Harmonic		
Frequency:	5230MHz		
Mode:	Mode 7		
Ant.Polar.:	Vertical		

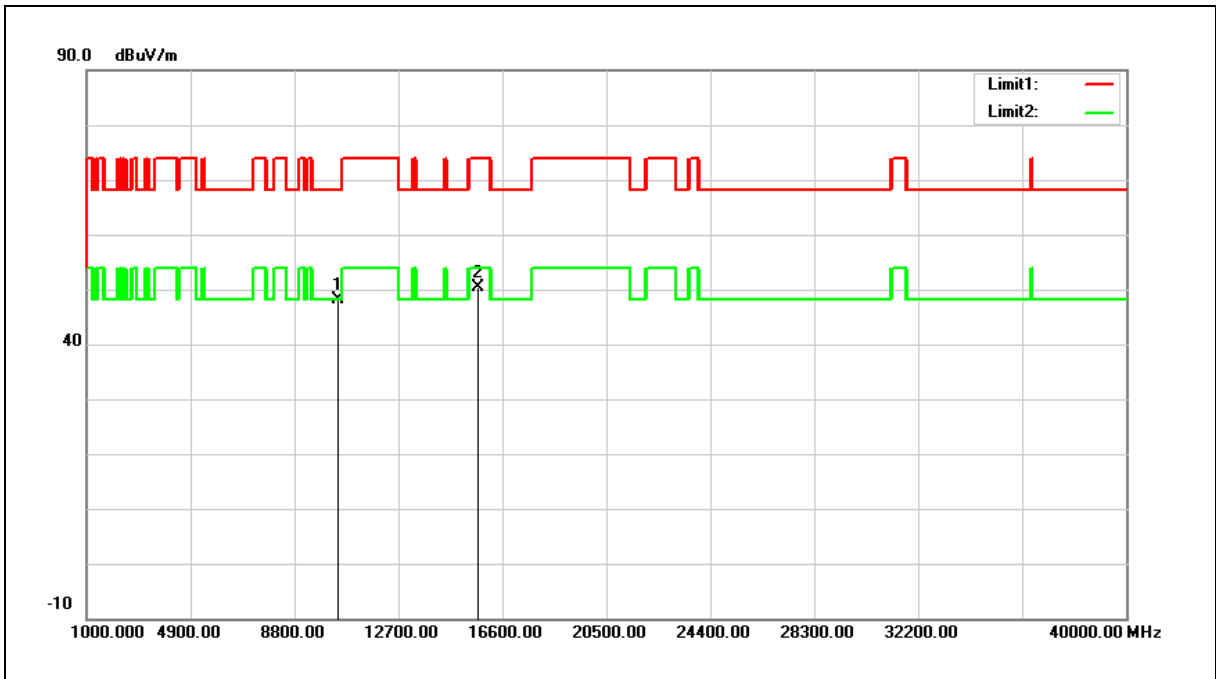

No.	Frequency (MHz)	Reading (dBuV)	Correct Factor (dB/m)	Result (dBuV/m)	Limit (dBuV/m)	Margin (dB)	Remark
1	10460.000	30.64	17.59	48.23	68.20	-19.97	peak
2	15690.000	29.98	20.37	50.35	74.00	-23.65	peak

Note:1.Result (dBuV/m) = Correct Factor (dB/m) + Reading(dBuV).

2.Correction factor (dB/m) = Antenna Factor (dB/m) + Cable loss (dB) – Pre-Amplifier gain (dB).

3.When the peak results are less than average limit, so not need to evaluate the average.



Standard:	FCC Part 15.407	Test Distance:	3m
Test item:	Harmonic		
Frequency:	5755MHz		
Mode:	Mode 7		
Ant.Polar.:	Horizontal		

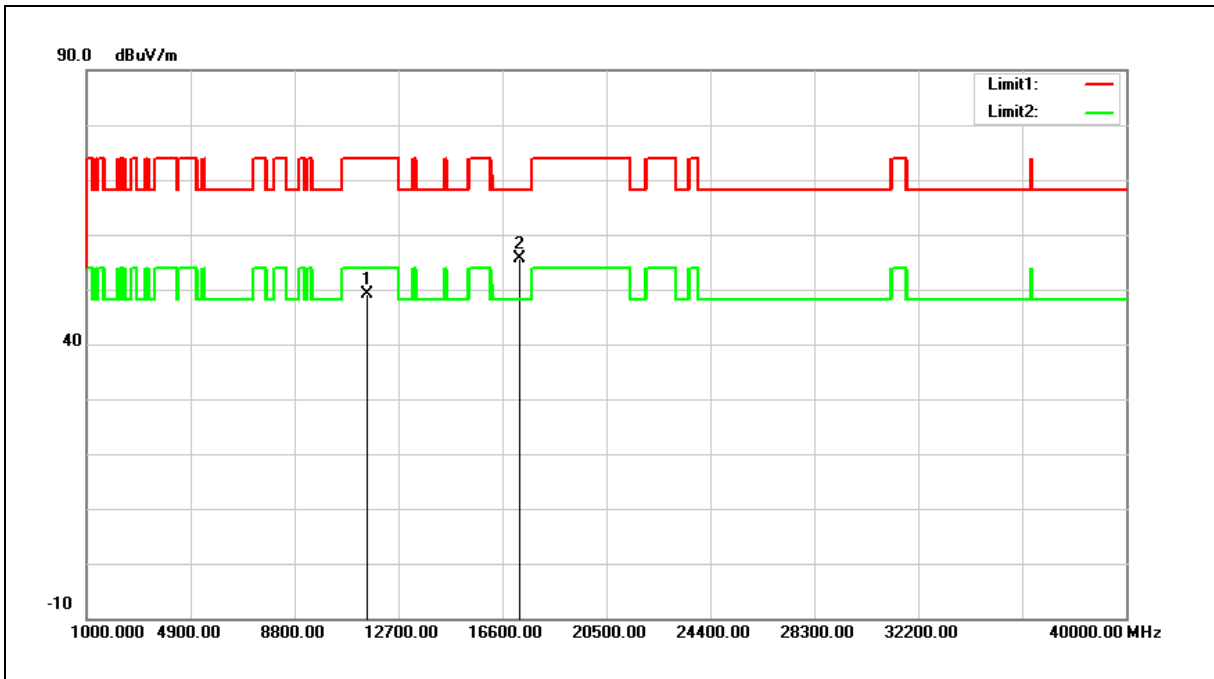

No.	Frequency (MHz)	Reading (dBuV)	Correct Factor (dB/m)	Result (dBuV/m)	Limit (dBuV/m)	Margin (dB)	Remark
1	11510.000	29.62	19.46	49.08	74.00	-24.92	peak
2	17265.000	30.50	25.09	55.59	68.20	-12.61	peak

Note:1.Result (dBuV/m) = Correct Factor (dB/m) + Reading(dBuV).

2.Correction factor (dB/m) = Antenna Factor (dB/m) + Cable loss (dB) – Pre-Amplifier gain (dB).

3.When the peak results are less than average limit, so not need to evaluate the average.



Standard:	FCC Part 15.407	Test Distance:	3m
Test item:	Harmonic		
Frequency:	5755MHz		
Mode:	Mode 7		
Ant.Polar.:	Vertical		

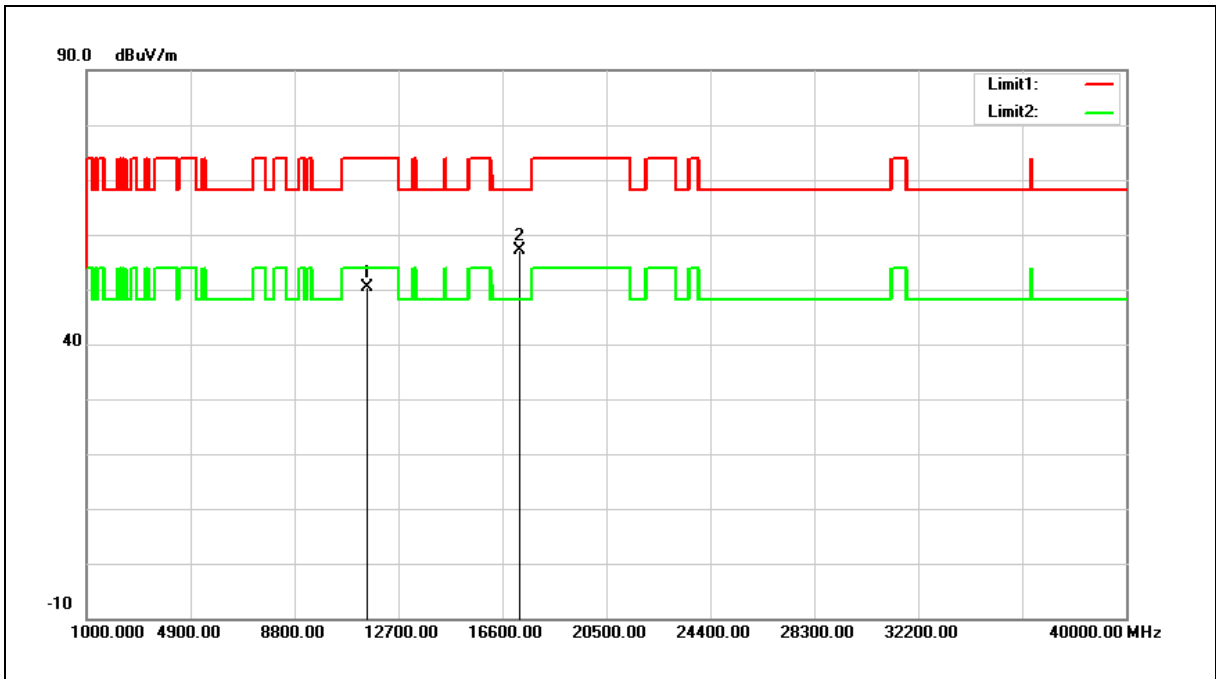

No.	Frequency (MHz)	Reading (dBuV)	Correct Factor (dB/m)	Result (dBuV/m)	Limit (dBuV/m)	Margin (dB)	Remark
1	11510.000	30.88	19.46	50.34	74.00	-23.66	peak
2	17265.000	32.07	25.09	57.16	68.20	-11.04	peak

Note:1.Result (dBuV/m) = Correct Factor (dB/m) + Reading(dBuV).

2.Correction factor (dB/m) = Antenna Factor (dB/m) + Cable loss (dB) – Pre-Amplifier gain (dB).

3.When the peak results are less than average limit, so not need to evaluate the average.



Standard:	FCC Part 15.407	Test Distance:	3m
Test item:	Harmonic		
Frequency:	5795MHz		
Mode:	Mode 7		
Ant.Polar.:	Horizontal		

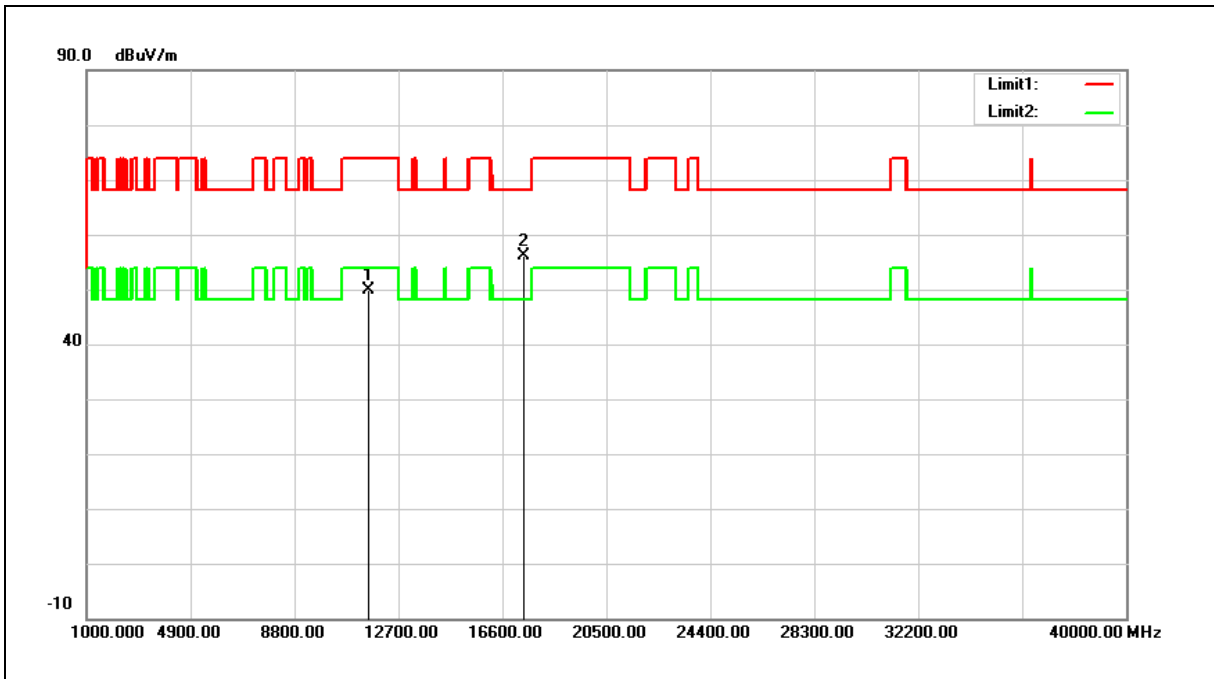

No.	Frequency (MHz)	Reading (dBuV)	Correct Factor (dB/m)	Result (dBuV/m)	Limit (dBuV/m)	Margin (dB)	Remark
1	11590.000	30.38	19.38	49.76	74.00	-24.24	peak
2	17385.000	30.64	25.41	56.05	68.20	-12.15	peak

Note:1.Result (dBuV/m) = Correct Factor (dB/m) + Reading(dBuV).

2.Correction factor (dB/m) = Antenna Factor (dB/m) + Cable loss (dB) – Pre-Amplifier gain (dB).

3.When the peak results are less than average limit, so not need to evaluate the average.



Standard:	FCC Part 15.407	Test Distance:	3m
Test item:	Harmonic		
Frequency:	5795MHz		
Mode:	Mode 7		
Ant.Polar.:	Vertical		

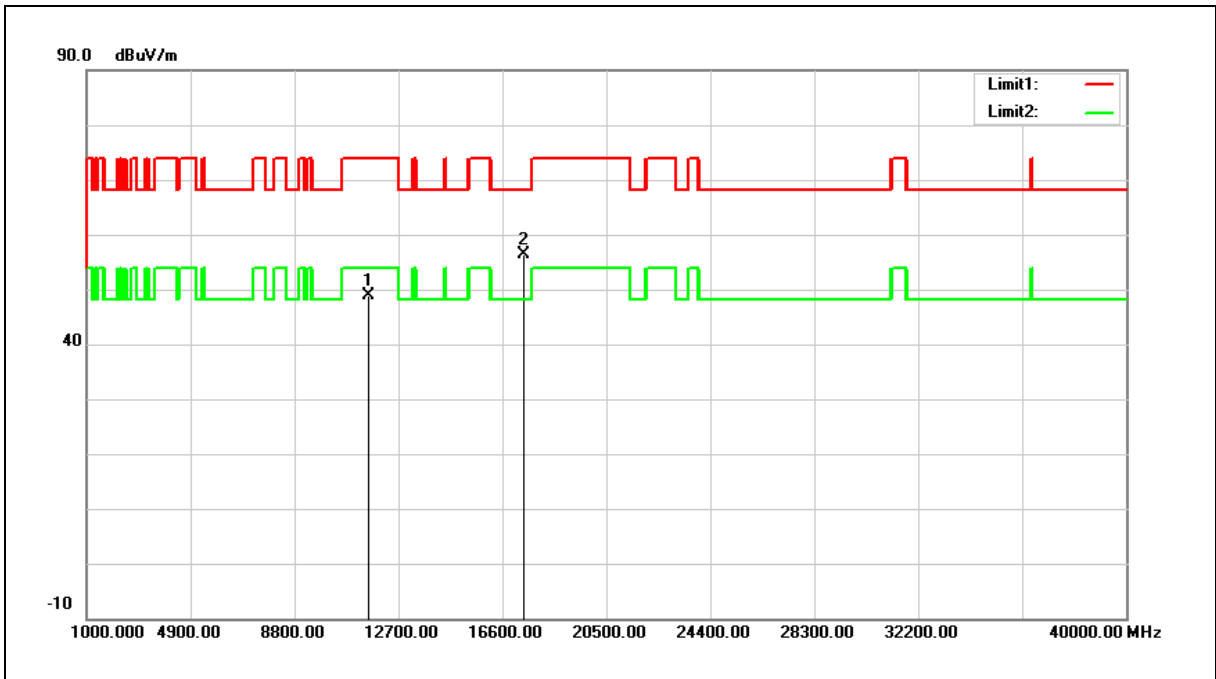

No.	Frequency (MHz)	Reading (dBuV)	Correct Factor (dB/m)	Result (dBuV/m)	Limit (dBuV/m)	Margin (dB)	Remark
1	11590.000	29.49	19.38	48.87	74.00	-25.13	peak
2	17385.000	31.04	25.41	56.45	68.20	-11.75	peak

Note:1.Result (dBuV/m) = Correct Factor (dB/m) + Reading(dBuV).

2.Correction factor (dB/m) = Antenna Factor (dB/m) + Cable loss (dB) – Pre-Amplifier gain (dB).

3.When the peak results are less than average limit, so not need to evaluate the average.



Standard:	FCC Part 15.407	Test Distance:	3m
Test item:	Harmonic		
Frequency:	5210MHz		
Mode:	Mode 8		
Ant.Polar.:	Horizontal		

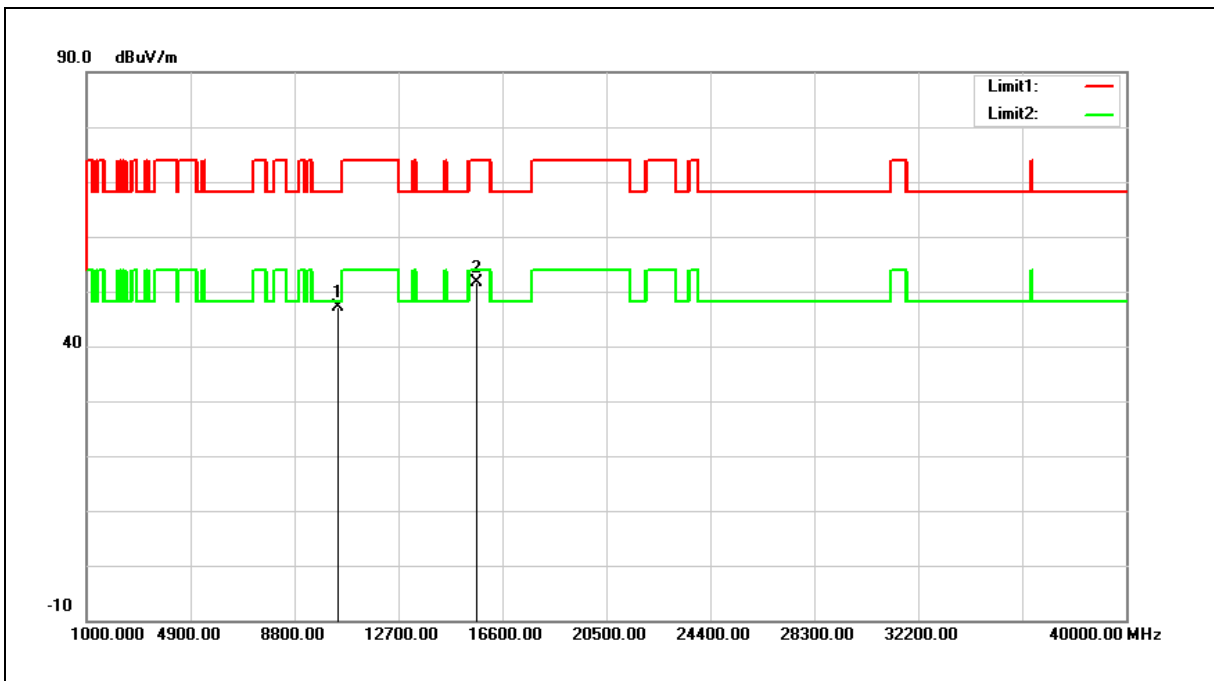

No.	Frequency (MHz)	Reading (dBuV)	Correct Factor (dB/m)	Result (dBuV/m)	Limit (dBuV/m)	Margin (dB)	Remark
1	10420.000	29.62	17.46	47.08	68.20	-21.12	peak
2	15630.000	31.19	20.53	51.72	74.00	-22.28	peak

Note:1.Result (dBuV/m) = Correct Factor (dB/m) + Reading(dBuV).

2.Correction factor (dB/m) = Antenna Factor (dB/m) + Cable loss (dB) – Pre-Amplifier gain (dB).

3.When the peak results are less than average limit, so not need to evaluate the average.



Standard:	FCC Part 15.407	Test Distance:	3m
Test item:	Harmonic		
Frequency:	5210MHz		
Mode:	Mode 8		
Ant.Polar.:	Vertical		

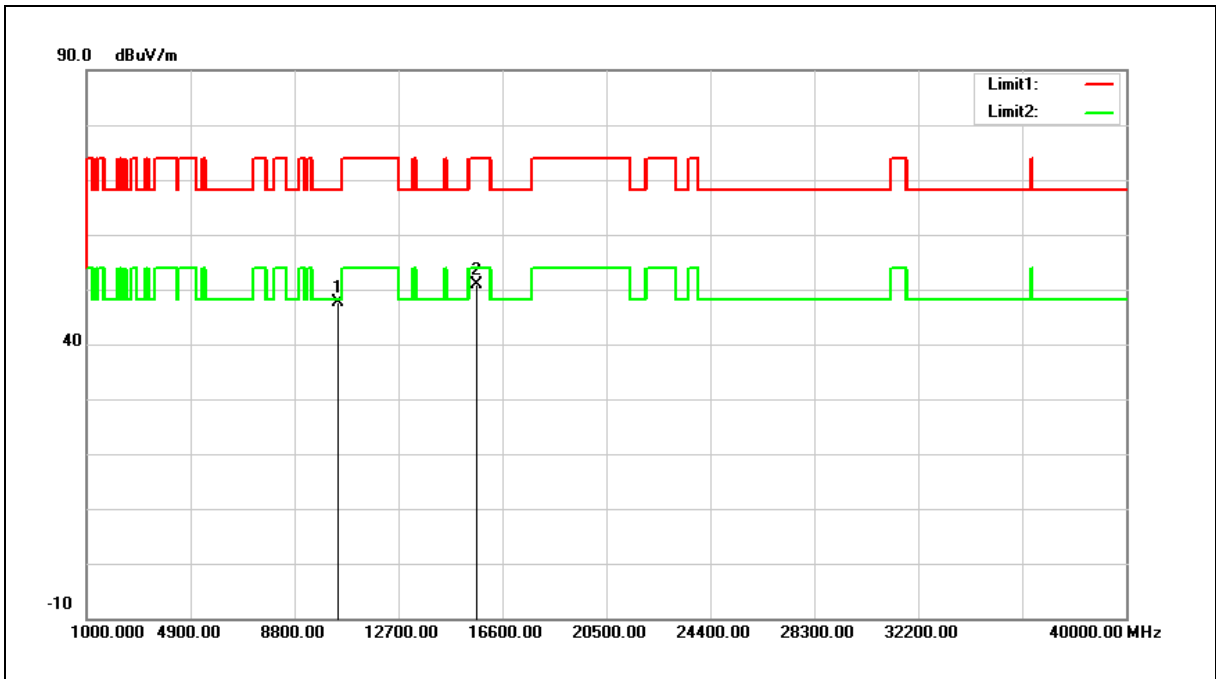

No.	Frequency (MHz)	Reading (dBuV)	Correct Factor (dB/m)	Result (dBuV/m)	Limit (dBuV/m)	Margin (dB)	Remark
1	10420.000	30.08	17.46	47.54	68.20	-20.66	peak
2	15630.000	30.44	20.53	50.97	74.00	-23.03	peak

Note:1.Result (dBuV/m) = Correct Factor (dB/m) + Reading(dBuV).

2.Correction factor (dB/m) = Antenna Factor (dB/m) + Cable loss (dB) – Pre-Amplifier gain (dB).

3.When the peak results are less than average limit, so not need to evaluate the average.



Standard:	FCC Part 15.407	Test Distance:	3m
Test item:	Harmonic		
Frequency:	5775MHz		
Mode:	Mode 8		
Ant.Polar.:	Horizontal		

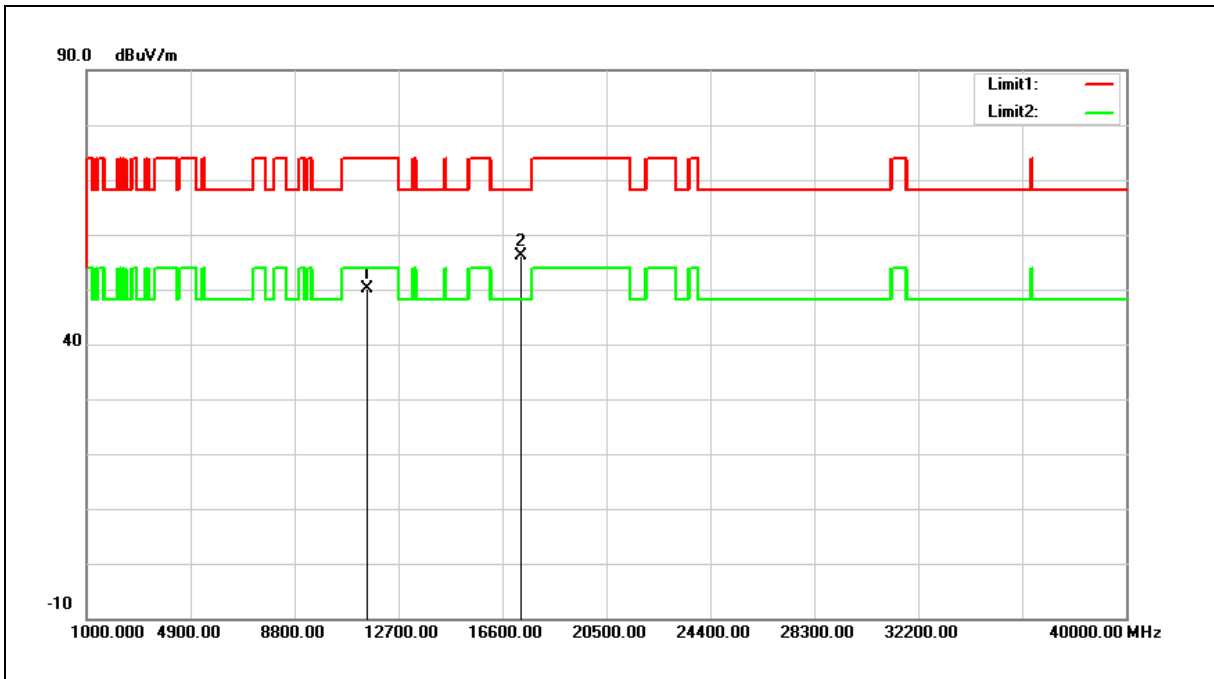

No.	Frequency (MHz)	Reading (dBuV)	Correct Factor (dB/m)	Result (dBuV/m)	Limit (dBuV/m)	Margin (dB)	Remark
1	11550.000	30.81	19.42	50.23	74.00	-23.77	peak
2	17325.000	30.84	25.25	56.09	68.20	-12.11	peak

Note:1.Result (dBuV/m) = Correct Factor (dB/m) + Reading(dBuV).

2.Correction factor (dB/m) = Antenna Factor (dB/m) + Cable loss (dB) – Pre-Amplifier gain (dB).

3.When the peak results are less than average limit, so not need to evaluate the average.



Standard:	FCC Part 15.407	Test Distance:	3m
Test item:	Harmonic		
Frequency:	5775MHz		
Mode:	Mode 8		
Ant.Polar.:	Vertical		

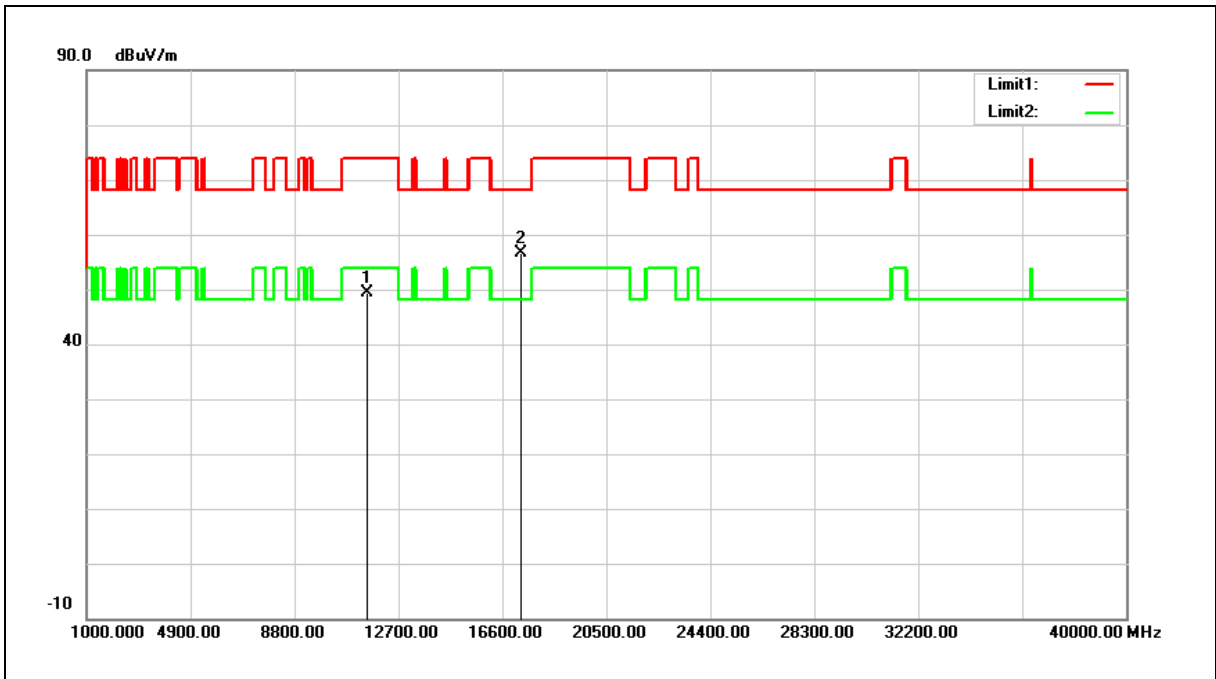

No.	Frequency (MHz)	Reading (dBuV)	Correct Factor (dB/m)	Result (dBuV/m)	Limit (dBuV/m)	Margin (dB)	Remark
1	11550.000	29.85	19.42	49.27	74.00	-24.73	peak
2	17325.000	31.29	25.25	56.54	68.20	-11.66	peak

Note:1.Result (dBuV/m) = Correct Factor (dB/m) + Reading(dBuV).

2.Correction factor (dB/m) = Antenna Factor (dB/m) + Cable loss (dB) – Pre-Amplifier gain (dB).

3.When the peak results are less than average limit, so not need to evaluate the average.

Standard:	FCC Part 15.407	Test Distance:	3 m
Test item:	Harmonic		
Mode:	Simultaneous Transmitting (WLAN 5 GHz+ WLAN 2.4 GHz)		
Ant.Polar.:	Horizontal		

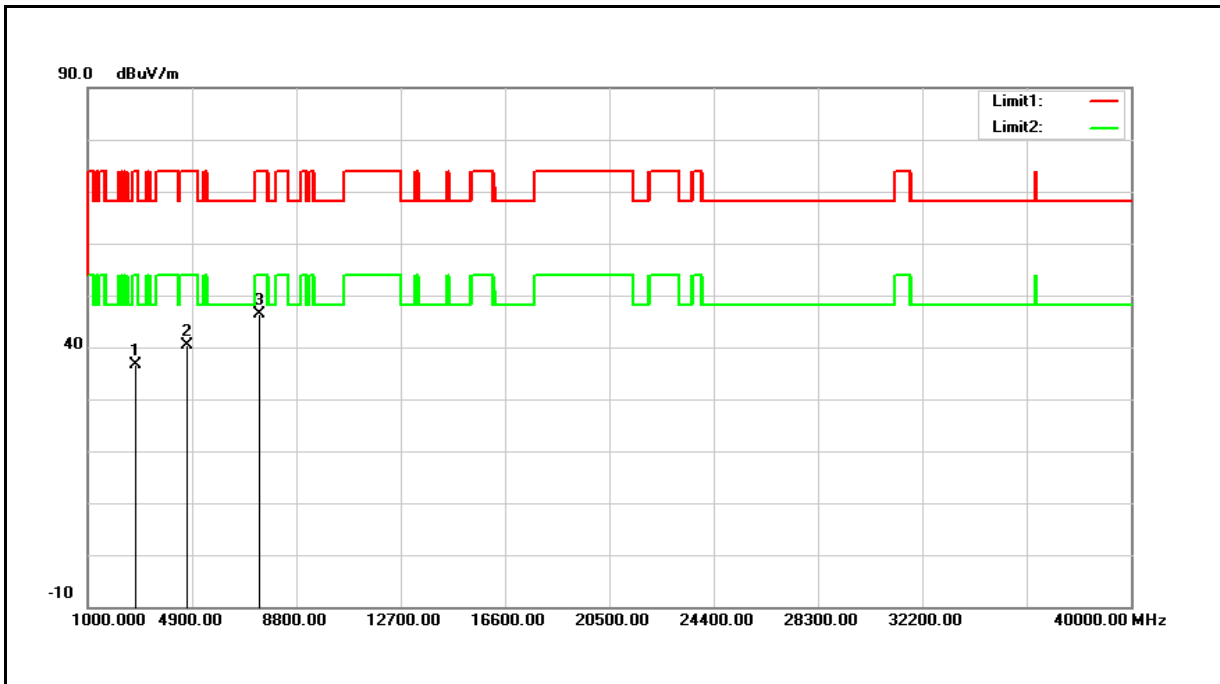

No.	Frequency (MHz)	Reading (dBuV)	Correct Factor (dB/m)	Result (dBuV/m)	Limit (dBuV/m)	Margin (dB)	Remark
1	2802.000	35.95	0.56	36.51	74.00	-37.49	peak
2	4689.000	34.93	5.56	40.49	74.00	-33.51	peak
3	7443.000	33.20	13.18	46.38	74.00	-27.62	peak

Note:1.Result (dBuV/m) = Correct Factor (dB/m) + Reading(dBuV).

2.Correction factor (dB/m) = Antenna Factor (dB/m) + Cable loss (dB) – Pre-Amplifier gain (dB).

3.When the peak results are less than average limit, so not need to evaluate the average.

Standard:	FCC Part 15.407	Test Distance:	3 m
Test item:	Harmonic		
Mode:	Simultaneous Transmitting (WLAN 5 GHz+ WLAN 2.4 GHz)		
Ant.Polar.:	Vertical		

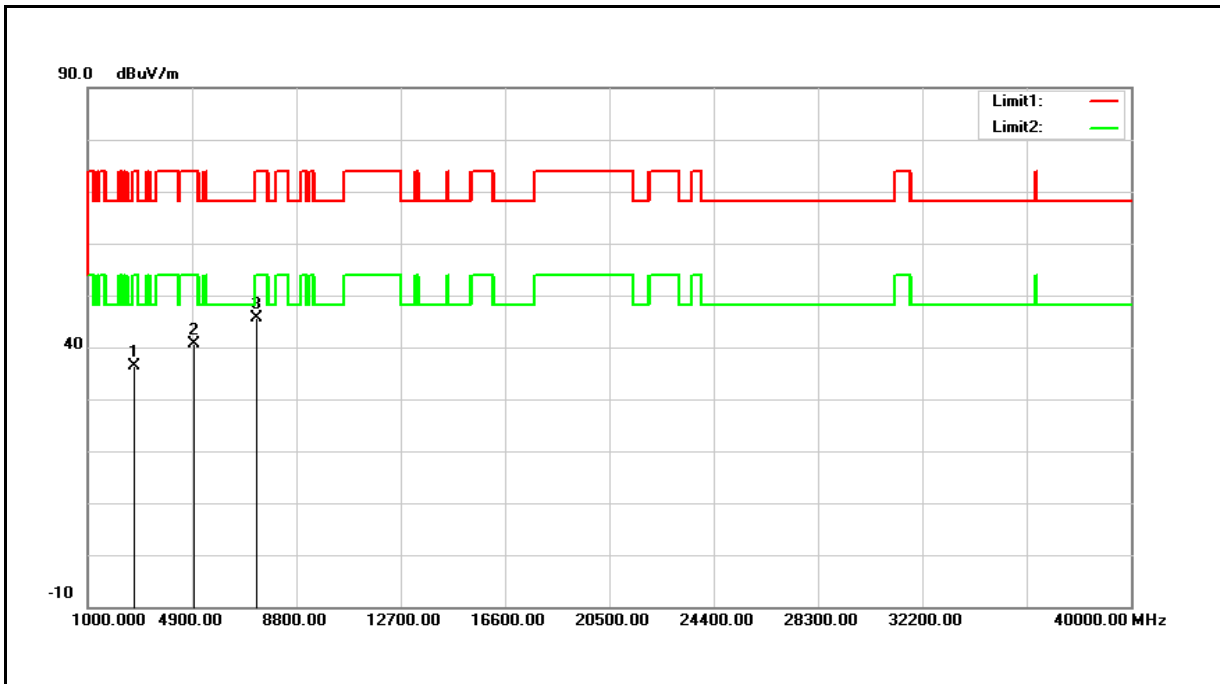

No.	Frequency (MHz)	Reading (dBuV)	Correct Factor (dB/m)	Result (dBuV/m)	Limit (dBuV/m)	Margin (dB)	Remark
1	2751.000	35.89	0.42	36.31	74.00	-37.69	peak
2	4961.000	34.28	6.38	40.66	74.00	-33.34	peak
3	7341.000	32.77	12.84	45.61	74.00	-28.39	peak

Note:1.Result (dBuV/m) = Correct Factor (dB/m) + Reading(dBuV).

2.Correction factor (dB/m) = Antenna Factor (dB/m) + Cable loss (dB) – Pre-Amplifier gain (dB).

3.When the peak results are less than average limit, so not need to evaluate the average.



Band Edge

Standard:	FCC Part 15.407	Test Distance:	3m
Test item:	Band edge		
Frequency:	5180MHz		
Mode:	Mode 2		
Ant.Polar.:	Horizontal		

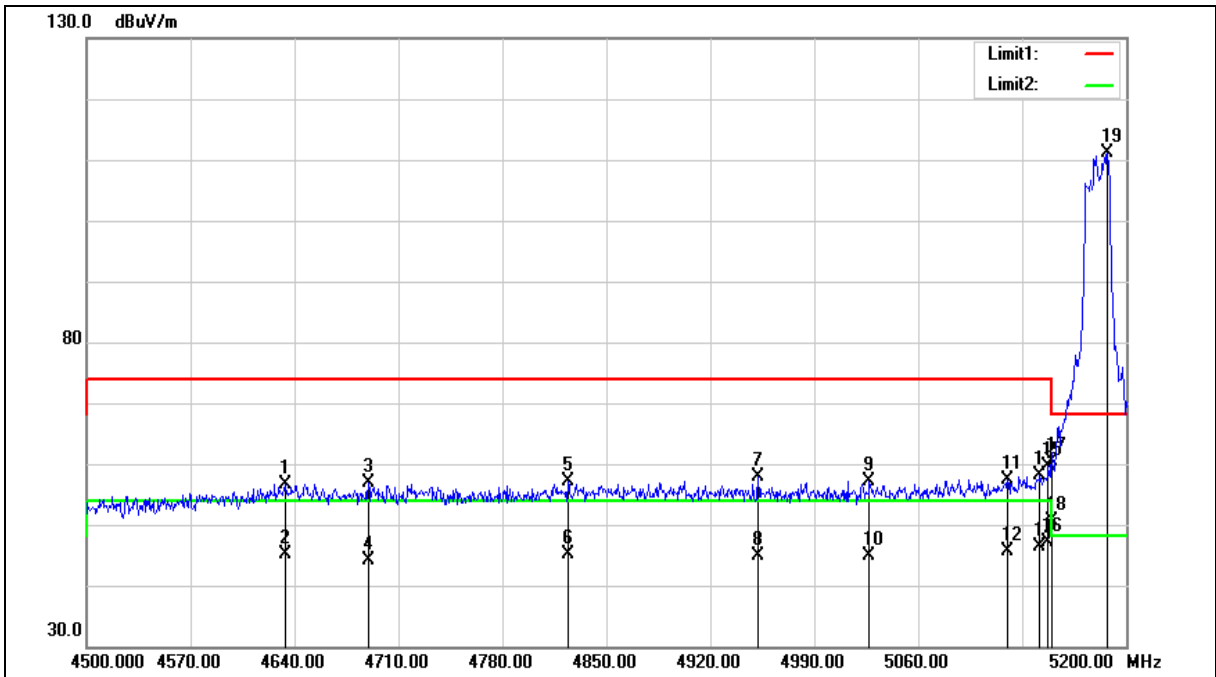



Standard:	FCC Part 15.407	Test Distance:	3m
Test item:	Band edge		
Frequency:	5180MHz		
Mode:	Mode 2		
Ant.Polar.:	Horizontal		

No.	Frequency (MHz)	Reading (dBuV)	Correct Factor (dB/m)	Result (dBuV/m)	Limit (dBuV/m)	Margin (dB)	Remark
1	4633.700	51.14	5.38	56.52	74.00	-17.48	peak
2	4633.700	39.73	5.38	45.11	54.00	-8.89	AVG
3	4689.700	51.31	5.56	56.87	74.00	-17.13	peak
4	4689.700	38.64	5.56	44.20	54.00	-9.80	AVG
5	4824.100	51.14	5.97	57.11	74.00	-16.89	peak
6	4824.100	39.04	5.97	45.01	54.00	-8.99	AVG
7	4952.200	51.59	6.36	57.95	74.00	-16.05	peak
8	4952.200	38.55	6.36	44.91	54.00	-9.09	AVG
9	5027.100	50.50	6.59	57.09	74.00	-16.91	peak
10	5027.100	38.18	6.59	44.77	54.00	-9.23	AVG
11	5120.200	50.52	6.85	57.37	74.00	-16.63	peak
12	5120.200	38.85	6.85	45.70	54.00	-8.30	AVG
13	5141.900	51.10	6.92	58.02	74.00	-15.98	peak
14	5141.900	39.41	6.92	46.33	54.00	-7.67	AVG
15	5147.500	52.58	6.94	59.52	74.00	-14.48	peak
16	5147.500	40.21	6.94	47.15	54.00	-6.85	AVG
17	5150.000	53.39	6.94	60.33	74.00	-13.67	peak
18	5150.000	43.75	6.94	50.69	54.00	-3.31	AVG
19	5187.400	104.12	7.05	111.17	--	--	peak

Note:1.Result (dBuV/m) = Correct Factor (dB/m) + Reading(dBuV).

2.Correction factor (dB/m) = Antenna Factor (dB/m) + Cable loss (dB) – Pre-Amplifier gain (dB).

3.When the peak results are less than average limit, so not need to evaluate the average.



Standard:	FCC Part 15.407	Test Distance:	3m
Test item:	Band edge		
Frequency:	5180MHz		
Mode:	Mode 2		
Ant.Polar.:	Vertical		

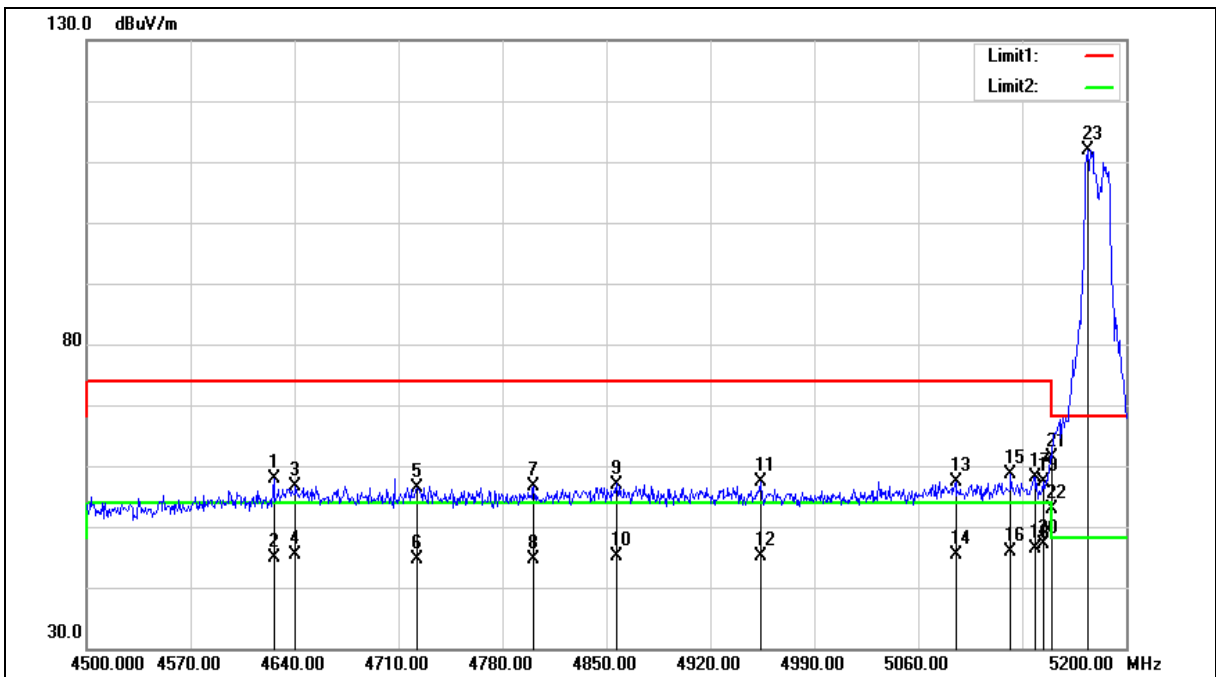



Standard:	FCC Part 15.407	Test Distance:	3m
Test item:	Band edge		
Frequency:	5180MHz		
Mode:	Mode 2		
Ant.Polar.:	Vertical		

No.	Frequency (MHz)	Reading (dBuV)	Correct Factor (dB/m)	Result (dBuV/m)	Limit (dBuV/m)	Margin (dB)	Remark
1	4626.000	52.39	5.37	57.76	74.00	-16.24	peak
2	4626.000	39.58	5.37	44.95	54.00	-9.05	AVG
3	4640.700	51.20	5.41	56.61	74.00	-17.39	peak
4	4640.700	39.91	5.41	45.32	54.00	-8.68	AVG
5	4722.600	50.76	5.67	56.43	74.00	-17.57	peak
6	4722.600	39.04	5.67	44.71	54.00	-9.29	AVG
7	4801.000	50.71	5.90	56.61	74.00	-17.39	peak
8	4801.000	38.74	5.90	44.64	54.00	-9.36	AVG
9	4857.000	50.92	6.08	57.00	74.00	-17.00	peak
10	4857.000	39.04	6.08	45.12	54.00	-8.88	AVG
11	4953.600	50.91	6.37	57.28	74.00	-16.72	peak
12	4953.600	38.66	6.37	45.03	54.00	-8.97	AVG
13	5085.200	50.75	6.75	57.50	74.00	-16.50	peak
14	5085.200	38.65	6.75	45.40	54.00	-8.60	AVG
15	5122.300	51.82	6.85	58.67	74.00	-15.33	peak
16	5122.300	39.00	6.85	45.85	54.00	-8.15	AVG
17	5138.400	51.23	6.91	58.14	74.00	-15.86	peak
18	5138.400	39.56	6.91	46.47	54.00	-7.53	AVG
19	5144.000	50.56	6.92	57.48	74.00	-16.52	peak
20	5144.000	40.33	6.92	47.25	54.00	-6.75	AVG
21	5150.000	54.44	6.94	61.38	74.00	-12.62	peak
22	5150.000	45.97	6.94	52.91	54.00	-1.09	AVG
23	5174.100	104.76	7.00	111.76	--	--	peak

Note:1.Result (dBuV/m) = Correct Factor (dB/m) + Reading(dBuV).

2.Correction factor (dB/m) = Antenna Factor (dB/m) + Cable loss (dB) – Pre-Amplifier gain (dB).

3.When the peak results are less than average limit, so not need to evaluate the average.



Standard:	FCC Part 15.407	Test Distance:	3m
Test item:	Band edge		
Frequency:	5200MHz		
Mode:	Mode 2		
Ant.Polar.:	Horizontal		

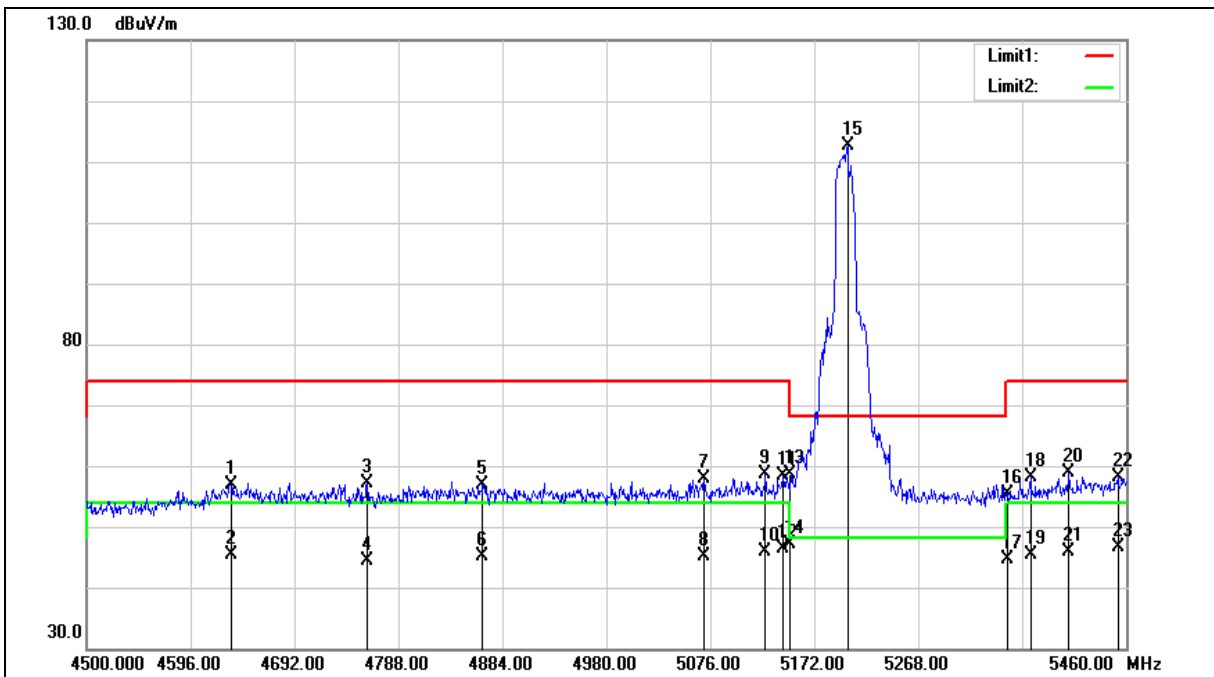



Standard:	FCC Part 15.407	Test Distance:	3m
Test item:	Band edge		
Frequency:	5200MHz		
Mode:	Mode 2		
Ant.Polar.:	Horizontal		

No.	Frequency (MHz)	Reading (dBuV)	Correct Factor (dB/m)	Result (dBuV/m)	Limit (dBuV/m)	Margin (dB)	Remark
1	4633.440	51.43	5.38	56.81	74.00	-17.19	peak
2	4633.440	39.98	5.38	45.36	54.00	-8.64	AVG
3	4759.200	51.24	5.77	57.01	74.00	-16.99	peak
4	4759.200	38.50	5.77	44.27	54.00	-9.73	AVG
5	4865.760	50.77	6.10	56.87	74.00	-17.13	peak
6	4865.760	39.01	6.10	45.11	54.00	-8.89	AVG
7	5070.240	51.11	6.71	57.82	74.00	-16.18	peak
8	5070.240	38.38	6.71	45.09	54.00	-8.91	AVG
9	5126.880	51.65	6.88	58.53	74.00	-15.47	peak
10	5126.880	38.99	6.88	45.87	54.00	-8.13	AVG
11	5143.200	51.36	6.92	58.28	74.00	-15.72	peak
12	5143.200	39.39	6.92	46.31	54.00	-7.69	AVG
13	5150.000	51.78	6.94	58.72	74.00	-15.28	peak
14	5150.000	40.22	6.94	47.16	54.00	-6.84	AVG
15	5202.720	105.50	7.08	112.58	--	--	peak
16	5350.000	47.76	7.50	55.26	74.00	-18.74	peak
17	5350.000	37.25	7.50	44.75	54.00	-9.25	AVG
18	5371.680	50.59	7.56	58.15	74.00	-15.85	peak
19	5371.680	37.80	7.56	45.36	54.00	-8.64	AVG
20	5407.200	51.13	7.67	58.80	74.00	-15.20	peak
21	5407.200	38.30	7.67	45.97	54.00	-8.03	AVG
22	5452.320	50.34	7.79	58.13	74.00	-15.87	peak
23	5452.320	38.87	7.79	46.66	54.00	-7.34	AVG

Note:1.Result (dBuV/m) = Correct Factor (dB/m) + Reading(dBuV).

2.Correction factor (dB/m) = Antenna Factor (dB/m) + Cable loss (dB) – Pre-Amplifier gain (dB).

3.When the peak results are less than average limit, so not need to evaluate the average.



Standard:	FCC Part 15.407	Test Distance:	3m
Test item:	Band edge		
Frequency:	5200MHz		
Mode:	Mode 2		
Ant.Polar.:	Vertical		

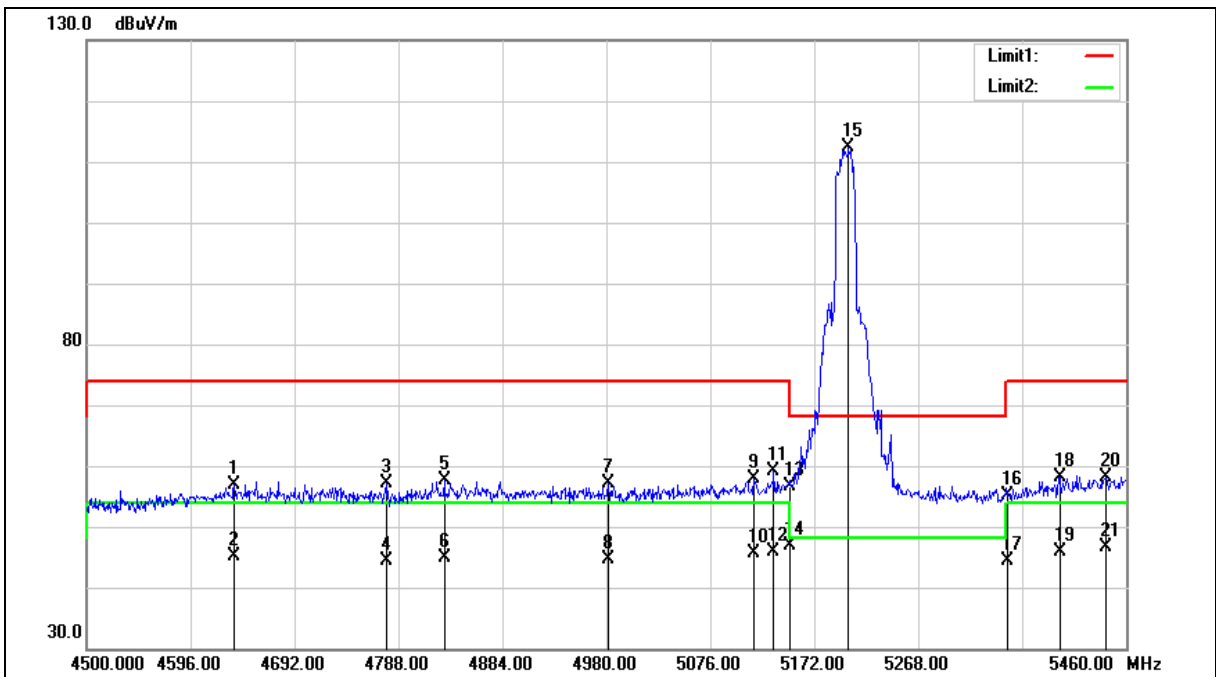



Standard:	FCC Part 15.407	Test Distance:	3m
Test item:	Band edge		
Frequency:	5200MHz		
Mode:	Mode 2		
Ant.Polar.:	Vertical		

No.	Frequency (MHz)	Reading (dBuV)	Correct Factor (dB/m)	Result (dBuV/m)	Limit (dBuV/m)	Margin (dB)	Remark
1	4636.320	51.58	5.40	56.98	74.00	-17.02	peak
2	4636.320	39.74	5.40	45.14	54.00	-8.86	AVG
3	4776.480	51.23	5.82	57.05	74.00	-16.95	peak
4	4776.480	38.46	5.82	44.28	54.00	-9.72	AVG
5	4830.240	51.63	5.99	57.62	74.00	-16.38	peak
6	4830.240	39.01	5.99	45.00	54.00	-9.00	AVG
7	4981.920	50.61	6.46	57.07	74.00	-16.93	peak
8	4981.920	38.23	6.46	44.69	54.00	-9.31	AVG
9	5116.320	50.94	6.84	57.78	74.00	-16.22	peak
10	5116.320	38.82	6.84	45.66	54.00	-8.34	AVG
11	5134.560	52.17	6.89	59.06	74.00	-14.94	peak
12	5134.560	39.09	6.89	45.98	54.00	-8.02	AVG
13	5150.000	49.57	6.94	56.51	74.00	-17.49	peak
14	5150.000	39.86	6.94	46.80	54.00	-7.20	AVG
15	5203.680	105.41	7.09	112.50	--	--	peak
16	5350.000	47.67	7.50	55.17	74.00	-18.83	peak
17	5350.000	36.92	7.50	44.42	54.00	-9.58	AVG
18	5398.560	50.53	7.65	58.18	74.00	-15.82	peak
19	5398.560	38.13	7.65	45.78	54.00	-8.22	AVG
20	5441.760	50.36	7.77	58.13	74.00	-15.87	peak
21	5441.760	38.76	7.77	46.53	54.00	-7.47	AVG

Note:1.Result (dBuV/m) = Correct Factor (dB/m) + Reading(dBuV).

2.Correction factor (dB/m) = Antenna Factor (dB/m) + Cable loss (dB) – Pre-Amplifier gain (dB).

3.When the peak results are less than average limit, so not need to evaluate the average.



Standard:	FCC Part 15.407	Test Distance:	3m
Test item:	Band edge		
Frequency:	5240MHz		
Mode:	Mode 2		
Ant.Polar.:	Horizontal		

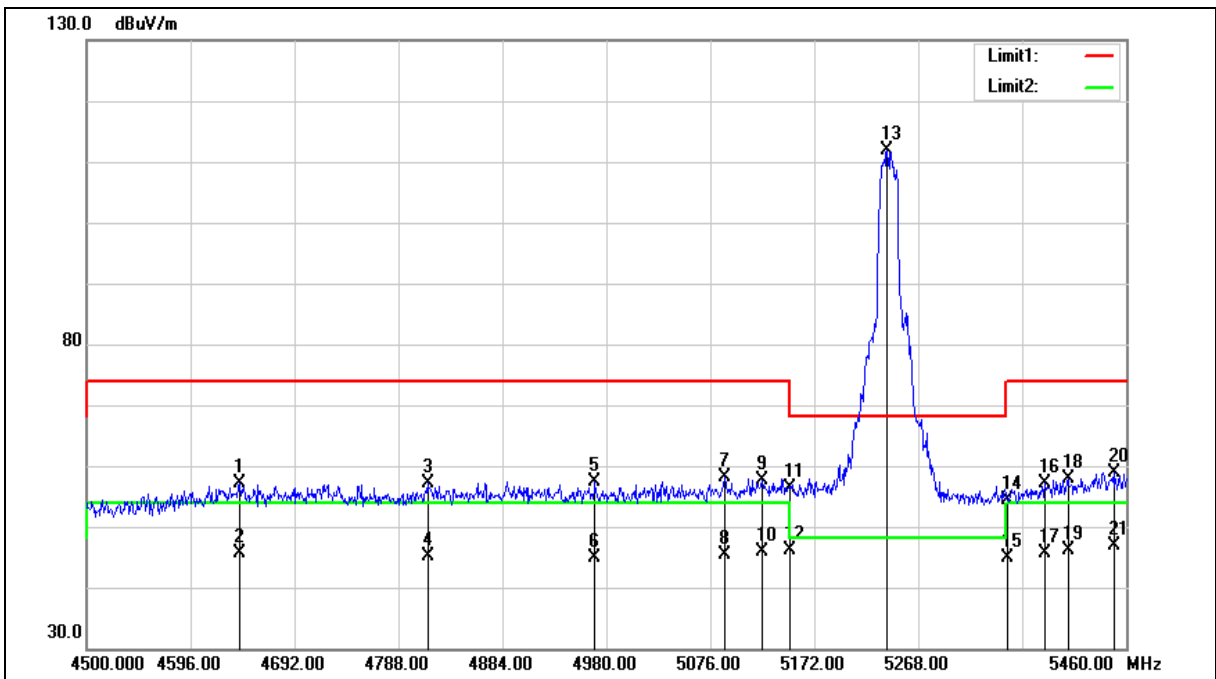



Standard:	FCC Part 15.407	Test Distance:	3m
Test item:	Band edge		
Frequency:	5240MHz		
Mode:	Mode 2		
Ant.Polar.:	Horizontal		

No.	Frequency (MHz)	Reading (dBuV)	Correct Factor (dB/m)	Result (dBuV/m)	Limit (dBuV/m)	Margin (dB)	Remark
1	4641.120	51.60	5.41	57.01	74.00	-16.99	peak
2	4641.120	40.11	5.41	45.52	54.00	-8.48	AVG
3	4814.880	51.08	5.94	57.02	74.00	-16.98	peak
4	4814.880	39.09	5.94	45.03	54.00	-8.97	AVG
5	4969.440	50.91	6.42	57.33	74.00	-16.67	peak
6	4969.440	38.48	6.42	44.90	54.00	-9.10	AVG
7	5089.440	51.38	6.76	58.14	74.00	-15.86	peak
8	5089.440	38.70	6.76	45.46	54.00	-8.54	AVG
9	5124.000	50.76	6.85	57.61	74.00	-16.39	peak
10	5124.000	38.94	6.85	45.79	54.00	-8.21	AVG
11	5150.000	49.43	6.94	56.37	74.00	-17.63	peak
12	5150.000	39.11	6.94	46.05	54.00	-7.95	AVG
13	5239.200	104.62	7.19	111.81	--	--	peak
14	5350.000	47.00	7.50	54.50	74.00	-19.50	peak
15	5350.000	37.30	7.50	44.80	54.00	-9.20	AVG
16	5385.120	49.61	7.61	57.22	74.00	-16.78	peak
17	5385.120	38.00	7.61	45.61	54.00	-8.39	AVG
18	5406.240	50.25	7.67	57.92	74.00	-16.08	peak
19	5406.240	38.49	7.67	46.16	54.00	-7.84	AVG
20	5448.480	51.18	7.79	58.97	74.00	-15.03	peak
21	5448.480	39.05	7.79	46.84	54.00	-7.16	AVG

Note:1.Result (dBuV/m) = Correct Factor (dB/m) + Reading(dBuV).

2.Correction factor (dB/m) = Antenna Factor (dB/m) + Cable loss (dB) – Pre-Amplifier gain (dB).

3.When the peak results are less than average limit, so not need to evaluate the average.



Standard:	FCC Part 15.407	Test Distance:	3m
Test item:	Band edge		
Frequency:	5240MHz		
Mode:	Mode 2		
Ant.Polar.:	Vertical		

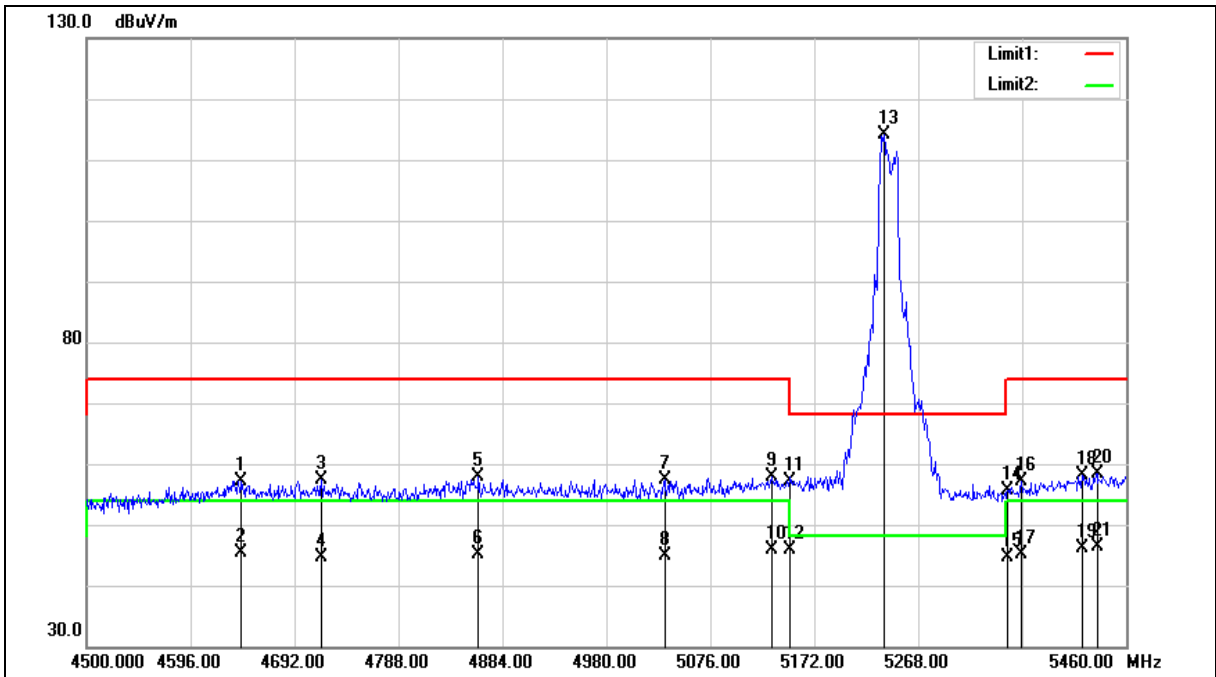



Standard:	FCC Part 15.407	Test Distance:	3m
Test item:	Band edge		
Frequency:	5240MHz		
Mode:	Mode 2		
Ant.Polar.:	Vertical		

No.	Frequency (MHz)	Reading (dBuV)	Correct Factor (dB/m)	Result (dBuV/m)	Limit (dBuV/m)	Margin (dB)	Remark
1	4643.040	51.77	5.41	57.18	74.00	-16.82	peak
2	4643.040	39.99	5.41	45.40	54.00	-8.60	AVG
3	4716.960	51.75	5.64	57.39	74.00	-16.61	peak
4	4716.960	39.07	5.64	44.71	54.00	-9.29	AVG
5	4861.920	51.83	6.09	57.92	74.00	-16.08	peak
6	4861.920	39.09	6.09	45.18	54.00	-8.82	AVG
7	5033.760	50.87	6.60	57.47	74.00	-16.53	peak
8	5033.760	38.34	6.60	44.94	54.00	-9.06	AVG
9	5132.640	50.94	6.89	57.83	74.00	-16.17	peak
10	5132.640	38.97	6.89	45.86	54.00	-8.14	AVG
11	5150.000	50.15	6.94	57.09	74.00	-16.91	peak
12	5150.000	39.02	6.94	45.96	54.00	-8.04	AVG
13	5236.320	106.89	7.19	114.08	--	--	peak
14	5350.000	48.08	7.50	55.58	74.00	-18.42	peak
15	5350.000	37.22	7.50	44.72	54.00	-9.28	AVG
16	5363.040	49.69	7.53	57.22	74.00	-16.78	peak
17	5363.040	37.48	7.53	45.01	54.00	-8.99	AVG
18	5419.680	50.51	7.71	58.22	74.00	-15.78	peak
19	5419.680	38.47	7.71	46.18	54.00	-7.82	AVG
20	5433.120	50.66	7.74	58.40	74.00	-15.60	peak
21	5433.120	38.66	7.74	46.40	54.00	-7.60	AVG

Note:1.Result (dBuV/m) = Correct Factor (dB/m) + Reading(dBuV).

2.Correction factor (dB/m) = Antenna Factor (dB/m) + Cable loss (dB) – Pre-Amplifier gain (dB).

3.When the peak results are less than average limit, so not need to evaluate the average.



Standard:	FCC Part 15.407	Test Distance:	3m
Test item:	Band edge		
Frequency:	5745MHz		
Mode:	Mode 2		
Ant.Polar.:	Horizontal		

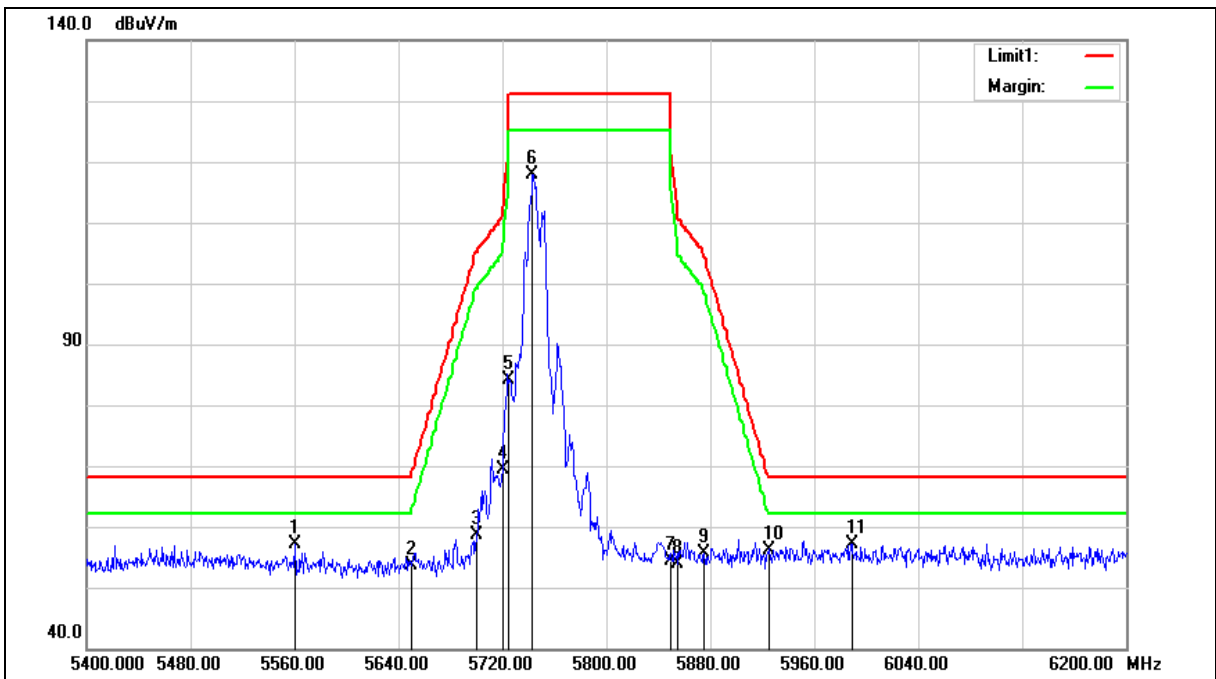



Standard:	FCC Part 15.407	Test Distance:	3m
Test item:	Band edge		
Frequency:	5745MHz		
Mode:	Mode 2		
Ant.Polar.:	Horizontal		

No.	Frequency (MHz)	Reading (dBuV)	Correct Factor (dB/m)	Result (dBuV/m)	Limit (dBuV/m)	Margin (dB)	Remark
1	5560.000	51.03	6.14	57.17	68.20	-11.03	peak
2	5650.000	47.28	6.31	53.59	68.20	-14.61	peak
3	5700.000	52.32	6.40	58.72	105.20	-46.48	peak
4	5720.000	62.94	6.44	69.38	110.80	-41.42	peak
5	5725.000	77.78	6.45	84.23	122.20	-37.97	peak
6	5743.200	111.48	6.47	117.95	--	--	peak
7	5850.000	47.70	6.67	54.37	122.20	-67.83	peak
8	5855.000	47.15	6.67	53.82	110.80	-56.98	peak
9	5875.000	48.91	6.72	55.63	105.20	-49.57	peak
10	5925.000	49.29	6.80	56.09	68.20	-12.11	peak
11	5988.800	50.22	6.92	57.14	68.20	-11.06	peak

Note:1.Result (dBuV/m) = Correct Factor (dB/m) + Reading(dBuV).

2.Correction factor (dB/m) = Antenna Factor (dB/m) + Cable loss (dB) – Pre-Amplifier gain (dB).

3.When the peak results are less than average limit, so not need to evaluate the average.



Standard:	FCC Part 15.407	Test Distance:	3m
Test item:	Band edge		
Frequency:	5745MHz		
Mode:	Mode 2		
Ant.Polar.:	Vertical		

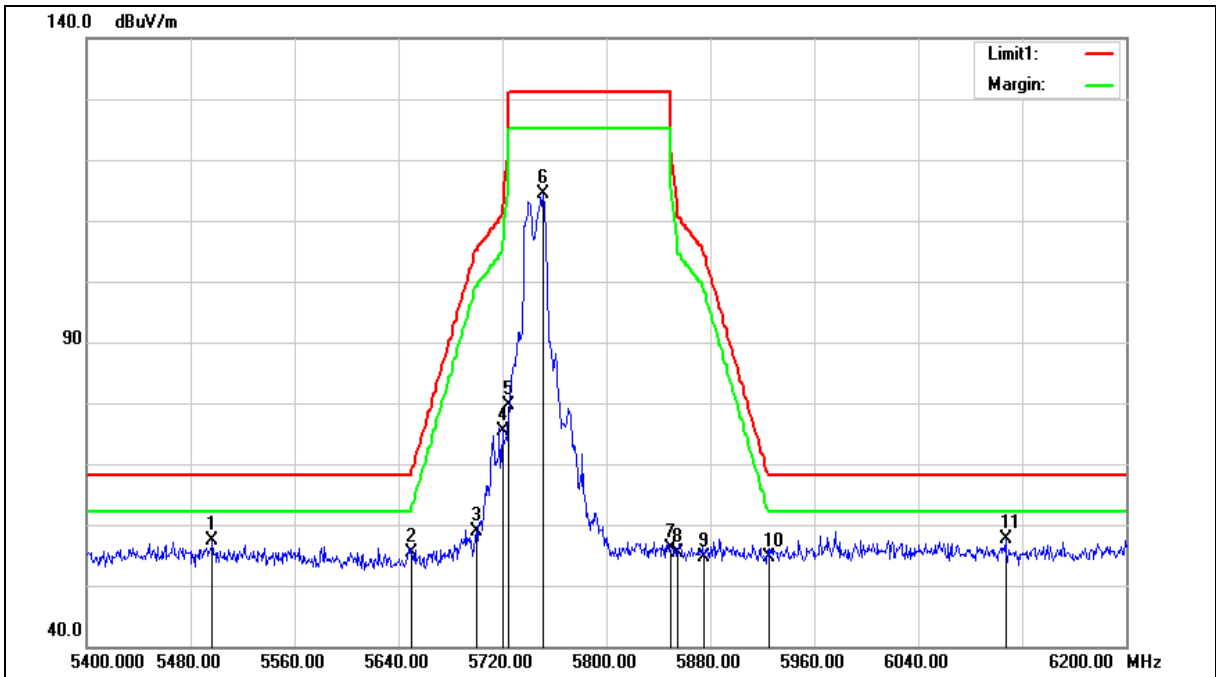



Standard:	FCC Part 15.407	Test Distance:	3m
Test item:	Band edge		
Frequency:	5745MHz		
Mode:	Mode 2		
Ant.Polar.:	Vertical		

No.	Frequency (MHz)	Reading (dBuV)	Correct Factor (dB/m)	Result (dBuV/m)	Limit (dBuV/m)	Margin (dB)	Remark
1	5496.800	51.29	6.03	57.32	68.20	-10.88	peak
2	5650.000	48.95	6.31	55.26	68.20	-12.94	peak
3	5700.000	52.45	6.40	58.85	105.20	-46.35	peak
4	5720.000	68.95	6.44	75.39	110.80	-35.41	peak
5	5725.000	73.09	6.45	79.54	122.20	-42.66	peak
6	5751.200	107.78	6.49	114.27	--	--	peak
7	5850.000	49.51	6.67	56.18	122.20	-66.02	peak
8	5855.000	48.77	6.67	55.44	110.80	-55.36	peak
9	5875.000	47.92	6.72	54.64	105.20	-50.56	peak
10	5925.000	47.93	6.80	54.73	68.20	-13.47	peak
11	6107.200	50.47	7.26	57.73	68.20	-10.47	peak

Note:1.Result (dBuV/m) = Correct Factor (dB/m) + Reading(dBuV).

2.Correction factor (dB/m) = Antenna Factor (dB/m) + Cable loss (dB) – Pre-Amplifier gain (dB).

3.When the peak results are less than average limit, so not need to evaluate the average.



Standard:	FCC Part 15.407	Test Distance:	3m
Test item:	Band edge		
Frequency:	5785MHz		
Mode:	Mode 2		
Ant.Polar.:	Horizontal		

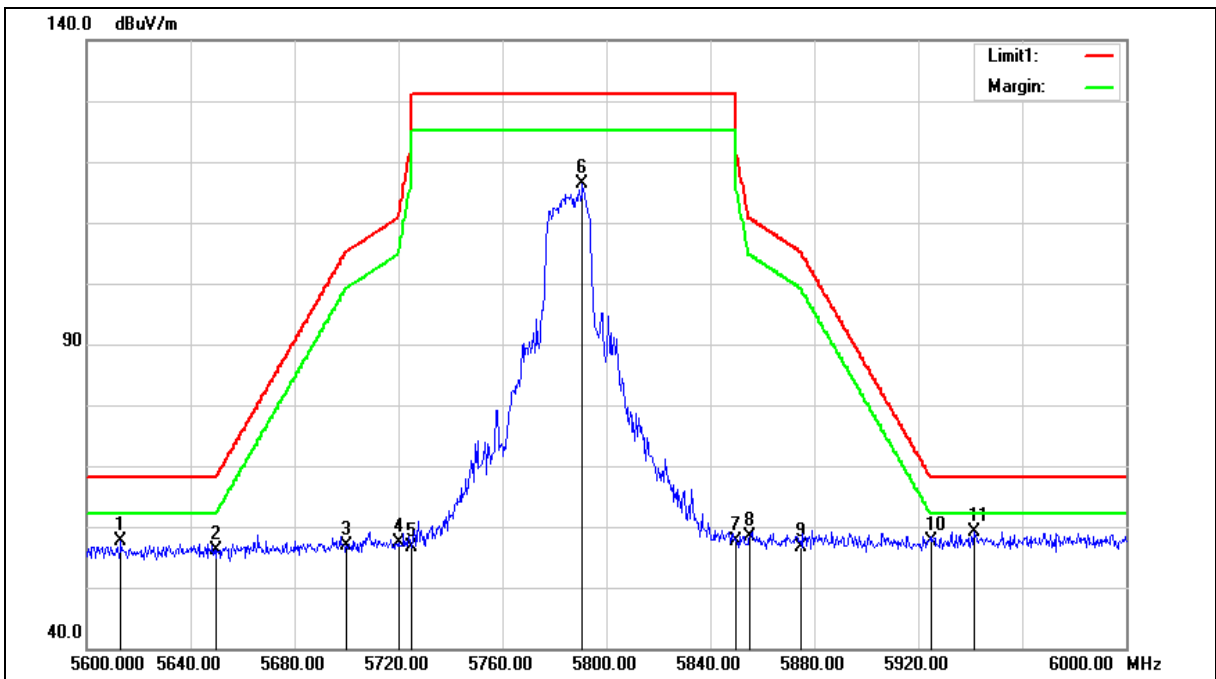



Standard:	FCC Part 15.407	Test Distance:	3m
Test item:	Band edge		
Frequency:	5785MHz		
Mode:	Mode 2		
Ant.Polar.:	Horizontal		

No.	Frequency (MHz)	Reading (dBuV)	Correct Factor (dB/m)	Result (dBuV/m)	Limit (dBuV/m)	Margin (dB)	Remark
1	5613.200	49.38	8.15	57.53	68.20	-10.67	peak
2	5650.000	47.92	8.24	56.16	68.20	-12.04	peak
3	5700.000	48.50	8.34	56.84	105.20	-48.36	peak
4	5720.000	48.97	8.38	57.35	110.80	-53.45	peak
5	5725.000	48.23	8.39	56.62	122.20	-65.58	peak
6	5790.800	107.80	8.51	116.31	--	--	peak
7	5850.000	49.12	8.63	57.75	122.20	-64.45	peak
8	5855.000	49.81	8.64	58.45	110.80	-52.35	peak
9	5875.000	47.84	8.69	56.53	105.20	-48.67	peak
10	5925.000	48.73	8.79	57.52	68.20	-10.68	peak
11	5941.600	50.39	8.82	59.21	68.20	-8.99	peak

Note:1.Result (dBuV/m) = Correct Factor (dB/m) + Reading(dBuV).

2.Correction factor (dB/m) = Antenna Factor (dB/m) + Cable loss (dB) – Pre-Amplifier gain (dB).

3.When the peak results are less than average limit, so not need to evaluate the average.



Standard:	FCC Part 15.407	Test Distance:	3m
Test item:	Band edge		
Frequency:	5785MHz		
Mode:	Mode 2		
Ant.Polar.:	Vertical		

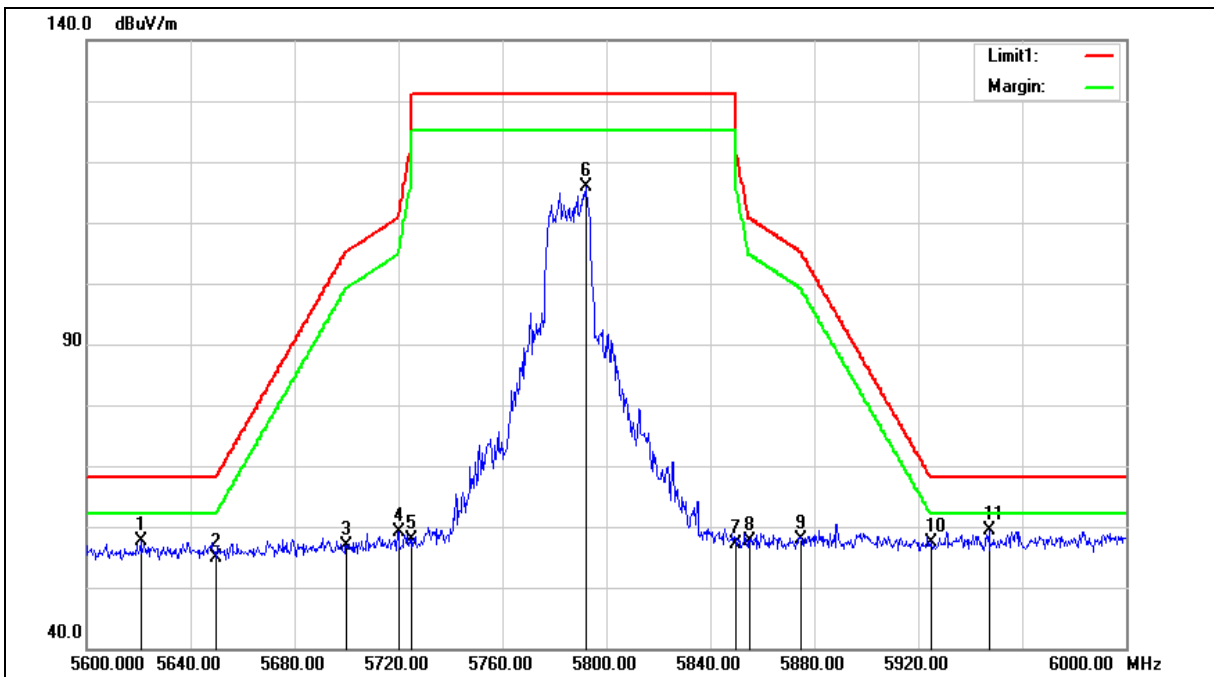



Standard:	FCC Part 15.407	Test Distance:	3m
Test item:	Band edge		
Frequency:	5785MHz		
Mode:	Mode 2		
Ant.Polar.:	Vertical		

No.	Frequency (MHz)	Reading (dBuV)	Correct Factor (dB/m)	Result (dBuV/m)	Limit (dBuV/m)	Margin (dB)	Remark
1	5620.800	49.37	8.17	57.54	68.20	-10.66	peak
2	5650.000	46.72	8.24	54.96	68.20	-13.24	peak
3	5700.000	48.49	8.34	56.83	105.20	-48.37	peak
4	5720.000	50.63	8.38	59.01	110.80	-51.79	peak
5	5725.000	49.48	8.39	57.87	122.20	-64.33	peak
6	5792.000	107.34	8.52	115.86	--	--	peak
7	5850.000	48.53	8.63	57.16	122.20	-65.04	peak
8	5855.000	49.05	8.64	57.69	110.80	-53.11	peak
9	5875.000	49.24	8.69	57.93	105.20	-47.27	peak
10	5925.000	48.47	8.79	57.26	68.20	-10.94	peak
11	5947.200	50.50	8.84	59.34	68.20	-8.86	peak

Note:1.Result (dBuV/m) = Correct Factor (dB/m) + Reading(dBuV).

2.Correction factor (dB/m) = Antenna Factor (dB/m) + Cable loss (dB) – Pre-Amplifier gain (dB).

3.When the peak results are less than average limit, so not need to evaluate the average.



Standard:	FCC Part 15.407	Test Distance:	3m
Test item:	Band edge		
Frequency:	5825MHz		
Mode:	Mode 2		
Ant.Polar.:	Horizontal		

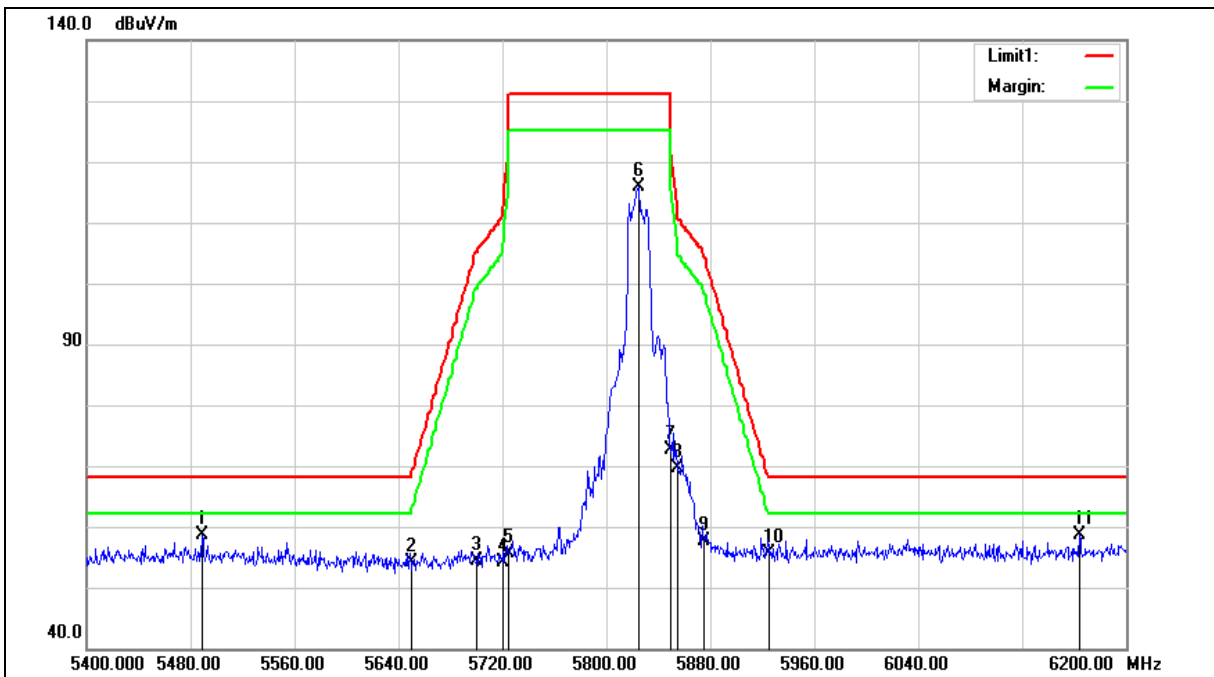



Standard:	FCC Part 15.407	Test Distance:	3m
Test item:	Band edge		
Frequency:	5825MHz		
Mode:	Mode 2		
Ant.Polar.:	Horizontal		

No.	Frequency (MHz)	Reading (dBUV)	Correct Factor (dB/m)	Result (dBUV/m)	Limit (dBUV/m)	Margin (dB)	Remark
1	5488.800	52.50	6.01	58.51	68.20	-9.69	peak
2	5650.000	47.75	6.31	54.06	68.20	-14.14	peak
3	5700.000	47.86	6.40	54.26	105.20	-50.94	peak
4	5720.000	47.74	6.44	54.18	110.80	-56.62	peak
5	5725.000	49.29	6.45	55.74	122.20	-66.46	peak
6	5824.800	109.23	6.62	115.85	--	--	peak
7	5850.000	66.02	6.67	72.69	122.20	-49.51	peak
8	5855.000	62.84	6.67	69.51	110.80	-41.29	peak
9	5875.000	50.86	6.72	57.58	105.20	-47.62	peak
10	5925.000	48.80	6.80	55.60	68.20	-12.60	peak
11	6164.000	51.18	7.41	58.59	68.20	-9.61	peak

Note:1.Result (dBUV/m) = Correct Factor (dB/m) + Reading(dBUV).

2.Correction factor (dB/m) = Antenna Factor (dB/m) + Cable loss (dB) – Pre-Amplifier gain (dB).

3.When the peak results are less than average limit, so not need to evaluate the average.



Standard:	FCC Part 15.407	Test Distance:	3m
Test item:	Band edge		
Frequency:	5825MHz		
Mode:	Mode 2		
Ant.Polar.:	Vertical		

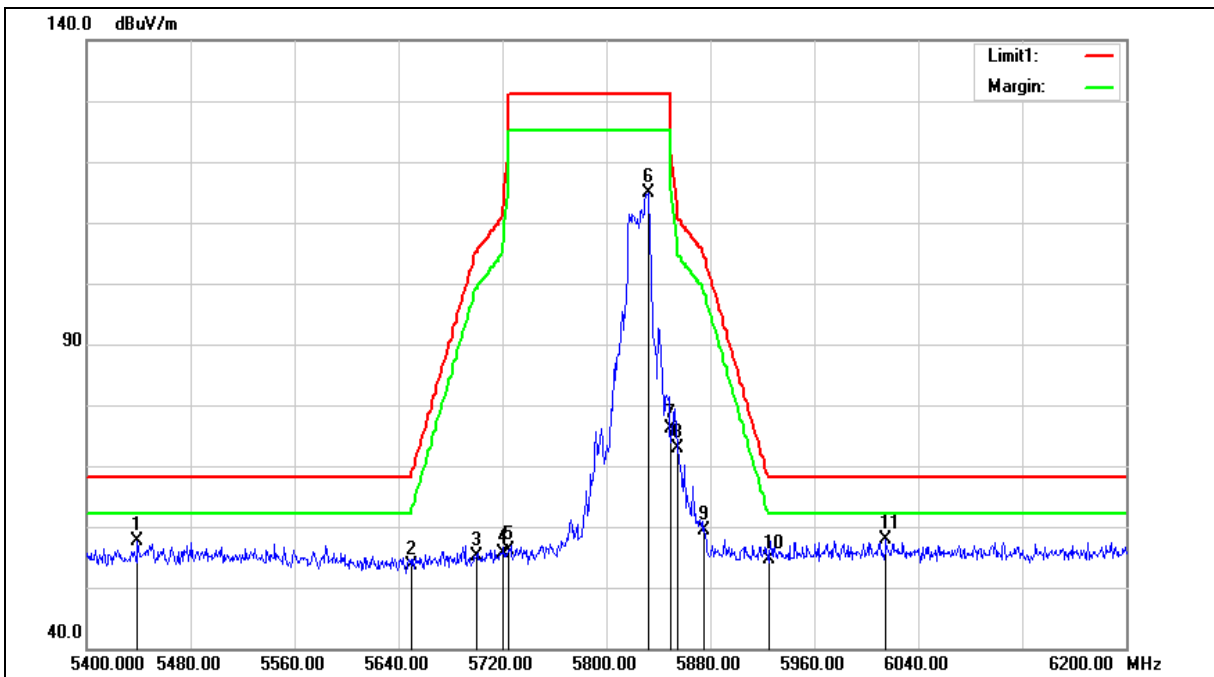



Standard:	FCC Part 15.407	Test Distance:	3m
Test item:	Band edge		
Frequency:	5825MHz		
Mode:	Mode 2		
Ant.Polar.:	Vertical		

No.	Frequency (MHz)	Reading (dBuV)	Correct Factor (dB/m)	Result (dBuV/m)	Limit (dBuV/m)	Margin (dB)	Remark
1	5439.200	51.74	5.88	57.62	68.20	-10.58	peak
2	5650.000	47.26	6.31	53.57	68.20	-14.63	peak
3	5700.000	48.78	6.40	55.18	105.20	-50.02	peak
4	5720.000	49.27	6.44	55.71	110.80	-55.09	peak
5	5725.000	49.56	6.45	56.01	122.20	-66.19	peak
6	5832.000	108.22	6.64	114.86	--	--	peak
7	5850.000	69.46	6.67	76.13	122.20	-46.07	peak
8	5855.000	66.20	6.67	72.87	110.80	-37.93	peak
9	5875.000	52.65	6.72	59.37	105.20	-45.83	peak
10	5925.000	47.89	6.80	54.69	68.20	-13.51	peak
11	6015.200	50.87	6.99	57.86	68.20	-10.34	peak

Note:1.Result (dBuV/m) = Correct Factor (dB/m) + Reading(dBuV).

2.Correction factor (dB/m) = Antenna Factor (dB/m) + Cable loss (dB) – Pre-Amplifier gain (dB).

3.When the peak results are less than average limit, so not need to evaluate the average.



Standard:	FCC Part 15.407	Test Distance:	3m
Test item:	Band edge		
Frequency:	5180MHz		
Mode:	Mode 3		
Ant.Polar.:	Horizontal		

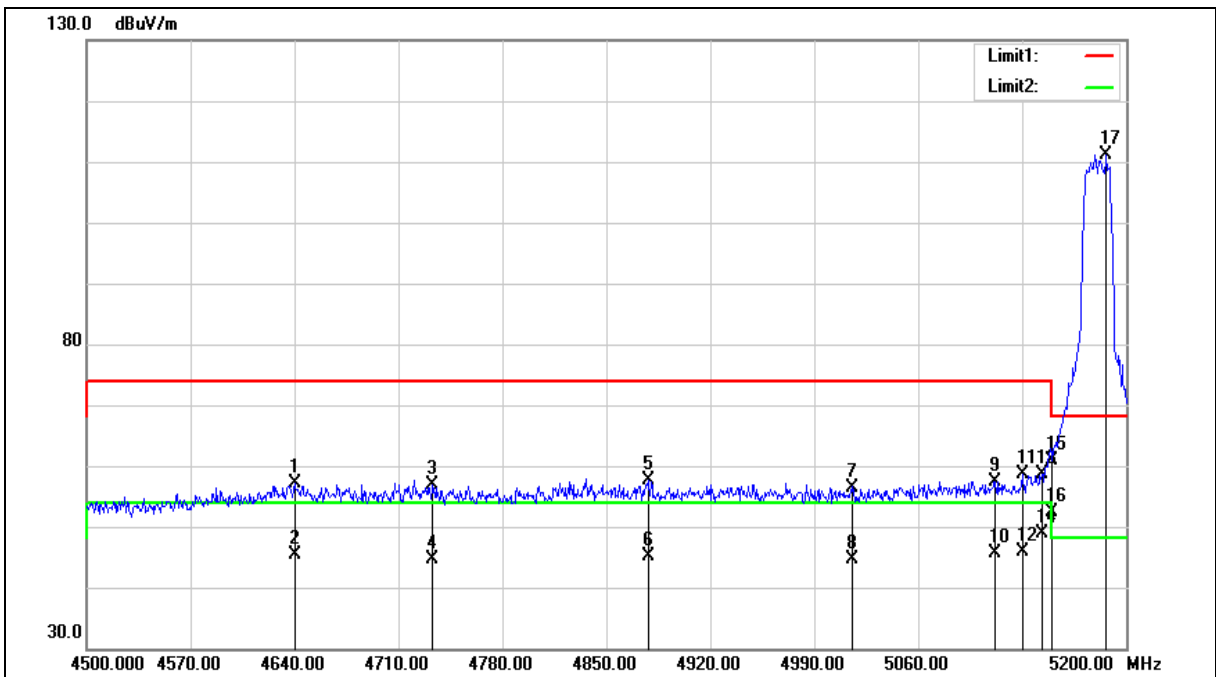



Standard:	FCC Part 15.407	Test Distance:	3m
Test item:	Band edge		
Frequency:	5180MHz		
Mode:	Mode 3		
Ant.Polar.:	Horizontal		

No.	Frequency (MHz)	Reading (dBuV)	Correct Factor (dB/m)	Result (dBuV/m)	Limit (dBuV/m)	Margin (dB)	Remark
1	4640.000	51.66	5.41	57.07	74.00	-16.93	peak
2	4640.000	39.90	5.41	45.31	54.00	-8.69	AVG
3	4733.100	51.15	5.69	56.84	74.00	-17.16	peak
4	4733.100	38.96	5.69	44.65	54.00	-9.35	AVG
5	4878.000	51.53	6.13	57.66	74.00	-16.34	peak
6	4878.000	38.98	6.13	45.11	54.00	-8.89	AVG
7	5015.900	49.94	6.56	56.50	74.00	-17.50	peak
8	5015.900	38.18	6.56	44.74	54.00	-9.26	AVG
9	5111.800	50.66	6.82	57.48	74.00	-16.52	peak
10	5111.800	38.77	6.82	45.59	54.00	-8.41	AVG
11	5130.000	51.65	6.88	58.53	74.00	-15.47	peak
12	5130.000	39.09	6.88	45.97	54.00	-8.03	AVG
13	5143.300	51.73	6.92	58.65	74.00	-15.35	peak
14	5143.300	41.89	6.92	48.81	54.00	-5.19	AVG
15	5150.000	53.94	6.94	60.88	74.00	-13.12	peak
16	5150.000	45.42	6.94	52.36	54.00	-1.64	AVG
17	5186.700	104.11	7.05	111.16	--	--	peak

Note:1.Result (dBuV/m) = Correct Factor (dB/m) + Reading(dBuV).

2.Correction factor (dB/m) = Antenna Factor (dB/m) + Cable loss (dB) – Pre-Amplifier gain (dB).

3.When the peak results are less than average limit, so not need to evaluate the average.



Standard:	FCC Part 15.407	Test Distance:	3m
Test item:	Band edge		
Frequency:	5180MHz		
Mode:	Mode 3		
Ant.Polar.:	Vertical		

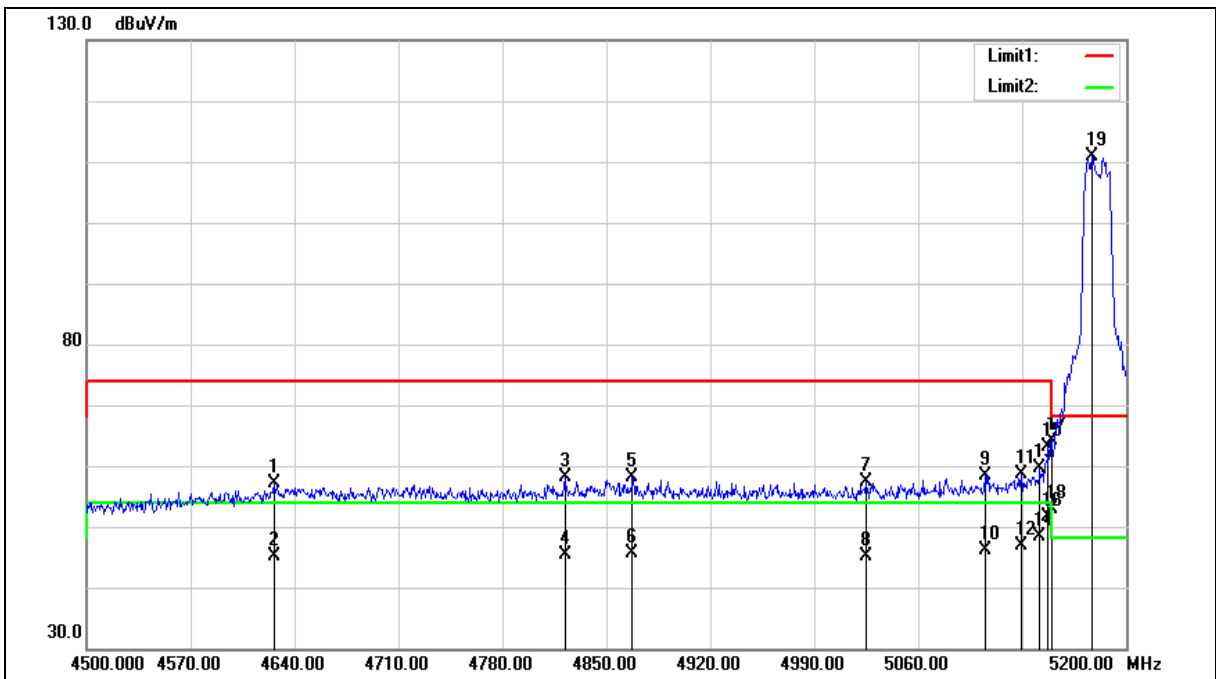



Standard:	FCC Part 15.407	Test Distance:	3m
Test item:	Band edge		
Frequency:	5180MHz		
Mode:	Mode 3		
Ant.Polar.:	Vertical		

No.	Frequency (MHz)	Reading (dBuV)	Correct Factor (dB/m)	Result (dBuV/m)	Limit (dBuV/m)	Margin (dB)	Remark
1	4626.000	51.64	5.37	57.01	74.00	-16.99	peak
2	4626.000	39.69	5.37	45.06	54.00	-8.94	AVG
3	4822.000	52.18	5.97	58.15	74.00	-15.85	peak
4	4822.000	39.41	5.97	45.38	54.00	-8.62	AVG
5	4867.500	52.08	6.11	58.19	74.00	-15.81	peak
6	4867.500	39.47	6.11	45.58	54.00	-8.42	AVG
7	5025.000	50.79	6.57	57.36	74.00	-16.64	peak
8	5025.000	38.64	6.57	45.21	54.00	-8.79	AVG
9	5104.800	51.51	6.80	58.31	74.00	-15.69	peak
10	5104.800	39.23	6.80	46.03	54.00	-7.97	AVG
11	5129.300	51.85	6.88	58.73	74.00	-15.27	peak
12	5129.300	39.90	6.88	46.78	54.00	-7.22	AVG
13	5141.900	52.82	6.92	59.74	74.00	-14.26	peak
14	5141.900	41.56	6.92	48.48	54.00	-5.52	AVG
15	5147.500	56.15	6.94	63.09	74.00	-10.91	peak
16	5147.500	44.80	6.94	51.74	54.00	-2.26	AVG
17	5150.000	57.27	6.94	64.21	74.00	-9.79	peak
18	5150.000	45.96	6.94	52.90	54.00	-1.10	AVG
19	5176.900	103.92	7.02	110.94	--	--	peak

Note:1.Result (dBuV/m) = Correct Factor (dB/m) + Reading(dBuV).

2.Correction factor (dB/m) = Antenna Factor (dB/m) + Cable loss (dB) – Pre-Amplifier gain (dB).

3.When the peak results are less than average limit, so not need to evaluate the average.



Standard:	FCC Part 15.407	Test Distance:	3m
Test item:	Band edge		
Frequency:	5200MHz		
Mode:	Mode 3		
Ant.Polar.:	Horizontal		

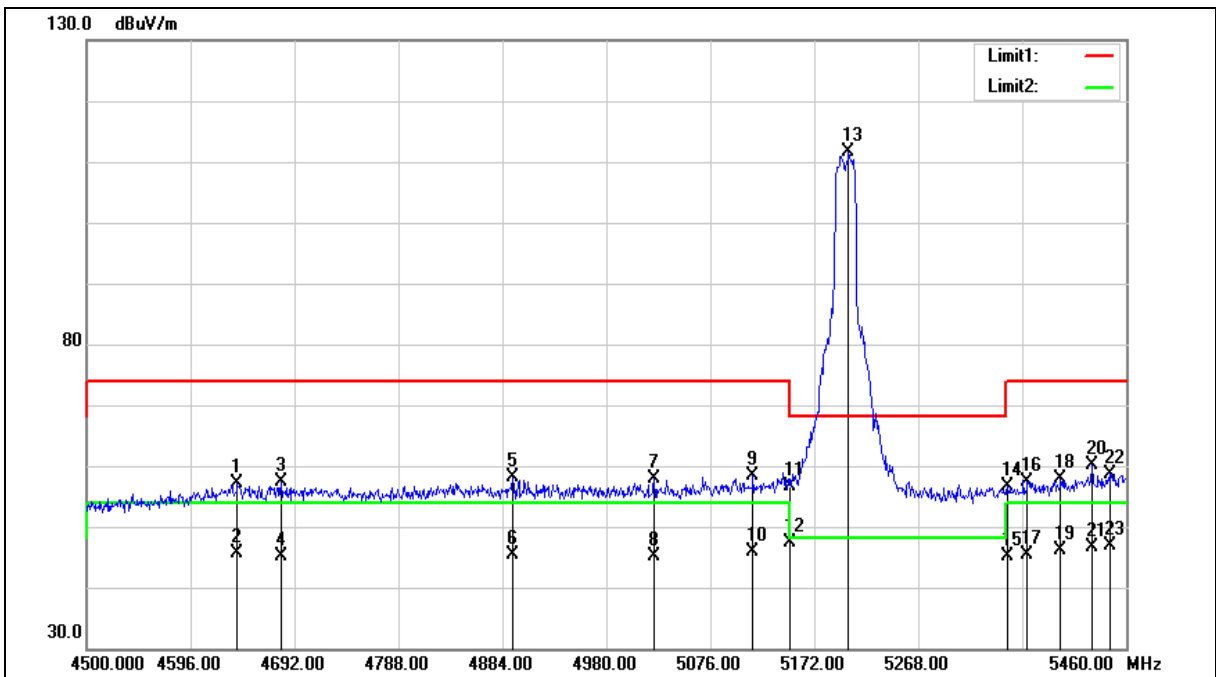



Standard:	FCC Part 15.407	Test Distance:	3m
Test item:	Band edge		
Frequency:	5200MHz		
Mode:	Mode 3		
Ant.Polar.:	Horizontal		

No.	Frequency (MHz)	Reading (dBUV)	Correct Factor (dB/m)	Result (dBUV/m)	Limit (dBUV/m)	Margin (dB)	Remark
1	4639.200	51.83	5.41	57.24	74.00	-16.76	peak
2	4639.200	40.12	5.41	45.53	54.00	-8.47	AVG
3	4679.520	51.73	5.53	57.26	74.00	-16.74	peak
4	4679.520	39.57	5.53	45.10	54.00	-8.90	AVG
5	4893.600	51.88	6.19	58.07	74.00	-15.93	peak
6	4893.600	39.13	6.19	45.32	54.00	-8.68	AVG
7	5024.160	51.33	6.57	57.90	74.00	-16.10	peak
8	5024.160	38.44	6.57	45.01	54.00	-8.99	AVG
9	5115.360	51.48	6.84	58.32	74.00	-15.68	peak
10	5115.360	39.06	6.84	45.90	54.00	-8.10	AVG
11	5150.000	49.63	6.94	56.57	74.00	-17.43	peak
12	5150.000	40.51	6.94	47.45	54.00	-6.55	AVG
13	5203.680	104.59	7.09	111.68	--	--	peak
14	5350.000	49.19	7.50	56.69	74.00	-17.31	peak
15	5350.000	37.52	7.50	45.02	54.00	-8.98	AVG
16	5368.800	49.72	7.55	57.27	74.00	-16.73	peak
17	5368.800	37.79	7.55	45.34	54.00	-8.66	AVG
18	5399.520	50.12	7.65	57.77	74.00	-16.23	peak
19	5399.520	38.55	7.65	46.20	54.00	-7.80	AVG
20	5428.320	52.29	7.73	60.02	74.00	-13.98	peak
21	5428.320	38.81	7.73	46.54	54.00	-7.46	AVG
22	5445.600	50.74	7.78	58.52	74.00	-15.48	peak
23	5445.600	39.12	7.78	46.90	54.00	-7.10	AVG

Note:1.Result (dBUV/m) = Correct Factor (dB/m) + Reading(dBUV).

2.Correction factor (dB/m) = Antenna Factor (dB/m) + Cable loss (dB) – Pre-Amplifier gain (dB).

3.When the peak results are less than average limit, so not need to evaluate the average.



Standard:	FCC Part 15.407	Test Distance:	3m
Test item:	Band edge		
Frequency:	5200MHz		
Mode:	Mode 3		
Ant.Polar.:	Vertical		

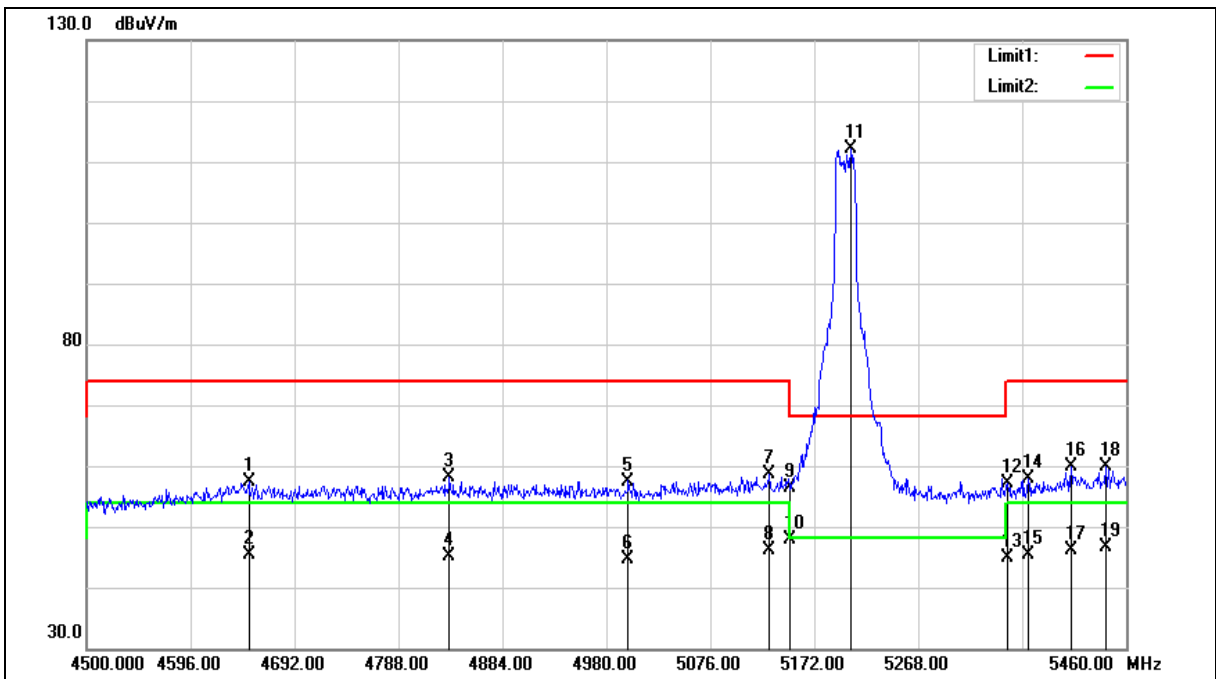



Standard:	FCC Part 15.407	Test Distance:	3m
Test item:	Band edge		
Frequency:	5200MHz		
Mode:	Mode 3		
Ant.Polar.:	Vertical		

No.	Frequency (MHz)	Reading (dBuV)	Correct Factor (dB/m)	Result (dBuV/m)	Limit (dBuV/m)	Margin (dB)	Remark
1	4649.760	52.05	5.43	57.48	74.00	-16.52	peak
2	4649.760	39.87	5.43	45.30	54.00	-8.70	AVG
3	4835.040	52.12	6.00	58.12	74.00	-15.88	peak
4	4835.040	39.19	6.00	45.19	54.00	-8.81	AVG
5	5000.160	50.99	6.51	57.50	74.00	-16.50	peak
6	5000.160	38.21	6.51	44.72	54.00	-9.28	AVG
7	5130.720	51.62	6.89	58.51	74.00	-15.49	peak
8	5130.720	39.12	6.89	46.01	54.00	-7.99	AVG
9	5150.000	49.45	6.94	56.39	74.00	-17.61	peak
10	5150.000	40.93	6.94	47.87	54.00	-6.13	AVG
11	5205.600	105.03	7.10	112.13	--	--	peak
12	5350.000	49.51	7.50	57.01	74.00	-16.99	peak
13	5350.000	37.34	7.50	44.84	54.00	-9.16	AVG
14	5369.760	50.21	7.56	57.77	74.00	-16.23	peak
15	5369.760	37.81	7.56	45.37	54.00	-8.63	AVG
16	5409.120	52.29	7.68	59.97	74.00	-14.03	peak
17	5409.120	38.56	7.68	46.24	54.00	-7.76	AVG
18	5441.760	52.05	7.77	59.82	74.00	-14.18	peak
19	5441.760	38.95	7.77	46.72	54.00	-7.28	AVG

Note:1.Result (dBuV/m) = Correct Factor (dB/m) + Reading(dBuV).

2.Correction factor (dB/m) = Antenna Factor (dB/m) + Cable loss (dB) – Pre-Amplifier gain (dB).

3.When the peak results are less than average limit, so not need to evaluate the average.



Standard:	FCC Part 15.407	Test Distance:	3m
Test item:	Band edge		
Frequency:	5240MHz		
Mode:	Mode 3		
Ant.Polar.:	Horizontal		

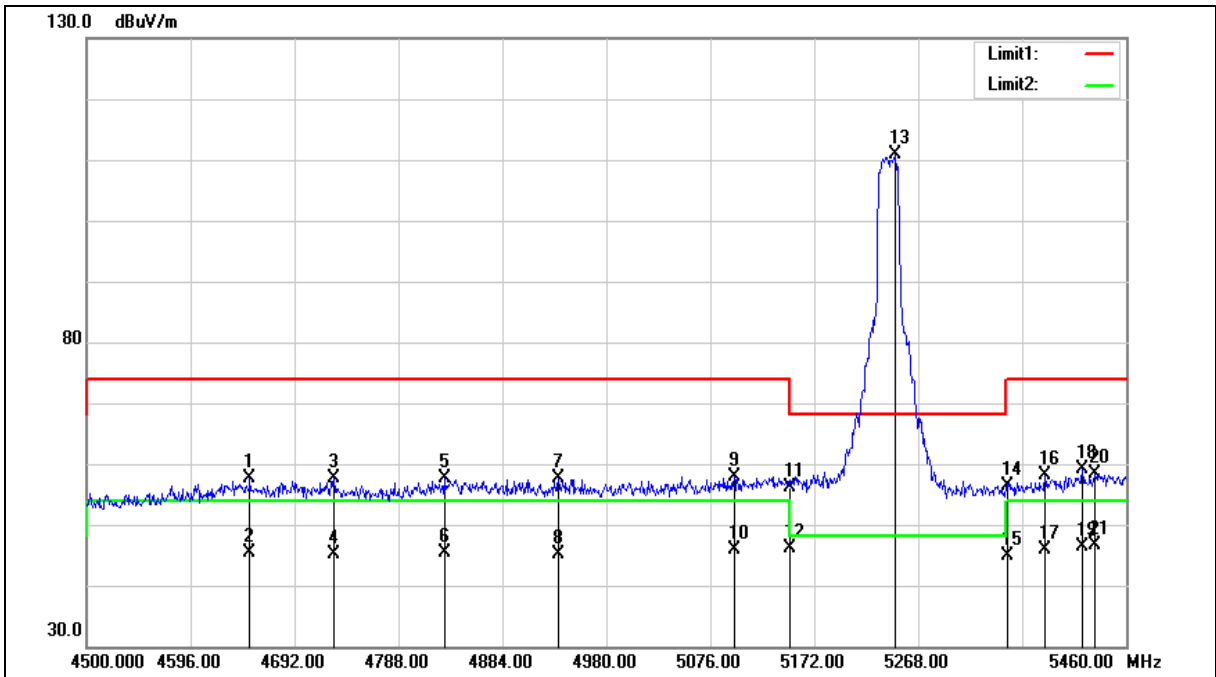



Standard:	FCC Part 15.407	Test Distance:	3m
Test item:	Band edge		
Frequency:	5240MHz		
Mode:	Mode 3		
Ant.Polar.:	Horizontal		

No.	Frequency (MHz)	Reading (dBuV)	Correct Factor (dB/m)	Result (dBuV/m)	Limit (dBuV/m)	Margin (dB)	Remark
1	4650.720	52.21	5.44	57.65	74.00	-16.35	peak
2	4650.720	39.89	5.44	45.33	54.00	-8.67	AVG
3	4728.480	51.84	5.68	57.52	74.00	-16.48	peak
4	4728.480	39.36	5.68	45.04	54.00	-8.96	AVG
5	4830.240	51.70	5.99	57.69	74.00	-16.31	peak
6	4830.240	39.38	5.99	45.37	54.00	-8.63	AVG
7	4935.840	51.30	6.32	57.62	74.00	-16.38	peak
8	4935.840	38.92	6.32	45.24	54.00	-8.76	AVG
9	5098.080	51.11	6.79	57.90	74.00	-16.10	peak
10	5098.080	39.10	6.79	45.89	54.00	-8.11	AVG
11	5150.000	49.28	6.94	56.22	74.00	-17.78	peak
12	5150.000	39.28	6.94	46.22	54.00	-7.78	AVG
13	5246.880	103.71	7.21	110.92	--	--	peak
14	5350.000	48.85	7.50	56.35	74.00	-17.65	peak
15	5350.000	37.46	7.50	44.96	54.00	-9.04	AVG
16	5385.120	50.40	7.61	58.01	74.00	-15.99	peak
17	5385.120	38.15	7.61	45.76	54.00	-8.24	AVG
18	5419.680	51.42	7.71	59.13	74.00	-14.87	peak
19	5419.680	38.72	7.71	46.43	54.00	-7.57	AVG
20	5431.200	50.70	7.74	58.44	74.00	-15.56	peak
21	5431.200	38.88	7.74	46.62	54.00	-7.38	AVG

Note:1.Result (dBuV/m) = Correct Factor (dB/m) + Reading(dBuV).

2.Correction factor (dB/m) = Antenna Factor (dB/m) + Cable loss (dB) – Pre-Amplifier gain (dB).

3.When the peak results are less than average limit, so not need to evaluate the average.



Standard:	FCC Part 15.407	Test Distance:	3m
Test item:	Band edge		
Frequency:	5240MHz		
Mode:	Mode 3		
Ant.Polar.:	Vertical		

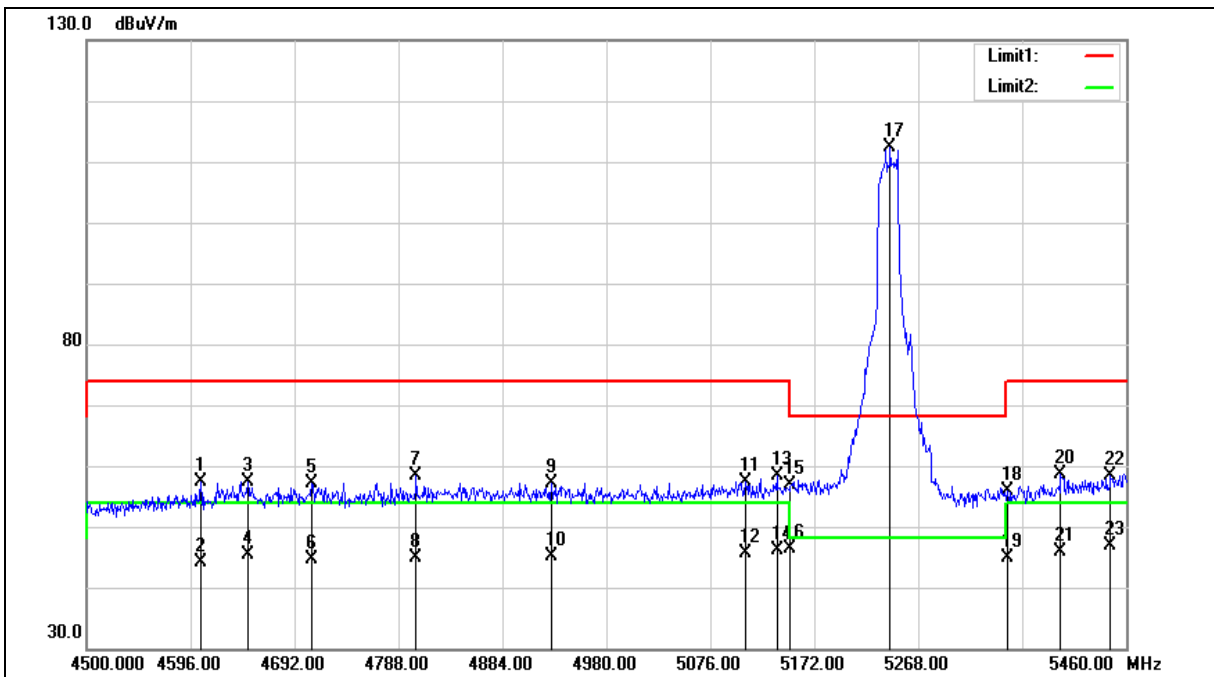



Standard:	FCC Part 15.407	Test Distance:	3m
Test item:	Band edge		
Frequency:	5240MHz		
Mode:	Mode 3		
Ant.Polar.:	Vertical		

No.	Frequency (MHz)	Reading (dBuV)	Correct Factor (dB/m)	Result (dBuV/m)	Limit (dBuV/m)	Margin (dB)	Remark
1	4605.600	51.96	5.30	57.26	74.00	-16.74	peak
2	4605.600	38.88	5.30	44.18	54.00	-9.82	AVG
3	4648.800	51.95	5.43	57.38	74.00	-16.62	peak
4	4648.800	39.86	5.43	45.29	54.00	-8.71	AVG
5	4708.320	51.60	5.62	57.22	74.00	-16.78	peak
6	4708.320	38.92	5.62	44.54	54.00	-9.46	AVG
7	4804.320	52.53	5.91	58.44	74.00	-15.56	peak
8	4804.320	38.99	5.91	44.90	54.00	-9.10	AVG
9	4929.120	50.78	6.29	57.07	74.00	-16.93	peak
10	4929.120	38.75	6.29	45.04	54.00	-8.96	AVG
11	5108.640	50.60	6.82	57.42	74.00	-16.58	peak
12	5108.640	38.91	6.82	45.73	54.00	-8.27	AVG
13	5137.440	51.58	6.91	58.49	74.00	-15.51	peak
14	5137.440	39.22	6.91	46.13	54.00	-7.87	AVG
15	5150.000	49.98	6.94	56.92	74.00	-17.08	peak
16	5150.000	39.38	6.94	46.32	54.00	-7.68	AVG
17	5242.080	105.15	7.20	112.35	--	--	peak
18	5350.000	48.27	7.50	55.77	74.00	-18.23	peak
19	5350.000	37.39	7.50	44.89	54.00	-9.11	AVG
20	5399.520	50.99	7.65	58.64	74.00	-15.36	peak
21	5399.520	38.35	7.65	46.00	54.00	-8.00	AVG
22	5445.600	50.61	7.78	58.39	74.00	-15.61	peak
23	5445.600	39.07	7.78	46.85	54.00	-7.15	AVG

Note:1.Result (dBuV/m) = Correct Factor (dB/m) + Reading(dBuV).

2.Correction factor (dB/m) = Antenna Factor (dB/m) + Cable loss (dB) – Pre-Amplifier gain (dB).

3.When the peak results are less than average limit, so not need to evaluate the average.



Standard:	FCC Part 15.407	Test Distance:	3m
Test item:	Band edge		
Frequency:	5745MHz		
Mode:	Mode 3		
Ant.Polar.:	Horizontal		

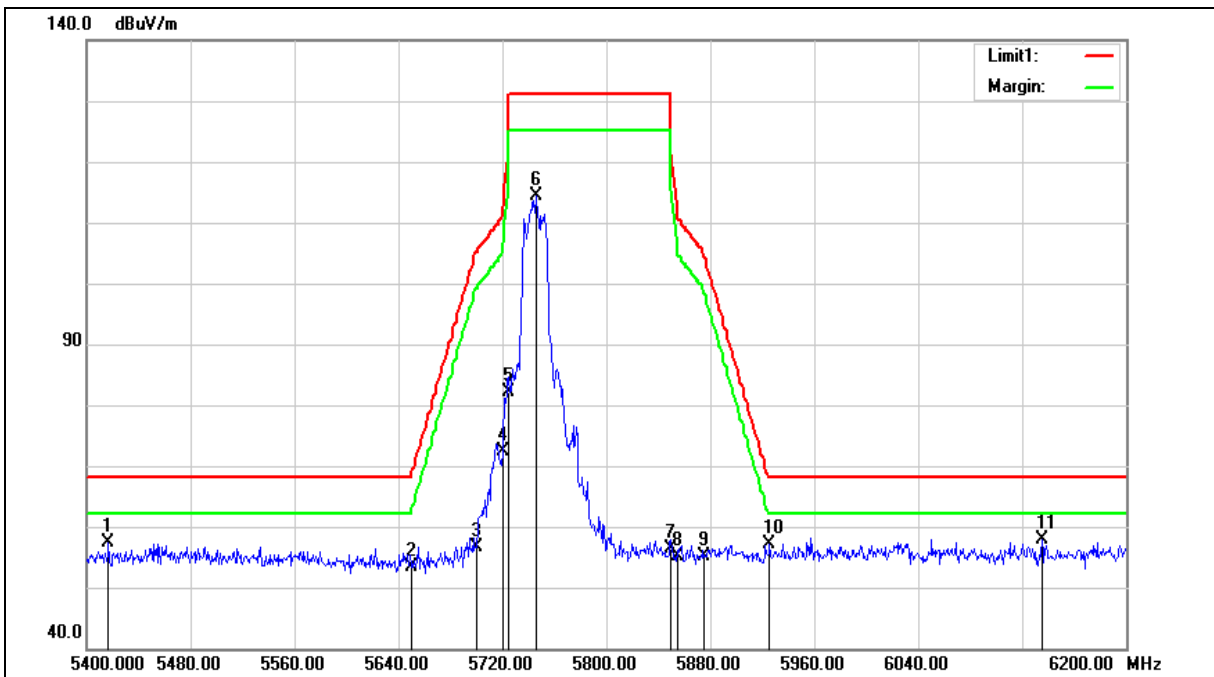



Standard:	FCC Part 15.407	Test Distance:	3m
Test item:	Band edge		
Frequency:	5745MHz		
Mode:	Mode 3		
Ant.Polar.:	Horizontal		

No.	Frequency (MHz)	Reading (dBuV)	Correct Factor (dB/m)	Result (dBuV/m)	Limit (dBuV/m)	Margin (dB)	Remark
1	5416.800	51.59	5.82	57.41	68.20	-10.79	peak
2	5650.000	47.10	6.31	53.41	68.20	-14.79	peak
3	5700.000	50.24	6.40	56.64	105.20	-48.56	peak
4	5720.000	65.90	6.44	72.34	110.80	-38.46	peak
5	5725.000	75.56	6.45	82.01	122.20	-40.19	peak
6	5745.600	107.92	6.48	114.40	--	--	peak
7	5850.000	49.61	6.67	56.28	122.20	-65.92	peak
8	5855.000	48.41	6.67	55.08	110.80	-55.72	peak
9	5875.000	48.37	6.72	55.09	105.20	-50.11	peak
10	5925.000	50.39	6.80	57.19	68.20	-11.01	peak
11	6135.200	50.63	7.33	57.96	68.20	-10.24	peak

Note:1.Result (dBuV/m) = Correct Factor (dB/m) + Reading(dBuV).

2.Correction factor (dB/m) = Antenna Factor (dB/m) + Cable loss (dB) – Pre-Amplifier gain (dB).

3.When the peak results are less than average limit, so not need to evaluate the average.



Standard:	FCC Part 15.407	Test Distance:	3m
Test item:	Band edge		
Frequency:	5745MHz		
Mode:	Mode 3		
Ant.Polar.:	Vertical		

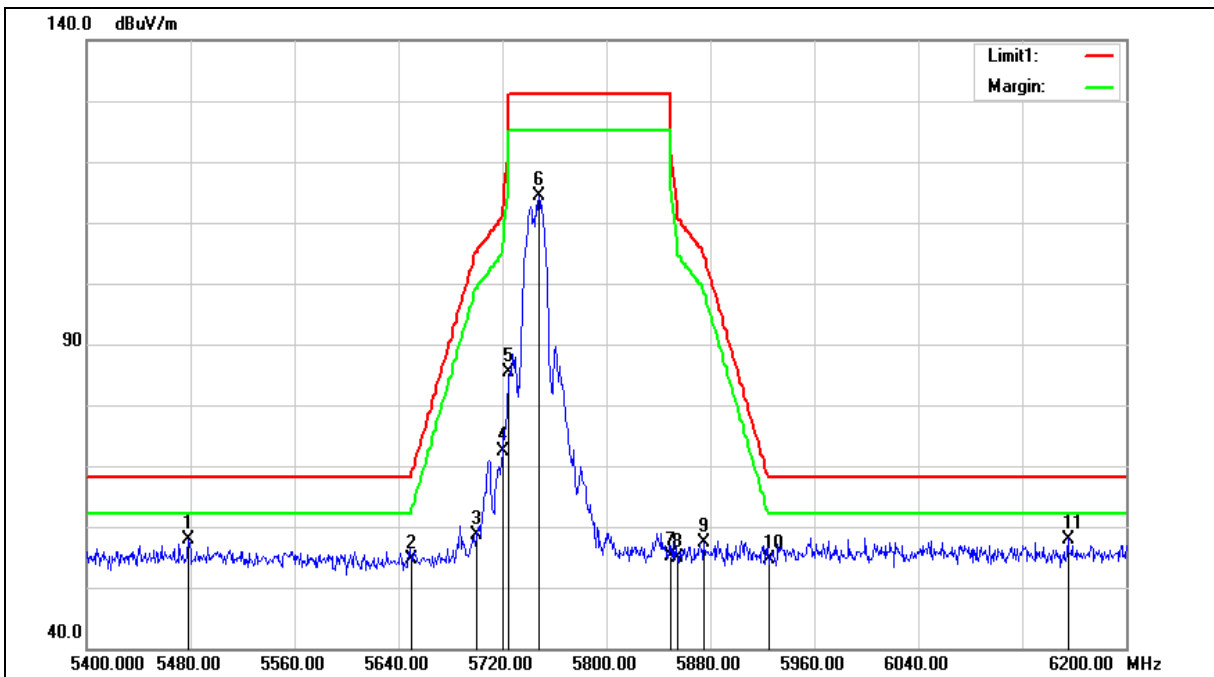



Standard:	FCC Part 15.407	Test Distance:	3m
Test item:	Band edge		
Frequency:	5745MHz		
Mode:	Mode 3		
Ant.Polar.:	Vertical		

No.	Frequency (MHz)	Reading (dBuV)	Correct Factor (dB/m)	Result (dBuV/m)	Limit (dBuV/m)	Margin (dB)	Remark
1	5478.400	52.00	5.98	57.98	68.20	-10.22	peak
2	5650.000	48.40	6.31	54.71	68.20	-13.49	peak
3	5700.000	52.17	6.40	58.57	105.20	-46.63	peak
4	5720.000	65.84	6.44	72.28	110.80	-38.52	peak
5	5725.000	78.96	6.45	85.41	122.20	-36.79	peak
6	5748.000	107.91	6.48	114.39	--	--	peak
7	5850.000	48.42	6.67	55.09	122.20	-67.11	peak
8	5855.000	48.11	6.67	54.78	110.80	-56.02	peak
9	5875.000	50.75	6.72	57.47	105.20	-47.73	peak
10	5925.000	47.89	6.80	54.69	68.20	-13.51	peak
11	6155.200	50.60	7.40	58.00	68.20	-10.20	peak

Note:1.Result (dBuV/m) = Correct Factor (dB/m) + Reading(dBuV).

2.Correction factor (dB/m) = Antenna Factor (dB/m) + Cable loss (dB) – Pre-Amplifier gain (dB).

3.When the peak results are less than average limit, so not need to evaluate the average.



Standard:	FCC Part 15.407	Test Distance:	3m
Test item:	Band edge		
Frequency:	5785MHz		
Mode:	Mode 3		
Ant.Polar.:	Horizontal		

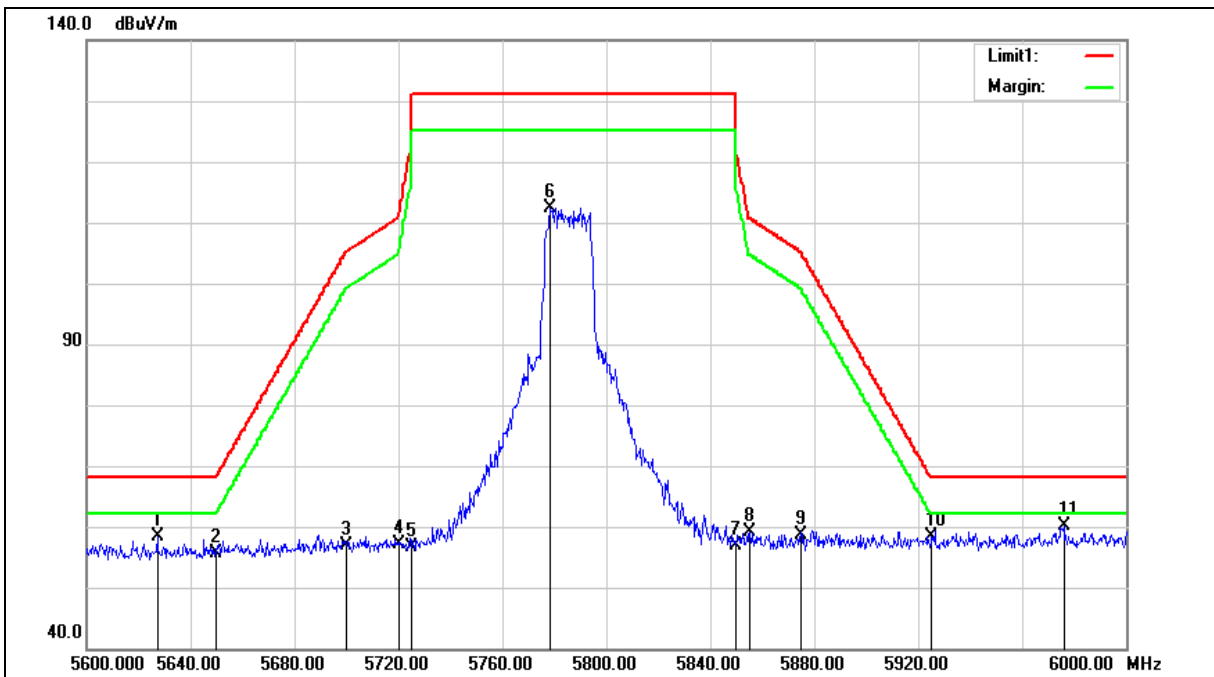



Standard:	FCC Part 15.407	Test Distance:	3m
Test item:	Band edge		
Frequency:	5785MHz		
Mode:	Mode 3		
Ant.Polar.:	Horizontal		

No.	Frequency (MHz)	Reading (dBuV)	Correct Factor (dB/m)	Result (dBuV/m)	Limit (dBuV/m)	Margin (dB)	Remark
1	5627.200	50.15	8.19	58.34	68.20	-9.86	peak
2	5650.000	47.34	8.24	55.58	68.20	-12.62	peak
3	5700.000	48.51	8.34	56.85	105.20	-48.35	peak
4	5720.000	48.67	8.38	57.05	110.80	-53.75	peak
5	5725.000	48.36	8.39	56.75	122.20	-65.45	peak
6	5778.400	103.89	8.49	112.38	--	--	peak
7	5850.000	48.35	8.63	56.98	122.20	-65.22	peak
8	5855.000	50.40	8.64	59.04	110.80	-51.76	peak
9	5875.000	49.89	8.69	58.58	105.20	-46.62	peak
10	5925.000	49.51	8.79	58.30	68.20	-9.90	peak
11	5976.000	51.16	8.90	60.06	68.20	-8.14	peak

Note:1.Result (dBuV/m) = Correct Factor (dB/m) + Reading(dBuV).

2.Correction factor (dB/m) = Antenna Factor (dB/m) + Cable loss (dB) – Pre-Amplifier gain (dB).

3.When the peak results are less than average limit, so not need to evaluate the average.



Standard:	FCC Part 15.407	Test Distance:	3m
Test item:	Band edge		
Frequency:	5785MHz		
Mode:	Mode 3		
Ant.Polar.:	Vertical		

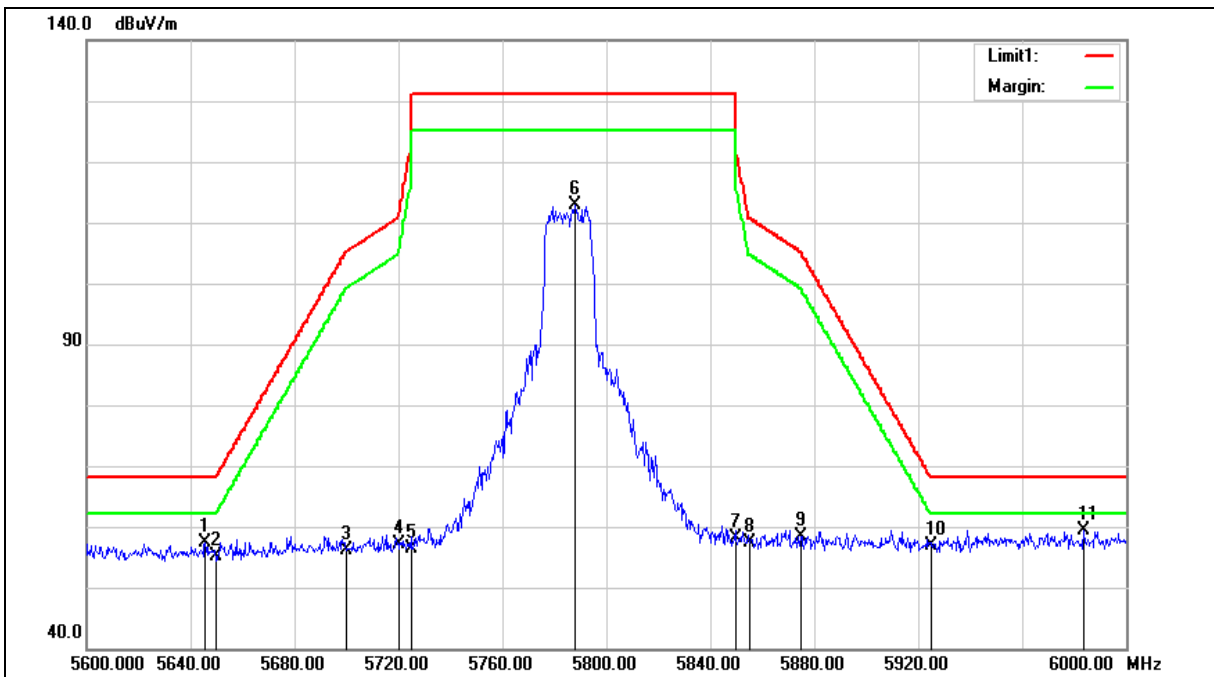



Standard:	FCC Part 15.407	Test Distance:	3m
Test item:	Band edge		
Frequency:	5785MHz		
Mode:	Mode 3		
Ant.Polar.:	Vertical		

No.	Frequency (MHz)	Reading (dBuV)	Correct Factor (dB/m)	Result (dBuV/m)	Limit (dBuV/m)	Margin (dB)	Remark
1	5645.600	49.18	8.23	57.41	68.20	-10.79	peak
2	5650.000	46.83	8.24	55.07	68.20	-13.13	peak
3	5700.000	47.83	8.34	56.17	105.20	-49.03	peak
4	5720.000	48.81	8.38	57.19	110.80	-53.61	peak
5	5725.000	48.04	8.39	56.43	122.20	-65.77	peak
6	5788.000	104.35	8.51	112.86	--	--	peak
7	5850.000	49.52	8.63	58.15	122.20	-64.05	peak
8	5855.000	48.76	8.64	57.40	110.80	-53.40	peak
9	5875.000	49.60	8.69	58.29	105.20	-46.91	peak
10	5925.000	48.08	8.79	56.87	68.20	-11.33	peak
11	5983.600	50.41	8.90	59.31	68.20	-8.89	peak

Note:1.Result (dBuV/m) = Correct Factor (dB/m) + Reading(dBuV).

2.Correction factor (dB/m) = Antenna Factor (dB/m) + Cable loss (dB) – Pre-Amplifier gain (dB).

3.When the peak results are less than average limit, so not need to evaluate the average.



Standard:	FCC Part 15.407	Test Distance:	3m
Test item:	Band edge		
Frequency:	5825MHz		
Mode:	Mode 3		
Ant.Polar.:	Horizontal		

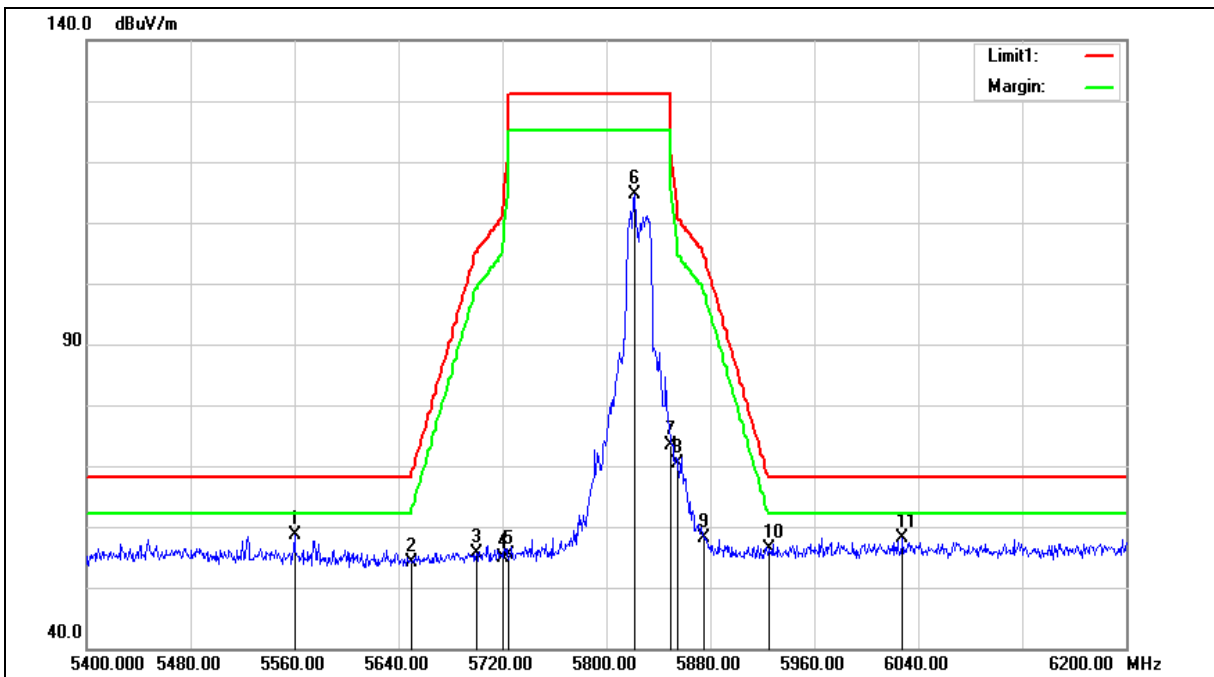



Standard:	FCC Part 15.407	Test Distance:	3m
Test item:	Band edge		
Frequency:	5825MHz		
Mode:	Mode 3		
Ant.Polar.:	Horizontal		

No.	Frequency (MHz)	Reading (dBuV)	Correct Factor (dB/m)	Result (dBuV/m)	Limit (dBuV/m)	Margin (dB)	Remark
1	5560.000	52.41	6.14	58.55	68.20	-9.65	peak
2	5650.000	47.85	6.31	54.16	68.20	-14.04	peak
3	5700.000	49.18	6.40	55.58	105.20	-49.62	peak
4	5720.000	48.38	6.44	54.82	110.80	-55.98	peak
5	5725.000	48.94	6.45	55.39	122.20	-66.81	peak
6	5821.600	107.91	6.62	114.53	--	--	peak
7	5850.000	66.63	6.67	73.30	122.20	-48.90	peak
8	5855.000	63.73	6.67	70.40	110.80	-40.40	peak
9	5875.000	51.29	6.72	58.01	105.20	-47.19	peak
10	5925.000	49.47	6.80	56.27	68.20	-11.93	peak
11	6028.000	51.03	7.02	58.05	68.20	-10.15	peak

Note:1.Result (dBuV/m) = Correct Factor (dB/m) + Reading(dBuV).

2.Correction factor (dB/m) = Antenna Factor (dB/m) + Cable loss (dB) – Pre-Amplifier gain (dB).

3.When the peak results are less than average limit, so not need to evaluate the average.



Standard:	FCC Part 15.407	Test Distance:	3m
Test item:	Band edge		
Frequency:	5825MHz		
Mode:	Mode 3		
Ant.Polar.:	Vertical		

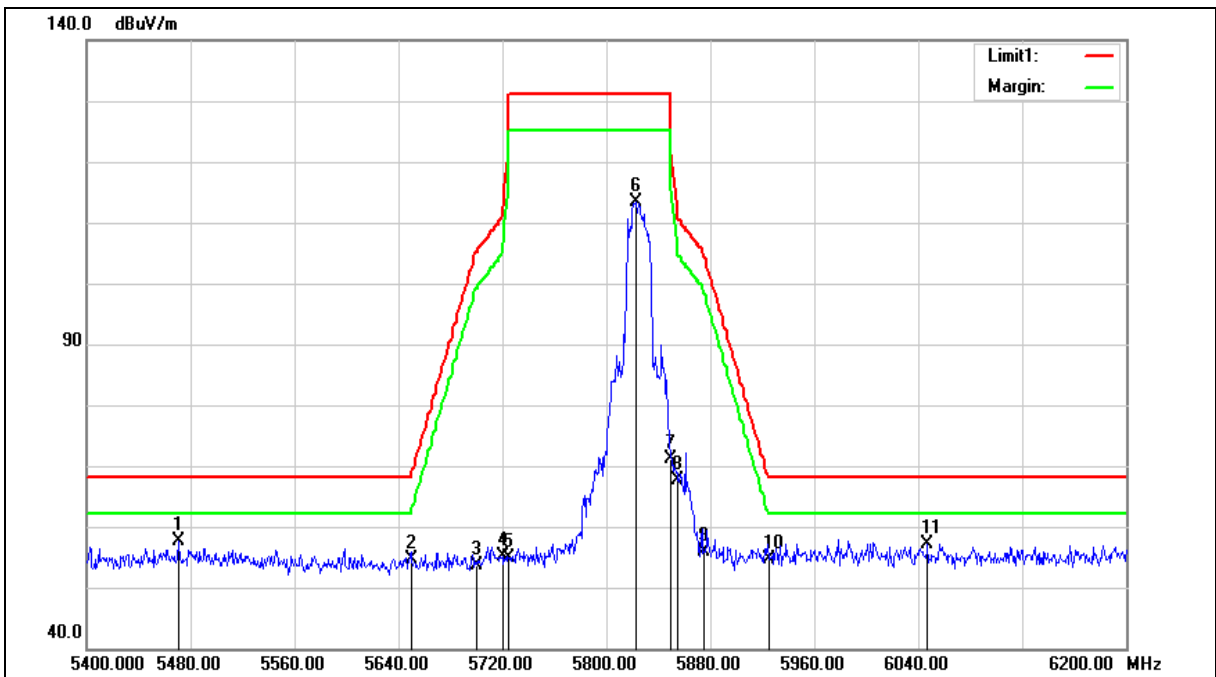



Standard:	FCC Part 15.407	Test Distance:	3m
Test item:	Band edge		
Frequency:	5825MHz		
Mode:	Mode 3		
Ant.Polar.:	Vertical		

No.	Frequency (MHz)	Reading (dBuV)	Correct Factor (dB/m)	Result (dBuV/m)	Limit (dBuV/m)	Margin (dB)	Remark
1	5470.400	51.77	5.96	57.73	68.20	-10.47	peak
2	5650.000	48.39	6.31	54.70	68.20	-13.50	peak
3	5700.000	47.35	6.40	53.75	105.20	-51.45	peak
4	5720.000	48.60	6.44	55.04	110.80	-55.76	peak
5	5725.000	48.55	6.45	55.00	122.20	-67.20	peak
6	5823.200	106.88	6.62	113.50	--	--	peak
7	5850.000	64.50	6.67	71.17	122.20	-51.03	peak
8	5855.000	60.87	6.67	67.54	110.80	-43.26	peak
9	5875.000	49.11	6.72	55.83	105.20	-49.37	peak
10	5925.000	47.87	6.80	54.67	68.20	-13.53	peak
11	6047.200	50.13	7.08	57.21	68.20	-10.99	peak

Note:1.Result (dBuV/m) = Correct Factor (dB/m) + Reading(dBuV).

2.Correction factor (dB/m) = Antenna Factor (dB/m) + Cable loss (dB) – Pre-Amplifier gain (dB).

3.When the peak results are less than average limit, so not need to evaluate the average.



Standard:	FCC Part 15.407	Test Distance:	3m
Test item:	Band edge		
Frequency:	5190MHz		
Mode:	Mode 4		
Ant.Polar.:	Horizontal		

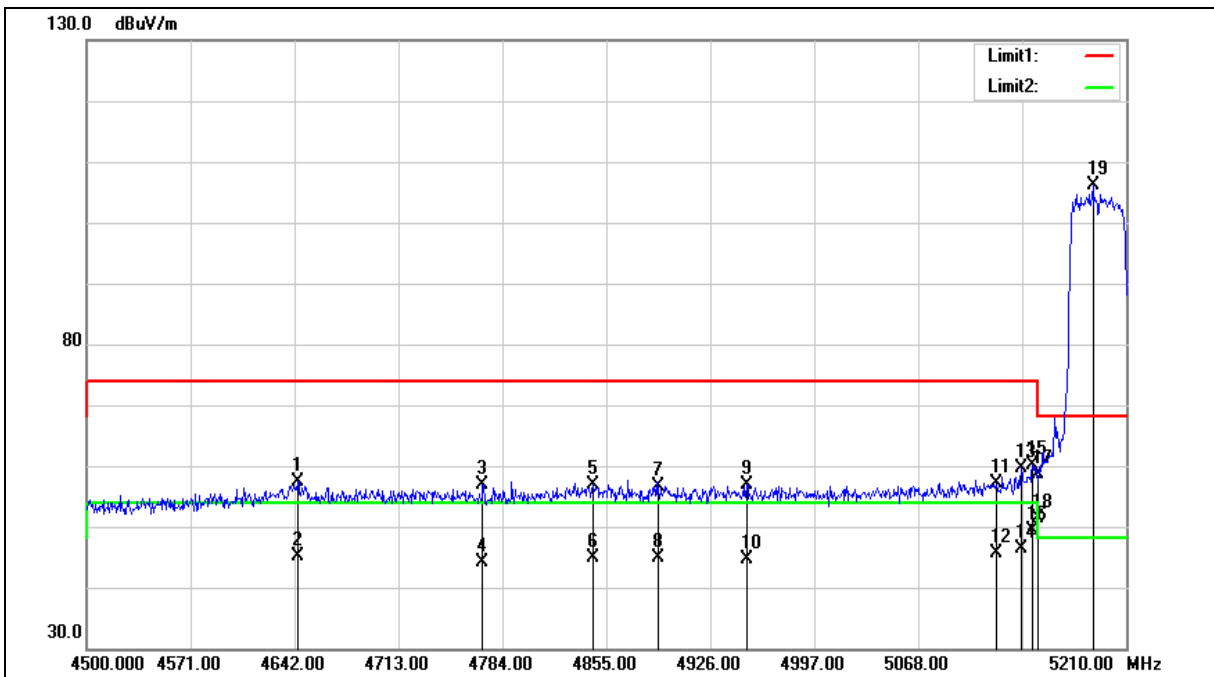



Standard:	FCC Part 15.407	Test Distance:	3m
Test item:	Band edge		
Frequency:	5190MHz		
Mode:	Mode 4		
Ant.Polar.:	Horizontal		

No.	Frequency (MHz)	Reading (dBuV)	Correct Factor (dB/m)	Result (dBuV/m)	Limit (dBuV/m)	Margin (dB)	Remark
1	4644.130	51.89	5.42	57.31	74.00	-16.69	peak
2	4644.130	39.66	5.42	45.08	54.00	-8.92	AVG
3	4770.510	51.14	5.81	56.95	74.00	-17.05	peak
4	4770.510	38.25	5.81	44.06	54.00	-9.94	AVG
5	4845.770	50.77	6.04	56.81	74.00	-17.19	peak
6	4845.770	38.79	6.04	44.83	54.00	-9.17	AVG
7	4890.500	50.51	6.17	56.68	74.00	-17.32	peak
8	4890.500	38.63	6.17	44.80	54.00	-9.20	AVG
9	4950.850	50.63	6.36	56.99	74.00	-17.01	peak
10	4950.850	38.33	6.36	44.69	54.00	-9.31	AVG
11	5121.250	50.36	6.85	57.21	74.00	-16.79	peak
12	5121.250	38.87	6.85	45.72	54.00	-8.28	AVG
13	5138.290	52.67	6.91	59.58	74.00	-14.42	peak
14	5138.290	39.53	6.91	46.44	54.00	-7.56	AVG
15	5146.100	53.28	6.93	60.21	74.00	-13.79	peak
16	5146.100	42.36	6.93	49.29	54.00	-4.71	AVG
17	5150.000	51.73	6.94	58.67	74.00	-15.33	peak
18	5150.000	44.47	6.94	51.41	54.00	-2.59	AVG
19	5187.280	98.97	7.05	106.02	--	--	peak

Note:1.Result (dBuV/m) = Correct Factor (dB/m) + Reading(dBuV).

2.Correction factor (dB/m) = Antenna Factor (dB/m) + Cable loss (dB) – Pre-Amplifier gain (dB).

3.When the peak results are less than average limit, so not need to evaluate the average.



Standard:	FCC Part 15.407	Test Distance:	3m
Test item:	Band edge		
Frequency:	5190MHz		
Mode:	Mode 4		
Ant.Polar.:	Vertical		

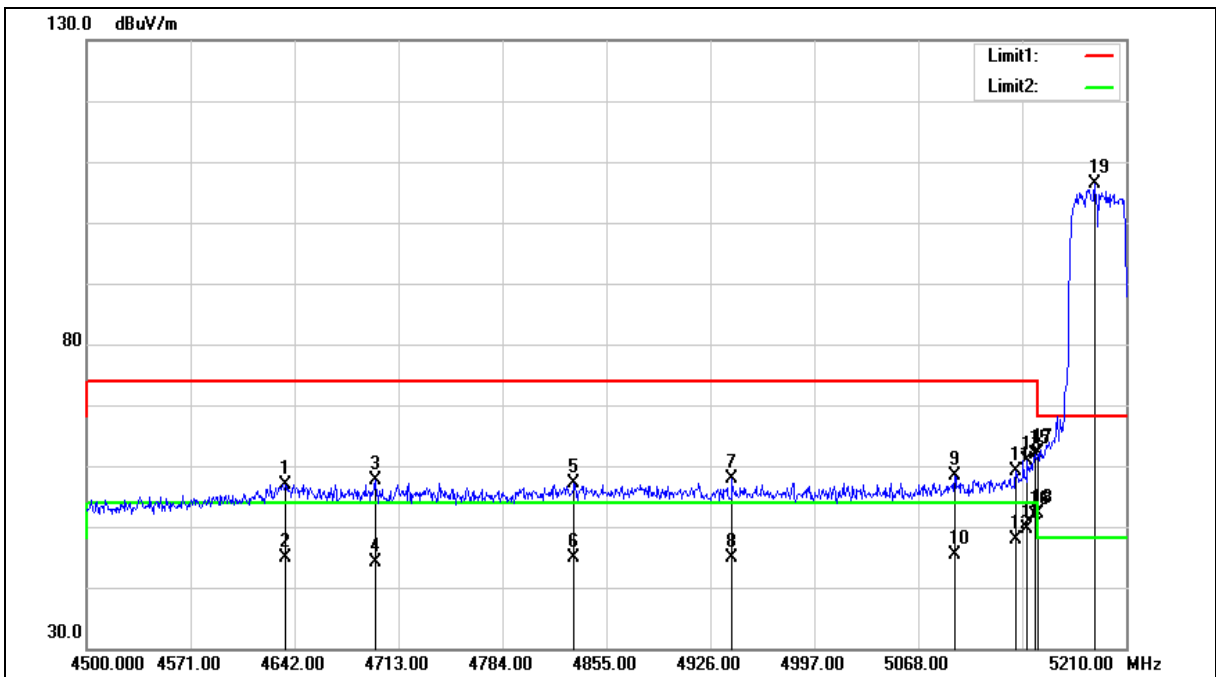



Standard:	FCC Part 15.407	Test Distance:	3m
Test item:	Band edge		
Frequency:	5190MHz		
Mode:	Mode 4		
Ant.Polar.:	Vertical		

No.	Frequency (MHz)	Reading (dBuV)	Correct Factor (dB/m)	Result (dBuV/m)	Limit (dBuV/m)	Margin (dB)	Remark
1	4635.610	51.59	5.39	56.98	74.00	-17.02	peak
2	4635.610	39.54	5.39	44.93	54.00	-9.07	AVG
3	4697.380	52.00	5.58	57.58	74.00	-16.42	peak
4	4697.380	38.62	5.58	44.20	54.00	-9.80	AVG
5	4832.990	51.22	5.99	57.21	74.00	-16.79	peak
6	4832.990	38.93	5.99	44.92	54.00	-9.08	AVG
7	4940.910	51.44	6.33	57.77	74.00	-16.23	peak
8	4940.910	38.56	6.33	44.89	54.00	-9.11	AVG
9	5092.850	51.53	6.77	58.30	74.00	-15.70	peak
10	5092.850	38.61	6.77	45.38	54.00	-8.62	AVG
11	5134.740	52.20	6.89	59.09	74.00	-14.91	peak
12	5134.740	40.96	6.89	47.85	54.00	-6.15	AVG
13	5142.550	53.93	6.92	60.85	74.00	-13.15	peak
14	5142.550	42.63	6.92	49.55	54.00	-4.45	AVG
15	5148.230	54.82	6.94	61.76	74.00	-12.24	peak
16	5148.230	44.82	6.94	51.76	54.00	-2.24	AVG
17	5150.000	55.26	6.94	62.20	74.00	-11.80	peak
18	5150.000	45.12	6.94	52.06	54.00	-1.94	AVG
19	5188.700	99.23	7.05	106.28	--	--	peak

Note:1.Result (dBuV/m) = Correct Factor (dB/m) + Reading(dBuV).

2.Correction factor (dB/m) = Antenna Factor (dB/m) + Cable loss (dB) – Pre-Amplifier gain (dB).

3.When the peak results are less than average limit, so not need to evaluate the average.

Standard:	FCC Part 15.407	Test Distance:	3m
Test item:	Band edge		
Frequency:	5230MHz		
Mode:	Mode 4		
Ant.Polar.:	Horizontal		

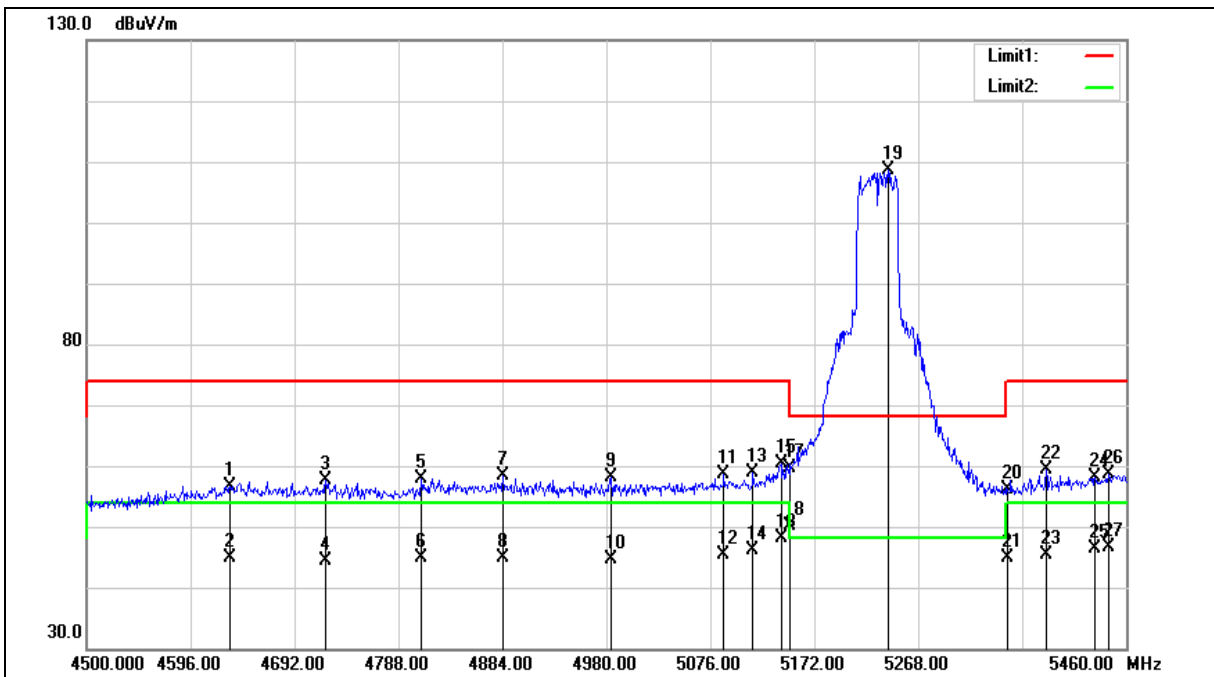

No.	Frequency (MHz)	Reading (dBuV)	Correct Factor (dB/m)	Result (dBuV/m)	Limit (dBuV/m)	Margin (dB)	Remark
1	4632.480	51.32	5.38	56.70	74.00	-17.30	peak
2	4632.480	39.50	5.38	44.88	54.00	-9.12	AVG
3	4720.800	51.98	5.66	57.64	74.00	-16.36	peak
4	4720.800	38.79	5.66	44.45	54.00	-9.55	AVG
5	4809.120	51.98	5.93	57.91	74.00	-16.09	peak

Note:1.Result (dBuV/m) = Correct Factor (dB/m) + Reading(dBuV).

2.Correction factor (dB/m) = Antenna Factor (dB/m) + Cable loss (dB) – Pre-Amplifier gain (dB).

3.When the peak results are less than average limit, so not need to evaluate the average.



Standard:	FCC Part 15.407	Test Distance:	3m
Test item:	Band edge		
Frequency:	5230MHz		
Mode:	Mode 4		
Ant.Polar.:	Horizontal		

No.	Frequency (MHz)	Reading (dBuV)	Correct Factor (dB/m)	Result (dBuV/m)	Limit (dBuV/m)	Margin (dB)	Remark
6	4809.120	38.88	5.93	44.81	54.00	-9.19	AVG
7	4884.000	52.23	6.15	58.38	74.00	-15.62	peak
8	4884.000	38.83	6.15	44.98	54.00	-9.02	AVG
9	4984.800	51.78	6.47	58.25	74.00	-15.75	peak
10	4984.800	38.25	6.47	44.72	54.00	-9.28	AVG
11	5088.480	51.80	6.76	58.56	74.00	-15.44	peak
12	5088.480	38.65	6.76	45.41	54.00	-8.59	AVG
13	5115.360	52.01	6.84	58.85	74.00	-15.15	peak
14	5115.360	39.17	6.84	46.01	54.00	-7.99	AVG
15	5141.280	53.58	6.91	60.49	74.00	-13.51	peak
16	5141.280	41.20	6.91	48.11	54.00	-5.89	AVG
17	5150.000	52.69	6.94	59.63	74.00	-14.37	peak
18	5150.000	43.14	6.94	50.08	54.00	-3.92	AVG
19	5240.160	101.51	7.19	108.70	--	--	peak
20	5350.000	48.58	7.50	56.08	74.00	-17.92	peak
21	5350.000	37.34	7.50	44.84	54.00	-9.16	AVG
22	5386.080	51.80	7.61	59.41	74.00	-14.59	peak
23	5386.080	37.84	7.61	45.45	54.00	-8.55	AVG
24	5431.200	50.46	7.74	58.20	74.00	-15.80	peak
25	5431.200	38.65	7.74	46.39	54.00	-7.61	AVG
26	5443.680	50.79	7.77	58.56	74.00	-15.44	peak
27	5443.680	38.81	7.77	46.58	54.00	-7.42	AVG

Note:1.Result (dBuV/m) = Correct Factor (dB/m) + Reading(dBuV).

2.Correction factor (dB/m) = Antenna Factor (dB/m) + Cable loss (dB) – Pre-Amplifier gain (dB).

3.When the peak results are less than average limit, so not need to evaluate the average.



Standard:	FCC Part 15.407	Test Distance:	3m
Test item:	Band edge		
Frequency:	5230MHz		
Mode:	Mode 4		
Ant.Polar.:	Vertical		

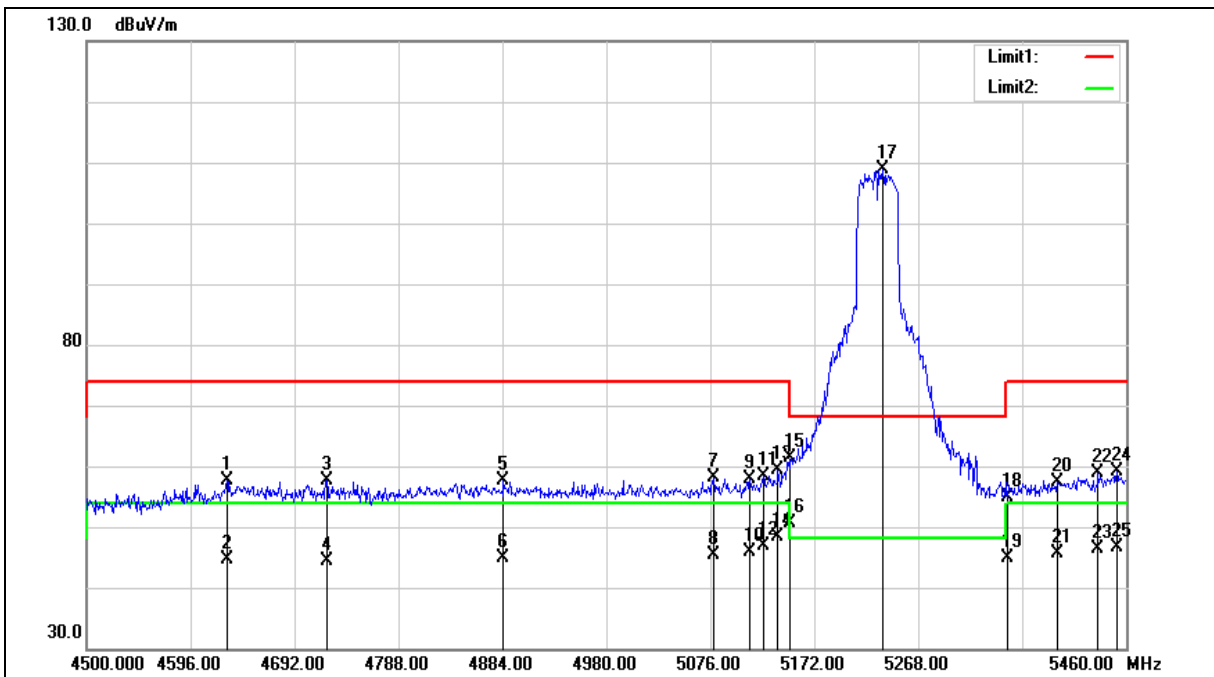

No.	Frequency (MHz)	Reading (dBuV)	Correct Factor (dB/m)	Result (dBuV/m)	Limit (dBuV/m)	Margin (dB)	Remark
1	4629.600	52.23	5.38	57.61	74.00	-16.39	peak
2	4629.600	39.30	5.38	44.68	54.00	-9.32	AVG
3	4721.760	51.92	5.67	57.59	74.00	-16.41	peak
4	4721.760	38.79	5.67	44.46	54.00	-9.54	AVG
5	4884.960	51.40	6.16	57.56	74.00	-16.44	peak

Note:1.Result (dBuV/m) = Correct Factor (dB/m) + Reading(dBuV).

2.Correction factor (dB/m) = Antenna Factor (dB/m) + Cable loss (dB) – Pre-Amplifier gain (dB).

3.When the peak results are less than average limit, so not need to evaluate the average.



Standard:	FCC Part 15.407	Test Distance:	3m
Test item:	Band edge		
Frequency:	5230MHz		
Mode:	Mode 4		
Ant.Polar.:	Vertical		

No.	Frequency (MHz)	Reading (dBuV)	Correct Factor (dB/m)	Result (dBuV/m)	Limit (dBuV/m)	Margin (dB)	Remark
6	4884.960	38.82	6.16	44.98	54.00	-9.02	AVG
7	5078.880	51.30	6.73	58.03	74.00	-15.97	peak
8	5078.880	38.66	6.73	45.39	54.00	-8.61	AVG
9	5112.480	50.95	6.82	57.77	74.00	-16.23	peak
10	5112.480	39.18	6.82	46.00	54.00	-8.00	AVG
11	5124.960	51.46	6.85	58.31	74.00	-15.69	peak
12	5124.960	39.91	6.85	46.76	54.00	-7.24	AVG
13	5138.400	52.41	6.91	59.32	74.00	-14.68	peak
14	5138.400	41.47	6.91	48.38	54.00	-5.62	AVG
15	5150.000	54.39	6.94	61.33	74.00	-12.67	peak
16	5150.000	43.64	6.94	50.58	54.00	-3.42	AVG
17	5235.360	101.75	7.18	108.93	--	--	peak
18	5350.000	47.39	7.50	54.89	74.00	-19.11	peak
19	5350.000	37.45	7.50	44.95	54.00	-9.05	AVG
20	5396.640	49.70	7.64	57.34	74.00	-16.66	peak
21	5396.640	38.07	7.64	45.71	54.00	-8.29	AVG
22	5434.080	51.19	7.74	58.93	74.00	-15.07	peak
23	5434.080	38.61	7.74	46.35	54.00	-7.65	AVG
24	5451.360	51.26	7.79	59.05	74.00	-14.95	peak
25	5451.360	38.73	7.79	46.52	54.00	-7.48	AVG

Note:1.Result (dBuV/m) = Correct Factor (dB/m) + Reading(dBuV).

2.Correction factor (dB/m) = Antenna Factor (dB/m) + Cable loss (dB) – Pre-Amplifier gain (dB).

3.When the peak results are less than average limit, so not need to evaluate the average.



Standard:	FCC Part 15.407	Test Distance:	3m
Test item:	Band edge		
Frequency:	5755MHz		
Mode:	Mode 4		
Ant.Polar.:	Horizontal		

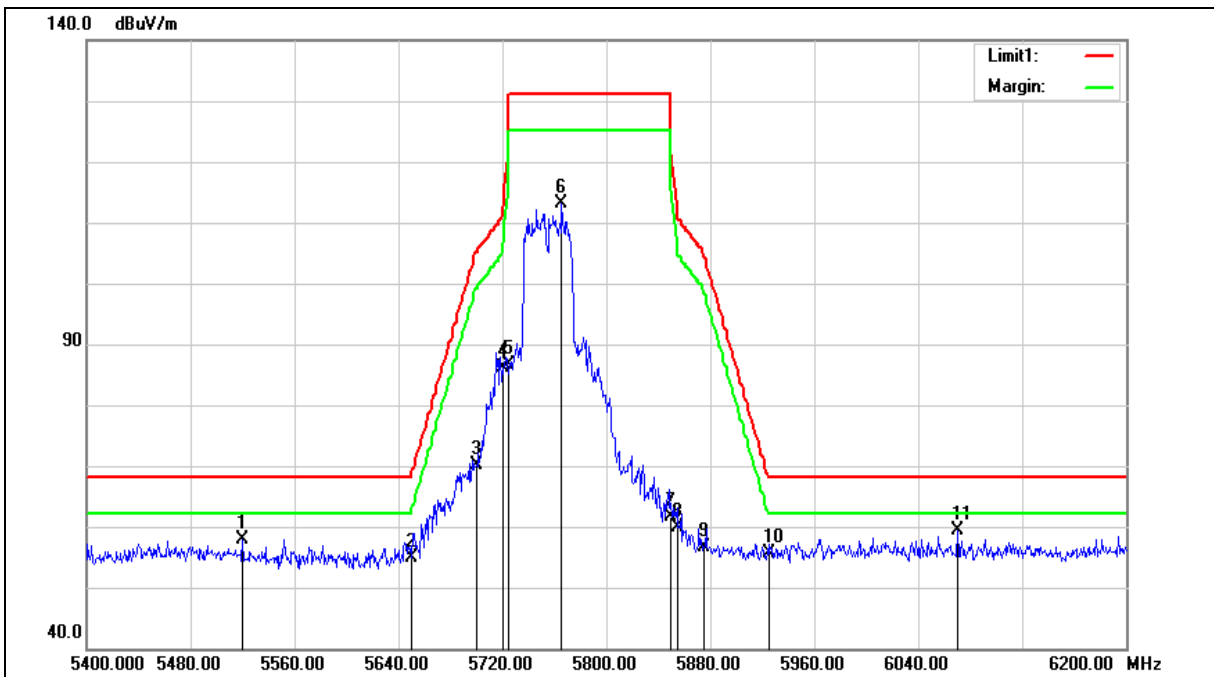



Standard:	FCC Part 15.407	Test Distance:	3m
Test item:	Band edge		
Frequency:	5755MHz		
Mode:	Mode 4		
Ant.Polar.:	Horizontal		

No.	Frequency (MHz)	Reading (dBuV)	Correct Factor (dB/m)	Result (dBuV/m)	Limit (dBuV/m)	Margin (dB)	Remark
1	5520.000	51.86	6.07	57.93	68.20	-10.27	peak
2	5650.000	48.67	6.31	54.98	68.20	-13.22	peak
3	5700.000	63.73	6.40	70.13	105.20	-35.07	peak
4	5720.000	79.69	6.44	86.13	110.80	-24.67	peak
5	5725.000	80.27	6.45	86.72	122.20	-35.48	peak
6	5765.600	106.56	6.52	113.08	--	--	peak
7	5850.000	55.00	6.67	61.67	122.20	-60.53	peak
8	5855.000	53.23	6.67	59.90	110.80	-50.90	peak
9	5875.000	49.95	6.72	56.67	105.20	-48.53	peak
10	5925.000	48.88	6.80	55.68	68.20	-12.52	peak
11	6070.400	52.16	7.15	59.31	68.20	-8.89	peak

Note:1.Result (dBuV/m) = Correct Factor (dB/m) + Reading(dBuV).

2.Correction factor (dB/m) = Antenna Factor (dB/m) + Cable loss (dB) – Pre-Amplifier gain (dB).

3.When the peak results are less than average limit, so not need to evaluate the average.



Standard:	FCC Part 15.407	Test Distance:	3m
Test item:	Band edge		
Frequency:	5755MHz		
Mode:	Mode 4		
Ant.Polar.:	Vertical		

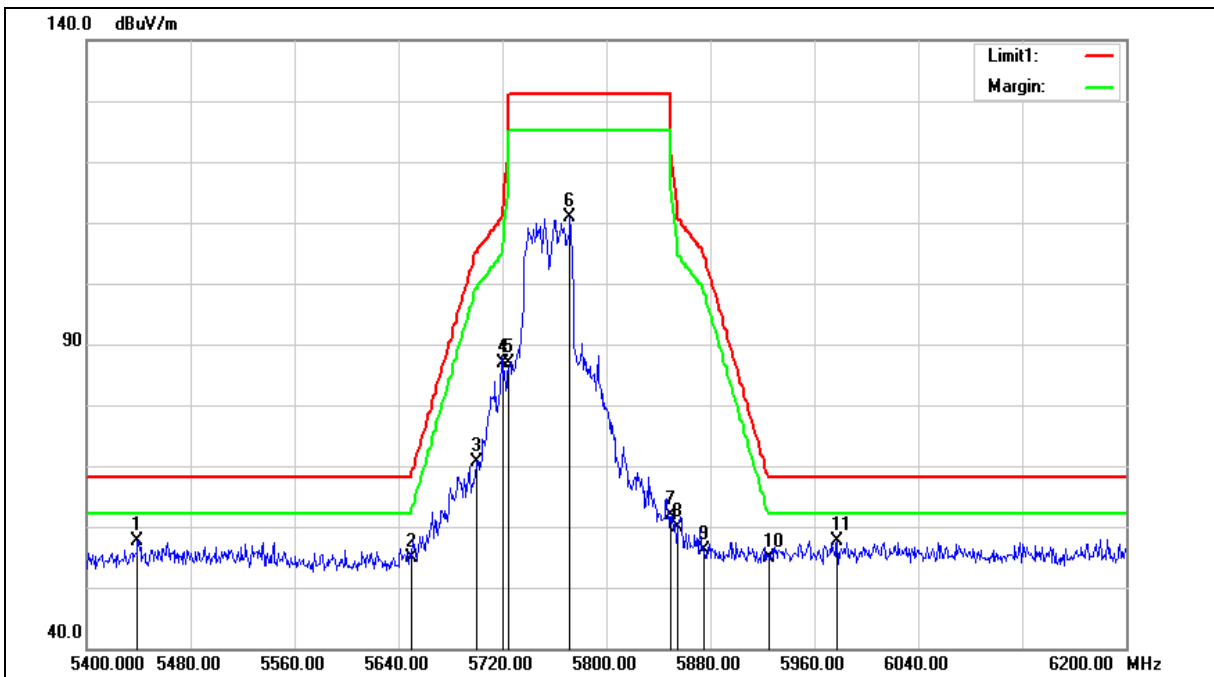



Standard:	FCC Part 15.407	Test Distance:	3m
Test item:	Band edge		
Frequency:	5755MHz		
Mode:	Mode 4		
Ant.Polar.:	Vertical		

No.	Frequency (MHz)	Reading (dBuV)	Correct Factor (dB/m)	Result (dBuV/m)	Limit (dBuV/m)	Margin (dB)	Remark
1	5439.200	51.86	5.88	57.74	68.20	-10.46	peak
2	5650.000	48.48	6.31	54.79	68.20	-13.41	peak
3	5700.000	64.32	6.40	70.72	105.20	-34.48	peak
4	5720.000	80.36	6.44	86.80	110.80	-24.00	peak
5	5725.000	80.35	6.45	86.80	122.20	-35.40	peak
6	5772.000	104.28	6.53	110.81	--	--	peak
7	5850.000	55.25	6.67	61.92	122.20	-60.28	peak
8	5855.000	53.19	6.67	59.86	110.80	-50.94	peak
9	5875.000	49.50	6.72	56.22	105.20	-48.98	peak
10	5925.000	48.05	6.80	54.85	68.20	-13.35	peak
11	5977.600	50.84	6.90	57.74	68.20	-10.46	peak

Note:1.Result (dBuV/m) = Correct Factor (dB/m) + Reading(dBuV).

2.Correction factor (dB/m) = Antenna Factor (dB/m) + Cable loss (dB) – Pre-Amplifier gain (dB).

3.When the peak results are less than average limit, so not need to evaluate the average.



Standard:	FCC Part 15.407	Test Distance:	3m
Test item:	Band edge		
Frequency:	5795MHz		
Mode:	Mode 4		
Ant.Polar.:	Horizontal		

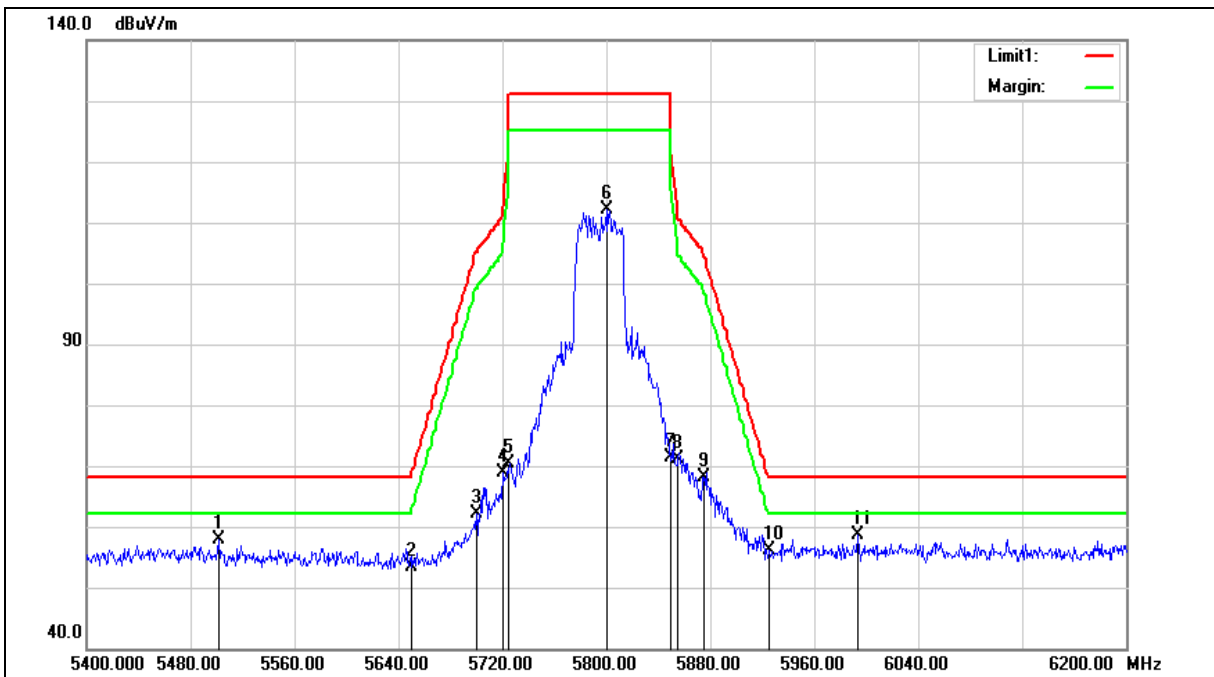



Standard:	FCC Part 15.407	Test Distance:	3m
Test item:	Band edge		
Frequency:	5795MHz		
Mode:	Mode 4		
Ant.Polar.:	Horizontal		

No.	Frequency (MHz)	Reading (dBuV)	Correct Factor (dB/m)	Result (dBuV/m)	Limit (dBuV/m)	Margin (dB)	Remark
1	5501.600	51.75	6.03	57.78	68.20	-10.42	peak
2	5650.000	46.98	6.31	53.29	68.20	-14.91	peak
3	5700.000	55.84	6.40	62.24	105.20	-42.96	peak
4	5720.000	62.47	6.44	68.91	110.80	-41.89	peak
5	5725.000	63.89	6.45	70.34	122.20	-51.86	peak
6	5800.000	105.47	6.57	112.04	--	--	peak
7	5850.000	64.75	6.67	71.42	122.20	-50.78	peak
8	5855.000	64.52	6.67	71.19	110.80	-39.61	peak
9	5875.000	61.51	6.72	68.23	105.20	-36.97	peak
10	5925.000	49.44	6.80	56.24	68.20	-11.96	peak
11	5993.600	51.76	6.92	58.68	68.20	-9.52	peak

Note:1.Result (dBuV/m) = Correct Factor (dB/m) + Reading(dBuV).

2.Correction factor (dB/m) = Antenna Factor (dB/m) + Cable loss (dB) – Pre-Amplifier gain (dB).

3.When the peak results are less than average limit, so not need to evaluate the average.



Standard:	FCC Part 15.407	Test Distance:	3m
Test item:	Band edge		
Frequency:	5795MHz		
Mode:	Mode 4		
Ant.Polar.:	Vertical		

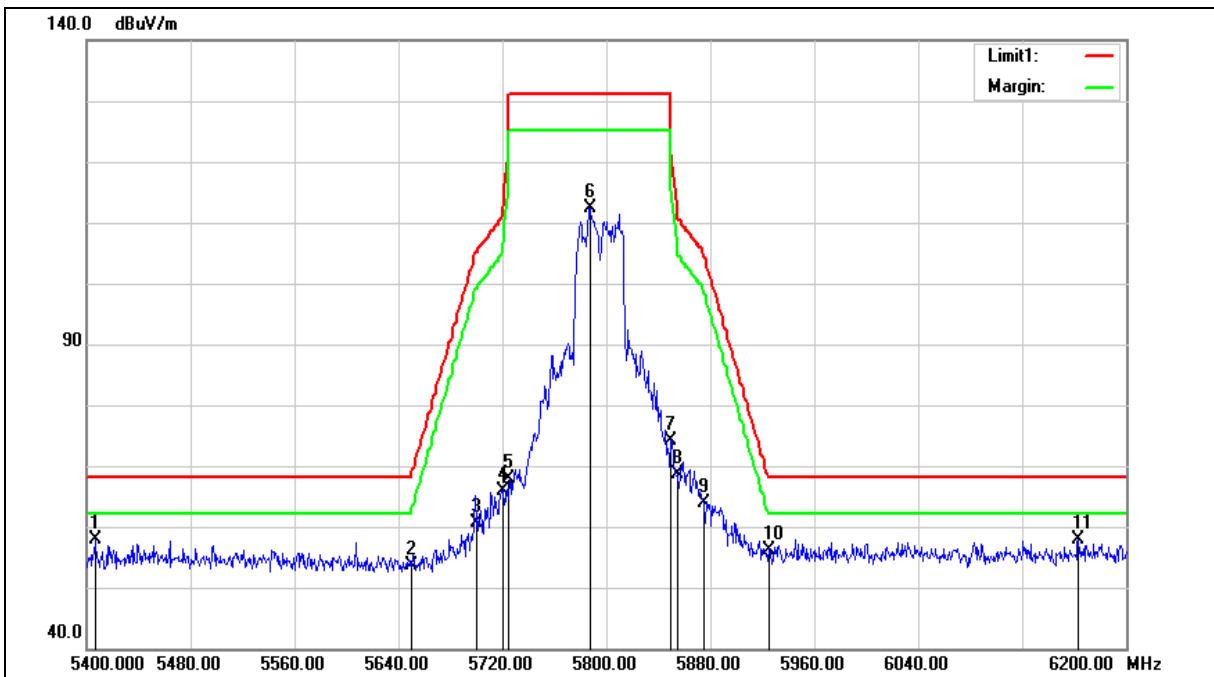



Standard:	FCC Part 15.407	Test Distance:	3m
Test item:	Band edge		
Frequency:	5795MHz		
Mode:	Mode 4		
Ant.Polar.:	Vertical		

No.	Frequency (MHz)	Reading (dBuV)	Correct Factor (dB/m)	Result (dBuV/m)	Limit (dBuV/m)	Margin (dB)	Remark
1	5406.400	52.05	5.79	57.84	68.20	-10.36	peak
2	5650.000	47.32	6.31	53.63	68.20	-14.57	peak
3	5700.000	54.11	6.40	60.51	105.20	-44.69	peak
4	5720.000	59.39	6.44	65.83	110.80	-44.97	peak
5	5725.000	61.45	6.45	67.90	122.20	-54.30	peak
6	5787.200	105.79	6.56	112.35	--	--	peak
7	5850.000	67.41	6.67	74.08	122.20	-48.12	peak
8	5855.000	61.93	6.67	68.60	110.80	-42.20	peak
9	5875.000	57.16	6.72	63.88	105.20	-41.32	peak
10	5925.000	49.42	6.80	56.22	68.20	-11.98	peak
11	6163.200	50.41	7.41	57.82	68.20	-10.38	peak

Note:1.Result (dBuV/m) = Correct Factor (dB/m) + Reading(dBuV).

2.Correction factor (dB/m) = Antenna Factor (dB/m) + Cable loss (dB) – Pre-Amplifier gain (dB).

3.When the peak results are less than average limit, so not need to evaluate the average.



Standard:	FCC Part 15.407	Test Distance:	3m
Test item:	Band edge		
Frequency:	5210MHz		
Mode:	Mode 5		
Ant.Polar.:	Horizontal		

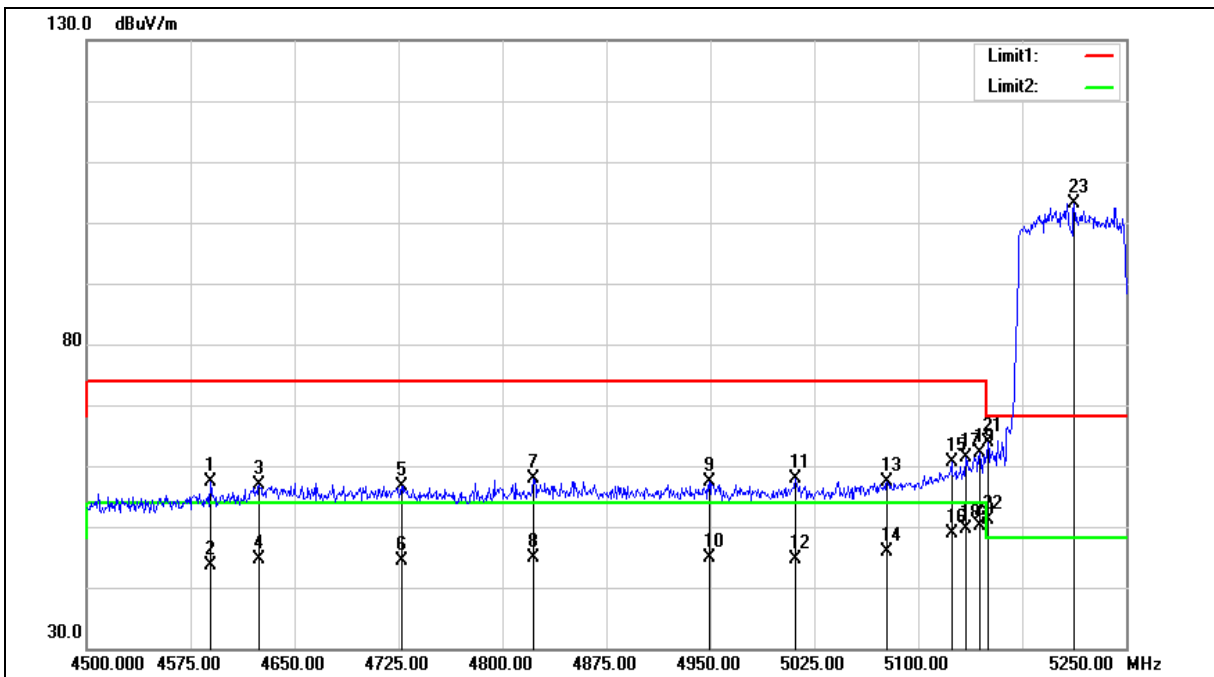



Standard:	FCC Part 15.407	Test Distance:	3m
Test item:	Band edge		
Frequency:	5210MHz		
Mode:	Mode 5		
Ant.Polar.:	Horizontal		

No.	Frequency (MHz)	Reading (dBuV)	Correct Factor (dB/m)	Result (dBuV/m)	Limit (dBuV/m)	Margin (dB)	Remark
1	4589.250	52.04	5.25	57.29	74.00	-16.71	peak
2	4589.250	38.42	5.25	43.67	54.00	-10.33	AVG
3	4624.500	51.59	5.36	56.95	74.00	-17.05	peak
4	4624.500	39.15	5.36	44.51	54.00	-9.49	AVG
5	4727.250	50.97	5.68	56.65	74.00	-17.35	peak
6	4727.250	38.77	5.68	44.45	54.00	-9.55	AVG
7	4822.500	51.86	5.97	57.83	74.00	-16.17	peak
8	4822.500	38.94	5.97	44.91	54.00	-9.09	AVG
9	4949.250	51.13	6.35	57.48	74.00	-16.52	peak
10	4949.250	38.43	6.35	44.78	54.00	-9.22	AVG
11	5011.500	51.36	6.54	57.90	74.00	-16.10	peak
12	5011.500	38.12	6.54	44.66	54.00	-9.34	AVG
13	5077.500	50.53	6.73	57.26	74.00	-16.74	peak
14	5077.500	39.13	6.73	45.86	54.00	-8.14	AVG
15	5124.000	53.83	6.85	60.68	74.00	-13.32	peak
16	5124.000	42.00	6.85	48.85	54.00	-5.15	AVG
17	5134.500	54.43	6.89	61.32	74.00	-12.68	peak
18	5134.500	42.79	6.89	49.68	54.00	-4.32	AVG
19	5144.250	55.25	6.92	62.17	74.00	-11.83	peak
20	5144.250	43.28	6.92	50.20	54.00	-3.80	AVG
21	5150.000	56.98	6.94	63.92	74.00	-10.08	peak
22	5150.000	44.11	6.94	51.05	54.00	-2.95	AVG
23	5212.500	96.07	7.11	103.18	--	--	peak

Note:1.Result (dBuV/m) = Correct Factor (dB/m) + Reading(dBuV).

2.Correction factor (dB/m) = Antenna Factor (dB/m) + Cable loss (dB) – Pre-Amplifier gain (dB).

3.When the peak results are less than average limit, so not need to evaluate the average.



Standard:	FCC Part 15.407	Test Distance:	3m
Test item:	Band edge		
Frequency:	5210MHz		
Mode:	Mode 5		
Ant.Polar.:	Vertical		

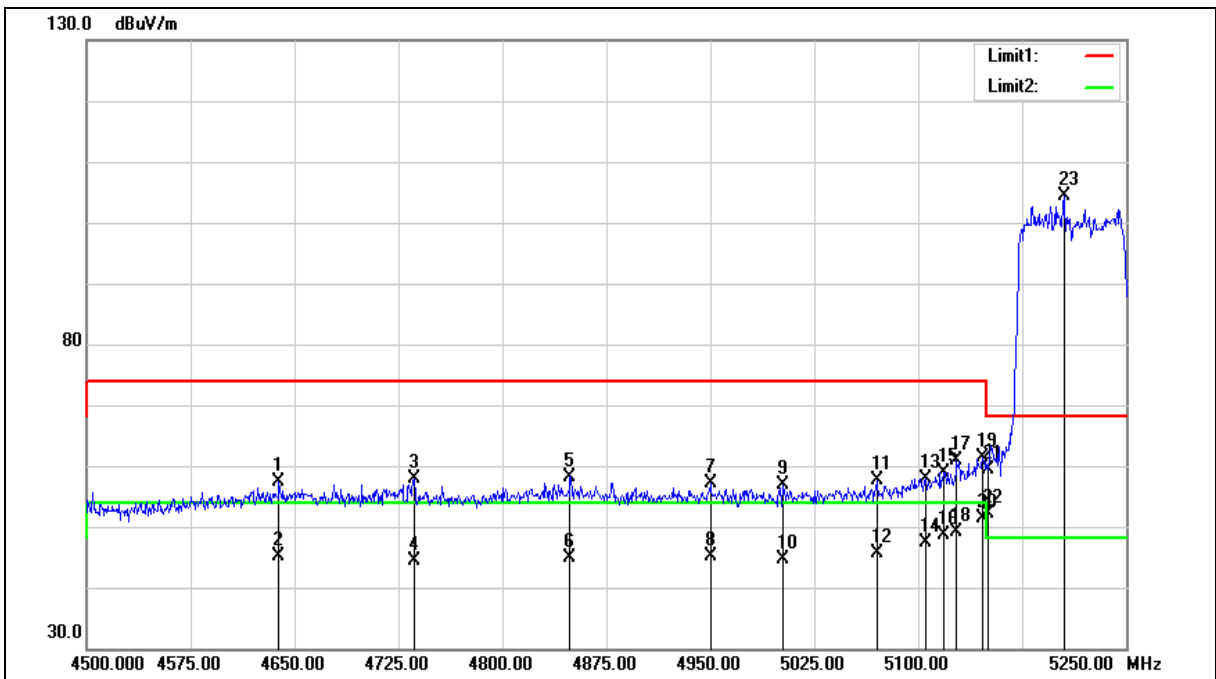



Standard:	FCC Part 15.407	Test Distance:	3m
Test item:	Band edge		
Frequency:	5210MHz		
Mode:	Mode 5		
Ant.Polar.:	Vertical		

No.	Frequency (MHz)	Reading (dBuV)	Correct Factor (dB/m)	Result (dBuV/m)	Limit (dBuV/m)	Margin (dB)	Remark
1	4638.750	52.02	5.41	57.43	74.00	-16.57	peak
2	4638.750	39.61	5.41	45.02	54.00	-8.98	AVG
3	4736.250	52.13	5.71	57.84	74.00	-16.16	peak
4	4736.250	38.56	5.71	44.27	54.00	-9.73	AVG
5	4848.750	52.01	6.05	58.06	74.00	-15.94	peak
6	4848.750	38.90	6.05	44.95	54.00	-9.05	AVG
7	4950.000	50.74	6.35	57.09	74.00	-16.91	peak
8	4950.000	38.78	6.35	45.13	54.00	-8.87	AVG
9	5002.500	50.31	6.51	56.82	74.00	-17.18	peak
10	5002.500	38.18	6.51	44.69	54.00	-9.31	AVG
11	5070.000	50.92	6.71	57.63	74.00	-16.37	peak
12	5070.000	38.85	6.71	45.56	54.00	-8.44	AVG
13	5105.250	51.18	6.81	57.99	74.00	-16.01	peak
14	5105.250	40.55	6.81	47.36	54.00	-6.64	AVG
15	5118.750	52.16	6.84	59.00	74.00	-15.00	peak
16	5118.750	41.76	6.84	48.60	54.00	-5.40	AVG
17	5127.750	54.05	6.88	60.93	74.00	-13.07	peak
18	5127.750	42.23	6.88	49.11	54.00	-4.89	AVG
19	5146.500	54.45	6.93	61.38	74.00	-12.62	peak
20	5146.500	44.41	6.93	51.34	54.00	-2.66	AVG
21	5150.000	52.45	6.94	59.39	74.00	-14.61	peak
22	5150.000	45.16	6.94	52.10	54.00	-1.90	AVG
23	5205.000	97.29	7.09	104.38	--	--	peak

Note:1.Result (dBuV/m) = Correct Factor (dB/m) + Reading(dBuV).

2.Correction factor (dB/m) = Antenna Factor (dB/m) + Cable loss (dB) – Pre-Amplifier gain (dB).

3.When the peak results are less than average limit, so not need to evaluate the average.



Standard:	FCC Part 15.407	Test Distance:	3m
Test item:	Band edge		
Frequency:	5775MHz		
Mode:	Mode 5		
Ant.Polar.:	Horizontal		

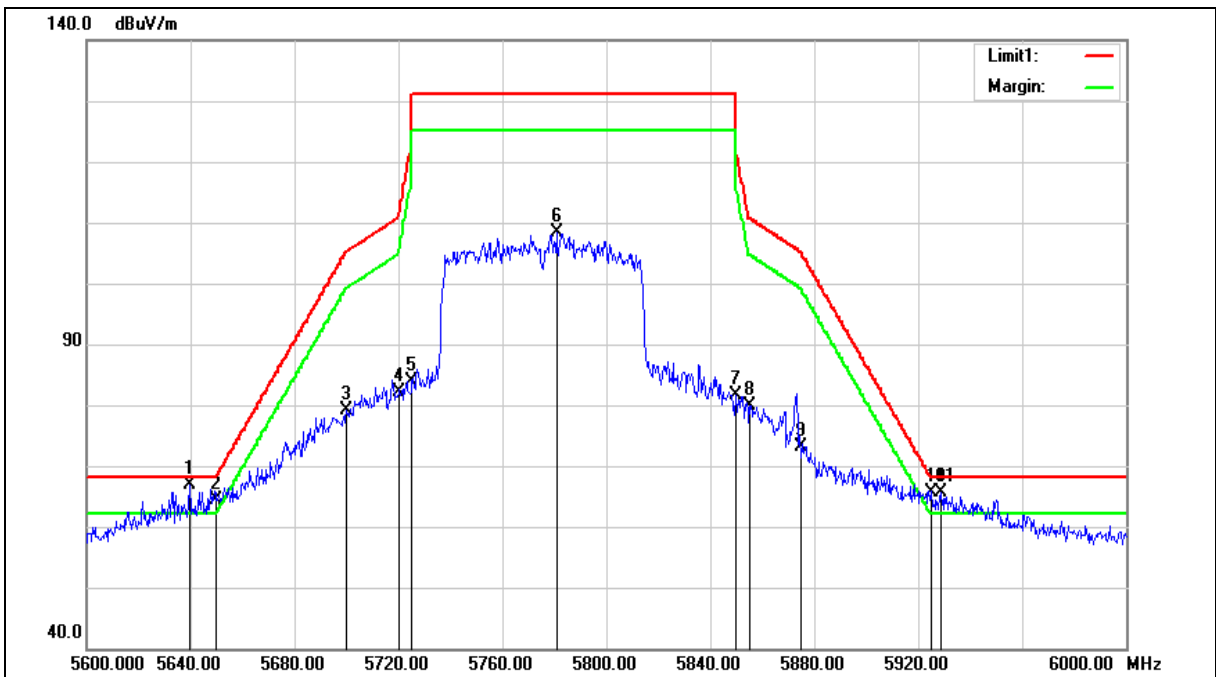



Standard:	FCC Part 15.407	Test Distance:	3m
Test item:	Band edge		
Frequency:	5775MHz		
Mode:	Mode 5		
Ant.Polar.:	Horizontal		

No.	Frequency (MHz)	Reading (dBuV)	Correct Factor (dB/m)	Result (dBuV/m)	Limit (dBuV/m)	Margin (dB)	Remark
1	5639.600	58.57	8.22	66.79	68.20	-1.41	peak
2	5650.000	56.15	8.24	64.39	68.20	-3.81	peak
3	5700.000	70.86	8.34	79.20	105.20	-26.00	peak
4	5720.000	73.71	8.38	82.09	110.80	-28.71	peak
5	5725.000	75.44	8.39	83.83	122.20	-38.37	peak
6	5780.800	99.79	8.50	108.29	--	--	peak
7	5850.000	72.88	8.63	81.51	122.20	-40.69	peak
8	5855.000	71.22	8.64	79.86	110.80	-30.94	peak
9	5875.000	64.37	8.69	73.06	105.20	-32.14	peak
10	5925.000	56.92	8.79	65.71	68.20	-2.49	peak
11	5928.800	56.89	8.80	65.69	68.20	-2.51	peak

Note:1.Result (dBuV/m) = Correct Factor (dB/m) + Reading(dBuV).

2.Correction factor (dB/m) = Antenna Factor (dB/m) + Cable loss (dB) – Pre-Amplifier gain (dB).

3.When the peak results are less than average limit, so not need to evaluate the average.



Standard:	FCC Part 15.407	Test Distance:	3m
Test item:	Band edge		
Frequency:	5775MHz		
Mode:	Mode 5		
Ant.Polar.:	Vertical		

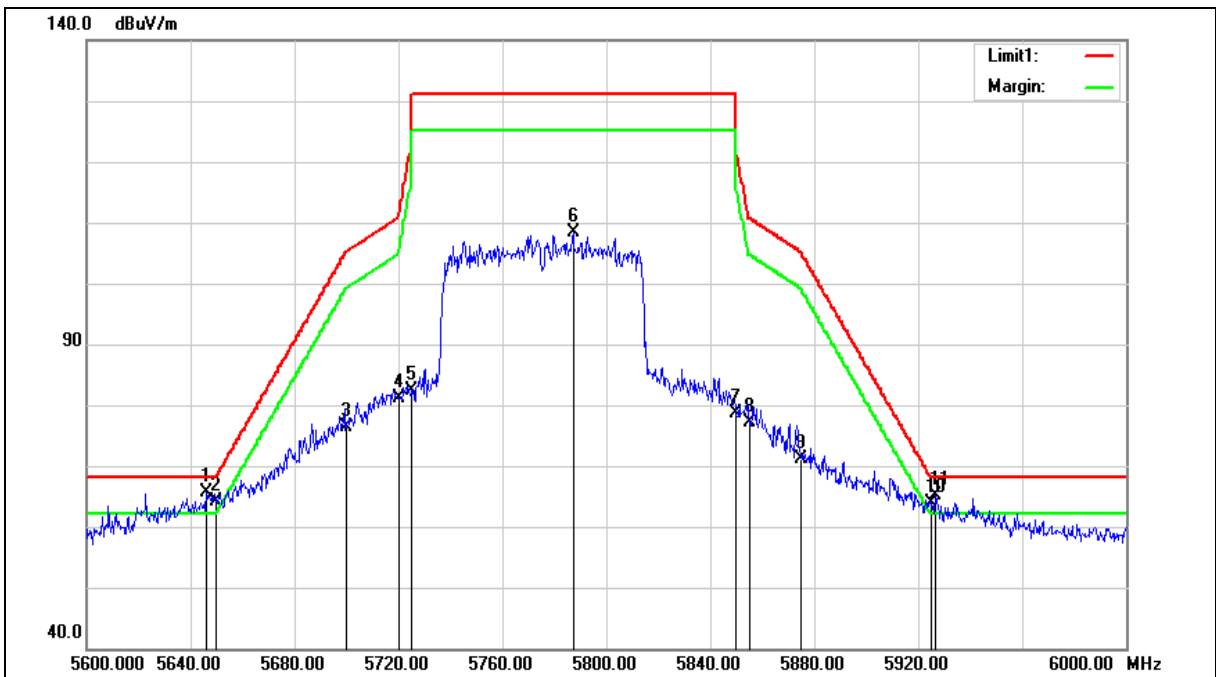



Standard:	FCC Part 15.407	Test Distance:	3m
Test item:	Band edge		
Frequency:	5775MHz		
Mode:	Mode 5		
Ant.Polar.:	Vertical		

No.	Frequency (MHz)	Reading (dBuV)	Correct Factor (dB/m)	Result (dBuV/m)	Limit (dBuV/m)	Margin (dB)	Remark
1	5646.000	57.43	8.23	65.66	68.20	-2.54	peak
2	5650.000	56.00	8.24	64.24	68.20	-3.96	peak
3	5700.000	68.16	8.34	76.50	105.20	-28.70	peak
4	5720.000	72.69	8.38	81.07	110.80	-29.73	peak
5	5725.000	73.97	8.39	82.36	122.20	-39.84	peak
6	5787.200	99.97	8.51	108.48	--	--	peak
7	5850.000	70.10	8.63	78.73	122.20	-43.47	peak
8	5855.000	68.53	8.64	77.17	110.80	-33.63	peak
9	5875.000	62.38	8.69	71.07	105.20	-34.13	peak
10	5925.000	55.01	8.79	63.80	68.20	-4.40	peak
11	5926.800	56.38	8.80	65.18	68.20	-3.02	peak

Note:1.Result (dBuV/m) = Correct Factor (dB/m) + Reading(dBuV).

2.Correction factor (dB/m) = Antenna Factor (dB/m) + Cable loss (dB) – Pre-Amplifier gain (dB).

3.When the peak results are less than average limit, so not need to evaluate the average.



Standard:	FCC Part 15.407	Test Distance:	3m
Test item:	Band edge		
Frequency:	5180MHz		
Mode:	Mode 6		
Ant.Polar.:	Horizontal		

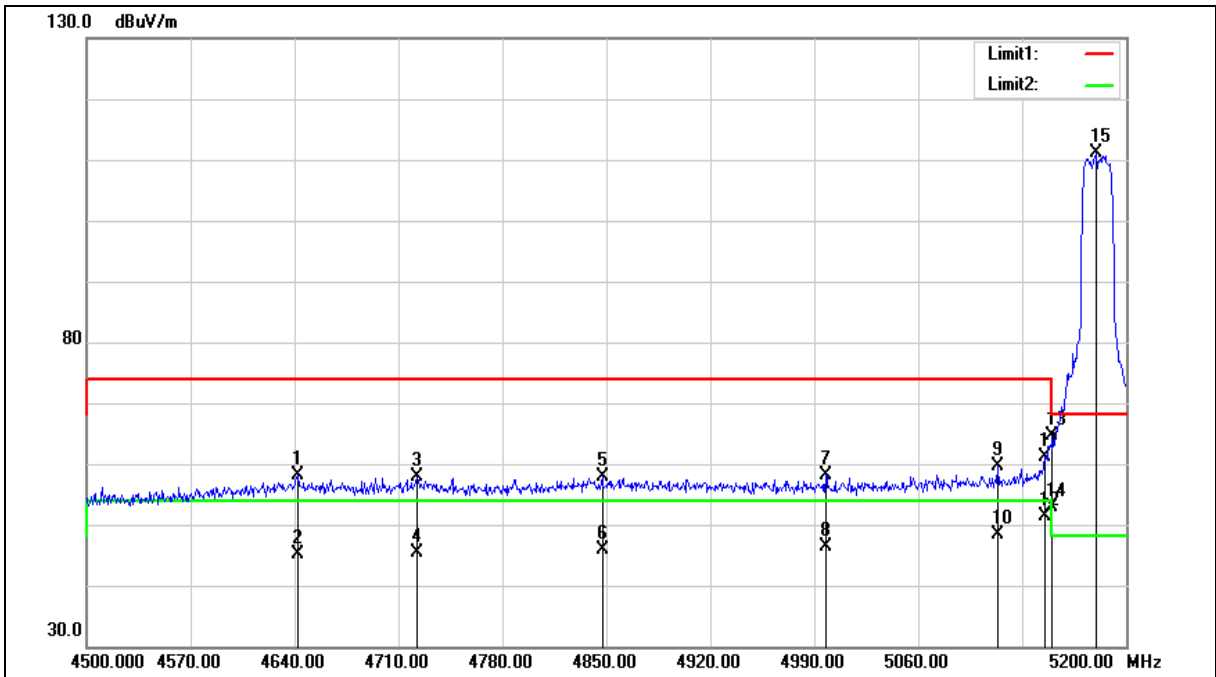



Standard:	FCC Part 15.407	Test Distance:	3m
Test item:	Band edge		
Frequency:	5180MHz		
Mode:	Mode 6		
Ant.Polar.:	Horizontal		

No.	Frequency (MHz)	Reading (dBuV)	Correct Factor (dB/m)	Result (dBuV/m)	Limit (dBuV/m)	Margin (dB)	Remark
1	4642.100	52.62	5.41	58.03	74.00	-15.97	peak
2	4642.100	39.68	5.41	45.09	54.00	-8.91	AVG
3	4722.600	52.17	5.67	57.84	74.00	-16.16	peak
4	4722.600	39.71	5.67	45.38	54.00	-8.62	AVG
5	4847.200	51.91	6.04	57.95	74.00	-16.05	peak
6	4847.200	39.85	6.04	45.89	54.00	-8.11	AVG
7	4997.700	51.58	6.50	58.08	74.00	-15.92	peak
8	4997.700	39.99	6.50	46.49	54.00	-7.51	AVG
9	5113.200	52.85	6.82	59.67	74.00	-14.33	peak
10	5113.200	41.58	6.82	48.40	54.00	-5.60	AVG
11	5145.400	54.20	6.93	61.13	74.00	-12.87	peak
12	5145.400	44.42	6.93	51.35	54.00	-2.65	AVG
13	5150.000	57.69	6.94	64.63	74.00	-9.37	peak
14	5150.000	45.92	6.94	52.86	54.00	-1.14	AVG
15	5179.700	104.12	7.02	111.14	--	--	peak

Note:1.Result (dBuV/m) = Correct Factor (dB/m) + Reading(dBuV).

2.Correction factor (dB/m) = Antenna Factor (dB/m) + Cable loss (dB) – Pre-Amplifier gain (dB).

3.When the peak results are less than average limit, so not need to evaluate the average.



Standard:	FCC Part 15.407	Test Distance:	3m
Test item:	Band edge		
Frequency:	5180MHz		
Mode:	Mode 6		
Ant.Polar.:	Vertical		

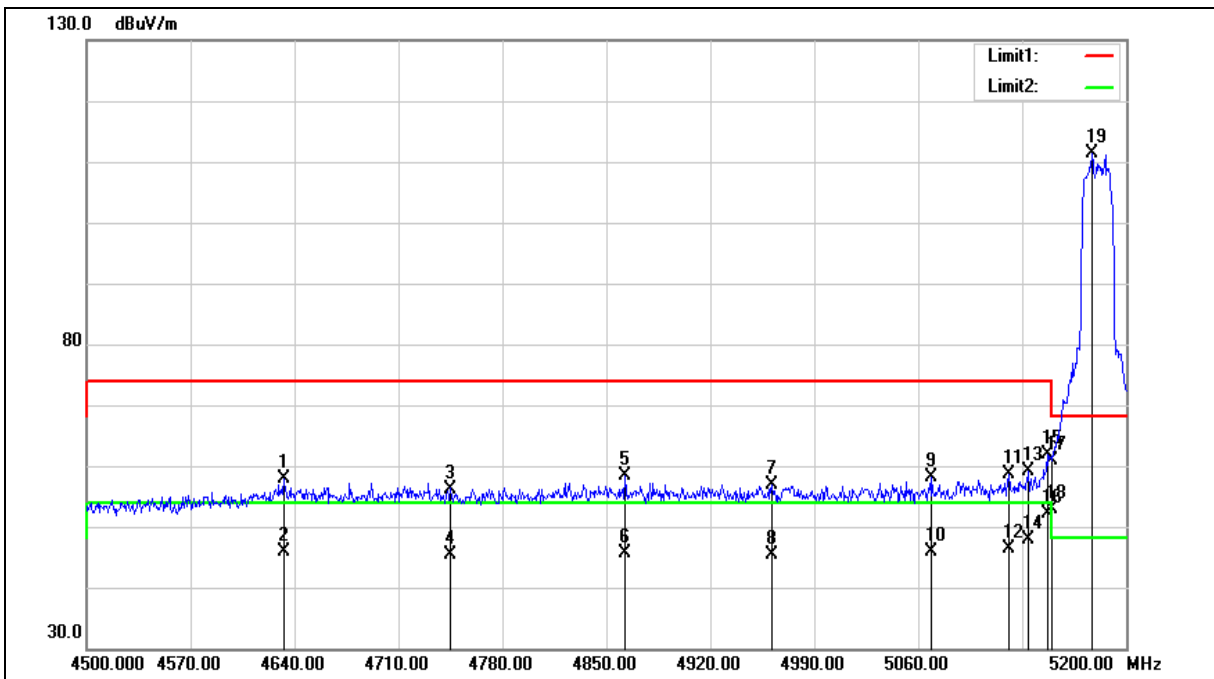



Standard:	FCC Part 15.407	Test Distance:	3m
Test item:	Band edge		
Frequency:	5180MHz		
Mode:	Mode 6		
Ant.Polar.:	Vertical		

No.	Frequency (MHz)	Reading (dBuV)	Correct Factor (dB/m)	Result (dBuV/m)	Limit (dBuV/m)	Margin (dB)	Remark
1	4633.000	52.47	5.38	57.85	74.00	-16.15	peak
2	4633.000	40.58	5.38	45.96	54.00	-8.04	AVG
3	4745.000	50.52	5.73	56.25	74.00	-17.75	peak
4	4745.000	39.53	5.73	45.26	54.00	-8.74	AVG
5	4862.600	52.19	6.09	58.28	74.00	-15.72	peak
6	4862.600	39.63	6.09	45.72	54.00	-8.28	AVG
7	4961.300	50.60	6.38	56.98	74.00	-17.02	peak
8	4961.300	39.10	6.38	45.48	54.00	-8.52	AVG
9	5069.100	51.37	6.70	58.07	74.00	-15.93	peak
10	5069.100	39.11	6.70	45.81	54.00	-8.19	AVG
11	5120.900	51.83	6.85	58.68	74.00	-15.32	peak
12	5120.900	39.60	6.85	46.45	54.00	-7.55	AVG
13	5134.200	52.16	6.89	59.05	74.00	-14.95	peak
14	5134.200	41.04	6.89	47.93	54.00	-6.07	AVG
15	5146.800	54.85	6.93	61.78	74.00	-12.22	peak
16	5146.800	45.29	6.93	52.22	54.00	-1.78	AVG
17	5150.000	53.88	6.94	60.82	74.00	-13.18	peak
18	5150.000	46.01	6.94	52.95	54.00	-1.05	AVG
19	5176.900	104.36	7.02	111.38	--	--	peak

Note:1.Result (dBuV/m) = Correct Factor (dB/m) + Reading(dBuV).

2.Correction factor (dB/m) = Antenna Factor (dB/m) + Cable loss (dB) – Pre-Amplifier gain (dB).

3.When the peak results are less than average limit, so not need to evaluate the average.



Standard:	FCC Part 15.407	Test Distance:	3m
Test item:	Band edge		
Frequency:	5200MHz		
Mode:	Mode 6		
Ant.Polar.:	Horizontal		

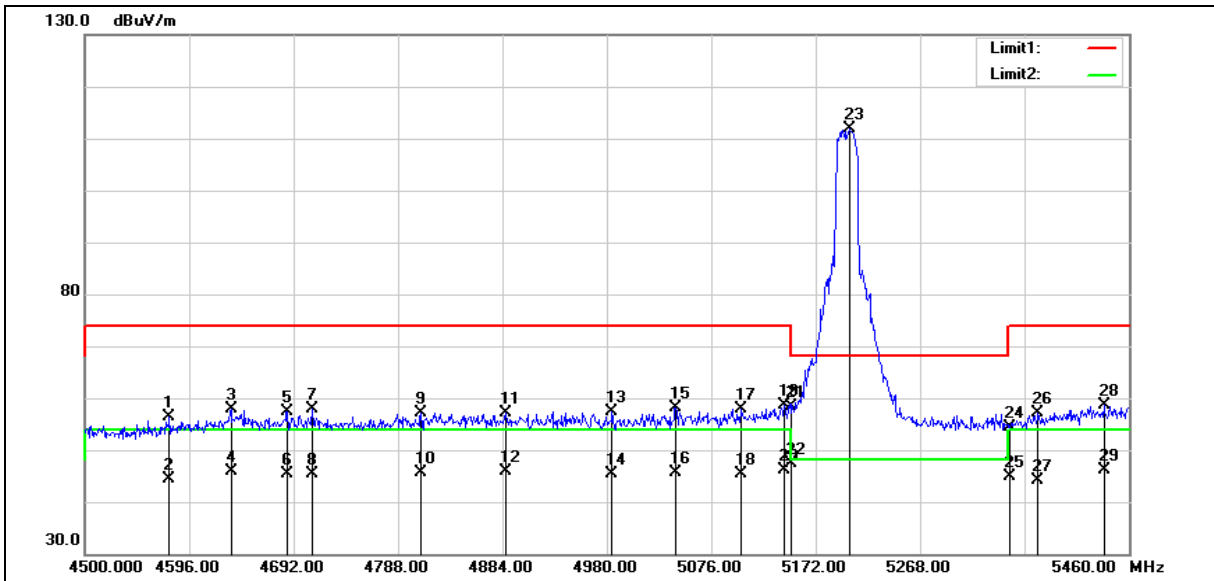

No.	Frequency (MHz)	Reading (dBuV)	Correct Factor (dB/m)	Result (dBuV/m)	Limit (dBuV/m)	Margin (dB)	Remark
1	4577.760	51.21	5.21	56.42	74.00	-17.58	peak
2	4577.760	39.24	5.21	44.45	54.00	-9.55	AVG
3	4634.400	52.60	5.39	57.99	74.00	-16.01	peak
4	4634.400	40.50	5.39	45.89	54.00	-8.11	AVG
5	4686.240	51.78	5.55	57.33	74.00	-16.67	peak

Note:1.Result (dBuV/m) = Correct Factor (dB/m) + Reading(dBuV).

2.Correction factor (dB/m) = Antenna Factor (dB/m) + Cable loss (dB) – Pre-Amplifier gain (dB).

3.When the peak results are less than average limit, so not need to evaluate the average.



Standard:	FCC Part 15.407	Test Distance:	3m
Test item:	Band edge		
Frequency:	5200MHz		
Mode:	Mode 6		
Ant.Polar.:	Horizontal		

No.	Frequency (MHz)	Reading (dBuV)	Correct Factor (dB/m)	Result (dBuV/m)	Limit (dBuV/m)	Margin (dB)	Remark
6	4686.240	39.80	5.55	45.35	54.00	-8.65	AVG
7	4709.280	52.16	5.62	57.78	74.00	-16.22	peak
8	4709.280	39.64	5.62	45.26	54.00	-8.74	AVG
9	4809.120	51.21	5.93	57.14	74.00	-16.86	peak
10	4809.120	39.60	5.93	45.53	54.00	-8.47	AVG
11	4886.880	51.07	6.16	57.23	74.00	-16.77	peak
12	4886.880	39.65	6.16	45.81	54.00	-8.19	AVG
13	4984.800	50.98	6.47	57.45	74.00	-16.55	peak
14	4984.800	39.02	6.47	45.49	54.00	-8.51	AVG
15	5043.360	51.58	6.63	58.21	74.00	-15.79	peak
16	5043.360	39.04	6.63	45.67	54.00	-8.33	AVG
17	5103.840	51.14	6.80	57.94	74.00	-16.06	peak
18	5103.840	38.54	6.80	45.34	54.00	-8.66	AVG
19	5143.200	51.64	6.92	58.56	74.00	-15.44	peak
20	5143.200	39.29	6.92	46.21	54.00	-7.79	AVG
21	5150.000	51.37	6.94	58.31	74.00	-15.69	peak
22	5150.000	40.33	6.94	47.27	54.00	-6.73	AVG
23	5203.680	104.77	7.09	111.86	--	--	peak
24	5350.000	46.98	7.50	54.48	74.00	-19.52	peak
25	5350.000	37.26	7.50	44.76	54.00	-9.24	AVG
26	5376.480	49.62	7.59	57.21	74.00	-16.79	peak
27	5376.480	36.44	7.59	44.03	54.00	-9.97	AVG
28	5436.960	50.90	7.76	58.66	74.00	-15.34	peak
29	5436.960	38.49	7.76	46.25	54.00	-7.75	AVG

Note:1.Result (dBuV/m) = Correct Factor (dB/m) + Reading(dBuV).

2.Correction factor (dB/m) = Antenna Factor (dB/m) + Cable loss (dB) – Pre-Amplifier gain (dB).

3.When the peak results are less than average limit, so not need to evaluate the average.



Standard:	FCC Part 15.407	Test Distance:	3m
Test item:	Band edge		
Frequency:	5200MHz		
Mode:	Mode 6		
Ant.Polar.:	Vertical		

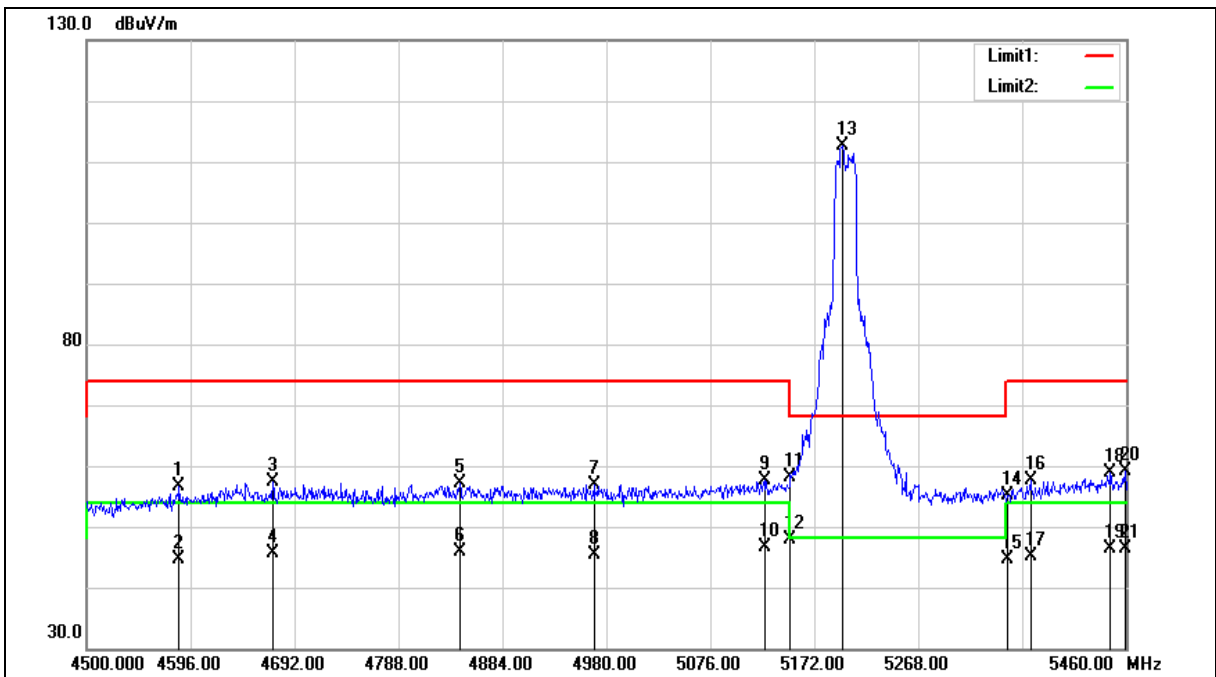



Standard:	FCC Part 15.407	Test Distance:	3m
Test item:	Band edge		
Frequency:	5200MHz		
Mode:	Mode 6		
Ant.Polar.:	Vertical		

No.	Frequency (MHz)	Reading (dBuV)	Correct Factor (dB/m)	Result (dBuV/m)	Limit (dBuV/m)	Margin (dB)	Remark
1	4585.440	51.49	5.24	56.73	74.00	-17.27	peak
2	4585.440	39.45	5.24	44.69	54.00	-9.31	AVG
3	4671.840	51.75	5.51	57.26	74.00	-16.74	peak
4	4671.840	40.20	5.51	45.71	54.00	-8.29	AVG
5	4844.640	51.13	6.04	57.17	74.00	-16.83	peak
6	4844.640	39.77	6.04	45.81	54.00	-8.19	AVG
7	4968.480	50.58	6.41	56.99	74.00	-17.01	peak
8	4968.480	39.08	6.41	45.49	54.00	-8.51	AVG
9	5125.920	50.66	6.88	57.54	74.00	-16.46	peak
10	5125.920	39.64	6.88	46.52	54.00	-7.48	AVG
11	5150.000	51.23	6.94	58.17	74.00	-15.83	peak
12	5150.000	41.06	6.94	48.00	54.00	-6.00	AVG
13	5197.920	105.63	7.08	112.71	--	--	peak
14	5350.000	47.73	7.50	55.23	74.00	-18.77	peak
15	5350.000	37.15	7.50	44.65	54.00	-9.35	AVG
16	5371.680	49.99	7.56	57.55	74.00	-16.45	peak
17	5371.680	37.47	7.56	45.03	54.00	-8.97	AVG
18	5445.600	51.04	7.78	58.82	74.00	-15.18	peak
19	5445.600	38.52	7.78	46.30	54.00	-7.70	AVG
20	5459.040	51.36	7.82	59.18	74.00	-14.82	peak
21	5459.040	38.60	7.82	46.42	54.00	-7.58	AVG

Note:1.Result (dBuV/m) = Correct Factor (dB/m) + Reading(dBuV).

2.Correction factor (dB/m) = Antenna Factor (dB/m) + Cable loss (dB) – Pre-Amplifier gain (dB).

3.When the peak results are less than average limit, so not need to evaluate the average.



Standard:	FCC Part 15.407	Test Distance:	3m
Test item:	Band edge		
Frequency:	5240MHz		
Ant.Polar.:	Horizontal		
Ant.Polar.:	Vertical		

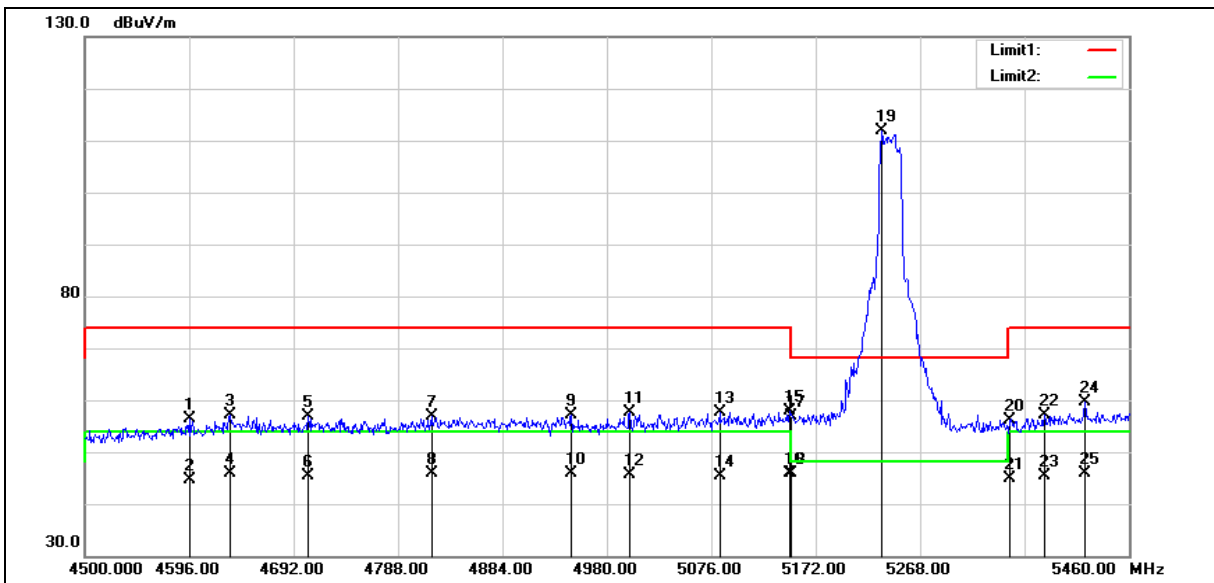

No.	Frequency (MHz)	Reading (dBuV)	Correct Factor (dB/m)	Result (dBuV/m)	Limit (dBuV/m)	Margin (dB)	Remark
1	4596.000	51.21	5.28	56.49	74.00	-17.51	peak
2	4596.000	39.39	5.28	44.67	54.00	-9.33	AVG
3	4633.440	51.74	5.38	57.12	74.00	-16.88	peak
4	4633.440	40.53	5.38	45.91	54.00	-8.09	AVG
5	4705.440	51.33	5.60	56.93	74.00	-17.07	peak

Note:1.Result (dBuV/m) = Correct Factor (dB/m) + Reading(dBuV).

2.Correction factor (dB/m) = Antenna Factor (dB/m) + Cable loss (dB) – Pre-Amplifier gain (dB).

3.When the peak results are less than average limit, so not need to evaluate the average.



Standard:	FCC Part 15.407	Test Distance:	3m
Test item:	Band edge		
Frequency:	5240MHz		
Ant.Polar.:	Horizontal		
Ant.Polar.:	Vertical		

No.	Frequency (MHz)	Reading (dBuV)	Correct Factor (dB/m)	Result (dBuV/m)	Limit (dBuV/m)	Margin (dB)	Remark
6	4705.440	39.78	5.60	45.38	54.00	-8.62	AVG
7	4818.720	50.88	5.95	56.83	74.00	-17.17	peak
8	4818.720	39.90	5.95	45.85	54.00	-8.15	AVG
9	4947.360	50.76	6.34	57.10	74.00	-16.90	peak
10	4947.360	39.46	6.34	45.80	54.00	-8.20	AVG
11	5001.120	51.12	6.51	57.63	74.00	-16.37	peak
12	5001.120	39.06	6.51	45.57	54.00	-8.43	AVG
13	5083.680	50.83	6.74	57.57	74.00	-16.43	peak
14	5083.680	38.56	6.74	45.30	54.00	-8.70	AVG
15	5148.000	50.90	6.94	57.84	74.00	-16.16	peak
16	5148.000	38.86	6.94	45.80	54.00	-8.20	AVG
17	5150.000	49.83	6.94	56.77	74.00	-17.23	peak
18	5150.000	38.91	6.94	45.85	54.00	-8.15	AVG
19	5232.480	104.67	7.17	111.84	--	--	peak
20	5350.000	48.68	7.50	56.18	74.00	-17.82	peak
21	5350.000	37.39	7.50	44.89	54.00	-9.11	AVG
22	5382.240	49.51	7.60	57.11	74.00	-16.89	peak
23	5382.240	37.69	7.60	45.29	54.00	-8.71	AVG
24	5419.680	51.83	7.71	59.54	74.00	-14.46	peak
25	5419.680	38.22	7.71	45.93	54.00	-8.07	AVG

Note:1.Result (dBuV/m) = Correct Factor (dB/m) + Reading(dBuV).

2.Correction factor (dB/m) = Antenna Factor (dB/m) + Cable loss (dB) – Pre-Amplifier gain (dB).

3.When the peak results are less than average limit, so not need to evaluate the average.



Standard:	FCC Part 15.407	Test Distance:	3m
Test item:	Band edge		
Frequency:	5240MHz		
Mode:	Mode 6		
Ant.Polar.:	Vertical		

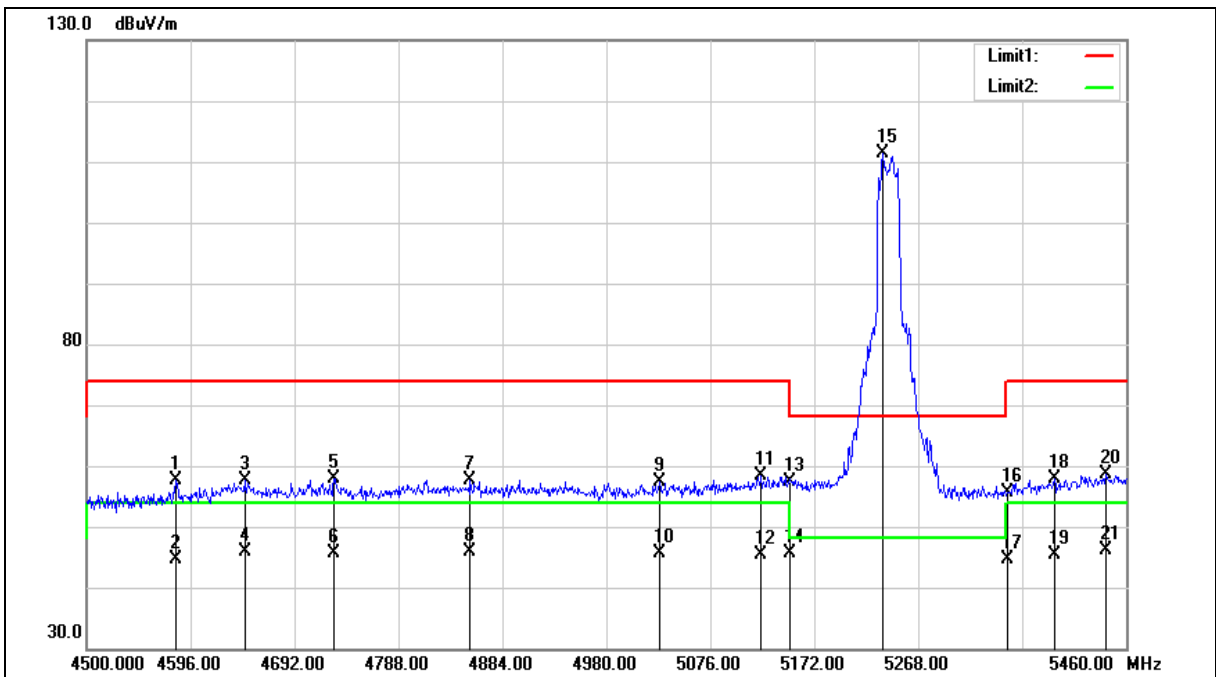



Standard:	FCC Part 15.407	Test Distance:	3m
Test item:	Band edge		
Frequency:	5240MHz		
Mode:	Mode 6		
Ant.Polar.:	Vertical		

No.	Frequency (MHz)	Reading (dBuV)	Correct Factor (dB/m)	Result (dBuV/m)	Limit (dBuV/m)	Margin (dB)	Remark
1	4582.560	52.39	5.23	57.62	74.00	-16.38	peak
2	4582.560	39.31	5.23	44.54	54.00	-9.46	AVG
3	4645.920	52.21	5.42	57.63	74.00	-16.37	peak
4	4645.920	40.56	5.42	45.98	54.00	-8.02	AVG
5	4728.480	52.32	5.68	58.00	74.00	-16.00	peak
6	4728.480	39.91	5.68	45.59	54.00	-8.41	AVG
7	4854.240	51.50	6.07	57.57	74.00	-16.43	peak
8	4854.240	39.72	6.07	45.79	54.00	-8.21	AVG
9	5028.960	50.87	6.59	57.46	74.00	-16.54	peak
10	5028.960	39.09	6.59	45.68	54.00	-8.32	AVG
11	5123.040	51.55	6.85	58.40	74.00	-15.60	peak
12	5123.040	38.64	6.85	45.49	54.00	-8.51	AVG
13	5150.000	50.36	6.94	57.30	74.00	-16.70	peak
14	5150.000	38.71	6.94	45.65	54.00	-8.35	AVG
15	5235.360	104.21	7.18	111.39	--	--	peak
16	5350.000	48.12	7.50	55.62	74.00	-18.38	peak
17	5350.000	37.01	7.50	44.51	54.00	-9.49	AVG
18	5393.760	50.32	7.63	57.95	74.00	-16.05	peak
19	5393.760	37.78	7.63	45.41	54.00	-8.59	AVG
20	5440.800	50.92	7.76	58.68	74.00	-15.32	peak
21	5440.800	38.48	7.76	46.24	54.00	-7.76	AVG

Note:1.Result (dBuV/m) = Correct Factor (dB/m) + Reading(dBuV).

2.Correction factor (dB/m) = Antenna Factor (dB/m) + Cable loss (dB) – Pre-Amplifier gain (dB).

3.When the peak results are less than average limit, so not need to evaluate the average.



Standard:	FCC Part 15.407	Test Distance:	3m
Test item:	Band edge		
Frequency:	5745MHz		
Mode:	Mode 6		
Ant.Polar.:	Horizontal		

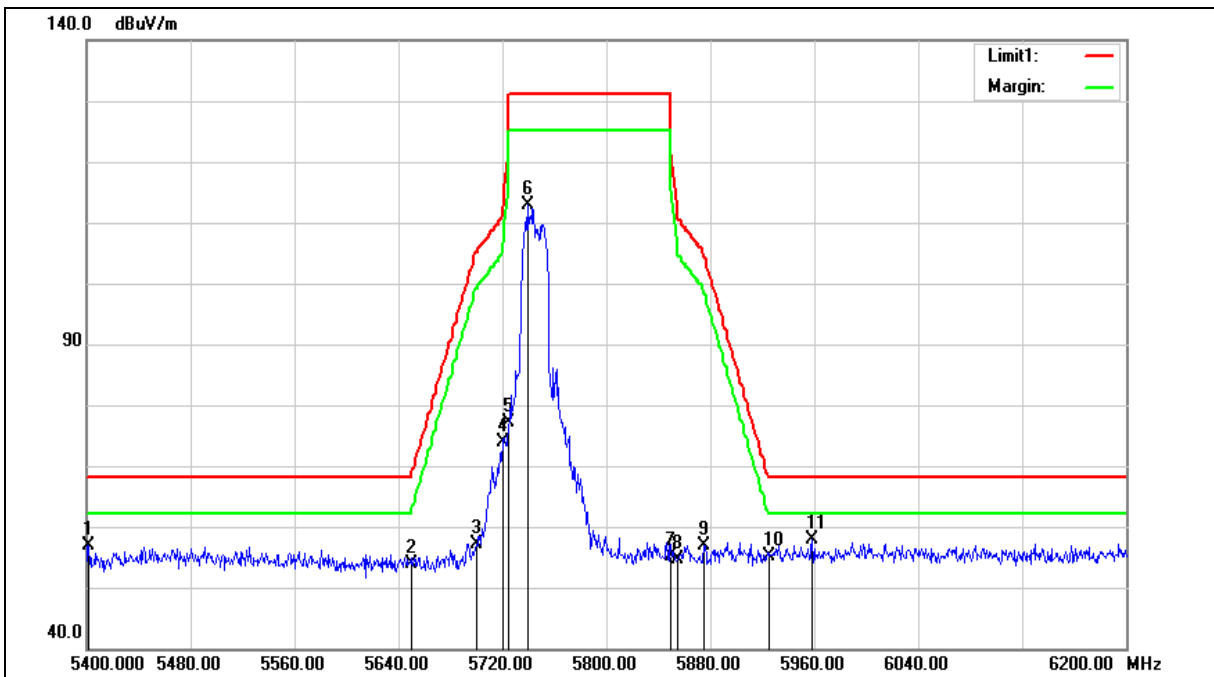



Standard:	FCC Part 15.407	Test Distance:	3m
Test item:	Band edge		
Frequency:	5745MHz		
Mode:	Mode 6		
Ant.Polar.:	Horizontal		

No.	Frequency (MHz)	Reading (dBuV)	Correct Factor (dB/m)	Result (dBuV/m)	Limit (dBuV/m)	Margin (dB)	Remark
1	5401.600	51.07	5.77	56.84	68.20	-11.36	peak
2	5650.000	47.67	6.31	53.98	68.20	-14.22	peak
3	5700.000	50.76	6.40	57.16	105.20	-48.04	peak
4	5720.000	67.55	6.44	73.99	110.80	-36.81	peak
5	5725.000	70.57	6.45	77.02	122.20	-45.18	peak
6	5739.200	106.46	6.46	112.92	--	--	peak
7	5850.000	48.51	6.67	55.18	122.20	-67.02	peak
8	5855.000	47.92	6.67	54.59	110.80	-56.21	peak
9	5875.000	50.22	6.72	56.94	105.20	-48.26	peak
10	5925.000	48.39	6.80	55.19	68.20	-13.01	peak
11	5958.400	51.09	6.87	57.96	68.20	-10.24	peak

Note:1.Result (dBuV/m) = Correct Factor (dB/m) + Reading(dBuV).

2.Correction factor (dB/m) = Antenna Factor (dB/m) + Cable loss (dB) – Pre-Amplifier gain (dB).

3.When the peak results are less than average limit, so not need to evaluate the average.



Standard:	FCC Part 15.407	Test Distance:	3m
Test item:	Band edge		
Frequency:	5745MHz		
Mode:	Mode 6		
Ant.Polar.:	Vertical		

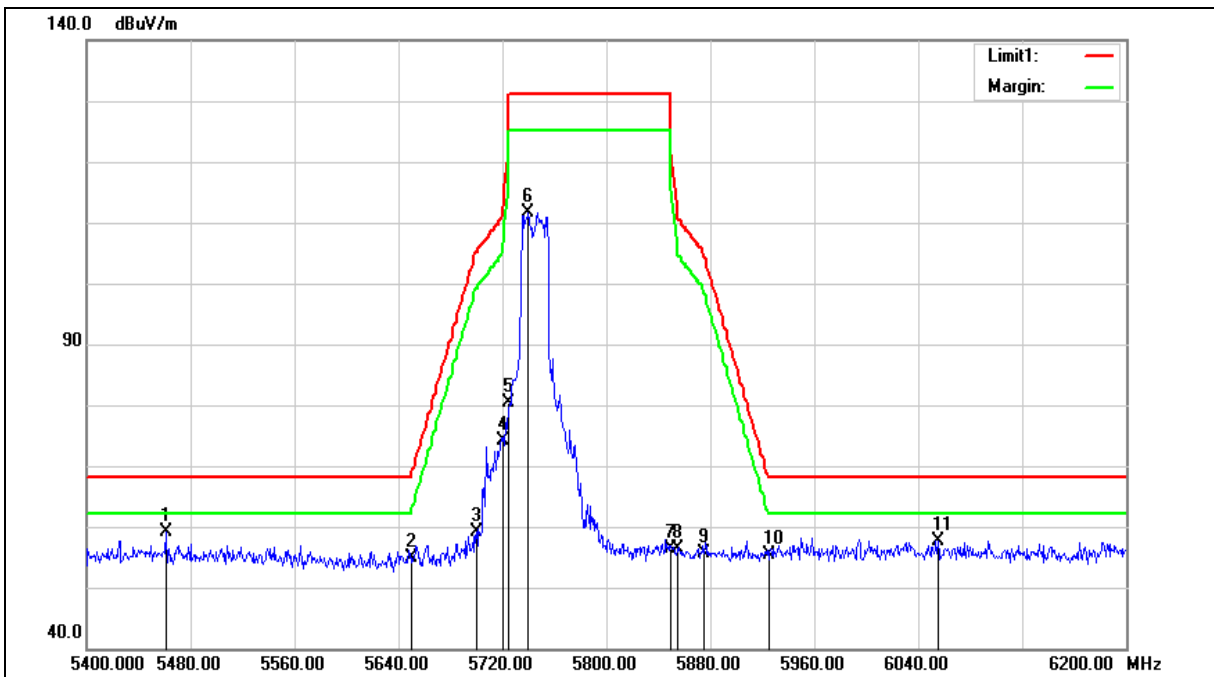



Standard:	FCC Part 15.407	Test Distance:	3m
Test item:	Band edge		
Frequency:	5745MHz		
Mode:	Mode 6		
Ant.Polar.:	Vertical		

No.	Frequency (MHz)	Reading (dBuV)	Correct Factor (dB/m)	Result (dBuV/m)	Limit (dBuV/m)	Margin (dB)	Remark
1	5460.800	53.08	5.93	59.01	68.20	-9.19	peak
2	5650.000	48.53	6.31	54.84	68.20	-13.36	peak
3	5700.000	52.83	6.40	59.23	105.20	-45.97	peak
4	5720.000	67.76	6.44	74.20	110.80	-36.60	peak
5	5725.000	73.94	6.45	80.39	122.20	-41.81	peak
6	5740.000	105.18	6.47	111.65	--	--	peak
7	5850.000	49.77	6.67	56.44	122.20	-65.76	peak
8	5855.000	49.83	6.67	56.50	110.80	-54.30	peak
9	5875.000	48.88	6.72	55.60	105.20	-49.60	peak
10	5925.000	48.57	6.80	55.37	68.20	-12.83	peak
11	6055.200	50.53	7.11	57.64	68.20	-10.56	peak

Note:1.Result (dBuV/m) = Correct Factor (dB/m) + Reading(dBuV).

2.Correction factor (dB/m) = Antenna Factor (dB/m) + Cable loss (dB) – Pre-Amplifier gain (dB).

3.When the peak results are less than average limit, so not need to evaluate the average.



Standard:	FCC Part 15.407	Test Distance:	3m
Test item:	Band edge		
Frequency:	5785MHz		
Mode:	Mode 6		
Ant.Polar.:	Horizontal		

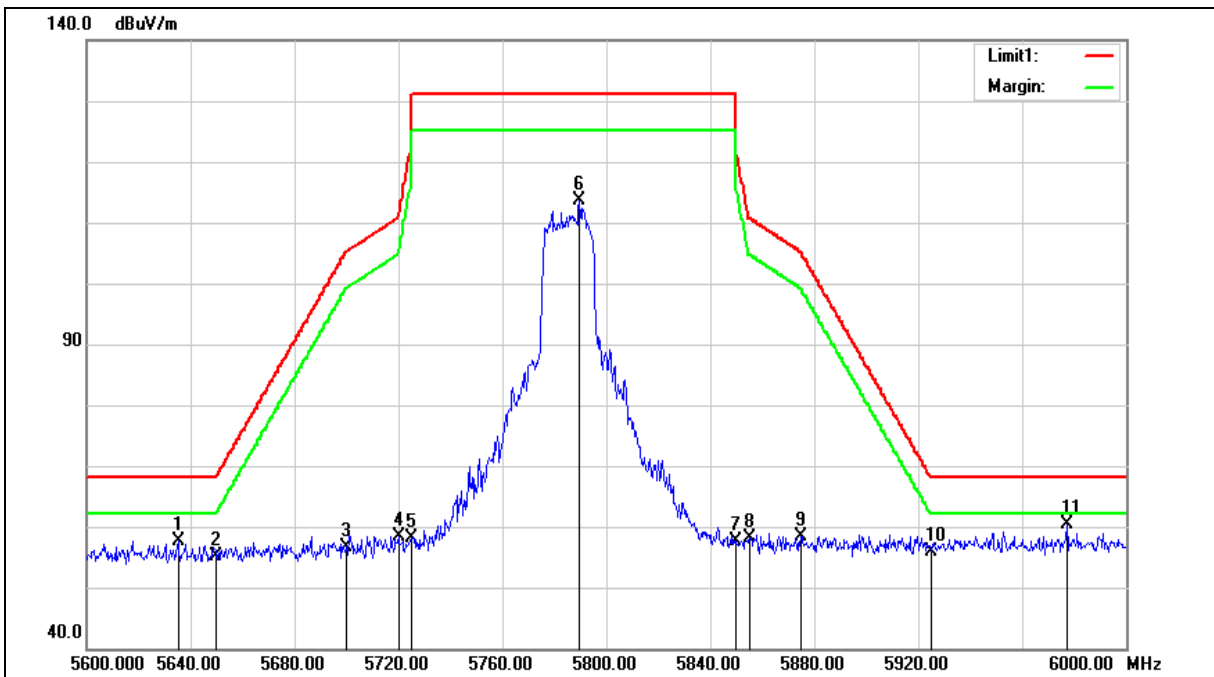



Standard:	FCC Part 15.407	Test Distance:	3m
Test item:	Band edge		
Frequency:	5785MHz		
Mode:	Mode 6		
Ant.Polar.:	Horizontal		

No.	Frequency (MHz)	Reading (dBuV)	Correct Factor (dB/m)	Result (dBuV/m)	Limit (dBuV/m)	Margin (dB)	Remark
1	5635.200	49.51	8.21	57.72	68.20	-10.48	peak
2	5650.000	46.77	8.24	55.01	68.20	-13.19	peak
3	5700.000	48.31	8.34	56.65	105.20	-48.55	peak
4	5720.000	49.90	8.38	58.28	110.80	-52.52	peak
5	5725.000	49.71	8.39	58.10	122.20	-64.10	peak
6	5789.600	105.08	8.51	113.59	--	--	peak
7	5850.000	48.91	8.63	57.54	122.20	-64.66	peak
8	5855.000	49.57	8.64	58.21	110.80	-52.59	peak
9	5875.000	49.74	8.69	58.43	105.20	-46.77	peak
10	5925.000	47.20	8.79	55.99	68.20	-12.21	peak
11	5977.200	51.44	8.90	60.34	68.20	-7.86	peak

Note:1.Result (dBuV/m) = Correct Factor (dB/m) + Reading(dBuV).

2.Correction factor (dB/m) = Antenna Factor (dB/m) + Cable loss (dB) – Pre-Amplifier gain (dB).

3.When the peak results are less than average limit, so not need to evaluate the average.



Standard:	FCC Part 15.407	Test Distance:	3m
Test item:	Band edge		
Frequency:	5785MHz		
Mode:	Mode 6		
Ant.Polar.:	Vertical		

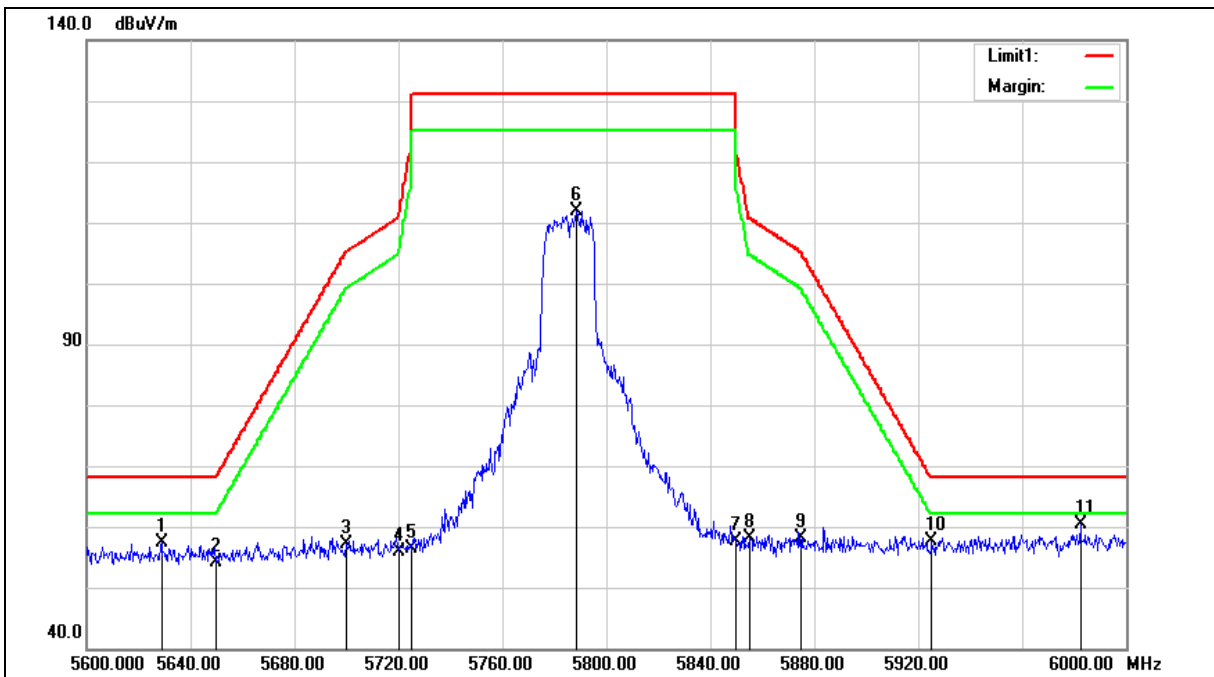



Standard:	FCC Part 15.407	Test Distance:	3m
Test item:	Band edge		
Frequency:	5785MHz		
Mode:	Mode 6		
Ant.Polar.:	Vertical		

No.	Frequency (MHz)	Reading (dBuV)	Correct Factor (dB/m)	Result (dBuV/m)	Limit (dBuV/m)	Margin (dB)	Remark
1	5628.800	49.25	8.20	57.45	68.20	-10.75	peak
2	5650.000	45.79	8.24	54.03	68.20	-14.17	peak
3	5700.000	48.88	8.34	57.22	105.20	-47.98	peak
4	5720.000	47.61	8.38	55.99	110.80	-54.81	peak
5	5725.000	47.97	8.39	56.36	122.20	-65.84	peak
6	5788.400	103.45	8.51	111.96	--	--	peak
7	5850.000	48.93	8.63	57.56	122.20	-64.64	peak
8	5855.000	49.51	8.64	58.15	110.80	-52.65	peak
9	5875.000	49.52	8.69	58.21	105.20	-46.99	peak
10	5925.000	48.78	8.79	57.57	68.20	-10.63	peak
11	5982.400	51.59	8.90	60.49	68.20	-7.71	peak

Note:1.Result (dBuV/m) = Correct Factor (dB/m) + Reading(dBuV).

2.Correction factor (dB/m) = Antenna Factor (dB/m) + Cable loss (dB) – Pre-Amplifier gain (dB).

3.When the peak results are less than average limit, so not need to evaluate the average.



Standard:	FCC Part 15.407	Test Distance:	3m
Test item:	Band edge		
Frequency:	5825MHz		
Mode:	Mode 6		
Ant.Polar.:	Horizontal		

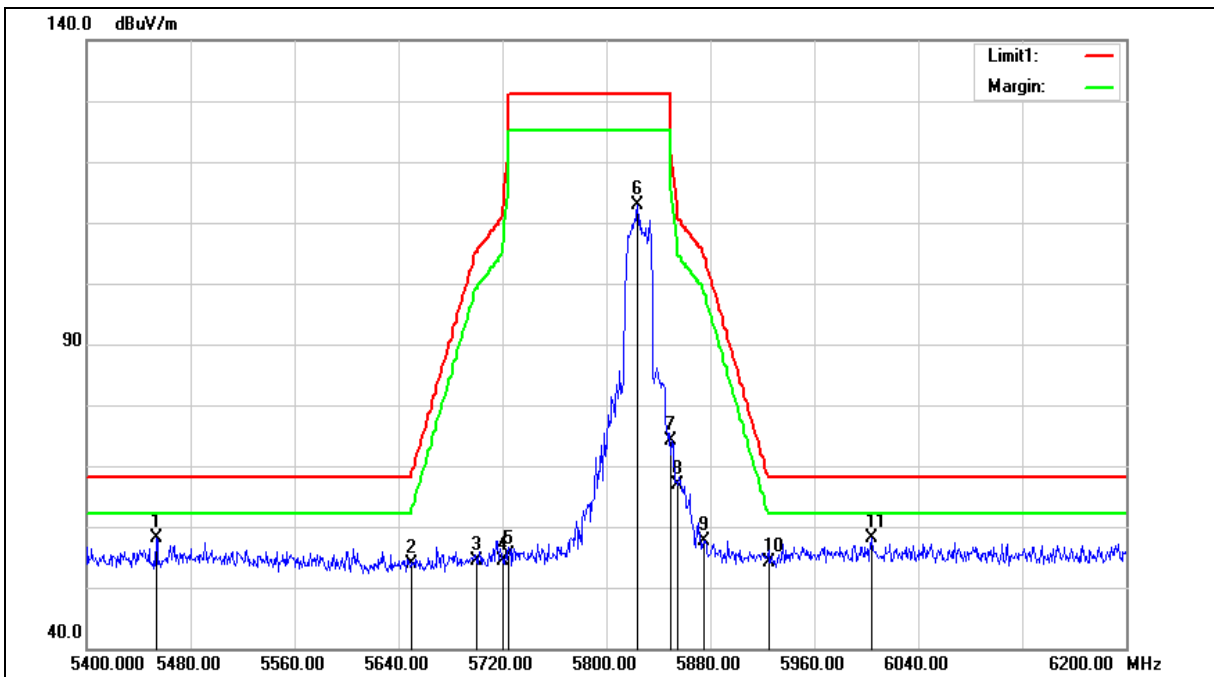



Standard:	FCC Part 15.407	Test Distance:	3m
Test item:	Band edge		
Frequency:	5825MHz		
Mode:	Mode 6		
Ant.Polar.:	Horizontal		

No.	Frequency (MHz)	Reading (dBuV)	Correct Factor (dB/m)	Result (dBuV/m)	Limit (dBuV/m)	Margin (dB)	Remark
1	5453.600	52.27	5.91	58.18	68.20	-10.02	peak
2	5650.000	47.69	6.31	54.00	68.20	-14.20	peak
3	5700.000	47.86	6.40	54.26	105.20	-50.94	peak
4	5720.000	47.91	6.44	54.35	110.80	-56.45	peak
5	5725.000	49.01	6.45	55.46	122.20	-66.74	peak
6	5824.000	106.25	6.62	112.87	--	--	peak
7	5850.000	67.36	6.67	74.03	122.20	-48.17	peak
8	5855.000	60.12	6.67	66.79	110.80	-44.01	peak
9	5875.000	51.02	6.72	57.74	105.20	-47.46	peak
10	5925.000	47.27	6.80	54.07	68.20	-14.13	peak
11	6004.000	51.15	6.95	58.10	68.20	-10.10	peak

Note:1.Result (dBuV/m) = Correct Factor (dB/m) + Reading(dBuV).

2.Correction factor (dB/m) = Antenna Factor (dB/m) + Cable loss (dB) – Pre-Amplifier gain (dB).

3.When the peak results are less than average limit, so not need to evaluate the average.



Standard:	FCC Part 15.407	Test Distance:	3m
Test item:	Band edge		
Frequency:	5825MHz		
Mode:	Mode 6		
Ant.Polar.:	Vertical		

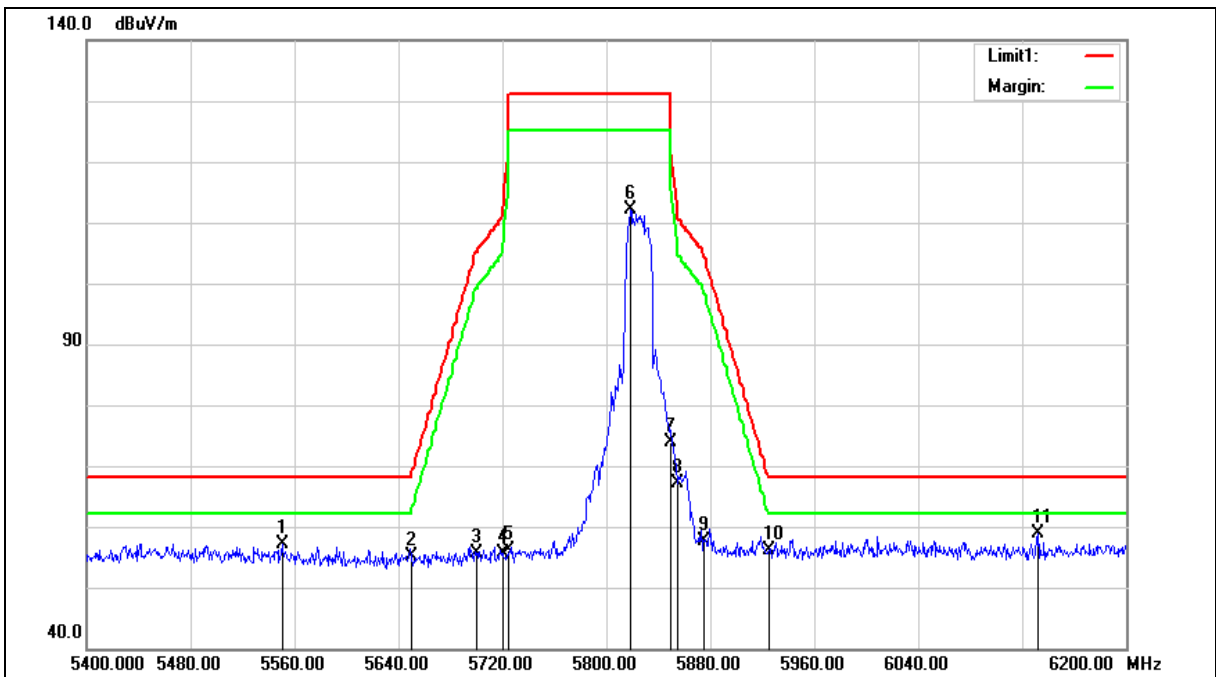



Standard:	FCC Part 15.407	Test Distance:	3m
Test item:	Band edge		
Frequency:	5825MHz		
Mode:	Mode 6		
Ant.Polar.:	Vertical		

No.	Frequency (MHz)	Reading (dBuV)	Correct Factor (dB/m)	Result (dBuV/m)	Limit (dBuV/m)	Margin (dB)	Remark
1	5550.400	51.04	6.13	57.17	68.20	-11.03	peak
2	5650.000	48.85	6.31	55.16	68.20	-13.04	peak
3	5700.000	49.18	6.40	55.58	105.20	-49.62	peak
4	5720.000	49.29	6.44	55.73	110.80	-55.07	peak
5	5725.000	49.72	6.45	56.17	122.20	-66.03	peak
6	5818.400	105.59	6.61	112.20	--	--	peak
7	5850.000	67.32	6.67	73.99	122.20	-48.21	peak
8	5855.000	60.53	6.67	67.20	110.80	-43.60	peak
9	5875.000	50.93	6.72	57.65	105.20	-47.55	peak
10	5925.000	49.21	6.80	56.01	68.20	-12.19	peak
11	6132.000	51.62	7.32	58.94	68.20	-9.26	peak

Note:1.Result (dBuV/m) = Correct Factor (dB/m) + Reading(dBuV).

2.Correction factor (dB/m) = Antenna Factor (dB/m) + Cable loss (dB) – Pre-Amplifier gain (dB).

3.When the peak results are less than average limit, so not need to evaluate the average.



Standard:	FCC Part 15.407	Test Distance:	3m
Test item:	Band edge		
Frequency:	5190MHz		
Mode:	Mode 7		
Ant.Polar.:	Horizontal		

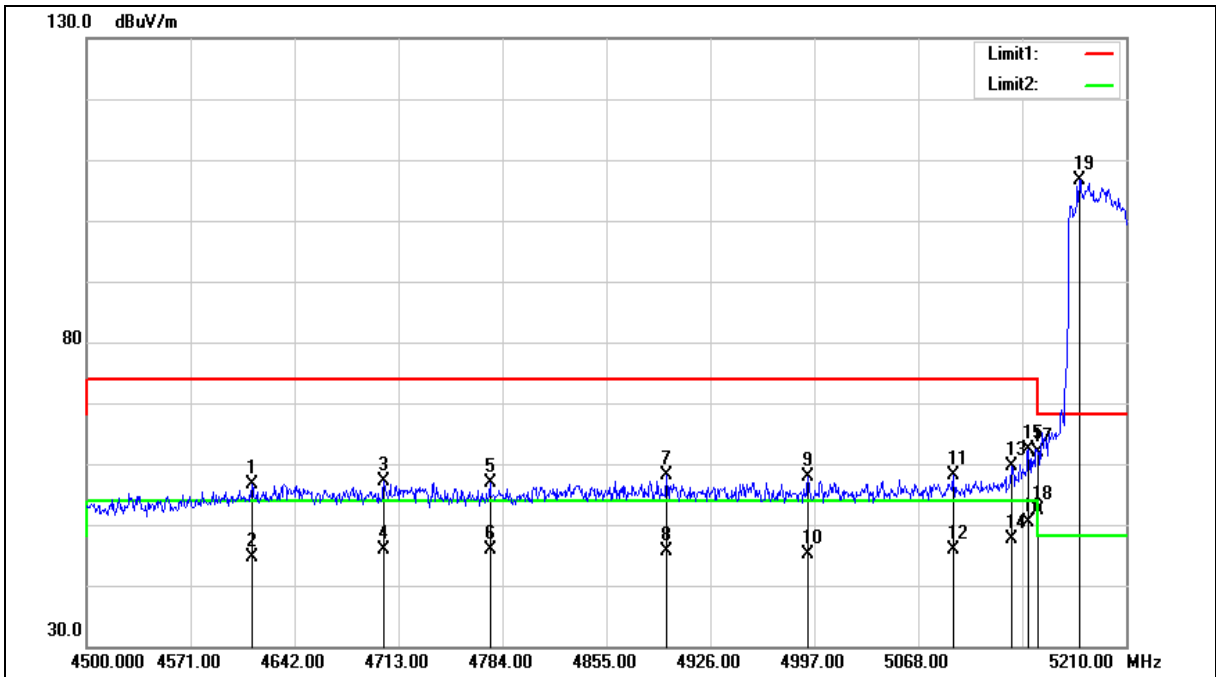



Standard:	FCC Part 15.407	Test Distance:	3m
Test item:	Band edge		
Frequency:	5190MHz		
Mode:	Mode 7		
Ant.Polar.:	Horizontal		

No.	Frequency (MHz)	Reading (dBuV)	Correct Factor (dB/m)	Result (dBuV/m)	Limit (dBuV/m)	Margin (dB)	Remark
1	4612.890	51.38	5.33	56.71	74.00	-17.29	peak
2	4612.890	39.41	5.33	44.74	54.00	-9.26	AVG
3	4703.060	51.60	5.60	57.20	74.00	-16.80	peak
4	4703.060	40.37	5.60	45.97	54.00	-8.03	AVG
5	4775.480	51.09	5.82	56.91	74.00	-17.09	peak
6	4775.480	40.13	5.82	45.95	54.00	-8.05	AVG
7	4896.180	51.83	6.19	58.02	74.00	-15.98	peak
8	4896.180	39.32	6.19	45.51	54.00	-8.49	AVG
9	4992.740	51.37	6.48	57.85	74.00	-16.15	peak
10	4992.740	38.69	6.48	45.17	54.00	-8.83	AVG
11	5092.140	51.30	6.77	58.07	74.00	-15.93	peak
12	5092.140	39.19	6.77	45.96	54.00	-8.04	AVG
13	5131.900	52.75	6.89	59.64	74.00	-14.36	peak
14	5131.900	40.78	6.89	47.67	54.00	-6.33	AVG
15	5143.260	55.34	6.92	62.26	74.00	-11.74	peak
16	5143.260	43.54	6.92	50.46	54.00	-3.54	AVG
17	5150.000	54.96	6.94	61.90	74.00	-12.10	peak
18	5150.000	45.35	6.94	52.29	54.00	-1.71	AVG
19	5178.050	99.56	7.02	106.58	--	--	peak

Note:1.Result (dBuV/m) = Correct Factor (dB/m) + Reading(dBuV).

2.Correction factor (dB/m) = Antenna Factor (dB/m) + Cable loss (dB) – Pre-Amplifier gain (dB).

3.When the peak results are less than average limit, so not need to evaluate the average.



Standard:	FCC Part 15.407	Test Distance:	3m
Test item:	Band edge		
Frequency:	5190MHz		
Mode:	Mode 7		
Ant.Polar.:	Vertical		

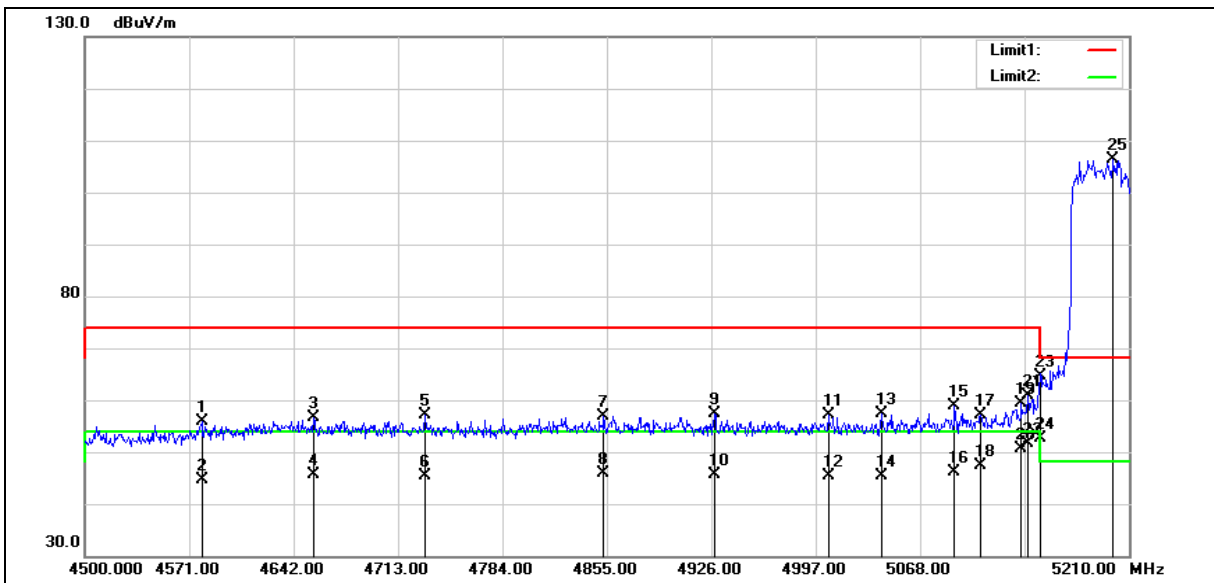

No.	Frequency (MHz)	Reading (dBuV)	Correct Factor (dB/m)	Result (dBuV/m)	Limit (dBuV/m)	Margin (dB)	Remark
1	4579.520	50.59	5.22	55.81	74.00	-18.19	peak
2	4579.520	39.50	5.22	44.72	54.00	-9.28	AVG
3	4655.490	51.24	5.45	56.69	74.00	-17.31	peak
4	4655.490	40.09	5.45	45.54	54.00	-8.46	AVG
5	4731.460	51.38	5.69	57.07	74.00	-16.93	peak

Note:1.Result (dBuV/m) = Correct Factor (dB/m) + Reading(dBuV).

2.Correction factor (dB/m) = Antenna Factor (dB/m) + Cable loss (dB) – Pre-Amplifier gain (dB).

3.When the peak results are less than average limit, so not need to evaluate the average.



Standard:	FCC Part 15.407	Test Distance:	3m
Test item:	Band edge		
Frequency:	5190MHz		
Mode:	Mode 7		
Ant.Polar.:	Vertical		

No.	Frequency (MHz)	Reading (dBuV)	Correct Factor (dB/m)	Result (dBuV/m)	Limit (dBuV/m)	Margin (dB)	Remark
6	4731.460	39.73	5.69	45.42	54.00	-8.58	AVG
7	4852.870	50.80	6.07	56.87	74.00	-17.13	peak
8	4852.870	39.71	6.07	45.78	54.00	-8.22	AVG
9	4928.130	51.04	6.29	57.33	74.00	-16.67	peak
10	4928.130	39.30	6.29	45.59	54.00	-8.41	AVG
11	5005.520	50.53	6.53	57.06	74.00	-16.94	peak
12	5005.520	38.77	6.53	45.30	54.00	-8.70	AVG
13	5041.730	50.79	6.63	57.42	74.00	-16.58	peak
14	5041.730	38.87	6.63	45.50	54.00	-8.50	AVG
15	5091.430	52.22	6.76	58.98	74.00	-15.02	peak
16	5091.430	39.36	6.76	46.12	54.00	-7.88	AVG
17	5109.180	50.22	6.82	57.04	74.00	-16.96	peak
18	5109.180	40.50	6.82	47.32	54.00	-6.68	AVG
19	5136.870	52.45	6.91	59.36	74.00	-14.64	peak
20	5136.870	43.82	6.91	50.73	54.00	-3.27	AVG
21	5141.130	53.94	6.91	60.85	74.00	-13.15	peak
22	5141.130	44.69	6.91	51.60	54.00	-2.40	AVG
23	5150.000	57.67	6.94	64.61	74.00	-9.39	peak
24	5150.000	45.81	6.94	52.75	54.00	-1.25	AVG
25	5199.350	99.26	7.08	106.34	--	--	peak

Note:1.Result (dBuV/m) = Correct Factor (dB/m) + Reading(dBuV).

2.Correction factor (dB/m) = Antenna Factor (dB/m) + Cable loss (dB) – Pre-Amplifier gain (dB).

3.When the peak results are less than average limit, so not need to evaluate the average.



Standard:	FCC Part 15.407	Test Distance:	3m
Test item:	Band edge		
Frequency:	5230MHz		
Mode:	Mode 7		
Ant.Polar.:	Horizontal		

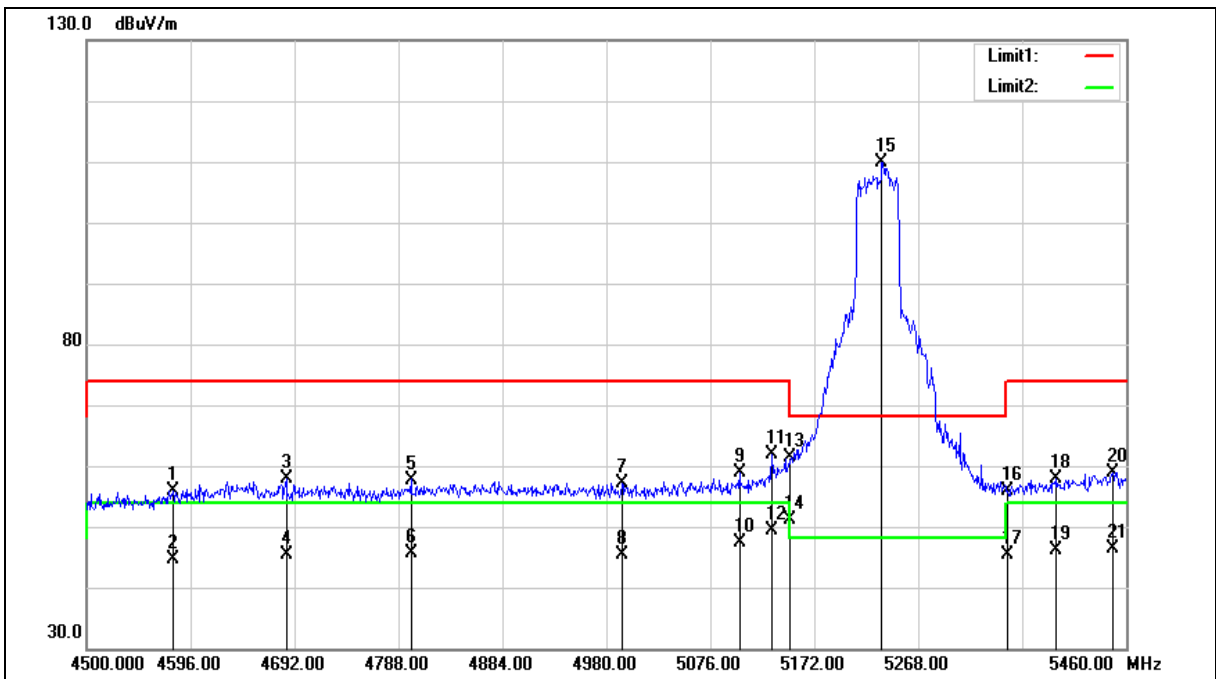



Standard:	FCC Part 15.407	Test Distance:	3m
Test item:	Band edge		
Frequency:	5230MHz		
Mode:	Mode 7		
Ant.Polar.:	Horizontal		

No.	Frequency (MHz)	Reading (dBuV)	Correct Factor (dB/m)	Result (dBuV/m)	Limit (dBuV/m)	Margin (dB)	Remark
1	4579.680	50.67	5.23	55.90	74.00	-18.10	peak
2	4579.680	39.45	5.23	44.68	54.00	-9.32	AVG
3	4684.320	52.27	5.55	57.82	74.00	-16.18	peak
4	4684.320	39.82	5.55	45.37	54.00	-8.63	AVG
5	4799.520	51.85	5.90	57.75	74.00	-16.25	peak
6	4799.520	39.69	5.90	45.59	54.00	-8.41	AVG
7	4994.400	50.70	6.50	57.20	74.00	-16.80	peak
8	4994.400	38.93	6.50	45.43	54.00	-8.57	AVG
9	5102.880	52.06	6.80	58.86	74.00	-15.14	peak
10	5102.880	40.69	6.80	47.49	54.00	-6.51	AVG
11	5132.640	55.05	6.89	61.94	74.00	-12.06	peak
12	5132.640	42.39	6.89	49.28	54.00	-4.72	AVG
13	5150.000	54.35	6.94	61.29	74.00	-12.71	peak
14	5150.000	44.07	6.94	51.01	54.00	-2.99	AVG
15	5234.400	102.80	7.17	109.97	--	--	peak
16	5350.000	48.33	7.50	55.83	74.00	-18.17	peak
17	5350.000	37.78	7.50	45.28	54.00	-8.72	AVG
18	5395.680	50.33	7.64	57.97	74.00	-16.03	peak
19	5395.680	38.53	7.64	46.17	54.00	-7.83	AVG
20	5447.520	51.17	7.79	58.96	74.00	-15.04	peak
21	5447.520	38.67	7.79	46.46	54.00	-7.54	AVG

Note:1.Result (dBuV/m) = Correct Factor (dB/m) + Reading(dBuV).

2.Correction factor (dB/m) = Antenna Factor (dB/m) + Cable loss (dB) – Pre-Amplifier gain (dB).

3.When the peak results are less than average limit, so not need to evaluate the average.

Standard:	FCC Part 15.407	Test Distance:	3m
Test item:	Band edge		
Frequency:	5230MHz		
Mode:	Mode 7		
Ant.Polar.:	Vertical		

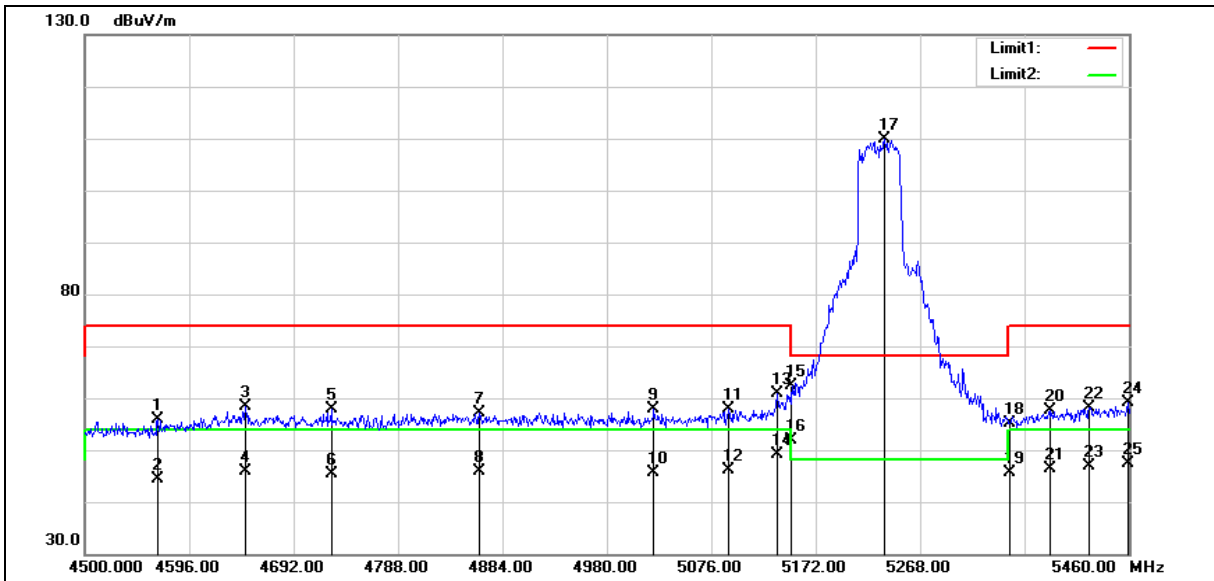

No.	Frequency (MHz)	Reading (dBuV)	Correct Factor (dB/m)	Result (dBuV/m)	Limit (dBuV/m)	Margin (dB)	Remark
1	4567.200	50.68	5.19	55.87	74.00	-18.13	peak
2	4567.200	39.10	5.19	44.29	54.00	-9.71	AVG
3	4647.840	52.93	5.43	58.36	74.00	-15.64	peak
4	4647.840	40.42	5.43	45.85	54.00	-8.15	AVG
5	4726.560	52.11	5.68	57.79	74.00	-16.21	peak

Note:1.Result (dBuV/m) = Correct Factor (dB/m) + Reading(dBuV).

2.Correction factor (dB/m) = Antenna Factor (dB/m) + Cable loss (dB) – Pre-Amplifier gain (dB).

3.When the peak results are less than average limit, so not need to evaluate the average.



Standard:	FCC Part 15.407	Test Distance:	3m
Test item:	Band edge		
Frequency:	5230MHz		
Mode:	Mode 7		
Ant.Polar.:	Vertical		

No.	Frequency (MHz)	Reading (dBuV)	Correct Factor (dB/m)	Result (dBuV/m)	Limit (dBuV/m)	Margin (dB)	Remark
6	4726.560	39.81	5.68	45.49	54.00	-8.51	AVG
7	4862.880	51.00	6.09	57.09	74.00	-16.91	peak
8	4862.880	39.74	6.09	45.83	54.00	-8.17	AVG
9	5023.200	51.28	6.57	57.85	74.00	-16.15	peak
10	5023.200	38.99	6.57	45.56	54.00	-8.44	AVG
11	5092.320	51.09	6.77	57.86	74.00	-16.14	peak
12	5092.320	39.43	6.77	46.20	54.00	-7.80	AVG
13	5136.480	54.07	6.91	60.98	74.00	-13.02	peak
14	5136.480	42.12	6.91	49.03	54.00	-4.97	AVG
15	5150.000	55.45	6.94	62.39	74.00	-11.61	peak
16	5150.000	44.95	6.94	51.89	54.00	-2.11	AVG
17	5235.360	102.74	7.18	109.92	--	--	peak
18	5350.000	47.61	7.50	55.11	74.00	-18.89	peak
19	5350.000	38.19	7.50	45.69	54.00	-8.31	AVG
20	5388.000	50.01	7.62	57.63	74.00	-16.37	peak
21	5388.000	38.78	7.62	46.40	54.00	-7.60	AVG
22	5423.520	50.44	7.71	58.15	74.00	-15.85	peak
23	5423.520	39.26	7.71	46.97	54.00	-7.03	AVG
24	5459.040	51.21	7.82	59.03	74.00	-14.97	peak
25	5459.040	39.59	7.82	47.41	54.00	-6.59	AVG

Note:1.Result (dBuV/m) = Correct Factor (dB/m) + Reading(dBuV).

2.Correction factor (dB/m) = Antenna Factor (dB/m) + Cable loss (dB) – Pre-Amplifier gain (dB).

3.When the peak results are less than average limit, so not need to evaluate the average.



Standard:	FCC Part 15.407	Test Distance:	3m
Test item:	Band edge		
Frequency:	5755MHz		
Mode:	Mode 7		
Ant.Polar.:	Horizontal		

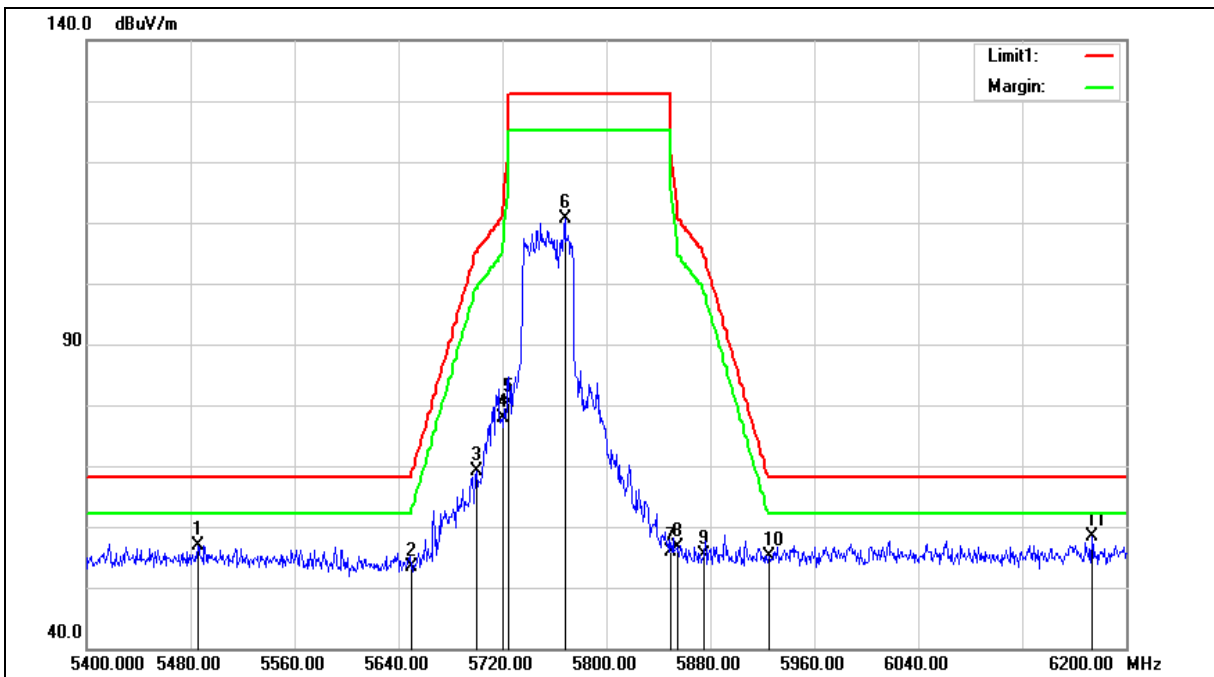



Standard:	FCC Part 15.407	Test Distance:	3m
Test item:	Band edge		
Frequency:	5755MHz		
Mode:	Mode 7		
Ant.Polar.:	Horizontal		

No.	Frequency (MHz)	Reading (dBuV)	Correct Factor (dB/m)	Result (dBuV/m)	Limit (dBuV/m)	Margin (dB)	Remark
1	5485.600	50.99	6.00	56.99	68.20	-11.21	peak
2	5650.000	47.19	6.31	53.50	68.20	-14.70	peak
3	5700.000	62.74	6.40	69.14	105.20	-36.06	peak
4	5720.000	71.47	6.44	77.91	110.80	-32.89	peak
5	5725.000	73.94	6.45	80.39	122.20	-41.81	peak
6	5768.000	104.04	6.52	110.56	--	--	peak
7	5850.000	49.32	6.67	55.99	122.20	-66.21	peak
8	5855.000	49.84	6.67	56.51	110.80	-54.29	peak
9	5875.000	48.73	6.72	55.45	105.20	-49.75	peak
10	5925.000	48.35	6.80	55.15	68.20	-13.05	peak
11	6173.600	50.90	7.45	58.35	68.20	-9.85	peak

Note:1.Result (dBuV/m) = Correct Factor (dB/m) + Reading(dBuV).

2.Correction factor (dB/m) = Antenna Factor (dB/m) + Cable loss (dB) – Pre-Amplifier gain (dB).

3.When the peak results are less than average limit, so not need to evaluate the average.



Standard:	FCC Part 15.407	Test Distance:	3m
Test item:	Band edge		
Frequency:	5755MHz		
Mode:	Mode 7		
Ant.Polar.:	Vertical		

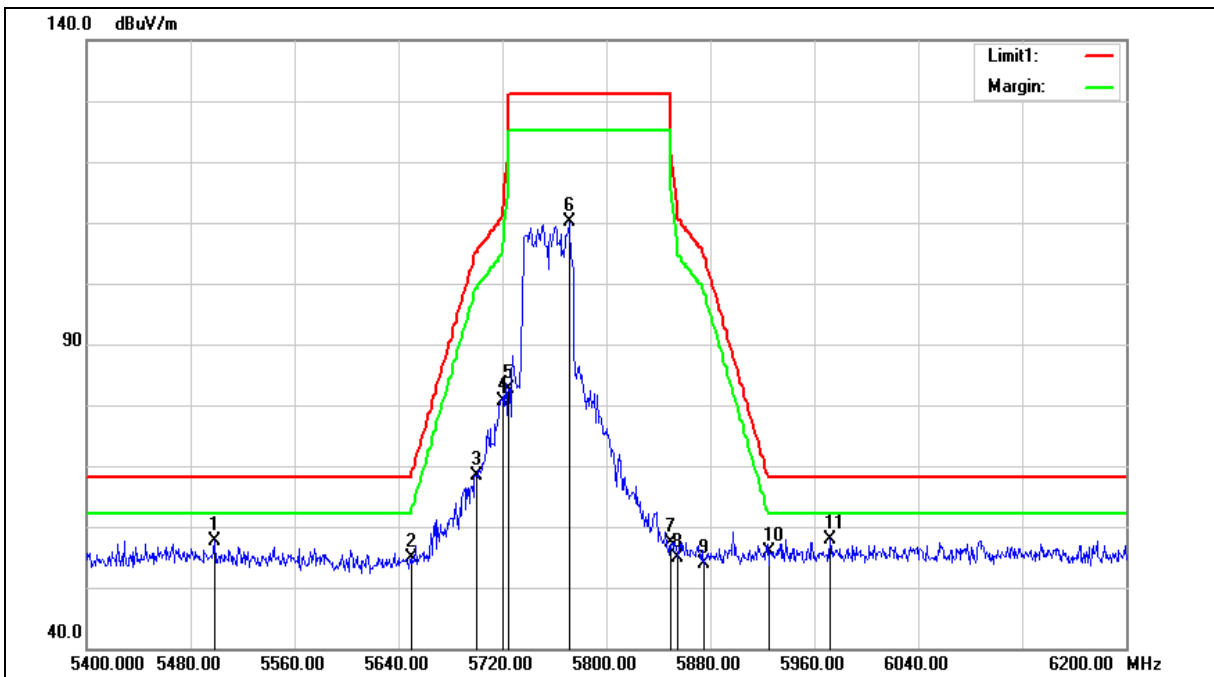



Standard:	FCC Part 15.407	Test Distance:	3m
Test item:	Band edge		
Frequency:	5755MHz		
Mode:	Mode 7		
Ant.Polar.:	Vertical		

No.	Frequency (MHz)	Reading (dBuV)	Correct Factor (dB/m)	Result (dBuV/m)	Limit (dBuV/m)	Margin (dB)	Remark
1	5498.400	51.59	6.04	57.63	68.20	-10.57	peak
2	5650.000	48.60	6.31	54.91	68.20	-13.29	peak
3	5700.000	61.87	6.40	68.27	105.20	-36.93	peak
4	5720.000	74.24	6.44	80.68	110.80	-30.12	peak
5	5725.000	76.12	6.45	82.57	122.20	-39.63	peak
6	5771.200	103.57	6.53	110.10	--	--	peak
7	5850.000	50.66	6.67	57.33	122.20	-64.87	peak
8	5855.000	48.22	6.67	54.89	110.80	-55.91	peak
9	5875.000	47.11	6.72	53.83	105.20	-51.37	peak
10	5925.000	49.01	6.80	55.81	68.20	-12.39	peak
11	5972.000	50.89	6.88	57.77	68.20	-10.43	peak

Note:1.Result (dBuV/m) = Correct Factor (dB/m) + Reading(dBuV).

2.Correction factor (dB/m) = Antenna Factor (dB/m) + Cable loss (dB) – Pre-Amplifier gain (dB).

3.When the peak results are less than average limit, so not need to evaluate the average.



Standard:	FCC Part 15.407	Test Distance:	3m
Test item:	Band edge		
Frequency:	5795MHz		
Mode:	Mode 7		
Ant.Polar.:	Horizontal		

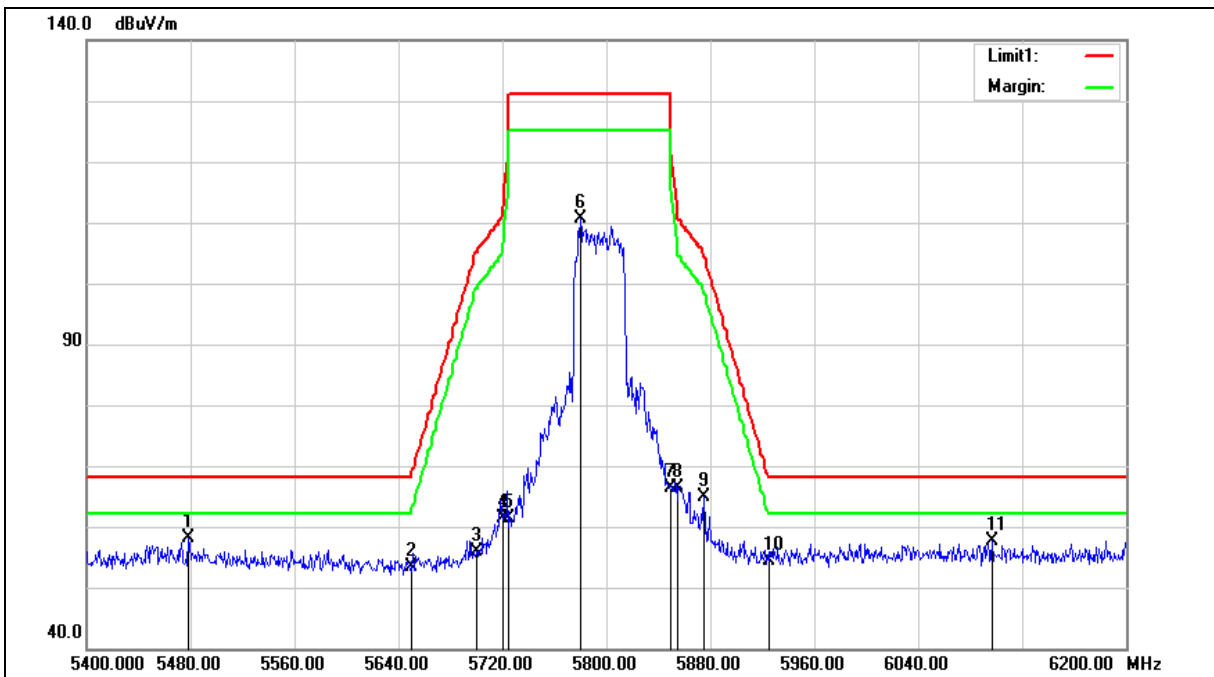



Standard:	FCC Part 15.407	Test Distance:	3m
Test item:	Band edge		
Frequency:	5795MHz		
Mode:	Mode 7		
Ant.Polar.:	Horizontal		

No.	Frequency (MHz)	Reading (dBuV)	Correct Factor (dB/m)	Result (dBuV/m)	Limit (dBuV/m)	Margin (dB)	Remark
1	5478.400	52.20	5.98	58.18	68.20	-10.02	peak
2	5650.000	47.17	6.31	53.48	68.20	-14.72	peak
3	5700.000	49.39	6.40	55.79	105.20	-49.41	peak
4	5720.000	55.06	6.44	61.50	110.80	-49.30	peak
5	5725.000	54.85	6.45	61.30	122.20	-60.90	peak
6	5780.000	103.98	6.54	110.52	--	--	peak
7	5850.000	59.71	6.67	66.38	122.20	-55.82	peak
8	5855.000	59.62	6.67	66.29	110.80	-44.51	peak
9	5875.000	58.15	6.72	64.87	105.20	-40.33	peak
10	5925.000	47.47	6.80	54.27	68.20	-13.93	peak
11	6096.800	50.50	7.23	57.73	68.20	-10.47	peak

Note:1.Result (dBuV/m) = Correct Factor (dB/m) + Reading(dBuV).

2.Correction factor (dB/m) = Antenna Factor (dB/m) + Cable loss (dB) – Pre-Amplifier gain (dB).

3.When the peak results are less than average limit, so not need to evaluate the average.



Standard:	FCC Part 15.407	Test Distance:	3m
Test item:	Band edge		
Frequency:	5795MHz		
Mode:	Mode 7		
Ant.Polar.:	Vertical		

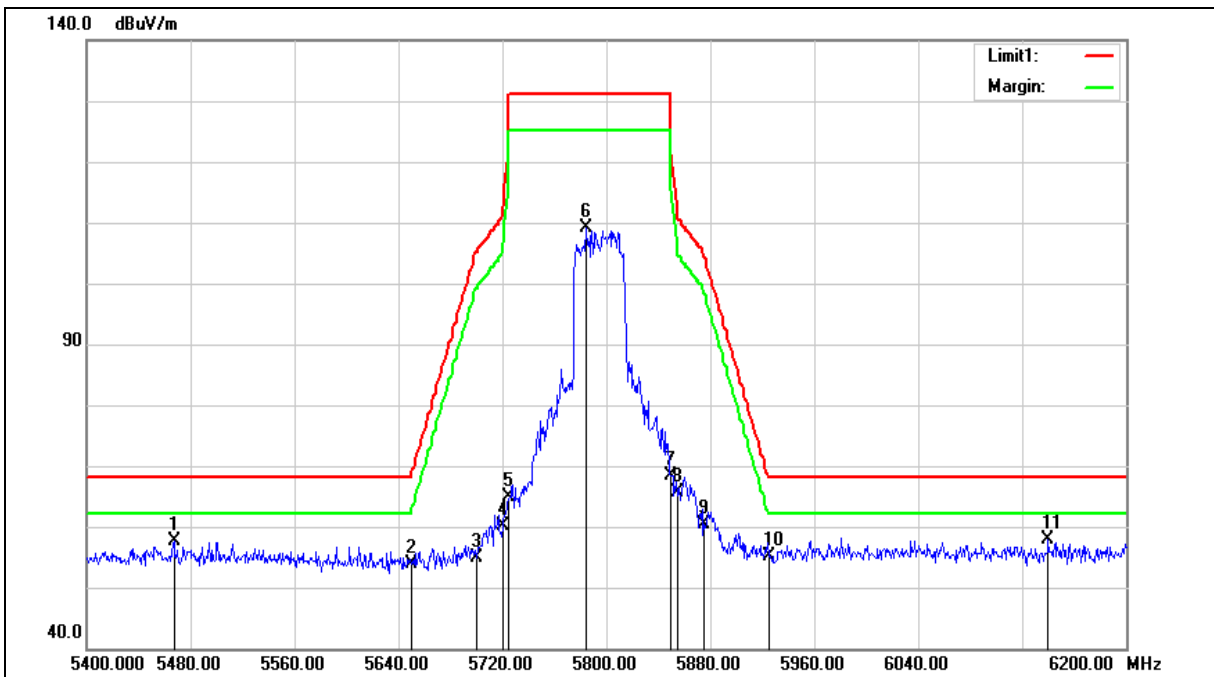



Standard:	FCC Part 15.407	Test Distance:	3m
Test item:	Band edge		
Frequency:	5795MHz		
Mode:	Mode 7		
Ant.Polar.:	Vertical		

No.	Frequency (MHz)	Reading (dBUV)	Correct Factor (dB/m)	Result (dBUV/m)	Limit (dBUV/m)	Margin (dB)	Remark
1	5467.200	51.60	5.95	57.55	68.20	-10.65	peak
2	5650.000	47.67	6.31	53.98	68.20	-14.22	peak
3	5700.000	48.36	6.40	54.76	105.20	-50.44	peak
4	5720.000	53.63	6.44	60.07	110.80	-50.73	peak
5	5725.000	58.39	6.45	64.84	122.20	-57.36	peak
6	5784.000	102.62	6.55	109.17	--	--	peak
7	5850.000	61.81	6.67	68.48	122.20	-53.72	peak
8	5855.000	58.94	6.67	65.61	110.80	-45.19	peak
9	5875.000	53.66	6.72	60.38	105.20	-44.82	peak
10	5925.000	48.34	6.80	55.14	68.20	-13.06	peak
11	6140.000	50.64	7.35	57.99	68.20	-10.21	peak

Note:1.Result (dBUV/m) = Correct Factor (dB/m) + Reading(dBUV).

2.Correction factor (dB/m) = Antenna Factor (dB/m) + Cable loss (dB) – Pre-Amplifier gain (dB).

3.When the peak results are less than average limit, so not need to evaluate the average.



Standard:	FCC Part 15.407	Test Distance:	3m
Test item:	Band edge		
Frequency:	5210MHz		
Mode:	Mode 8		
Ant.Polar.:	Horizontal		

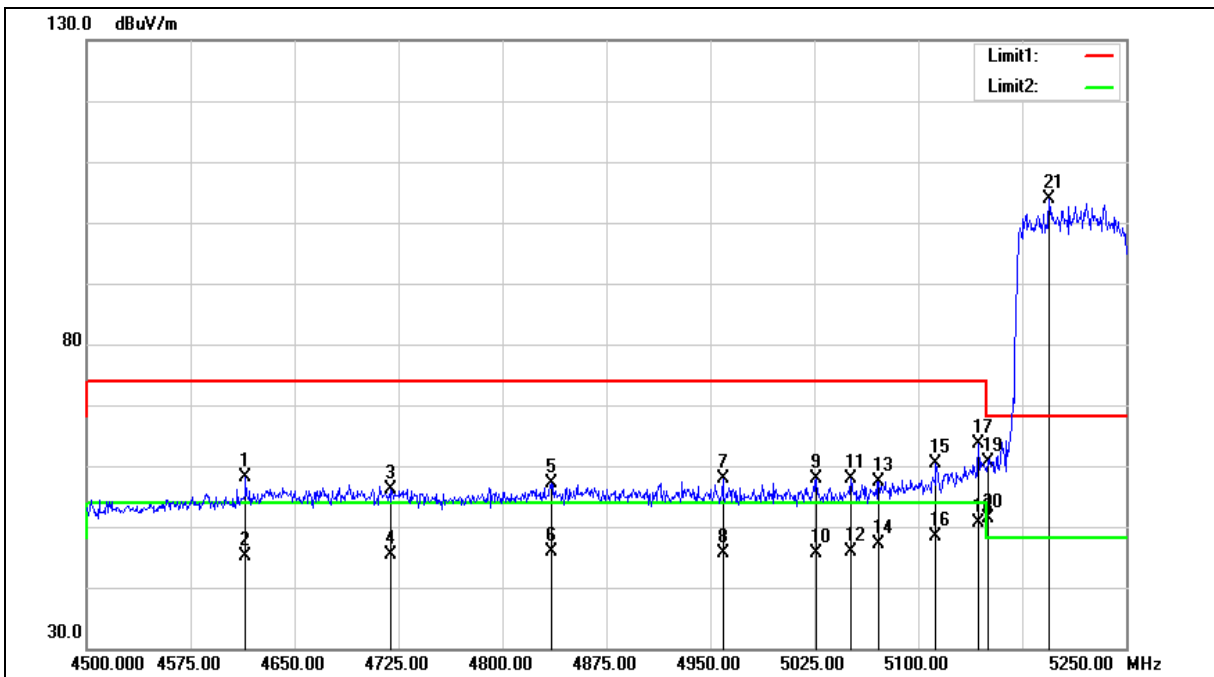



Standard:	FCC Part 15.407	Test Distance:	3m
Test item:	Band edge		
Frequency:	5210MHz		
Mode:	Mode 8		
Ant.Polar.:	Horizontal		

No.	Frequency (MHz)	Reading (dBuV)	Correct Factor (dB/m)	Result (dBuV/m)	Limit (dBuV/m)	Margin (dB)	Remark
1	4614.750	52.69	5.33	58.02	74.00	-15.98	peak
2	4614.750	39.69	5.33	45.02	54.00	-8.98	AVG
3	4719.750	50.51	5.65	56.16	74.00	-17.84	peak
4	4719.750	39.82	5.65	45.47	54.00	-8.53	AVG
5	4835.250	51.22	6.00	57.22	74.00	-16.78	peak
6	4835.250	39.95	6.00	45.95	54.00	-8.05	AVG
7	4959.000	51.42	6.38	57.80	74.00	-16.20	peak
8	4959.000	39.33	6.38	45.71	54.00	-8.29	AVG
9	5026.500	51.35	6.59	57.94	74.00	-16.06	peak
10	5026.500	39.00	6.59	45.59	54.00	-8.41	AVG
11	5051.250	51.21	6.65	57.86	74.00	-16.14	peak
12	5051.250	39.20	6.65	45.85	54.00	-8.15	AVG
13	5071.500	50.74	6.71	57.45	74.00	-16.55	peak
14	5071.500	40.41	6.71	47.12	54.00	-6.88	AVG
15	5112.750	53.60	6.82	60.42	74.00	-13.58	peak
16	5112.750	41.56	6.82	48.38	54.00	-5.62	AVG
17	5143.500	56.64	6.92	63.56	74.00	-10.44	peak
18	5143.500	43.67	6.92	50.59	54.00	-3.41	AVG
19	5150.000	53.65	6.94	60.59	74.00	-13.41	peak
20	5150.000	44.37	6.94	51.31	54.00	-2.69	AVG
21	5194.500	96.71	7.06	103.77	--	--	peak

Note:1.Result (dBuV/m) = Correct Factor (dB/m) + Reading(dBuV).

2.Correction factor (dB/m) = Antenna Factor (dB/m) + Cable loss (dB) – Pre-Amplifier gain (dB).

3.When the peak results are less than average limit, so not need to evaluate the average.



Standard:	FCC Part 15.407	Test Distance:	3m
Test item:	Band edge		
Frequency:	5210MHz		
Mode:	Mode 8		
Ant.Polar.:	Vertical		

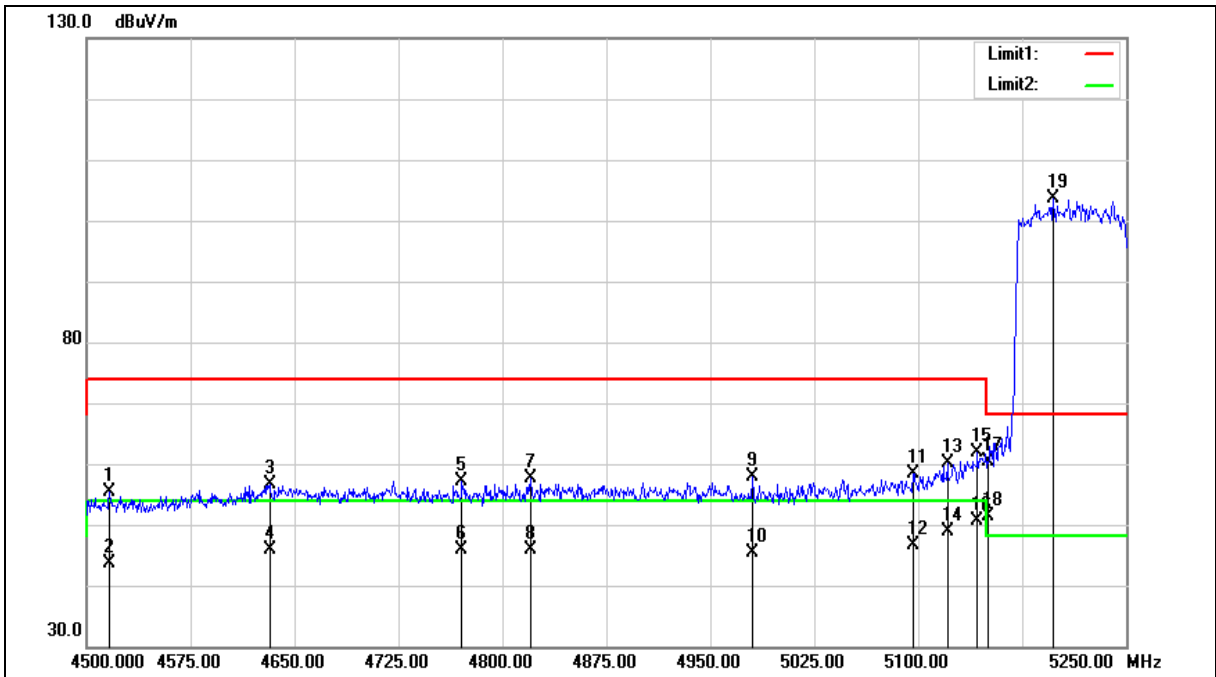



Standard:	FCC Part 15.407	Test Distance:	3m
Test item:	Band edge		
Frequency:	5210MHz		
Mode:	Mode 8		
Ant.Polar.:	Vertical		

No.	Frequency (MHz)	Reading (dBuV)	Correct Factor (dB/m)	Result (dBuV/m)	Limit (dBuV/m)	Margin (dB)	Remark
1	4516.500	50.42	5.03	55.45	74.00	-18.55	peak
2	4516.500	38.49	5.03	43.52	54.00	-10.48	AVG
3	4632.000	51.18	5.38	56.56	74.00	-17.44	peak
4	4632.000	40.60	5.38	45.98	54.00	-8.02	AVG
5	4770.750	51.37	5.81	57.18	74.00	-16.82	peak
6	4770.750	39.95	5.81	45.76	54.00	-8.24	AVG
7	4820.250	51.61	5.95	57.56	74.00	-16.44	peak
8	4820.250	39.87	5.95	45.82	54.00	-8.18	AVG
9	4980.750	51.39	6.46	57.85	74.00	-16.15	peak
10	4980.750	38.94	6.46	45.40	54.00	-8.60	AVG
11	5096.250	51.63	6.78	58.41	74.00	-15.59	peak
12	5096.250	39.78	6.78	46.56	54.00	-7.44	AVG
13	5121.000	53.33	6.85	60.18	74.00	-13.82	peak
14	5121.000	42.09	6.85	48.94	54.00	-5.06	AVG
15	5142.750	55.05	6.92	61.97	74.00	-12.03	peak
16	5142.750	43.65	6.92	50.57	54.00	-3.43	AVG
17	5150.000	53.49	6.94	60.43	74.00	-13.57	peak
18	5150.000	44.47	6.94	51.41	54.00	-2.59	AVG
19	5197.500	96.61	7.08	103.69	--	--	peak

Note:1.Result (dBuV/m) = Correct Factor (dB/m) + Reading(dBuV).

2.Correction factor (dB/m) = Antenna Factor (dB/m) + Cable loss (dB) – Pre-Amplifier gain (dB).

3.When the peak results are less than average limit, so not need to evaluate the average.



Standard:	FCC Part 15.407	Test Distance:	3m
Test item:	Band edge		
Frequency:	5775MHz		
Mode:	Mode 8		
Ant.Polar.:	Horizontal		

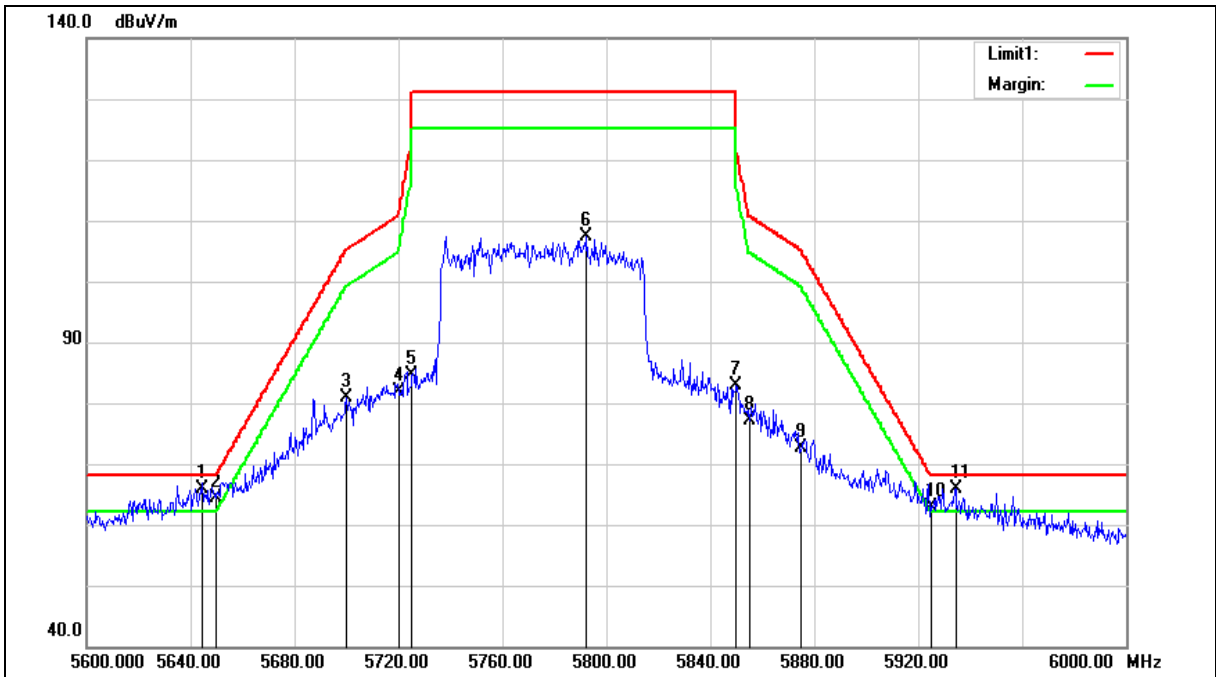



Standard:	FCC Part 15.407	Test Distance:	3m
Test item:	Band edge		
Frequency:	5775MHz		
Mode:	Mode 8		
Ant.Polar.:	Horizontal		

No.	Frequency (MHz)	Reading (dBuV)	Correct Factor (dB/m)	Result (dBuV/m)	Limit (dBuV/m)	Margin (dB)	Remark
1	5644.400	57.61	8.22	65.83	68.20	-2.37	peak
2	5650.000	56.10	8.24	64.34	68.20	-3.86	peak
3	5700.000	72.53	8.34	80.87	105.20	-24.33	peak
4	5720.000	73.53	8.38	81.91	110.80	-28.89	peak
5	5725.000	76.31	8.39	84.70	122.20	-37.50	peak
6	5792.400	98.90	8.52	107.42	--	--	peak
7	5850.000	74.36	8.63	82.99	122.20	-39.21	peak
8	5855.000	68.60	8.64	77.24	110.80	-33.56	peak
9	5875.000	64.06	8.69	72.75	105.20	-32.45	peak
10	5925.000	54.05	8.79	62.84	68.20	-5.36	peak
11	5934.400	57.13	8.81	65.94	68.20	-2.26	peak

Note:1.Result (dBuV/m) = Correct Factor (dB/m) + Reading(dBuV).

2.Correction factor (dB/m) = Antenna Factor (dB/m) + Cable loss (dB) – Pre-Amplifier gain (dB).

3.When the peak results are less than average limit, so not need to evaluate the average.



Standard:	FCC Part 15.407	Test Distance:	3m
Test item:	Band edge		
Frequency:	5775MHz		
Mode:	Mode 8		
Ant.Polar.:	Vertical		

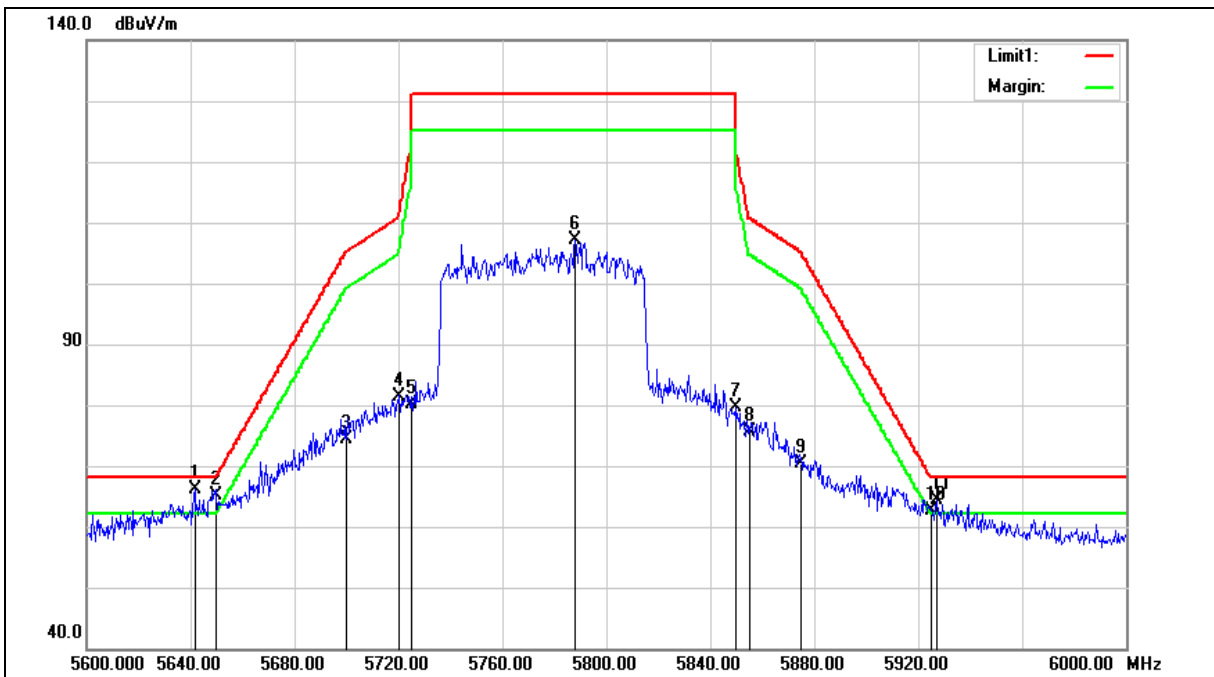



Standard:	FCC Part 15.407	Test Distance:	3m
Test item:	Band edge		
Frequency:	5775MHz		
Mode:	Mode 8		
Ant.Polar.:	Vertical		

No.	Frequency (MHz)	Reading (dBuV)	Correct Factor (dB/m)	Result (dBuV/m)	Limit (dBuV/m)	Margin (dB)	Remark
1	5641.600	57.84	8.22	66.06	68.20	-2.14	peak
2	5650.000	56.80	8.24	65.04	68.20	-3.16	peak
3	5700.000	65.92	8.34	74.26	105.20	-30.94	peak
4	5720.000	73.01	8.38	81.39	110.80	-29.41	peak
5	5725.000	71.74	8.39	80.13	122.20	-42.07	peak
6	5788.000	98.51	8.51	107.02	--	--	peak
7	5850.000	70.90	8.63	79.53	122.20	-42.67	peak
8	5855.000	66.96	8.64	75.60	110.80	-35.20	peak
9	5875.000	61.78	8.69	70.47	105.20	-34.73	peak
10	5925.000	53.78	8.79	62.57	68.20	-5.63	peak
11	5927.200	55.52	8.80	64.32	68.20	-3.88	peak

Note:1.Result (dBuV/m) = Correct Factor (dB/m) + Reading(dBuV).

2.Correction factor (dB/m) = Antenna Factor (dB/m) + Cable loss (dB) – Pre-Amplifier gain (dB).

3.When the peak results are less than average limit, so not need to evaluate the average.

Beamforming on

Below 1 GHz

Standard:	FCC Part 15.407	Test Distance:	3m
Test item:	Radiated Emission		
Frequency:	5745 MHz		
Mode:	Mode 2		
Ant.Polar.:	Horizontal		

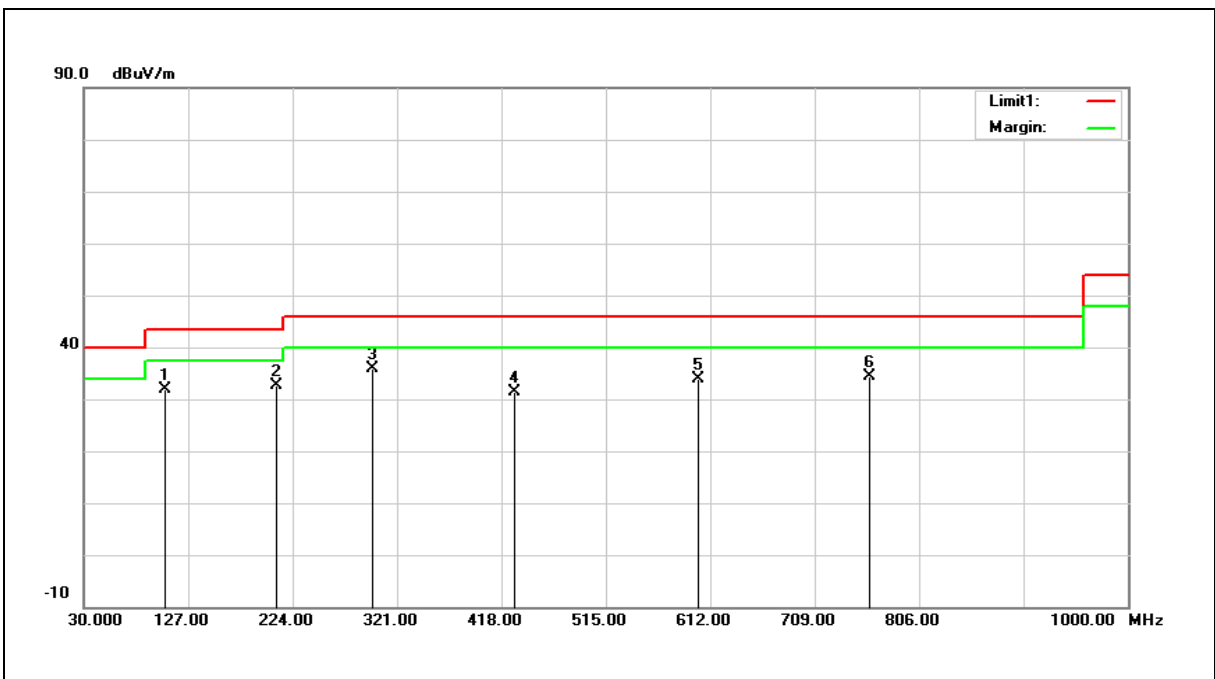

No.	Frequency (MHz)	Reading (dBuV)	Correct Factor (dB/m)	Result (dBuV/m)	Limit (dBuV/m)	Margin (dB)	Remark
1	105.6600	41.65	-9.88	31.77	43.50	-11.73	QP
2	208.4800	40.35	-7.69	32.66	43.50	-10.84	QP
3	297.7200	40.15	-4.26	35.89	46.00	-10.11	QP
4	430.6100	32.52	-1.25	31.27	46.00	-14.73	QP
5	600.3600	31.27	2.49	33.76	46.00	-12.24	QP
6	760.4100	28.98	5.33	34.31	46.00	-11.69	QP

Note:1.Result (dBuV/m) = Correct Factor (dB/m) + Reading(dBuV).

Example: 31.77= -9.88+41.65.

2.Correction factor (dB/m) = Antenna Factor (dB/m) + Cable loss (dB) – Pre-Amplifier gain (dB).

3.When the peak results are less than average limit, so not need to evaluate the average.



Standard:	FCC Part 15.407	Test Distance:	3m
Test item:	Radiated Emission		
Frequency:	5745 MHz		
Mode:	Mode 2		
Ant.Polar.:	Vertical		

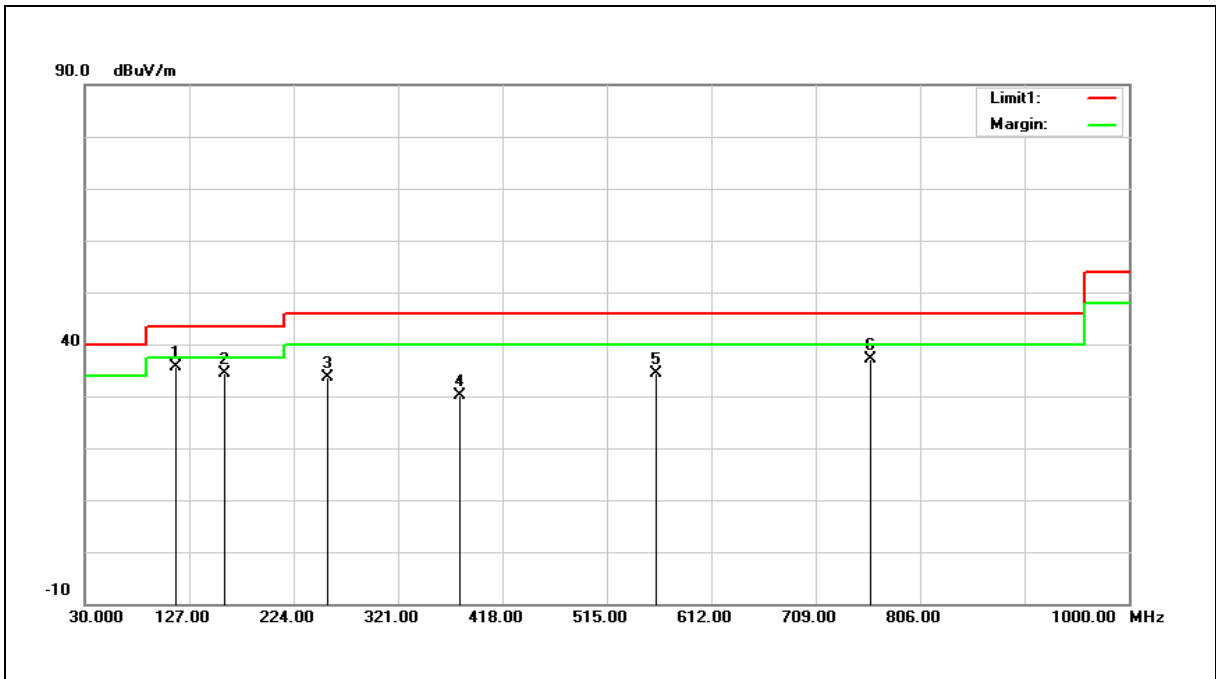

No.	Frequency (MHz)	Reading (dBuV)	Correct Factor (dB/m)	Result (dBuV/m)	Limit (dBuV/m)	Margin (dB)	Remark
1	114.3900	44.62	-8.89	35.73	43.50	-7.77	QP
2	159.9800	39.68	-5.41	34.27	43.50	-9.23	QP
3	255.0400	39.32	-5.79	33.53	46.00	-12.47	QP
4	378.2300	32.89	-2.66	30.23	46.00	-15.77	QP
5	560.5900	33.05	1.35	34.40	46.00	-11.60	QP
6	760.4100	31.73	5.33	37.06	46.00	-8.94	QP

Note:1.Result (dBuV/m) = Correct Factor (dB/m) + Reading(dBuV).

Example: 35.73= -8.89+44.62.

2.Correction factor (dB/m) = Antenna Factor (dB/m) + Cable loss (dB) – Pre-Amplifier gain (dB).

3.When the peak results are less than average limit, so not need to evaluate the average.



Above 1 GHz

Standard:	FCC Part 15.407	Test Distance:	3m
Test item:	Harmonic		
Frequency:	5180MHz		
Mode:	Mode 3		
Ant.Polar.:	Horizontal		

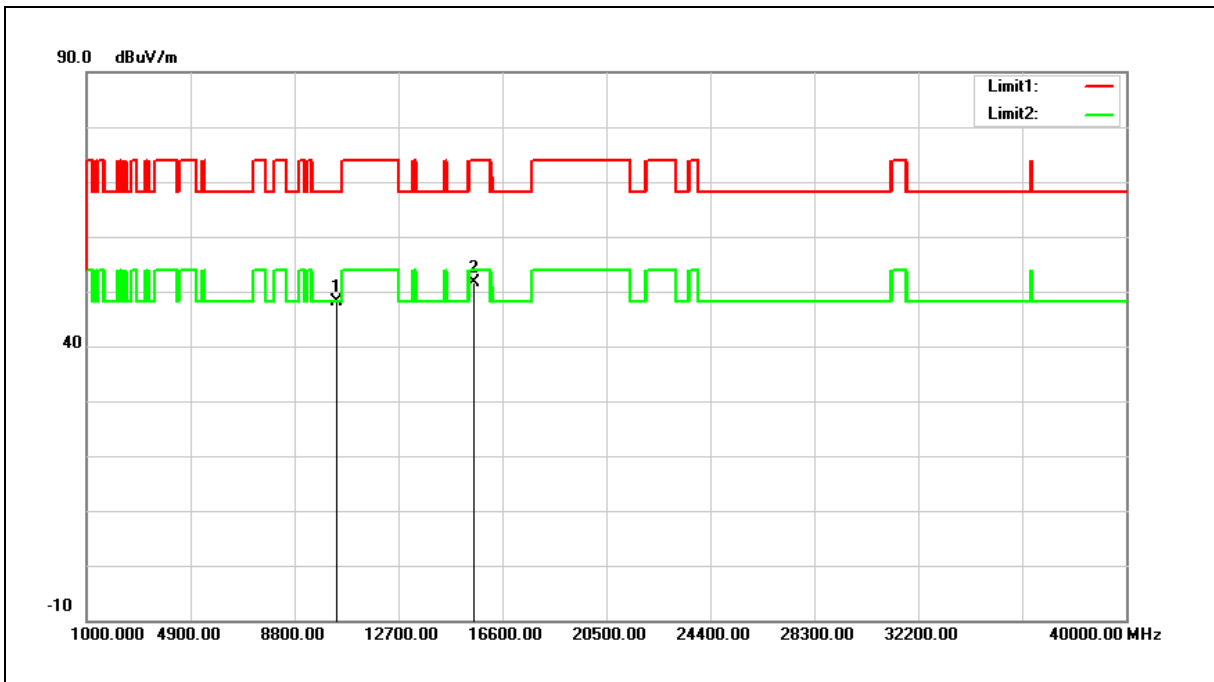

No.	Frequency (MHz)	Reading (dBuV)	Correct Factor (dB/m)	Result (dBuV/m)	Limit (dBuV/m)	Margin (dB)	Remark
1	10360.000	30.72	17.29	48.01	68.20	-20.19	peak
2	15540.000	30.77	20.75	51.52	74.00	-22.48	peak

Note:1.Result (dBuV/m) = Correct Factor (dB/m) + Reading(dBuV).

Example: 48.01= 17.29+30.72.

2.Correction factor (dB/m) = Antenna Factor (dB/m) + Cable loss (dB) – Pre-Amplifier gain (dB).

3.When the peak results are less than average limit, so not need to evaluate the average.



Standard:	FCC Part 15.407	Test Distance:	3m
Test item:	Harmonic		
Frequency:	5180MHz		
Mode:	Mode 3		
Ant.Polar.:	Vertical		

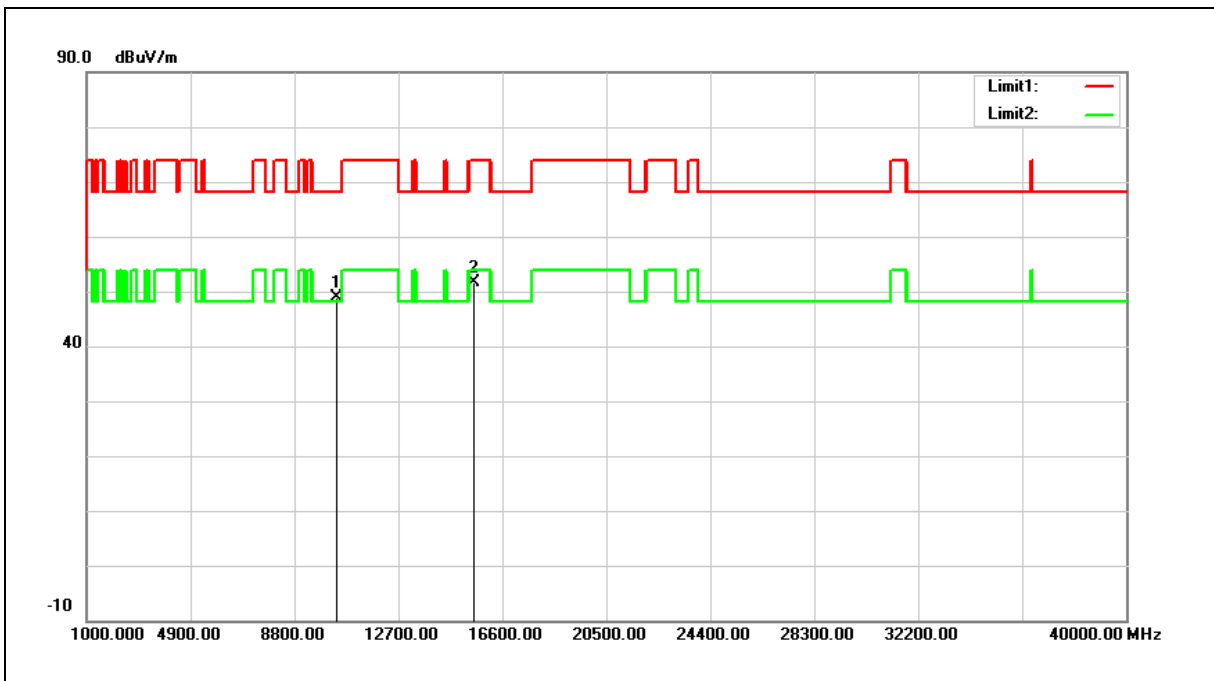

No.	Frequency (MHz)	Reading (dBuV)	Correct Factor (dB/m)	Result (dBuV/m)	Limit (dBuV/m)	Margin (dB)	Remark
1	10360.000	31.70	17.29	48.99	68.20	-19.21	peak
2	15540.000	30.90	20.75	51.65	74.00	-22.35	peak

Note:1.Result (dBuV/m) = Correct Factor (dB/m) + Reading(dBuV).

Example: 48.99= 17.29+31.70.

2.Correction factor (dB/m) = Antenna Factor (dB/m) + Cable loss (dB) – Pre-Amplifier gain (dB).

3.When the peak results are less than average limit, so not need to evaluate the average.



Standard:	FCC Part 15.407	Test Distance:	3m
Test item:	Harmonic		
Frequency:	5200MHz		
Mode:	Mode 3		
Ant.Polar.:	Horizontal		

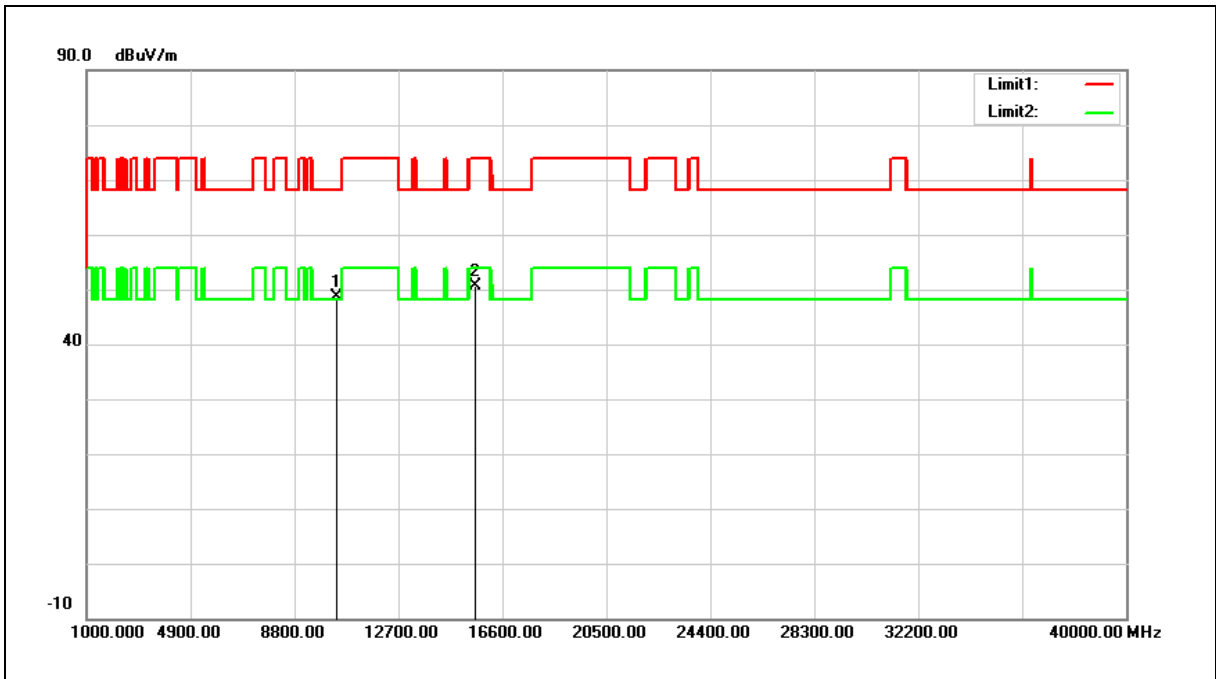

No.	Frequency (MHz)	Reading (dBuV)	Correct Factor (dB/m)	Result (dBuV/m)	Limit (dBuV/m)	Margin (dB)	Remark
1	10400.000	31.15	17.40	48.55	68.20	-19.65	peak
2	15600.000	29.91	20.60	50.51	74.00	-23.49	peak

Note:1.Result (dBuV/m) = Correct Factor (dB/m) + Reading(dBuV).

2.Correction factor (dB/m) = Antenna Factor (dB/m) + Cable loss (dB) – Pre-Amplifier gain (dB).

3.When the peak results are less than average limit, so not need to evaluate the average.



Standard:	FCC Part 15.407	Test Distance:	3m
Test item:	Harmonic		
Frequency:	5200MHz		
Mode:	Mode 3		
Ant.Polar.:	Vertical		

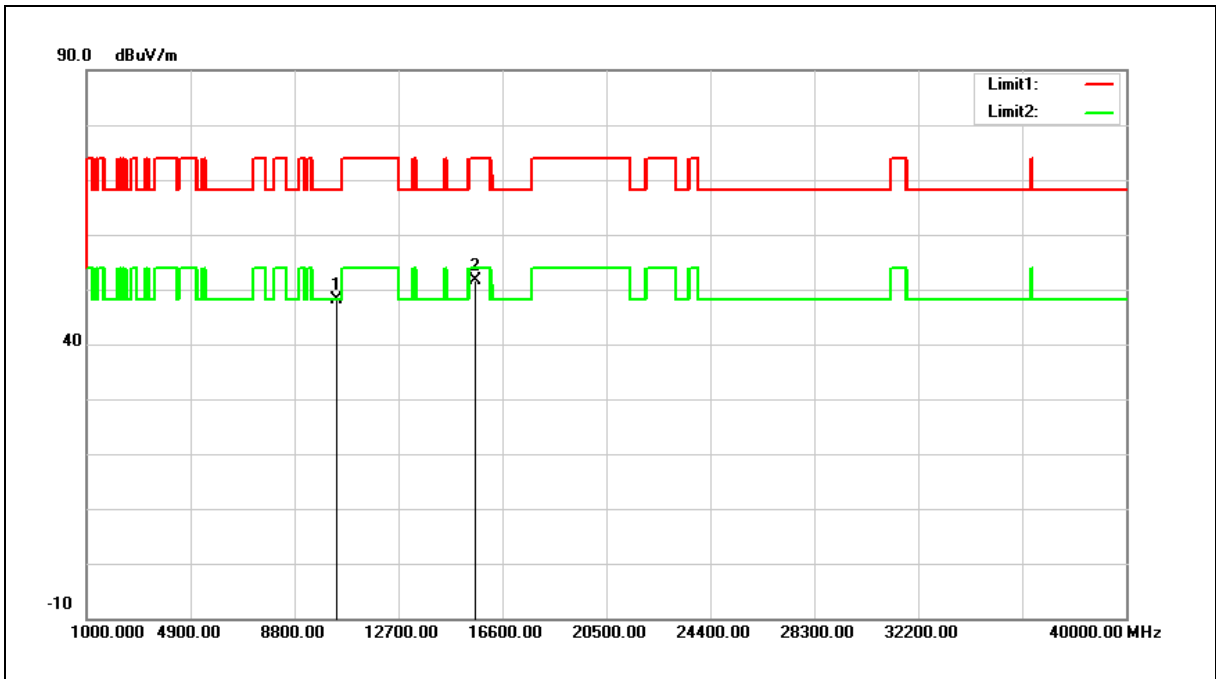

No.	Frequency (MHz)	Reading (dBuV)	Correct Factor (dB/m)	Result (dBuV/m)	Limit (dBuV/m)	Margin (dB)	Remark
1	10400.000	30.79	17.40	48.19	68.20	-20.01	peak
2	15600.000	31.08	20.60	51.68	74.00	-22.32	peak

Note:1.Result (dBuV/m) = Correct Factor (dB/m) + Reading(dBuV).

2.Correction factor (dB/m) = Antenna Factor (dB/m) + Cable loss (dB) – Pre-Amplifier gain (dB).

3.When the peak results are less than average limit, so not need to evaluate the average.



Standard:	FCC Part 15.407	Test Distance:	3m
Test item:	Harmonic		
Frequency:	5240MHz		
Mode:	Mode 3		
Ant.Polar.:	Horizontal		

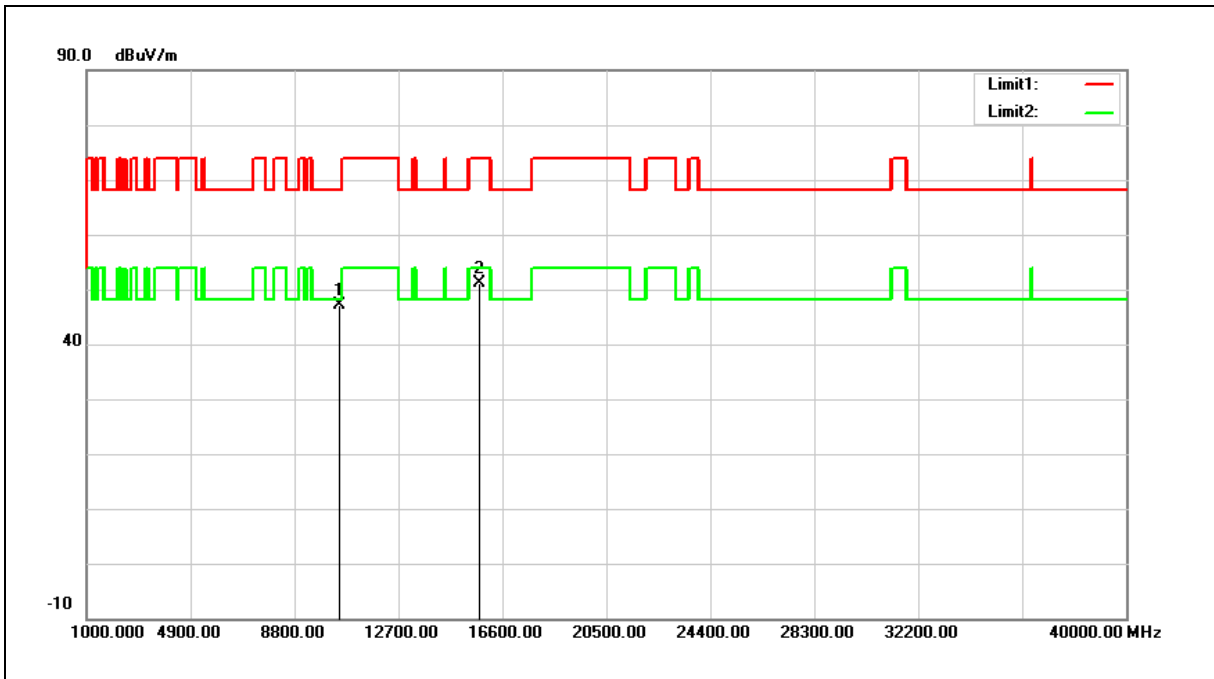

No.	Frequency (MHz)	Reading (dBuV)	Correct Factor (dB/m)	Result (dBuV/m)	Limit (dBuV/m)	Margin (dB)	Remark
1	10480.000	29.60	17.64	47.24	68.20	-20.96	peak
2	15720.000	30.80	20.30	51.10	74.00	-22.90	peak

Note:1.Result (dBuV/m) = Correct Factor (dB/m) + Reading(dBuV).

2.Correction factor (dB/m) = Antenna Factor (dB/m) + Cable loss (dB) – Pre-Amplifier gain (dB).

3.When the peak results are less than average limit, so not need to evaluate the average.



Standard:	FCC Part 15.407	Test Distance:	3m
Test item:	Harmonic		
Frequency:	5240MHz		
Mode:	Mode 3		
Ant.Polar.:	Vertical		

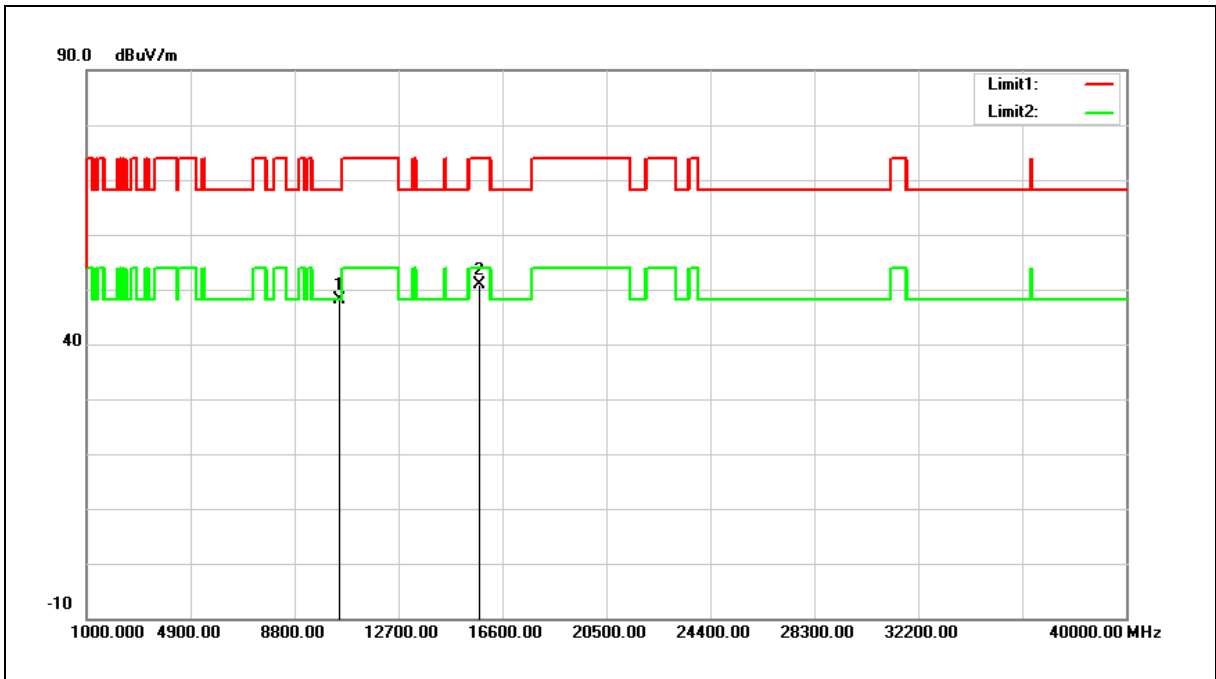

No.	Frequency (MHz)	Reading (dBuV)	Correct Factor (dB/m)	Result (dBuV/m)	Limit (dBuV/m)	Margin (dB)	Remark
1	10480.000	30.60	17.64	48.24	68.20	-19.96	peak
2	15720.000	30.59	20.30	50.89	74.00	-23.11	peak

Note:1.Result (dBuV/m) = Correct Factor (dB/m) + Reading(dBuV).

2.Correction factor (dB/m) = Antenna Factor (dB/m) + Cable loss (dB) – Pre-Amplifier gain (dB).

3.When the peak results are less than average limit, so not need to evaluate the average.

Standard:	FCC Part 15.407	Test Distance:	3m
Test item:	Harmonic		
Frequency:	5745MHz		
Mode:	Mode 3		
Ant.Polar.:	Horizontal		

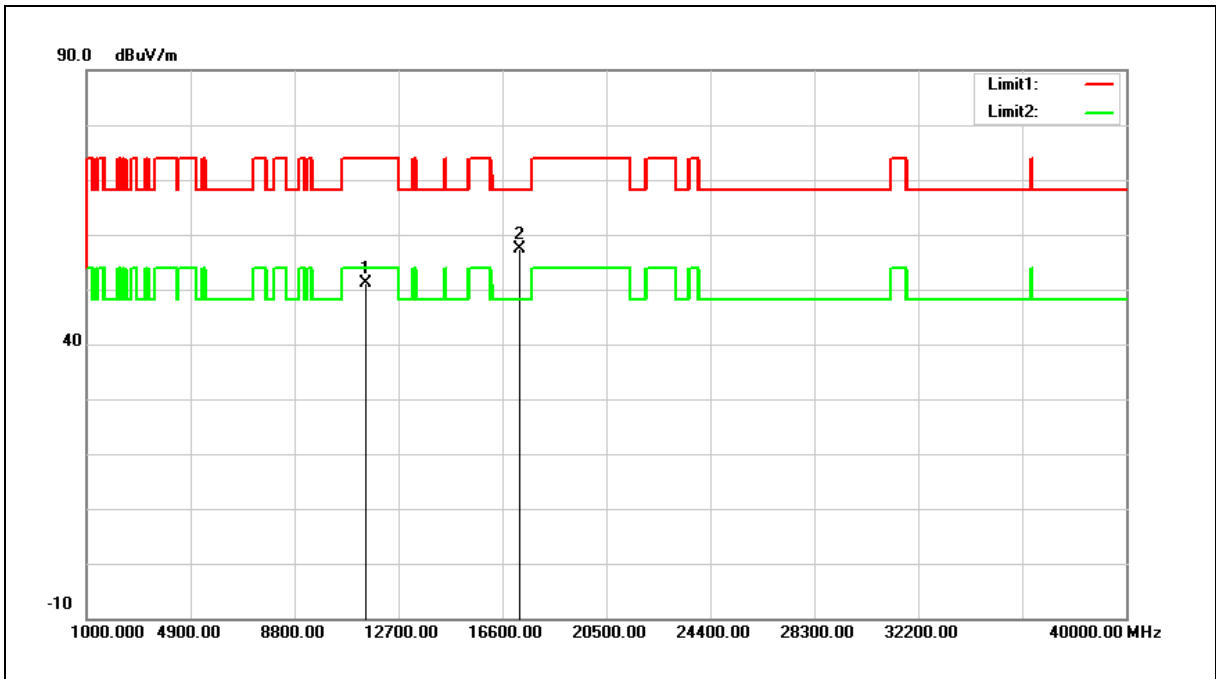

No.	Frequency (MHz)	Reading (dBuV)	Correct Factor (dB/m)	Result (dBuV/m)	Limit (dBuV/m)	Margin (dB)	Remark
1	11490.000	31.64	19.45	51.09	74.00	-22.91	peak
2	17235.000	32.25	25.01	57.26	68.20	-10.94	peak

Note:1.Result (dBuV/m) = Correct Factor (dB/m) + Reading(dBuV).

2.Correction factor (dB/m) = Antenna Factor (dB/m) + Cable loss (dB) – Pre-Amplifier gain (dB).

3.When the peak results are less than average limit, so not need to evaluate the average.

Standard:	FCC Part 15.407	Test Distance:	3m
Test item:	Harmonic		
Frequency:	5745MHz		
Mode:	Mode 3		
Ant.Polar.:	Vertical		

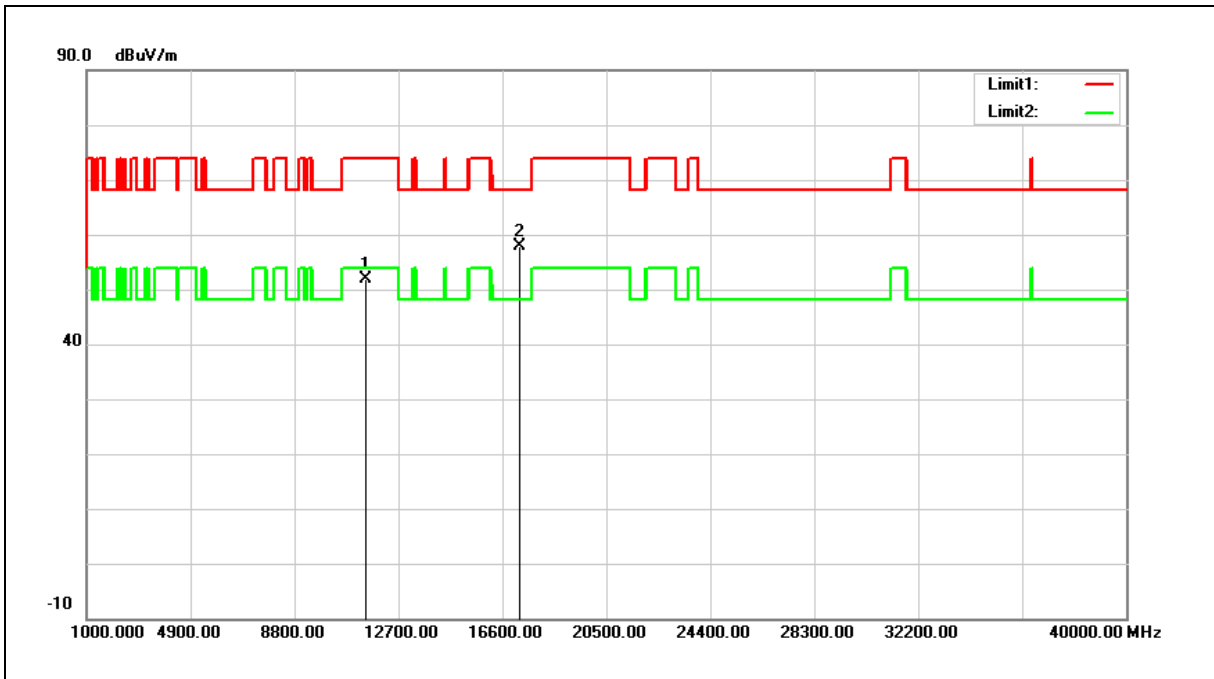

No.	Frequency (MHz)	Reading (dBuV)	Correct Factor (dB/m)	Result (dBuV/m)	Limit (dBuV/m)	Margin (dB)	Remark
1	11490.000	32.43	19.45	51.88	74.00	-22.12	peak
2	17235.000	32.91	25.01	57.92	68.20	-10.28	peak

Note:1.Result (dBuV/m) = Correct Factor (dB/m) + Reading(dBuV).

2.Correction factor (dB/m) = Antenna Factor (dB/m) + Cable loss (dB) – Pre-Amplifier gain (dB).

3.When the peak results are less than average limit, so not need to evaluate the average.

Standard:	FCC Part 15.407	Test Distance:	3m
Test item:	Harmonic		
Frequency:	5785MHz		
Mode:	Mode 3		
Ant.Polar.:	Horizontal		

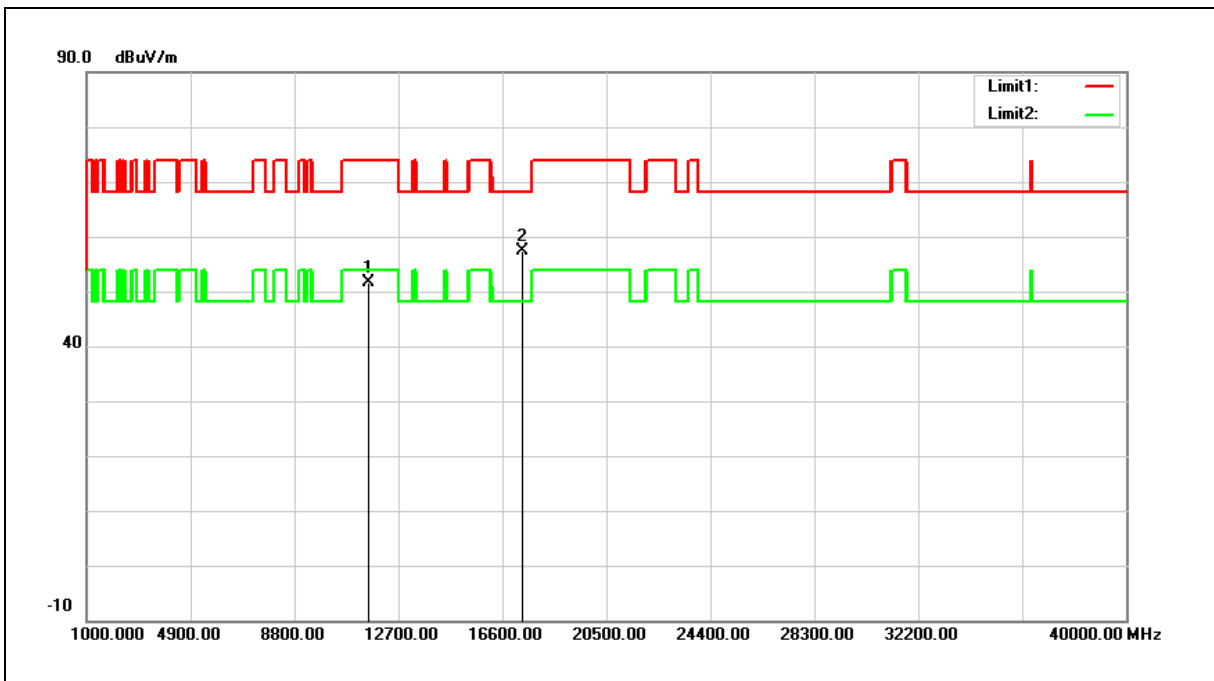

No.	Frequency (MHz)	Reading (dBuV)	Correct Factor (dB/m)	Result (dBuV/m)	Limit (dBuV/m)	Margin (dB)	Remark
1	11570.000	32.32	19.39	51.71	74.00	-22.29	peak
2	17355.000	32.15	25.34	57.49	68.20	-10.71	peak

Note:1.Result (dBuV/m) = Correct Factor (dB/m) + Reading(dBuV).

2.Correction factor (dB/m) = Antenna Factor (dB/m) + Cable loss (dB) – Pre-Amplifier gain (dB).

3.When the peak results are less than average limit, so not need to evaluate the average.



Standard:	FCC Part 15.407	Test Distance:	3m
Test item:	Harmonic		
Frequency:	5785MHz		
Mode:	Mode 3		
Ant.Polar.:	Vertical		

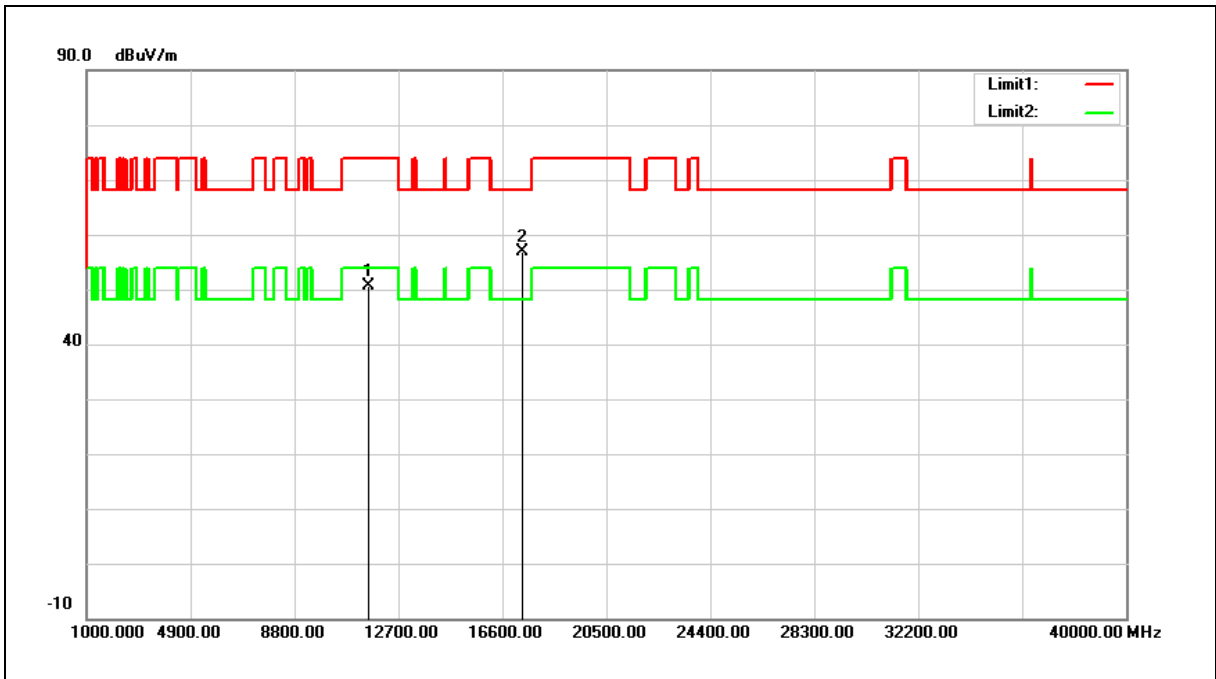

No.	Frequency (MHz)	Reading (dBuV)	Correct Factor (dB/m)	Result (dBuV/m)	Limit (dBuV/m)	Margin (dB)	Remark
1	11570.000	31.33	19.39	50.72	74.00	-23.28	peak
2	17355.000	31.64	25.34	56.98	68.20	-11.22	peak

Note:1.Result (dBuV/m) = Correct Factor (dB/m) + Reading(dBuV).

2.Correction factor (dB/m) = Antenna Factor (dB/m) + Cable loss (dB) – Pre-Amplifier gain (dB).

3.When the peak results are less than average limit, so not need to evaluate the average.



Standard:	FCC Part 15.407	Test Distance:	3m
Test item:	Harmonic		
Frequency:	5825MHz		
Mode:	Mode 3		
Ant.Polar.:	Horizontal		

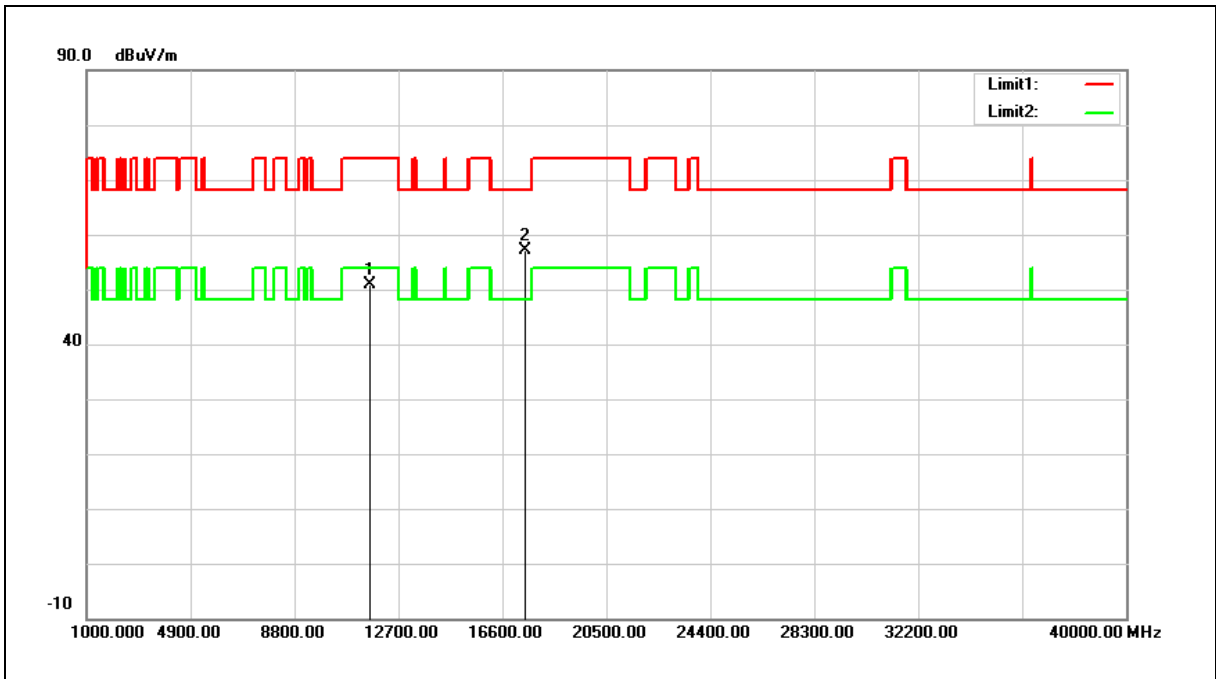

No.	Frequency (MHz)	Reading (dBuV)	Correct Factor (dB/m)	Result (dBuV/m)	Limit (dBuV/m)	Margin (dB)	Remark
1	11650.000	31.49	19.32	50.81	74.00	-23.19	peak
2	17475.000	31.59	25.65	57.24	68.20	-10.96	peak

Note:1.Result (dBuV/m) = Correct Factor (dB/m) + Reading(dBuV).

2.Correction factor (dB/m) = Antenna Factor (dB/m) + Cable loss (dB) – Pre-Amplifier gain (dB).

3.When the peak results are less than average limit, so not need to evaluate the average.



Standard:	FCC Part 15.407	Test Distance:	3m
Test item:	Harmonic		
Frequency:	5825MHz		
Mode:	Mode 3		
Ant.Polar.:	Vertical		

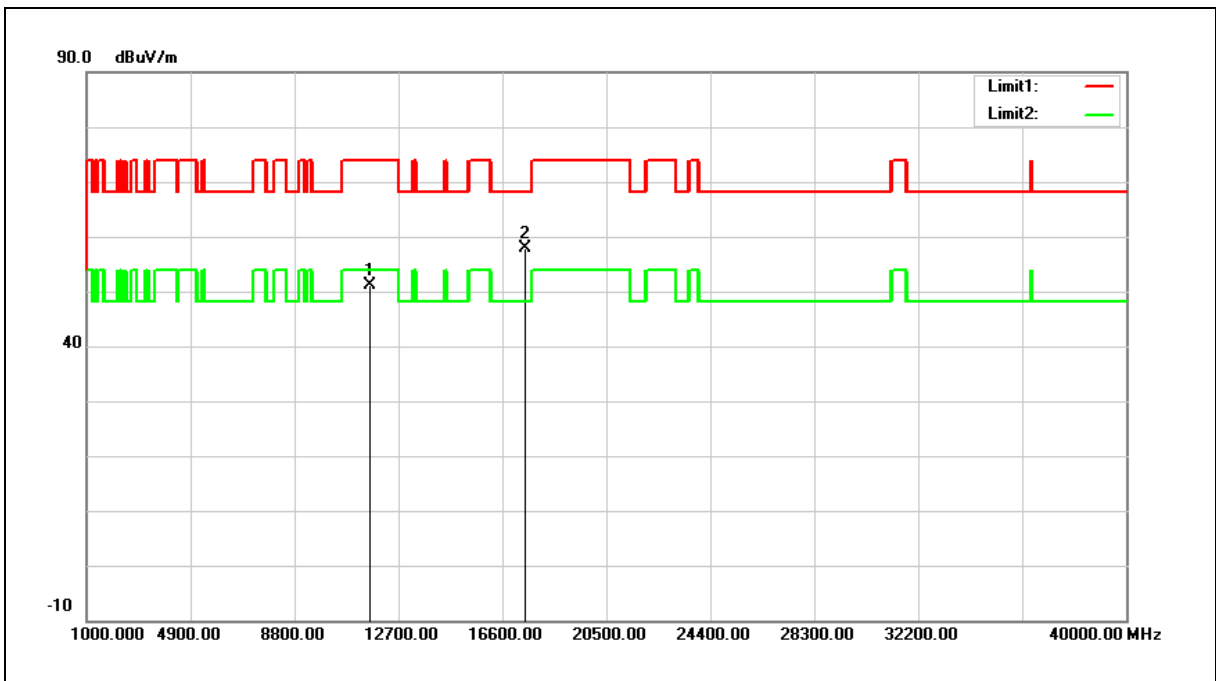

No.	Frequency (MHz)	Reading (dBuV)	Correct Factor (dB/m)	Result (dBuV/m)	Limit (dBuV/m)	Margin (dB)	Remark
1	11650.000	31.71	19.32	51.03	74.00	-22.97	peak
2	17475.000	32.14	25.65	57.79	68.20	-10.41	peak

Note:1.Result (dBuV/m) = Correct Factor (dB/m) + Reading(dBuV).

2.Correction factor (dB/m) = Antenna Factor (dB/m) + Cable loss (dB) – Pre-Amplifier gain (dB).

3.When the peak results are less than average limit, so not need to evaluate the average.



Standard:	FCC Part 15.407	Test Distance:	3m
Test item:	Harmonic		
Frequency:	5190MHz		
Mode:	Mode 4		
Ant.Polar.:	Horizontal		

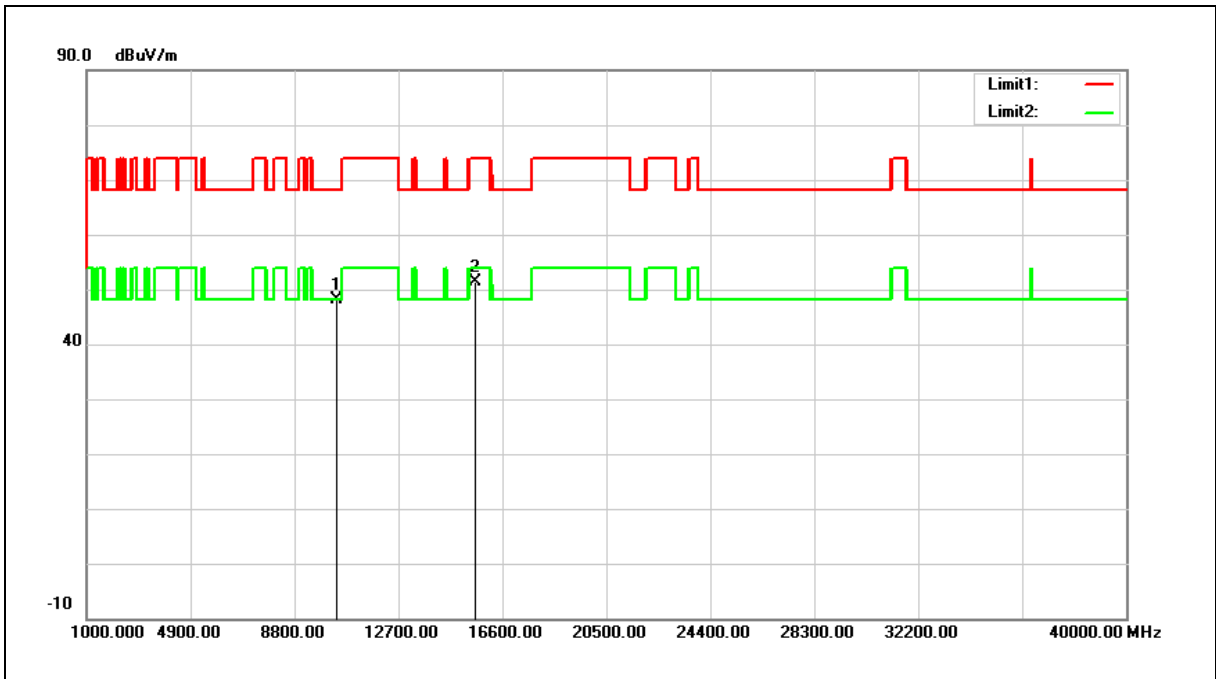

No.	Frequency (MHz)	Reading (dBuV)	Correct Factor (dB/m)	Result (dBuV/m)	Limit (dBuV/m)	Margin (dB)	Remark
1	10380.000	30.72	17.35	48.07	68.20	-20.13	peak
2	15570.000	30.60	20.68	51.28	74.00	-22.72	peak

Note:1.Result (dBuV/m) = Correct Factor (dB/m) + Reading(dBuV).

2.Correction factor (dB/m) = Antenna Factor (dB/m) + Cable loss (dB) – Pre-Amplifier gain (dB).

3.When the peak results are less than average limit, so not need to evaluate the average.



Standard:	FCC Part 15.407	Test Distance:	3m
Test item:	Harmonic		
Frequency:	5190MHz		
Mode:	Mode 4		
Ant.Polar.:	Vertical		

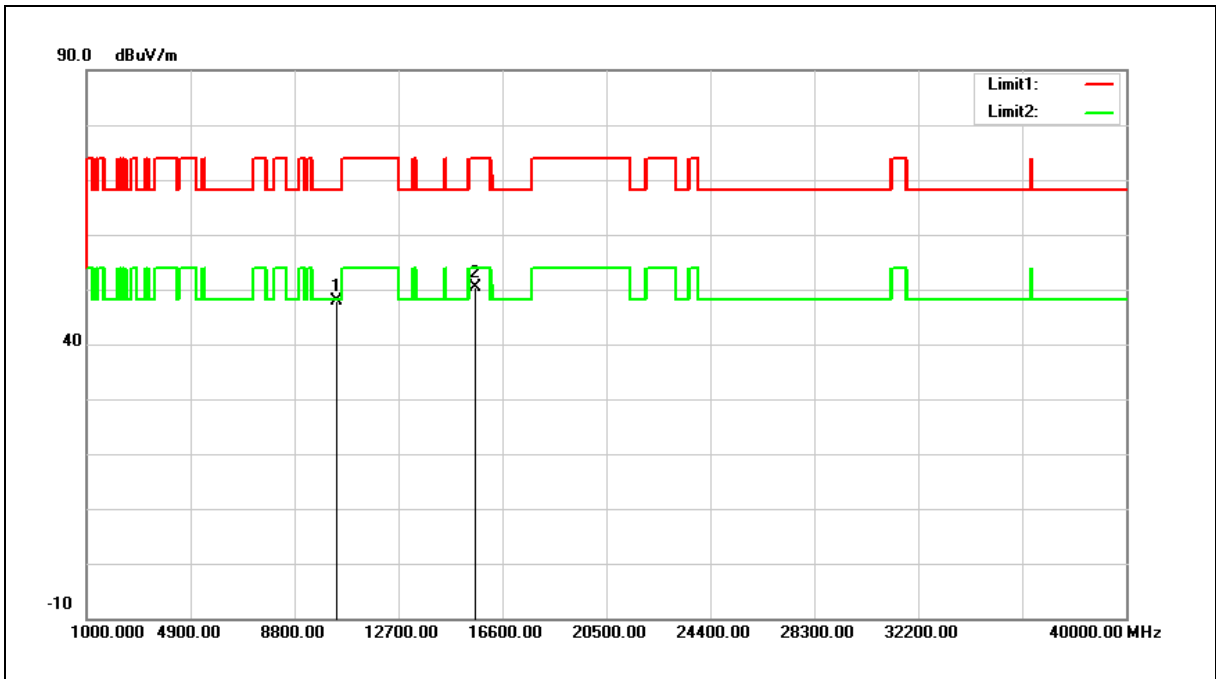

No.	Frequency (MHz)	Reading (dBuV)	Correct Factor (dB/m)	Result (dBuV/m)	Limit (dBuV/m)	Margin (dB)	Remark
1	10380.000	30.43	17.35	47.78	68.20	-20.42	peak
2	15570.000	29.62	20.68	50.30	74.00	-23.70	peak

Note:1.Result (dBuV/m) = Correct Factor (dB/m) + Reading(dBuV).

2.Correction factor (dB/m) = Antenna Factor (dB/m) + Cable loss (dB) – Pre-Amplifier gain (dB).

3.When the peak results are less than average limit, so not need to evaluate the average.



Standard:	FCC Part 15.407	Test Distance:	3m
Test item:	Harmonic		
Frequency:	5230MHz		
Mode:	Mode 4		
Ant.Polar.:	Horizontal		

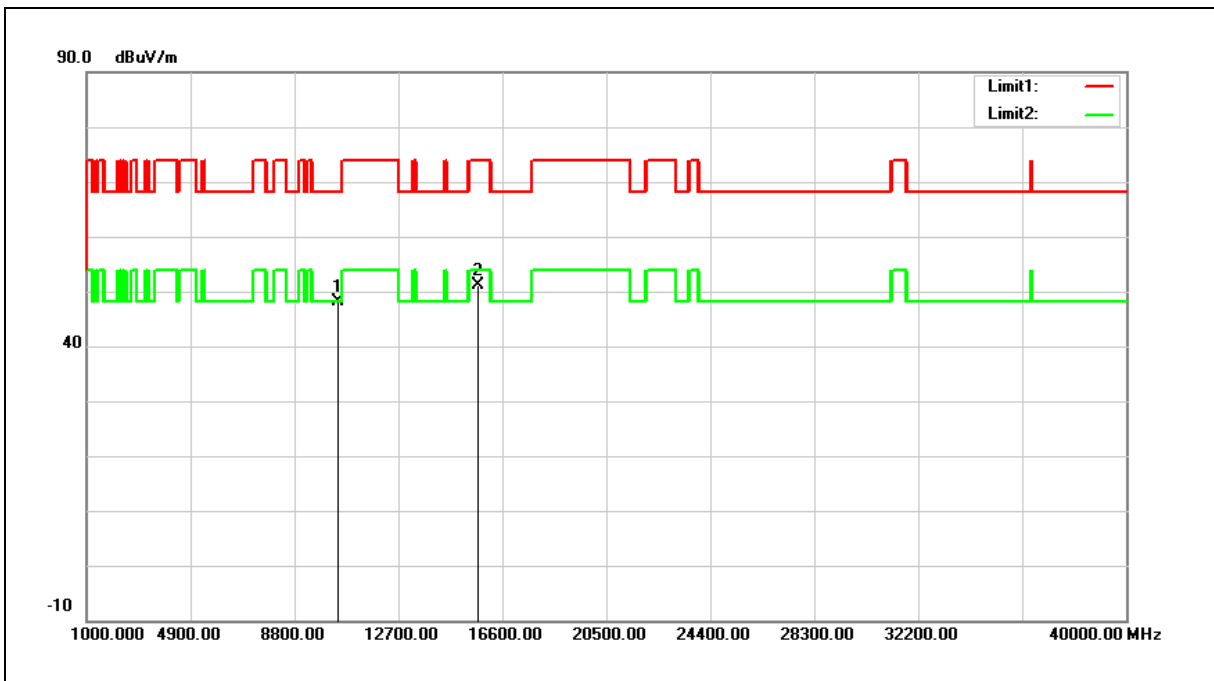

No.	Frequency (MHz)	Reading (dBuV)	Correct Factor (dB/m)	Result (dBuV/m)	Limit (dBuV/m)	Margin (dB)	Remark
1	10460.000	30.54	17.59	48.13	68.20	-20.07	peak
2	15690.000	30.70	20.37	51.07	74.00	-22.93	peak

Note:1.Result (dBuV/m) = Correct Factor (dB/m) + Reading(dBuV).

2.Correction factor (dB/m) = Antenna Factor (dB/m) + Cable loss (dB) – Pre-Amplifier gain (dB).

3.When the peak results are less than average limit, so not need to evaluate the average.



Standard:	FCC Part 15.407	Test Distance:	3m
Test item:	Harmonic		
Frequency:	5230MHz		
Mode:	Mode 4		
Ant.Polar.:	Vertical		

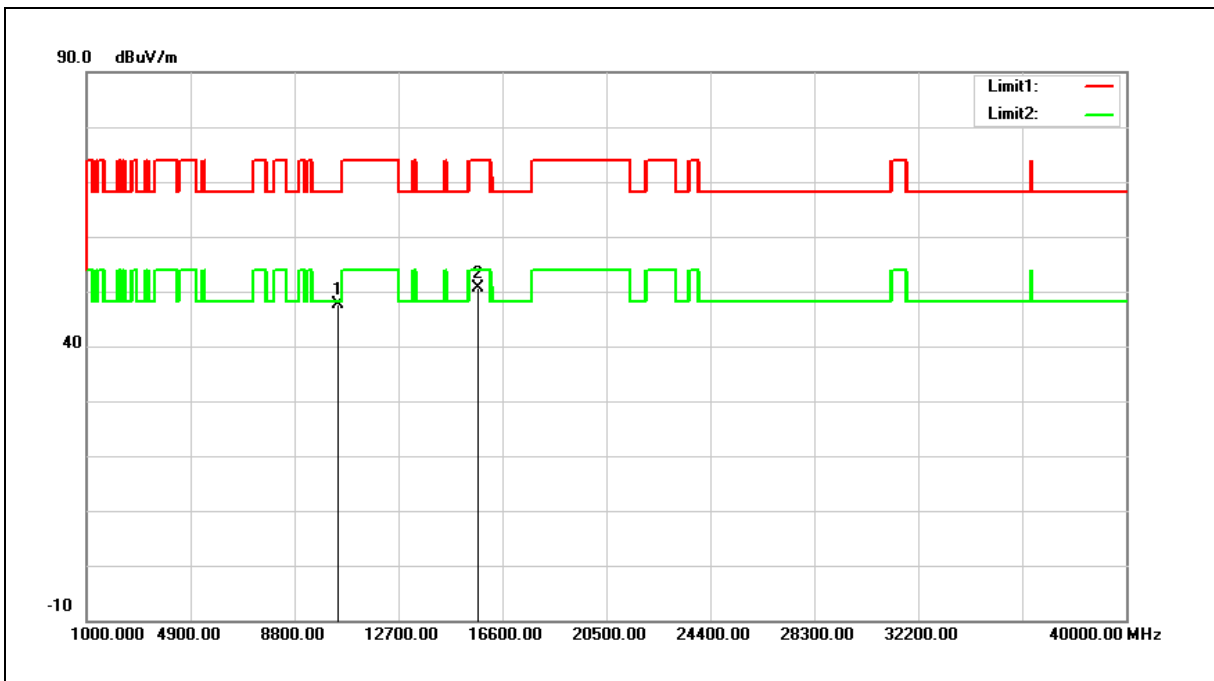

No.	Frequency (MHz)	Reading (dBuV)	Correct Factor (dB/m)	Result (dBuV/m)	Limit (dBuV/m)	Margin (dB)	Remark
1	10460.000	30.02	17.59	47.61	68.20	-20.59	peak
2	15690.000	30.18	20.37	50.55	74.00	-23.45	peak

Note:1.Result (dBuV/m) = Correct Factor (dB/m) + Reading(dBuV).

2.Correction factor (dB/m) = Antenna Factor (dB/m) + Cable loss (dB) – Pre-Amplifier gain (dB).

3.When the peak results are less than average limit, so not need to evaluate the average.



Standard:	FCC Part 15.407	Test Distance:	3m
Test item:	Harmonic		
Frequency:	5755MHz		
Mode:	Mode 4		
Ant.Polar.:	Horizontal		

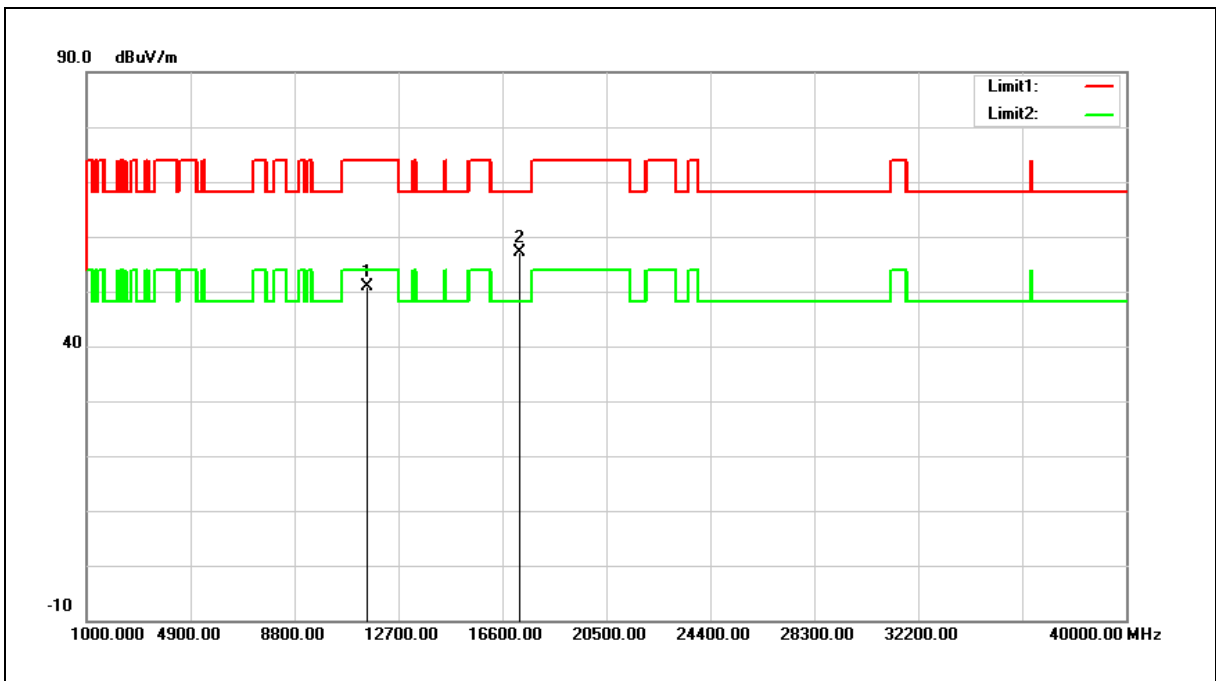

No.	Frequency (MHz)	Reading (dBuV)	Correct Factor (dB/m)	Result (dBuV/m)	Limit (dBuV/m)	Margin (dB)	Remark
1	11510.000	31.41	19.46	50.87	74.00	-23.13	peak
2	17265.000	31.94	25.09	57.03	68.20	-11.17	peak

Note:1.Result (dBuV/m) = Correct Factor (dB/m) + Reading(dBuV).

2.Correction factor (dB/m) = Antenna Factor (dB/m) + Cable loss (dB) – Pre-Amplifier gain (dB).

3.When the peak results are less than average limit, so not need to evaluate the average.



Standard:	FCC Part 15.407	Test Distance:	3m
Test item:	Harmonic		
Frequency:	5755MHz		
Mode:	Mode 4		
Ant.Polar.:	Vertical		

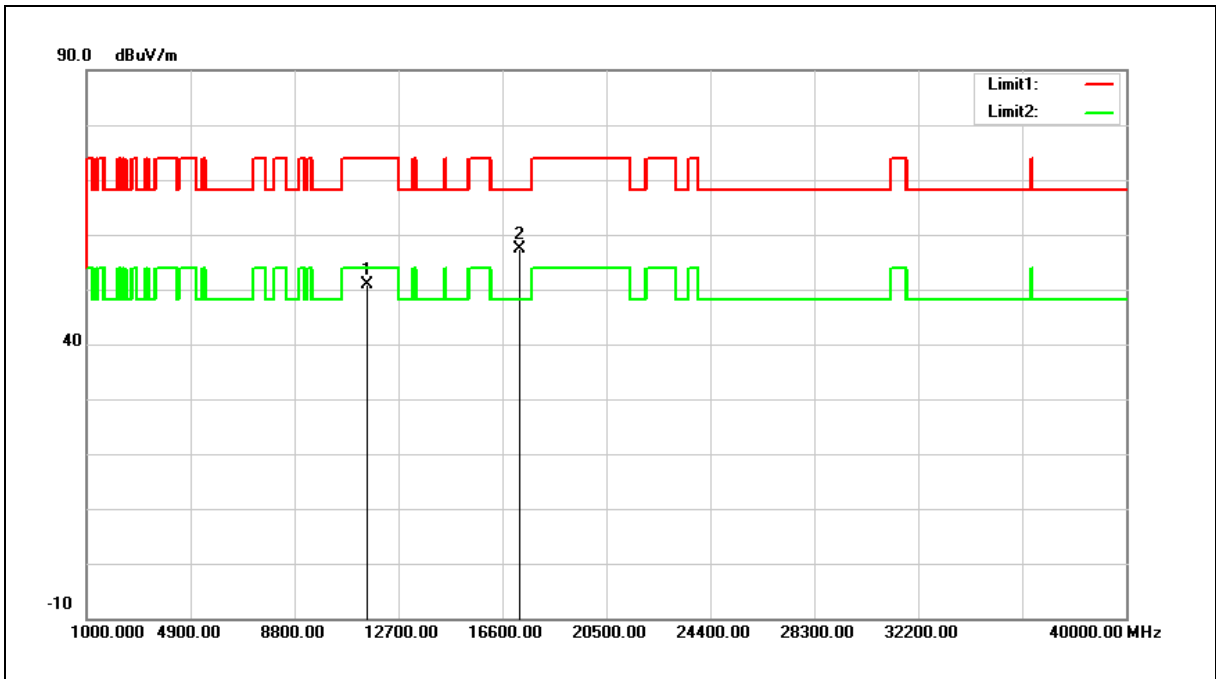

No.	Frequency (MHz)	Reading (dBuV)	Correct Factor (dB/m)	Result (dBuV/m)	Limit (dBuV/m)	Margin (dB)	Remark
1	11510.000	31.50	19.46	50.96	74.00	-23.04	peak
2	17265.000	32.23	25.09	57.32	68.20	-10.88	peak

Note:1.Result (dBuV/m) = Correct Factor (dB/m) + Reading(dBuV).

2.Correction factor (dB/m) = Antenna Factor (dB/m) + Cable loss (dB) – Pre-Amplifier gain (dB).

3.When the peak results are less than average limit, so not need to evaluate the average.



Standard:	FCC Part 15.407	Test Distance:	3m
Test item:	Harmonic		
Frequency:	5795MHz		
Mode:	Mode 4		
Ant.Polar.:	Horizontal		

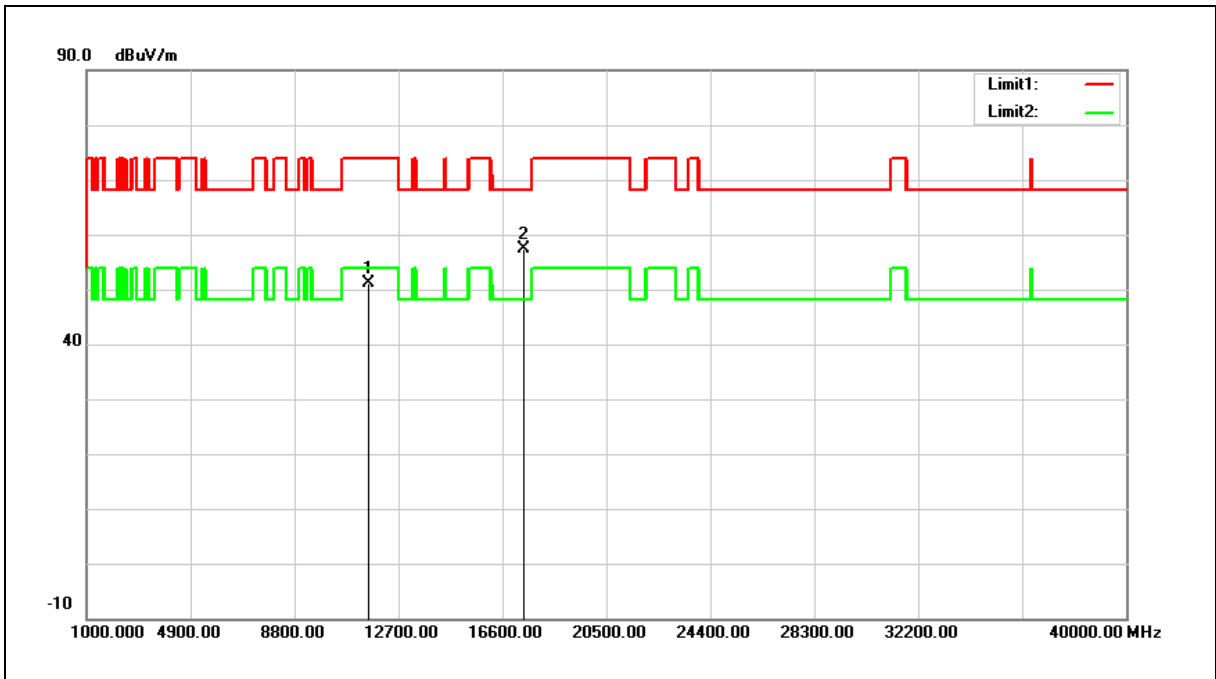

No.	Frequency (MHz)	Reading (dBuV)	Correct Factor (dB/m)	Result (dBuV/m)	Limit (dBuV/m)	Margin (dB)	Remark
1	11590.000	31.81	19.38	51.19	74.00	-22.81	peak
2	17385.000	31.91	25.41	57.32	68.20	-10.88	peak

Note:1.Result (dBuV/m) = Correct Factor (dB/m) + Reading(dBuV).

2.Correction factor (dB/m) = Antenna Factor (dB/m) + Cable loss (dB) – Pre-Amplifier gain (dB).

3.When the peak results are less than average limit, so not need to evaluate the average.



Standard:	FCC Part 15.407	Test Distance:	3m
Test item:	Harmonic		
Frequency:	5795MHz		
Mode:	Mode 4		
Ant.Polar.:	Vertical		

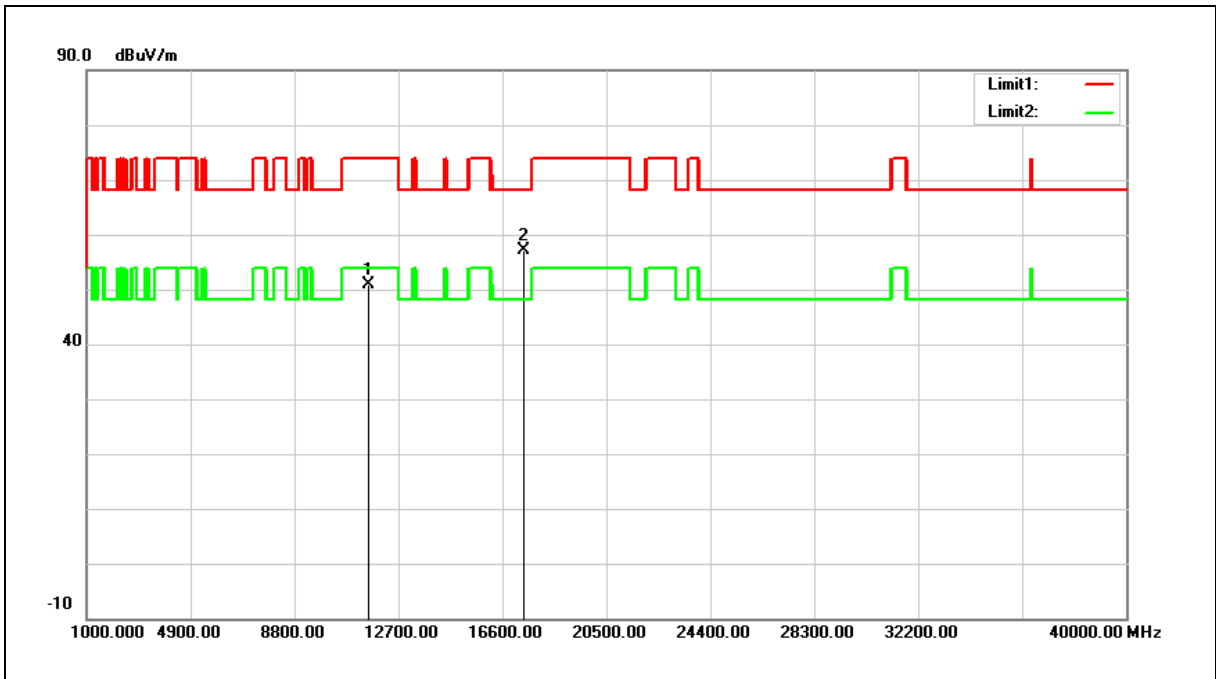

No.	Frequency (MHz)	Reading (dBuV)	Correct Factor (dB/m)	Result (dBuV/m)	Limit (dBuV/m)	Margin (dB)	Remark
1	11590.000	31.39	19.38	50.77	74.00	-23.23	peak
2	17385.000	31.84	25.41	57.25	68.20	-10.95	peak

- Note:1.Result (dBuV/m) = Correct Factor (dB/m) + Reading(dBuV).
- 2.Correction factor (dB/m) = Antenna Factor (dB/m) + Cable loss (dB) – Pre-Amplifier gain (dB).
- 3.When the peak results are less than average limit, so not need to evaluate the average.



Standard:	FCC Part 15.407	Test Distance:	3m
Test item:	Harmonic		
Frequency:	5210MHz		
Mode:	Mode 5		
Ant.Polar.:	Horizontal		

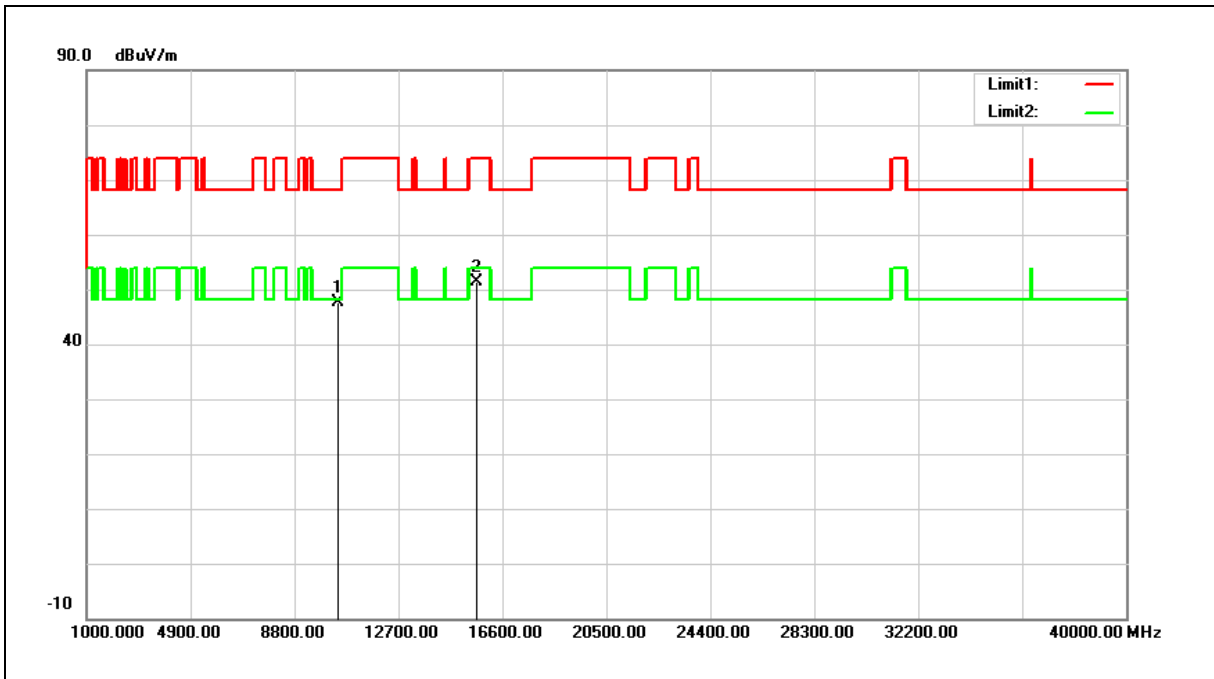

No.	Frequency (MHz)	Reading (dBuV)	Correct Factor (dB/m)	Result (dBuV/m)	Limit (dBuV/m)	Margin (dB)	Remark
1	10420.000	30.20	17.46	47.66	68.20	-20.54	peak
2	15630.000	30.94	20.53	51.47	74.00	-22.53	peak

Note:1.Result (dBuV/m) = Correct Factor (dB/m) + Reading(dBuV).

2.Correction factor (dB/m) = Antenna Factor (dB/m) + Cable loss (dB) – Pre-Amplifier gain (dB).

3.When the peak results are less than average limit, so not need to evaluate the average.



Standard:	FCC Part 15.407	Test Distance:	3m
Test item:	Harmonic		
Frequency:	5210MHz		
Mode:	Mode 5		
Ant.Polar.:	Vertical		

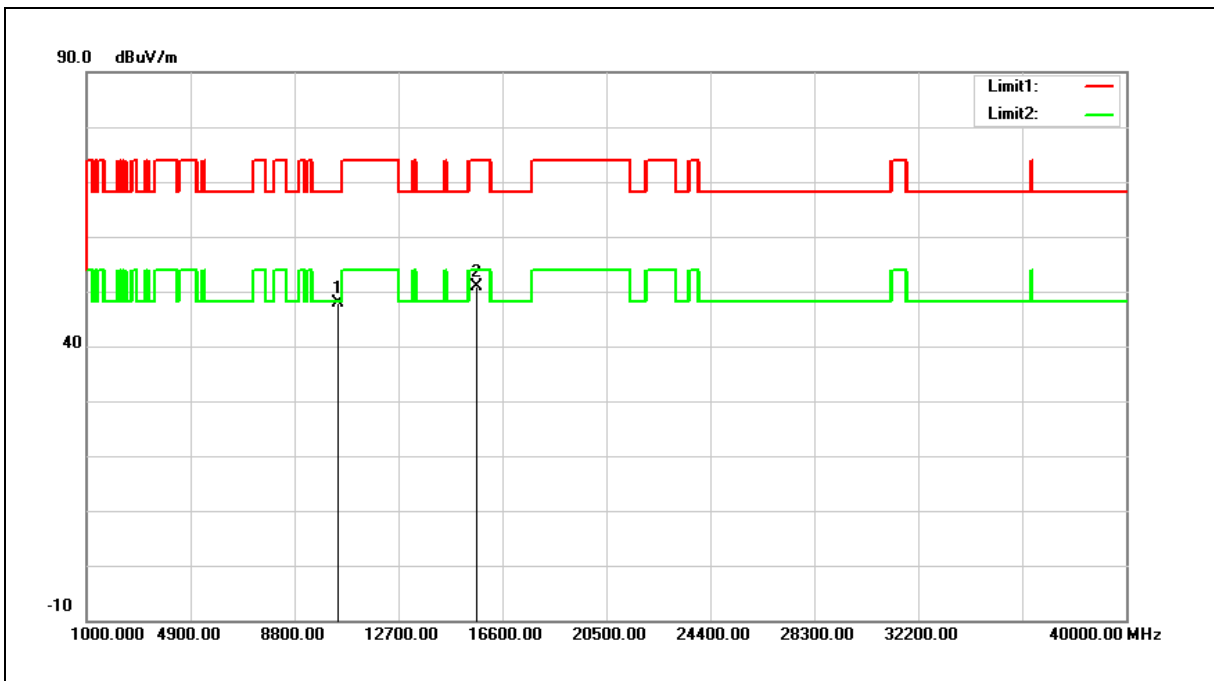

No.	Frequency (MHz)	Reading (dBuV)	Correct Factor (dB/m)	Result (dBuV/m)	Limit (dBuV/m)	Margin (dB)	Remark
1	10420.000	30.35	17.46	47.81	68.20	-20.39	peak
2	15630.000	30.38	20.53	50.91	74.00	-23.09	peak

Note:1.Result (dBuV/m) = Correct Factor (dB/m) + Reading(dBuV).

2.Correction factor (dB/m) = Antenna Factor (dB/m) + Cable loss (dB) – Pre-Amplifier gain (dB).

3.When the peak results are less than average limit, so not need to evaluate the average.



Standard:	FCC Part 15.407	Test Distance:	3m
Test item:	Harmonic		
Frequency:	5775MHz		
Mode:	Mode 5		
Ant.Polar.:	Horizontal		

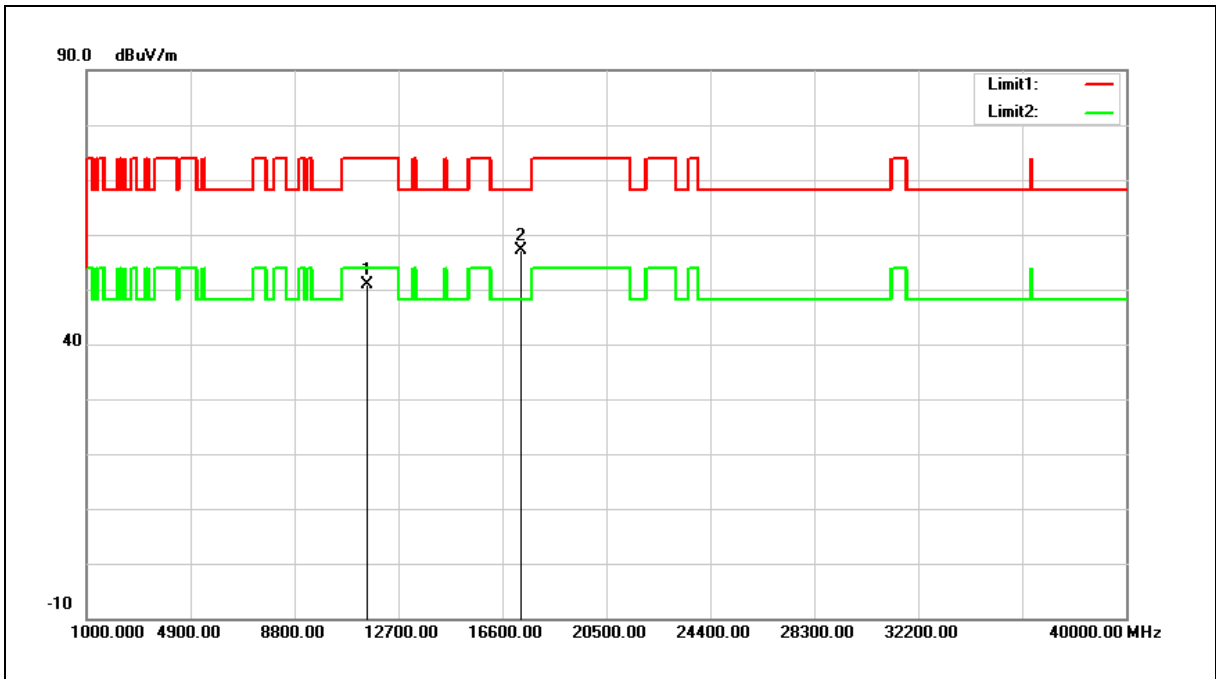

No.	Frequency (MHz)	Reading (dBuV)	Correct Factor (dB/m)	Result (dBuV/m)	Limit (dBuV/m)	Margin (dB)	Remark
1	11550.000	31.58	19.42	51.00	74.00	-23.00	peak
2	17325.000	31.79	25.25	57.04	68.20	-11.16	peak

Note:1.Result (dBuV/m) = Correct Factor (dB/m) + Reading(dBuV).

2.Correction factor (dB/m) = Antenna Factor (dB/m) + Cable loss (dB) – Pre-Amplifier gain (dB).

3.When the peak results are less than average limit, so not need to evaluate the average.



Standard:	FCC Part 15.407	Test Distance:	3m
Test item:	Harmonic		
Frequency:	5775MHz		
Mode:	Mode 5		
Ant.Polar.:	Vertical		

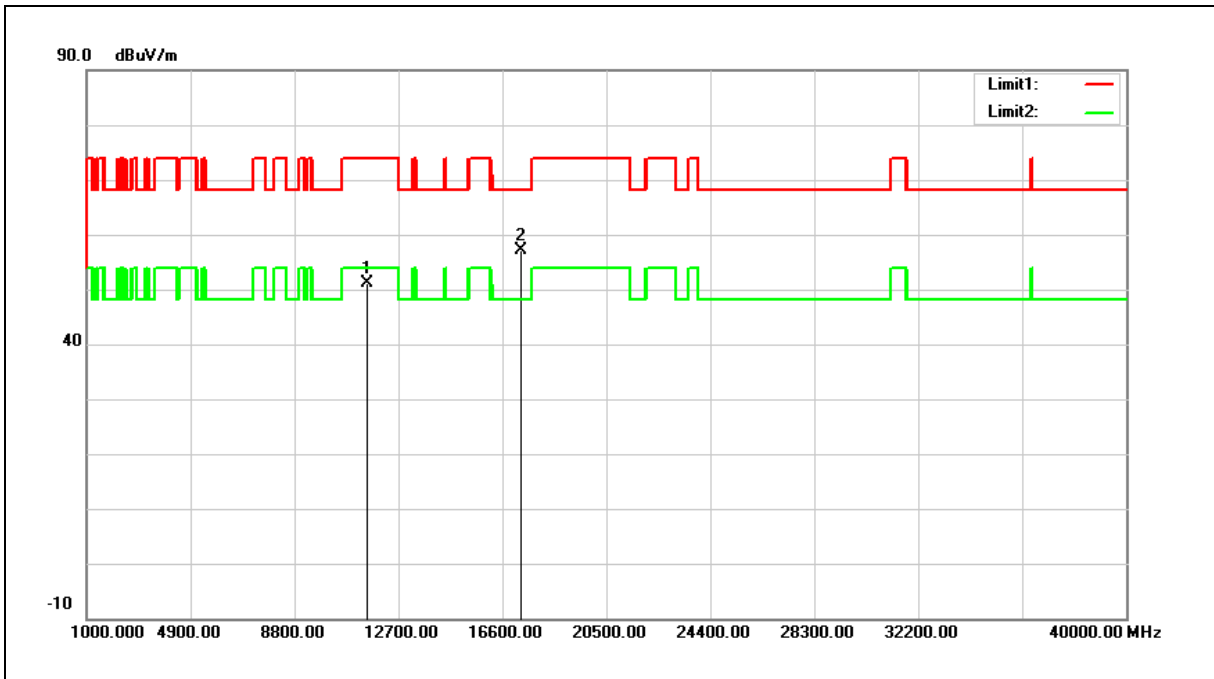

No.	Frequency (MHz)	Reading (dBuV)	Correct Factor (dB/m)	Result (dBuV/m)	Limit (dBuV/m)	Margin (dB)	Remark
1	11550.000	31.66	19.42	51.08	74.00	-22.92	peak
2	17325.000	31.81	25.25	57.06	68.20	-11.14	peak

Note:1.Result (dBuV/m) = Correct Factor (dB/m) + Reading(dBuV).

2.Correction factor (dB/m) = Antenna Factor (dB/m) + Cable loss (dB) – Pre-Amplifier gain (dB).

3.When the peak results are less than average limit, so not need to evaluate the average.



Standard:	FCC Part 15.407	Test Distance:	3m
Test item:	Harmonic		
Frequency:	5180MHz		
Mode:	Mode 6		
Ant.Polar.:	Horizontal		

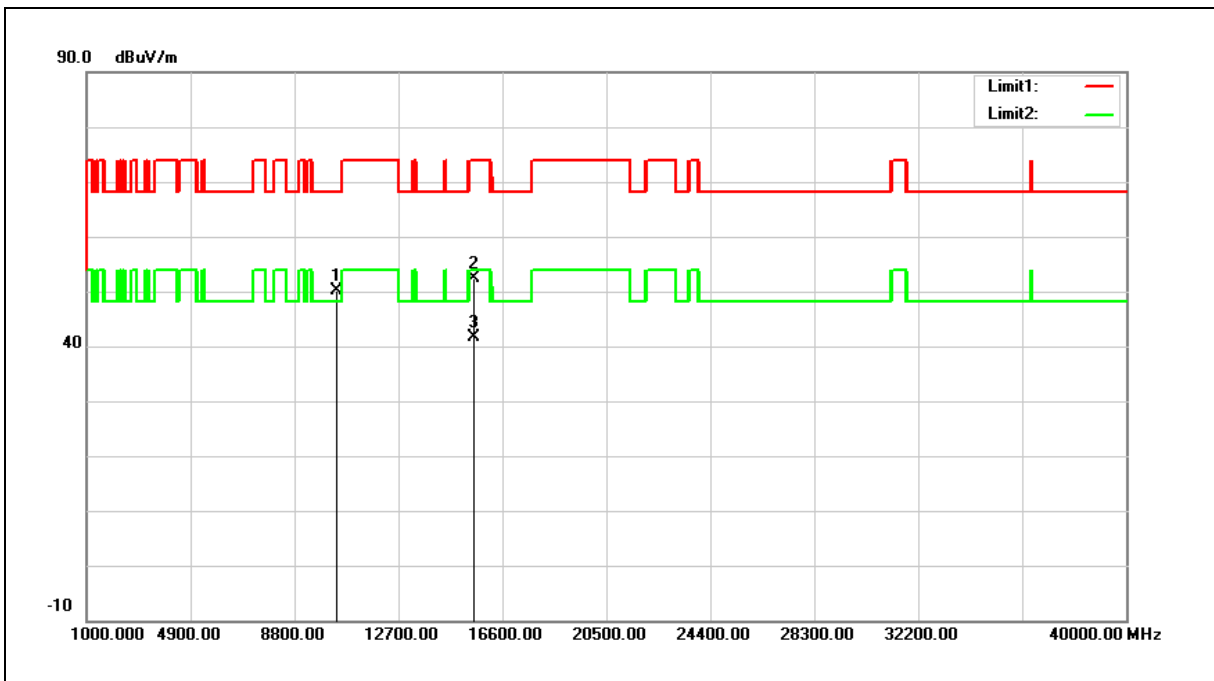

No.	Frequency (MHz)	Reading (dBuV)	Correct Factor (dB/m)	Result (dBuV/m)	Limit (dBuV/m)	Margin (dB)	Remark
1	10360.000	32.88	17.29	50.17	68.20	-18.03	peak
2	15540.000	31.65	20.75	52.40	74.00	-21.60	peak
3	15540.000	20.96	20.75	41.71	54.00	-12.29	AVG

Note:1.Result (dBuV/m) = Correct Factor (dB/m) + Reading(dBuV).

2.Correction factor (dB/m) = Antenna Factor (dB/m) + Cable loss (dB) – Pre-Amplifier gain (dB).

3.When the peak results are less than average limit, so not need to evaluate the average.



Standard:	FCC Part 15.407	Test Distance:	3m
Test item:	Harmonic		
Frequency:	5180MHz		
Mode:	Mode 6		
Ant.Polar.:	Vertical		

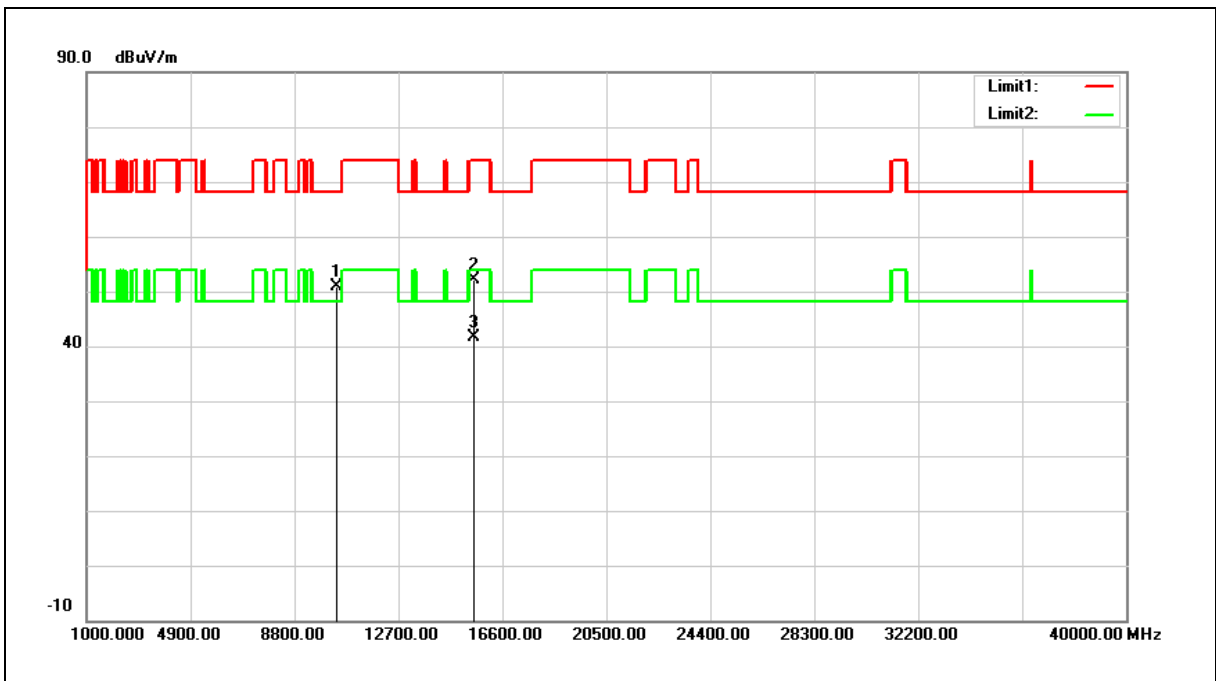

No.	Frequency (MHz)	Reading (dBuV)	Correct Factor (dB/m)	Result (dBuV/m)	Limit (dBuV/m)	Margin (dB)	Remark
1	10360.000	33.48	17.29	50.77	68.20	-17.43	peak
2	15540.000	31.32	20.75	52.07	74.00	-21.93	peak
3	15540.000	20.81	20.75	41.56	54.00	-12.44	AVG

Note:1.Result (dBuV/m) = Correct Factor (dB/m) + Reading(dBuV).

2.Correction factor (dB/m) = Antenna Factor (dB/m) + Cable loss (dB) – Pre-Amplifier gain (dB).

3.When the peak results are less than average limit, so not need to evaluate the average.



Standard:	FCC Part 15.407	Test Distance:	3m
Test item:	Harmonic		
Frequency:	5200MHz		
Mode:	Mode 6		
Ant.Polar.:	Horizontal		

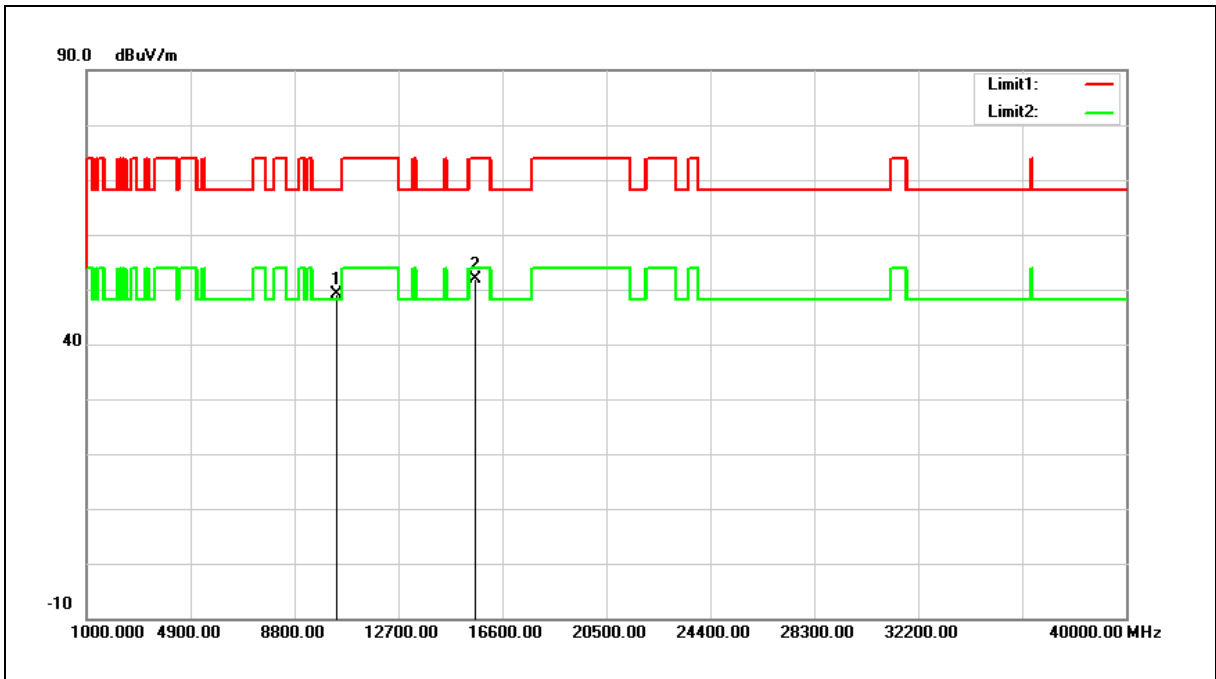

No.	Frequency (MHz)	Reading (dBuV)	Correct Factor (dB/m)	Result (dBuV/m)	Limit (dBuV/m)	Margin (dB)	Remark
1	10400.000	31.67	17.40	49.07	68.20	-19.13	peak
2	15600.000	31.28	20.60	51.88	74.00	-22.12	peak

Note:1.Result (dBuV/m) = Correct Factor (dB/m) + Reading(dBuV).

2.Correction factor (dB/m) = Antenna Factor (dB/m) + Cable loss (dB) – Pre-Amplifier gain (dB).

3.When the peak results are less than average limit, so not need to evaluate the average.



Standard:	FCC Part 15.407	Test Distance:	3m
Test item:	Harmonic		
Frequency:	5200MHz		
Mode:	Mode 6		
Ant.Polar.:	Vertical		

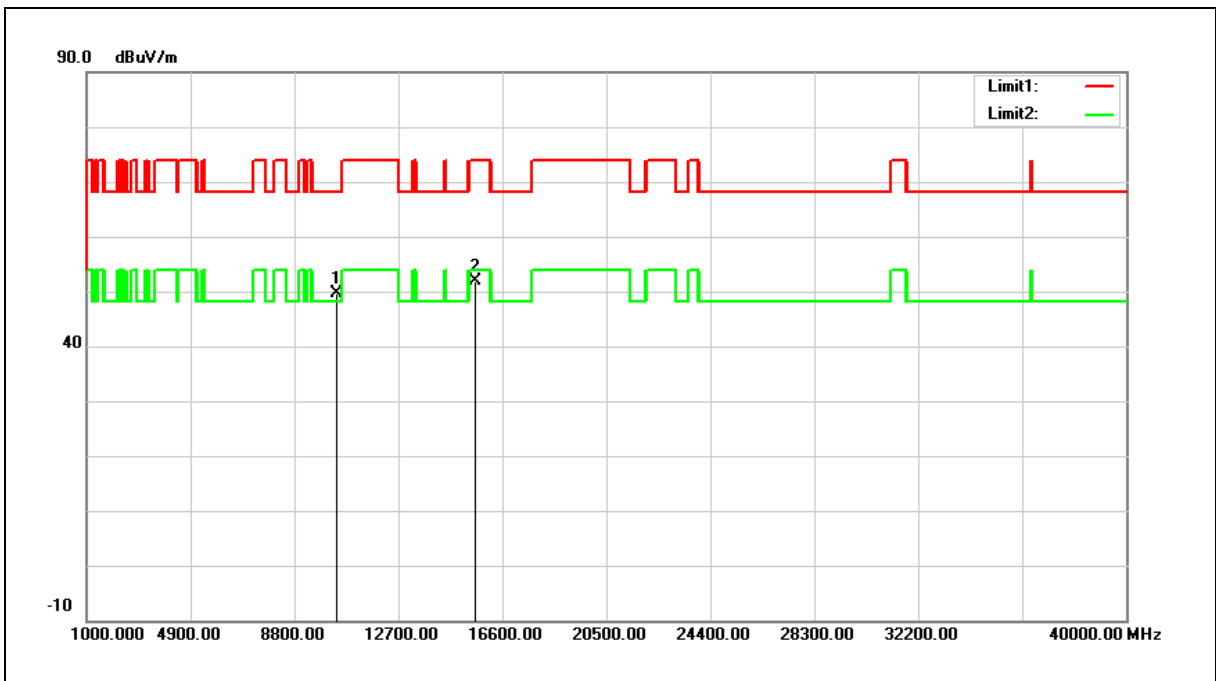

No.	Frequency (MHz)	Reading (dBuV)	Correct Factor (dB/m)	Result (dBuV/m)	Limit (dBuV/m)	Margin (dB)	Remark
1	10400.000	32.26	17.40	49.66	68.20	-18.54	peak
2	15600.000	31.37	20.60	51.97	74.00	-22.03	peak

Note:1.Result (dBuV/m) = Correct Factor (dB/m) + Reading(dBuV).

2.Correction factor (dB/m) = Antenna Factor (dB/m) + Cable loss (dB) – Pre-Amplifier gain (dB).

3.When the peak results are less than average limit, so not need to evaluate the average.



Standard:	FCC Part 15.407	Test Distance:	3m
Test item:	Harmonic		
Frequency:	5240MHz		
Mode:	Mode 6		
Ant.Polar.:	Horizontal		

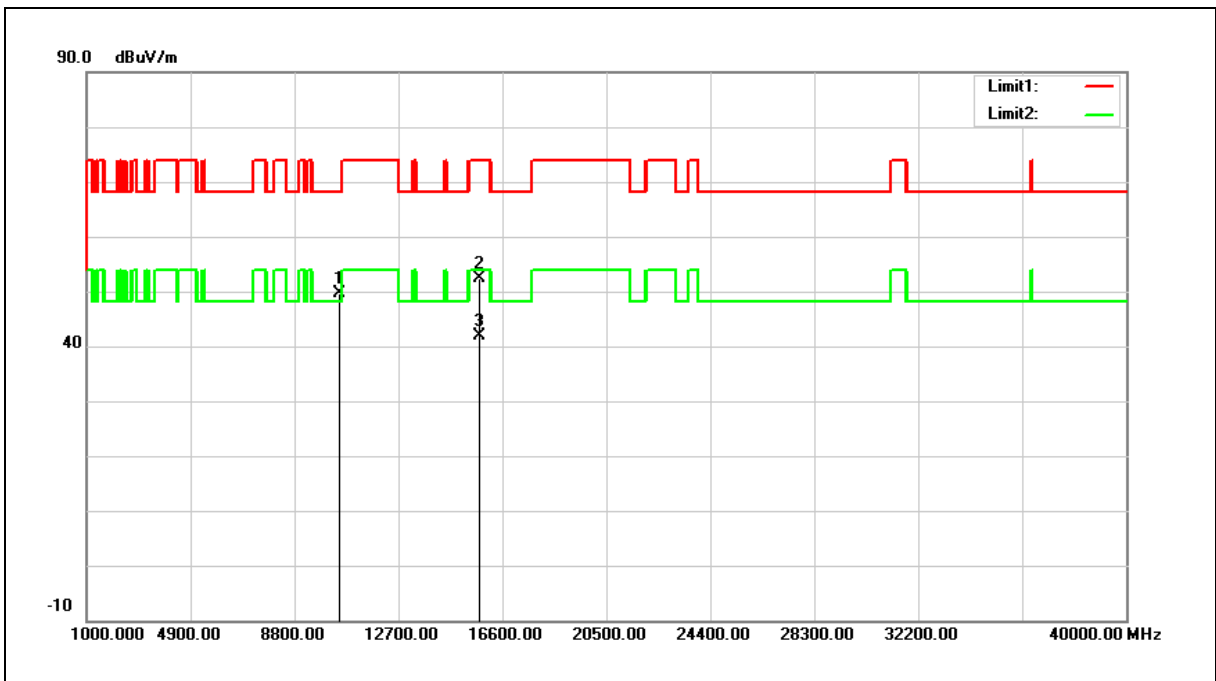

No.	Frequency (MHz)	Reading (dBuV)	Correct Factor (dB/m)	Result (dBuV/m)	Limit (dBuV/m)	Margin (dB)	Remark
1	10480.000	31.97	17.64	49.61	68.20	-18.59	peak
2	15720.000	31.99	20.30	52.29	74.00	-21.71	peak
3	15720.000	21.69	20.30	41.99	54.00	-12.01	AVG

Note:1.Result (dBuV/m) = Correct Factor (dB/m) + Reading(dBuV).

2.Correction factor (dB/m) = Antenna Factor (dB/m) + Cable loss (dB) – Pre-Amplifier gain (dB).

3.When the peak results are less than average limit, so not need to evaluate the average.



Standard:	FCC Part 15.407	Test Distance:	3m
Test item:	Harmonic		
Frequency:	5240MHz		
Mode:	Mode 6		
Ant.Polar.:	Vertical		

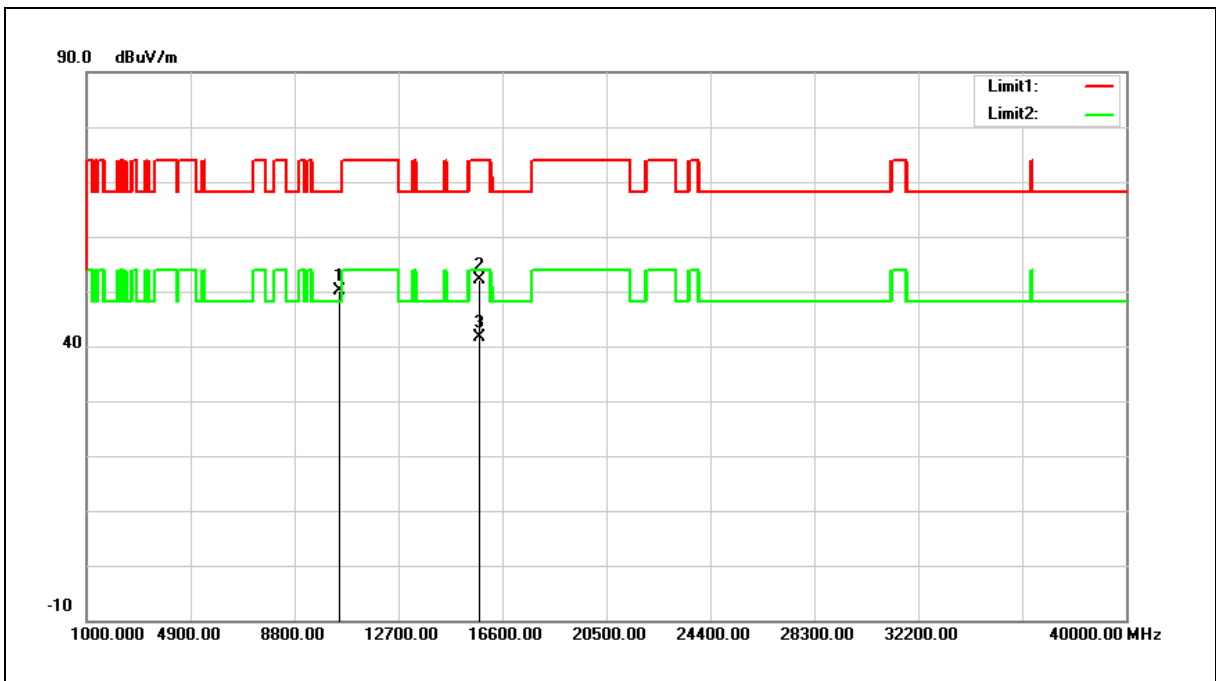

No.	Frequency (MHz)	Reading (dBuV)	Correct Factor (dB/m)	Result (dBuV/m)	Limit (dBuV/m)	Margin (dB)	Remark
1	10480.000	32.58	17.64	50.22	68.20	-17.98	peak
2	15720.000	31.91	20.30	52.21	74.00	-21.79	peak
3	15720.000	21.22	20.30	41.52	54.00	-12.48	AVG

Note:1.Result (dBuV/m) = Correct Factor (dB/m) + Reading(dBuV).

2.Correction factor (dB/m) = Antenna Factor (dB/m) + Cable loss (dB) – Pre-Amplifier gain (dB).

3.When the peak results are less than average limit, so not need to evaluate the average.



Standard:	FCC Part 15.407	Test Distance:	3m
Test item:	Harmonic		
Frequency:	5745MHz		
Mode:	Mode 6		
Ant.Polar.:	Horizontal		

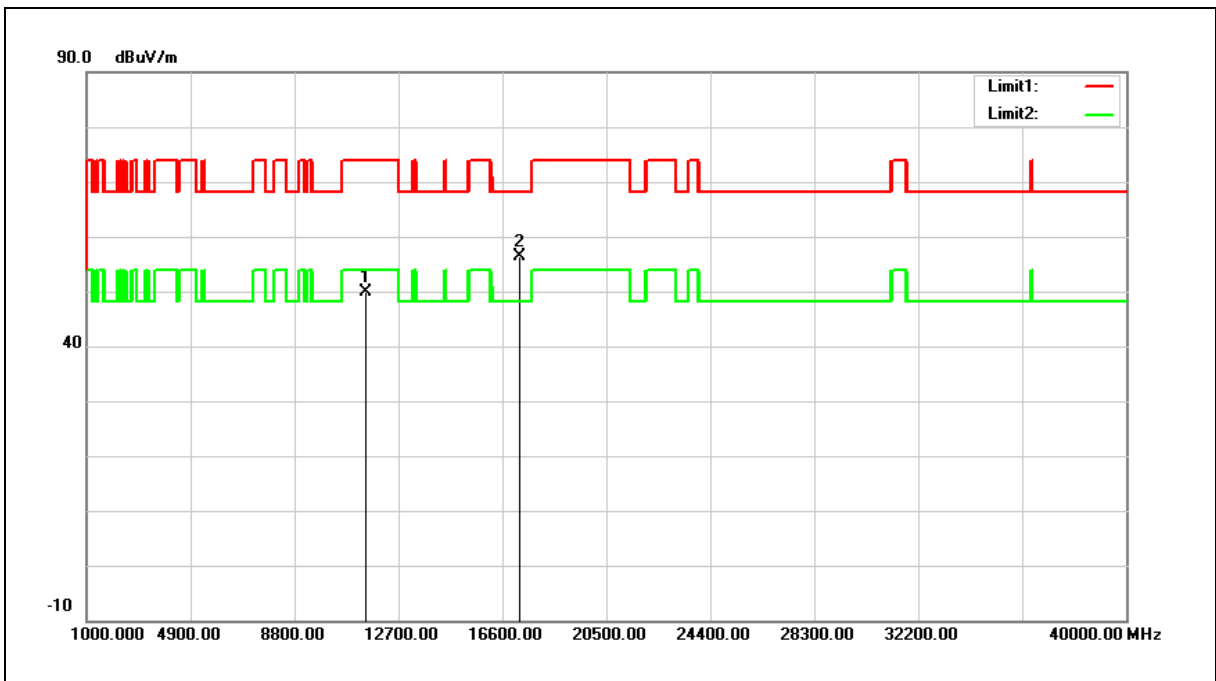

No.	Frequency (MHz)	Reading (dBuV)	Correct Factor (dB/m)	Result (dBuV/m)	Limit (dBuV/m)	Margin (dB)	Remark
1	11490.000	30.51	19.45	49.96	74.00	-24.04	peak
2	17235.000	31.34	25.01	56.35	68.20	-11.85	peak

Note:1.Result (dBuV/m) = Correct Factor (dB/m) + Reading(dBuV).

2.Correction factor (dB/m) = Antenna Factor (dB/m) + Cable loss (dB) – Pre-Amplifier gain (dB).

3.When the peak results are less than average limit, so not need to evaluate the average.



Standard:	FCC Part 15.407	Test Distance:	3m
Test item:	Harmonic		
Frequency:	5745MHz		
Mode:	Mode 6		
Ant.Polar.:	Vertical		

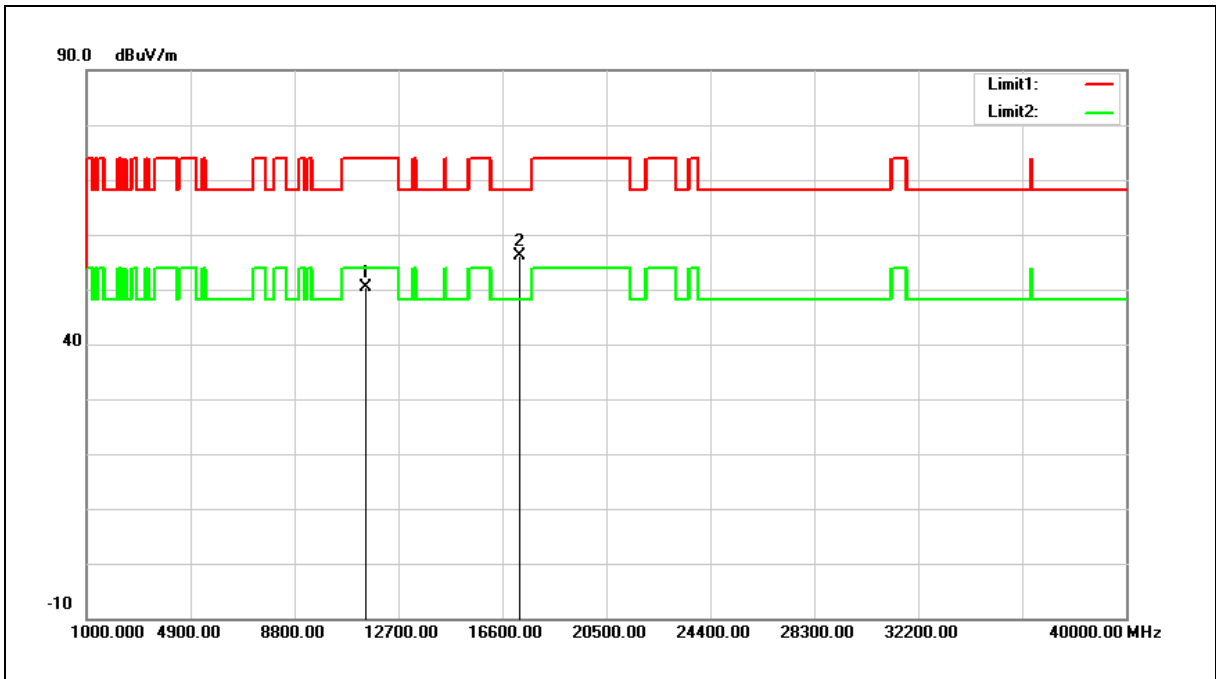

No.	Frequency (MHz)	Reading (dBuV)	Correct Factor (dB/m)	Result (dBuV/m)	Limit (dBuV/m)	Margin (dB)	Remark
1	11490.000	30.81	19.45	50.26	74.00	-23.74	peak
2	17235.000	31.08	25.01	56.09	68.20	-12.11	peak

- Note:1.Result (dBuV/m) = Correct Factor (dB/m) + Reading(dBuV).
 2.Correction factor (dB/m) = Antenna Factor (dB/m) + Cable loss (dB) – Pre-Amplifier gain (dB).
 3.When the peak results are less than average limit, so not need to evaluate the average.



Standard:	FCC Part 15.407	Test Distance:	3m
Test item:	Harmonic		
Frequency:	5785MHz		
Mode:	Mode 6		
Ant.Polar.:	Horizontal		

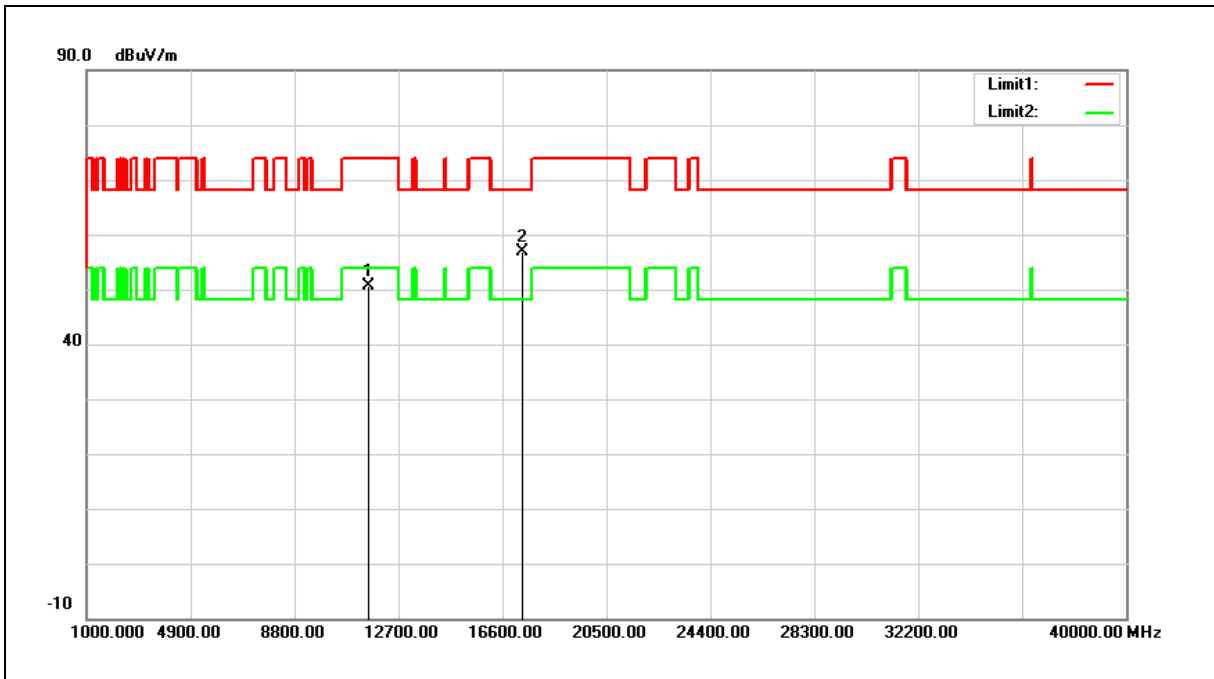

No.	Frequency (MHz)	Reading (dBuV)	Correct Factor (dB/m)	Result (dBuV/m)	Limit (dBuV/m)	Margin (dB)	Remark
1	11570.000	31.12	19.39	50.51	74.00	-23.49	peak
2	17355.000	31.54	25.34	56.88	68.20	-11.32	peak

Note:1.Result (dBuV/m) = Correct Factor (dB/m) + Reading(dBuV).

2.Correction factor (dB/m) = Antenna Factor (dB/m) + Cable loss (dB) – Pre-Amplifier gain (dB).

3.When the peak results are less than average limit, so not need to evaluate the average.



Standard:	FCC Part 15.407	Test Distance:	3m
Test item:	Harmonic		
Frequency:	5785MHz		
Mode:	Mode 6		
Ant.Polar.:	Vertical		

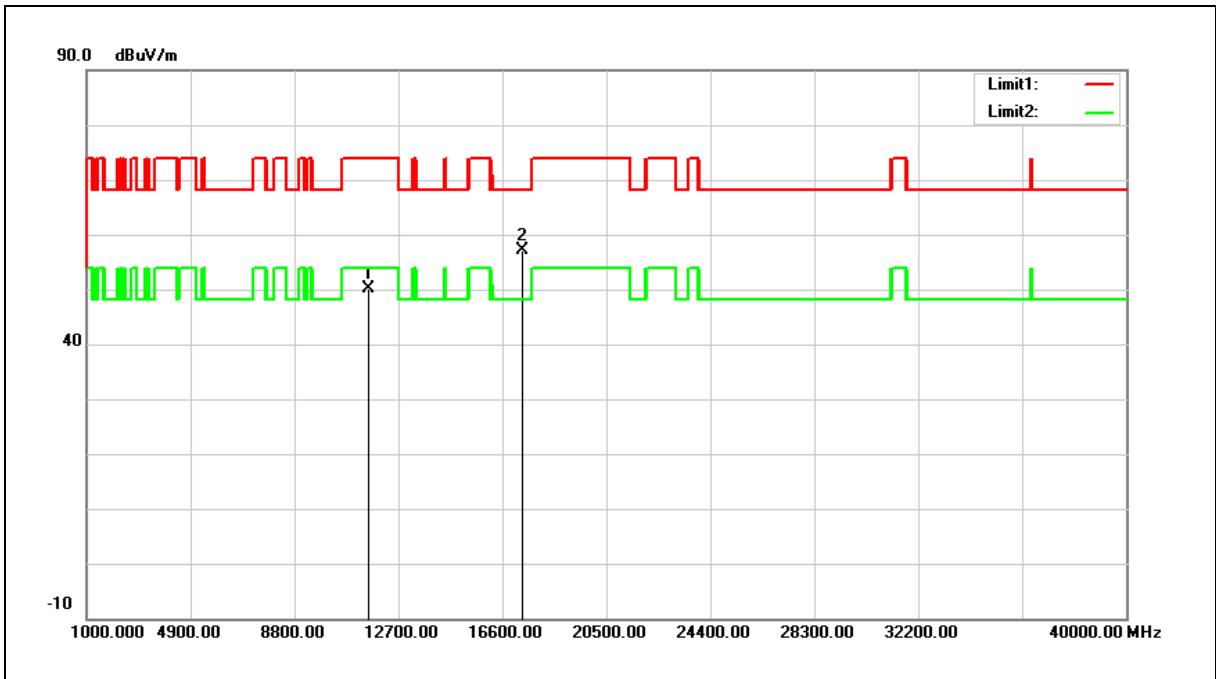

No.	Frequency (MHz)	Reading (dBuV)	Correct Factor (dB/m)	Result (dBuV/m)	Limit (dBuV/m)	Margin (dB)	Remark
1	11570.000	30.66	19.39	50.05	74.00	-23.95	peak
2	17355.000	31.76	25.34	57.10	68.20	-11.10	peak

Note:1.Result (dBuV/m) = Correct Factor (dB/m) + Reading(dBuV).

2.Correction factor (dB/m) = Antenna Factor (dB/m) + Cable loss (dB) – Pre-Amplifier gain (dB).

3.When the peak results are less than average limit, so not need to evaluate the average.



Standard:	FCC Part 15.407	Test Distance:	3m
Test item:	Harmonic		
Frequency:	5825MHz		
Mode:	Mode 6		
Ant.Polar.:	Horizontal		

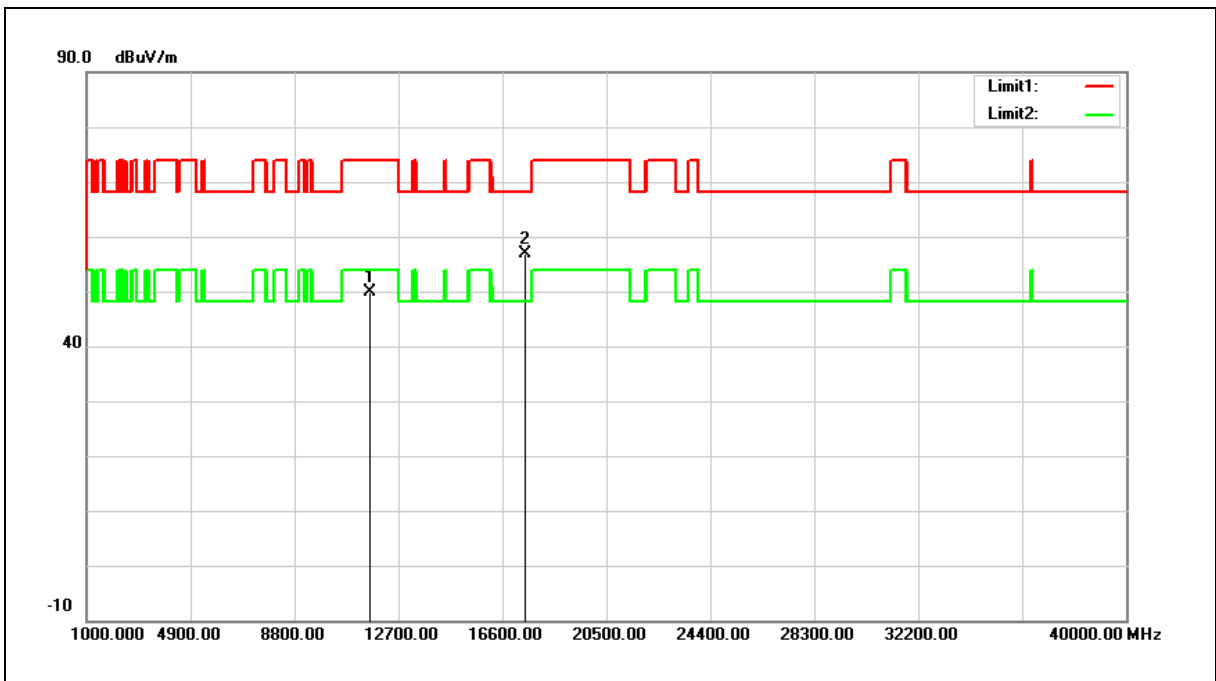

No.	Frequency (MHz)	Reading (dBuV)	Correct Factor (dB/m)	Result (dBuV/m)	Limit (dBuV/m)	Margin (dB)	Remark
1	11650.000	30.45	19.32	49.77	74.00	-24.23	peak
2	17475.000	31.31	25.65	56.96	68.20	-11.24	peak

Note:1.Result (dBuV/m) = Correct Factor (dB/m) + Reading(dBuV).

2.Correction factor (dB/m) = Antenna Factor (dB/m) + Cable loss (dB) – Pre-Amplifier gain (dB).

3.When the peak results are less than average limit, so not need to evaluate the average.



Standard:	FCC Part 15.407	Test Distance:	3m
Test item:	Harmonic		
Frequency:	5825MHz		
Mode:	Mode 6		
Ant.Polar.:	Vertical		

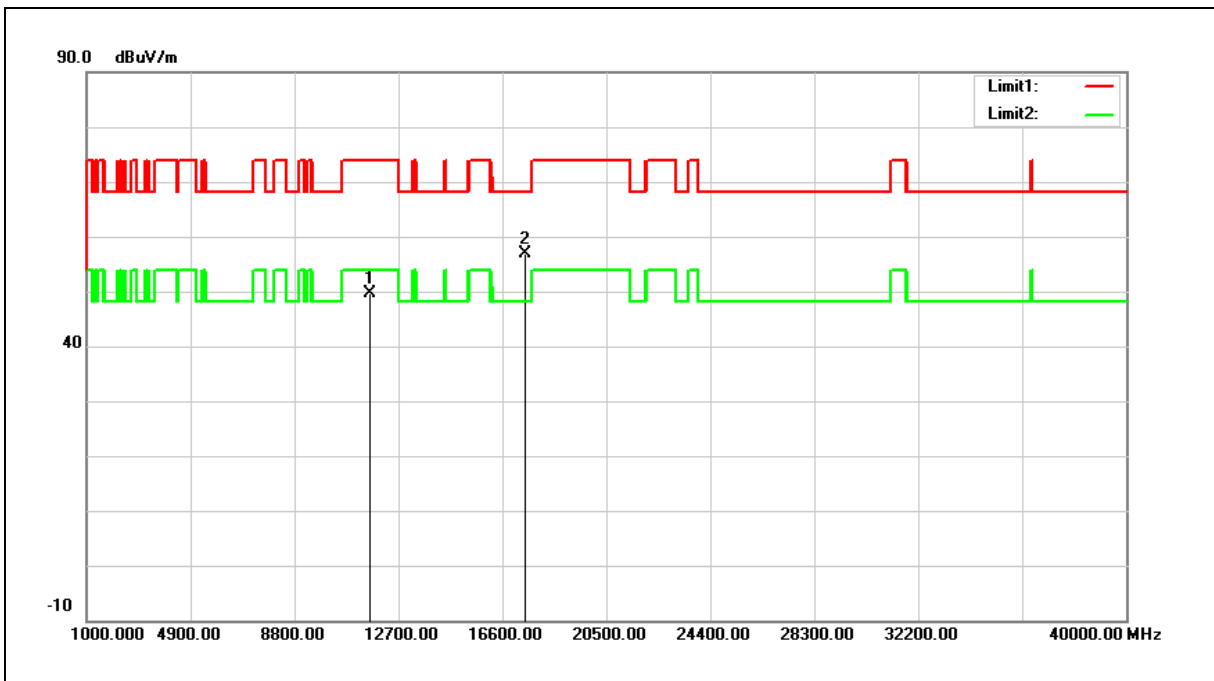

No.	Frequency (MHz)	Reading (dBuV)	Correct Factor (dB/m)	Result (dBuV/m)	Limit (dBuV/m)	Margin (dB)	Remark
1	11650.000	30.27	19.32	49.59	74.00	-24.41	peak
2	17475.000	31.19	25.65	56.84	68.20	-11.36	peak

Note:1.Result (dBuV/m) = Correct Factor (dB/m) + Reading(dBuV).

2.Correction factor (dB/m) = Antenna Factor (dB/m) + Cable loss (dB) – Pre-Amplifier gain (dB).

3.When the peak results are less than average limit, so not need to evaluate the average.



Standard:	FCC Part 15.407	Test Distance:	3m
Test item:	Harmonic		
Frequency:	5190MHz		
Mode:	Mode 7		
Ant.Polar.:	Horizontal		

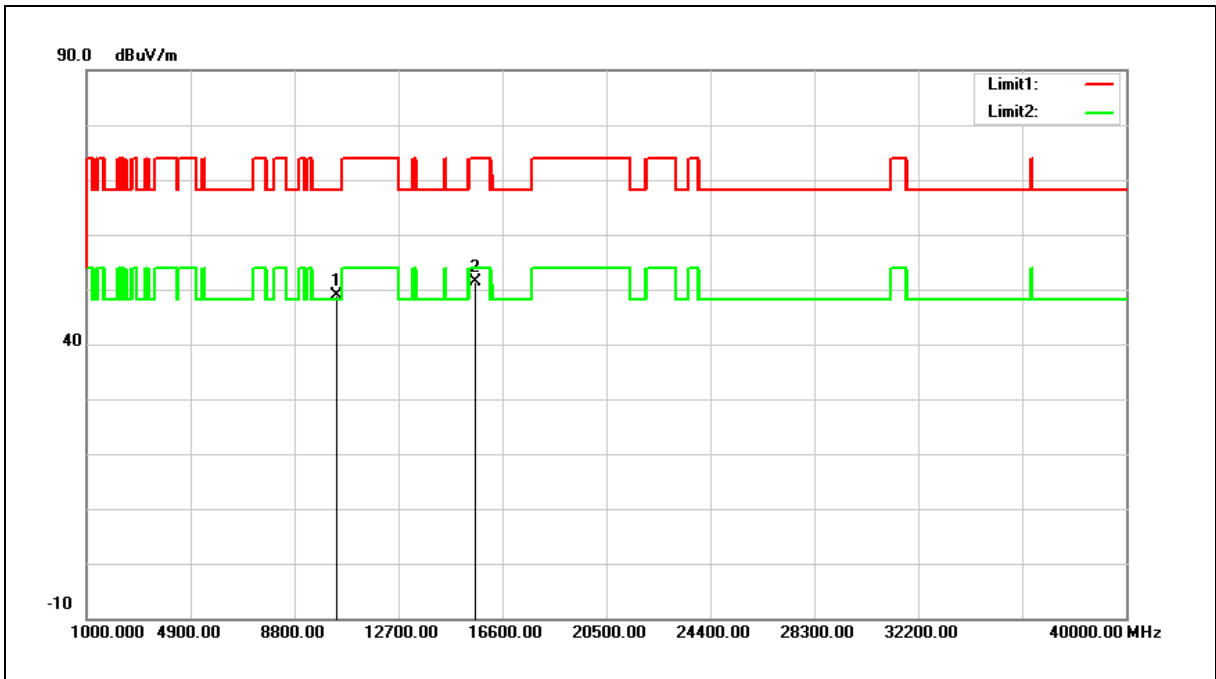

No.	Frequency (MHz)	Reading (dBuV)	Correct Factor (dB/m)	Result (dBuV/m)	Limit (dBuV/m)	Margin (dB)	Remark
1	10380.000	31.62	17.35	48.97	68.20	-19.23	peak
2	15570.000	30.78	20.68	51.46	74.00	-22.54	peak

Note:1.Result (dBuV/m) = Correct Factor (dB/m) + Reading(dBuV).

2.Correction factor (dB/m) = Antenna Factor (dB/m) + Cable loss (dB) – Pre-Amplifier gain (dB).

3.When the peak results are less than average limit, so not need to evaluate the average.



Standard:	FCC Part 15.407	Test Distance:	3m
Test item:	Harmonic		
Frequency:	5190MHz		
Mode:	Mode 7		
Ant.Polar.:	Vertical		

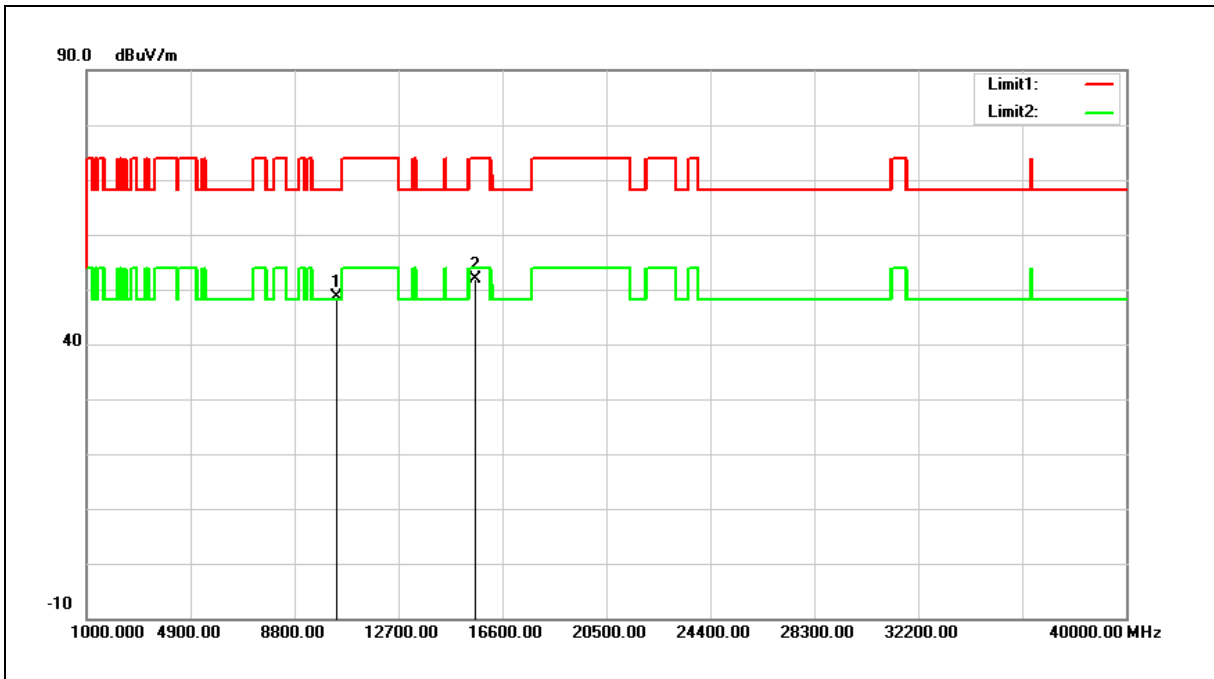

No.	Frequency (MHz)	Reading (dBuV)	Correct Factor (dB/m)	Result (dBuV/m)	Limit (dBuV/m)	Margin (dB)	Remark
1	10380.000	31.25	17.35	48.60	68.20	-19.60	peak
2	15570.000	31.21	20.68	51.89	74.00	-22.11	peak

Note:1.Result (dBuV/m) = Correct Factor (dB/m) + Reading(dBuV).

2.Correction factor (dB/m) = Antenna Factor (dB/m) + Cable loss (dB) – Pre-Amplifier gain (dB).

3.When the peak results are less than average limit, so not need to evaluate the average.



Standard:	FCC Part 15.407	Test Distance:	3m
Test item:	Harmonic		
Frequency:	5230MHz		
Mode:	Mode 7		
Ant.Polar.:	Horizontal		

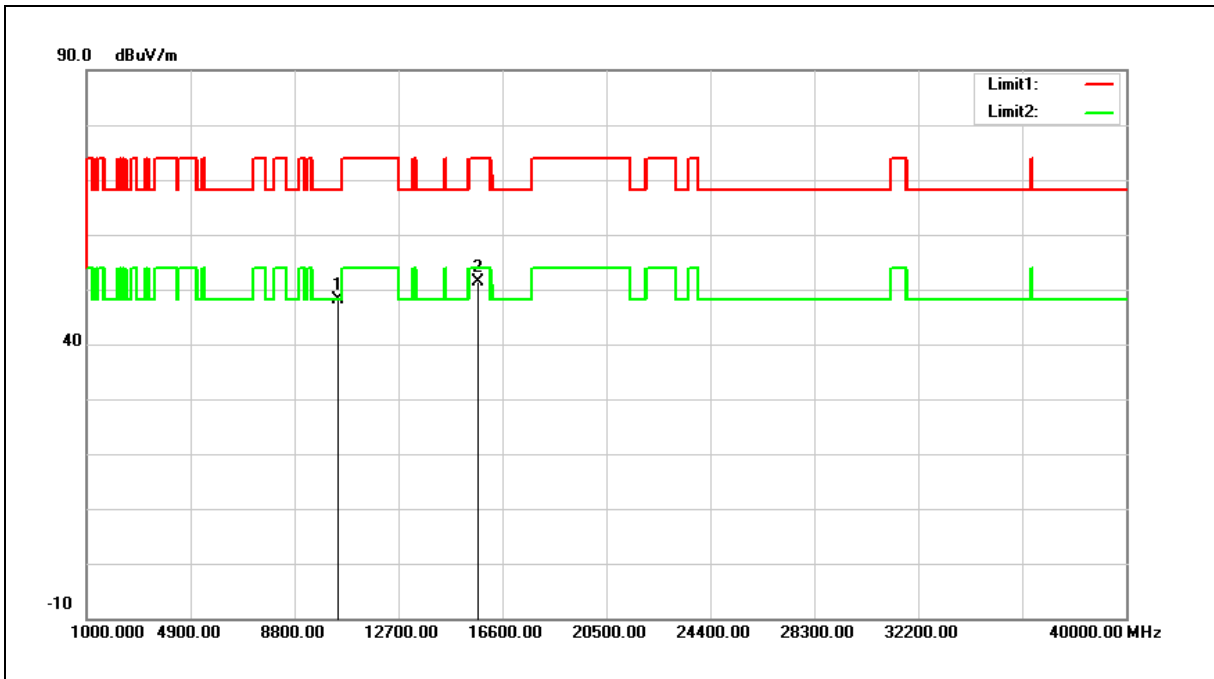

No.	Frequency (MHz)	Reading (dBuV)	Correct Factor (dB/m)	Result (dBuV/m)	Limit (dBuV/m)	Margin (dB)	Remark
1	10460.000	30.47	17.59	48.06	68.20	-20.14	peak
2	15690.000	30.99	20.37	51.36	74.00	-22.64	peak

Note:1.Result (dBuV/m) = Correct Factor (dB/m) + Reading(dBuV).

2.Correction factor (dB/m) = Antenna Factor (dB/m) + Cable loss (dB) – Pre-Amplifier gain (dB).

3.When the peak results are less than average limit, so not need to evaluate the average.



Standard:	FCC Part 15.407	Test Distance:	3m
Test item:	Harmonic		
Frequency:	5230MHz		
Mode:	Mode 7		
Ant.Polar.:	Vertical		

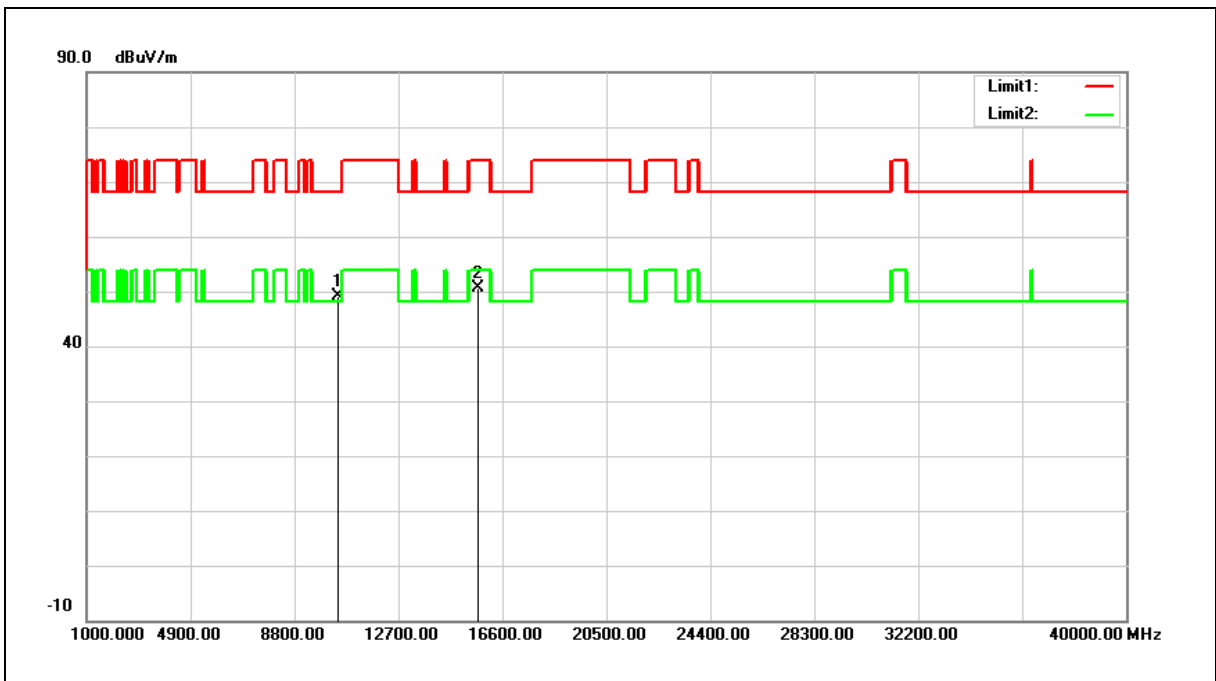

No.	Frequency (MHz)	Reading (dBuV)	Correct Factor (dB/m)	Result (dBuV/m)	Limit (dBuV/m)	Margin (dB)	Remark
1	10460.000	31.51	17.59	49.10	68.20	-19.10	peak
2	15690.000	30.32	20.37	50.69	74.00	-23.31	peak

Note:1.Result (dBuV/m) = Correct Factor (dB/m) + Reading(dBuV).

2.Correction factor (dB/m) = Antenna Factor (dB/m) + Cable loss (dB) – Pre-Amplifier gain (dB).

3.When the peak results are less than average limit, so not need to evaluate the average.



Standard:	FCC Part 15.407	Test Distance:	3m
Test item:	Harmonic		
Frequency:	5755MHz		
Mode:	Mode 7		
Ant.Polar.:	Horizontal		

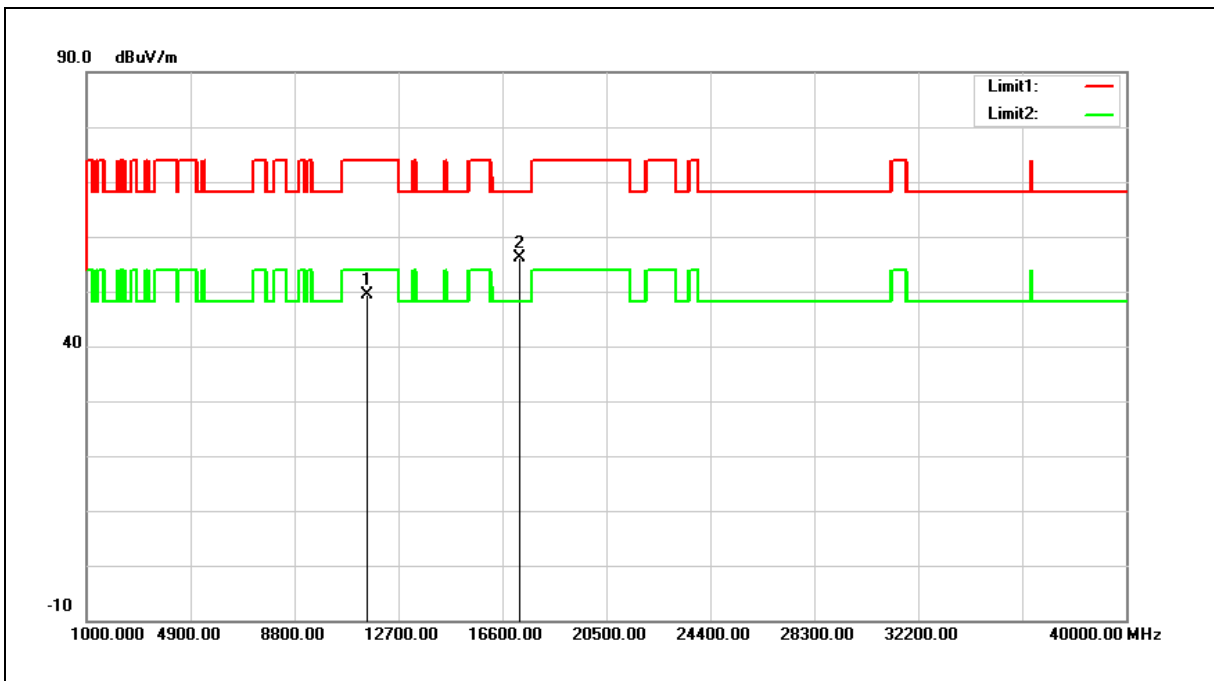

No.	Frequency (MHz)	Reading (dBuV)	Correct Factor (dB/m)	Result (dBuV/m)	Limit (dBuV/m)	Margin (dB)	Remark
1	11510.000	29.80	19.46	49.26	74.00	-24.74	peak
2	17265.000	30.95	25.09	56.04	68.20	-12.16	peak

Note:1.Result (dBuV/m) = Correct Factor (dB/m) + Reading(dBuV).

2.Correction factor (dB/m) = Antenna Factor (dB/m) + Cable loss (dB) – Pre-Amplifier gain (dB).

3.When the peak results are less than average limit, so not need to evaluate the average.



Standard:	FCC Part 15.407	Test Distance:	3m
Test item:	Harmonic		
Frequency:	5755MHz		
Mode:	Mode 7		
Ant.Polar.:	Vertical		

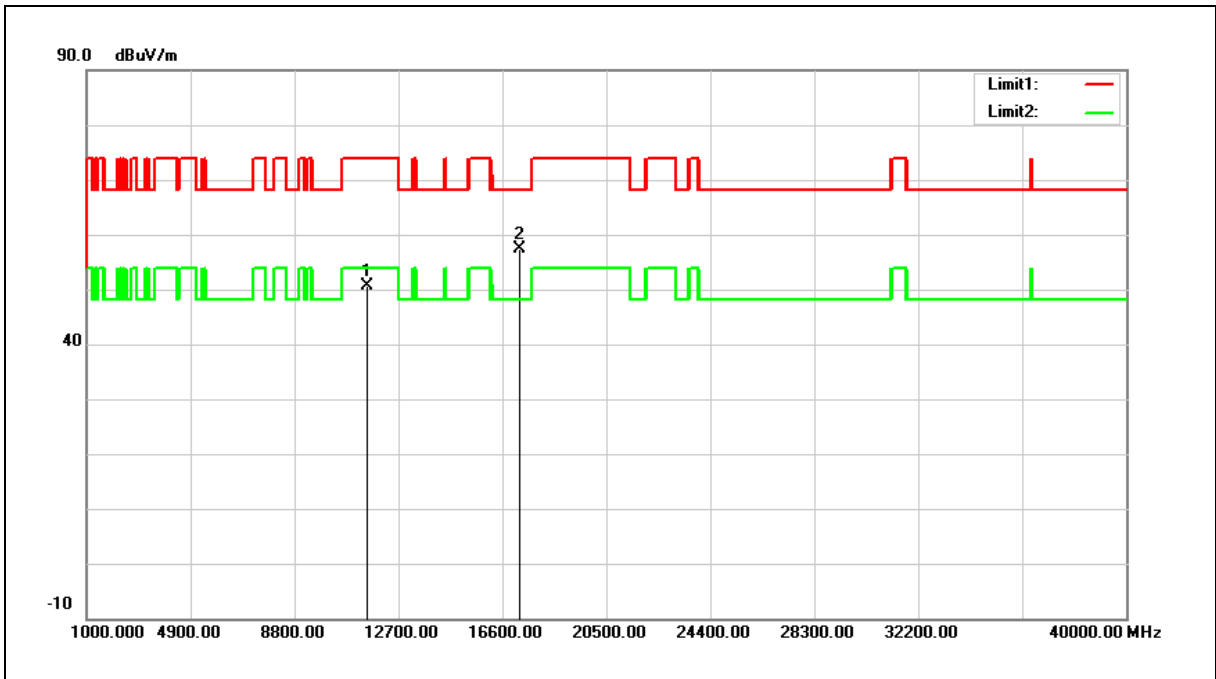

No.	Frequency (MHz)	Reading (dBuV)	Correct Factor (dB/m)	Result (dBuV/m)	Limit (dBuV/m)	Margin (dB)	Remark
1	11510.000	31.17	19.46	50.63	74.00	-23.37	peak
2	17265.000	32.31	25.09	57.40	68.20	-10.80	peak

Note:1.Result (dBuV/m) = Correct Factor (dB/m) + Reading(dBuV).

2.Correction factor (dB/m) = Antenna Factor (dB/m) + Cable loss (dB) – Pre-Amplifier gain (dB).

3.When the peak results are less than average limit, so not need to evaluate the average.



Standard:	FCC Part 15.407	Test Distance:	3m
Test item:	Harmonic		
Frequency:	5795MHz		
Mode:	Mode 7		
Ant.Polar.:	Horizontal		

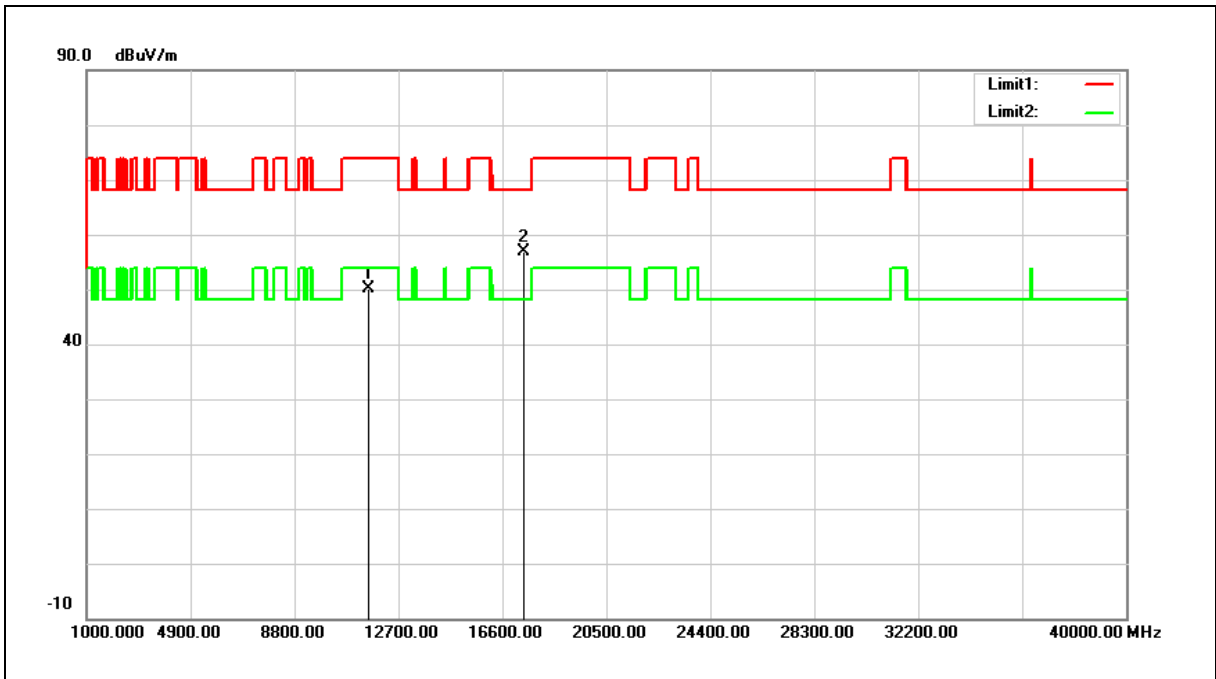

No.	Frequency (MHz)	Reading (dBuV)	Correct Factor (dB/m)	Result (dBuV/m)	Limit (dBuV/m)	Margin (dB)	Remark
1	11590.000	30.67	19.38	50.05	74.00	-23.95	peak
2	17385.000	31.51	25.41	56.92	68.20	-11.28	peak

Note:1.Result (dBuV/m) = Correct Factor (dB/m) + Reading(dBuV).

2.Correction factor (dB/m) = Antenna Factor (dB/m) + Cable loss (dB) – Pre-Amplifier gain (dB).

3.When the peak results are less than average limit, so not need to evaluate the average.



Standard:	FCC Part 15.407	Test Distance:	3m
Test item:	Harmonic		
Frequency:	5795MHz		
Mode:	Mode 7		
Ant.Polar.:	Vertical		

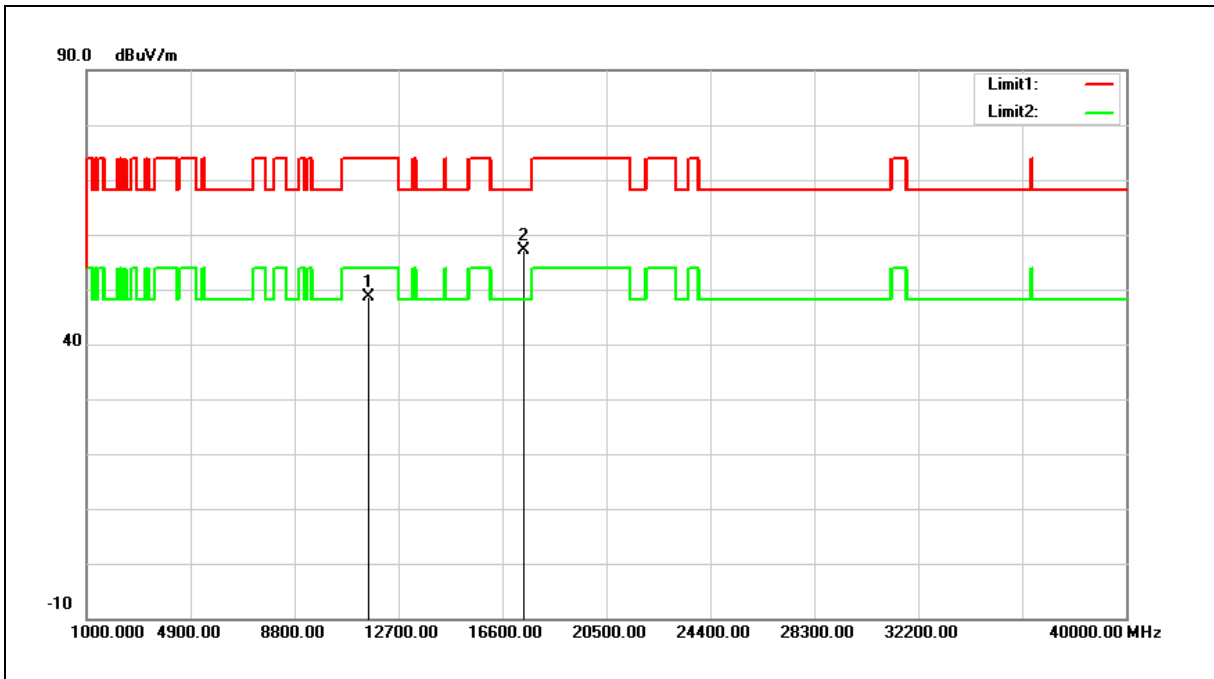

No.	Frequency (MHz)	Reading (dBuV)	Correct Factor (dB/m)	Result (dBuV/m)	Limit (dBuV/m)	Margin (dB)	Remark
1	11590.000	29.25	19.38	48.63	74.00	-25.37	peak
2	17385.000	31.61	25.41	57.02	68.20	-11.18	peak

Note:1.Result (dBuV/m) = Correct Factor (dB/m) + Reading(dBuV).

2.Correction factor (dB/m) = Antenna Factor (dB/m) + Cable loss (dB) – Pre-Amplifier gain (dB).

3.When the peak results are less than average limit, so not need to evaluate the average.



Standard:	FCC Part 15.407	Test Distance:	3m
Test item:	Harmonic		
Frequency:	5210MHz		
Mode:	Mode 8		
Ant.Polar.:	Horizontal		

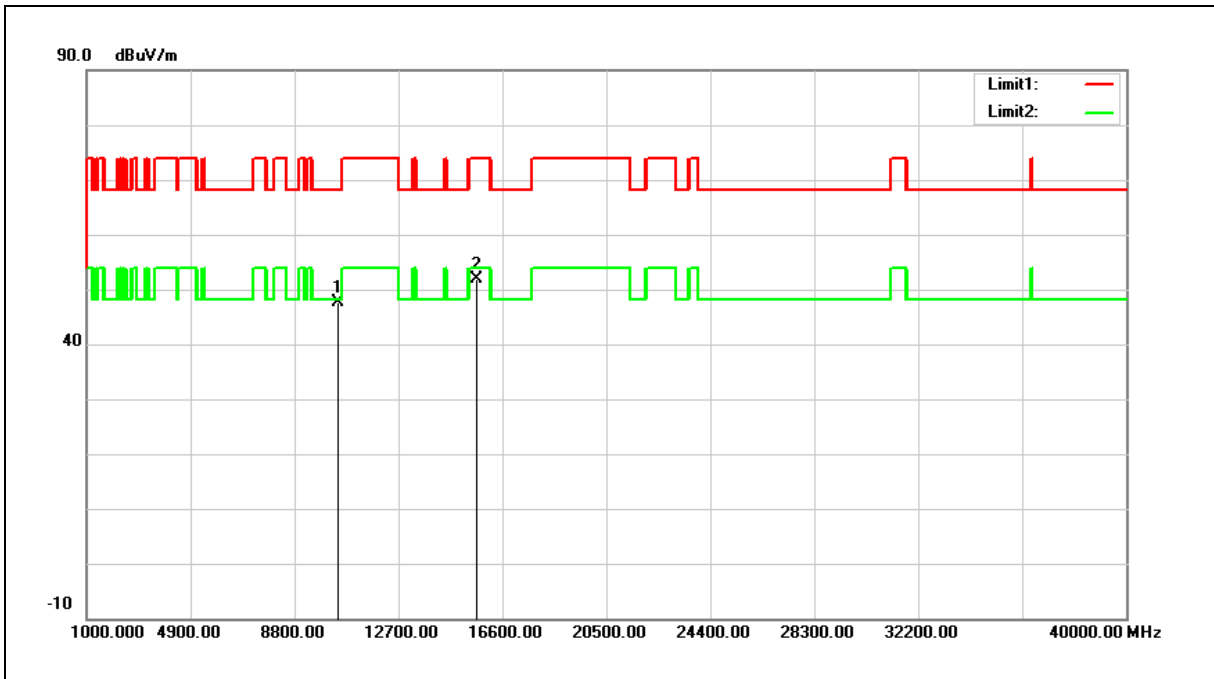

No.	Frequency (MHz)	Reading (dBuV)	Correct Factor (dB/m)	Result (dBuV/m)	Limit (dBuV/m)	Margin (dB)	Remark
1	10420.000	30.20	17.46	47.66	68.20	-20.54	peak
2	15630.000	31.44	20.53	51.97	74.00	-22.03	peak

Note:1.Result (dBuV/m) = Correct Factor (dB/m) + Reading(dBuV).

2.Correction factor (dB/m) = Antenna Factor (dB/m) + Cable loss (dB) – Pre-Amplifier gain (dB).

3.When the peak results are less than average limit, so not need to evaluate the average.



Standard:	FCC Part 15.407	Test Distance:	3m
Test item:	Harmonic		
Frequency:	5210MHz		
Mode:	Mode 8		
Ant.Polar.:	Vertical		

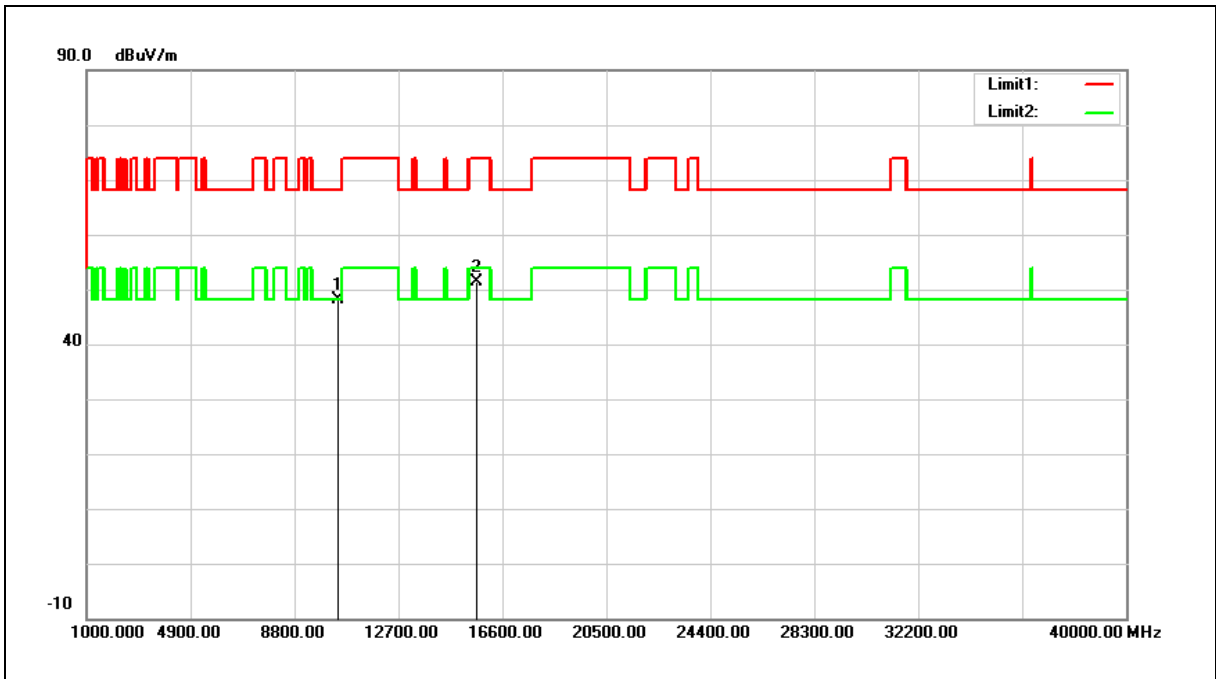

No.	Frequency (MHz)	Reading (dBuV)	Correct Factor (dB/m)	Result (dBuV/m)	Limit (dBuV/m)	Margin (dB)	Remark
1	10420.000	30.55	17.46	48.01	68.20	-20.19	peak
2	15630.000	30.82	20.53	51.35	74.00	-22.65	peak

Note:1.Result (dBuV/m) = Correct Factor (dB/m) + Reading(dBuV).

2.Correction factor (dB/m) = Antenna Factor (dB/m) + Cable loss (dB) – Pre-Amplifier gain (dB).

3.When the peak results are less than average limit, so not need to evaluate the average.



Standard:	FCC Part 15.407	Test Distance:	3m
Test item:	Harmonic		
Frequency:	5775MHz		
Mode:	Mode 8		
Ant.Polar.:	Horizontal		

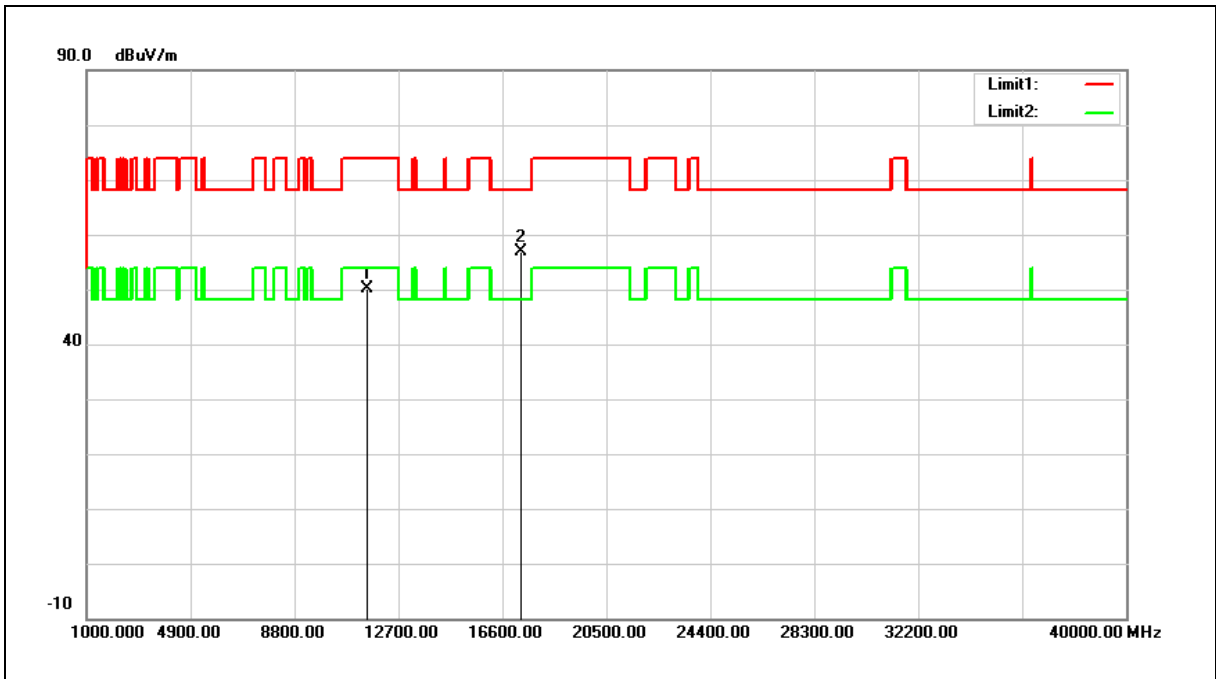

No.	Frequency (MHz)	Reading (dBuV)	Correct Factor (dB/m)	Result (dBuV/m)	Limit (dBuV/m)	Margin (dB)	Remark
1	11550.000	30.74	19.42	50.16	74.00	-23.84	peak
2	17325.000	31.54	25.25	56.79	68.20	-11.41	peak

Note:1.Result (dBuV/m) = Correct Factor (dB/m) + Reading(dBuV).

2.Correction factor (dB/m) = Antenna Factor (dB/m) + Cable loss (dB) – Pre-Amplifier gain (dB).

3.When the peak results are less than average limit, so not need to evaluate the average.



Standard:	FCC Part 15.407	Test Distance:	3m
Test item:	Harmonic		
Frequency:	5775MHz		
Mode:	Mode 8		
Ant.Polar.:	Vertical		

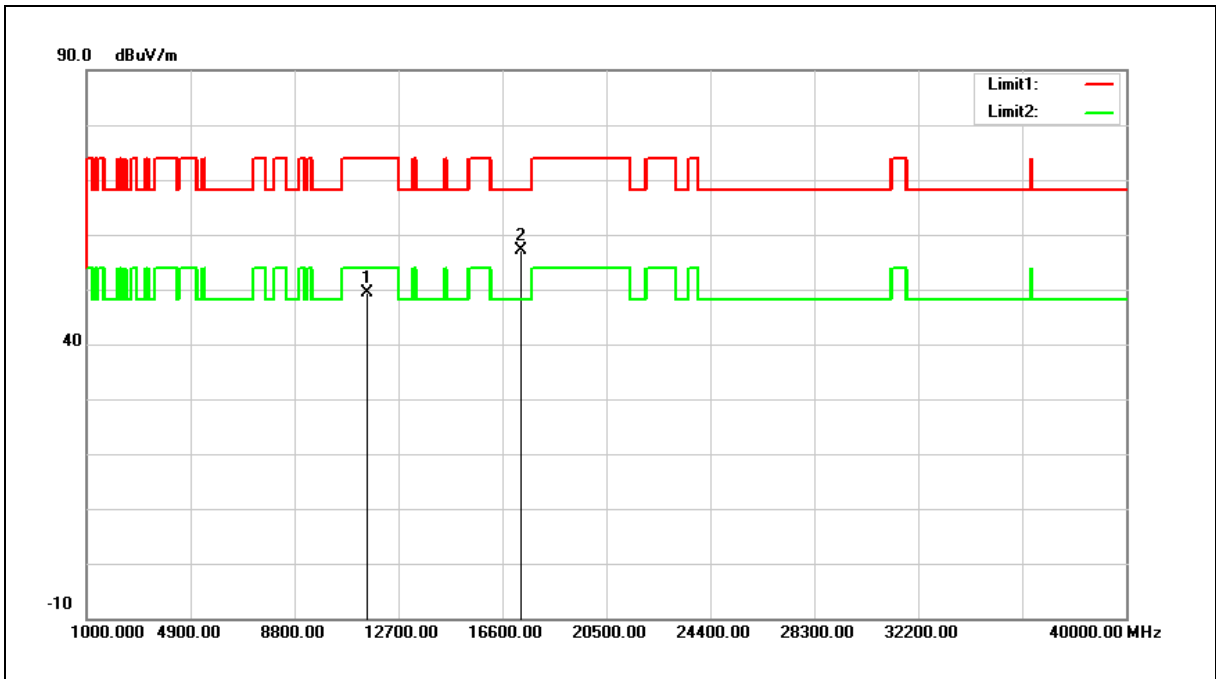

No.	Frequency (MHz)	Reading (dBuV)	Correct Factor (dB/m)	Result (dBuV/m)	Limit (dBuV/m)	Margin (dB)	Remark
1	11550.000	29.89	19.42	49.31	74.00	-24.69	peak
2	17325.000	31.86	25.25	57.11	68.20	-11.09	peak

Note:1.Result (dBuV/m) = Correct Factor (dB/m) + Reading(dBuV).

2.Correction factor (dB/m) = Antenna Factor (dB/m) + Cable loss (dB) – Pre-Amplifier gain (dB).

3.When the peak results are less than average limit, so not need to evaluate the average.

Standard:	FCC Part 15.407	Test Distance:	3 m
Test item:	Harmonic		
Mode:	Simultaneous Transmitting (WLAN 5 GHz+ WLAN 2.4 GHz)		
Ant.Polar.:	Horizontal		

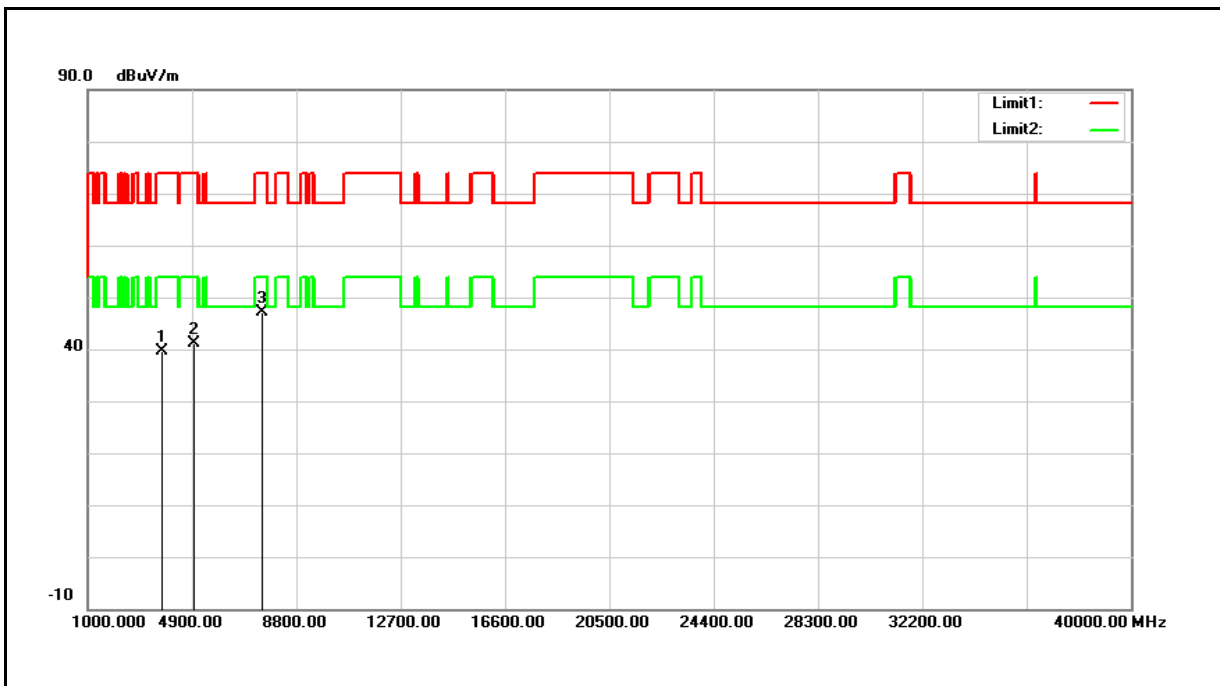

No.	Frequency (MHz)	Reading (dBuV)	Correct Factor (dB/m)	Result (dBuV/m)	Limit (dBuV/m)	Margin (dB)	Remark
1	3737.000	36.67	3.08	39.75	74.00	-34.25	peak
2	4961.000	34.67	6.38	41.05	74.00	-32.95	peak
3	7477.000	33.90	13.30	47.20	74.00	-26.80	peak

Note:1.Result (dBuV/m) = Correct Factor (dB/m) + Reading(dBuV).

2.Correction factor (dB/m) = Antenna Factor (dB/m) + Cable loss (dB) – Pre-Amplifier gain (dB).

3.When the peak results are less than average limit, so not need to evaluate the average.



Standard:	FCC Part 15.407	Test Distance:	3 m
Test item:	Harmonic		
Mode:	Simultaneous Transmitting (WLAN 5 GHz+ WLAN 2.4 GHz)		
Ant.Polar.:	Vertical		

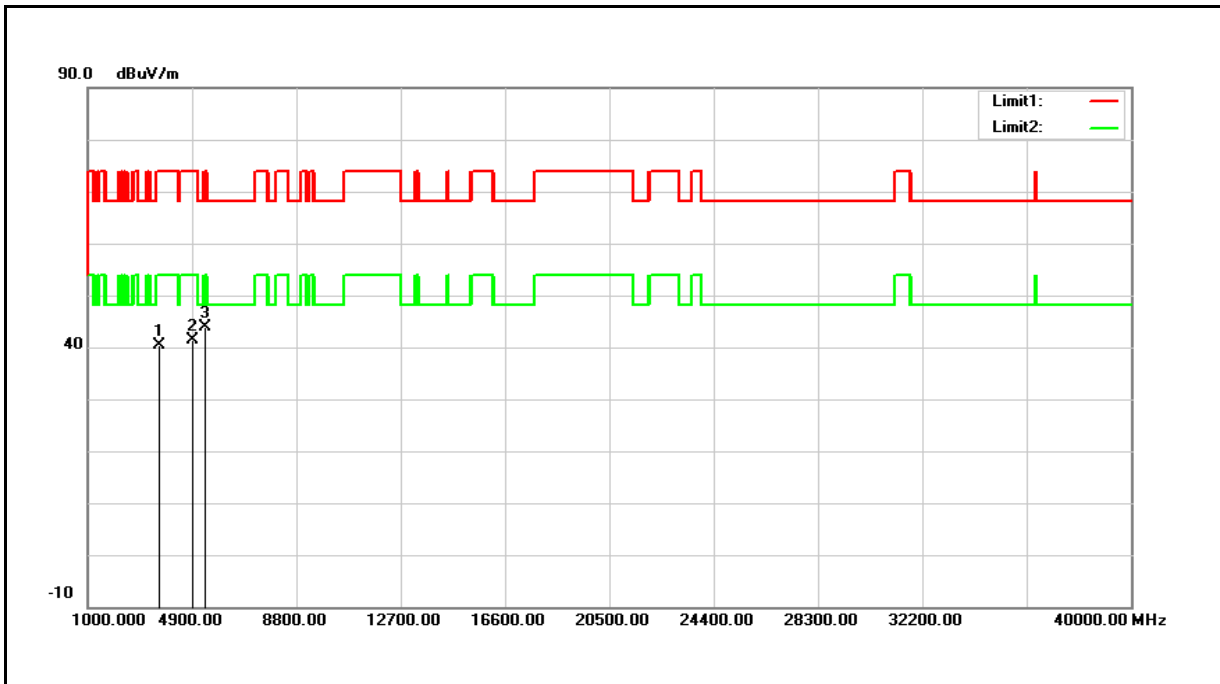

No.	Frequency (MHz)	Reading (dBuV)	Correct Factor (dB/m)	Result (dBuV/m)	Limit (dBuV/m)	Margin (dB)	Remark
1	3635.000	37.78	2.72	40.50	74.00	-33.50	peak
2	4893.000	35.28	6.18	41.46	74.00	-32.54	peak
3	5386.000	36.19	7.61	43.80	74.00	-30.20	peak

Note:1.Result (dBuV/m) = Correct Factor (dB/m) + Reading(dBuV).

2.Correction factor (dB/m) = Antenna Factor (dB/m) + Cable loss (dB) – Pre-Amplifier gain (dB).

3.When the peak results are less than average limit, so not need to evaluate the average.



Band Edge

Standard:	FCC Part 15.407	Test Distance:	3m
Test item:	Band edge		
Frequency:	5180MHz		
Mode:	Mode 3		
Ant.Polar.:	Horizontal		

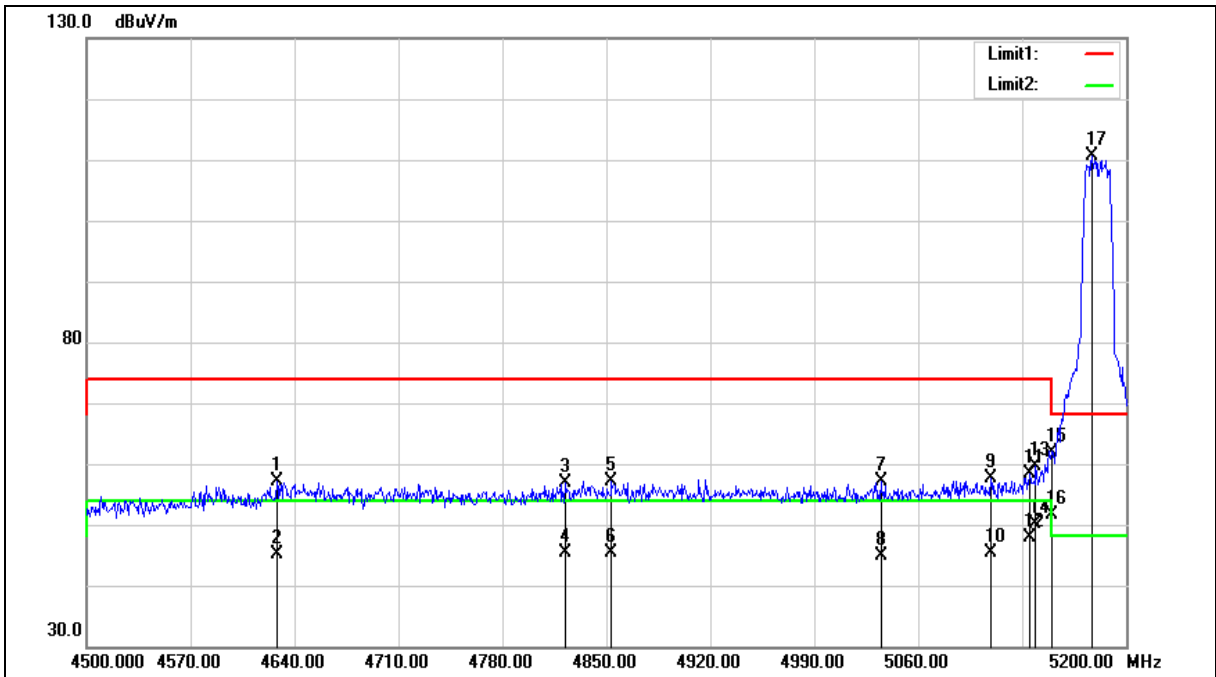



Standard:	FCC Part 15.407	Test Distance:	3m
Test item:	Band edge		
Frequency:	5180MHz		
Mode:	Mode 3		
Ant.Polar.:	Horizontal		

No.	Frequency (MHz)	Reading (dBuV)	Correct Factor (dB/m)	Result (dBuV/m)	Limit (dBuV/m)	Margin (dB)	Remark
1	4628.100	51.77	5.37	57.14	74.00	-16.86	peak
2	4628.100	39.82	5.37	45.19	54.00	-8.81	AVG
3	4822.700	50.83	5.97	56.80	74.00	-17.20	peak
4	4822.700	39.34	5.97	45.31	54.00	-8.69	AVG
5	4853.500	51.12	6.07	57.19	74.00	-16.81	peak
6	4853.500	39.35	6.07	45.42	54.00	-8.58	AVG
7	5034.800	50.52	6.60	57.12	74.00	-16.88	peak
8	5034.800	38.31	6.60	44.91	54.00	-9.09	AVG
9	5109.000	50.74	6.82	57.56	74.00	-16.44	peak
10	5109.000	38.57	6.82	45.39	54.00	-8.61	AVG
11	5134.900	51.56	6.89	58.45	74.00	-15.55	peak
12	5134.900	41.05	6.89	47.94	54.00	-6.06	AVG
13	5139.100	52.75	6.91	59.66	74.00	-14.34	peak
14	5139.100	43.30	6.91	50.21	54.00	-3.79	AVG
15	5150.000	54.93	6.94	61.87	74.00	-12.13	peak
16	5150.000	44.79	6.94	51.73	54.00	-2.27	AVG
17	5176.900	103.49	7.02	110.51	--	--	peak

Note:1.Result (dBuV/m) = Correct Factor (dB/m) + Reading(dBuV).

2.Correction factor (dB/m) = Antenna Factor (dB/m) + Cable loss (dB) – Pre-Amplifier gain (dB).

3.When the peak results are less than average limit, so not need to evaluate the average.



Standard:	FCC Part 15.407	Test Distance:	3m
Test item:	Band edge		
Frequency:	5180MHz		
Mode:	Mode 3		
Ant.Polar.:	Vertical		

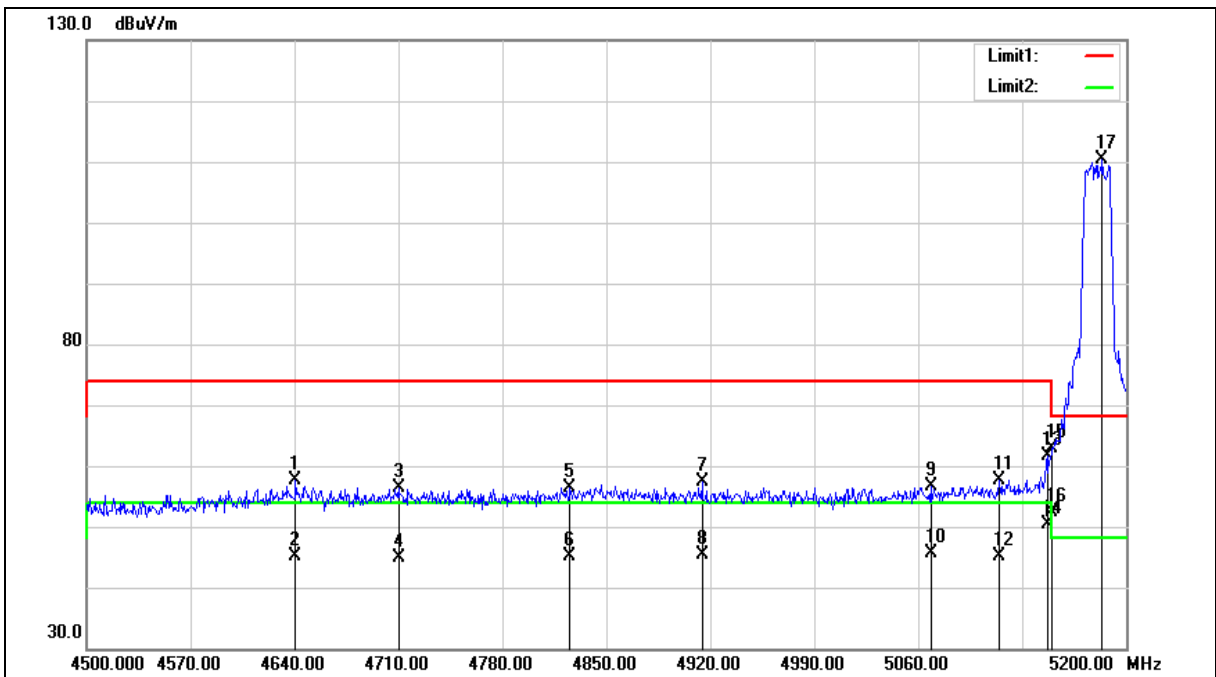



Standard:	FCC Part 15.407	Test Distance:	3m
Test item:	Band edge		
Frequency:	5180MHz		
Mode:	Mode 3		
Ant.Polar.:	Vertical		

No.	Frequency (MHz)	Reading (dBuV)	Correct Factor (dB/m)	Result (dBuV/m)	Limit (dBuV/m)	Margin (dB)	Remark
1	4640.700	52.29	5.41	57.70	74.00	-16.30	peak
2	4640.700	39.80	5.41	45.21	54.00	-8.79	AVG
3	4710.000	50.78	5.62	56.40	74.00	-17.60	peak
4	4710.000	39.30	5.62	44.92	54.00	-9.08	AVG
5	4825.500	50.44	5.98	56.42	74.00	-17.58	peak
6	4825.500	39.08	5.98	45.06	54.00	-8.94	AVG
7	4914.400	51.13	6.25	57.38	74.00	-16.62	peak
8	4914.400	39.14	6.25	45.39	54.00	-8.61	AVG
9	5068.400	50.03	6.70	56.73	74.00	-17.27	peak
10	5068.400	38.81	6.70	45.51	54.00	-8.49	AVG
11	5114.600	50.85	6.83	57.68	74.00	-16.32	peak
12	5114.600	38.41	6.83	45.24	54.00	-8.76	AVG
13	5146.800	54.78	6.93	61.71	74.00	-12.29	peak
14	5146.800	43.35	6.93	50.28	54.00	-3.72	AVG
15	5150.000	56.03	6.94	62.97	74.00	-11.03	peak
16	5150.000	45.39	6.94	52.33	54.00	-1.67	AVG
17	5183.900	103.25	7.03	110.28	--	--	peak

Note:1.Result (dBuV/m) = Correct Factor (dB/m) + Reading(dBuV).

2.Correction factor (dB/m) = Antenna Factor (dB/m) + Cable loss (dB) – Pre-Amplifier gain (dB).

3.When the peak results are less than average limit, so not need to evaluate the average.



Standard:	FCC Part 15.407	Test Distance:	3m
Test item:	Band edge		
Frequency:	5200MHz		
Mode:	Mode 3		
Ant.Polar.:	Horizontal		

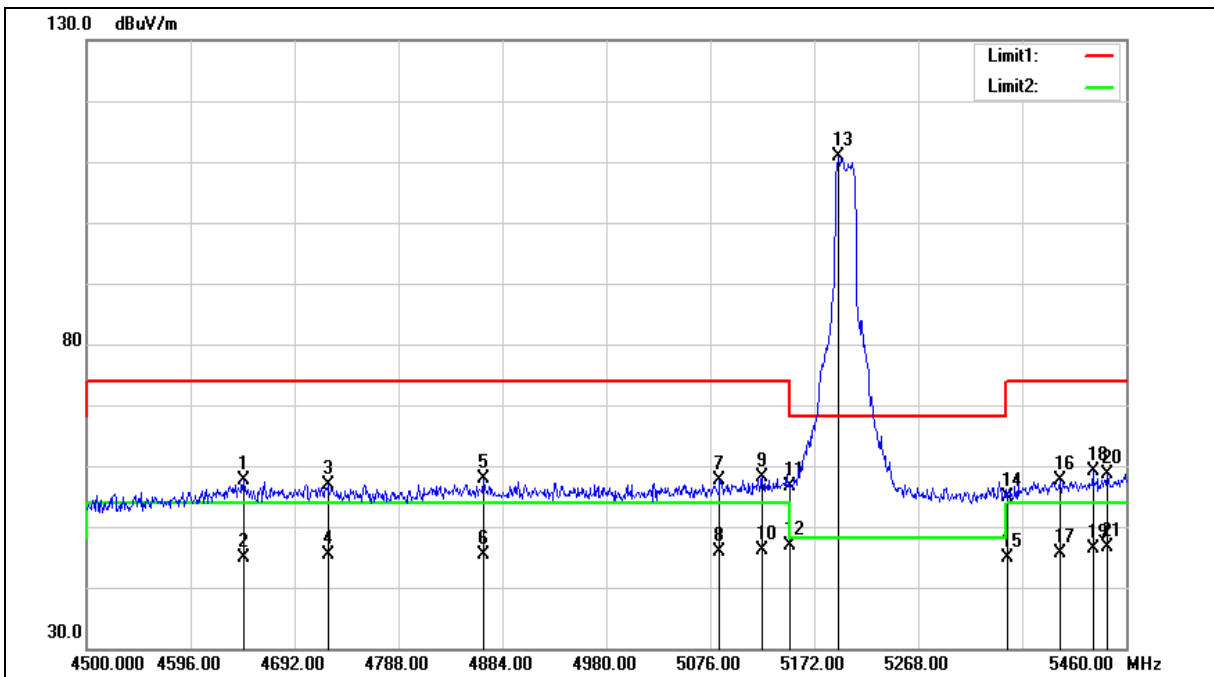



Standard:	FCC Part 15.407	Test Distance:	3m
Test item:	Band edge		
Frequency:	5200MHz		
Mode:	Mode 3		
Ant.Polar.:	Horizontal		

No.	Frequency (MHz)	Reading (dBuV)	Correct Factor (dB/m)	Result (dBuV/m)	Limit (dBuV/m)	Margin (dB)	Remark
1	4644.960	52.26	5.42	57.68	74.00	-16.32	peak
2	4644.960	39.53	5.42	44.95	54.00	-9.05	AVG
3	4722.720	51.10	5.67	56.77	74.00	-17.23	peak
4	4722.720	39.70	5.67	45.37	54.00	-8.63	AVG
5	4866.720	51.66	6.11	57.77	74.00	-16.23	peak
6	4866.720	39.38	6.11	45.49	54.00	-8.51	AVG
7	5084.640	50.77	6.74	57.51	74.00	-16.49	peak
8	5084.640	39.08	6.74	45.82	54.00	-8.18	AVG
9	5124.000	51.19	6.85	58.04	74.00	-15.96	peak
10	5124.000	39.16	6.85	46.01	54.00	-7.99	AVG
11	5150.000	49.66	6.94	56.60	74.00	-17.40	peak
12	5150.000	39.82	6.94	46.76	54.00	-7.24	AVG
13	5194.080	103.82	7.06	110.88	--	--	peak
14	5350.000	47.44	7.50	54.94	74.00	-19.06	peak
15	5350.000	37.35	7.50	44.85	54.00	-9.15	AVG
16	5399.520	50.06	7.65	57.71	74.00	-16.29	peak
17	5399.520	37.92	7.65	45.57	54.00	-8.43	AVG
18	5429.280	51.46	7.73	59.19	74.00	-14.81	peak
19	5429.280	38.63	7.73	46.36	54.00	-7.64	AVG
20	5442.720	50.91	7.77	58.68	74.00	-15.32	peak
21	5442.720	38.97	7.77	46.74	54.00	-7.26	AVG

Note:1.Result (dBuV/m) = Correct Factor (dB/m) + Reading(dBuV).

2.Correction factor (dB/m) = Antenna Factor (dB/m) + Cable loss (dB) – Pre-Amplifier gain (dB).

3.When the peak results are less than average limit, so not need to evaluate the average.



Standard:	FCC Part 15.407	Test Distance:	3m
Test item:	Band edge		
Frequency:	5200MHz		
Mode:	Mode 3		
Ant.Polar.:	Vertical		

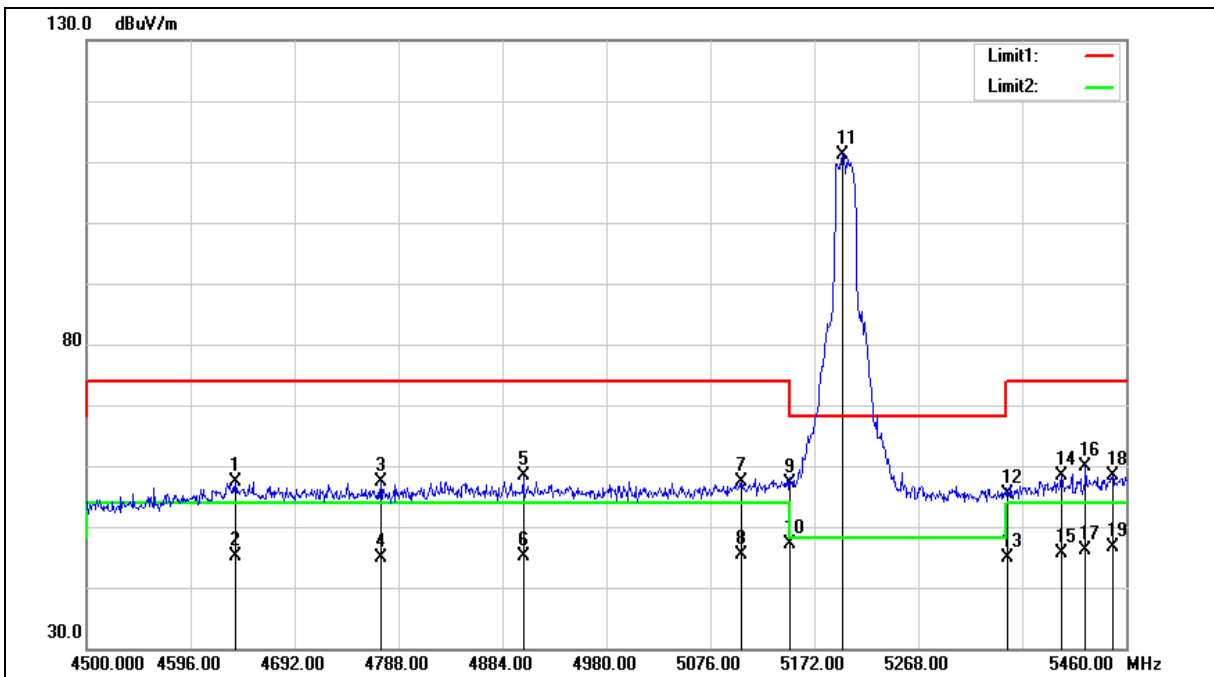



Standard:	FCC Part 15.407	Test Distance:	3m
Test item:	Band edge		
Frequency:	5200MHz		
Mode:	Mode 3		
Ant.Polar.:	Vertical		

No.	Frequency (MHz)	Reading (dBuV)	Correct Factor (dB/m)	Result (dBuV/m)	Limit (dBuV/m)	Margin (dB)	Remark
1	4637.280	52.04	5.40	57.44	74.00	-16.56	peak
2	4637.280	39.85	5.40	45.25	54.00	-8.75	AVG
3	4771.680	51.53	5.81	57.34	74.00	-16.66	peak
4	4771.680	39.08	5.81	44.89	54.00	-9.11	AVG
5	4903.200	52.05	6.21	58.26	74.00	-15.74	peak
6	4903.200	38.92	6.21	45.13	54.00	-8.87	AVG
7	5104.800	50.47	6.80	57.27	74.00	-16.73	peak
8	5104.800	38.58	6.80	45.38	54.00	-8.62	AVG
9	5150.000	50.17	6.94	57.11	74.00	-16.89	peak
10	5150.000	40.28	6.94	47.22	54.00	-6.78	AVG
11	5197.920	104.02	7.08	111.10	--	--	peak
12	5350.000	47.83	7.50	55.33	74.00	-18.67	peak
13	5350.000	37.45	7.50	44.95	54.00	-9.05	AVG
14	5400.480	50.81	7.65	58.46	74.00	-15.54	peak
15	5400.480	38.01	7.65	45.66	54.00	-8.34	AVG
16	5422.560	52.10	7.71	59.81	74.00	-14.19	peak
17	5422.560	38.47	7.71	46.18	54.00	-7.82	AVG
18	5447.520	50.49	7.79	58.28	74.00	-15.72	peak
19	5447.520	38.85	7.79	46.64	54.00	-7.36	AVG

Note:1.Result (dBuV/m) = Correct Factor (dB/m) + Reading(dBuV).

2.Correction factor (dB/m) = Antenna Factor (dB/m) + Cable loss (dB) – Pre-Amplifier gain (dB).

3.When the peak results are less than average limit, so not need to evaluate the average.



Standard:	FCC Part 15.407	Test Distance:	3m
Test item:	Band edge		
Frequency:	5240MHz		
Mode:	Mode 3		
Ant.Polar.:	Horizontal		

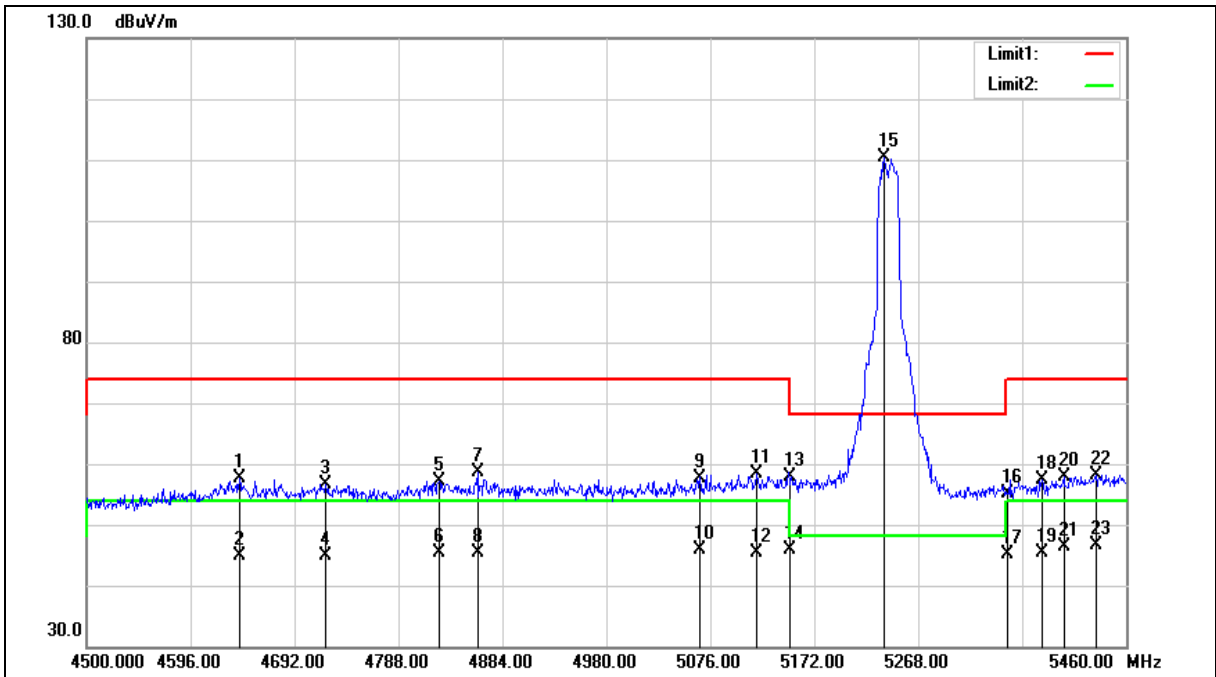



Standard:	FCC Part 15.407	Test Distance:	3m
Test item:	Band edge		
Frequency:	5240MHz		
Mode:	Mode 3		
Ant.Polar.:	Horizontal		

No.	Frequency (MHz)	Reading (dBuV)	Correct Factor (dB/m)	Result (dBuV/m)	Limit (dBuV/m)	Margin (dB)	Remark
1	4641.120	52.27	5.41	57.68	74.00	-16.32	peak
2	4641.120	39.36	5.41	44.77	54.00	-9.23	AVG
3	4720.800	51.03	5.66	56.69	74.00	-17.31	peak
4	4720.800	39.30	5.66	44.96	54.00	-9.04	AVG
5	4825.440	51.18	5.98	57.16	74.00	-16.84	peak
6	4825.440	39.31	5.98	45.29	54.00	-8.71	AVG
7	4860.960	52.52	6.08	58.60	74.00	-15.40	peak
8	4860.960	39.42	6.08	45.50	54.00	-8.50	AVG
9	5066.400	51.05	6.70	57.75	74.00	-16.25	peak
10	5066.400	39.06	6.70	45.76	54.00	-8.24	AVG
11	5118.240	51.52	6.84	58.36	74.00	-15.64	peak
12	5118.240	38.49	6.84	45.33	54.00	-8.67	AVG
13	5150.000	50.84	6.94	57.78	74.00	-16.22	peak
14	5150.000	39.04	6.94	45.98	54.00	-8.02	AVG
15	5236.320	103.20	7.19	110.39	--	--	peak
16	5350.000	47.57	7.50	55.07	74.00	-18.93	peak
17	5350.000	37.51	7.50	45.01	54.00	-8.99	AVG
18	5382.240	49.72	7.60	57.32	74.00	-16.68	peak
19	5382.240	37.75	7.60	45.35	54.00	-8.65	AVG
20	5402.400	50.20	7.65	57.85	74.00	-16.15	peak
21	5402.400	38.64	7.65	46.29	54.00	-7.71	AVG
22	5432.160	50.45	7.74	58.19	74.00	-15.81	peak
23	5432.160	38.99	7.74	46.73	54.00	-7.27	AVG

Note:1.Result (dBuV/m) = Correct Factor (dB/m) + Reading(dBuV).

2.Correction factor (dB/m) = Antenna Factor (dB/m) + Cable loss (dB) – Pre-Amplifier gain (dB).

3.When the peak results are less than average limit, so not need to evaluate the average.



Standard:	FCC Part 15.407	Test Distance:	3m
Test item:	Band edge		
Frequency:	5240MHz		
Mode:	Mode 3		
Ant.Polar.:	Vertical		

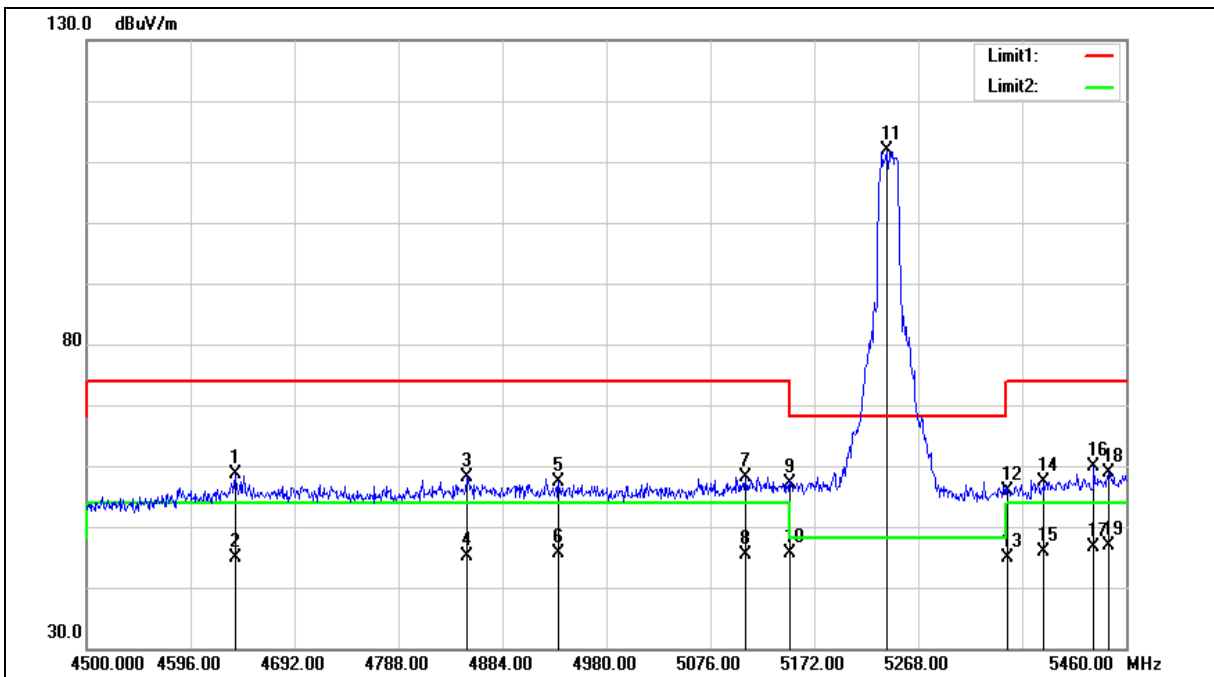



Standard:	FCC Part 15.407	Test Distance:	3m
Test item:	Band edge		
Frequency:	5240MHz		
Mode:	Mode 3		
Ant.Polar.:	Vertical		

No.	Frequency (MHz)	Reading (dBuV)	Correct Factor (dB/m)	Result (dBuV/m)	Limit (dBuV/m)	Margin (dB)	Remark
1	4637.280	53.27	5.40	58.67	74.00	-15.33	peak
2	4637.280	39.60	5.40	45.00	54.00	-9.00	AVG
3	4851.360	52.12	6.06	58.18	74.00	-15.82	peak
4	4851.360	39.13	6.06	45.19	54.00	-8.81	AVG
5	4935.840	51.04	6.32	57.36	74.00	-16.64	peak
6	4935.840	39.28	6.32	45.60	54.00	-8.40	AVG
7	5108.640	51.34	6.82	58.16	74.00	-15.84	peak
8	5108.640	38.52	6.82	45.34	54.00	-8.66	AVG
9	5150.000	50.07	6.94	57.01	74.00	-16.99	peak
10	5150.000	38.64	6.94	45.58	54.00	-8.42	AVG
11	5239.200	104.61	7.19	111.80	--	--	peak
12	5350.000	48.38	7.50	55.88	74.00	-18.12	peak
13	5350.000	37.29	7.50	44.79	54.00	-9.21	AVG
14	5384.160	49.81	7.60	57.41	74.00	-16.59	peak
15	5384.160	38.16	7.60	45.76	54.00	-8.24	AVG
16	5430.240	52.04	7.73	59.77	74.00	-14.23	peak
17	5430.240	38.93	7.73	46.66	54.00	-7.34	AVG
18	5443.680	51.18	7.77	58.95	74.00	-15.05	peak
19	5443.680	39.04	7.77	46.81	54.00	-7.19	AVG

Note:1.Result (dBuV/m) = Correct Factor (dB/m) + Reading(dBuV).

2.Correction factor (dB/m) = Antenna Factor (dB/m) + Cable loss (dB) – Pre-Amplifier gain (dB).

3.When the peak results are less than average limit, so not need to evaluate the average.



Standard:	FCC Part 15.407	Test Distance:	3m
Test item:	Band edge		
Frequency:	5745MHz		
Mode:	Mode 3		
Ant.Polar.:	Horizontal		

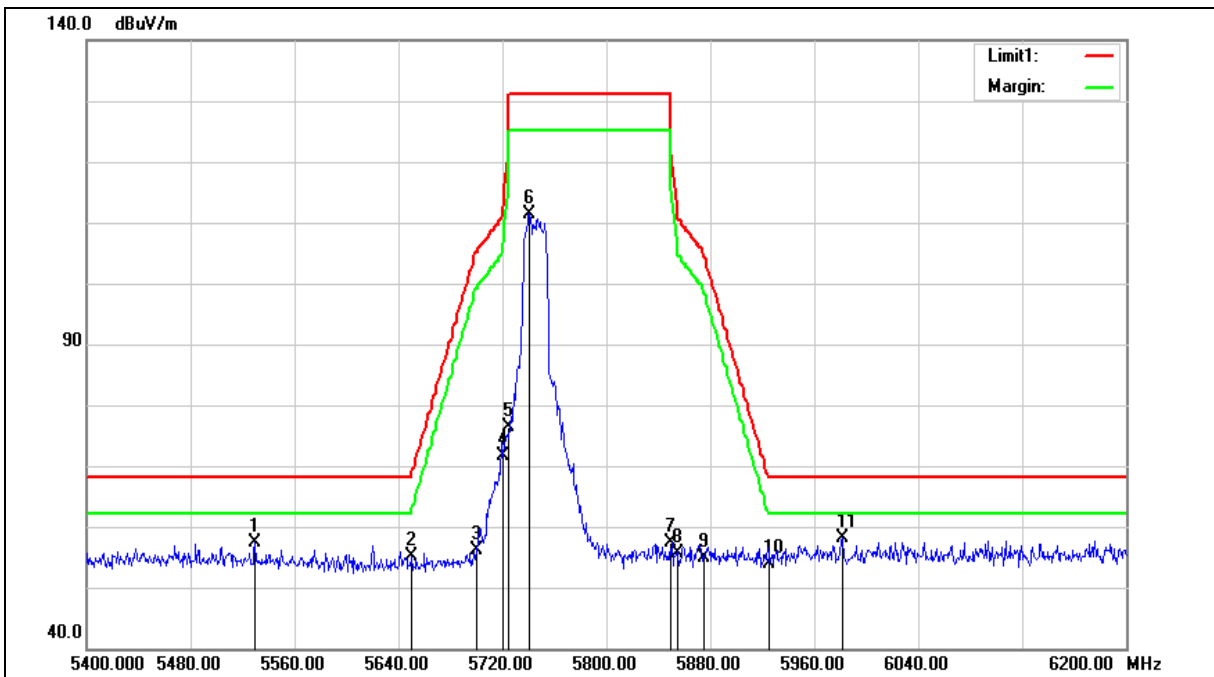



Standard:	FCC Part 15.407	Test Distance:	3m
Test item:	Band edge		
Frequency:	5745MHz		
Mode:	Mode 3		
Ant.Polar.:	Horizontal		

No.	Frequency (MHz)	Reading (dBuV)	Correct Factor (dB/m)	Result (dBuV/m)	Limit (dBuV/m)	Margin (dB)	Remark
1	5529.600	51.21	6.09	57.30	68.20	-10.90	peak
2	5650.000	48.94	6.31	55.25	68.20	-12.95	peak
3	5700.000	49.67	6.40	56.07	105.20	-49.13	peak
4	5720.000	65.28	6.44	71.72	110.80	-39.08	peak
5	5725.000	69.90	6.45	76.35	122.20	-45.85	peak
6	5740.800	104.86	6.47	111.33	--	--	peak
7	5850.000	50.59	6.67	57.26	122.20	-64.94	peak
8	5855.000	48.84	6.67	55.51	110.80	-55.29	peak
9	5875.000	48.04	6.72	54.76	105.20	-50.44	peak
10	5925.000	47.00	6.80	53.80	68.20	-14.40	peak
11	5981.600	51.12	6.90	58.02	68.20	-10.18	peak

Note:1.Result (dBuV/m) = Correct Factor (dB/m) + Reading(dBuV).

2.Correction factor (dB/m) = Antenna Factor (dB/m) + Cable loss (dB) – Pre-Amplifier gain (dB).

3.When the peak results are less than average limit, so not need to evaluate the average.



Standard:	FCC Part 15.407	Test Distance:	3m
Test item:	Band edge		
Frequency:	5745MHz		
Mode:	Mode 3		
Ant.Polar.:	Vertical		

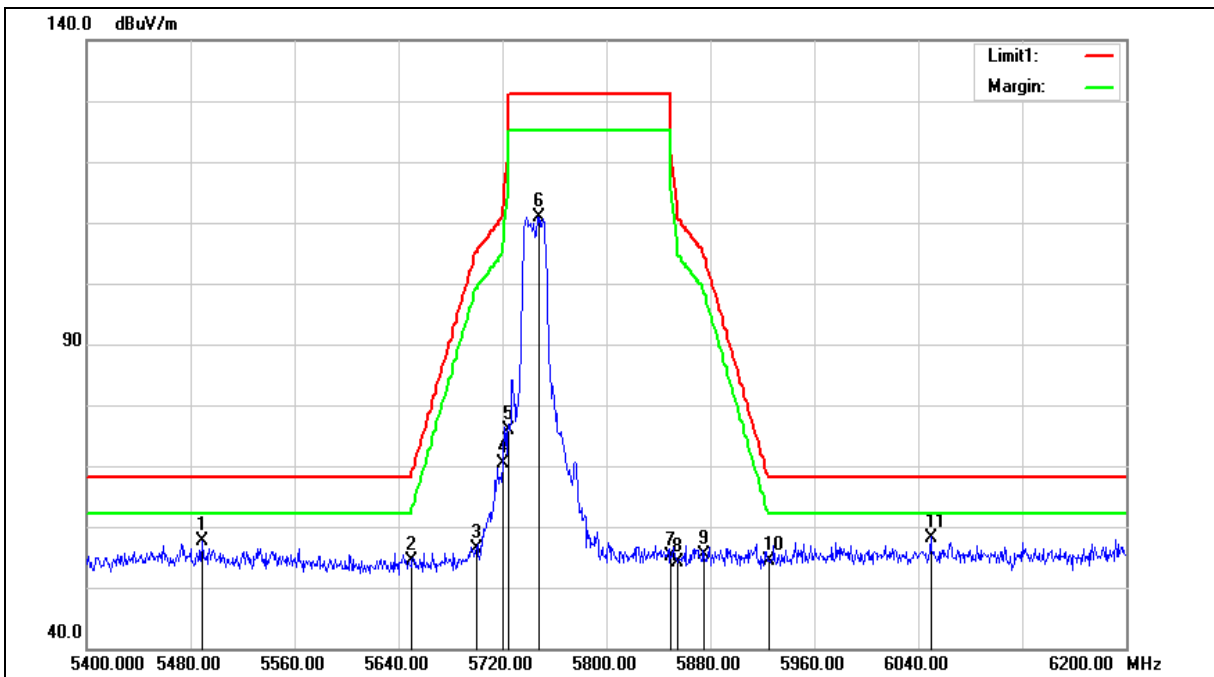



Standard:	FCC Part 15.407	Test Distance:	3m
Test item:	Band edge		
Frequency:	5745MHz		
Mode:	Mode 3		
Ant.Polar.:	Vertical		

No.	Frequency (MHz)	Reading (dBuV)	Correct Factor (dB/m)	Result (dBuV/m)	Limit (dBuV/m)	Margin (dB)	Remark
1	5488.800	51.54	6.01	57.55	68.20	-10.65	peak
2	5650.000	47.96	6.31	54.27	68.20	-13.93	peak
3	5700.000	49.94	6.40	56.34	105.20	-48.86	peak
4	5720.000	63.95	6.44	70.39	110.80	-40.41	peak
5	5725.000	69.34	6.45	75.79	122.20	-46.41	peak
6	5748.000	104.42	6.48	110.90	--	--	peak
7	5850.000	48.53	6.67	55.20	122.20	-67.00	peak
8	5855.000	47.40	6.67	54.07	110.80	-56.73	peak
9	5875.000	48.59	6.72	55.31	105.20	-49.89	peak
10	5925.000	47.62	6.80	54.42	68.20	-13.78	peak
11	6049.600	51.16	7.09	58.25	68.20	-9.95	peak

Note:1.Result (dBuV/m) = Correct Factor (dB/m) + Reading(dBuV).

2.Correction factor (dB/m) = Antenna Factor (dB/m) + Cable loss (dB) – Pre-Amplifier gain (dB).

3.When the peak results are less than average limit, so not need to evaluate the average.



Standard:	FCC Part 15.407	Test Distance:	3m
Test item:	Band edge		
Frequency:	5785MHz		
Mode:	Mode 3		
Ant.Polar.:	Horizontal		

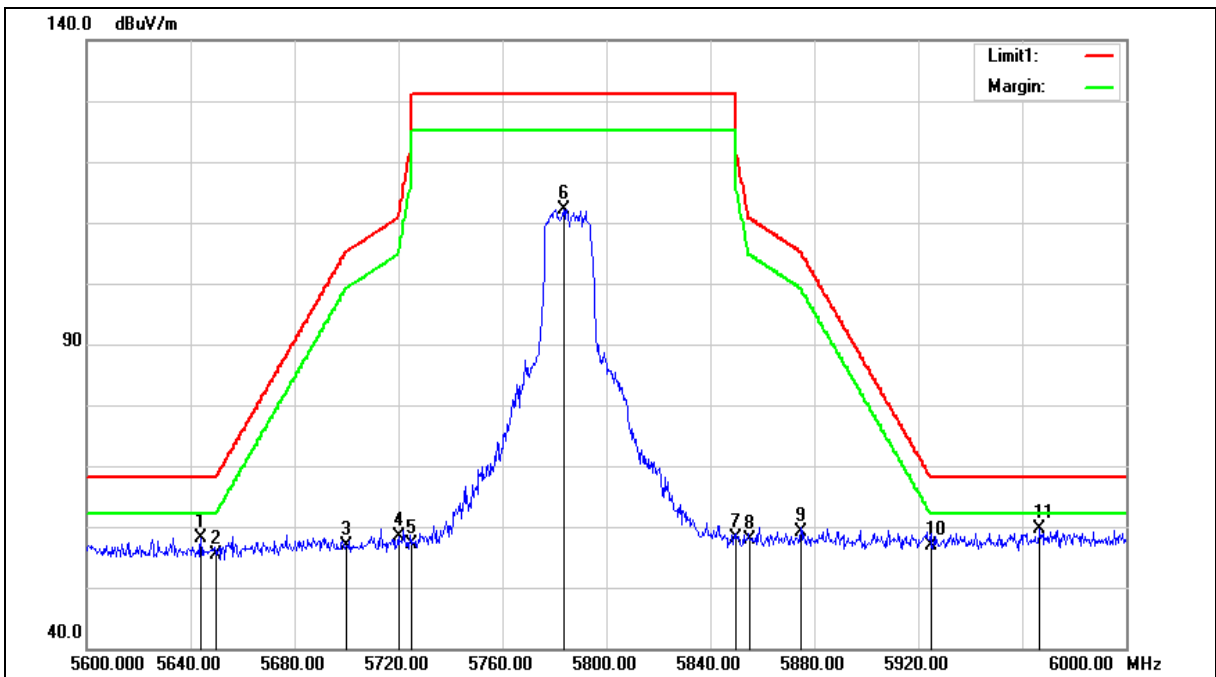



Standard:	FCC Part 15.407	Test Distance:	3m
Test item:	Band edge		
Frequency:	5785MHz		
Mode:	Mode 3		
Ant.Polar.:	Horizontal		

No.	Frequency (MHz)	Reading (dBuV)	Correct Factor (dB/m)	Result (dBuV/m)	Limit (dBuV/m)	Margin (dB)	Remark
1	5644.000	50.03	8.22	58.25	68.20	-9.95	peak
2	5650.000	47.24	8.24	55.48	68.20	-12.72	peak
3	5700.000	48.50	8.34	56.84	105.20	-48.36	peak
4	5720.000	49.96	8.38	58.34	110.80	-52.46	peak
5	5725.000	48.64	8.39	57.03	122.20	-65.17	peak
6	5783.600	103.74	8.50	112.24	--	--	peak
7	5850.000	49.56	8.63	58.19	122.20	-64.01	peak
8	5855.000	49.33	8.64	57.97	110.80	-52.83	peak
9	5875.000	50.43	8.69	59.12	105.20	-46.08	peak
10	5925.000	48.03	8.79	56.82	68.20	-11.38	peak
11	5966.800	50.63	8.88	59.51	68.20	-8.69	peak

Note:1.Result (dBuV/m) = Correct Factor (dB/m) + Reading(dBuV).

2.Correction factor (dB/m) = Antenna Factor (dB/m) + Cable loss (dB) – Pre-Amplifier gain (dB).

3.When the peak results are less than average limit, so not need to evaluate the average.



Standard:	FCC Part 15.407	Test Distance:	3m
Test item:	Band edge		
Frequency:	5785MHz		
Mode:	Mode 3		
Ant.Polar.:	Vertical		

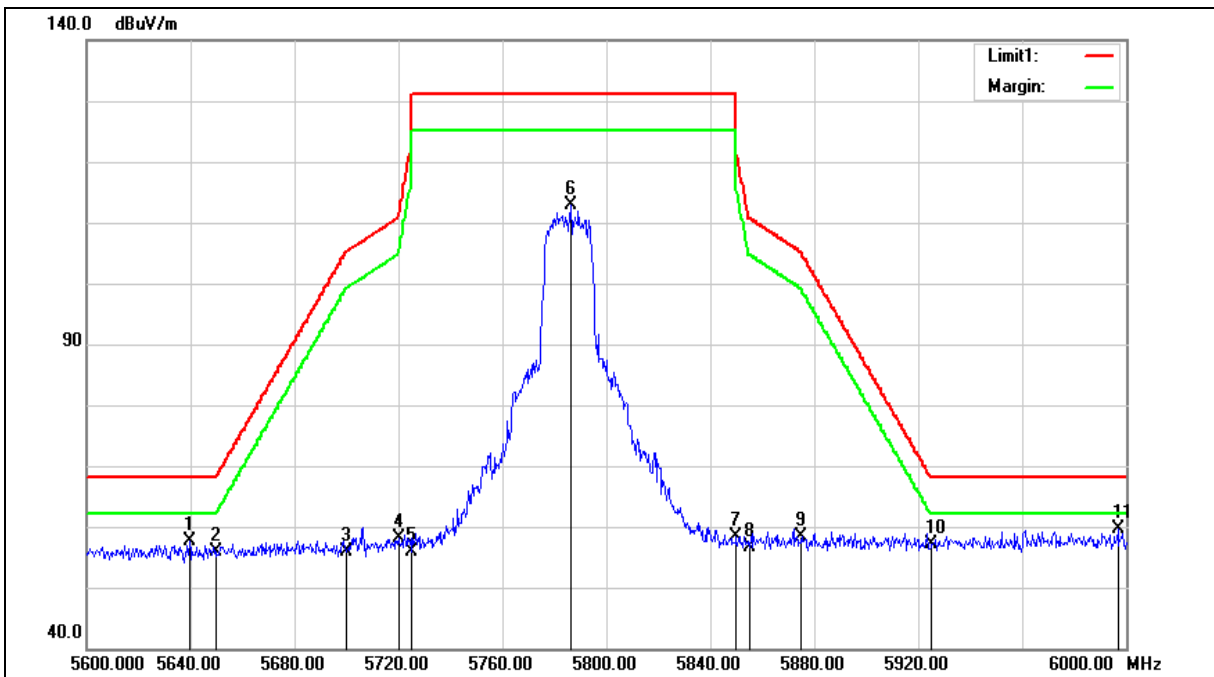



Standard:	FCC Part 15.407	Test Distance:	3m
Test item:	Band edge		
Frequency:	5785MHz		
Mode:	Mode 3		
Ant.Polar.:	Vertical		

No.	Frequency (MHz)	Reading (dBuV)	Correct Factor (dB/m)	Result (dBuV/m)	Limit (dBuV/m)	Margin (dB)	Remark
1	5639.600	49.36	8.22	57.58	68.20	-10.62	peak
2	5650.000	47.73	8.24	55.97	68.20	-12.23	peak
3	5700.000	47.56	8.34	55.90	105.20	-49.30	peak
4	5720.000	49.80	8.38	58.18	110.80	-52.62	peak
5	5725.000	47.60	8.39	55.99	122.20	-66.21	peak
6	5786.400	104.28	8.51	112.79	--	--	peak
7	5850.000	49.80	8.63	58.43	122.20	-63.77	peak
8	5855.000	48.02	8.64	56.66	110.80	-54.14	peak
9	5875.000	49.77	8.69	58.46	105.20	-46.74	peak
10	5925.000	48.35	8.79	57.14	68.20	-11.06	peak
11	5996.800	50.62	8.94	59.56	68.20	-8.64	peak

Note:1.Result (dBuV/m) = Correct Factor (dB/m) + Reading(dBuV).

2.Correction factor (dB/m) = Antenna Factor (dB/m) + Cable loss (dB) – Pre-Amplifier gain (dB).

3.When the peak results are less than average limit, so not need to evaluate the average.



Standard:	FCC Part 15.407	Test Distance:	3m
Test item:	Band edge		
Frequency:	5825MHz		
Mode:	Mode 3		
Ant.Polar.:	Horizontal		

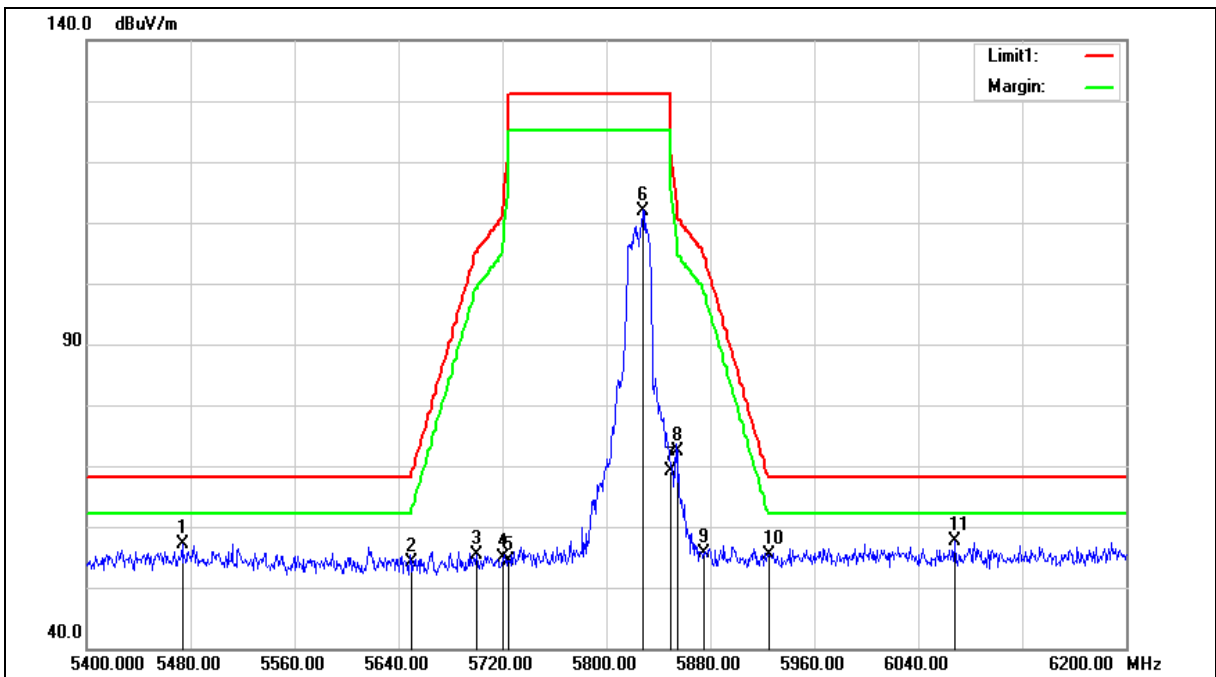



Standard:	FCC Part 15.407	Test Distance:	3m
Test item:	Band edge		
Frequency:	5825MHz		
Mode:	Mode 3		
Ant.Polar.:	Horizontal		

No.	Frequency (MHz)	Reading (dBuV)	Correct Factor (dB/m)	Result (dBuV/m)	Limit (dBuV/m)	Margin (dB)	Remark
1	5473.600	51.27	5.96	57.23	68.20	-10.97	peak
2	5650.000	47.94	6.31	54.25	68.20	-13.95	peak
3	5700.000	48.89	6.40	55.29	105.20	-49.91	peak
4	5720.000	48.51	6.44	54.95	110.80	-55.85	peak
5	5725.000	47.90	6.45	54.35	122.20	-67.85	peak
6	5828.000	105.37	6.63	112.00	--	--	peak
7	5850.000	62.57	6.67	69.24	122.20	-52.96	peak
8	5855.000	65.83	6.67	72.50	110.80	-38.30	peak
9	5875.000	48.97	6.72	55.69	105.20	-49.51	peak
10	5925.000	48.56	6.80	55.36	68.20	-12.84	peak
11	6068.000	50.43	7.15	57.58	68.20	-10.62	peak

Note:1.Result (dBuV/m) = Correct Factor (dB/m) + Reading(dBuV).

2.Correction factor (dB/m) = Antenna Factor (dB/m) + Cable loss (dB) – Pre-Amplifier gain (dB).

3.When the peak results are less than average limit, so not need to evaluate the average.



Standard:	FCC Part 15.407	Test Distance:	3m
Test item:	Band edge		
Frequency:	5825MHz		
Mode:	Mode 3		
Ant.Polar.:	Vertical		

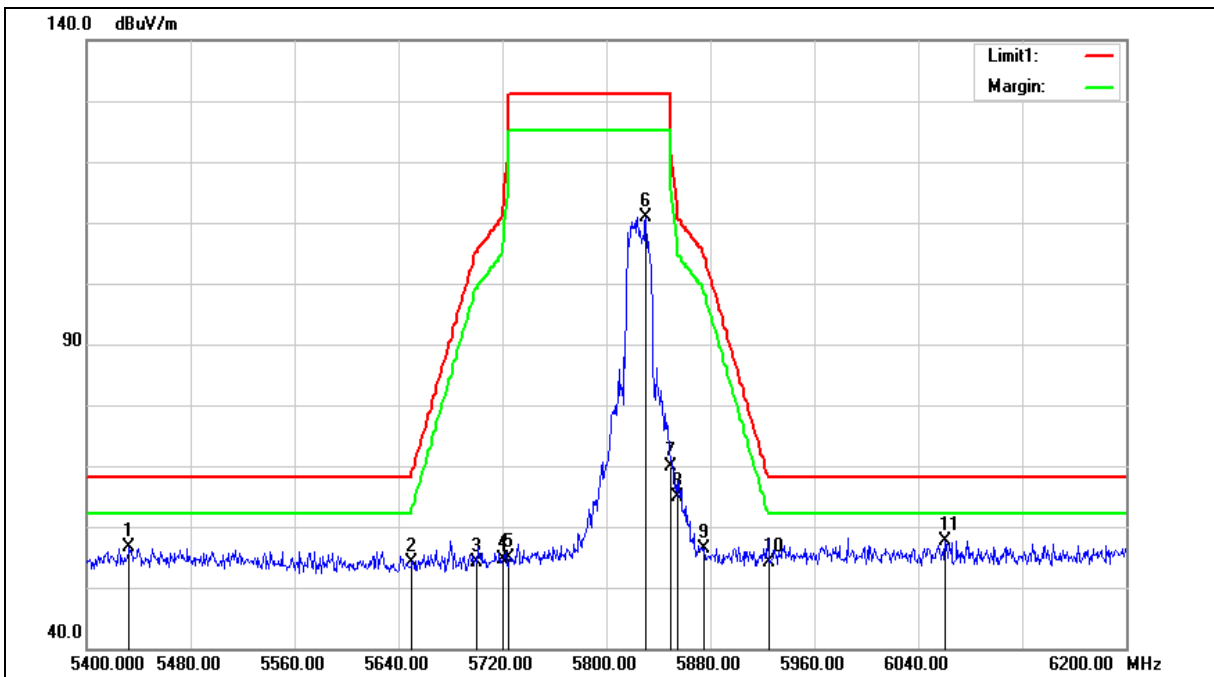



Standard:	FCC Part 15.407	Test Distance:	3m
Test item:	Band edge		
Frequency:	5825MHz		
Mode:	Mode 3		
Ant.Polar.:	Vertical		

No.	Frequency (MHz)	Reading (dBuV)	Correct Factor (dB/m)	Result (dBuV/m)	Limit (dBuV/m)	Margin (dB)	Remark
1	5432.800	50.85	5.86	56.71	68.20	-11.49	peak
2	5650.000	47.76	6.31	54.07	68.20	-14.13	peak
3	5700.000	47.81	6.40	54.21	105.20	-50.99	peak
4	5720.000	48.17	6.44	54.61	110.80	-56.19	peak
5	5725.000	48.32	6.45	54.77	122.20	-67.43	peak
6	5830.400	104.25	6.63	110.88	--	--	peak
7	5850.000	63.28	6.67	69.95	122.20	-52.25	peak
8	5855.000	58.32	6.67	64.99	110.80	-45.81	peak
9	5875.000	49.57	6.72	56.29	105.20	-48.91	peak
10	5925.000	47.30	6.80	54.10	68.20	-14.10	peak
11	6060.800	50.60	7.12	57.72	68.20	-10.48	peak

Note:1.Result (dBuV/m) = Correct Factor (dB/m) + Reading(dBuV).

2.Correction factor (dB/m) = Antenna Factor (dB/m) + Cable loss (dB) – Pre-Amplifier gain (dB).

3.When the peak results are less than average limit, so not need to evaluate the average.



Standard:	FCC Part 15.407	Test Distance:	3m
Test item:	Band edge		
Frequency:	5190MHz		
Mode:	Mode 4		
Ant.Polar.:	Horizontal		

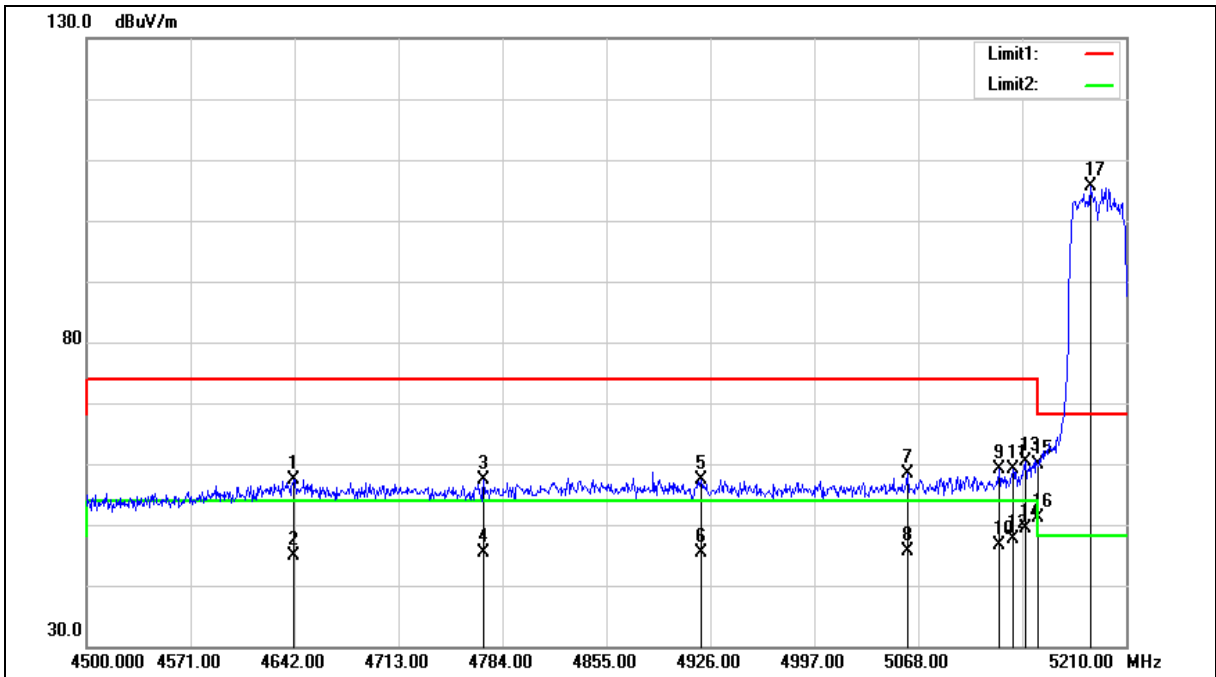



Standard:	FCC Part 15.407	Test Distance:	3m
Test item:	Band edge		
Frequency:	5190MHz		
Mode:	Mode 4		
Ant.Polar.:	Horizontal		

No.	Frequency (MHz)	Reading (dBuV)	Correct Factor (dB/m)	Result (dBuV/m)	Limit (dBuV/m)	Margin (dB)	Remark
1	4641.290	51.94	5.41	57.35	74.00	-16.65	peak
2	4641.290	39.54	5.41	44.95	54.00	-9.05	AVG
3	4771.220	51.47	5.81	57.28	74.00	-16.72	peak
4	4771.220	39.46	5.81	45.27	54.00	-8.73	AVG
5	4919.610	51.10	6.26	57.36	74.00	-16.64	peak
6	4919.610	39.20	6.26	45.46	54.00	-8.54	AVG
7	5060.900	51.69	6.68	58.37	74.00	-15.63	peak
8	5060.900	39.05	6.68	45.73	54.00	-8.27	AVG
9	5123.380	52.16	6.85	59.01	74.00	-14.99	peak
10	5123.380	39.67	6.85	46.52	54.00	-7.48	AVG
11	5132.610	52.28	6.89	59.17	74.00	-14.83	peak
12	5132.610	40.82	6.89	47.71	54.00	-6.29	AVG
13	5141.130	53.39	6.91	60.30	74.00	-13.70	peak
14	5141.130	42.58	6.91	49.49	54.00	-4.51	AVG
15	5150.000	52.94	6.94	59.88	74.00	-14.12	peak
16	5150.000	44.18	6.94	51.12	54.00	-2.88	AVG
17	5185.860	98.47	7.04	105.51	--	--	peak

Note:1.Result (dBuV/m) = Correct Factor (dB/m) + Reading(dBuV).

2.Correction factor (dB/m) = Antenna Factor (dB/m) + Cable loss (dB) – Pre-Amplifier gain (dB).

3.When the peak results are less than average limit, so not need to evaluate the average.



Standard:	FCC Part 15.407	Test Distance:	3m
Test item:	Band edge		
Frequency:	5190MHz		
Mode:	Mode 4		
Ant.Polar.:	Vertical		

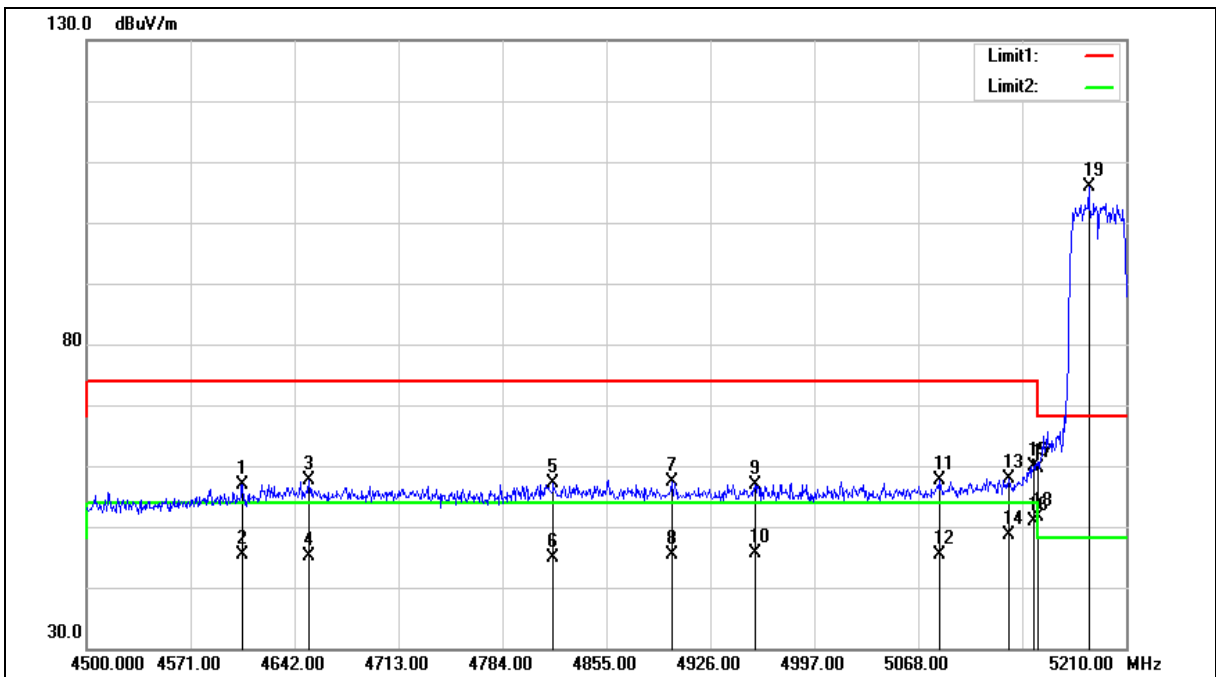



Standard:	FCC Part 15.407	Test Distance:	3m
Test item:	Band edge		
Frequency:	5190MHz		
Mode:	Mode 4		
Ant.Polar.:	Vertical		

No.	Frequency (MHz)	Reading (dBuV)	Correct Factor (dB/m)	Result (dBuV/m)	Limit (dBuV/m)	Margin (dB)	Remark
1	4606.500	51.63	5.30	56.93	74.00	-17.07	peak
2	4606.500	40.02	5.30	45.32	54.00	-8.68	AVG
3	4651.940	52.08	5.44	57.52	74.00	-16.48	peak
4	4651.940	39.73	5.44	45.17	54.00	-8.83	AVG
5	4818.790	51.14	5.95	57.09	74.00	-16.91	peak
6	4818.790	39.04	5.95	44.99	54.00	-9.01	AVG
7	4899.730	51.12	6.20	57.32	74.00	-16.68	peak
8	4899.730	39.06	6.20	45.26	54.00	-8.74	AVG
9	4956.530	50.41	6.37	56.78	74.00	-17.22	peak
10	4956.530	39.28	6.37	45.65	54.00	-8.35	AVG
11	5082.200	50.95	6.74	57.69	74.00	-16.31	peak
12	5082.200	38.70	6.74	45.44	54.00	-8.56	AVG
13	5129.770	51.10	6.88	57.98	74.00	-16.02	peak
14	5129.770	41.73	6.88	48.61	54.00	-5.39	AVG
15	5146.810	52.99	6.93	59.92	74.00	-14.08	peak
16	5146.810	43.86	6.93	50.79	54.00	-3.21	AVG
17	5150.000	52.67	6.94	59.61	74.00	-14.39	peak
18	5150.000	44.63	6.94	51.57	54.00	-2.43	AVG
19	5184.440	98.83	7.03	105.86	--	--	peak

Note:1.Result (dBuV/m) = Correct Factor (dB/m) + Reading(dBuV).

2.Correction factor (dB/m) = Antenna Factor (dB/m) + Cable loss (dB) – Pre-Amplifier gain (dB).

3.When the peak results are less than average limit, so not need to evaluate the average.



Standard:	FCC Part 15.407	Test Distance:	3m
Test item:	Band edge		
Frequency:	5230MHz		
Mode:	Mode 4		
Ant.Polar.:	Horizontal		

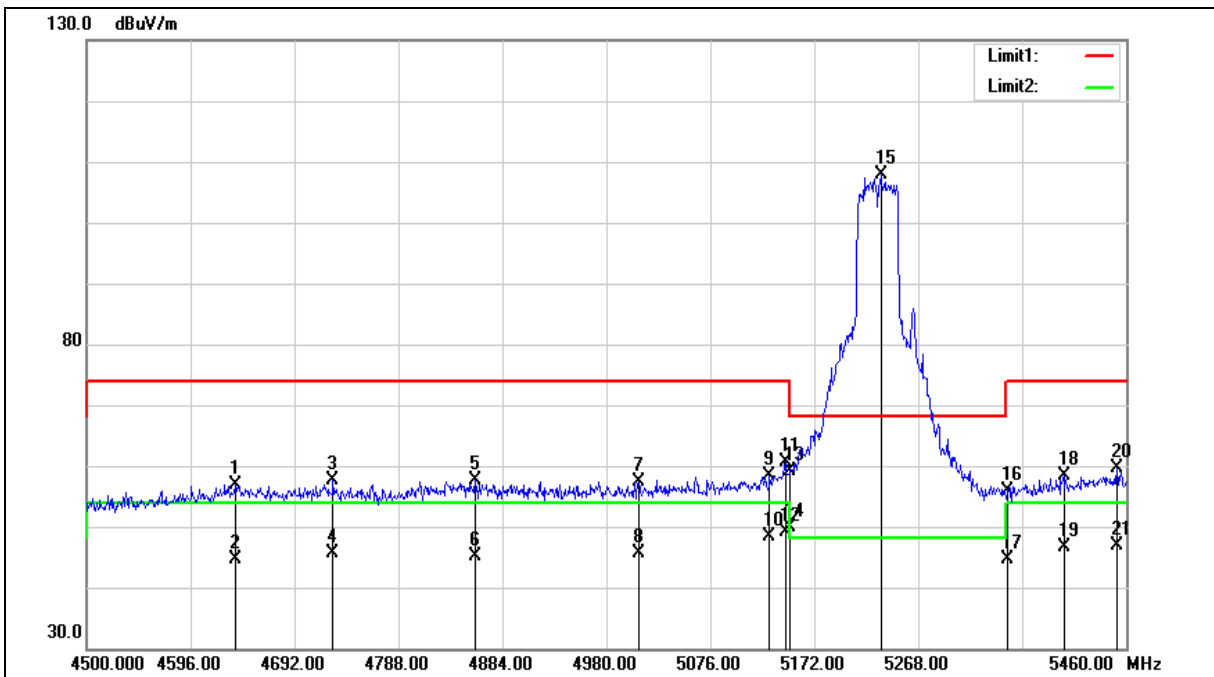



Standard:	FCC Part 15.407	Test Distance:	3m
Test item:	Band edge		
Frequency:	5230MHz		
Mode:	Mode 4		
Ant.Polar.:	Horizontal		

No.	Frequency (MHz)	Reading (dBuV)	Correct Factor (dB/m)	Result (dBuV/m)	Limit (dBuV/m)	Margin (dB)	Remark
1	4637.280	51.60	5.40	57.00	74.00	-17.00	peak
2	4637.280	39.26	5.40	44.66	54.00	-9.34	AVG
3	4727.520	51.87	5.68	57.55	74.00	-16.45	peak
4	4727.520	39.95	5.68	45.63	54.00	-8.37	AVG
5	4859.040	51.49	6.08	57.57	74.00	-16.43	peak
6	4859.040	39.12	6.08	45.20	54.00	-8.80	AVG
7	5009.760	50.84	6.54	57.38	74.00	-16.62	peak
8	5009.760	39.01	6.54	45.55	54.00	-8.45	AVG
9	5130.720	51.37	6.89	58.26	74.00	-15.74	peak
10	5130.720	41.40	6.89	48.29	54.00	-5.71	AVG
11	5145.120	53.63	6.93	60.56	74.00	-13.44	peak
12	5145.120	42.18	6.93	49.11	54.00	-4.89	AVG
13	5150.000	52.31	6.94	59.25	74.00	-14.75	peak
14	5150.000	42.85	6.94	49.79	54.00	-4.21	AVG
15	5233.440	100.75	7.17	107.92	--	--	peak
16	5350.000	48.36	7.50	55.86	74.00	-18.14	peak
17	5350.000	37.25	7.50	44.75	54.00	-9.25	AVG
18	5402.400	50.71	7.65	58.36	74.00	-15.64	peak
19	5402.400	38.91	7.65	46.56	54.00	-7.44	AVG
20	5451.360	51.91	7.79	59.70	74.00	-14.30	peak
21	5451.360	39.12	7.79	46.91	54.00	-7.09	AVG

Note:1.Result (dBuV/m) = Correct Factor (dB/m) + Reading(dBuV).

2.Correction factor (dB/m) = Antenna Factor (dB/m) + Cable loss (dB) – Pre-Amplifier gain (dB).

3.When the peak results are less than average limit, so not need to evaluate the average.



Standard:	FCC Part 15.407	Test Distance:	3m
Test item:	Band edge		
Frequency:	5230MHz		
Mode:	Mode 4		
Ant.Polar.:	Vertical		

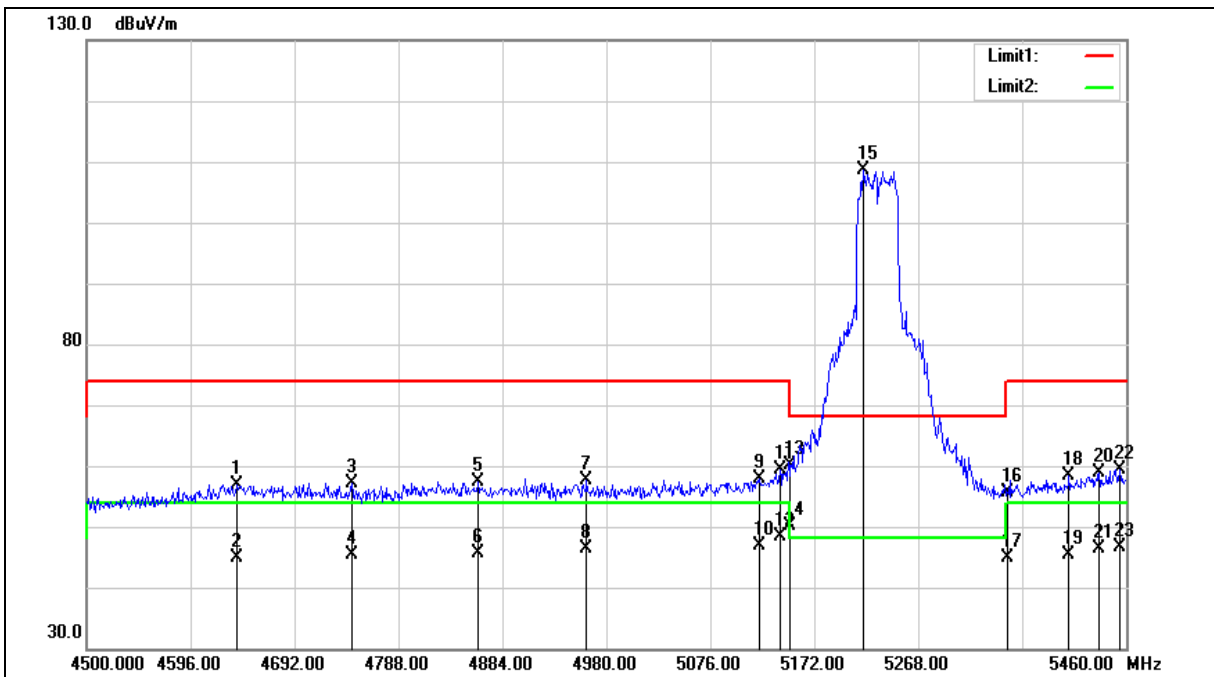



Standard:	FCC Part 15.407	Test Distance:	3m
Test item:	Band edge		
Frequency:	5230MHz		
Mode:	Mode 4		
Ant.Polar.:	Vertical		

No.	Frequency (MHz)	Reading (dBuV)	Correct Factor (dB/m)	Result (dBuV/m)	Limit (dBuV/m)	Margin (dB)	Remark
1	4638.240	51.55	5.40	56.95	74.00	-17.05	peak
2	4638.240	39.40	5.40	44.80	54.00	-9.20	AVG
3	4744.800	51.38	5.73	57.11	74.00	-16.89	peak
4	4744.800	39.72	5.73	45.45	54.00	-8.55	AVG
5	4861.920	51.26	6.09	57.35	74.00	-16.65	peak
6	4861.920	39.60	6.09	45.69	54.00	-8.31	AVG
7	4961.760	51.35	6.39	57.74	74.00	-16.26	peak
8	4961.760	39.88	6.39	46.27	54.00	-7.73	AVG
9	5121.120	50.94	6.85	57.79	74.00	-16.21	peak
10	5121.120	39.99	6.85	46.84	54.00	-7.16	AVG
11	5140.320	52.54	6.91	59.45	74.00	-14.55	peak
12	5140.320	41.46	6.91	48.37	54.00	-5.63	AVG
13	5150.000	53.25	6.94	60.19	74.00	-13.81	peak
14	5150.000	43.23	6.94	50.17	54.00	-3.83	AVG
15	5217.120	101.39	7.13	108.52	--	--	peak
16	5350.000	48.05	7.50	55.55	74.00	-18.45	peak
17	5350.000	37.32	7.50	44.82	54.00	-9.18	AVG
18	5407.200	50.66	7.67	58.33	74.00	-15.67	peak
19	5407.200	37.70	7.67	45.37	54.00	-8.63	AVG
20	5435.040	51.10	7.75	58.85	74.00	-15.15	peak
21	5435.040	38.56	7.75	46.31	54.00	-7.69	AVG
22	5454.240	51.62	7.80	59.42	74.00	-14.58	peak
23	5454.240	38.75	7.80	46.55	54.00	-7.45	AVG

Note:1.Result (dBuV/m) = Correct Factor (dB/m) + Reading(dBuV).

2.Correction factor (dB/m) = Antenna Factor (dB/m) + Cable loss (dB) – Pre-Amplifier gain (dB).

3.When the peak results are less than average limit, so not need to evaluate the average.



Standard:	FCC Part 15.407	Test Distance:	3m
Test item:	Band edge		
Frequency:	5755MHz		
Mode:	Mode 4		
Ant.Polar.:	Horizontal		

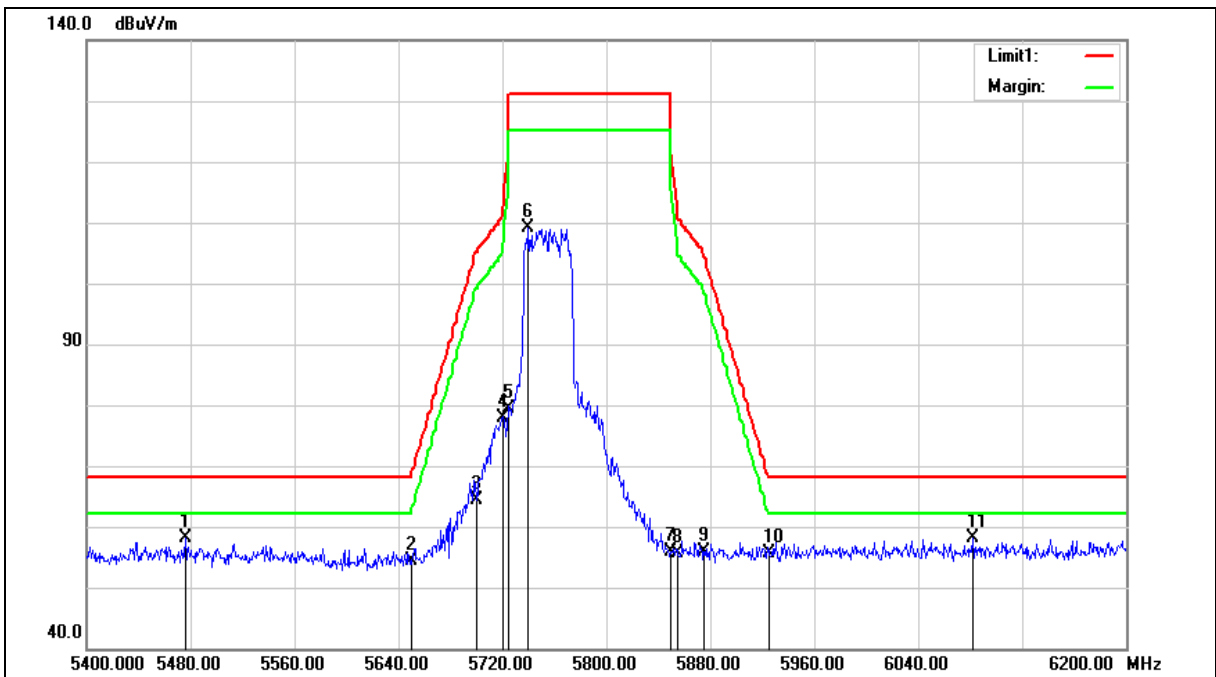



Standard:	FCC Part 15.407	Test Distance:	3m
Test item:	Band edge		
Frequency:	5755MHz		
Mode:	Mode 4		
Ant.Polar.:	Horizontal		

No.	Frequency (MHz)	Reading (dBuV)	Correct Factor (dB/m)	Result (dBuV/m)	Limit (dBuV/m)	Margin (dB)	Remark
1	5476.000	52.22	5.98	58.20	68.20	-10.00	peak
2	5650.000	47.96	6.31	54.27	68.20	-13.93	peak
3	5700.000	57.96	6.40	64.36	105.20	-40.84	peak
4	5720.000	71.51	6.44	77.95	110.80	-32.85	peak
5	5725.000	72.94	6.45	79.39	122.20	-42.81	peak
6	5740.000	102.71	6.47	109.18	--	--	peak
7	5850.000	49.16	6.67	55.83	122.20	-66.37	peak
8	5855.000	48.87	6.67	55.54	110.80	-55.26	peak
9	5875.000	49.19	6.72	55.91	105.20	-49.29	peak
10	5925.000	48.83	6.80	55.63	68.20	-12.57	peak
11	6082.400	50.98	7.18	58.16	68.20	-10.04	peak

Note:1.Result (dBuV/m) = Correct Factor (dB/m) + Reading(dBuV).

2.Correction factor (dB/m) = Antenna Factor (dB/m) + Cable loss (dB) – Pre-Amplifier gain (dB).

3.When the peak results are less than average limit, so not need to evaluate the average.



Standard:	FCC Part 15.407	Test Distance:	3m
Test item:	Band edge		
Frequency:	5755MHz		
Mode:	Mode 4		
Ant.Polar.:	Vertical		

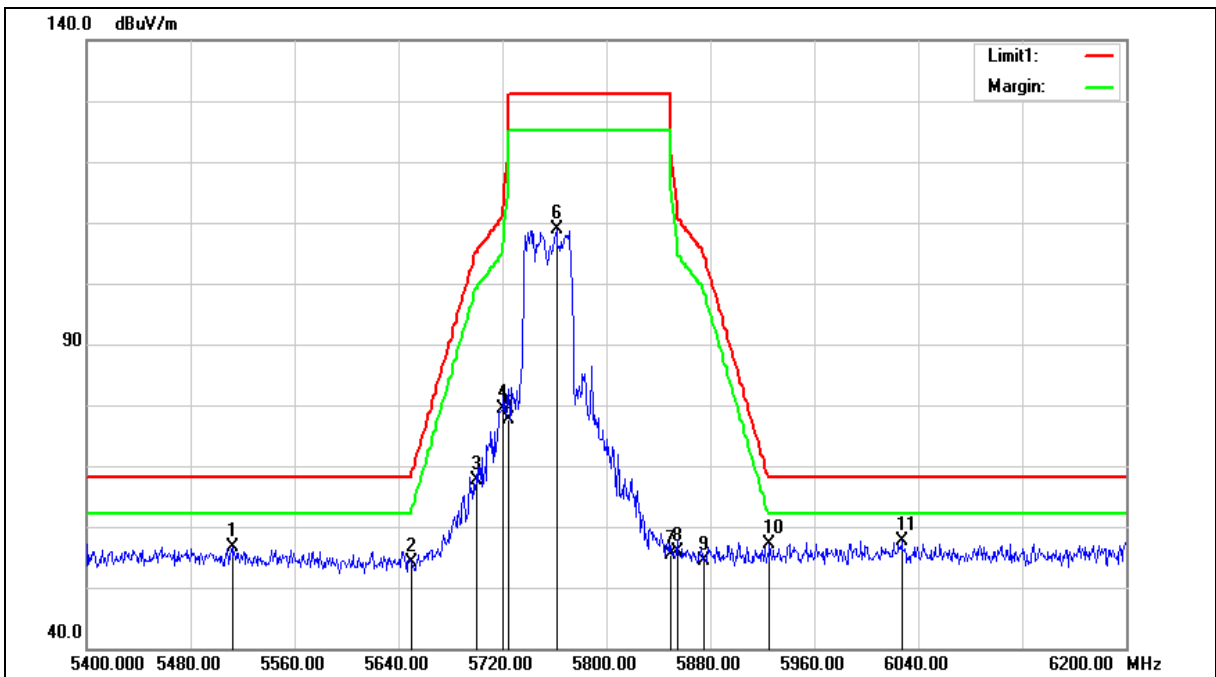



Standard:	FCC Part 15.407	Test Distance:	3m
Test item:	Band edge		
Frequency:	5755MHz		
Mode:	Mode 4		
Ant.Polar.:	Vertical		

No.	Frequency (MHz)	Reading (dBuV)	Correct Factor (dB/m)	Result (dBuV/m)	Limit (dBuV/m)	Margin (dB)	Remark
1	5512.000	50.67	6.05	56.72	68.20	-11.48	peak
2	5650.000	47.85	6.31	54.16	68.20	-14.04	peak
3	5700.000	61.23	6.40	67.63	105.20	-37.57	peak
4	5720.000	72.82	6.44	79.26	110.80	-31.54	peak
5	5725.000	71.19	6.45	77.64	122.20	-44.56	peak
6	5761.600	102.35	6.51	108.86	--	--	peak
7	5850.000	48.72	6.67	55.39	122.20	-66.81	peak
8	5855.000	49.12	6.67	55.79	110.80	-55.01	peak
9	5875.000	47.65	6.72	54.37	105.20	-50.83	peak
10	5925.000	50.34	6.80	57.14	68.20	-11.06	peak
11	6027.200	50.52	7.02	57.54	68.20	-10.66	peak

Note:1.Result (dBuV/m) = Correct Factor (dB/m) + Reading(dBuV).

2.Correction factor (dB/m) = Antenna Factor (dB/m) + Cable loss (dB) – Pre-Amplifier gain (dB).

3.When the peak results are less than average limit, so not need to evaluate the average.



Standard:	FCC Part 15.407	Test Distance:	3m
Test item:	Band edge		
Frequency:	5795MHz		
Mode:	Mode 4		
Ant.Polar.:	Horizontal		

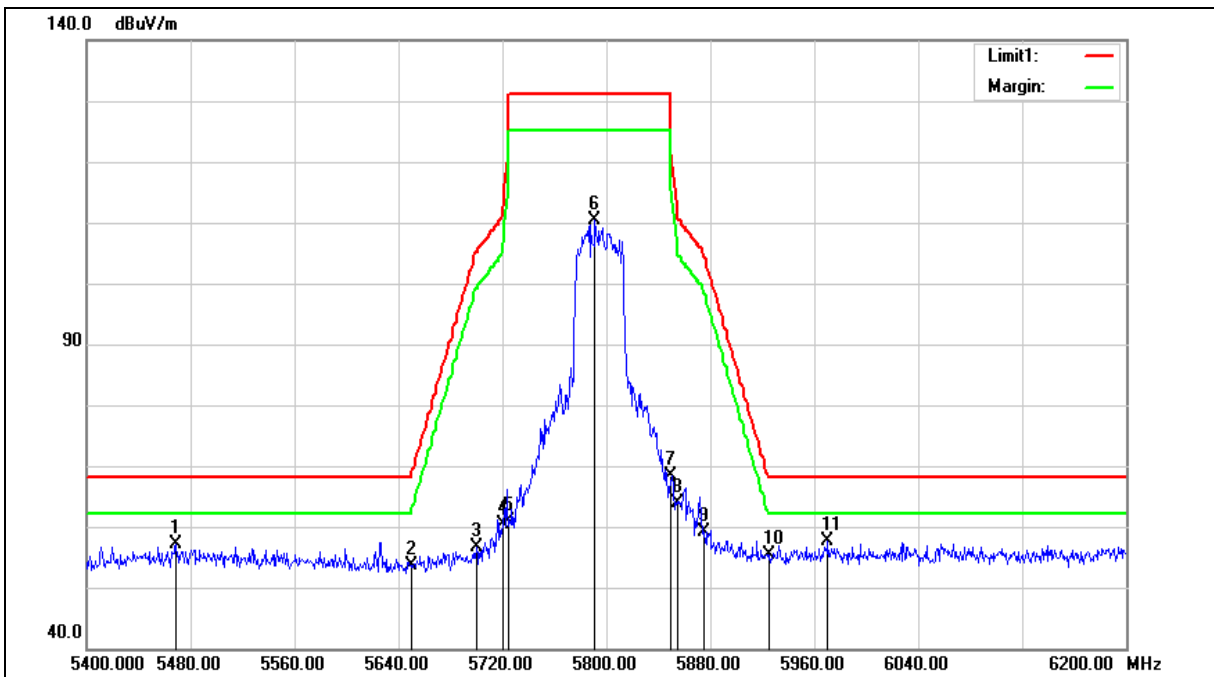



Standard:	FCC Part 15.407	Test Distance:	3m
Test item:	Band edge		
Frequency:	5795MHz		
Mode:	Mode 4		
Ant.Polar.:	Horizontal		

No.	Frequency (MHz)	Reading (dBuV)	Correct Factor (dB/m)	Result (dBuV/m)	Limit (dBuV/m)	Margin (dB)	Remark
1	5468.800	51.18	5.95	57.13	68.20	-11.07	peak
2	5650.000	47.36	6.31	53.67	68.20	-14.53	peak
3	5700.000	50.23	6.40	56.63	105.20	-48.57	peak
4	5720.000	53.90	6.44	60.34	110.80	-50.46	peak
5	5725.000	54.49	6.45	60.94	122.20	-61.26	peak
6	5791.200	103.77	6.57	110.34	--	--	peak
7	5850.000	61.82	6.67	68.49	122.20	-53.71	peak
8	5855.000	57.20	6.67	63.87	110.80	-46.93	peak
9	5875.000	52.46	6.72	59.18	105.20	-46.02	peak
10	5925.000	48.57	6.80	55.37	68.20	-12.83	peak
11	5970.400	50.85	6.89	57.74	68.20	-10.46	peak

Note:1.Result (dBuV/m) = Correct Factor (dB/m) + Reading(dBuV).

2.Correction factor (dB/m) = Antenna Factor (dB/m) + Cable loss (dB) – Pre-Amplifier gain (dB).

3.When the peak results are less than average limit, so not need to evaluate the average.



Standard:	FCC Part 15.407	Test Distance:	3m
Test item:	Band edge		
Frequency:	5795MHz		
Mode:	Mode 4		
Ant.Polar.:	Vertical		

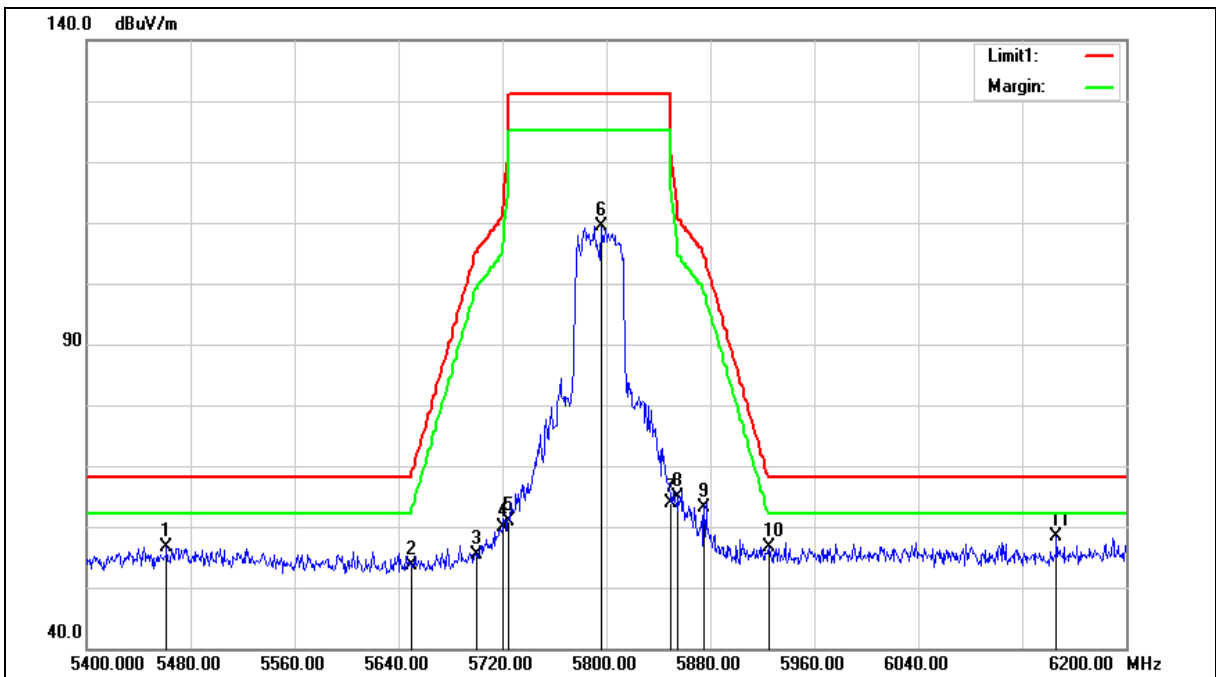



Standard:	FCC Part 15.407	Test Distance:	3m
Test item:	Band edge		
Frequency:	5795MHz		
Mode:	Mode 4		
Ant.Polar.:	Vertical		

No.	Frequency (MHz)	Reading (dBuV)	Correct Factor (dB/m)	Result (dBuV/m)	Limit (dBuV/m)	Margin (dB)	Remark
1	5461.600	50.74	5.93	56.67	68.20	-11.53	peak
2	5650.000	47.44	6.31	53.75	68.20	-14.45	peak
3	5700.000	49.05	6.40	55.45	105.20	-49.75	peak
4	5720.000	53.37	6.44	59.81	110.80	-50.99	peak
5	5725.000	54.31	6.45	60.76	122.20	-61.44	peak
6	5796.000	102.78	6.57	109.35	--	--	peak
7	5850.000	57.30	6.67	63.97	122.20	-58.23	peak
8	5855.000	58.11	6.67	64.78	110.80	-46.02	peak
9	5875.000	56.53	6.72	63.25	105.20	-41.95	peak
10	5925.000	49.82	6.80	56.62	68.20	-11.58	peak
11	6146.400	50.95	7.37	58.32	68.20	-9.88	peak

Note:1.Result (dBuV/m) = Correct Factor (dB/m) + Reading(dBuV).

2.Correction factor (dB/m) = Antenna Factor (dB/m) + Cable loss (dB) – Pre-Amplifier gain (dB).

3.When the peak results are less than average limit, so not need to evaluate the average.



Standard:	FCC Part 15.407	Test Distance:	3m
Test item:	Band edge		
Frequency:	5210MHz		
Mode:	Mode 5		
Ant.Polar.:	Horizontal		

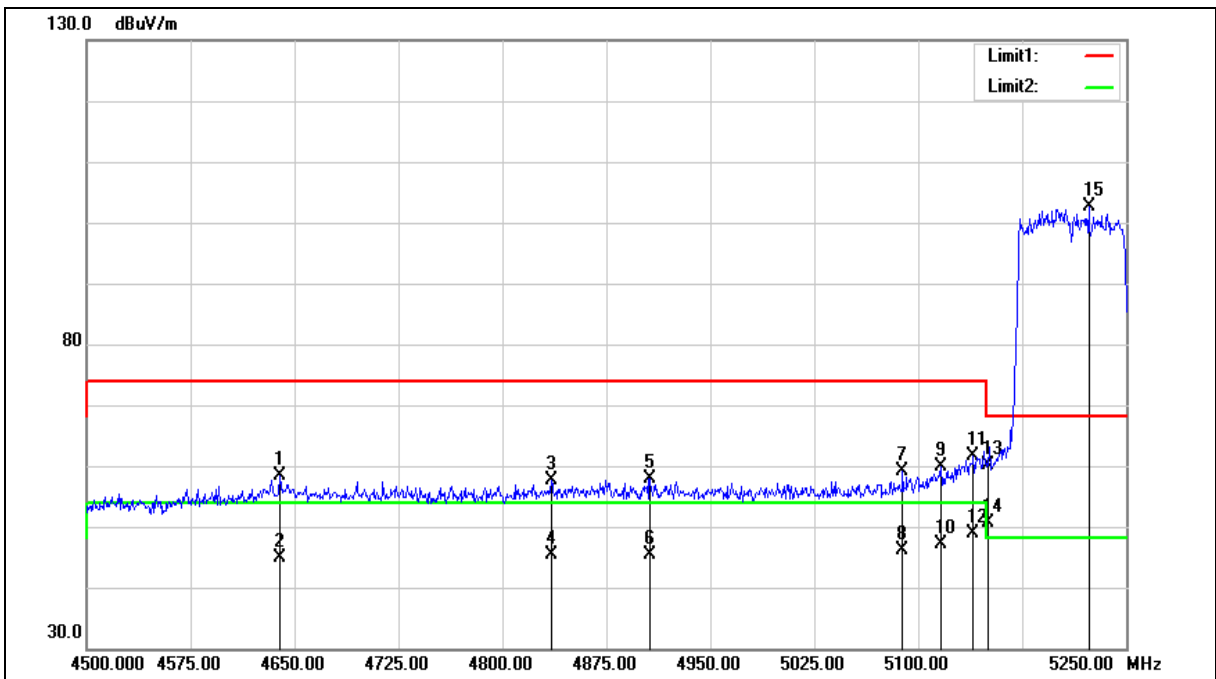



Standard:	FCC Part 15.407	Test Distance:	3m
Test item:	Band edge		
Frequency:	5210MHz		
Mode:	Mode 5		
Ant.Polar.:	Horizontal		

No.	Frequency (MHz)	Reading (dBuV)	Correct Factor (dB/m)	Result (dBuV/m)	Limit (dBuV/m)	Margin (dB)	Remark
1	4639.500	52.92	5.41	58.33	74.00	-15.67	peak
2	4639.500	39.36	5.41	44.77	54.00	-9.23	AVG
3	4835.250	51.58	6.00	57.58	74.00	-16.42	peak
4	4835.250	39.31	6.00	45.31	54.00	-8.69	AVG
5	4906.500	51.75	6.22	57.97	74.00	-16.03	peak
6	4906.500	39.15	6.22	45.37	54.00	-8.63	AVG
7	5088.750	52.31	6.76	59.07	74.00	-14.93	peak
8	5088.750	39.30	6.76	46.06	54.00	-7.94	AVG
9	5116.500	52.92	6.84	59.76	74.00	-14.24	peak
10	5116.500	40.29	6.84	47.13	54.00	-6.87	AVG
11	5139.750	54.75	6.91	61.66	74.00	-12.34	peak
12	5139.750	41.96	6.91	48.87	54.00	-5.13	AVG
13	5150.000	53.20	6.94	60.14	74.00	-13.86	peak
14	5150.000	43.73	6.94	50.67	54.00	-3.33	AVG
15	5223.000	95.60	7.14	102.74	--	--	peak

Note:1.Result (dBuV/m) = Correct Factor (dB/m) + Reading(dBuV).

2.Correction factor (dB/m) = Antenna Factor (dB/m) + Cable loss (dB) – Pre-Amplifier gain (dB).

3.When the peak results are less than average limit, so not need to evaluate the average.



Standard:	FCC Part 15.407	Test Distance:	3m
Test item:	Band edge		
Frequency:	5210MHz		
Mode:	Mode 5		
Ant.Polar.:	Vertical		

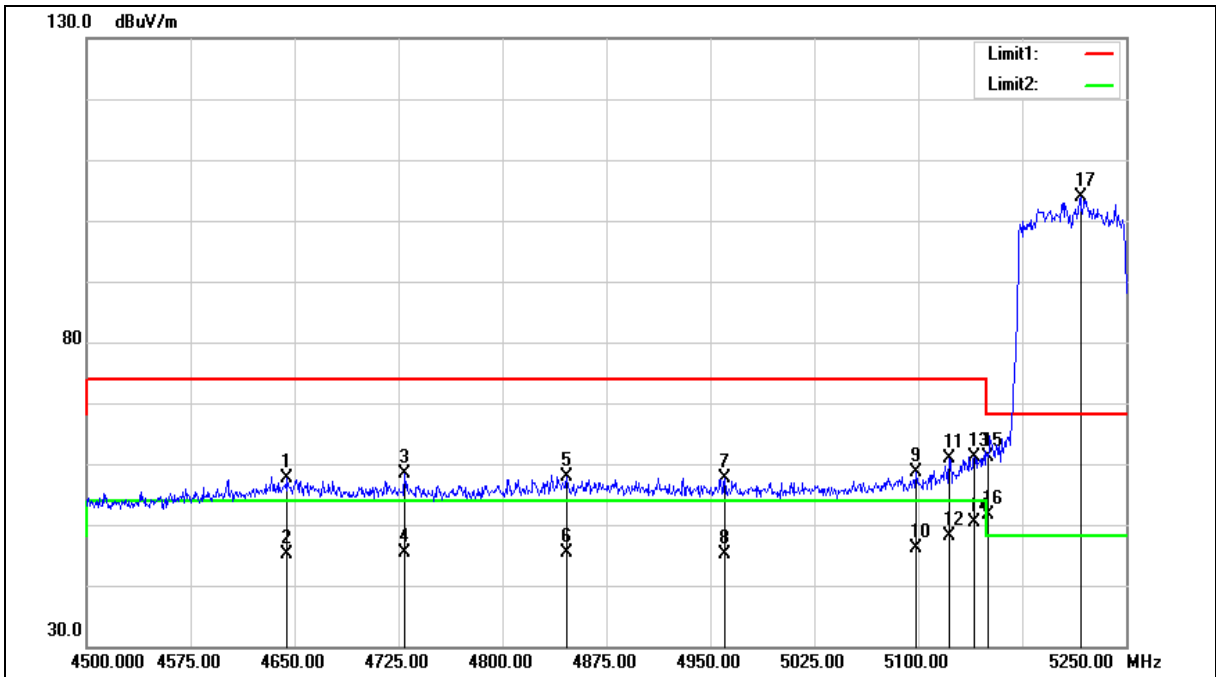



Standard:	FCC Part 15.407	Test Distance:	3m
Test item:	Band edge		
Frequency:	5210MHz		
Mode:	Mode 5		
Ant.Polar.:	Vertical		

No.	Frequency (MHz)	Reading (dBuV)	Correct Factor (dB/m)	Result (dBuV/m)	Limit (dBuV/m)	Margin (dB)	Remark
1	4644.750	52.16	5.42	57.58	74.00	-16.42	peak
2	4644.750	39.65	5.42	45.07	54.00	-8.93	AVG
3	4729.500	52.81	5.68	58.49	74.00	-15.51	peak
4	4729.500	39.81	5.68	45.49	54.00	-8.51	AVG
5	4846.500	51.93	6.04	57.97	74.00	-16.03	peak
6	4846.500	39.25	6.04	45.29	54.00	-8.71	AVG
7	4960.500	51.35	6.38	57.73	74.00	-16.27	peak
8	4960.500	38.73	6.38	45.11	54.00	-8.89	AVG
9	5098.500	51.72	6.79	58.51	74.00	-15.49	peak
10	5098.500	39.42	6.79	46.21	54.00	-7.79	AVG
11	5122.500	53.95	6.85	60.80	74.00	-13.20	peak
12	5122.500	41.31	6.85	48.16	54.00	-5.84	AVG
13	5140.500	54.16	6.91	61.07	74.00	-12.93	peak
14	5140.500	43.37	6.91	50.28	54.00	-3.72	AVG
15	5150.000	54.14	6.94	61.08	74.00	-12.92	peak
16	5150.000	44.79	6.94	51.73	54.00	-2.27	AVG
17	5217.000	96.79	7.13	103.92	--	--	peak

Note:1.Result (dBuV/m) = Correct Factor (dB/m) + Reading(dBuV).

2.Correction factor (dB/m) = Antenna Factor (dB/m) + Cable loss (dB) – Pre-Amplifier gain (dB).

3.When the peak results are less than average limit, so not need to evaluate the average.



Standard:	FCC Part 15.407	Test Distance:	3m
Test item:	Band edge		
Frequency:	5775MHz		
Mode:	Mode 5		
Ant.Polar.:	Horizontal		

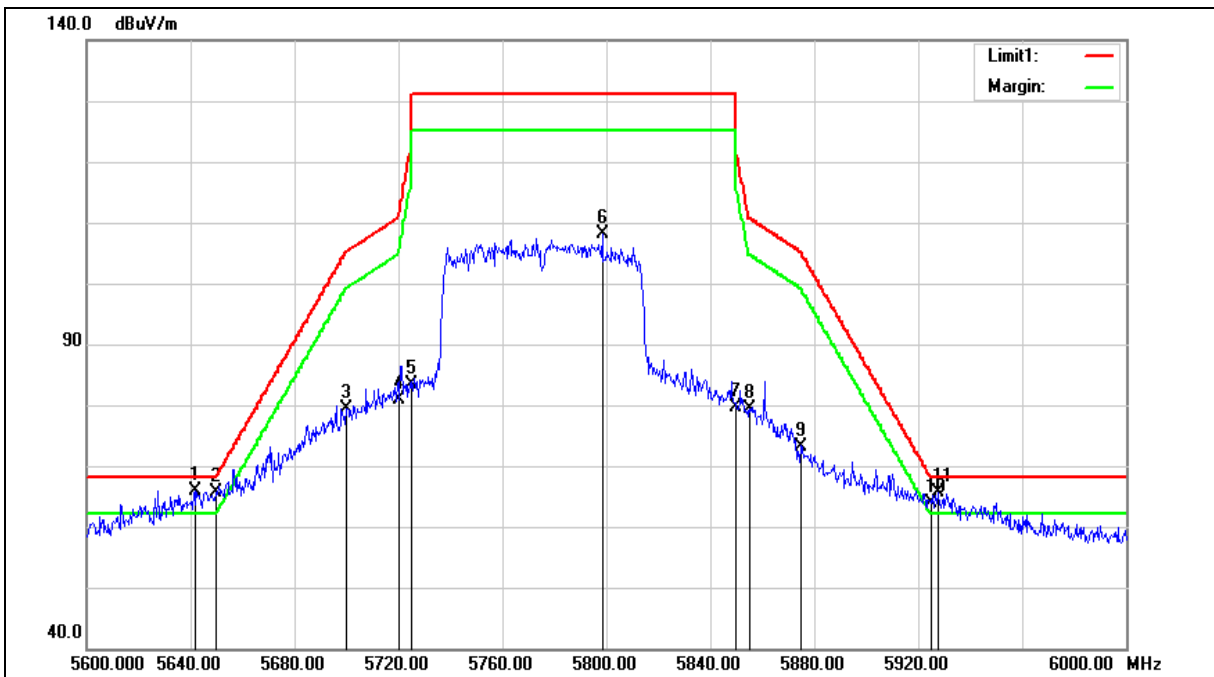



Standard:	FCC Part 15.407	Test Distance:	3m
Test item:	Band edge		
Frequency:	5775MHz		
Mode:	Mode 5		
Ant.Polar.:	Horizontal		

No.	Frequency (MHz)	Reading (dBuV)	Correct Factor (dB/m)	Result (dBuV/m)	Limit (dBuV/m)	Margin (dB)	Remark
1	5641.600	57.67	8.22	65.89	68.20	-2.31	peak
2	5650.000	57.43	8.24	65.67	68.20	-2.53	peak
3	5700.000	70.97	8.34	79.31	105.20	-25.89	peak
4	5720.000	72.61	8.38	80.99	110.80	-29.81	peak
5	5725.000	74.95	8.39	83.34	122.20	-38.86	peak
6	5798.400	99.54	8.53	108.07	--	--	peak
7	5850.000	71.02	8.63	79.65	122.20	-42.55	peak
8	5855.000	70.84	8.64	79.48	110.80	-31.32	peak
9	5875.000	64.51	8.69	73.20	105.20	-32.00	peak
10	5925.000	55.19	8.79	63.98	68.20	-4.22	peak
11	5927.600	56.89	8.80	65.69	68.20	-2.51	peak

Note:1.Result (dBuV/m) = Correct Factor (dB/m) + Reading(dBuV).

2.Correction factor (dB/m) = Antenna Factor (dB/m) + Cable loss (dB) – Pre-Amplifier gain (dB).

3.When the peak results are less than average limit, so not need to evaluate the average.



Standard:	FCC Part 15.407	Test Distance:	3m
Test item:	Band edge		
Frequency:	5775MHz		
Mode:	Mode 5		
Ant.Polar.:	Vertical		

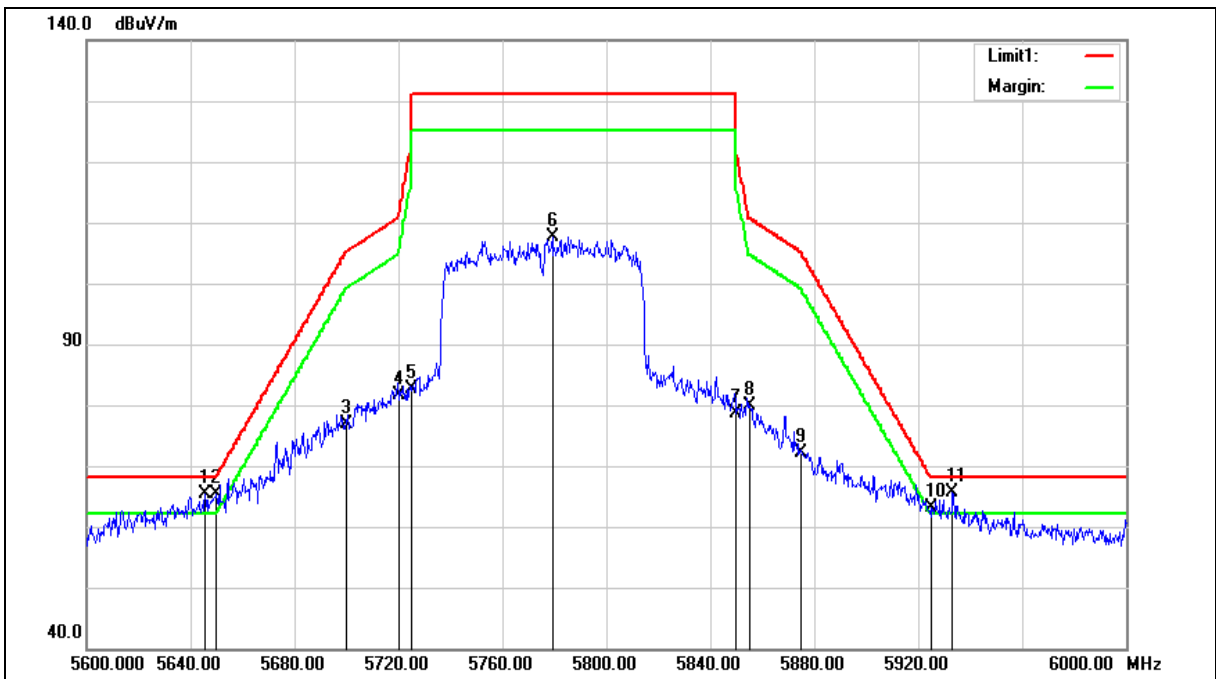



Standard:	FCC Part 15.407	Test Distance:	3m
Test item:	Band edge		
Frequency:	5775MHz		
Mode:	Mode 5		
Ant.Polar.:	Vertical		

No.	Frequency (MHz)	Reading (dBUV)	Correct Factor (dB/m)	Result (dBUV/m)	Limit (dBUV/m)	Margin (dB)	Remark
1	5645.600	57.07	8.23	65.30	68.20	-2.90	peak
2	5650.000	57.05	8.24	65.29	68.20	-2.91	peak
3	5700.000	68.50	8.34	76.84	105.20	-28.36	peak
4	5720.000	73.28	8.38	81.66	110.80	-29.14	peak
5	5725.000	74.31	8.39	82.70	122.20	-39.50	peak
6	5779.200	99.20	8.49	107.69	--	--	peak
7	5850.000	70.04	8.63	78.67	122.20	-43.53	peak
8	5855.000	71.27	8.64	79.91	110.80	-30.89	peak
9	5875.000	63.36	8.69	72.05	105.20	-33.15	peak
10	5925.000	54.39	8.79	63.18	68.20	-5.02	peak
11	5933.200	56.89	8.80	65.69	68.20	-2.51	peak

Note:1.Result (dBUV/m) = Correct Factor (dB/m) + Reading(dBUV).

2.Correction factor (dB/m) = Antenna Factor (dB/m) + Cable loss (dB) – Pre-Amplifier gain (dB).

3.When the peak results are less than average limit, so not need to evaluate the average.



Standard:	FCC Part 15.407	Test Distance:	3m
Test item:	Band edge		
Frequency:	5180MHz		
Mode:	Mode 6		
Ant.Polar.:	Horizontal		

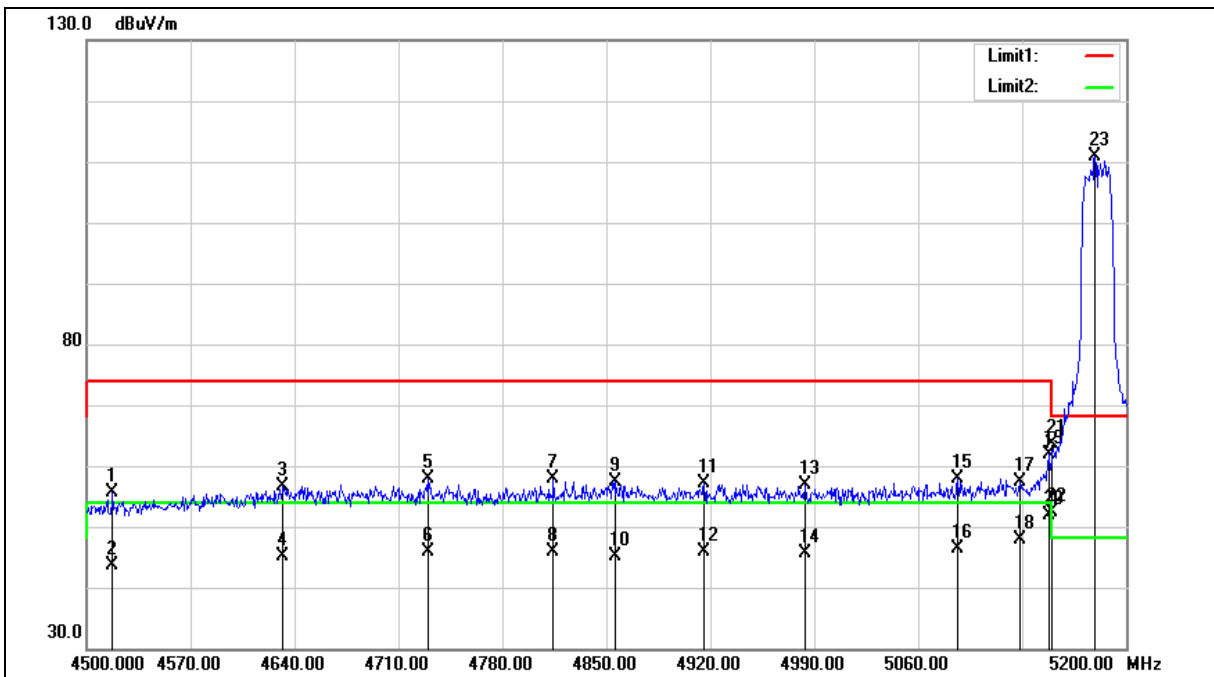



Standard:	FCC Part 15.407	Test Distance:	3m
Test item:	Band edge		
Frequency:	5180MHz		
Mode:	Mode 6		
Ant.Polar.:	Horizontal		

No.	Frequency (MHz)	Reading (dBuV)	Correct Factor (dB/m)	Result (dBuV/m)	Limit (dBuV/m)	Margin (dB)	Remark
1	4517.500	50.69	5.03	55.72	74.00	-18.28	peak
2	4517.500	38.64	5.03	43.67	54.00	-10.33	AVG
3	4632.300	51.34	5.38	56.72	74.00	-17.28	peak
4	4632.300	39.70	5.38	45.08	54.00	-8.92	AVG
5	4729.600	52.28	5.69	57.97	74.00	-16.03	peak
6	4729.600	40.20	5.69	45.89	54.00	-8.11	AVG
7	4814.300	51.86	5.94	57.80	74.00	-16.20	peak
8	4814.300	39.91	5.94	45.85	54.00	-8.15	AVG
9	4856.300	51.39	6.07	57.46	74.00	-16.54	peak
10	4856.300	38.99	6.07	45.06	54.00	-8.94	AVG
11	4915.800	50.78	6.25	57.03	74.00	-16.97	peak
12	4915.800	39.62	6.25	45.87	54.00	-8.13	AVG
13	4983.700	50.52	6.46	56.98	74.00	-17.02	peak
14	4983.700	39.25	6.46	45.71	54.00	-8.29	AVG
15	5086.600	51.14	6.76	57.90	74.00	-16.10	peak
16	5086.600	39.63	6.76	46.39	54.00	-7.61	AVG
17	5128.600	50.51	6.88	57.39	74.00	-16.61	peak
18	5128.600	40.88	6.88	47.76	54.00	-6.24	AVG
19	5148.200	54.92	6.94	61.86	74.00	-12.14	peak
20	5148.200	44.92	6.94	51.86	54.00	-2.14	AVG
21	5150.000	56.58	6.94	63.52	74.00	-10.48	peak
22	5150.000	45.34	6.94	52.28	54.00	-1.72	AVG
23	5179.000	103.98	7.02	111.00	--	--	peak

Note:1.Result (dBuV/m) = Correct Factor (dB/m) + Reading(dBuV).

2.Correction factor (dB/m) = Antenna Factor (dB/m) + Cable loss (dB) – Pre-Amplifier gain (dB).

3.When the peak results are less than average limit, so not need to evaluate the average.



Standard:	FCC Part 15.407	Test Distance:	3m
Test item:	Band edge		
Frequency:	5180MHz		
Mode:	Mode 6		
Ant.Polar.:	Vertical		

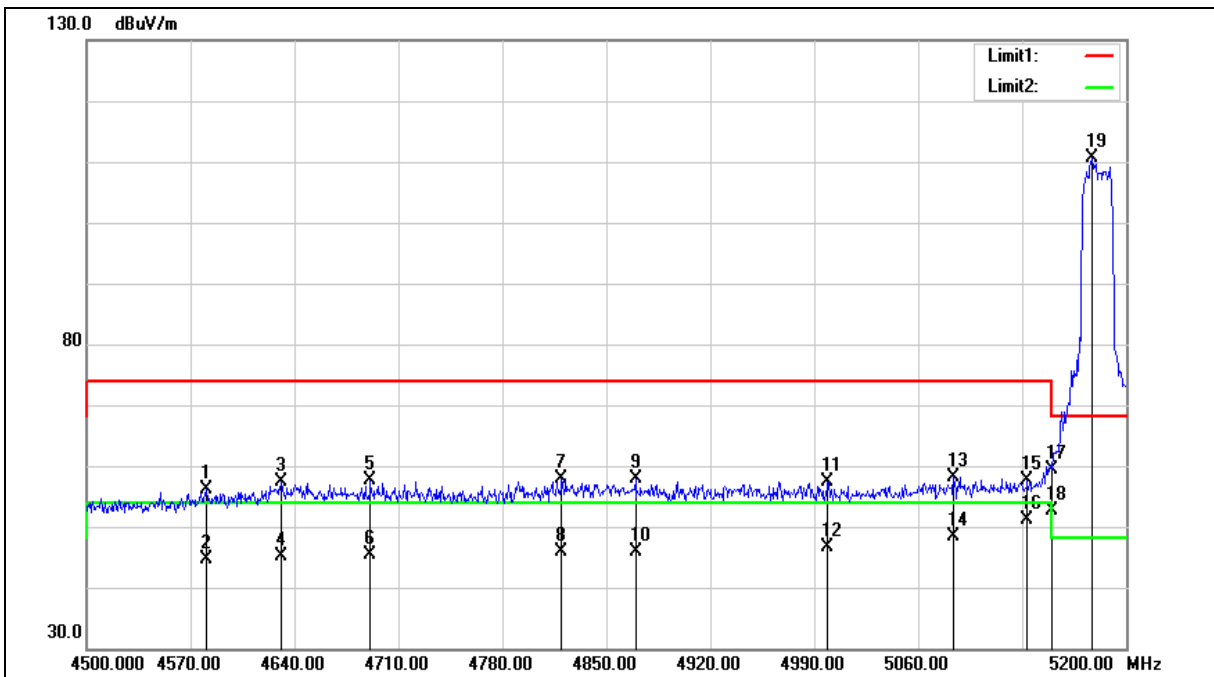



Standard:	FCC Part 15.407	Test Distance:	3m
Test item:	Band edge		
Frequency:	5180MHz		
Mode:	Mode 6		
Ant.Polar.:	Vertical		

No.	Frequency (MHz)	Reading (dBuV)	Correct Factor (dB/m)	Result (dBuV/m)	Limit (dBuV/m)	Margin (dB)	Remark
1	4580.500	50.78	5.23	56.01	74.00	-17.99	peak
2	4580.500	39.47	5.23	44.70	54.00	-9.30	AVG
3	4630.900	51.89	5.38	57.27	74.00	-16.73	peak
4	4630.900	39.80	5.38	45.18	54.00	-8.82	AVG
5	4691.100	52.16	5.56	57.72	74.00	-16.28	peak
6	4691.100	39.84	5.56	45.40	54.00	-8.60	AVG
7	4819.900	51.95	5.95	57.90	74.00	-16.10	peak
8	4819.900	39.92	5.95	45.87	54.00	-8.13	AVG
9	4869.600	51.68	6.11	57.79	74.00	-16.21	peak
10	4869.600	39.79	6.11	45.90	54.00	-8.10	AVG
11	4999.100	50.98	6.51	57.49	74.00	-16.51	peak
12	4999.100	40.02	6.51	46.53	54.00	-7.47	AVG
13	5083.800	51.51	6.74	58.25	74.00	-15.75	peak
14	5083.800	41.54	6.74	48.28	54.00	-5.72	AVG
15	5133.500	50.78	6.89	57.67	74.00	-16.33	peak
16	5133.500	44.17	6.89	51.06	54.00	-2.94	AVG
17	5150.000	52.53	6.94	59.47	74.00	-14.53	peak
18	5150.000	45.64	6.94	52.58	54.00	-1.42	AVG
19	5176.900	103.56	7.02	110.58	--	--	peak

Note:1.Result (dBuV/m) = Correct Factor (dB/m) + Reading(dBuV).

2.Correction factor (dB/m) = Antenna Factor (dB/m) + Cable loss (dB) – Pre-Amplifier gain (dB).

3.When the peak results are less than average limit, so not need to evaluate the average.



Standard:	FCC Part 15.407	Test Distance:	3m
Test item:	Band edge		
Frequency:	5200MHz		
Mode:	Mode 6		
Ant.Polar.:	Horizontal		

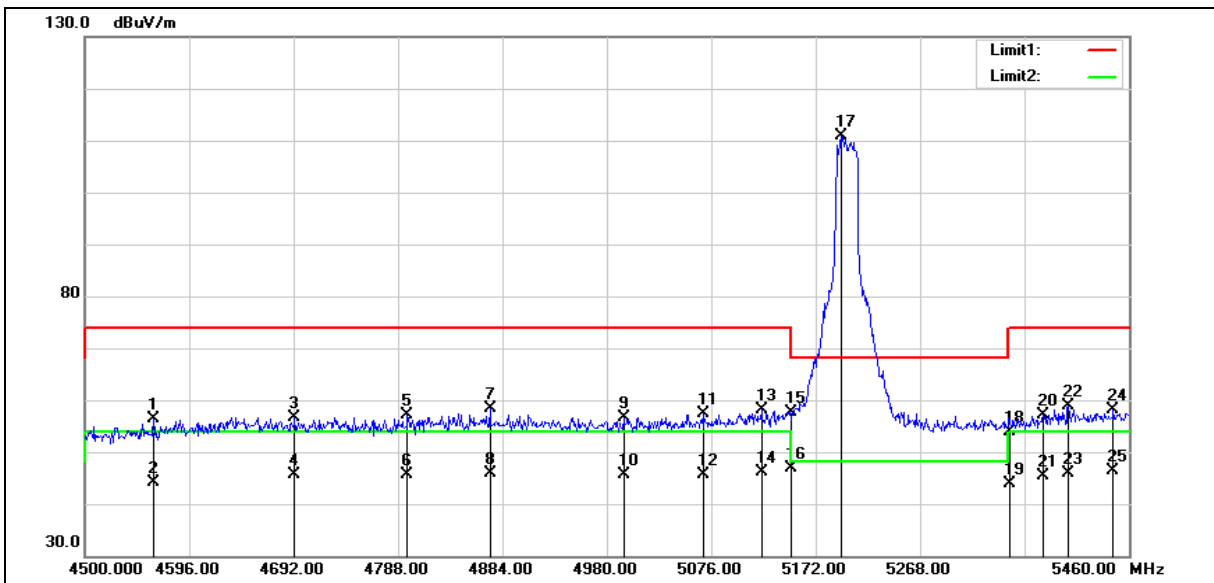

No.	Frequency (MHz)	Reading (dBuV)	Correct Factor (dB/m)	Result (dBuV/m)	Limit (dBuV/m)	Margin (dB)	Remark
1	4563.360	51.15	5.17	56.32	74.00	-17.68	peak
2	4563.360	38.95	5.17	44.12	54.00	-9.88	AVG
3	4692.960	51.18	5.57	56.75	74.00	-17.25	peak
4	4692.960	39.97	5.57	45.54	54.00	-8.46	AVG
5	4796.640	51.19	5.89	57.08	74.00	-16.92	peak

Note:1.Result (dBuV/m) = Correct Factor (dB/m) + Reading(dBuV).

2.Correction factor (dB/m) = Antenna Factor (dB/m) + Cable loss (dB) – Pre-Amplifier gain (dB).

3.When the peak results are less than average limit, so not need to evaluate the average.



Standard:	FCC Part 15.407	Test Distance:	3m
Test item:	Band edge		
Frequency:	5200MHz		
Mode:	Mode 6		
Ant.Polar.:	Horizontal		

No.	Frequency (MHz)	Reading (dBuV)	Correct Factor (dB/m)	Result (dBuV/m)	Limit (dBuV/m)	Margin (dB)	Remark
6	4796.640	39.84	5.89	45.73	54.00	-8.27	AVG
7	4872.480	52.21	6.12	58.33	74.00	-15.67	peak
8	4872.480	39.86	6.12	45.98	54.00	-8.02	AVG
9	4995.360	50.09	6.50	56.59	74.00	-17.41	peak
10	4995.360	39.07	6.50	45.57	54.00	-8.43	AVG
11	5069.280	50.72	6.70	57.42	74.00	-16.58	peak
12	5069.280	38.87	6.70	45.57	54.00	-8.43	AVG
13	5122.080	51.37	6.85	58.22	74.00	-15.78	peak
14	5122.080	39.27	6.85	46.12	54.00	-7.88	AVG
15	5150.000	50.61	6.94	57.55	74.00	-16.45	peak
16	5150.000	39.87	6.94	46.81	54.00	-7.19	AVG
17	5195.040	103.73	7.07	110.80	--	--	peak
18	5350.000	46.35	7.50	53.85	74.00	-20.15	peak
19	5350.000	36.43	7.50	43.93	54.00	-10.07	AVG
20	5381.280	49.41	7.60	57.01	74.00	-16.99	peak
21	5381.280	37.83	7.60	45.43	54.00	-8.57	AVG
22	5404.320	51.32	7.66	58.98	74.00	-15.02	peak
23	5404.320	38.21	7.66	45.87	54.00	-8.13	AVG
24	5445.600	50.36	7.78	58.14	74.00	-15.86	peak
25	5445.600	38.70	7.78	46.48	54.00	-7.52	AVG

Note:1.Result (dBuV/m) = Correct Factor (dB/m) + Reading(dBuV).

2.Correction factor (dB/m) = Antenna Factor (dB/m) + Cable loss (dB) – Pre-Amplifier gain (dB).

3.When the peak results are less than average limit, so not need to evaluate the average.



Standard:	FCC Part 15.407	Test Distance:	3m
Test item:	Band edge		
Frequency:	5200MHz		
Mode:	Mode 6		
Ant.Polar.:	Vertical		

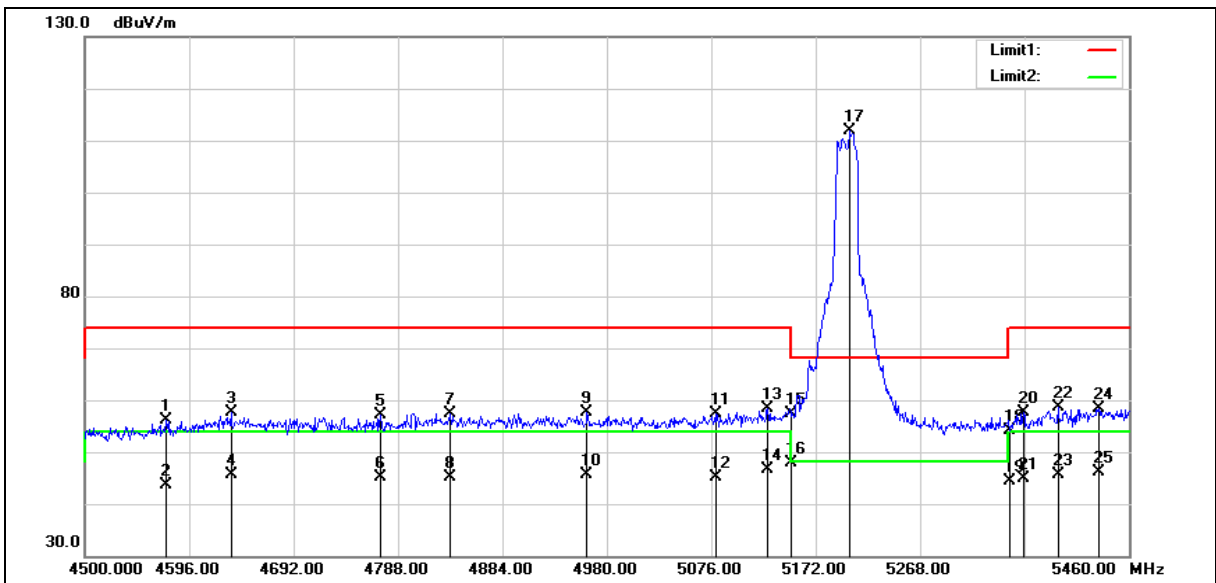

No.	Frequency (MHz)	Reading (dBuV)	Correct Factor (dB/m)	Result (dBuV/m)	Limit (dBuV/m)	Margin (dB)	Remark
1	4574.880	50.84	5.20	56.04	74.00	-17.96	peak
2	4574.880	38.37	5.20	43.57	54.00	-10.43	AVG
3	4634.400	52.21	5.39	57.60	74.00	-16.40	peak
4	4634.400	40.26	5.39	45.65	54.00	-8.35	AVG
5	4771.680	51.36	5.81	57.17	74.00	-16.83	peak

Note:1.Result (dBuV/m) = Correct Factor (dB/m) + Reading(dBuV).

2.Correction factor (dB/m) = Antenna Factor (dB/m) + Cable loss (dB) – Pre-Amplifier gain (dB).

3.When the peak results are less than average limit, so not need to evaluate the average.



Standard:	FCC Part 15.407	Test Distance:	3m
Test item:	Band edge		
Frequency:	5200MHz		
Mode:	Mode 6		
Ant.Polar.:	Vertical		

No.	Frequency (MHz)	Reading (dBuV)	Correct Factor (dB/m)	Result (dBuV/m)	Limit (dBuV/m)	Margin (dB)	Remark
6	4771.680	39.38	5.81	45.19	54.00	-8.81	AVG
7	4836.000	51.36	6.01	57.37	74.00	-16.63	peak
8	4836.000	39.00	6.01	45.01	54.00	-8.99	AVG
9	4961.760	51.16	6.39	57.55	74.00	-16.45	peak
10	4961.760	39.23	6.39	45.62	54.00	-8.38	AVG
11	5079.840	50.73	6.73	57.46	74.00	-16.54	peak
12	5079.840	38.42	6.73	45.15	54.00	-8.85	AVG
13	5127.840	51.58	6.88	58.46	74.00	-15.54	peak
14	5127.840	39.87	6.88	46.75	54.00	-7.25	AVG
15	5150.000	50.54	6.94	57.48	74.00	-16.52	peak
16	5150.000	40.95	6.94	47.89	54.00	-6.11	AVG
17	5202.720	104.68	7.08	111.76	--	--	peak
18	5350.000	46.74	7.50	54.24	74.00	-19.76	peak
19	5350.000	36.86	7.50	44.36	54.00	-9.64	AVG
20	5363.040	50.16	7.53	57.69	74.00	-16.31	peak
21	5363.040	37.40	7.53	44.93	54.00	-9.07	AVG
22	5394.720	51.05	7.63	58.68	74.00	-15.32	peak
23	5394.720	38.00	7.63	45.63	54.00	-8.37	AVG
24	5432.160	50.58	7.74	58.32	74.00	-15.68	peak
25	5432.160	38.45	7.74	46.19	54.00	-7.81	AVG

Note:1.Result (dBuV/m) = Correct Factor (dB/m) + Reading(dBuV).

2.Correction factor (dB/m) = Antenna Factor (dB/m) + Cable loss (dB) – Pre-Amplifier gain (dB).

3.When the peak results are less than average limit, so not need to evaluate the average.



Standard:	FCC Part 15.407	Test Distance:	3m
Test item:	Band edge		
Frequency:	5240MHz		
Mode:	Mode 6		
Ant.Polar.:	Horizontal		

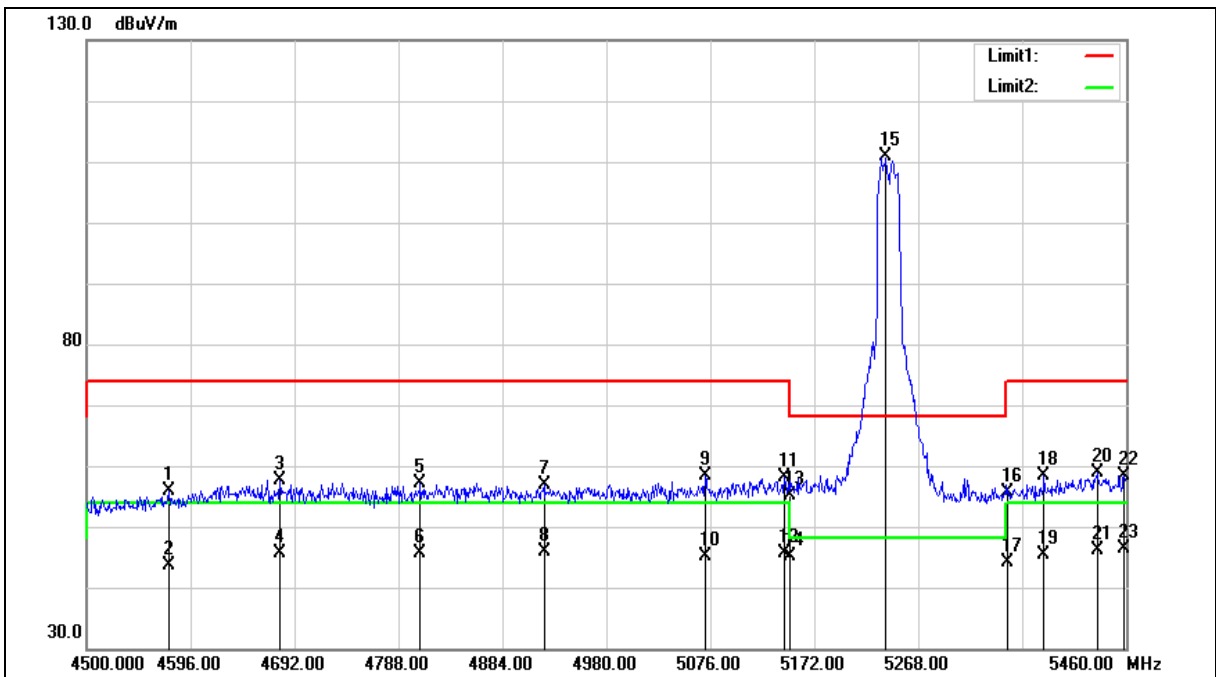



Standard:	FCC Part 15.407	Test Distance:	3m
Test item:	Band edge		
Frequency:	5240MHz		
Mode:	Mode 6		
Ant.Polar.:	Horizontal		

No.	Frequency (MHz)	Reading (dBUV)	Correct Factor (dB/m)	Result (dBUV/m)	Limit (dBUV/m)	Margin (dB)	Remark
1	4575.840	50.64	5.21	55.85	74.00	-18.15	peak
2	4575.840	38.30	5.21	43.51	54.00	-10.49	AVG
3	4678.560	52.18	5.52	57.70	74.00	-16.30	peak
4	4678.560	40.18	5.52	45.70	54.00	-8.30	AVG
5	4808.160	51.16	5.93	57.09	74.00	-16.91	peak
6	4808.160	39.67	5.93	45.60	54.00	-8.40	AVG
7	4922.400	50.52	6.28	56.80	74.00	-17.20	peak
8	4922.400	39.55	6.28	45.83	54.00	-8.17	AVG
9	5071.200	51.76	6.71	58.47	74.00	-15.53	peak
10	5071.200	38.38	6.71	45.09	54.00	-8.91	AVG
11	5144.160	51.22	6.92	58.14	74.00	-15.86	peak
12	5144.160	38.82	6.92	45.74	54.00	-8.26	AVG
13	5150.000	48.17	6.94	55.11	74.00	-18.89	peak
14	5150.000	38.30	6.94	45.24	54.00	-8.76	AVG
15	5238.240	103.76	7.19	110.95	--	--	peak
16	5350.000	48.13	7.50	55.63	74.00	-18.37	peak
17	5350.000	36.58	7.50	44.08	54.00	-9.92	AVG
18	5384.160	50.72	7.60	58.32	74.00	-15.68	peak
19	5384.160	37.78	7.60	45.38	54.00	-8.62	AVG
20	5433.120	51.13	7.74	58.87	74.00	-15.13	peak
21	5433.120	38.45	7.74	46.19	54.00	-7.81	AVG
22	5458.080	50.66	7.81	58.47	74.00	-15.53	peak
23	5458.080	38.59	7.81	46.40	54.00	-7.60	AVG

Note:1.Result (dBUV/m) = Correct Factor (dB/m) + Reading(dBUV).

2.Correction factor (dB/m) = Antenna Factor (dB/m) + Cable loss (dB) – Pre-Amplifier gain (dB).

3.When the peak results are less than average limit, so not need to evaluate the average.



Standard:	FCC Part 15.407	Test Distance:	3m
Test item:	Band edge		
Frequency:	5240MHz		
Mode:	Mode 6		
Ant.Polar.:	Vertical		

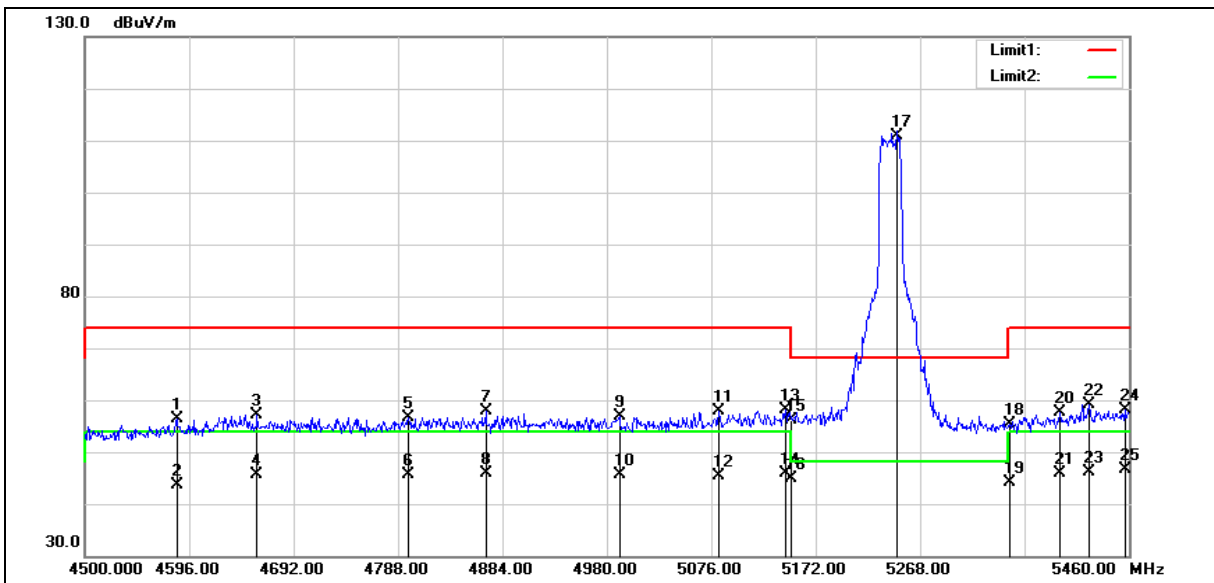

No.	Frequency (MHz)	Reading (dBuV)	Correct Factor (dB/m)	Result (dBuV/m)	Limit (dBuV/m)	Margin (dB)	Remark
1	4584.480	51.24	5.24	56.48	74.00	-17.52	peak
2	4584.480	38.48	5.24	43.72	54.00	-10.28	AVG
3	4658.400	51.75	5.47	57.22	74.00	-16.78	peak
4	4658.400	40.22	5.47	45.69	54.00	-8.31	AVG
5	4797.600	50.66	5.89	56.55	74.00	-17.45	peak

Note:1.Result (dBuV/m) = Correct Factor (dB/m) + Reading(dBuV).

2.Correction factor (dB/m) = Antenna Factor (dB/m) + Cable loss (dB) – Pre-Amplifier gain (dB).

3.When the peak results are less than average limit, so not need to evaluate the average.



Standard:	FCC Part 15.407	Test Distance:	3m
Test item:	Band edge		
Frequency:	5240MHz		
Mode:	Mode 6		
Ant.Polar.:	Vertical		

No.	Frequency (MHz)	Reading (dBuV)	Correct Factor (dB/m)	Result (dBuV/m)	Limit (dBuV/m)	Margin (dB)	Remark
6	4797.600	39.70	5.89	45.59	54.00	-8.41	AVG
7	4868.640	51.73	6.11	57.84	74.00	-16.16	peak
8	4868.640	39.86	6.11	45.97	54.00	-8.03	AVG
9	4991.520	50.30	6.48	56.78	74.00	-17.22	peak
10	4991.520	39.14	6.48	45.62	54.00	-8.38	AVG
11	5082.720	51.17	6.74	57.91	74.00	-16.09	peak
12	5082.720	38.68	6.74	45.42	54.00	-8.58	AVG
13	5144.160	51.11	6.92	58.03	74.00	-15.97	peak
14	5144.160	38.93	6.92	45.85	54.00	-8.15	AVG
15	5150.000	49.11	6.94	56.05	74.00	-17.95	peak
16	5150.000	38.01	6.94	44.95	54.00	-9.05	AVG
17	5246.880	103.66	7.21	110.87	--	--	peak
18	5350.000	47.82	7.50	55.32	74.00	-18.68	peak
19	5350.000	36.57	7.50	44.07	54.00	-9.93	AVG
20	5396.640	50.01	7.64	57.65	74.00	-16.35	peak
21	5396.640	38.13	7.64	45.77	54.00	-8.23	AVG
22	5423.520	51.53	7.71	59.24	74.00	-14.76	peak
23	5423.520	38.46	7.71	46.17	54.00	-7.83	AVG
24	5456.160	50.26	7.81	58.07	74.00	-15.93	peak
25	5456.160	38.71	7.81	46.52	54.00	-7.48	AVG

Note:1.Result (dBuV/m) = Correct Factor (dB/m) + Reading(dBuV).

2.Correction factor (dB/m) = Antenna Factor (dB/m) + Cable loss (dB) – Pre-Amplifier gain (dB).

3.When the peak results are less than average limit, so not need to evaluate the average.



Standard:	FCC Part 15.407	Test Distance:	3m
Test item:	Band edge		
Frequency:	5745MHz		
Mode:	Mode 6		
Ant.Polar.:	Horizontal		

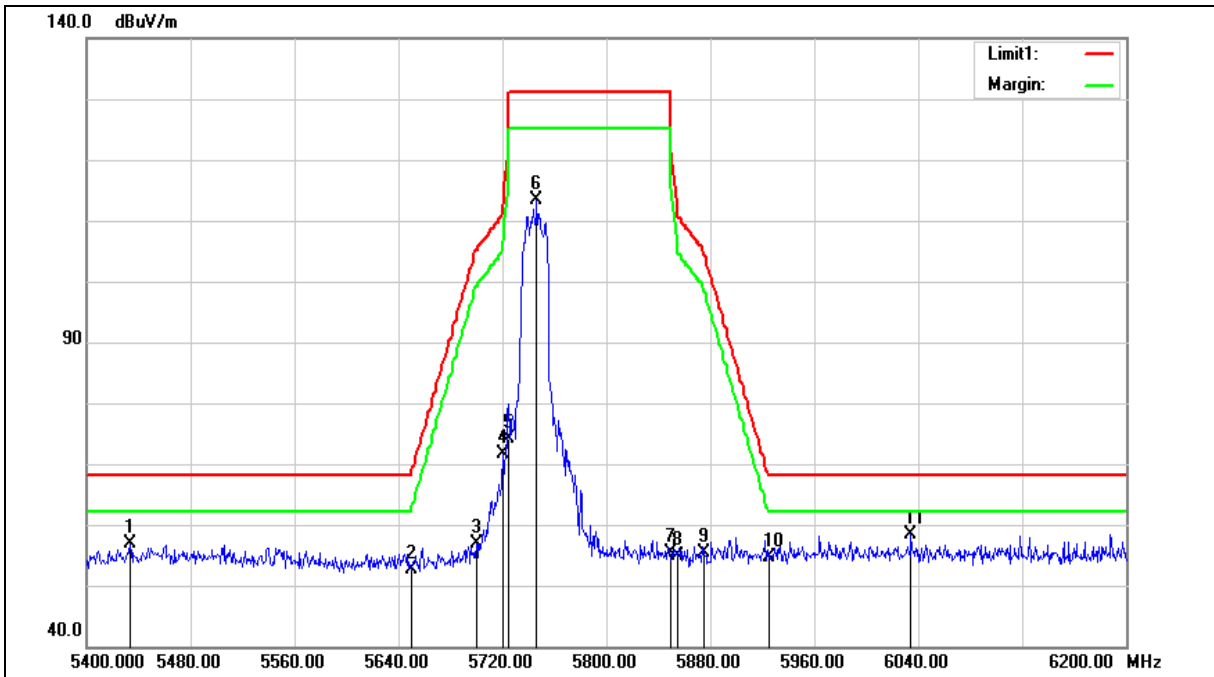



Standard:	FCC Part 15.407	Test Distance:	3m
Test item:	Band edge		
Frequency:	5745MHz		
Mode:	Mode 6		
Ant.Polar.:	Horizontal		

No.	Frequency (MHz)	Reading (dBuV)	Correct Factor (dB/m)	Result (dBuV/m)	Limit (dBuV/m)	Margin (dB)	Remark
1	5433.600	51.08	5.86	56.94	68.20	-11.26	peak
2	5650.000	46.30	6.31	52.61	68.20	-15.59	peak
3	5700.000	50.36	6.40	56.76	105.20	-48.44	peak
4	5720.000	65.12	6.44	71.56	110.80	-39.24	peak
5	5725.000	67.61	6.45	74.06	122.20	-48.14	peak
6	5746.400	106.91	6.48	113.39	--	--	peak
7	5850.000	48.77	6.67	55.44	122.20	-66.76	peak
8	5855.000	48.28	6.67	54.95	110.80	-55.85	peak
9	5875.000	48.73	6.72	55.45	105.20	-49.75	peak
10	5925.000	47.74	6.80	54.54	68.20	-13.66	peak
11	6034.400	51.32	7.04	58.36	68.20	-9.84	peak

Note:1.Result (dBuV/m) = Correct Factor (dB/m) + Reading(dBuV).

2.Correction factor (dB/m) = Antenna Factor (dB/m) + Cable loss (dB) – Pre-Amplifier gain (dB).

3.When the peak results are less than average limit, so not need to evaluate the average.



Standard:	FCC Part 15.407	Test Distance:	3m
Test item:	Band edge		
Frequency:	5745MHz		
Mode:	Mode 6		
Ant.Polar.:	Vertical		

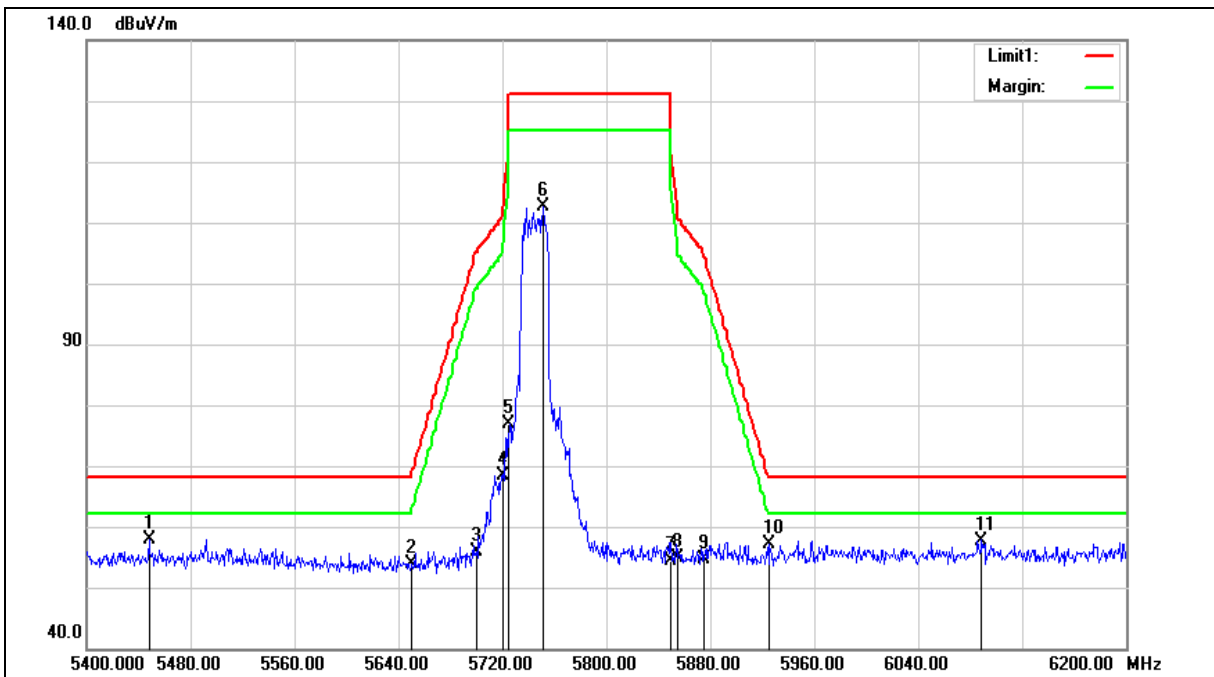



Standard:	FCC Part 15.407	Test Distance:	3m
Test item:	Band edge		
Frequency:	5745MHz		
Mode:	Mode 6		
Ant.Polar.:	Vertical		

No.	Frequency (MHz)	Reading (dBuV)	Correct Factor (dB/m)	Result (dBuV/m)	Limit (dBuV/m)	Margin (dB)	Remark
1	5448.000	52.02	5.90	57.92	68.20	-10.28	peak
2	5650.000	47.69	6.31	54.00	68.20	-14.20	peak
3	5700.000	49.37	6.40	55.77	105.20	-49.43	peak
4	5720.000	61.83	6.44	68.27	110.80	-42.53	peak
5	5725.000	70.47	6.45	76.92	122.20	-45.28	peak
6	5751.200	106.10	6.49	112.59	--	--	peak
7	5850.000	47.68	6.67	54.35	122.20	-67.85	peak
8	5855.000	48.19	6.67	54.86	110.80	-55.94	peak
9	5875.000	47.89	6.72	54.61	105.20	-50.59	peak
10	5925.000	50.25	6.80	57.05	68.20	-11.15	peak
11	6088.800	50.55	7.20	57.75	68.20	-10.45	peak

Note:1.Result (dBuV/m) = Correct Factor (dB/m) + Reading(dBuV).

2.Correction factor (dB/m) = Antenna Factor (dB/m) + Cable loss (dB) – Pre-Amplifier gain (dB).

3.When the peak results are less than average limit, so not need to evaluate the average.



Standard:	FCC Part 15.407	Test Distance:	3m
Test item:	Band edge		
Frequency:	5785MHz		
Mode:	Mode 6		
Ant.Polar.:	Horizontal		

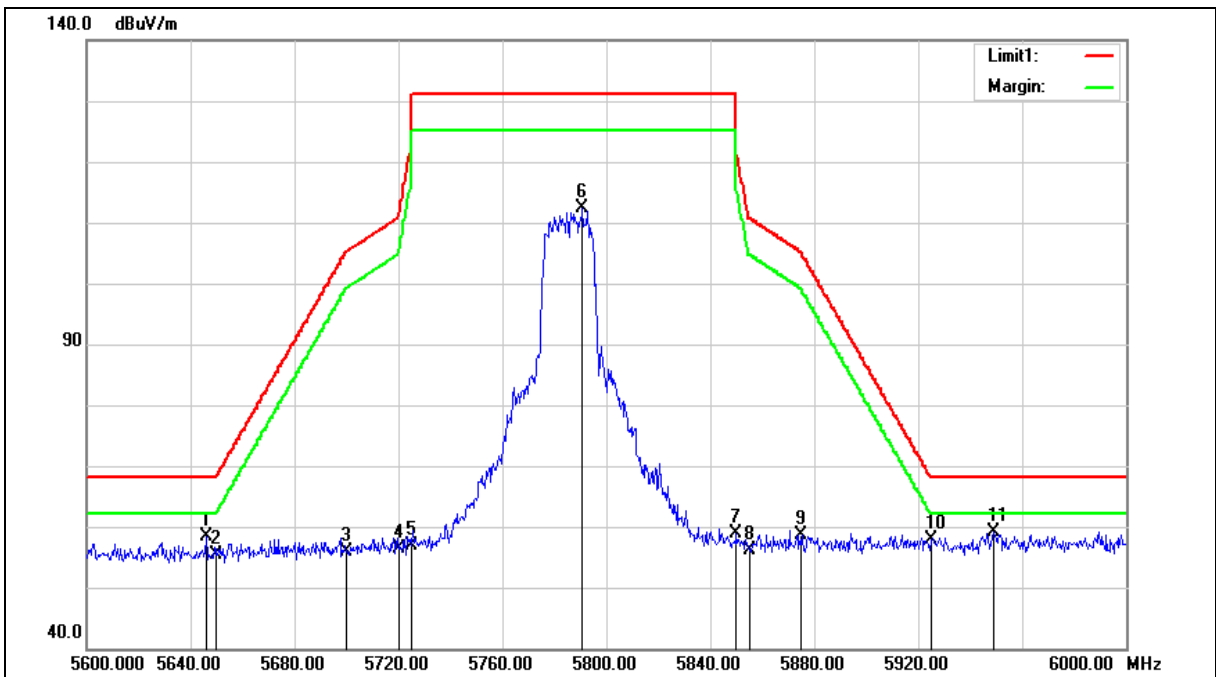



Standard:	FCC Part 15.407	Test Distance:	3m
Test item:	Band edge		
Frequency:	5785MHz		
Mode:	Mode 6		
Ant.Polar.:	Horizontal		

No.	Frequency (MHz)	Reading (dBuV)	Correct Factor (dB/m)	Result (dBuV/m)	Limit (dBuV/m)	Margin (dB)	Remark
1	5646.000	50.11	8.23	58.34	68.20	-9.86	peak
2	5650.000	47.06	8.24	55.30	68.20	-12.90	peak
3	5700.000	47.50	8.34	55.84	105.20	-49.36	peak
4	5720.000	48.03	8.38	56.41	110.80	-54.39	peak
5	5725.000	48.48	8.39	56.87	122.20	-65.33	peak
6	5790.800	103.82	8.51	112.33	--	--	peak
7	5850.000	50.31	8.63	58.94	122.20	-63.26	peak
8	5855.000	47.53	8.64	56.17	110.80	-54.63	peak
9	5875.000	49.82	8.69	58.51	105.20	-46.69	peak
10	5925.000	49.19	8.79	57.98	68.20	-10.22	peak
11	5948.800	50.24	8.84	59.08	68.20	-9.12	peak

Note:1.Result (dBuV/m) = Correct Factor (dB/m) + Reading(dBuV).

2.Correction factor (dB/m) = Antenna Factor (dB/m) + Cable loss (dB) – Pre-Amplifier gain (dB).

3.When the peak results are less than average limit, so not need to evaluate the average.



Standard:	FCC Part 15.407	Test Distance:	3m
Test item:	Band edge		
Frequency:	5785MHz		
Mode:	Mode 6		
Ant.Polar.:	Vertical		

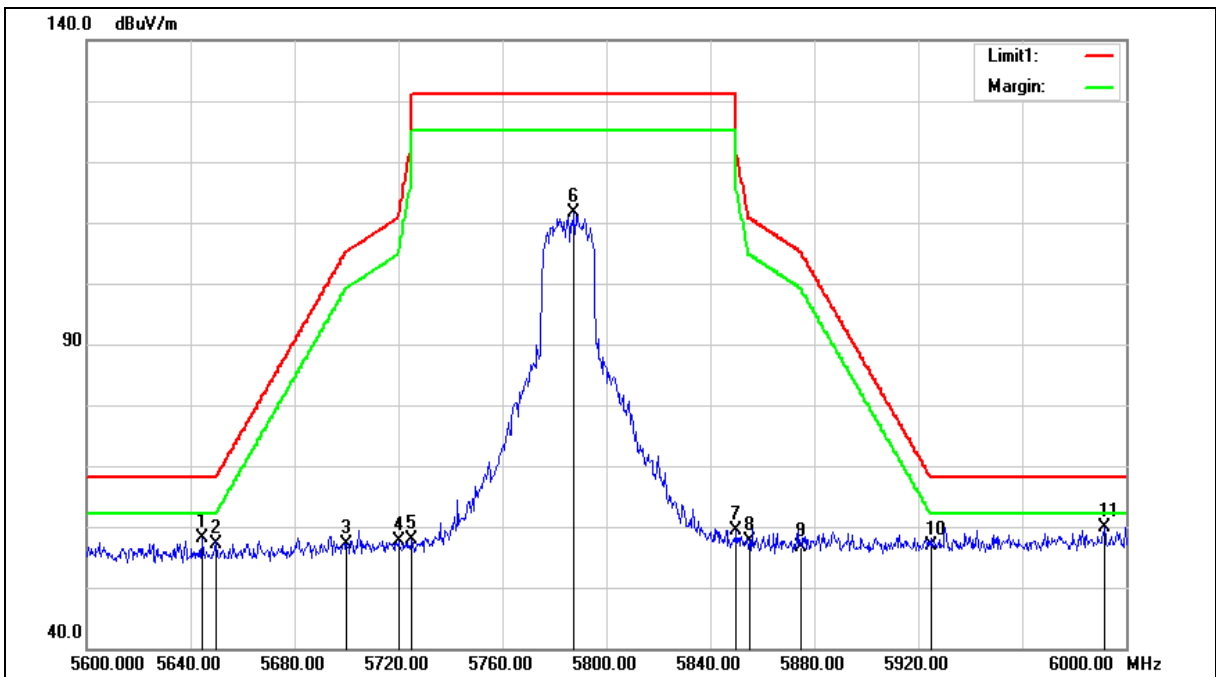



Standard:	FCC Part 15.407	Test Distance:	3m
Test item:	Band edge		
Frequency:	5785MHz		
Mode:	Mode 6		
Ant.Polar.:	Vertical		

No.	Frequency (MHz)	Reading (dBUV)	Correct Factor (dB/m)	Result (dBUV/m)	Limit (dBUV/m)	Margin (dB)	Remark
1	5644.400	49.89	8.22	58.11	68.20	-10.09	peak
2	5650.000	48.90	8.24	57.14	68.20	-11.06	peak
3	5700.000	48.88	8.34	57.22	105.20	-47.98	peak
4	5720.000	49.37	8.38	57.75	110.80	-53.05	peak
5	5725.000	49.41	8.39	57.80	122.20	-64.40	peak
6	5787.600	103.01	8.51	111.52	--	--	peak
7	5850.000	50.74	8.63	59.37	122.20	-62.83	peak
8	5855.000	49.07	8.64	57.71	110.80	-53.09	peak
9	5875.000	47.97	8.69	56.66	105.20	-48.54	peak
10	5925.000	48.05	8.79	56.84	68.20	-11.36	peak
11	5991.600	51.03	8.92	59.95	68.20	-8.25	peak

Note:1.Result (dBUV/m) = Correct Factor (dB/m) + Reading(dBUV).

2.Correction factor (dB/m) = Antenna Factor (dB/m) + Cable loss (dB) – Pre-Amplifier gain (dB).

3.When the peak results are less than average limit, so not need to evaluate the average.



Standard:	FCC Part 15.407	Test Distance:	3m
Test item:	Band edge		
Frequency:	5825MHz		
Mode:	Mode 6		
Ant.Polar.:	Horizontal		

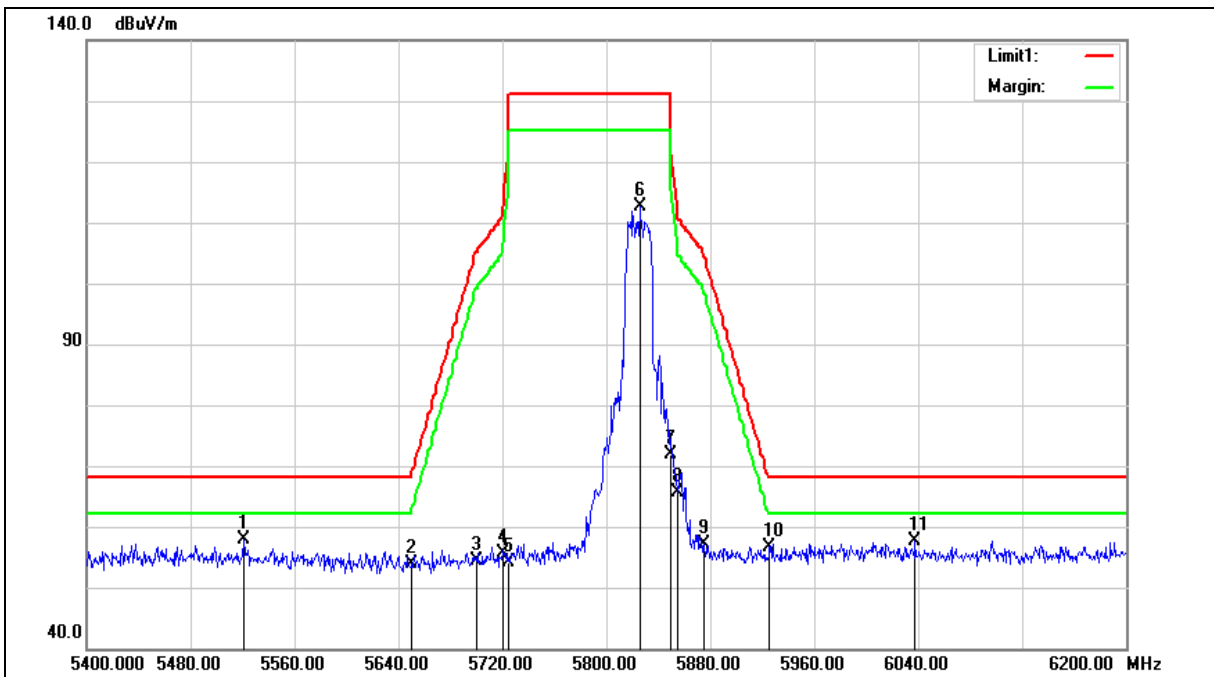



Standard:	FCC Part 15.407	Test Distance:	3m
Test item:	Band edge		
Frequency:	5825MHz		
Mode:	Mode 6		
Ant.Polar.:	Horizontal		

No.	Frequency (MHz)	Reading (dBUV)	Correct Factor (dB/m)	Result (dBUV/m)	Limit (dBUV/m)	Margin (dB)	Remark
1	5520.800	51.72	6.07	57.79	68.20	-10.41	peak
2	5650.000	47.58	6.31	53.89	68.20	-14.31	peak
3	5700.000	47.89	6.40	54.29	105.20	-50.91	peak
4	5720.000	49.14	6.44	55.58	110.80	-55.22	peak
5	5725.000	47.63	6.45	54.08	122.20	-68.12	peak
6	5825.600	106.06	6.63	112.69	--	--	peak
7	5850.000	65.17	6.67	71.84	122.20	-50.36	peak
8	5855.000	58.99	6.67	65.66	110.80	-45.14	peak
9	5875.000	50.42	6.72	57.14	105.20	-48.06	peak
10	5925.000	49.75	6.80	56.55	68.20	-11.65	peak
11	6037.600	50.69	7.05	57.74	68.20	-10.46	peak

Note:1.Result (dBUV/m) = Correct Factor (dB/m) + Reading(dBUV).

2.Correction factor (dB/m) = Antenna Factor (dB/m) + Cable loss (dB) – Pre-Amplifier gain (dB).

3.When the peak results are less than average limit, so not need to evaluate the average.



Standard:	FCC Part 15.407	Test Distance:	3m
Test item:	Band edge		
Frequency:	5825MHz		
Mode:	Mode 6		
Ant.Polar.:	Vertical		

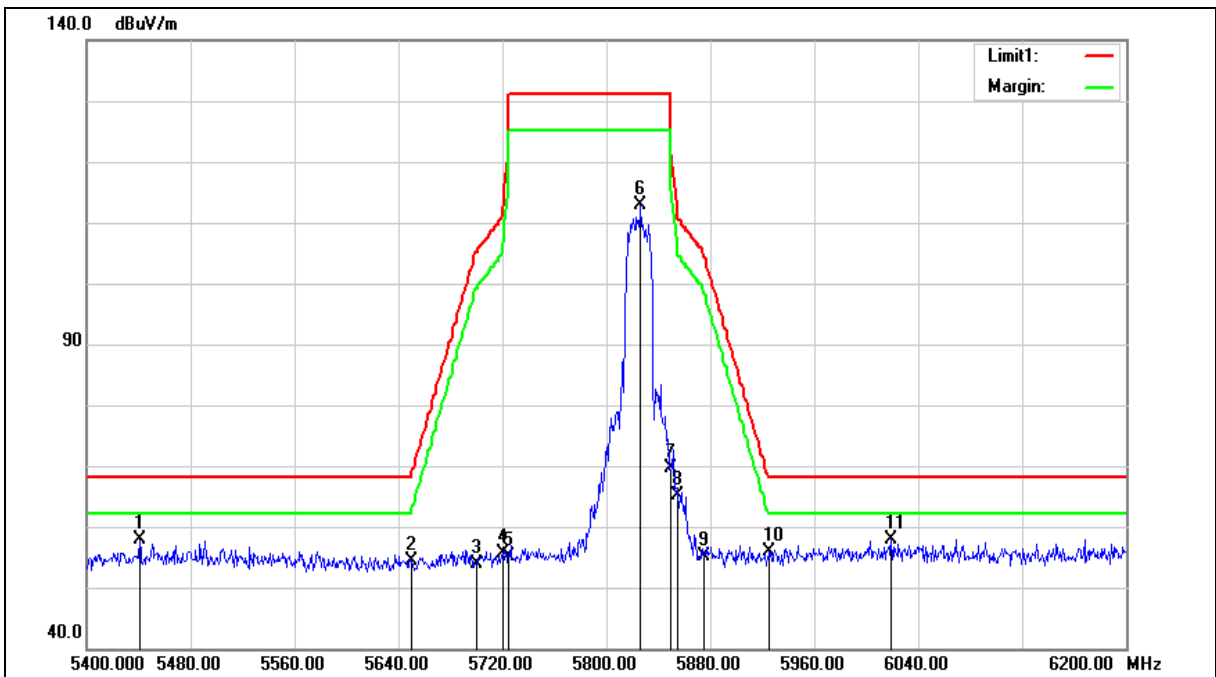



Standard:	FCC Part 15.407	Test Distance:	3m
Test item:	Band edge		
Frequency:	5825MHz		
Mode:	Mode 6		
Ant.Polar.:	Vertical		

No.	Frequency (MHz)	Reading (dBuV)	Correct Factor (dB/m)	Result (dBuV/m)	Limit (dBuV/m)	Margin (dB)	Remark
1	5440.800	52.04	5.88	57.92	68.20	-10.28	peak
2	5650.000	48.02	6.31	54.33	68.20	-13.87	peak
3	5700.000	47.57	6.40	53.97	105.20	-51.23	peak
4	5720.000	49.23	6.44	55.67	110.80	-55.13	peak
5	5725.000	48.77	6.45	55.22	122.20	-66.98	peak
6	5826.400	106.28	6.63	112.91	--	--	peak
7	5850.000	62.88	6.67	69.55	122.20	-52.65	peak
8	5855.000	58.58	6.67	65.25	110.80	-45.55	peak
9	5875.000	48.44	6.72	55.16	105.20	-50.04	peak
10	5925.000	48.99	6.80	55.79	68.20	-12.41	peak
11	6019.200	50.99	7.00	57.99	68.20	-10.21	peak

Note:1.Result (dBuV/m) = Correct Factor (dB/m) + Reading(dBuV).

2.Correction factor (dB/m) = Antenna Factor (dB/m) + Cable loss (dB) – Pre-Amplifier gain (dB).

3.When the peak results are less than average limit, so not need to evaluate the average.



Standard:	FCC Part 15.407	Test Distance:	3m
Test item:	Band edge		
Frequency:	5190MHz		
Mode:	Mode 7		
Ant.Polar.:	Horizontal		

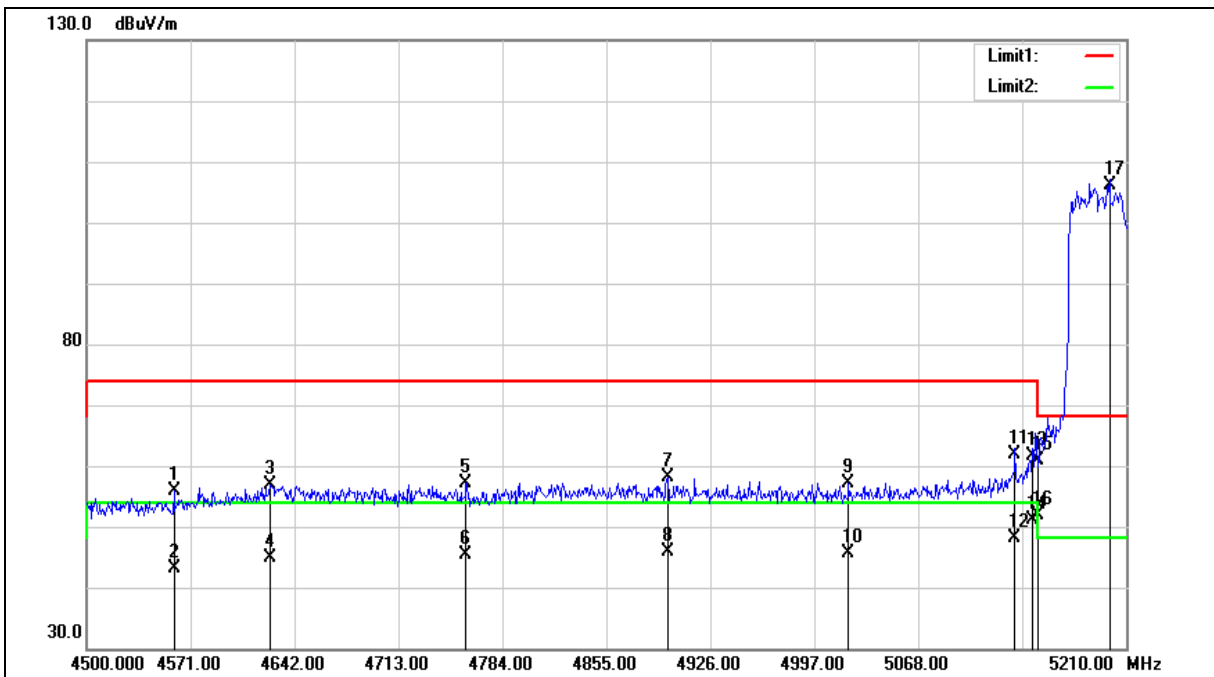



Standard:	FCC Part 15.407	Test Distance:	3m
Test item:	Band edge		
Frequency:	5190MHz		
Mode:	Mode 7		
Ant.Polar.:	Horizontal		

No.	Frequency (MHz)	Reading (dBuV)	Correct Factor (dB/m)	Result (dBuV/m)	Limit (dBuV/m)	Margin (dB)	Remark
1	4559.640	50.72	5.16	55.88	74.00	-18.12	peak
2	4559.640	37.87	5.16	43.03	54.00	-10.97	AVG
3	4625.670	51.40	5.37	56.77	74.00	-17.23	peak
4	4625.670	39.44	5.37	44.81	54.00	-9.19	AVG
5	4759.150	51.38	5.77	57.15	74.00	-16.85	peak
6	4759.150	39.55	5.77	45.32	54.00	-8.68	AVG
7	4896.890	52.00	6.19	58.19	74.00	-15.81	peak
8	4896.890	39.79	6.19	45.98	54.00	-8.02	AVG
9	5020.430	50.48	6.57	57.05	74.00	-16.95	peak
10	5020.430	39.12	6.57	45.69	54.00	-8.31	AVG
11	5134.030	54.87	6.89	61.76	74.00	-12.24	peak
12	5134.030	41.30	6.89	48.19	54.00	-5.81	AVG
13	5146.100	54.58	6.93	61.51	74.00	-12.49	peak
14	5146.100	44.30	6.93	51.23	54.00	-2.77	AVG
15	5150.000	53.98	6.94	60.92	74.00	-13.08	peak
16	5150.000	45.05	6.94	51.99	54.00	-2.01	AVG
17	5198.640	98.94	7.08	106.02	--	--	peak

Note:1.Result (dBuV/m) = Correct Factor (dB/m) + Reading(dBuV).

2.Correction factor (dB/m) = Antenna Factor (dB/m) + Cable loss (dB) – Pre-Amplifier gain (dB).

3.When the peak results are less than average limit, so not need to evaluate the average.



Standard:	FCC Part 15.407	Test Distance:	3m
Test item:	Band edge		
Frequency:	5190MHz		
Mode:	Mode 7		
Ant.Polar.:	Vertical		

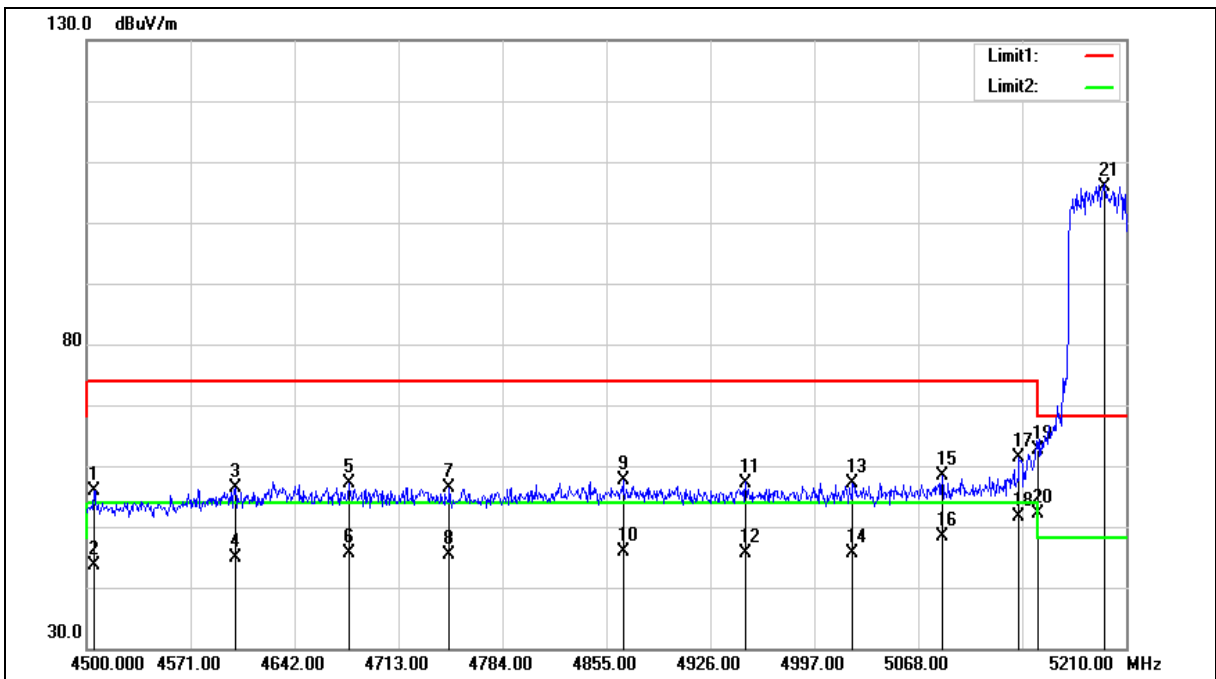



Standard:	FCC Part 15.407	Test Distance:	3m
Test item:	Band edge		
Frequency:	5190MHz		
Mode:	Mode 7		
Ant.Polar.:	Vertical		

No.	Frequency (MHz)	Reading (dBuV)	Correct Factor (dB/m)	Result (dBuV/m)	Limit (dBuV/m)	Margin (dB)	Remark
1	4504.970	50.88	4.99	55.87	74.00	-18.13	peak
2	4504.970	38.61	4.99	43.60	54.00	-10.40	AVG
3	4601.530	51.18	5.29	56.47	74.00	-17.53	peak
4	4601.530	39.60	5.29	44.89	54.00	-9.11	AVG
5	4678.920	51.59	5.53	57.12	74.00	-16.88	peak
6	4678.920	40.21	5.53	45.74	54.00	-8.26	AVG
7	4747.790	50.58	5.74	56.32	74.00	-17.68	peak
8	4747.790	39.65	5.74	45.39	54.00	-8.61	AVG
9	4866.360	51.54	6.11	57.65	74.00	-16.35	peak
10	4866.360	39.84	6.11	45.95	54.00	-8.05	AVG
11	4950.140	50.89	6.36	57.25	74.00	-16.75	peak
12	4950.140	39.38	6.36	45.74	54.00	-8.26	AVG
13	5023.270	50.66	6.57	57.23	74.00	-16.77	peak
14	5023.270	39.05	6.57	45.62	54.00	-8.38	AVG
15	5084.330	51.57	6.74	58.31	74.00	-15.69	peak
16	5084.330	41.52	6.74	48.26	54.00	-5.74	AVG
17	5136.870	54.43	6.91	61.34	74.00	-12.66	peak
18	5136.870	44.83	6.91	51.74	54.00	-2.26	AVG
19	5150.000	55.65	6.94	62.59	74.00	-11.41	peak
20	5150.000	45.29	6.94	52.23	54.00	-1.77	AVG
21	5195.090	98.82	7.07	105.89	--	--	peak

Note:1.Result (dBuV/m) = Correct Factor (dB/m) + Reading(dBuV).

2.Correction factor (dB/m) = Antenna Factor (dB/m) + Cable loss (dB) – Pre-Amplifier gain (dB).

3.When the peak results are less than average limit, so not need to evaluate the average.



Standard:	FCC Part 15.407	Test Distance:	3m
Test item:	Band edge		
Frequency:	5230MHz		
Mode:	Mode 7		
Ant.Polar.:	Horizontal		

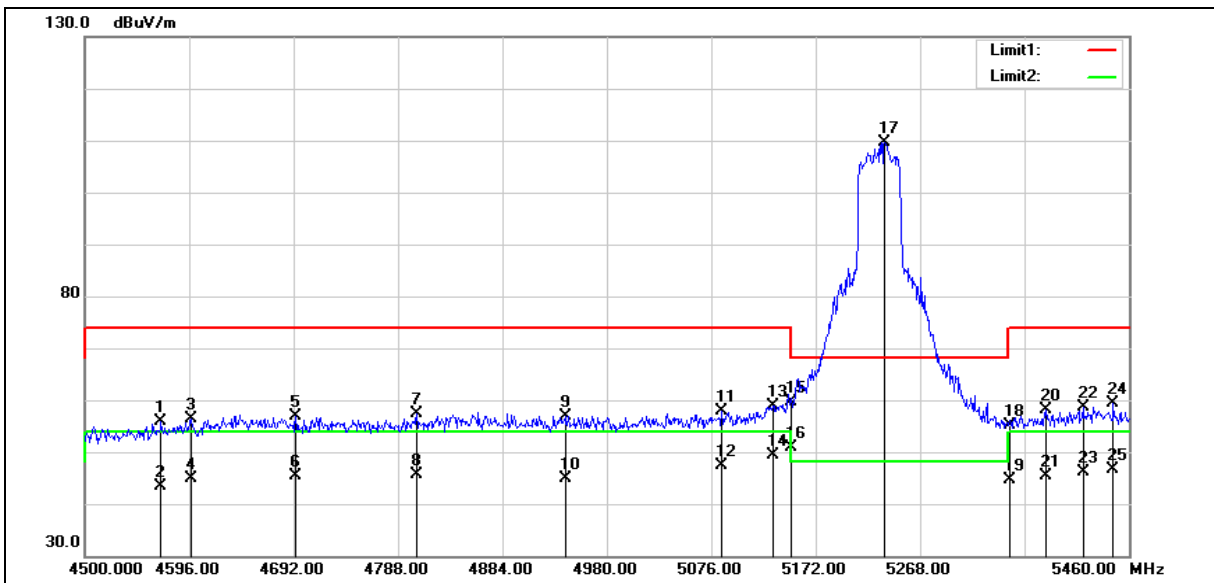

No.	Frequency (MHz)	Reading (dBuV)	Correct Factor (dB/m)	Result (dBuV/m)	Limit (dBuV/m)	Margin (dB)	Remark
1	4570.080	50.66	5.19	55.85	74.00	-18.15	peak
2	4570.080	38.15	5.19	43.34	54.00	-10.66	AVG
3	4597.920	51.10	5.29	56.39	74.00	-17.61	peak
4	4597.920	39.60	5.29	44.89	54.00	-9.11	AVG
5	4693.920	51.25	5.58	56.83	74.00	-17.17	peak

Note:1.Result (dBuV/m) = Correct Factor (dB/m) + Reading(dBuV).

2.Correction factor (dB/m) = Antenna Factor (dB/m) + Cable loss (dB) – Pre-Amplifier gain (dB).

3.When the peak results are less than average limit, so not need to evaluate the average.



Standard:	FCC Part 15.407	Test Distance:	3m
Test item:	Band edge		
Frequency:	5230MHz		
Mode:	Mode 7		
Ant.Polar.:	Horizontal		

No.	Frequency (MHz)	Reading (dBuV)	Correct Factor (dB/m)	Result (dBuV/m)	Limit (dBuV/m)	Margin (dB)	Remark
6	4693.920	39.92	5.58	45.50	54.00	-8.50	AVG
7	4805.280	51.41	5.91	57.32	74.00	-16.68	peak
8	4805.280	39.76	5.91	45.67	54.00	-8.33	AVG
9	4941.600	50.67	6.33	57.00	74.00	-17.00	peak
10	4941.600	38.54	6.33	44.87	54.00	-9.13	AVG
11	5085.600	51.07	6.75	57.82	74.00	-16.18	peak
12	5085.600	40.75	6.75	47.50	54.00	-6.50	AVG
13	5132.640	51.98	6.89	58.87	74.00	-15.13	peak
14	5132.640	42.57	6.89	49.46	54.00	-4.54	AVG
15	5150.000	52.66	6.94	59.60	74.00	-14.40	peak
16	5150.000	43.90	6.94	50.84	54.00	-3.16	AVG
17	5235.360	102.54	7.18	109.72	--	--	peak
18	5350.000	47.59	7.50	55.09	74.00	-18.91	peak
19	5350.000	37.25	7.50	44.75	54.00	-9.25	AVG
20	5384.160	50.65	7.60	58.25	74.00	-15.75	peak
21	5384.160	37.86	7.60	45.46	54.00	-8.54	AVG
22	5417.760	51.00	7.70	58.70	74.00	-15.30	peak
23	5417.760	38.35	7.70	46.05	54.00	-7.95	AVG
24	5445.600	51.55	7.78	59.33	74.00	-14.67	peak
25	5445.600	38.73	7.78	46.51	54.00	-7.49	AVG

Note:1.Result (dBuV/m) = Correct Factor (dB/m) + Reading(dBuV).

2.Correction factor (dB/m) = Antenna Factor (dB/m) + Cable loss (dB) – Pre-Amplifier gain (dB).

3.When the peak results are less than average limit, so not need to evaluate the average.



Standard:	FCC Part 15.407	Test Distance:	3m
Test item:	Band edge		
Frequency:	5230MHz		
Mode:	Mode 7		
Ant.Polar.:	Vertical		

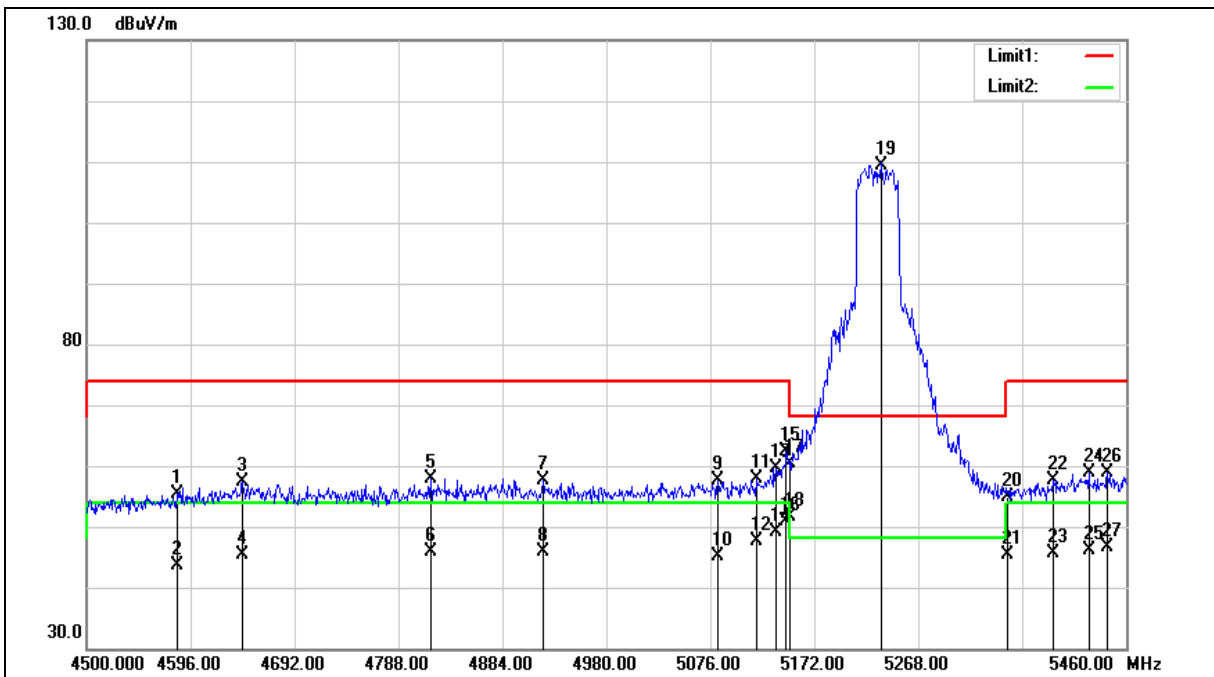

No.	Frequency (MHz)	Reading (dBuV)	Correct Factor (dB/m)	Result (dBuV/m)	Limit (dBuV/m)	Margin (dB)	Remark
1	4583.520	50.18	5.23	55.41	74.00	-18.59	peak
2	4583.520	38.52	5.23	43.75	54.00	-10.25	AVG
3	4644.000	51.94	5.42	57.36	74.00	-16.64	peak
4	4644.000	39.94	5.42	45.36	54.00	-8.64	AVG
5	4817.760	51.92	5.95	57.87	74.00	-16.13	peak

Note:1.Result (dBuV/m) = Correct Factor (dB/m) + Reading(dBuV).

2.Correction factor (dB/m) = Antenna Factor (dB/m) + Cable loss (dB) – Pre-Amplifier gain (dB).

3.When the peak results are less than average limit, so not need to evaluate the average.



Standard:	FCC Part 15.407	Test Distance:	3m
Test item:	Band edge		
Frequency:	5230MHz		
Mode:	Mode 7		
Ant.Polar.:	Vertical		

No.	Frequency (MHz)	Reading (dBuV)	Correct Factor (dB/m)	Result (dBuV/m)	Limit (dBuV/m)	Margin (dB)	Remark
6	4817.760	39.91	5.95	45.86	54.00	-8.14	AVG
7	4921.440	51.40	6.28	57.68	74.00	-16.32	peak
8	4921.440	39.54	6.28	45.82	54.00	-8.18	AVG
9	5082.720	50.78	6.74	57.52	74.00	-16.48	peak
10	5082.720	38.44	6.74	45.18	54.00	-8.82	AVG
11	5118.240	51.15	6.84	57.99	74.00	-16.01	peak
12	5118.240	40.84	6.84	47.68	54.00	-6.32	AVG
13	5136.480	52.72	6.91	59.63	74.00	-14.37	peak
14	5136.480	42.21	6.91	49.12	54.00	-4.88	AVG
15	5146.080	55.43	6.93	62.36	74.00	-11.64	peak
16	5146.080	44.05	6.93	50.98	54.00	-3.02	AVG
17	5150.000	53.44	6.94	60.38	74.00	-13.62	peak
18	5150.000	44.81	6.94	51.75	54.00	-2.25	AVG
19	5233.440	102.24	7.17	109.41	--	--	peak
20	5350.000	47.26	7.50	54.76	74.00	-19.24	peak
21	5350.000	37.82	7.50	45.32	54.00	-8.68	AVG
22	5392.800	50.03	7.63	57.66	74.00	-16.34	peak
23	5392.800	38.02	7.63	45.65	54.00	-8.35	AVG
24	5425.440	51.22	7.73	58.95	74.00	-15.05	peak
25	5425.440	38.46	7.73	46.19	54.00	-7.81	AVG
26	5442.720	51.16	7.77	58.93	74.00	-15.07	peak
27	5442.720	38.74	7.77	46.51	54.00	-7.49	AVG

Note:1.Result (dBuV/m) = Correct Factor (dB/m) + Reading(dBuV).

2.Correction factor (dB/m) = Antenna Factor (dB/m) + Cable loss (dB) – Pre-Amplifier gain (dB).

3.When the peak results are less than average limit, so not need to evaluate the average.



Standard:	FCC Part 15.407	Test Distance:	3m
Test item:	Band edge		
Frequency:	5755MHz		
Mode:	Mode 7		
Ant.Polar.:	Horizontal		

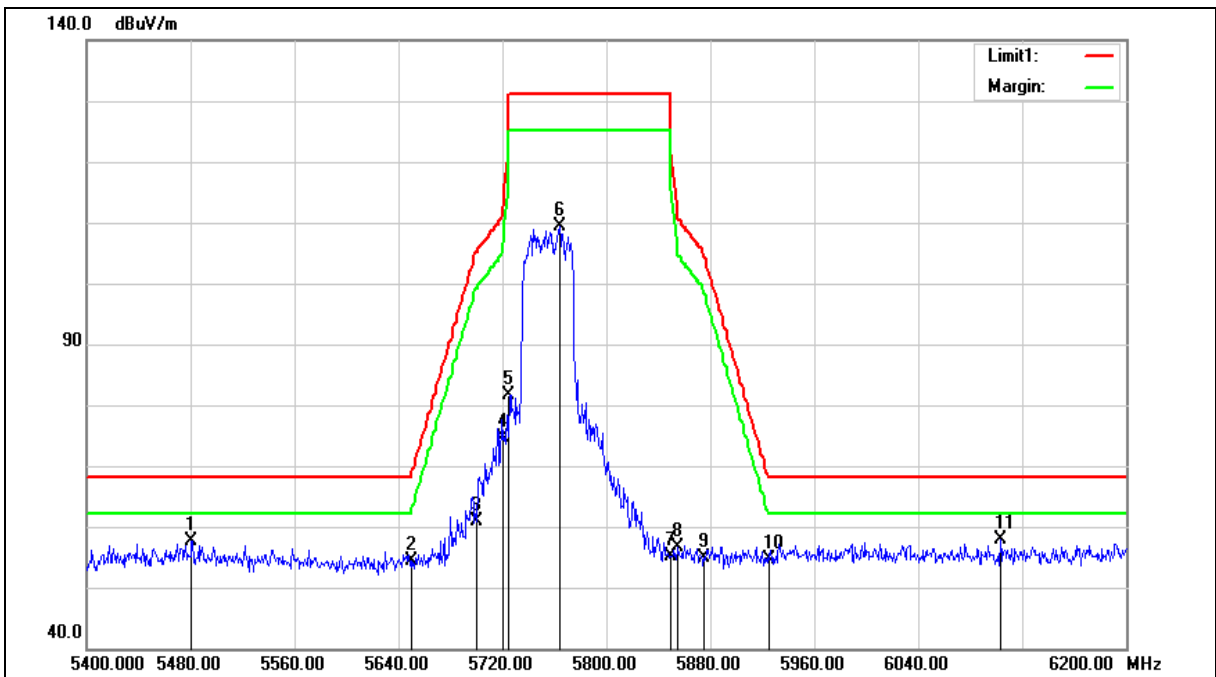



Standard:	FCC Part 15.407	Test Distance:	3m
Test item:	Band edge		
Frequency:	5755MHz		
Mode:	Mode 7		
Ant.Polar.:	Horizontal		

No.	Frequency (MHz)	Reading (dBuV)	Correct Factor (dB/m)	Result (dBuV/m)	Limit (dBuV/m)	Margin (dB)	Remark
1	5480.800	51.62	5.99	57.61	68.20	-10.59	peak
2	5650.000	48.14	6.31	54.45	68.20	-13.75	peak
3	5700.000	54.58	6.40	60.98	105.20	-44.22	peak
4	5720.000	68.13	6.44	74.57	110.80	-36.23	peak
5	5725.000	75.13	6.45	81.58	122.20	-40.62	peak
6	5764.000	102.99	6.51	109.50	--	--	peak
7	5850.000	48.48	6.67	55.15	122.20	-67.05	peak
8	5855.000	49.90	6.67	56.57	110.80	-54.23	peak
9	5875.000	48.22	6.72	54.94	105.20	-50.26	peak
10	5925.000	47.85	6.80	54.65	68.20	-13.55	peak
11	6103.200	50.62	7.25	57.87	68.20	-10.33	peak

Note:1.Result (dBuV/m) = Correct Factor (dB/m) + Reading(dBuV).

2.Correction factor (dB/m) = Antenna Factor (dB/m) + Cable loss (dB) – Pre-Amplifier gain (dB).

3.When the peak results are less than average limit, so not need to evaluate the average.



Standard:	FCC Part 15.407	Test Distance:	3m
Test item:	Band edge		
Frequency:	5755MHz		
Mode:	Mode 7		
Ant.Polar.:	Vertical		

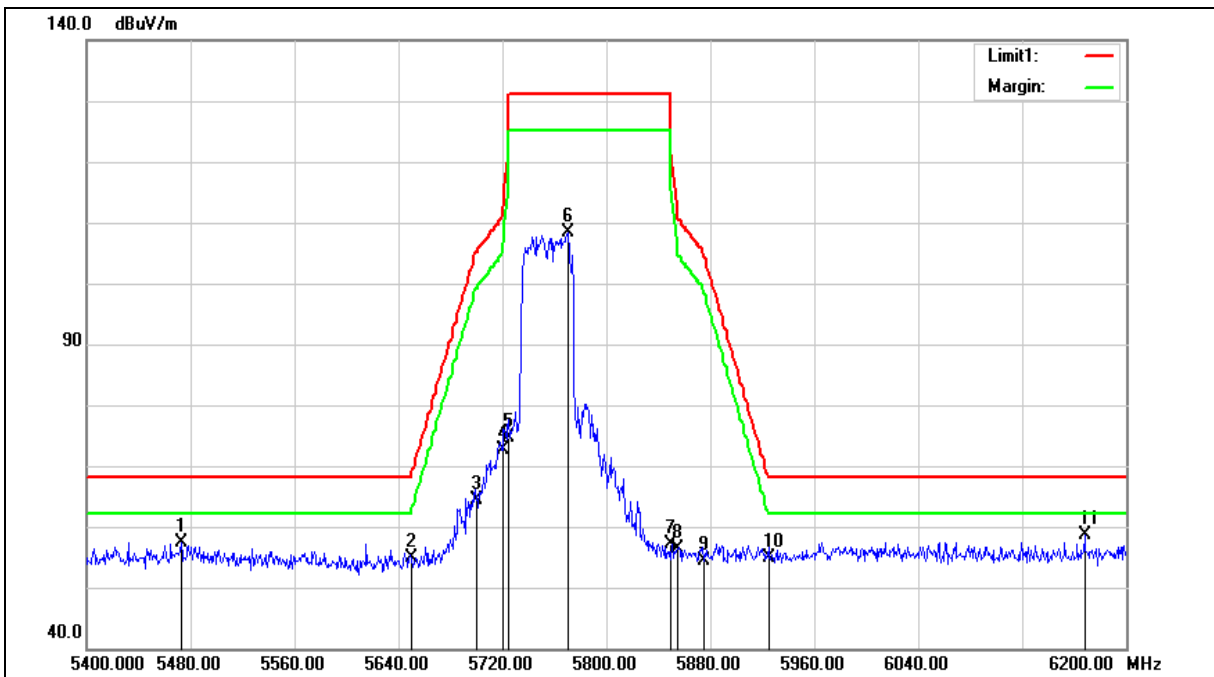



Standard:	FCC Part 15.407	Test Distance:	3m
Test item:	Band edge		
Frequency:	5755MHz		
Mode:	Mode 7		
Ant.Polar.:	Vertical		

No.	Frequency (MHz)	Reading (dBuV)	Correct Factor (dB/m)	Result (dBuV/m)	Limit (dBuV/m)	Margin (dB)	Remark
1	5472.800	51.44	5.96	57.40	68.20	-10.80	peak
2	5650.000	48.67	6.31	54.98	68.20	-13.22	peak
3	5700.000	57.89	6.40	64.29	105.20	-40.91	peak
4	5720.000	66.27	6.44	72.71	110.80	-38.09	peak
5	5725.000	68.18	6.45	74.63	122.20	-47.57	peak
6	5770.400	101.76	6.52	108.28	--	--	peak
7	5850.000	50.51	6.67	57.18	122.20	-65.02	peak
8	5855.000	49.66	6.67	56.33	110.80	-54.47	peak
9	5875.000	47.78	6.72	54.50	105.20	-50.70	peak
10	5925.000	48.11	6.80	54.91	68.20	-13.29	peak
11	6168.000	51.16	7.43	58.59	68.20	-9.61	peak

Note:1.Result (dBuV/m) = Correct Factor (dB/m) + Reading(dBuV).

2.Correction factor (dB/m) = Antenna Factor (dB/m) + Cable loss (dB) – Pre-Amplifier gain (dB).

3.When the peak results are less than average limit, so not need to evaluate the average.



Standard:	FCC Part 15.407	Test Distance:	3m
Test item:	Band edge		
Frequency:	5795MHz		
Mode:	Mode 7		
Ant.Polar.:	Horizontal		

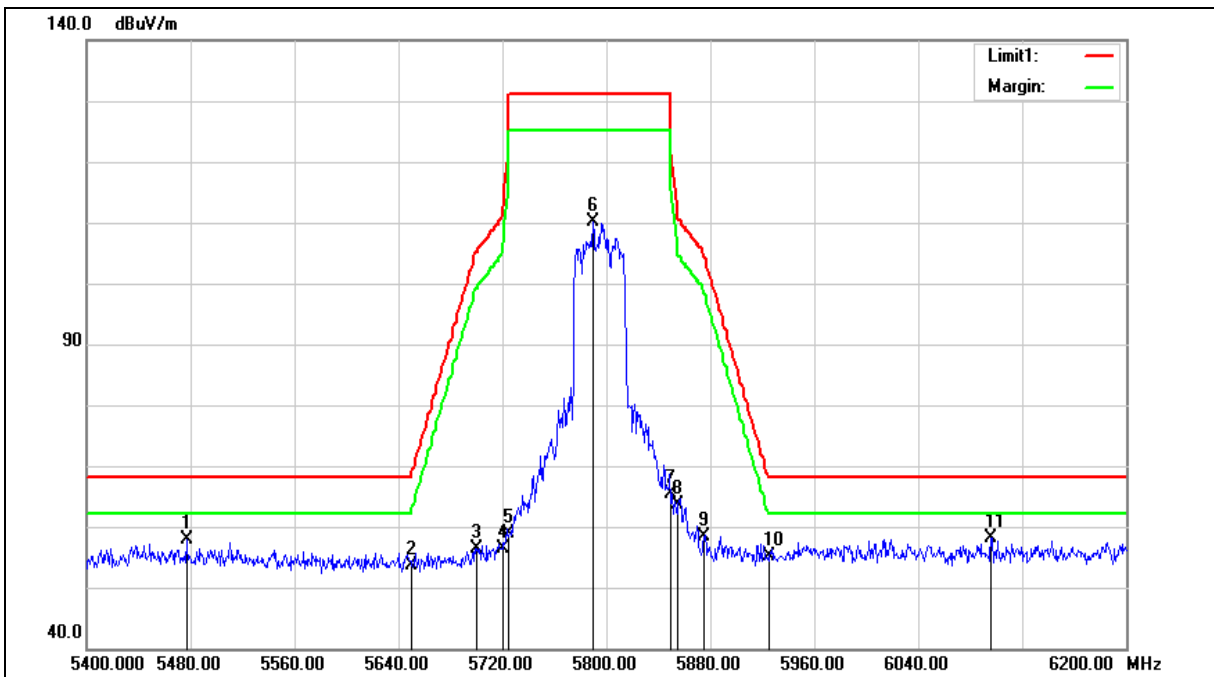



Standard:	FCC Part 15.407	Test Distance:	3m
Test item:	Band edge		
Frequency:	5795MHz		
Mode:	Mode 7		
Ant.Polar.:	Horizontal		

No.	Frequency (MHz)	Reading (dBuV)	Correct Factor (dB/m)	Result (dBuV/m)	Limit (dBuV/m)	Margin (dB)	Remark
1	5476.800	51.97	5.98	57.95	68.20	-10.25	peak
2	5650.000	47.25	6.31	53.56	68.20	-14.64	peak
3	5700.000	50.07	6.40	56.47	105.20	-48.73	peak
4	5720.000	49.91	6.44	56.35	110.80	-54.45	peak
5	5725.000	52.51	6.45	58.96	122.20	-63.24	peak
6	5789.600	103.52	6.56	110.08	--	--	peak
7	5850.000	58.61	6.67	65.28	122.20	-56.92	peak
8	5855.000	56.86	6.67	63.53	110.80	-47.27	peak
9	5875.000	51.72	6.72	58.44	105.20	-46.76	peak
10	5925.000	48.43	6.80	55.23	68.20	-12.97	peak
11	6096.000	50.86	7.23	58.09	68.20	-10.11	peak

Note:1.Result (dBuV/m) = Correct Factor (dB/m) + Reading(dBuV).

2.Correction factor (dB/m) = Antenna Factor (dB/m) + Cable loss (dB) – Pre-Amplifier gain (dB).

3.When the peak results are less than average limit, so not need to evaluate the average.



Standard:	FCC Part 15.407	Test Distance:	3m
Test item:	Band edge		
Frequency:	5795MHz		
Mode:	Mode 7		
Ant.Polar.:	Vertical		

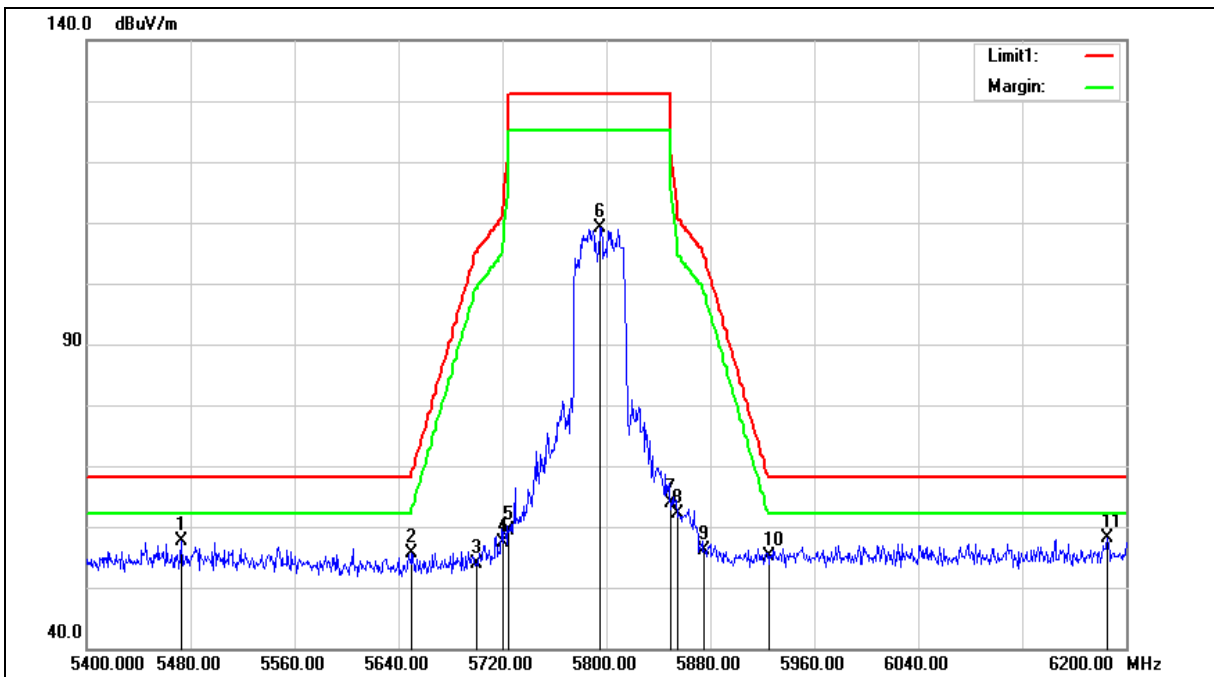



Standard:	FCC Part 15.407	Test Distance:	3m
Test item:	Band edge		
Frequency:	5795MHz		
Mode:	Mode 7		
Ant.Polar.:	Vertical		

No.	Frequency (MHz)	Reading (dBuV)	Correct Factor (dB/m)	Result (dBuV/m)	Limit (dBuV/m)	Margin (dB)	Remark
1	5472.800	51.59	5.96	57.55	68.20	-10.65	peak
2	5650.000	49.33	6.31	55.64	68.20	-12.56	peak
3	5700.000	47.55	6.40	53.95	105.20	-51.25	peak
4	5720.000	50.98	6.44	57.42	110.80	-53.38	peak
5	5725.000	52.97	6.45	59.42	122.20	-62.78	peak
6	5795.200	102.62	6.57	109.19	--	--	peak
7	5850.000	57.28	6.67	63.95	122.20	-58.25	peak
8	5855.000	55.45	6.67	62.12	110.80	-48.68	peak
9	5875.000	49.53	6.72	56.25	105.20	-48.95	peak
10	5925.000	48.26	6.80	55.06	68.20	-13.14	peak
11	6185.600	50.68	7.48	58.16	68.20	-10.04	peak

Note:1.Result (dBuV/m) = Correct Factor (dB/m) + Reading(dBuV).

2.Correction factor (dB/m) = Antenna Factor (dB/m) + Cable loss (dB) – Pre-Amplifier gain (dB).

3.When the peak results are less than average limit, so not need to evaluate the average.



Standard:	FCC Part 15.407	Test Distance:	3m
Test item:	Band edge		
Frequency:	5210MHz		
Mode:	Mode 8		
Ant.Polar.:	Horizontal		

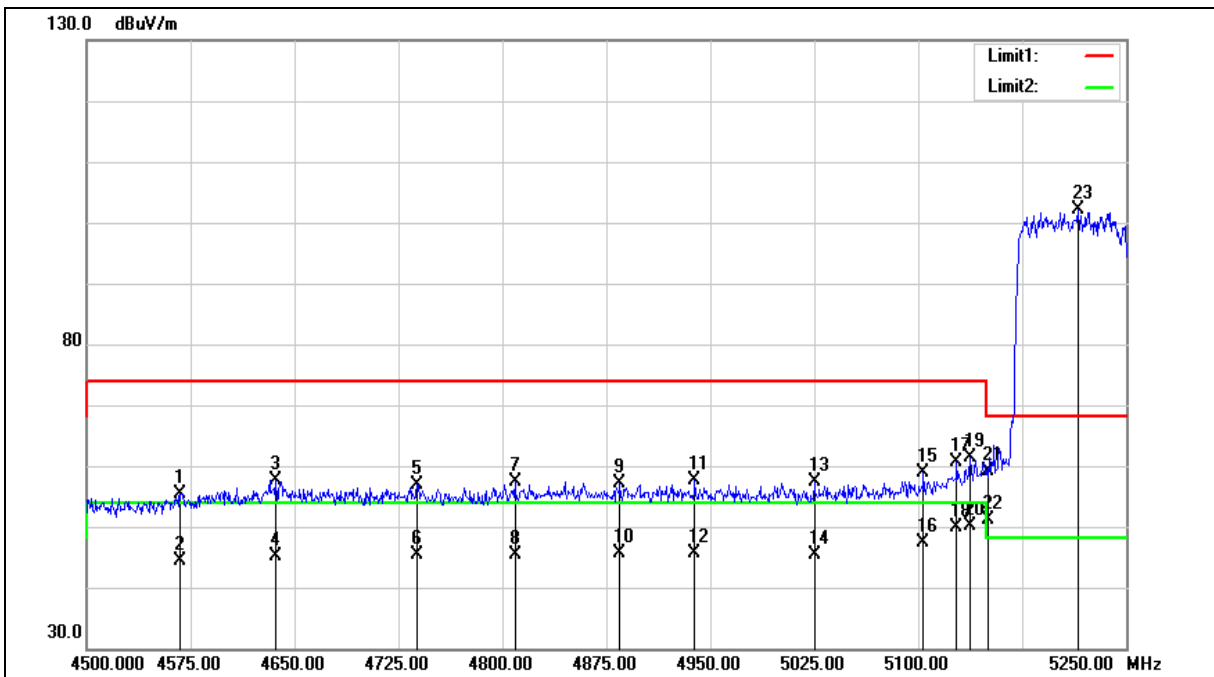



Standard:	FCC Part 15.407	Test Distance:	3m
Test item:	Band edge		
Frequency:	5210MHz		
Mode:	Mode 8		
Ant.Polar.:	Horizontal		

No.	Frequency (MHz)	Reading (dBuV)	Correct Factor (dB/m)	Result (dBuV/m)	Limit (dBuV/m)	Margin (dB)	Remark
1	4567.500	50.12	5.19	55.31	74.00	-18.69	peak
2	4567.500	39.09	5.19	44.28	54.00	-9.72	AVG
3	4636.500	52.27	5.40	57.67	74.00	-16.33	peak
4	4636.500	39.61	5.40	45.01	54.00	-8.99	AVG
5	4738.500	51.23	5.71	56.94	74.00	-17.06	peak
6	4738.500	39.55	5.71	45.26	54.00	-8.74	AVG
7	4809.000	51.57	5.93	57.50	74.00	-16.50	peak
8	4809.000	39.46	5.93	45.39	54.00	-8.61	AVG
9	4884.750	51.00	6.16	57.16	74.00	-16.84	peak
10	4884.750	39.52	6.16	45.68	54.00	-8.32	AVG
11	4938.750	51.19	6.33	57.52	74.00	-16.48	peak
12	4938.750	39.20	6.33	45.53	54.00	-8.47	AVG
13	5025.000	50.73	6.57	57.30	74.00	-16.70	peak
14	5025.000	38.92	6.57	45.49	54.00	-8.51	AVG
15	5103.750	51.98	6.80	58.78	74.00	-15.22	peak
16	5103.750	40.61	6.80	47.41	54.00	-6.59	AVG
17	5127.750	53.73	6.88	60.61	74.00	-13.39	peak
18	5127.750	43.05	6.88	49.93	54.00	-4.07	AVG
19	5137.500	54.47	6.91	61.38	74.00	-12.62	peak
20	5137.500	43.33	6.91	50.24	54.00	-3.76	AVG
21	5150.000	52.18	6.94	59.12	74.00	-14.88	peak
22	5150.000	44.08	6.94	51.02	54.00	-2.98	AVG
23	5215.500	95.10	7.13	102.23	--	--	peak

Note:1.Result (dBuV/m) = Correct Factor (dB/m) + Reading(dBuV).

2.Correction factor (dB/m) = Antenna Factor (dB/m) + Cable loss (dB) – Pre-Amplifier gain (dB).

3.When the peak results are less than average limit, so not need to evaluate the average.



Standard:	FCC Part 15.407	Test Distance:	3m
Test item:	Band edge		
Frequency:	5210MHz		
Mode:	Mode 8		
Ant.Polar.:	Vertical		

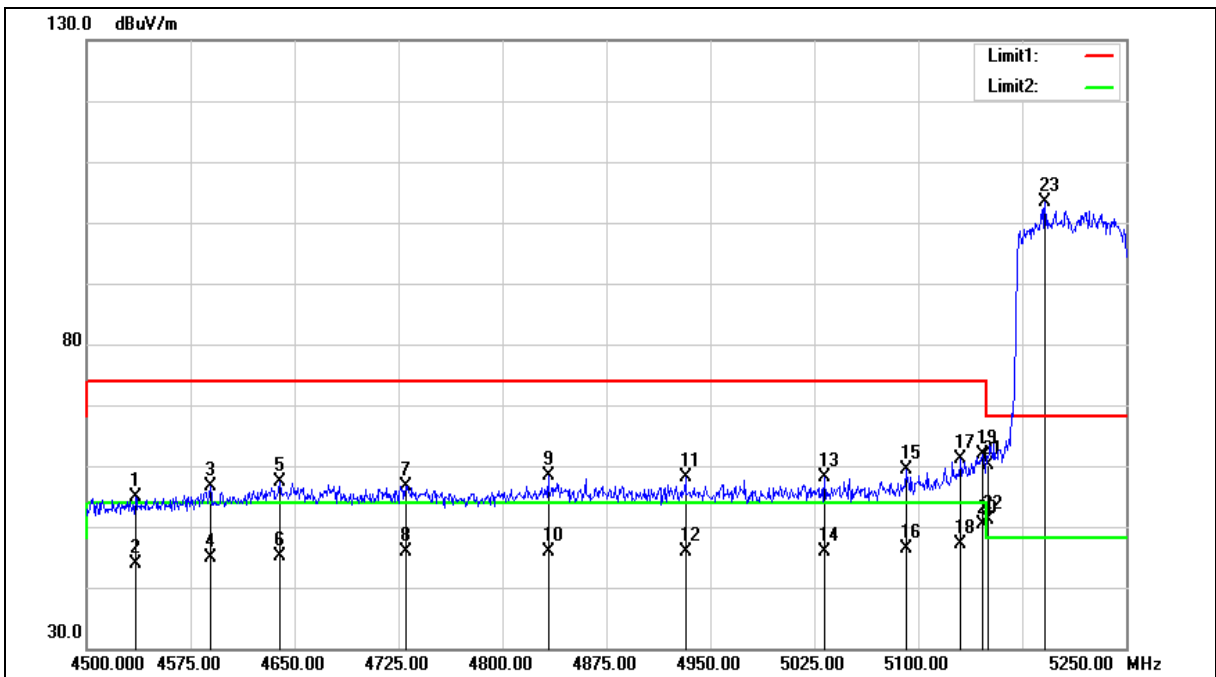



Standard:	FCC Part 15.407	Test Distance:	3m
Test item:	Band edge		
Frequency:	5210MHz		
Mode:	Mode 8		
Ant.Polar.:	Vertical		

No.	Frequency (MHz)	Reading (dBuV)	Correct Factor (dB/m)	Result (dBuV/m)	Limit (dBuV/m)	Margin (dB)	Remark
1	4535.250	49.71	5.09	54.80	74.00	-19.20	peak
2	4535.250	38.71	5.09	43.80	54.00	-10.20	AVG
3	4589.250	51.50	5.25	56.75	74.00	-17.25	peak
4	4589.250	39.59	5.25	44.84	54.00	-9.16	AVG
5	4639.500	52.05	5.41	57.46	74.00	-16.54	peak
6	4639.500	39.78	5.41	45.19	54.00	-8.81	AVG
7	4730.250	50.93	5.69	56.62	74.00	-17.38	peak
8	4730.250	40.16	5.69	45.85	54.00	-8.15	AVG
9	4833.000	52.42	5.99	58.41	74.00	-15.59	peak
10	4833.000	39.92	5.99	45.91	54.00	-8.09	AVG
11	4932.000	51.89	6.30	58.19	74.00	-15.81	peak
12	4932.000	39.54	6.30	45.84	54.00	-8.16	AVG
13	5032.500	51.62	6.60	58.22	74.00	-15.78	peak
14	5032.500	39.21	6.60	45.81	54.00	-8.19	AVG
15	5091.000	52.51	6.76	59.27	74.00	-14.73	peak
16	5091.000	39.59	6.76	46.35	54.00	-7.65	AVG
17	5130.750	54.26	6.89	61.15	74.00	-12.85	peak
18	5130.750	40.14	6.89	47.03	54.00	-6.97	AVG
19	5146.500	55.02	6.93	61.95	74.00	-12.05	peak
20	5146.500	43.35	6.93	50.28	54.00	-3.72	AVG
21	5150.000	53.19	6.94	60.13	74.00	-13.87	peak
22	5150.000	44.07	6.94	51.01	54.00	-2.99	AVG
23	5191.500	96.21	7.05	103.26	--	--	peak

Note:1.Result (dBuV/m) = Correct Factor (dB/m) + Reading(dBuV).

2.Correction factor (dB/m) = Antenna Factor (dB/m) + Cable loss (dB) – Pre-Amplifier gain (dB).

3.When the peak results are less than average limit, so not need to evaluate the average.



Standard:	FCC Part 15.407	Test Distance:	3m
Test item:	Band edge		
Frequency:	5775MHz		
Mode:	Mode 8		
Ant.Polar.:	Horizontal		

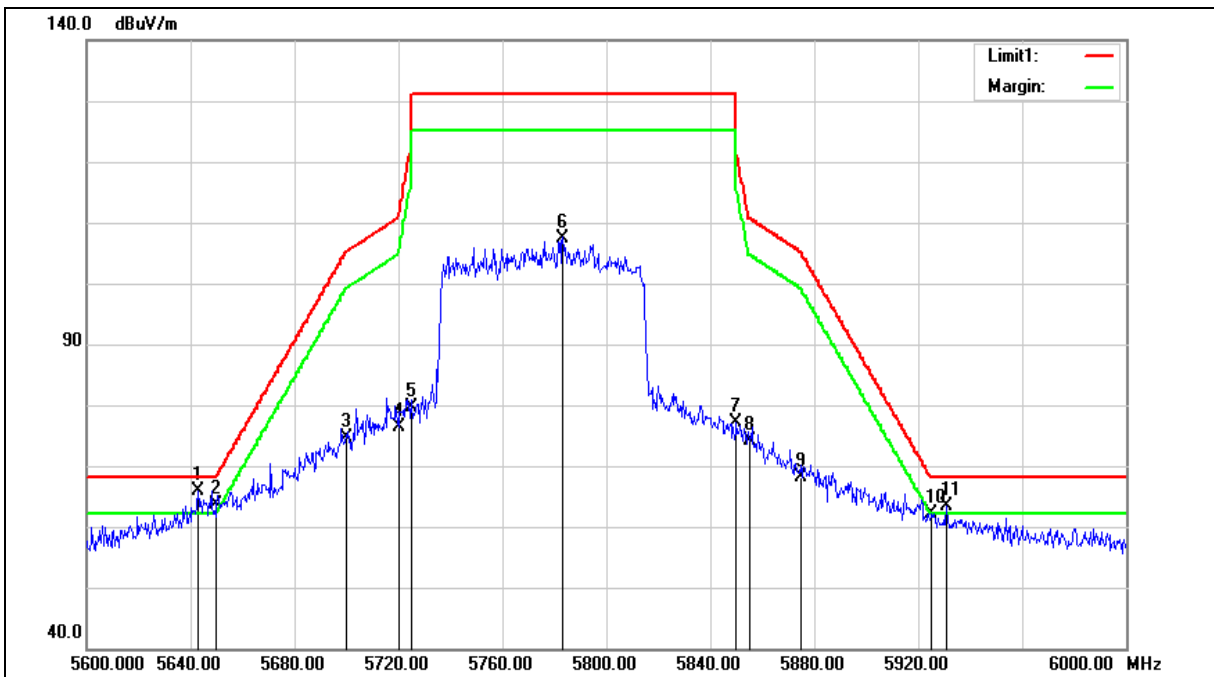



Standard:	FCC Part 15.407	Test Distance:	3m
Test item:	Band edge		
Frequency:	5775MHz		
Mode:	Mode 8		
Ant.Polar.:	Horizontal		

No.	Frequency (MHz)	Reading (dBuV)	Correct Factor (dB/m)	Result (dBuV/m)	Limit (dBuV/m)	Margin (dB)	Remark
1	5642.800	57.57	8.22	65.79	68.20	-2.41	peak
2	5650.000	55.32	8.24	63.56	68.20	-4.64	peak
3	5700.000	66.29	8.34	74.63	105.20	-30.57	peak
4	5720.000	68.03	8.38	76.41	110.80	-34.39	peak
5	5725.000	71.20	8.39	79.59	122.20	-42.61	peak
6	5783.200	98.76	8.50	107.26	--	--	peak
7	5850.000	68.41	8.63	77.04	122.20	-45.16	peak
8	5855.000	65.49	8.64	74.13	110.80	-36.67	peak
9	5875.000	59.56	8.69	68.25	105.20	-36.95	peak
10	5925.000	53.23	8.79	62.02	68.20	-6.18	peak
11	5930.800	54.48	8.80	63.28	68.20	-4.92	peak

Note:1.Result (dBuV/m) = Correct Factor (dB/m) + Reading(dBuV).

2.Correction factor (dB/m) = Antenna Factor (dB/m) + Cable loss (dB) – Pre-Amplifier gain (dB).

3.When the peak results are less than average limit, so not need to evaluate the average.



Standard:	FCC Part 15.407	Test Distance:	3m
Test item:	Band edge		
Frequency:	5775MHz		
Mode:	Mode 8		
Ant.Polar.:	Vertical		

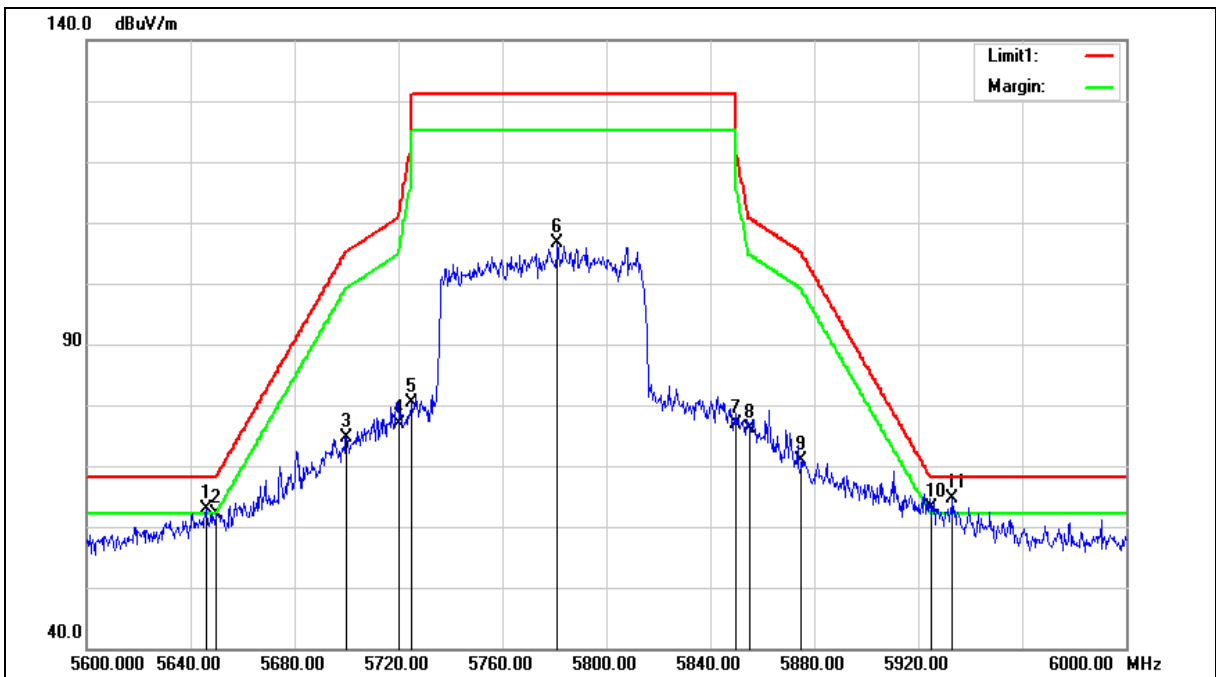



Standard:	FCC Part 15.407	Test Distance:	3m
Test item:	Band edge		
Frequency:	5775MHz		
Mode:	Mode 8		
Ant.Polar.:	Vertical		

No.	Frequency (MHz)	Reading (dBuV)	Correct Factor (dB/m)	Result (dBuV/m)	Limit (dBuV/m)	Margin (dB)	Remark
1	5646.000	54.72	8.23	62.95	68.20	-5.25	peak
2	5650.000	54.01	8.24	62.25	68.20	-5.95	peak
3	5700.000	66.21	8.34	74.55	105.20	-30.65	peak
4	5720.000	68.48	8.38	76.86	110.80	-33.94	peak
5	5725.000	71.94	8.39	80.33	122.20	-41.87	peak
6	5781.200	98.06	8.50	106.56	--	--	peak
7	5850.000	68.26	8.63	76.89	122.20	-45.31	peak
8	5855.000	67.56	8.64	76.20	110.80	-34.60	peak
9	5875.000	62.07	8.69	70.76	105.20	-34.44	peak
10	5925.000	54.36	8.79	63.15	68.20	-5.05	peak
11	5933.200	55.89	8.80	64.69	68.20	-3.51	peak

Note:1.Result (dBuV/m) = Correct Factor (dB/m) + Reading(dBuV).

2.Correction factor (dB/m) = Antenna Factor (dB/m) + Cable loss (dB) – Pre-Amplifier gain (dB).

3.When the peak results are less than average limit, so not need to evaluate the average.

Annex C. Conducted Test Results

Maximum Conducted Output Power Measurement

Test Mode		Mode 2: IEEE 802.11a Continuous TX mode		
Frequency (MHz)	Data Rate	ANT-0		Limit (dBm)
		(dBm)	(W)	
5180.0	6 M	16.51	0.045	≤ 30.00
5200.0		16.48	0.044	≤ 30.00
5220.0		16.46	0.044	≤ 30.00
5240.0		16.61	0.046	≤ 30.00
5745.0		19.24	0.084	≤ 30.00
5765.0		19.28	0.085	≤ 30.00
5785.0		19.31	0.085	≤ 30.00
5805.0		19.25	0.084	≤ 30.00
5825.0		19.52	0.090	≤ 30.00
Frequency (MHz)	Data Rate	ANT-1		Limit (dBm)
		(dBm)	(W)	
5180.0	6 M	16.71	0.047	≤ 30.00
5200.0		16.69	0.047	≤ 30.00
5220.0		16.65	0.046	≤ 30.00
5240.0		16.91	0.049	≤ 30.00
5745.0		18.94	0.078	≤ 30.00
5765.0		18.78	0.076	≤ 30.00
5785.0		18.82	0.076	≤ 30.00
5805.0		18.80	0.076	≤ 30.00
5825.0		19.15	0.082	≤ 30.00
Frequency (MHz)	Data Rate	ANT-2		Limit (dBm)
		(dBm)	(W)	
5180.0	6 M	16.48	0.044	≤ 30.00
5200.0		16.51	0.045	≤ 30.00
5220.0		16.45	0.044	≤ 30.00
5240.0		16.54	0.045	≤ 30.00
5745.0		19.51	0.089	≤ 30.00
5765.0		19.46	0.088	≤ 30.00
5785.0		19.54	0.090	≤ 30.00
5805.0		19.51	0.089	≤ 30.00
5825.0		19.61	0.091	≤ 30.00

Note: The relevant measured result has the offset with cable loss already.



Test Mode		Mode 2: IEEE 802.11a Continuous TX mode		
Frequency (MHz)	Data Rate	ANT-3		Limit (dBm)
		(dBm)	(W)	
5180.0	6 M	16.81	0.048	≤ 30.00
5200.0		16.84	0.048	≤ 30.00
5220.0		16.79	0.048	≤ 30.00
5240.0		16.86	0.049	≤ 30.00
5745.0		19.32	0.086	≤ 30.00
5765.0		19.39	0.087	≤ 30.00
5785.0		19.41	0.087	≤ 30.00
5805.0		19.35	0.086	≤ 30.00
5825.0		19.46	0.088	≤ 30.00
Frequency (MHz)		Data Rate	ANT-0+1+2+3	
	(dBm)		(W)	
5180.0	6 M	22.65	0.184	≤ 30.00
5200.0		22.65	0.184	≤ 30.00
5220.0		22.61	0.182	≤ 30.00
5240.0		22.75	0.189	≤ 30.00
5745.0		25.28	0.337	≤ 30.00
5765.0		25.26	0.335	≤ 30.00
5785.0		25.30	0.339	≤ 30.00
5805.0		25.26	0.335	≤ 30.00
5825.0		25.46	0.351	≤ 30.00

Note: The relevant measured result has the offset with cable loss already.



Test Mode		Mode 3: IEEE 802.11ac 20 MHz Continuous TX mode		
Frequency (MHz)	Data Rate	ANT-0		Limit (dBm)
		(dBm)	(W)	
5180.0	26 M	18.22	0.066	≤ 30.00
5200.0		19.32	0.086	≤ 30.00
5220.0		19.29	0.085	≤ 30.00
5240.0		19.41	0.087	≤ 30.00
5745.0		19.14	0.082	≤ 30.00
5765.0		19.20	0.083	≤ 30.00
5785.0		19.22	0.084	≤ 30.00
5805.0		19.19	0.083	≤ 30.00
5825.0		19.48	0.089	≤ 30.00
Frequency (MHz)	Data Rate	ANT-1		Limit (dBm)
		(dBm)	(W)	
5180.0	26 M	18.34	0.068	≤ 30.00
5200.0		19.24	0.084	≤ 30.00
5220.0		19.20	0.083	≤ 30.00
5240.0		19.34	0.086	≤ 30.00
5745.0		18.80	0.076	≤ 30.00
5765.0		18.79	0.076	≤ 30.00
5785.0		18.85	0.077	≤ 30.00
5805.0		18.82	0.076	≤ 30.00
5825.0		18.82	0.076	≤ 30.00
Frequency (MHz)	Data Rate	ANT-2		Limit (dBm)
		(dBm)	(W)	
5180.0	26 M	18.32	0.068	≤ 30.00
5200.0		19.14	0.082	≤ 30.00
5220.0		19.11	0.081	≤ 30.00
5240.0		19.24	0.084	≤ 30.00
5745.0		19.28	0.085	≤ 30.00
5765.0		19.39	0.087	≤ 30.00
5785.0		19.45	0.088	≤ 30.00
5805.0		19.42	0.087	≤ 30.00
5825.0		19.42	0.087	≤ 30.00

Note: The relevant measured result has the offset with cable loss already.



Test Mode		Mode 3: IEEE 802.11ac 20 MHz Continuous TX mode		
Frequency (MHz)	Data Rate	ANT-3		Limit (dBm)
		(dBm)	(W)	
5180.0	26 M	18.38	0.069	≤ 30.00
5200.0		19.35	0.086	≤ 30.00
5220.0		19.29	0.085	≤ 30.00
5240.0		19.31	0.085	≤ 30.00
5745.0		19.22	0.084	≤ 30.00
5765.0		19.25	0.084	≤ 30.00
5785.0		19.32	0.086	≤ 30.00
5805.0		19.29	0.085	≤ 30.00
5825.0		19.34	0.086	≤ 30.00
5825.0		19.34	0.086	≤ 30.00
Frequency (MHz)	Data Rate	ANT-0+1+2+3		Limit (dBm)
		(dBm)	(W)	
5180.0	26 M	24.34	0.271	≤ 30.00
5200.0		25.28	0.338	≤ 30.00
5220.0		25.24	0.334	≤ 30.00
5240.0		25.35	0.342	≤ 30.00
5745.0		25.13	0.326	≤ 30.00
5765.0		25.18	0.330	≤ 30.00
5785.0		25.24	0.334	≤ 30.00
5805.0		25.21	0.332	≤ 30.00
5825.0		25.29	0.338	≤ 30.00
5825.0		25.29	0.338	≤ 30.00

Note: The relevant measured result has the offset with cable loss already.



Test Mode		Mode 4: IEEE 802.11ac 40 MHz Continuous TX mode		
Frequency (MHz)	Data Rate	ANT-0		Limit (dBm)
		(dBm)	(W)	
5190.0	54 M	16.64	0.046	≤ 30.00
5230.0		19.51	0.089	≤ 30.00
5755.0		19.21	0.083	≤ 30.00
5795.0		19.48	0.089	≤ 30.00
Frequency (MHz)	Data Rate	ANT-1		Limit (dBm)
		(dBm)	(W)	
5190.0	54 M	16.74	0.047	≤ 30.00
5230.0		19.68	0.093	≤ 30.00
5755.0		19.18	0.083	≤ 30.00
5795.0		19.12	0.082	≤ 30.00
Frequency (MHz)	Data Rate	ANT-2		Limit (dBm)
		(dBm)	(W)	
5190.0	54 M	16.68	0.047	≤ 30.00
5230.0		19.48	0.089	≤ 30.00
5755.0		19.82	0.096	≤ 30.00
5795.0		19.95	0.099	≤ 30.00
Frequency (MHz)	Data Rate	ANT-3		Limit (dBm)
		(dBm)	(W)	
5190.0	54 M	16.91	0.049	≤ 30.00
5230.0		19.61	0.091	≤ 30.00
5755.0		19.44	0.088	≤ 30.00
5795.0		19.51	0.089	≤ 30.00
Frequency (MHz)	Data Rate	ANT-0+1+2+3		Limit (dBm)
		(dBm)	(W)	
5190.0	54 M	22.76	0.189	≤ 30.00
5230.0		25.59	0.362	≤ 30.00
5755.0		25.44	0.350	≤ 30.00
5795.0		25.55	0.359	≤ 30.00

Note: The relevant measured result has the offset with cable loss already.



Test Mode		Mode 5: IEEE 802.11ac 80 MHz Continuous TX mode		
Frequency (MHz)	Data Rate	ANT-0		Limit (dBm)
		(dBm)	(W)	
5210.0	117.2 M	16.44	0.044	≤ 30.00
5775.0		19.22	0.084	≤ 30.00
Frequency (MHz)	Data Rate	ANT-1		Limit (dBm)
		(dBm)	(W)	
5210.0	117.2 M	16.48	0.044	≤ 30.00
5775.0		18.94	0.078	≤ 30.00
Frequency (MHz)	Data Rate	ANT-2		Limit (dBm)
		(dBm)	(W)	
5210.0	117.2 M	16.22	0.042	≤ 30.00
5775.0		19.81	0.096	≤ 30.00
Frequency (MHz)	Data Rate	ANT-3		Limit (dBm)
		(dBm)	(W)	
5210.0	117.2 M	16.61	0.046	≤ 30.00
5775.0		19.34	0.086	≤ 30.00
Frequency (MHz)	Data Rate	ANT-0+1+2+3		Limit (dBm)
		(dBm)	(W)	
5210.0	117.2 M	22.46	0.176	≤ 30.00
5775.0		25.36	0.344	≤ 30.00

Note: The relevant measured result has the offset with cable loss already.



Test Mode		Mode 6: IEEE 802.11ax 20 MHz Continuous TX mode		
Frequency (MHz)	Data Rate	ANT-0		Limit (dBm)
		(dBm)	(W)	
5180.0	MCS 0	18.12	0.065	≤ 30.00
5200.0		19.61	0.091	≤ 30.00
5220.0		19.55	0.090	≤ 30.00
5240.0		19.72	0.094	≤ 30.00
5745.0		19.14	0.082	≤ 30.00
5765.0		19.22	0.084	≤ 30.00
5785.0		19.31	0.085	≤ 30.00
5805.0		19.29	0.085	≤ 30.00
5825.0		19.64	0.092	≤ 30.00
Frequency (MHz)	Data Rate	ANT-1		Limit (dBm)
		(dBm)	(W)	
5180.0	MCS 0	18.21	0.066	≤ 30.00
5200.0		19.51	0.089	≤ 30.00
5220.0		19.48	0.089	≤ 30.00
5240.0		19.61	0.091	≤ 30.00
5745.0		18.82	0.076	≤ 30.00
5765.0		19.00	0.079	≤ 30.00
5785.0		19.02	0.080	≤ 30.00
5805.0		18.97	0.079	≤ 30.00
5825.0		19.21	0.083	≤ 30.00
Frequency (MHz)	Data Rate	ANT-2		Limit (dBm)
		(dBm)	(W)	
5180.0	MCS 0	18.18	0.066	≤ 30.00
5200.0		19.24	0.084	≤ 30.00
5220.0		19.20	0.083	≤ 30.00
5240.0		19.31	0.085	≤ 30.00
5745.0		19.65	0.092	≤ 30.00
5765.0		19.66	0.092	≤ 30.00
5785.0		19.71	0.094	≤ 30.00
5805.0		19.62	0.092	≤ 30.00
5825.0		19.61	0.091	≤ 30.00

Note: The relevant measured result has the offset with cable loss already.



Test Mode		Mode 6: IEEE 802.11ax 20 MHz Continuous TX mode		
Frequency (MHz)	Data Rate	ANT-3		Limit (dBm)
		(dBm)	(W)	
5180.0	MCS 0	18.22	0.066	≤ 30.00
5200.0		19.54	0.090	≤ 30.00
5220.0		19.48	0.089	≤ 30.00
5240.0		19.58	0.091	≤ 30.00
5745.0		19.34	0.086	≤ 30.00
5765.0		19.31	0.085	≤ 30.00
5785.0		19.35	0.086	≤ 30.00
5805.0		19.28	0.085	≤ 30.00
5825.0		19.66	0.092	≤ 30.00
Frequency (MHz)		Data Rate	ANT-0+1+2+3	
	(dBm)		(W)	
5180.0	MCS 0	24.20	0.263	≤ 30.00
5200.0		25.50	0.355	≤ 30.00
5220.0		25.45	0.351	≤ 30.00
5240.0		25.58	0.361	≤ 30.00
5745.0		25.27	0.336	≤ 30.00
5765.0		25.32	0.341	≤ 30.00
5785.0		25.38	0.345	≤ 30.00
5805.0		25.32	0.340	≤ 30.00
5825.0		25.55	0.359	≤ 30.00

Note: The relevant measured result has the offset with cable loss already.



Test Mode		Mode 7: IEEE 802.11ax 40 MHz Continuous TX mode		
Frequency (MHz)	Data Rate	ANT-0		Limit (dBm)
		(dBm)	(W)	
5190.0	MCS 0	16.82	0.048	≤ 30.00
5230.0		19.64	0.092	≤ 30.00
5755.0		19.32	0.086	≤ 30.00
5795.0		19.54	0.090	≤ 30.00
Frequency (MHz)	Data Rate	ANT-1		Limit (dBm)
		(dBm)	(W)	
5190.0	MCS 0	16.88	0.049	≤ 30.00
5230.0		19.91	0.098	≤ 30.00
5755.0		19.14	0.082	≤ 30.00
5795.0		19.24	0.084	≤ 30.00
Frequency (MHz)	Data Rate	ANT-2		Limit (dBm)
		(dBm)	(W)	
5190.0	MCS 0	16.92	0.049	≤ 30.00
5230.0		19.58	0.091	≤ 30.00
5755.0		19.92	0.098	≤ 30.00
5795.0		19.96	0.099	≤ 30.00
Frequency (MHz)	Data Rate	ANT-3		Limit (dBm)
		(dBm)	(W)	
5190.0	MCS 0	17.01	0.050	≤ 30.00
5230.0		19.82	0.096	≤ 30.00
5755.0		19.64	0.092	≤ 30.00
5795.0		19.82	0.096	≤ 30.00
Frequency (MHz)	Data Rate	ANT-0+1+2+3		Limit (dBm)
		(dBm)	(W)	
5190.0	MCS 0	22.93	0.196	≤ 30.00
5230.0		25.76	0.377	≤ 30.00
5755.0		25.54	0.358	≤ 30.00
5795.0		25.67	0.369	≤ 30.00

Note: The relevant measured result has the offset with cable loss already.



Test Mode		Mode 8: IEEE 802.11ax 80 MHz Continuous TX mode		
Frequency (MHz)	Data Rate	ANT-0		Limit (dBm)
		(dBm)	(W)	
5210.0	MCS 0	16.14	0.041	≤ 30.00
5775.0		19.32	0.086	≤ 30.00
Frequency (MHz)	Data Rate	ANT-1		Limit (dBm)
		(dBm)	(W)	
5210.0	MCS 0	16.19	0.042	≤ 30.00
5775.0		19.14	0.082	≤ 30.00
Frequency (MHz)	Data Rate	ANT-2		Limit (dBm)
		(dBm)	(W)	
5210.0	MCS 0	15.92	0.039	≤ 30.00
5775.0		19.94	0.099	≤ 30.00
Frequency (MHz)	Data Rate	ANT-3		Limit (dBm)
		(dBm)	(W)	
5210.0	MCS 0	16.21	0.042	≤ 30.00
5775.0		19.52	0.090	≤ 30.00
Frequency (MHz)	Data Rate	ANT-0+1+2+3		Limit (dBm)
		(dBm)	(W)	
5210.0	MCS 0	22.14	0.164	≤ 30.00
5775.0		25.51	0.356	≤ 30.00

Note: The relevant measured result has the offset with cable loss already.



Beamforming on

Test Mode		Mode 3: IEEE 802.11ac 20 MHz Continuous TX mode		
Frequency (MHz)	Data Rate	ANT-0		Limit (dBm)
		(dBm)	(W)	
5180.0	26 M	11.91	0.016	≤ 25.35
5200.0		12.95	0.020	≤ 25.35
5220.0		12.93	0.020	≤ 25.35
5240.0		13.14	0.021	≤ 25.35
5745.0		12.76	0.019	≤ 25.31
5765.0		12.75	0.019	≤ 25.31
5785.0		12.81	0.019	≤ 25.31
5805.0		12.77	0.019	≤ 25.31
5825.0		13.23	0.021	≤ 25.31
Frequency (MHz)	Data Rate	ANT-1		Limit (dBm)
		(dBm)	(W)	
5180.0	26 M	12.14	0.016	≤ 25.35
5200.0		13.11	0.020	≤ 25.35
5220.0		13.08	0.020	≤ 25.35
5240.0		13.33	0.022	≤ 25.35
5745.0		12.74	0.019	≤ 25.31
5765.0		12.64	0.018	≤ 25.31
5785.0		12.68	0.019	≤ 25.31
5805.0		12.65	0.018	≤ 25.31
5825.0		12.80	0.019	≤ 25.31
Frequency (MHz)	Data Rate	ANT-2		Limit (dBm)
		(dBm)	(W)	
5180.0	26 M	12.18	0.017	≤ 25.35
5200.0		12.97	0.020	≤ 25.35
5220.0		12.92	0.020	≤ 25.35
5240.0		13.15	0.021	≤ 25.35
5745.0		13.18	0.021	≤ 25.31
5765.0		13.10	0.020	≤ 25.31
5785.0		13.14	0.021	≤ 25.31
5805.0		13.09	0.020	≤ 25.31
5825.0		13.34	0.022	≤ 25.31

Note: The relevant measured result has the offset with cable loss already.



Test Mode		Mode 3: IEEE 802.11ac 20 MHz Continuous TX mode		
Frequency (MHz)	Data Rate	ANT-3		Limit (dBm)
		(dBm)	(W)	
5180.0	26 M	12.14	0.016	≤ 25.35
5200.0		13.13	0.021	≤ 25.35
5220.0		13.10	0.020	≤ 25.35
5240.0		13.25	0.021	≤ 25.35
5745.0		13.15	0.021	≤ 25.31
5765.0		13.06	0.020	≤ 25.31
5785.0		13.12	0.021	≤ 25.31
5805.0		13.09	0.020	≤ 25.31
5825.0		13.28	0.021	≤ 25.31
5825.0		13.28	0.021	≤ 25.31
Frequency (MHz)	Data Rate	ANT-0+1+2+3		Limit (dBm)
		(dBm)	(W)	
5180.0	26 M	18.11	0.065	≤ 25.35
5200.0		19.06	0.081	≤ 25.35
5220.0		19.03	0.080	≤ 25.35
5240.0		19.24	0.084	≤ 25.35
5745.0		18.98	0.079	≤ 25.31
5765.0		18.91	0.078	≤ 25.31
5785.0		18.96	0.079	≤ 25.31
5805.0		18.92	0.078	≤ 25.31
5825.0		19.19	0.083	≤ 25.31
5825.0		19.19	0.083	≤ 25.31

Note: The relevant measured result has the offset with cable loss already.



Test Mode		Mode 4: IEEE 802.11ac 40 MHz Continuous TX mode		
Frequency (MHz)	Data Rate	ANT-0		Limit (dBm)
		(dBm)	(W)	
5190.0	54 M	10.26	0.011	≤ 25.35
5230.0		13.21	0.021	≤ 25.35
5755.0		12.84	0.019	≤ 25.31
5795.0		13.22	0.021	≤ 25.31
Frequency (MHz)	Data Rate	ANT-1		Limit (dBm)
		(dBm)	(W)	
5190.0	54 M	10.42	0.011	≤ 25.35
5230.0		13.41	0.022	≤ 25.35
5755.0		12.85	0.019	≤ 25.31
5795.0		12.78	0.019	≤ 25.31
Frequency (MHz)	Data Rate	ANT-2		Limit (dBm)
		(dBm)	(W)	
5190.0	54 M	10.22	0.011	≤ 25.35
5230.0		13.28	0.021	≤ 25.35
5755.0		13.64	0.023	≤ 25.31
5795.0		13.68	0.023	≤ 25.31
Frequency (MHz)	Data Rate	ANT-3		Limit (dBm)
		(dBm)	(W)	
5190.0	54 M	10.33	0.011	≤ 25.35
5230.0		13.36	0.022	≤ 25.35
5755.0		13.17	0.021	≤ 25.31
5795.0		13.34	0.022	≤ 25.31
Frequency (MHz)	Data Rate	ANT-0+1+2+3		Limit (dBm)
		(dBm)	(W)	
5190.0	54 M	16.33	0.043	≤ 25.35
5230.0		19.34	0.086	≤ 25.35
5755.0		19.16	0.082	≤ 25.31
5795.0		19.29	0.085	≤ 25.31

Note: The relevant measured result has the offset with cable loss already.



Test Mode		Mode 5: IEEE 802.11ac 80 MHz Continuous TX mode		
Frequency (MHz)	Data Rate	ANT-0		Limit (dBm)
		(dBm)	(W)	
5210.0	117.2 M	10.06	0.010	≤ 25.35
5775.0		12.86	0.019	≤ 25.31
Frequency (MHz)	Data Rate	ANT-1		Limit (dBm)
		(dBm)	(W)	
5210.0	117.2 M	10.09	0.010	≤ 25.35
5775.0		12.67	0.018	≤ 25.31
Frequency (MHz)	Data Rate	ANT-2		Limit (dBm)
		(dBm)	(W)	
5210.0	117.2 M	9.98	0.010	≤ 25.35
5775.0		13.51	0.022	≤ 25.31
Frequency (MHz)	Data Rate	ANT-3		Limit (dBm)
		(dBm)	(W)	
5210.0	117.2 M	10.07	0.010	≤ 25.35
5775.0		13.14	0.021	≤ 25.31
Frequency (MHz)	Data Rate	ANT-0+1+2+3		Limit (dBm)
		(dBm)	(W)	
5210.0	117.2 M	16.07	0.040	≤ 25.35
5775.0		19.08	0.081	≤ 25.31

Note: The relevant measured result has the offset with cable loss already.



Test Mode		Mode 6: IEEE 802.11ax 20 MHz Continuous TX mode		
Frequency (MHz)	Data Rate	ANT-0		Limit (dBm)
		(dBm)	(W)	
5180.0	MCS 0	11.81	0.015	≤ 25.35
5200.0		13.25	0.021	≤ 25.35
5220.0		13.21	0.021	≤ 25.35
5240.0		13.51	0.022	≤ 25.35
5745.0		13.02	0.020	≤ 25.31
5765.0		13.01	0.020	≤ 25.31
5785.0		13.09	0.020	≤ 25.31
5805.0		13.06	0.020	≤ 25.31
5825.0		13.54	0.023	≤ 25.31
Frequency (MHz)	Data Rate	ANT-1		Limit (dBm)
		(dBm)	(W)	
5180.0	MCS 0	12.04	0.016	≤ 25.35
5200.0		13.41	0.022	≤ 25.35
5220.0		13.44	0.022	≤ 25.35
5240.0		13.57	0.023	≤ 25.35
5745.0		12.78	0.019	≤ 25.31
5765.0		12.73	0.019	≤ 25.31
5785.0		12.82	0.019	≤ 25.31
5805.0		12.77	0.019	≤ 25.31
5825.0		13.04	0.020	≤ 25.31
Frequency (MHz)	Data Rate	ANT-2		Limit (dBm)
		(dBm)	(W)	
5180.0	MCS 0	11.97	0.016	≤ 25.35
5200.0		13.18	0.021	≤ 25.35
5220.0		13.12	0.021	≤ 25.35
5240.0		13.28	0.021	≤ 25.35
5745.0		13.54	0.023	≤ 25.31
5765.0		13.51	0.022	≤ 25.31
5785.0		13.58	0.023	≤ 25.31
5805.0		13.55	0.023	≤ 25.31
5825.0		13.60	0.023	≤ 25.31

Note: The relevant measured result has the offset with cable loss already.



Test Mode		Mode 6: IEEE 802.11ax 20 MHz Continuous TX mode		
Frequency (MHz)	Data Rate	ANT-3		Limit (dBm)
		(dBm)	(W)	
5180.0	MCS 0	11.94	0.016	≤ 25.35
5200.0		13.34	0.022	≤ 25.35
5220.0		13.30	0.021	≤ 25.35
5240.0		13.51	0.022	≤ 25.35
5745.0		13.31	0.021	≤ 25.31
5765.0		13.26	0.021	≤ 25.31
5785.0		13.30	0.021	≤ 25.31
5805.0		13.22	0.021	≤ 25.31
5825.0		13.55	0.023	≤ 25.31
5825.0				
Frequency (MHz)	Data Rate	ANT-0+1+2+3		Limit (dBm)
		(dBm)	(W)	
5180.0	MCS 0	17.96	0.063	≤ 25.35
5200.0		19.32	0.085	≤ 25.35
5220.0		19.29	0.085	≤ 25.35
5240.0		19.49	0.089	≤ 25.35
5745.0		19.19	0.083	≤ 25.31
5765.0		19.16	0.082	≤ 25.31
5785.0		19.23	0.084	≤ 25.31
5805.0		19.18	0.083	≤ 25.31
5825.0		19.46	0.088	≤ 25.31

Note: The relevant measured result has the offset with cable loss already.



Test Mode		Mode 7: IEEE 802.11ax 40 MHz Continuous TX mode		
Frequency (MHz)	Data Rate	ANT-0		Limit (dBm)
		(dBm)	(W)	
5190.0	MCS 0	10.36	0.011	≤ 25.35
5230.0		13.24	0.021	≤ 25.35
5755.0		12.94	0.020	≤ 25.31
5795.0		13.26	0.021	≤ 25.31
Frequency (MHz)	Data Rate	ANT-1		Limit (dBm)
		(dBm)	(W)	
5190.0	MCS 0	10.46	0.011	≤ 25.35
5230.0		13.56	0.023	≤ 25.35
5755.0		13.02	0.020	≤ 25.31
5795.0		12.97	0.020	≤ 25.31
Frequency (MHz)	Data Rate	ANT-2		Limit (dBm)
		(dBm)	(W)	
5190.0	MCS 0	10.29	0.011	≤ 25.35
5230.0		13.25	0.021	≤ 25.35
5755.0		13.74	0.024	≤ 25.31
5795.0		13.72	0.024	≤ 25.31
Frequency (MHz)	Data Rate	ANT-3		Limit (dBm)
		(dBm)	(W)	
5190.0	MCS 0	10.41	0.011	≤ 25.35
5230.0		13.44	0.022	≤ 25.35
5755.0		13.44	0.022	≤ 25.31
5795.0		13.57	0.023	≤ 25.31
Frequency (MHz)	Data Rate	ANT-0+1+2+3		Limit (dBm)
		(dBm)	(W)	
5190.0	MCS 0	16.40	0.044	≤ 25.35
5230.0		19.40	0.087	≤ 25.35
5755.0		19.32	0.085	≤ 25.31
5795.0		19.41	0.087	≤ 25.31

Note: The relevant measured result has the offset with cable loss already.



Test Mode		Mode 8: IEEE 802.11ax 80 MHz Continuous TX mode		
Frequency (MHz)	Data Rate	ANT-0		Limit (dBm)
		(dBm)	(W)	
5210.0	MCS 0	9.68	0.009	≤ 25.35
5775.0		13.08	0.020	≤ 25.31
Frequency (MHz)	Data Rate	ANT-1		Limit (dBm)
		(dBm)	(W)	
5210.0	MCS 0	9.76	0.009	≤ 25.35
5775.0		12.97	0.020	≤ 25.31
Frequency (MHz)	Data Rate	ANT-2		Limit (dBm)
		(dBm)	(W)	
5210.0	MCS 0	9.59	0.009	≤ 25.35
5775.0		13.74	0.024	≤ 25.31
Frequency (MHz)	Data Rate	ANT-3		Limit (dBm)
		(dBm)	(W)	
5210.0	MCS 0	9.86	0.010	≤ 25.35
5775.0		13.48	0.022	≤ 25.31
Frequency (MHz)	Data Rate	ANT-0+1+2+3		Limit (dBm)
		(dBm)	(W)	
5210.0	MCS 0	15.74	0.038	≤ 25.35
5775.0		19.35	0.086	≤ 25.31

Note: The relevant measured result has the offset with cable loss already.



26 dB RF Bandwidth Measurement & 99 % Occupied Bandwidth Measurement

Test Mode	Mode 2: IEEE 802.11a Continuous TX mode	
Frequency (MHz)	26 dB Bandwidth (MHz)	99 % Occupied Bandwidth (MHz)
	ANT-0	
5180.0	19.440	16.447
5200.0	19.430	16.463
5240.0	19.390	16.453
Frequency (MHz)	26 dB Bandwidth (MHz)	99 % Occupied Bandwidth (MHz)
	ANT-1	
5180.0	19.620	16.475
5200.0	19.310	16.467
5240.0	19.400	16.425
Frequency (MHz)	26 dB Bandwidth (MHz)	99 % Occupied Bandwidth (MHz)
	ANT-2	
5180.0	19.190	16.447
5200.0	19.280	16.467
5240.0	19.280	16.482
Frequency (MHz)	26 dB Bandwidth (MHz)	99 % Occupied Bandwidth (MHz)
	ANT-3	
5180.0	19.180	16.440
5200.0	19.100	16.446
5240.0	19.170	16.446

Note: The 99 % occupied bandwidth not crossed 5250 MHz.



Test Mode	Mode 3: IEEE 802.11ac 20 MHz Continuous TX mode	
Frequency (MHz)	26 dB Bandwidth (MHz)	99 % Occupied Bandwidth (MHz)
	ANT-0	
5180.0	20.710	17.647
5200.0	21.380	17.683
5240.0	22.050	17.713
Frequency (MHz)	26 dB Bandwidth (MHz)	99 % Occupied Bandwidth (MHz)
	ANT-1	
5180.0	21.120	17.653
5200.0	22.730	17.740
5240.0	22.560	17.720
Frequency (MHz)	26 dB Bandwidth (MHz)	99 % Occupied Bandwidth (MHz)
	ANT-2	
5180.0	21.460	17.651
5200.0	23.890	17.715
5240.0	22.030	17.700
Frequency (MHz)	26 dB Bandwidth (MHz)	99 % Occupied Bandwidth (MHz)
	ANT-3	
5180.0	21.200	17.668
5200.0	23.210	17.727
5240.0	21.950	17.697

Note: The 99 % occupied bandwidth not crossed 5250 MHz.



Test Mode	Mode 4: IEEE 802.11ac 40 MHz Continuous TX mode	
Frequency (MHz)	26 dB Bandwidth (MHz)	99 % Occupied Bandwidth (MHz)
	ANT-0	
5190.0	41.980	36.254
5230.0	42.620	36.375
Frequency (MHz)	26 dB Bandwidth (MHz)	99 % Occupied Bandwidth (MHz)
	ANT-1	
5190.0	40.610	36.285
5230.0	44.930	36.490
Frequency (MHz)	26 dB Bandwidth (MHz)	99 % Occupied Bandwidth (MHz)
	ANT-2	
5190.0	40.920	36.192
5230.0	43.400	36.449
Frequency (MHz)	26 dB Bandwidth (MHz)	99 % Occupied Bandwidth (MHz)
	ANT-3	
5190.0	40.740	36.255
5230.0	47.560	36.436

Test Mode	Mode 5: IEEE 802.11ac 80 MHz Continuous TX mode	
Frequency (MHz)	26 dB Bandwidth (MHz)	99 % Occupied Bandwidth (MHz)
	ANT-0	
5210.0	81.330	75.354
Frequency (MHz)	26 dB Bandwidth (MHz)	99 % Occupied Bandwidth (MHz)
	ANT-1	
5210.0	80.940	75.385
Frequency (MHz)	26 dB Bandwidth (MHz)	99 % Occupied Bandwidth (MHz)
	ANT-2	
5210.0	82.190	75.428
Frequency (MHz)	26 dB Bandwidth (MHz)	99 % Occupied Bandwidth (MHz)
	ANT-3	
5210.0	82.040	75.426

Note: The 99 % occupied bandwidth not crossed 5250 MHz..



Test Mode	Mode 6: IEEE 802.11ax 20 MHz Continuous TX mode	
Frequency (MHz)	26 dB Bandwidth (MHz)	99 % Occupied Bandwidth (MHz)
	ANT-0	
5180.0	21.230	18.929
5200.0	21.540	18.991
5240.0	22.150	19.000
Frequency (MHz)	26 dB Bandwidth (MHz)	99 % Occupied Bandwidth (MHz)
	ANT-1	
5180.0	21.450	18.977
5200.0	22.420	19.055
5240.0	22.570	19.027
Frequency (MHz)	26 dB Bandwidth (MHz)	99 % Occupied Bandwidth (MHz)
	ANT-2	
5180.0	21.510	18.973
5200.0	21.780	19.010
5240.0	23.640	19.076
Frequency (MHz)	26 dB Bandwidth (MHz)	99 % Occupied Bandwidth (MHz)
	ANT-3	
5180.0	21.100	18.985
5200.0	23.370	19.048
5240.0	21.740	19.034

Note: The 99 % occupied bandwidth not crossed 5250 MHz.



Test Mode	Mode 7: IEEE 802.11ax 40 MHz Continuous TX mode	
Frequency (MHz)	26 dB Bandwidth (MHz)	99 % Occupied Bandwidth (MHz)
	ANT-0	
5190.0	41.040	37.861
5230.0	44.660	38.140
Frequency (MHz)	26 dB Bandwidth (MHz)	99 % Occupied Bandwidth (MHz)
	ANT-1	
5190.0	41.970	37.909
5230.0	42.790	38.063
Frequency (MHz)	26 dB Bandwidth (MHz)	99 % Occupied Bandwidth (MHz)
	ANT-2	
5190.0	41.380	37.807
5230.0	53.870	38.188
Frequency (MHz)	26 dB Bandwidth (MHz)	99 % Occupied Bandwidth (MHz)
	ANT-3	
5190.0	41.980	37.968
5230.0	43.530	38.087

Test Mode	Mode 8: IEEE 802.11ax 80 MHz Continuous TX mode	
Frequency (MHz)	26 dB Bandwidth (MHz)	99 % Occupied Bandwidth (MHz)
	ANT-0	
5210.0	81.790	77.093
Frequency (MHz)	26 dB Bandwidth (MHz)	99 % Occupied Bandwidth (MHz)
	ANT-1	
5210.0	81.710	77.041
Frequency (MHz)	26 dB Bandwidth (MHz)	99 % Occupied Bandwidth (MHz)
	ANT-2	
5210.0	82.150	77.132
Frequency (MHz)	26 dB Bandwidth (MHz)	99 % Occupied Bandwidth (MHz)
	ANT-3	
5210.0	82.210	77.130

Note: The 99 % occupied bandwidth not crossed 5250 MHz.



Beamforming on

Test Mode	Mode 3: IEEE 802.11ac 20 MHz Continuous TX mode	
Frequency (MHz)	26 dB Bandwidth (MHz)	99 % Occupied Bandwidth (MHz)
	ANT-0	
5180.0	20.430	17.618
5200.0	20.320	17.634
5240.0	20.600	17.615
Frequency (MHz)	26 dB Bandwidth (MHz)	99 % Occupied Bandwidth (MHz)
	ANT-1	
5180.0	20.350	17.600
5200.0	20.520	17.646
5240.0	20.470	17.669
Frequency (MHz)	26 dB Bandwidth (MHz)	99 % Occupied Bandwidth (MHz)
	ANT-2	
5180.0	20.550	17.604
5200.0	20.330	17.633
5240.0	20.410	17.651
Frequency (MHz)	26 dB Bandwidth (MHz)	99 % Occupied Bandwidth (MHz)
	ANT-3	
5180.0	20.410	17.636
5200.0	20.550	17.633
5240.0	20.300	17.610

Note: The 99 % occupied bandwidth not crossed 5250 MHz.



Test Mode	Mode 4: IEEE 802.11ac 40 MHz Continuous TX mode	
Frequency (MHz)	26 dB Bandwidth (MHz)	99 % Occupied Bandwidth (MHz)
	ANT-0	
5190.0	40.850	36.256
5230.0	40.990	36.208
Frequency (MHz)	26 dB Bandwidth (MHz)	99 % Occupied Bandwidth (MHz)
	ANT-1	
5190.0	41.060	36.252
5230.0	41.220	36.221
Frequency (MHz)	26 dB Bandwidth (MHz)	99 % Occupied Bandwidth (MHz)
	ANT-2	
5190.0	41.230	36.196
5230.0	40.840	36.182
Frequency (MHz)	26 dB Bandwidth (MHz)	99 % Occupied Bandwidth (MHz)
	ANT-3	
5190.0	40.580	36.236
5230.0	40.630	36.161

Test Mode	Mode 5: IEEE 802.11ac 80 MHz Continuous TX mode	
Frequency (MHz)	26 dB Bandwidth (MHz)	99 % Occupied Bandwidth (MHz)
	ANT-0	
5210.0	81.740	75.425
Frequency (MHz)	26 dB Bandwidth (MHz)	99 % Occupied Bandwidth (MHz)
	ANT-1	
5210.0	81.030	75.377
Frequency (MHz)	26 dB Bandwidth (MHz)	99 % Occupied Bandwidth (MHz)
	ANT-2	
5210.0	81.940	75.314
Frequency (MHz)	26 dB Bandwidth (MHz)	99 % Occupied Bandwidth (MHz)
	ANT-3	
5210.0	82.000	75.319

Note: The 99 % occupied bandwidth not crossed 5250 MHz.



Test Mode	Mode 6: IEEE 802.11ax 20 MHz Continuous TX mode	
Frequency (MHz)	26 dB Bandwidth (MHz)	99 % Occupied Bandwidth (MHz)
	ANT-0	
5180.0	20.880	18.985
5200.0	21.060	18.958
5240.0	21.230	18.975
Frequency (MHz)	26 dB Bandwidth (MHz)	99 % Occupied Bandwidth (MHz)
	ANT-1	
5180.0	20.930	18.979
5200.0	21.040	19.020
5240.0	20.650	18.930
Frequency (MHz)	26 dB Bandwidth (MHz)	99 % Occupied Bandwidth (MHz)
	ANT-2	
5180.0	21.580	18.989
5200.0	20.890	18.968
5240.0	21.210	19.005
Frequency (MHz)	26 dB Bandwidth (MHz)	99 % Occupied Bandwidth (MHz)
	ANT-3	
5180.0	20.740	18.993
5200.0	21.330	18.975
5240.0	21.240	18.974

Note: The 99 % occupied bandwidth not crossed 5250 MHz.



Test Mode	Mode 7: IEEE 802.11ax 40 MHz Continuous TX mode	
Frequency (MHz)	26 dB Bandwidth (MHz)	99 % Occupied Bandwidth (MHz)
	ANT-0	
5190.0	41.090	37.893
5230.0	41.610	37.903
Frequency (MHz)	26 dB Bandwidth (MHz)	99 % Occupied Bandwidth (MHz)
	ANT-1	
5190.0	41.850	37.921
5230.0	42.130	37.817
Frequency (MHz)	26 dB Bandwidth (MHz)	99 % Occupied Bandwidth (MHz)
	ANT-2	
5190.0	41.570	37.864
5230.0	41.720	37.942
Frequency (MHz)	26 dB Bandwidth (MHz)	99 % Occupied Bandwidth (MHz)
	ANT-3	
5190.0	41.370	37.911
5230.0	41.610	37.823

Test Mode	Mode 8: IEEE 802.11ax 80 MHz Continuous TX mode	
Frequency (MHz)	26 dB Bandwidth (MHz)	99 % Occupied Bandwidth (MHz)
	ANT-0	
5210.0	81.550	77.193
Frequency (MHz)	26 dB Bandwidth (MHz)	99 % Occupied Bandwidth (MHz)
	ANT-1	
5210.0	81.670	77.160
Frequency (MHz)	26 dB Bandwidth (MHz)	99 % Occupied Bandwidth (MHz)
	ANT-2	
5210.0	81.800	77.210
Frequency (MHz)	26 dB Bandwidth (MHz)	99 % Occupied Bandwidth (MHz)
	ANT-3	
5210.0	81.510	77.137

Note: The 99 % occupied bandwidth not crossed 5250 MHz.

■ Test Graphs

Mode 2: IEEE 802.11a Continuous TX mode_ ANT-0	
5180 MHz	<p>Agilent Spectrum Analyzer - Occupied BW</p> <p>Center Freq: 5.180000000 GHz Trig: Free Run #Attens: 30 dB Avg/Hold: 1/1 Radio Std: None Radio Device: BTS</p> <p>Ref Offset 11.4 dB Ref 30.00 dBm</p> <p>Center 5.18 GHz #Res BW 300 kHz #VBW 1 MHz Span 40 MHz Sweep 1 ms</p> <p>Occupied Bandwidth: 16.447 MHz Total Power: 23.7 dBm Transmit Freq Error: 5.612 kHz x dB Bandwidth: 19.44 MHz OBW Power: 99.00 % x dB: -26.00 dB</p> <p>Center Freq: 5.180000000 GHz CF Step: 4.000000 MHz Freq Offset: 0 Hz</p>
5200 MHz	<p>Agilent Spectrum Analyzer - Occupied BW</p> <p>Center Freq: 5.200000000 GHz Trig: Free Run #Attens: 30 dB Avg/Hold: 1/1 Radio Std: None Radio Device: BTS</p> <p>Ref Offset 11.4 dB Ref 30.00 dBm</p> <p>Center 5.2 GHz #Res BW 300 kHz #VBW 1 MHz Span 40 MHz Sweep 1 ms</p> <p>Occupied Bandwidth: 16.463 MHz Total Power: 23.1 dBm Transmit Freq Error: -17.679 kHz x dB Bandwidth: 19.43 MHz OBW Power: 99.00 % x dB: -26.00 dB</p> <p>Center Freq: 5.200000000 GHz CF Step: 4.000000 MHz Freq Offset: 0 Hz</p>
5240 MHz	<p>Agilent Spectrum Analyzer - Occupied BW</p> <p>Center Freq: 5.240000000 GHz Trig: Free Run #Attens: 30 dB Avg/Hold: 1/1 Radio Std: None Radio Device: BTS</p> <p>Ref Offset 11.4 dB Ref 30.00 dBm</p> <p>Center 5.24 GHz #Res BW 300 kHz #VBW 1 MHz Span 40 MHz Sweep 1 ms</p> <p>Occupied Bandwidth: 16.453 MHz Total Power: 23.0 dBm Transmit Freq Error: 16.392 kHz x dB Bandwidth: 19.39 MHz OBW Power: 99.00 % x dB: -26.00 dB</p> <p>Center Freq: 5.240000000 GHz CF Step: 4.000000 MHz Freq Offset: 0 Hz</p>



Mode 3: IEEE 802.11ac 20 MHz Continuous TX mode_ ANT-0	
5180 MHz	<p>Center Freq: 5.180000000 GHz</p> <p>Occupied Bandwidth: 17.647 MHz</p> <p>Total Power: 25.0 dBm</p> <p>Transmit Freq Error: 27.265 kHz</p> <p>OBW Power: 99.00 %</p> <p>x dB Bandwidth: 20.71 MHz</p> <p>x dB: -26.00 dB</p>
5200 MHz	<p>Center Freq: 5.200000000 GHz</p> <p>Occupied Bandwidth: 17.683 MHz</p> <p>Total Power: 25.5 dBm</p> <p>Transmit Freq Error: 5.328 kHz</p> <p>OBW Power: 99.00 %</p> <p>x dB Bandwidth: 21.38 MHz</p> <p>x dB: -26.00 dB</p>
5240 MHz	<p>Center Freq: 5.240000000 GHz</p> <p>Occupied Bandwidth: 17.713 MHz</p> <p>Total Power: 25.6 dBm</p> <p>Transmit Freq Error: -6.445 kHz</p> <p>OBW Power: 99.00 %</p> <p>x dB Bandwidth: 22.05 MHz</p> <p>x dB: -26.00 dB</p>



Mode 4: IEEE 802.11ac 40 MHz Continuous TX mode_ ANT-0

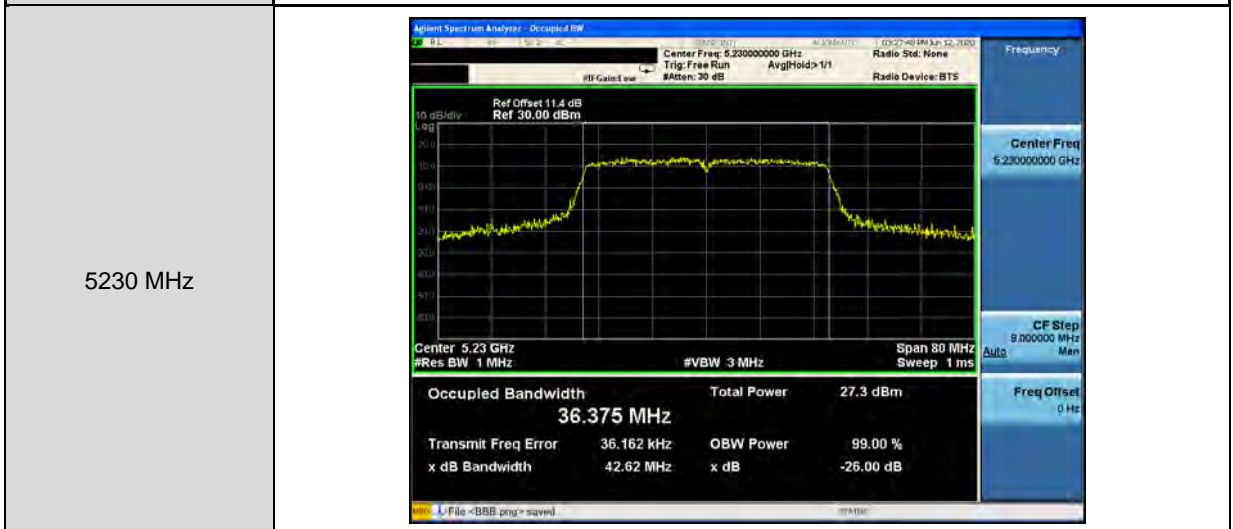
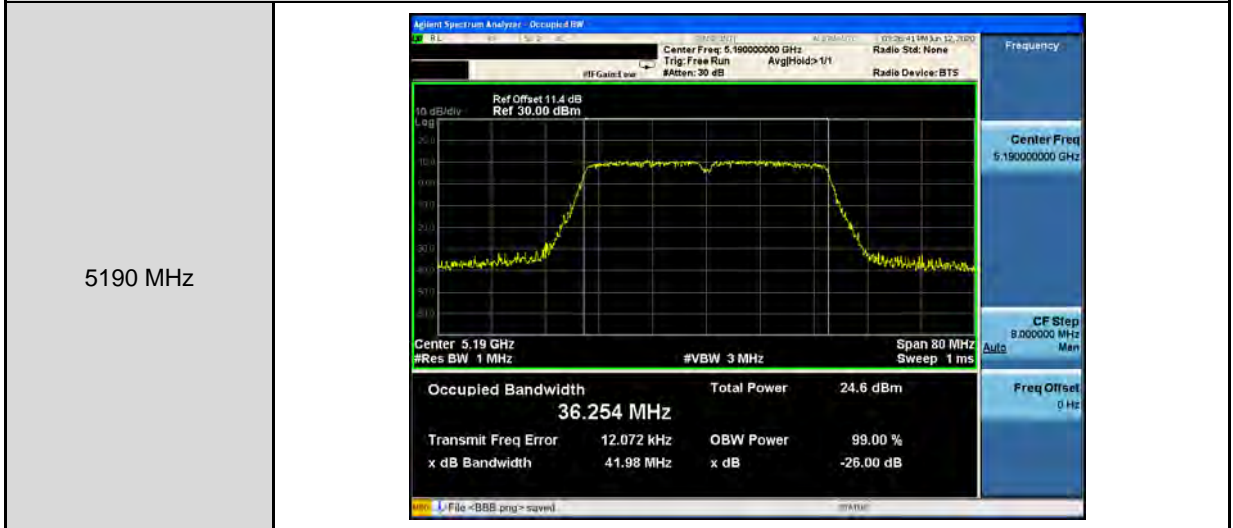

Mode 5: IEEE 802.11ac 80 MHz Continuous TX mode_ ANT-0





Mode 6: IEEE 802.11ax 20 MHz Continuous TX mode_ANT-0	
5180 MHz	<p>Agilent Spectrum Analyzer - Occupied BW</p> <p>Center Freq: 5.180000000 GHz Trig: Free Run #Attens: 30 dB Avg/Hold: 1/1 Radio Std: None Radio Device: BTS</p> <p>Ref Offset 11.4 dB Ref 30.00 dBm</p> <p>Center 5.18 GHz #Res BW 300 kHz #VBW 1 MHz Span 40 MHz Sweep 1 ms</p> <p>Occupied Bandwidth 18.929 MHz Total Power 25.6 dBm Transmit Freq Error 28.406 kHz x dB Bandwidth 21.23 MHz OBW Power 99.00 % x dB -26.00 dB</p> <p>Center Freq 5.180000000 GHz CF Step 4.000000 MHz Freq Offset 0 Hz</p>
5200 MHz	<p>Agilent Spectrum Analyzer - Occupied BW</p> <p>Center Freq: 5.200000000 GHz Trig: Free Run #Attens: 30 dB Avg/Hold: 1/1 Radio Std: None Radio Device: BTS</p> <p>Ref Offset 11.4 dB Ref 30.00 dBm</p> <p>Center 5.2 GHz #Res BW 300 kHz #VBW 1 MHz Span 40 MHz Sweep 1 ms</p> <p>Occupied Bandwidth 18.991 MHz Total Power 26.9 dBm Transmit Freq Error -6.221 kHz x dB Bandwidth 21.54 MHz OBW Power 99.00 % x dB -26.00 dB</p> <p>Center Freq 5.200000000 GHz CF Step 4.000000 MHz Freq Offset 0 Hz</p>
5240 MHz	<p>Agilent Spectrum Analyzer - Occupied BW</p> <p>Center Freq: 5.240000000 GHz Trig: Free Run #Attens: 30 dB Avg/Hold: 1/1 Radio Std: None Radio Device: BTS</p> <p>Ref Offset 11.4 dB Ref 30.00 dBm</p> <p>Center 5.24 GHz #Res BW 300 kHz #VBW 1 MHz Span 40 MHz Sweep 1 ms</p> <p>Occupied Bandwidth 19.000 MHz Total Power 26.9 dBm Transmit Freq Error 636 Hz x dB Bandwidth 22.15 MHz OBW Power 99.00 % x dB -26.00 dB</p> <p>Center Freq 5.240000000 GHz CF Step 4.000000 MHz Freq Offset 0 Hz</p>



Mode 7: IEEE 802.11ax 40 MHz Continuous TX mode_ ANT-0

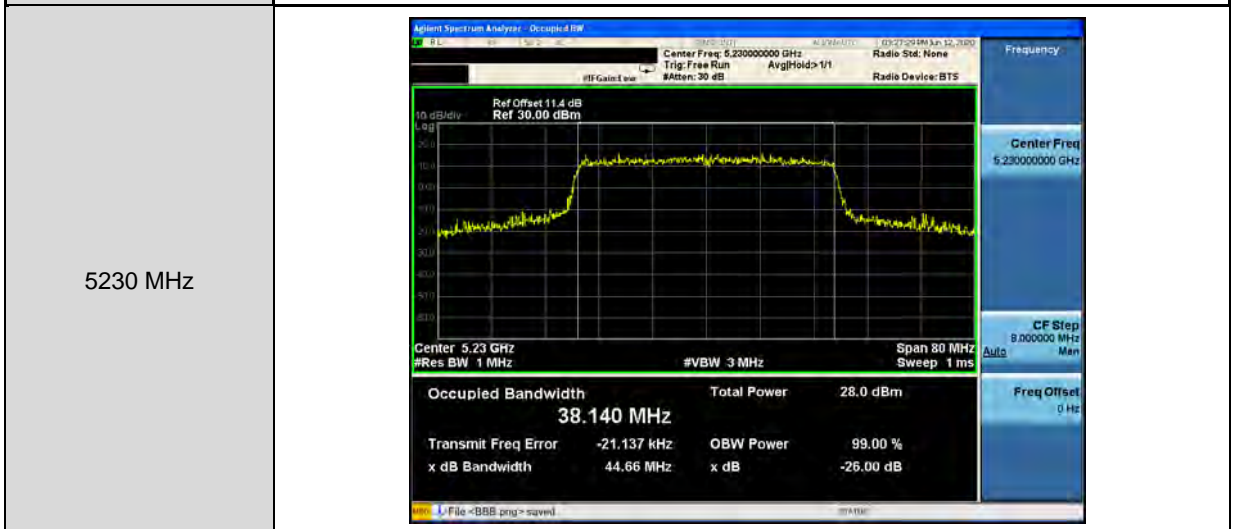
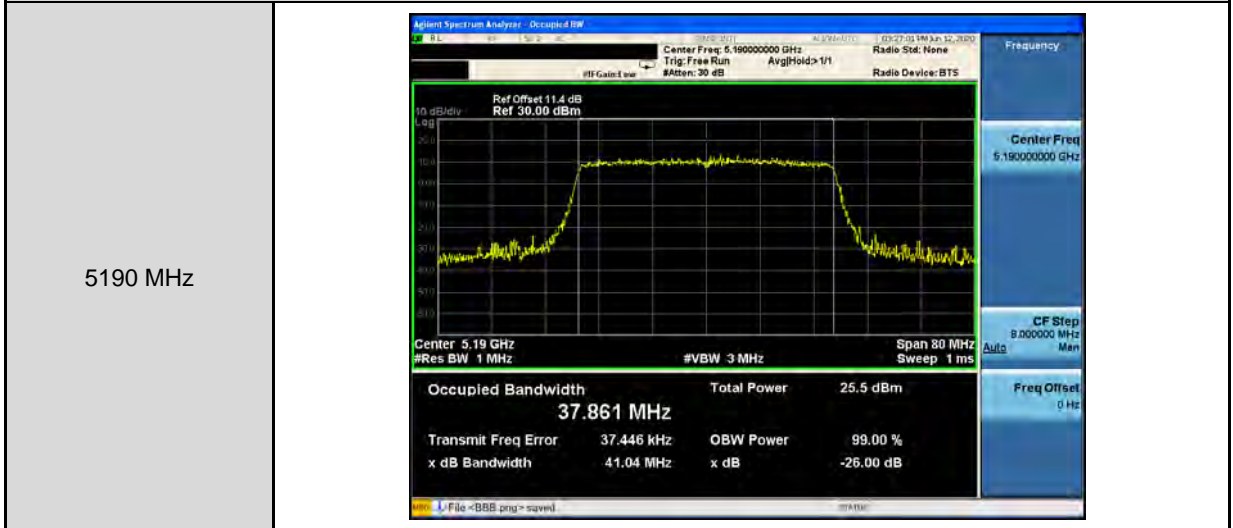

Mode 8: IEEE 802.11ax 80 MHz Continuous TX mode_ ANT-0

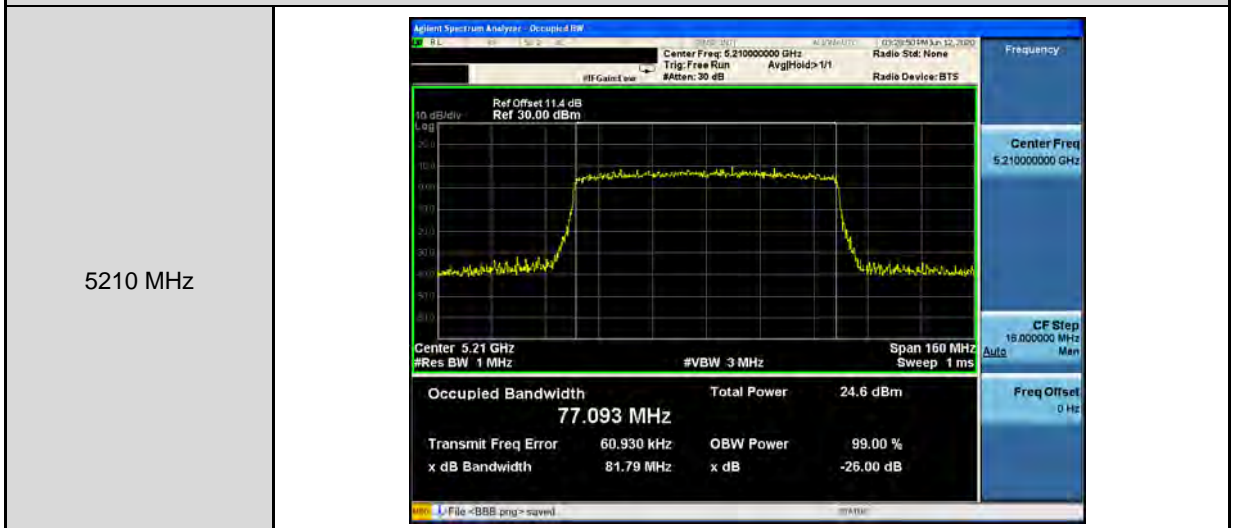



Mode 2: IEEE 802.11a Continuous TX mode_ ANT-1	
5180 MHz	<p>Agilent Spectrum Analyzer - Occupied BW</p> <p>Center Freq: 5.180000000 GHz Trig: Free Run #Attens: 30 dB Avg/Hold: 1/1 Radio Std: None Radio Device: BTS</p> <p>Ref Offset 11.4 dB Ref 30.00 dBm</p> <p>Center 5.18 GHz #Res BW 300 kHz #VBW 1 MHz Span 40 MHz Sweep 1 ms</p> <p>Occupied Bandwidth: 16.475 MHz Total Power: 23.5 dBm Transmit Freq Error: -15.177 kHz OBW Power: 99.00 % x dB Bandwidth: 19.62 MHz x dB: -26.00 dB</p> <p>Center Freq: 5.180000000 GHz CF Step: 4.000000 MHz Freq Offset: 0 Hz</p>
5200 MHz	<p>Agilent Spectrum Analyzer - Occupied BW</p> <p>Center Freq: 5.200000000 GHz Trig: Free Run #Attens: 30 dB Avg/Hold: 1/1 Radio Std: None Radio Device: BTS</p> <p>Ref Offset 11.4 dB Ref 30.00 dBm</p> <p>Center 5.2 GHz #Res BW 300 kHz #VBW 1 MHz Span 40 MHz Sweep 1 ms</p> <p>Occupied Bandwidth: 16.467 MHz Total Power: 23.2 dBm Transmit Freq Error: -17.669 kHz OBW Power: 99.00 % x dB Bandwidth: 19.31 MHz x dB: -26.00 dB</p> <p>Center Freq: 5.200000000 GHz CF Step: 4.000000 MHz Freq Offset: 0 Hz</p>
5240 MHz	<p>Agilent Spectrum Analyzer - Occupied BW</p> <p>Center Freq: 5.240000000 GHz Trig: Free Run #Attens: 30 dB Avg/Hold: 1/1 Radio Std: None Radio Device: BTS</p> <p>Ref Offset 11.4 dB Ref 30.00 dBm</p> <p>Center 5.24 GHz #Res BW 300 kHz #VBW 1 MHz Span 40 MHz Sweep 1 ms</p> <p>Occupied Bandwidth: 16.425 MHz Total Power: 23.1 dBm Transmit Freq Error: 2.237 kHz OBW Power: 99.00 % x dB Bandwidth: 19.40 MHz x dB: -26.00 dB</p> <p>Center Freq: 5.240000000 GHz CF Step: 4.000000 MHz Freq Offset: 0 Hz</p>



Mode 3: IEEE 802.11ac 20 MHz Continuous TX mode_ANT-1	
5180 MHz	<p>Agilent Spectrum Analyzer - Occupied BW</p> <p>Center Freq: 5.180000000 GHz Trig: Free Run #Att: 30 dB Avg/Hold: 1/1 Radio Std: None Radio Device: BTS</p> <p>Ref Offset 11.4 dB Ref 30.00 dBm</p> <p>Center 5.18 GHz #Res BW 300 kHz #VBW 1 MHz Span 40 MHz Sweep 1 ms</p> <p>Occupied Bandwidth: 17.653 MHz Total Power: 25.0 dBm Transmit Freq Error: 4.649 kHz OBW Power: 99.00 % x dB Bandwidth: 21.12 MHz x dB: -26.00 dB</p> <p>Center Freq: 5.180000000 GHz CF Step: 4.000000 MHz Man Freq Offset: 0 Hz</p> <p>File > BBS.png > saved</p>
5200 MHz	<p>Agilent Spectrum Analyzer - Occupied BW</p> <p>Center Freq: 5.200000000 GHz Trig: Free Run #Att: 30 dB Avg/Hold: 1/1 Radio Std: None Radio Device: BTS</p> <p>Ref Offset 11.4 dB Ref 30.00 dBm</p> <p>Center 5.2 GHz #Res BW 300 kHz #VBW 1 MHz Span 40 MHz Sweep 1 ms</p> <p>Occupied Bandwidth: 17.740 MHz Total Power: 25.8 dBm Transmit Freq Error: -2.030 kHz OBW Power: 99.00 % x dB Bandwidth: 22.73 MHz x dB: -26.00 dB</p> <p>Center Freq: 5.200000000 GHz CF Step: 4.000000 MHz Man Freq Offset: 0 Hz</p> <p>File > BBS.png > saved</p>
5240 MHz	<p>Agilent Spectrum Analyzer - Occupied BW</p> <p>Center Freq: 5.240000000 GHz Trig: Free Run #Att: 30 dB Avg/Hold: 1/1 Radio Std: None Radio Device: BTS</p> <p>Ref Offset 11.4 dB Ref 30.00 dBm</p> <p>Center 5.24 GHz #Res BW 300 kHz #VBW 1 MHz Span 40 MHz Sweep 1 ms</p> <p>Occupied Bandwidth: 17.720 MHz Total Power: 25.6 dBm Transmit Freq Error: 2.539 kHz OBW Power: 99.00 % x dB Bandwidth: 22.56 MHz x dB: -26.00 dB</p> <p>Center Freq: 5.240000000 GHz CF Step: 4.000000 MHz Man Freq Offset: 0 Hz</p> <p>File > BBS.png > saved</p>



Mode 4: IEEE 802.11ac 40 MHz Continuous TX mode_ ANT-1

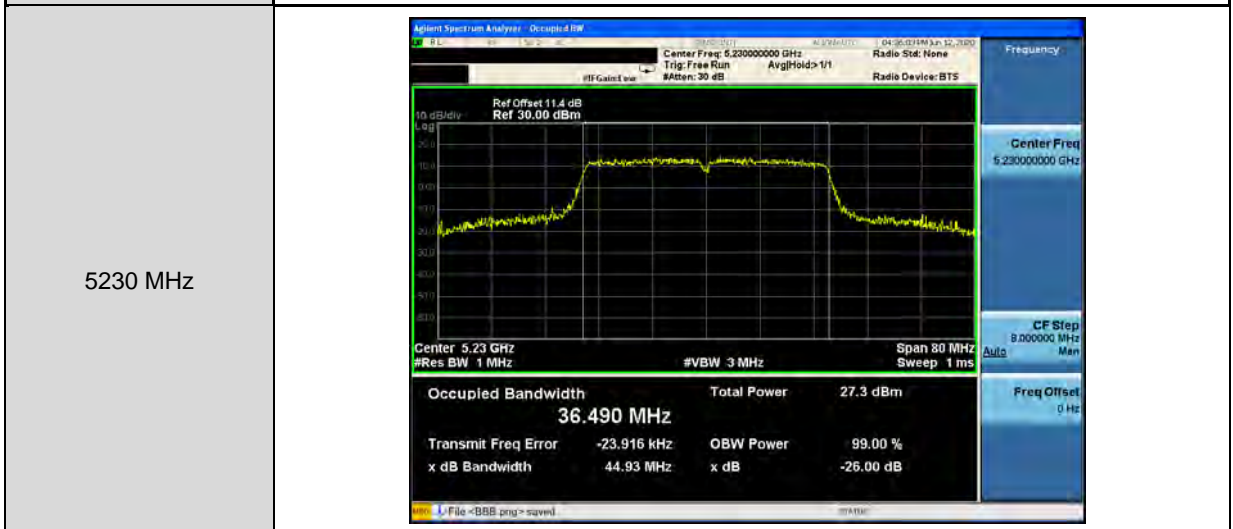
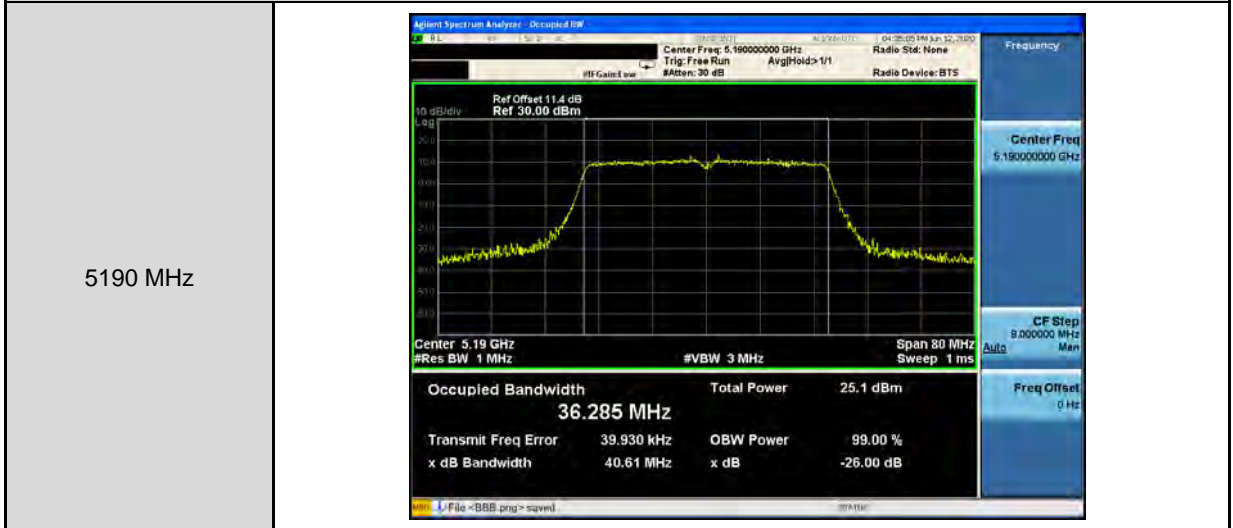

Mode 5: IEEE 802.11ac 80 MHz Continuous TX mode_ ANT-1

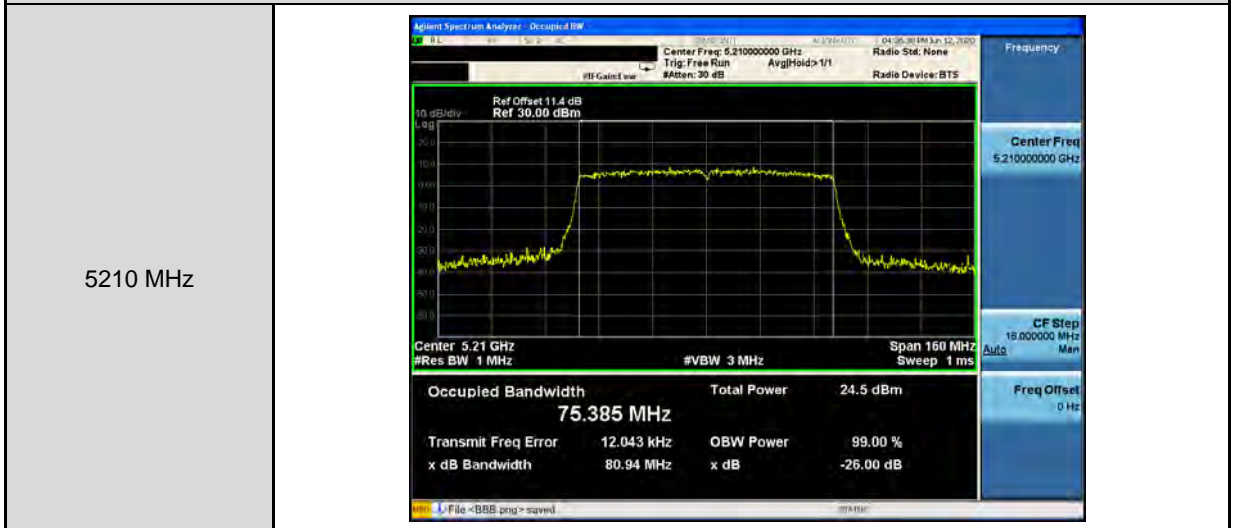



Mode 6: IEEE 802.11ax 20 MHz Continuous TX mode_ ANT-1	
5180 MHz	<p>Agilent Spectrum Analyzer - Occupied BW</p> <p>Center Freq: 5.180000000 GHz Trig: Free Run #Attens: 30 dB Avg/Hold: 1/1 Radio Std: None Radio Device: BTS</p> <p>Ref Offset 11.4 dB Ref 30.00 dBm</p> <p>Center 5.18 GHz #Res BW 300 kHz #VBW 1 MHz Span 40 MHz Sweep 1 ms</p> <p>Occupied Bandwidth 18.977 MHz Total Power 25.6 dBm Transmit Freq Error 24.953 kHz x dB Bandwidth 21.45 MHz OBW Power 99.00 % x dB -26.00 dB</p> <p>Center Freq 5.180000000 GHz CF Step 4.000000 MHz Man Freq Offset 0 Hz</p> <p>File > BBS.png > saved</p>
5200 MHz	<p>Agilent Spectrum Analyzer - Occupied BW</p> <p>Center Freq: 5.200000000 GHz Trig: Free Run #Attens: 30 dB Avg/Hold: 1/1 Radio Std: None Radio Device: BTS</p> <p>Ref Offset 11.4 dB Ref 30.00 dBm</p> <p>Center 5.2 GHz #Res BW 300 kHz #VBW 1 MHz Span 40 MHz Sweep 1 ms</p> <p>Occupied Bandwidth 19.055 MHz Total Power 26.6 dBm Transmit Freq Error 14.001 kHz x dB Bandwidth 22.42 MHz OBW Power 99.00 % x dB -26.00 dB</p> <p>Center Freq 5.200000000 GHz CF Step 4.000000 MHz Man Freq Offset 0 Hz</p> <p>File > BBS.png > saved</p>
5240 MHz	<p>Agilent Spectrum Analyzer - Occupied BW</p> <p>Center Freq: 5.240000000 GHz Trig: Free Run #Attens: 30 dB Avg/Hold: 1/1 Radio Std: None Radio Device: BTS</p> <p>Ref Offset 11.4 dB Ref 30.00 dBm</p> <p>Center 5.24 GHz #Res BW 300 kHz #VBW 1 MHz Span 40 MHz Sweep 1 ms</p> <p>Occupied Bandwidth 19.027 MHz Total Power 26.8 dBm Transmit Freq Error -9.027 kHz x dB Bandwidth 22.57 MHz OBW Power 99.00 % x dB -26.00 dB</p> <p>Center Freq 5.240000000 GHz CF Step 4.000000 MHz Man Freq Offset 0 Hz</p> <p>File > BBS.png > saved</p>



Mode 7: IEEE 802.11ax 40 MHz Continuous TX mode_ ANT-1

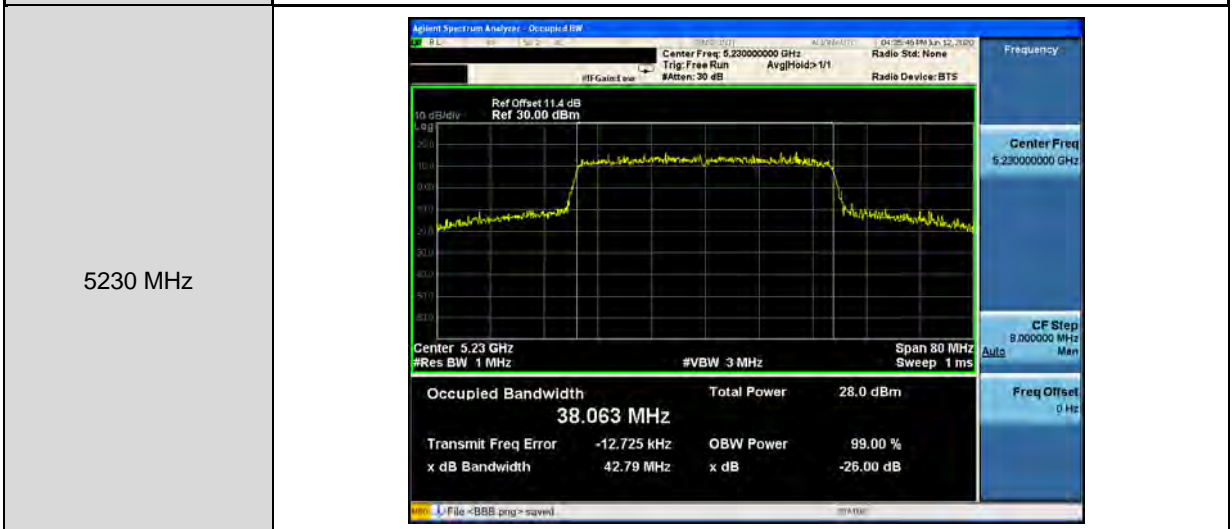
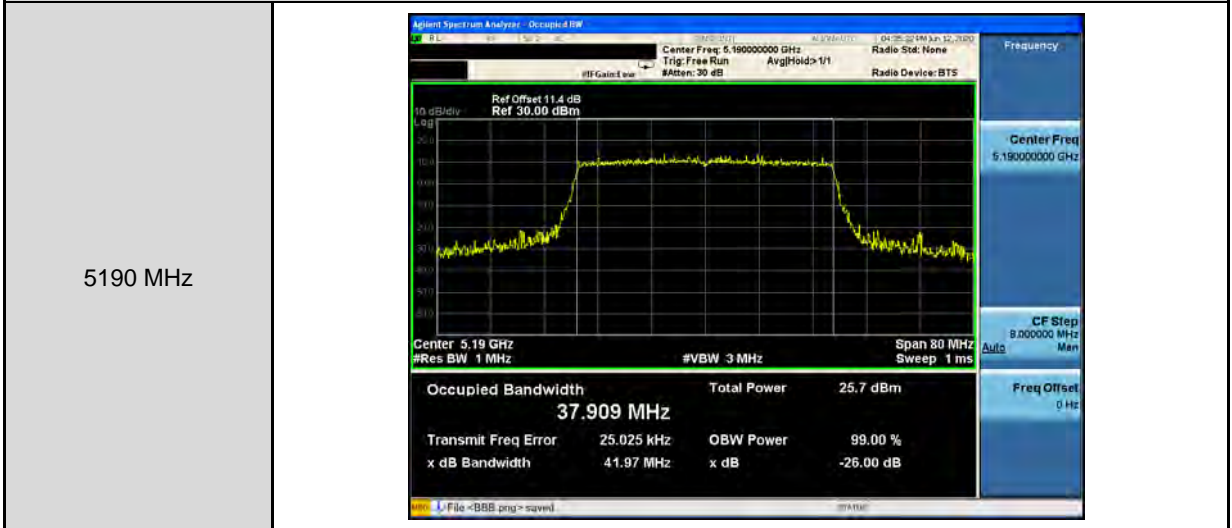

Mode 8: IEEE 802.11ax 80 MHz Continuous TX mode_ ANT-1

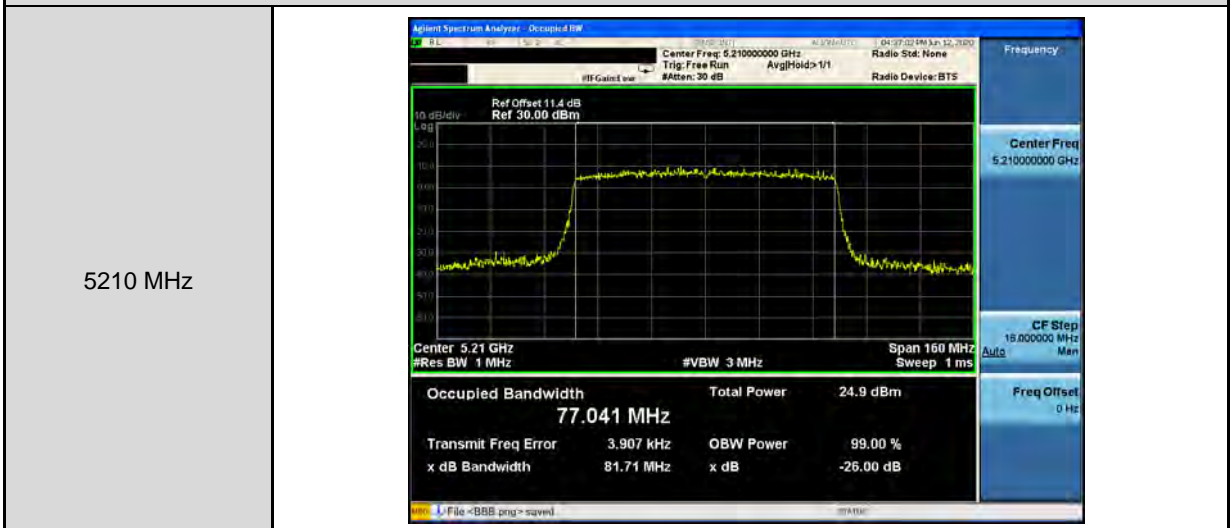



Mode 2: IEEE 802.11a Continuous TX mode_ ANT-2	
5180 MHz	<p>Agilent Spectrum Analyzer - Occupied BW</p> <p>Center Freq: 5.180000000 GHz Trig: Free Run Avg/Hold: 1/1 Radio Std: None Radio Device: BTS</p> <p>Ref Offset 11.4 dB Ref 30.00 dBm</p> <p>Center 5.18 GHz #Res BW 300 kHz #VBW 1 MHz Span 40 MHz Sweep 1 ms</p> <p>Occupied Bandwidth: 16.447 MHz Total Power: 24.0 dBm Transmit Freq Error: 4.902 kHz OBW Power: 99.00 % x dB Bandwidth: 19.19 MHz x dB: -26.00 dB</p>
5200 MHz	<p>Agilent Spectrum Analyzer - Occupied BW</p> <p>Center Freq: 5.200000000 GHz Trig: Free Run Avg/Hold: 1/1 Radio Std: None Radio Device: BTS</p> <p>Ref Offset 11.4 dB Ref 30.00 dBm</p> <p>Center 5.2 GHz #Res BW 300 kHz #VBW 1 MHz Span 40 MHz Sweep 1 ms</p> <p>Occupied Bandwidth: 16.467 MHz Total Power: 23.4 dBm Transmit Freq Error: -1.465 kHz OBW Power: 99.00 % x dB Bandwidth: 19.28 MHz x dB: -26.00 dB</p>
5240 MHz	<p>Agilent Spectrum Analyzer - Occupied BW</p> <p>Center Freq: 5.240000000 GHz Trig: Free Run Avg/Hold: 1/1 Radio Std: None Radio Device: BTS</p> <p>Ref Offset 11.4 dB Ref 30.00 dBm</p> <p>Center 5.24 GHz #Res BW 300 kHz #VBW 1 MHz Span 40 MHz Sweep 1 ms</p> <p>Occupied Bandwidth: 16.482 MHz Total Power: 23.3 dBm Transmit Freq Error: -2.889 kHz OBW Power: 99.00 % x dB Bandwidth: 19.28 MHz x dB: -26.00 dB</p>



Mode 3: IEEE 802.11ac 20 MHz Continuous TX mode_ANT-2	
5180 MHz	<p>Agilent Spectrum Analyzer - Occupied BW</p> <p>Center Freq: 5.180000000 GHz Trig: Free Run #Att: 30 dB</p> <p>Radio Std: None Radio Device: BTS</p> <p>Ref Offset 11.4 dB Ref 30.00 dBm</p> <p>Center 5.18 GHz #Res BW 300 kHz #VBW 1 MHz Span 40 MHz Sweep 1 ms</p> <p>Occupied Bandwidth: 17.651 MHz Total Power: 25.6 dBm Transmit Freq Error: 6.227 kHz x dB Bandwidth: 21.46 MHz OBW Power: 99.00 % x dB: -26.00 dB</p>
5200 MHz	<p>Agilent Spectrum Analyzer - Occupied BW</p> <p>Center Freq: 5.200000000 GHz Trig: Free Run #Att: 30 dB</p> <p>Radio Std: None Radio Device: BTS</p> <p>Ref Offset 11.4 dB Ref 30.00 dBm</p> <p>Center 5.2 GHz #Res BW 300 kHz #VBW 1 MHz Span 40 MHz Sweep 1 ms</p> <p>Occupied Bandwidth: 17.715 MHz Total Power: 25.7 dBm Transmit Freq Error: 16.962 kHz x dB Bandwidth: 23.89 MHz OBW Power: 99.00 % x dB: -26.00 dB</p>
5240 MHz	<p>Agilent Spectrum Analyzer - Occupied BW</p> <p>Center Freq: 5.240000000 GHz Trig: Free Run #Att: 30 dB</p> <p>Radio Std: None Radio Device: BTS</p> <p>Ref Offset 11.4 dB Ref 30.00 dBm</p> <p>Center 5.24 GHz #Res BW 300 kHz #VBW 1 MHz Span 40 MHz Sweep 1 ms</p> <p>Occupied Bandwidth: 17.700 MHz Total Power: 25.5 dBm Transmit Freq Error: 719 Hz x dB Bandwidth: 22.03 MHz OBW Power: 99.00 % x dB: -26.00 dB</p>

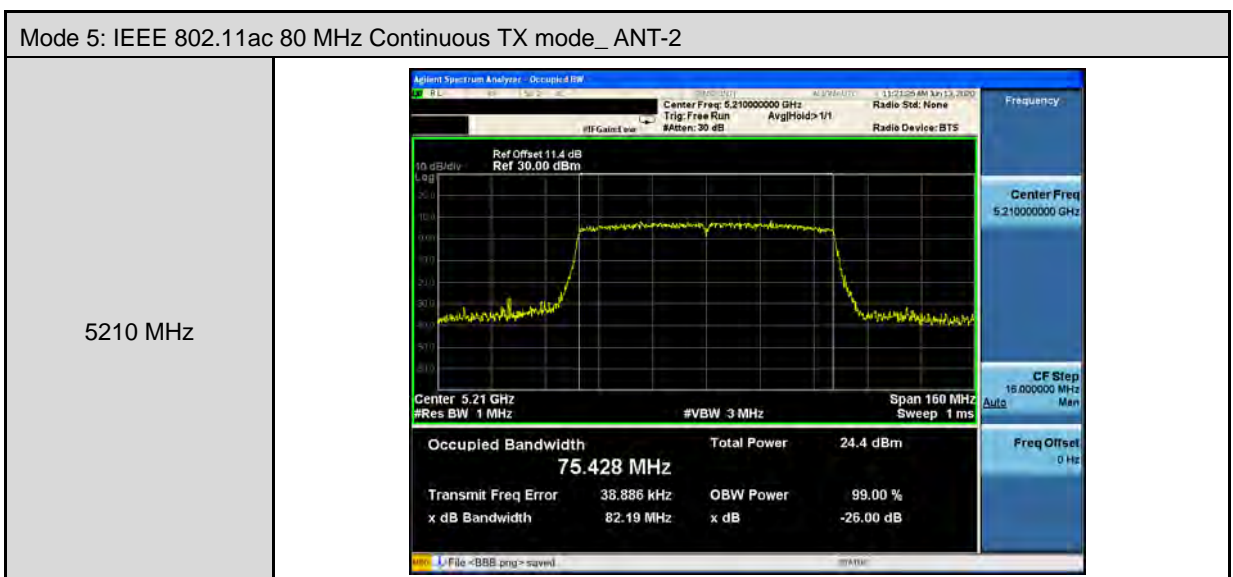
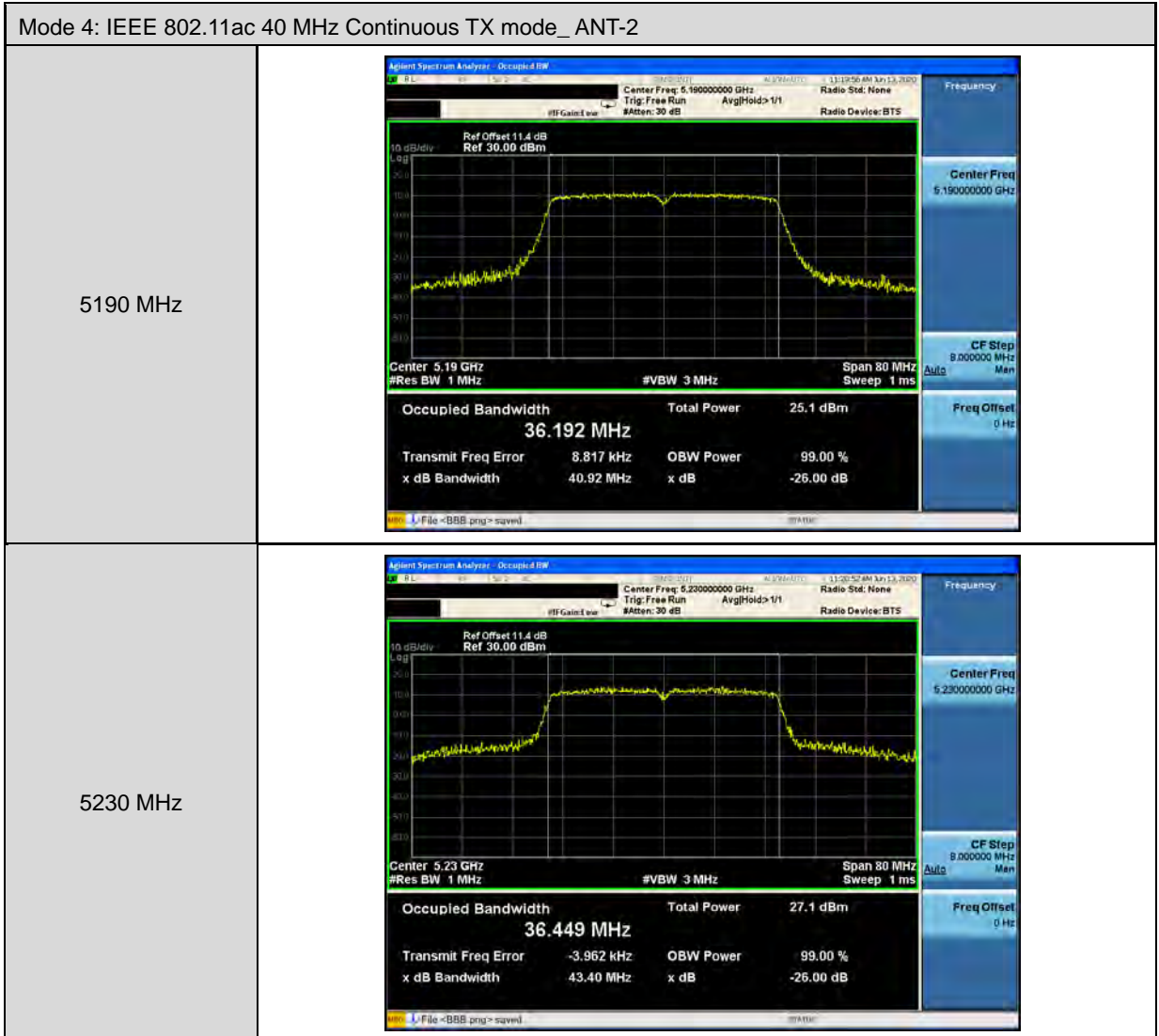



Mode 6: IEEE 802.11ax 20 MHz Continuous TX mode_ANT-2	
5180 MHz	<p>Agilent Spectrum Analyzer - Occupied BW</p> <p>Center Freq: 5.180000000 GHz Trig: Free Run #Atten: 30 dB Avg/Hold: 1/1 Radio Std: None Radio Device: BTS</p> <p>Ref Offset 11.4 dB Ref 30.00 dBm</p> <p>Center 5.18 GHz #Res BW 300 kHz #VBW 1 MHz Span 40 MHz Sweep 1 ms</p> <p>Occupied Bandwidth: 18.973 MHz Total Power: 26.1 dBm Transmit Freq Error: -1.262 kHz x dB Bandwidth: 21.51 MHz OBW Power: 99.00 % x dB: -26.00 dB</p>
5200 MHz	<p>Agilent Spectrum Analyzer - Occupied BW</p> <p>Center Freq: 5.200000000 GHz Trig: Free Run #Atten: 30 dB Avg/Hold: 1/1 Radio Std: None Radio Device: BTS</p> <p>Ref Offset 11.4 dB Ref 30.00 dBm</p> <p>Center 5.2 GHz #Res BW 300 kHz #VBW 1 MHz Span 40 MHz Sweep 1 ms</p> <p>Occupied Bandwidth: 19.010 MHz Total Power: 26.7 dBm Transmit Freq Error: 11.040 kHz x dB Bandwidth: 21.78 MHz OBW Power: 99.00 % x dB: -26.00 dB</p>
5240 MHz	<p>Agilent Spectrum Analyzer - Occupied BW</p> <p>Center Freq: 5.240000000 GHz Trig: Free Run #Atten: 30 dB Avg/Hold: 1/1 Radio Std: None Radio Device: BTS</p> <p>Ref Offset 11.4 dB Ref 30.00 dBm</p> <p>Center 5.24 GHz #Res BW 300 kHz #VBW 1 MHz Span 40 MHz Sweep 1 ms</p> <p>Occupied Bandwidth: 19.076 MHz Total Power: 26.4 dBm Transmit Freq Error: 3.318 kHz x dB Bandwidth: 23.64 MHz OBW Power: 99.00 % x dB: -26.00 dB</p>

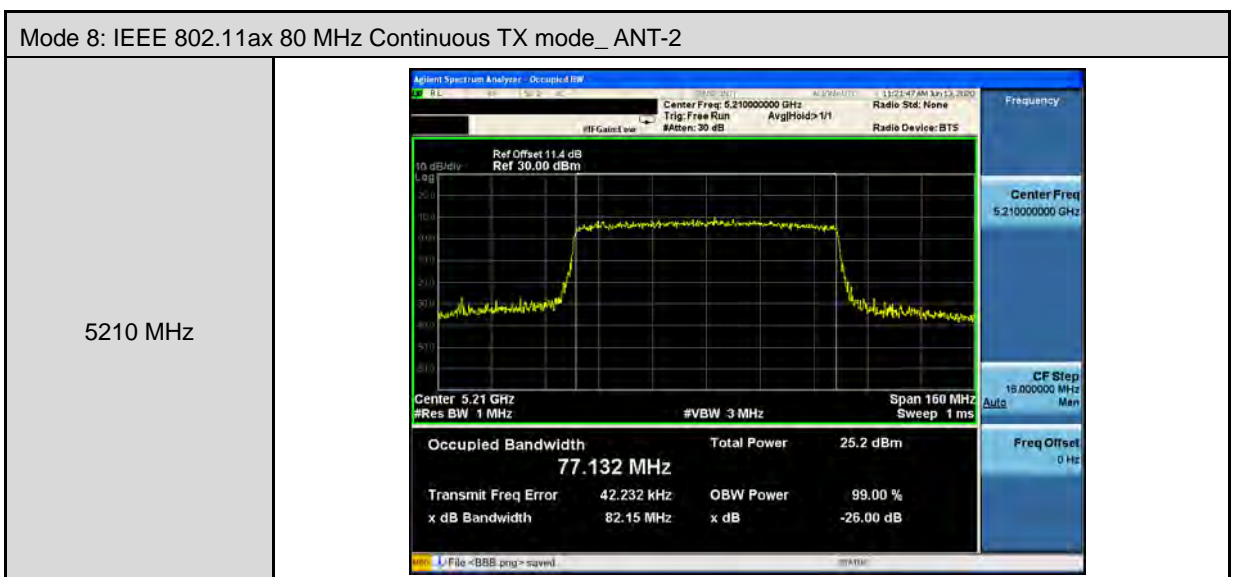
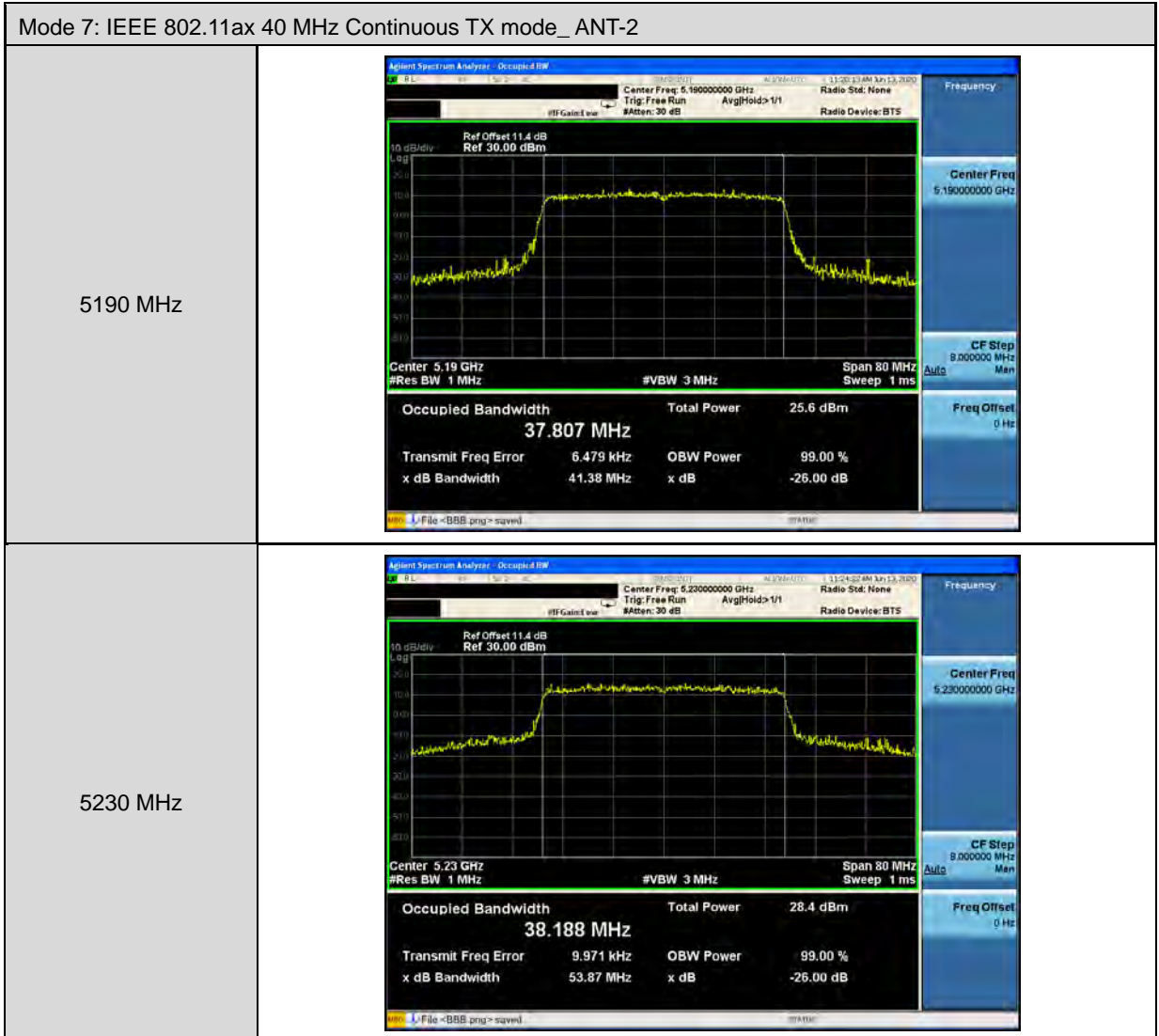



Mode 2: IEEE 802.11a Continuous TX mode_ ANT-3	
5180 MHz	<p>Agilent Spectrum Analyzer - Occupied BW</p> <p>Center Freq: 5.180000000 GHz Trig: Free Run #Atten: 30 dB Avg/Hold: 1/1 Radio Std: None Radio Device: BTS</p> <p>Ref Offset 11.4 dB Ref 30.00 dBm</p> <p>Center 5.18 GHz #Res BW 300 kHz #VBW 1 MHz Span 40 MHz Sweep 1 ms</p> <p>Occupied Bandwidth 16.440 MHz Total Power 23.2 dBm Transmit Freq Error -13.888 kHz OBW Power 99.00 % x dB Bandwidth 19.18 MHz x dB -26.00 dB</p> <p>Center Freq 5.180000000 GHz CF Step 4.000000 MHz Man Freq Offset 0 Hz</p> <p>File > BBS.png > save</p>
5200 MHz	<p>Agilent Spectrum Analyzer - Occupied BW</p> <p>Center Freq: 5.200000000 GHz Trig: Free Run #Atten: 30 dB Avg/Hold: 1/1 Radio Std: None Radio Device: BTS</p> <p>Ref Offset 11.4 dB Ref 30.00 dBm</p> <p>Center 5.2 GHz #Res BW 300 kHz #VBW 1 MHz Span 40 MHz Sweep 1 ms</p> <p>Occupied Bandwidth 16.446 MHz Total Power 23.4 dBm Transmit Freq Error 6.435 kHz OBW Power 99.00 % x dB Bandwidth 19.10 MHz x dB -26.00 dB</p> <p>Center Freq 5.200000000 GHz CF Step 4.000000 MHz Man Freq Offset 0 Hz</p> <p>File > BBS.png > save</p>
5240 MHz	<p>Agilent Spectrum Analyzer - Occupied BW</p> <p>Center Freq: 5.240000000 GHz Trig: Free Run #Atten: 30 dB Avg/Hold: 1/1 Radio Std: None Radio Device: BTS</p> <p>Ref Offset 11.4 dB Ref 30.00 dBm</p> <p>Center 5.24 GHz #Res BW 300 kHz #VBW 1 MHz Span 40 MHz Sweep 1 ms</p> <p>Occupied Bandwidth 16.446 MHz Total Power 23.1 dBm Transmit Freq Error -8.857 kHz OBW Power 99.00 % x dB Bandwidth 19.17 MHz x dB -26.00 dB</p> <p>Center Freq 5.240000000 GHz CF Step 4.000000 MHz Man Freq Offset 0 Hz</p> <p>File > BBS.png > save</p>



Mode 3: IEEE 802.11ac 20 MHz Continuous TX mode_ ANT-3	
5180 MHz	<p>Agilent Spectrum Analyzer - Occupied BW</p> <p>Center Freq: 5.180000000 GHz Trig: Free Run #Att: 30 dB Avg/Hold: 1/1 Radio Std: None Radio Device: BTS</p> <p>Ref Offset 11.4 dB Ref 30.00 dBm</p> <p>Center 5.18 GHz #Res BW 300 kHz #VBW 1 MHz Span 40 MHz Sweep 1 ms</p> <p>Occupied Bandwidth: 17.668 MHz Total Power: 25.0 dBm Transmit Freq Error: 9.996 kHz x dB Bandwidth: 21.20 MHz OBW Power: 99.00 % x dB: -26.00 dB</p> <p>Center Freq: 5.180000000 GHz CF Step: 4.000000 MHz Freq Offset: 0 Hz</p>
5200 MHz	<p>Agilent Spectrum Analyzer - Occupied BW</p> <p>Center Freq: 5.200000000 GHz Trig: Free Run #Att: 30 dB Avg/Hold: 1/1 Radio Std: None Radio Device: BTS</p> <p>Ref Offset 11.4 dB Ref 30.00 dBm</p> <p>Center 5.2 GHz #Res BW 300 kHz #VBW 1 MHz Span 40 MHz Sweep 1 ms</p> <p>Occupied Bandwidth: 17.727 MHz Total Power: 25.6 dBm Transmit Freq Error: 10.157 kHz x dB Bandwidth: 23.21 MHz OBW Power: 99.00 % x dB: -26.00 dB</p> <p>Center Freq: 5.200000000 GHz CF Step: 4.000000 MHz Freq Offset: 0 Hz</p>
5240 MHz	<p>Agilent Spectrum Analyzer - Occupied BW</p> <p>Center Freq: 5.240000000 GHz Trig: Free Run #Att: 30 dB Avg/Hold: 1/1 Radio Std: None Radio Device: BTS</p> <p>Ref Offset 11.4 dB Ref 30.00 dBm</p> <p>Center 5.24 GHz #Res BW 300 kHz #VBW 1 MHz Span 40 MHz Sweep 1 ms</p> <p>Occupied Bandwidth: 17.697 MHz Total Power: 25.3 dBm Transmit Freq Error: 5.842 kHz x dB Bandwidth: 21.95 MHz OBW Power: 99.00 % x dB: -26.00 dB</p> <p>Center Freq: 5.240000000 GHz CF Step: 4.000000 MHz Freq Offset: 0 Hz</p>



Mode 4: IEEE 802.11ac 40 MHz Continuous TX mode_ ANT-3

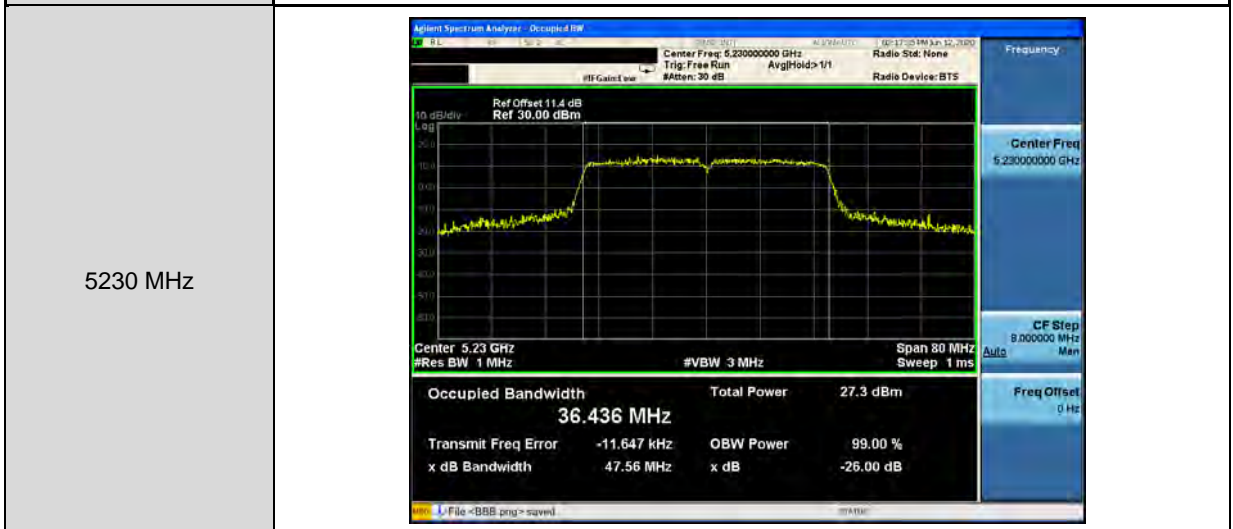
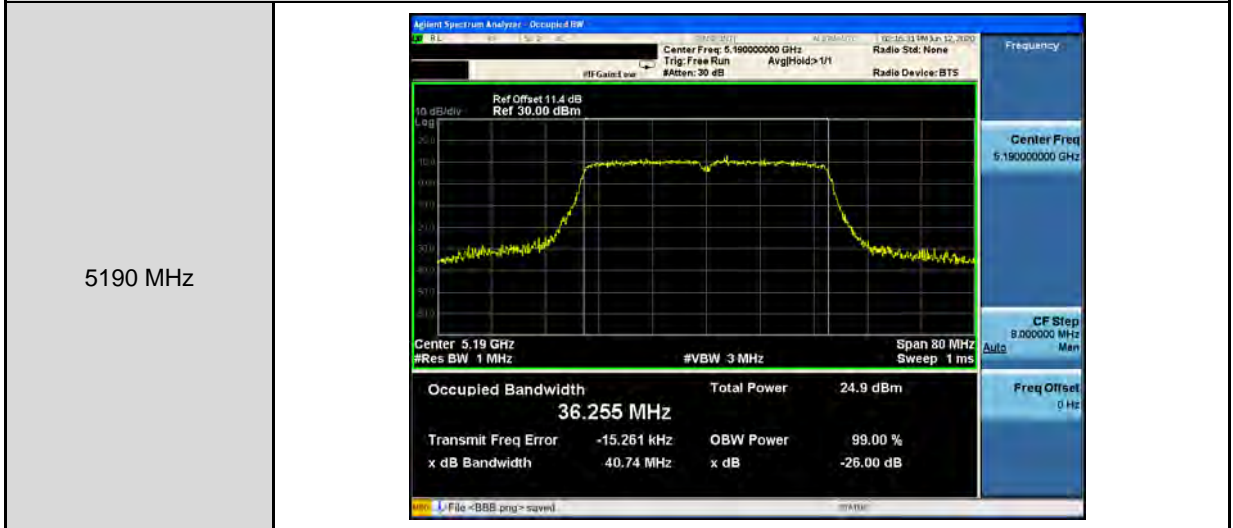

Mode 5: IEEE 802.11ac 80 MHz Continuous TX mode_ ANT-3

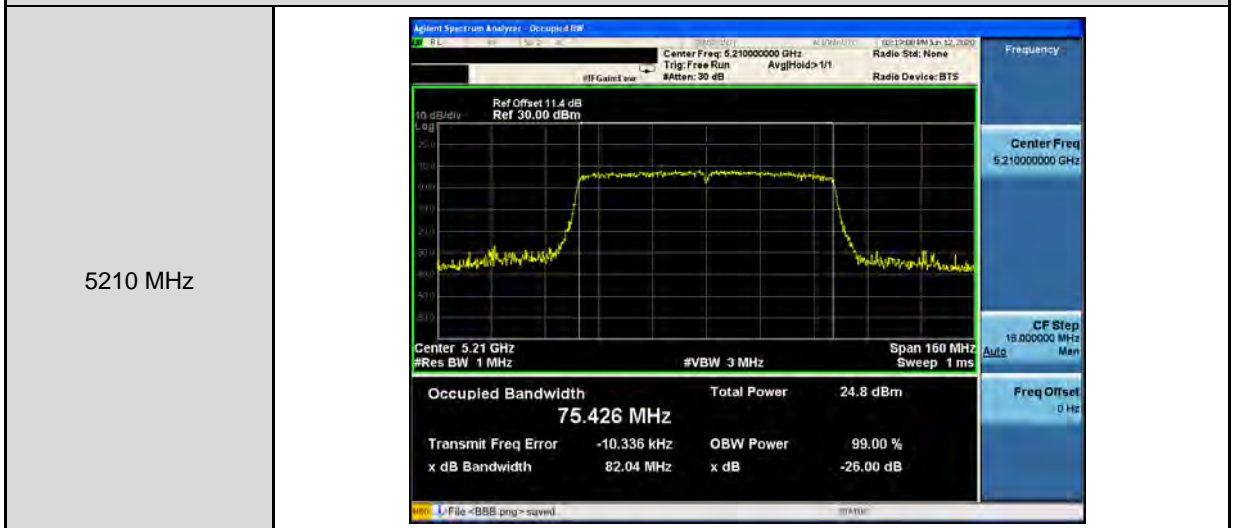



Mode 6: IEEE 802.11ax 20 MHz Continuous TX mode_ ANT-3	
5180 MHz	<p>Agilent Spectrum Analyzer - Occupied BW</p> <p>Center Freq: 5.180000000 GHz Trig: Free Run #Attens: 30 dB Avg/Hold: 1/1 Radio Std: None Radio Device: BTS</p> <p>Ref Offset 11.4 dB Ref 30.00 dBm</p> <p>Center 5.18 GHz #Res BW 300 kHz #VBW 1 MHz Span 40 MHz Sweep 1 ms</p> <p>Occupied Bandwidth 18.985 MHz Total Power 25.7 dBm Transmit Freq Error -339 Hz OBW Power 99.00 % x dB Bandwidth 21.10 MHz x dB -26.00 dB</p> <p>Center Freq 5.180000000 GHz CF Step 4.000000 MHz Man Freq Offset 0 Hz</p>
5200 MHz	<p>Agilent Spectrum Analyzer - Occupied BW</p> <p>Center Freq: 5.200000000 GHz Trig: Free Run #Attens: 30 dB Avg/Hold: 1/1 Radio Std: None Radio Device: BTS</p> <p>Ref Offset 11.4 dB Ref 30.00 dBm</p> <p>Center 5.2 GHz #Res BW 300 kHz #VBW 1 MHz Span 40 MHz Sweep 1 ms</p> <p>Occupied Bandwidth 19.048 MHz Total Power 26.6 dBm Transmit Freq Error 9.822 kHz OBW Power 99.00 % x dB Bandwidth 23.37 MHz x dB -26.00 dB</p> <p>Center Freq 5.200000000 GHz CF Step 4.000000 MHz Man Freq Offset 0 Hz</p>
5240 MHz	<p>Agilent Spectrum Analyzer - Occupied BW</p> <p>Center Freq: 5.240000000 GHz Trig: Free Run #Attens: 30 dB Avg/Hold: 1/1 Radio Std: None Radio Device: BTS</p> <p>Ref Offset 11.4 dB Ref 30.00 dBm</p> <p>Center 5.24 GHz #Res BW 300 kHz #VBW 1 MHz Span 40 MHz Sweep 1 ms</p> <p>Occupied Bandwidth 19.034 MHz Total Power 26.6 dBm Transmit Freq Error 25.856 kHz OBW Power 99.00 % x dB Bandwidth 21.74 MHz x dB -26.00 dB</p> <p>Center Freq 5.240000000 GHz CF Step 4.000000 MHz Man Freq Offset 0 Hz</p>

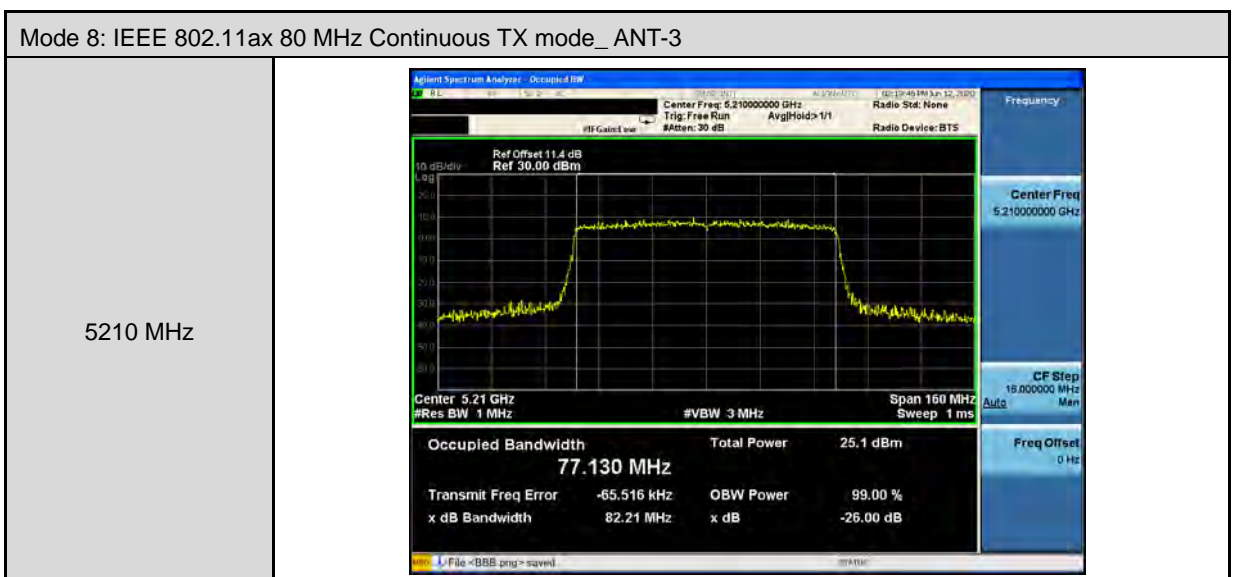



Beamforming on

Mode 3: IEEE 802.11ac 20 MHz Continuous TX mode_ ANT-0

5180 MHz	
5200 MHz	
5240 MHz	

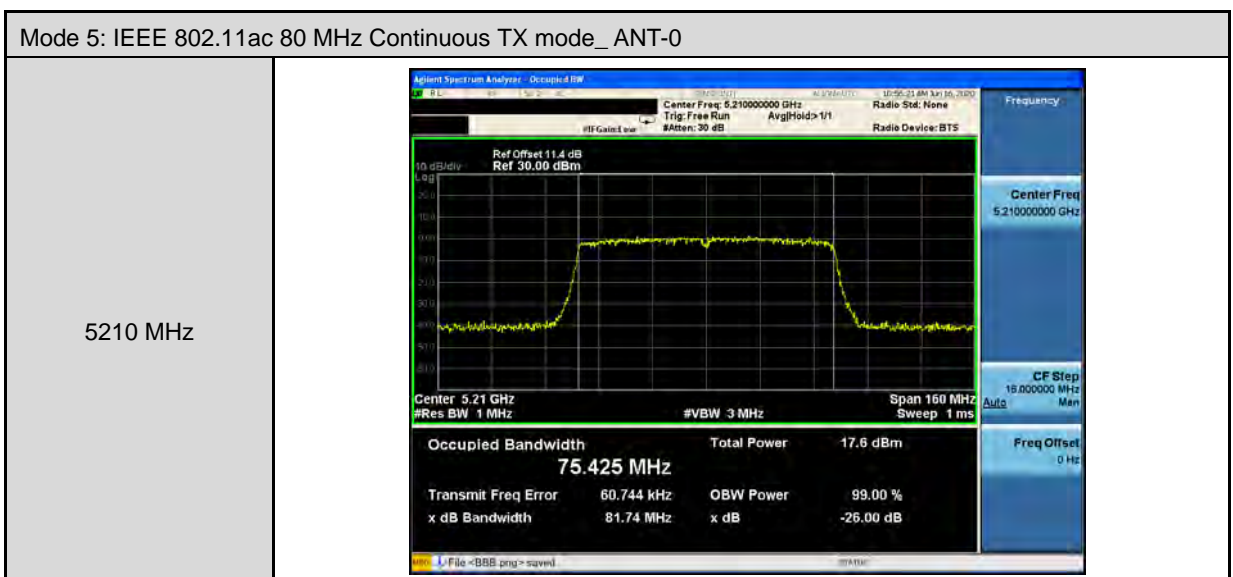
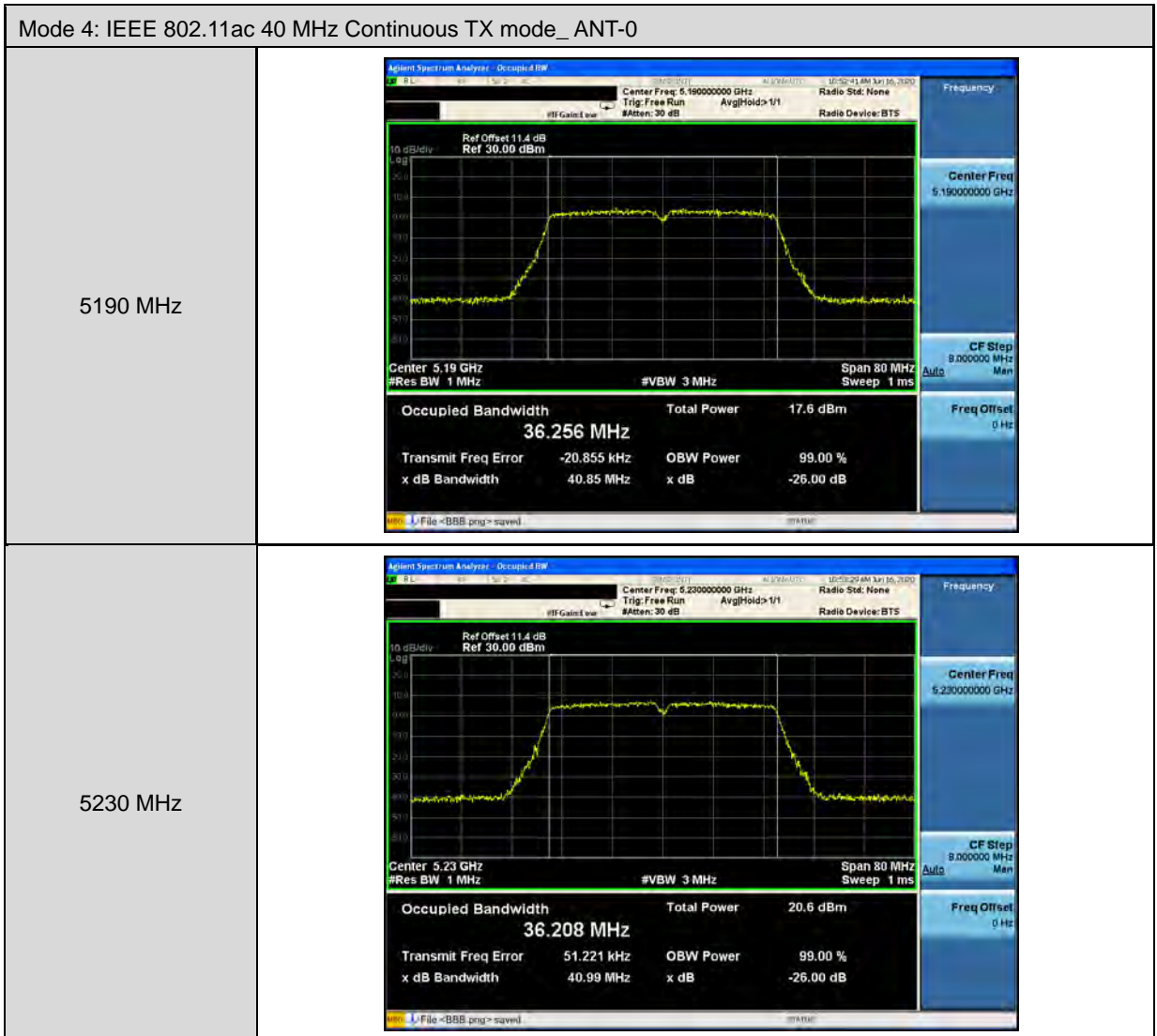



Mode 6: IEEE 802.11ax 20 MHz Continuous TX mode_ ANT-0	
5180 MHz	<p>Agilent Spectrum Analyzer - Occupied BW</p> <p>Center Freq: 5.180000000 GHz Trig: Free Run #Atten: 30 dB Avg/Hold: 1/1 Radio Std: None Radio Device: BTS</p> <p>Ref Offset 11.4 dB Ref 30.00 dBm</p> <p>Center 5.18 GHz #Res BW 300 kHz #VBW 1 MHz Span 40 MHz Sweep 1 ms</p> <p>Occupied Bandwidth: 18.985 MHz Total Power: 18.9 dBm Transmit Freq Error: 2.716 kHz OBW Power: 99.00 % x dB Bandwidth: 20.88 MHz x dB: -26.00 dB</p> <p>Center Freq: 5.180000000 GHz CF Step: 4.000000 MHz Freq Offset: 0 Hz</p>
5200 MHz	<p>Agilent Spectrum Analyzer - Occupied BW</p> <p>Center Freq: 5.200000000 GHz Trig: Free Run #Atten: 30 dB Avg/Hold: 1/1 Radio Std: None Radio Device: BTS</p> <p>Ref Offset 11.4 dB Ref 30.00 dBm</p> <p>Center 5.2 GHz #Res BW 300 kHz #VBW 1 MHz Span 40 MHz Sweep 1 ms</p> <p>Occupied Bandwidth: 18.958 MHz Total Power: 20.1 dBm Transmit Freq Error: -4.835 kHz OBW Power: 99.00 % x dB Bandwidth: 21.06 MHz x dB: -26.00 dB</p> <p>Center Freq: 5.200000000 GHz CF Step: 4.000000 MHz Freq Offset: 0 Hz</p>
5240 MHz	<p>Agilent Spectrum Analyzer - Occupied BW</p> <p>Center Freq: 5.240000000 GHz Trig: Free Run #Atten: 30 dB Avg/Hold: 1/1 Radio Std: None Radio Device: BTS</p> <p>Ref Offset 11.4 dB Ref 30.00 dBm</p> <p>Center 5.24 GHz #Res BW 300 kHz #VBW 1 MHz Span 40 MHz Sweep 1 ms</p> <p>Occupied Bandwidth: 18.975 MHz Total Power: 20.4 dBm Transmit Freq Error: 1.774 kHz OBW Power: 99.00 % x dB Bandwidth: 21.23 MHz x dB: -26.00 dB</p> <p>Center Freq: 5.240000000 GHz CF Step: 4.000000 MHz Freq Offset: 0 Hz</p>

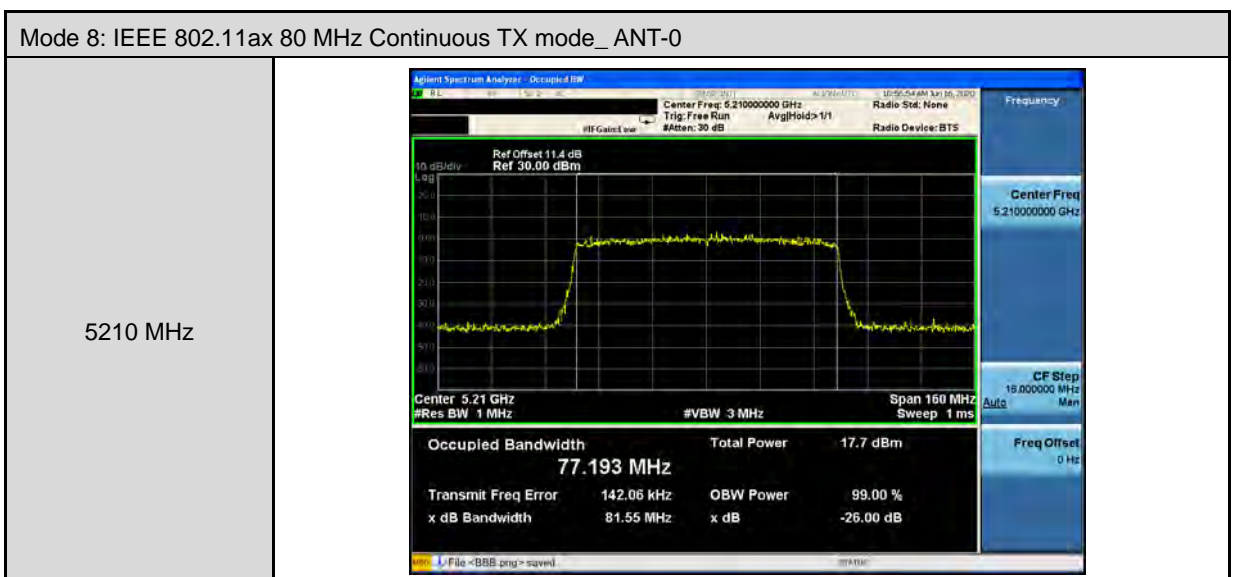
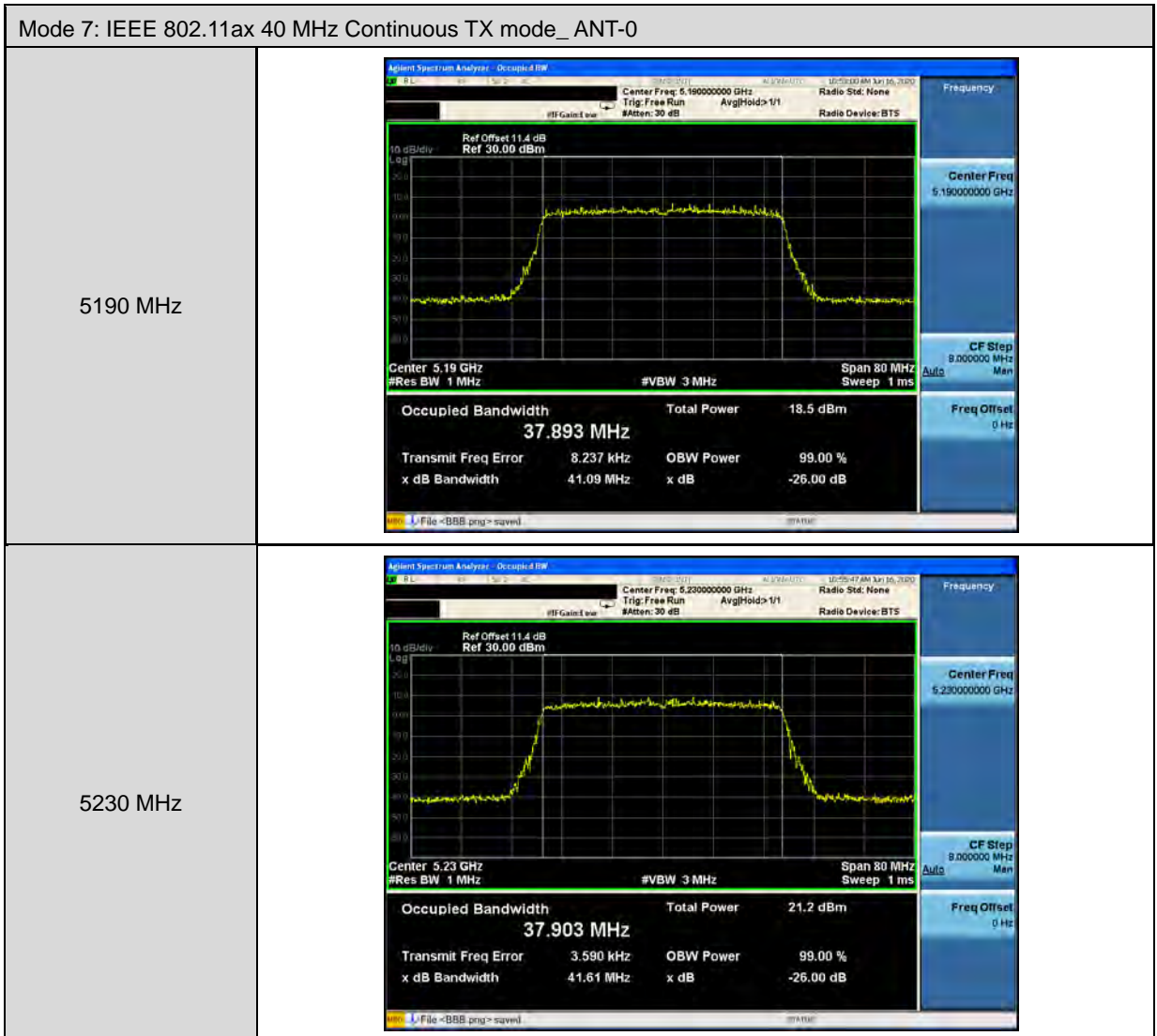



Mode 3: IEEE 802.11ac 20 MHz Continuous TX mode_ANT-1	
5180 MHz	<p>Agilent Spectrum Analyzer - Occupied BW</p> <p>Center Freq: 5.180000000 GHz Trig: Free Run #Attens: 30 dB Avg/Hold: 1/1 Radio Std: None Radio Device: BTS</p> <p>Ref Offset 11.4 dB Ref 30.00 dBm</p> <p>Center 5.18 GHz #Res BW 300 kHz #VBW 1 MHz Span 40 MHz Sweep 1 ms</p> <p>Occupied Bandwidth 17.600 MHz Total Power 19.0 dBm Transmit Freq Error 14.179 kHz OBW Power 99.00 % x dB Bandwidth 20.35 MHz x dB -26.00 dB</p> <p>Center Freq 5.180000000 GHz CF Step 4.000000 MHz Man Freq Offset 0 Hz</p>
5200 MHz	<p>Agilent Spectrum Analyzer - Occupied BW</p> <p>Center Freq: 5.200000000 GHz Trig: Free Run #Attens: 30 dB Avg/Hold: 1/1 Radio Std: None Radio Device: BTS</p> <p>Ref Offset 11.4 dB Ref 30.00 dBm</p> <p>Center 5.2 GHz #Res BW 300 kHz #VBW 1 MHz Span 40 MHz Sweep 1 ms</p> <p>Occupied Bandwidth 17.646 MHz Total Power 19.7 dBm Transmit Freq Error -501 Hz OBW Power 99.00 % x dB Bandwidth 20.52 MHz x dB -26.00 dB</p> <p>Center Freq 5.200000000 GHz CF Step 4.000000 MHz Man Freq Offset 0 Hz</p>
5240 MHz	<p>Agilent Spectrum Analyzer - Occupied BW</p> <p>Center Freq: 5.240000000 GHz Trig: Free Run #Attens: 30 dB Avg/Hold: 1/1 Radio Std: None Radio Device: BTS</p> <p>Ref Offset 11.4 dB Ref 30.00 dBm</p> <p>Center 5.24 GHz #Res BW 300 kHz #VBW 1 MHz Span 40 MHz Sweep 1 ms</p> <p>Occupied Bandwidth 17.669 MHz Total Power 19.7 dBm Transmit Freq Error -9.174 kHz OBW Power 99.00 % x dB Bandwidth 20.47 MHz x dB -26.00 dB</p> <p>Center Freq 5.240000000 GHz CF Step 4.000000 MHz Man Freq Offset 0 Hz</p>

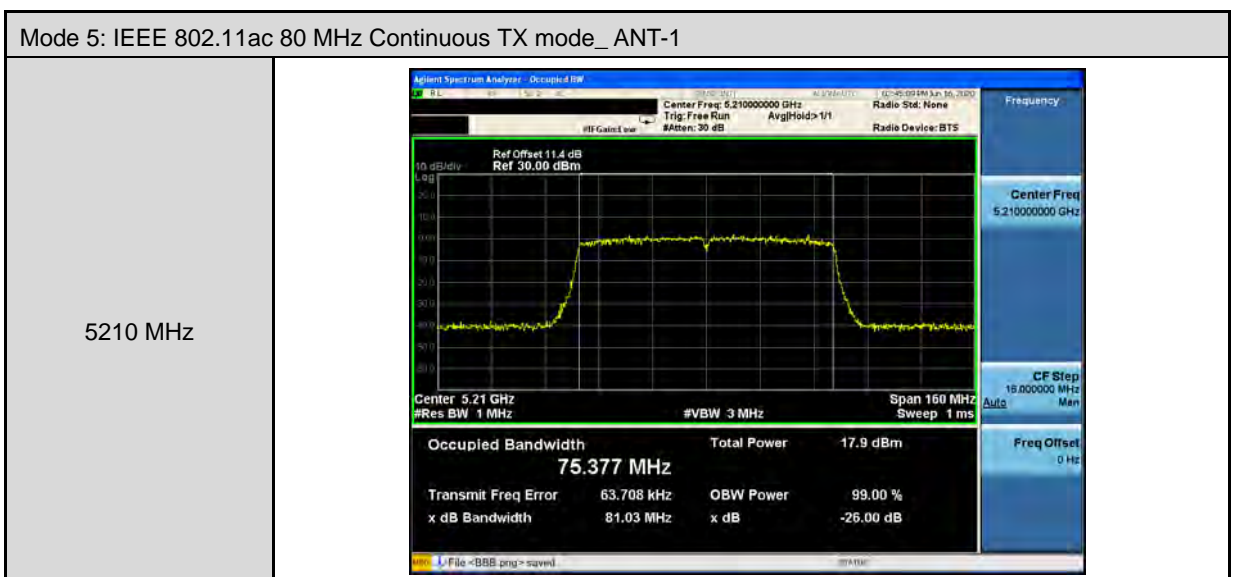
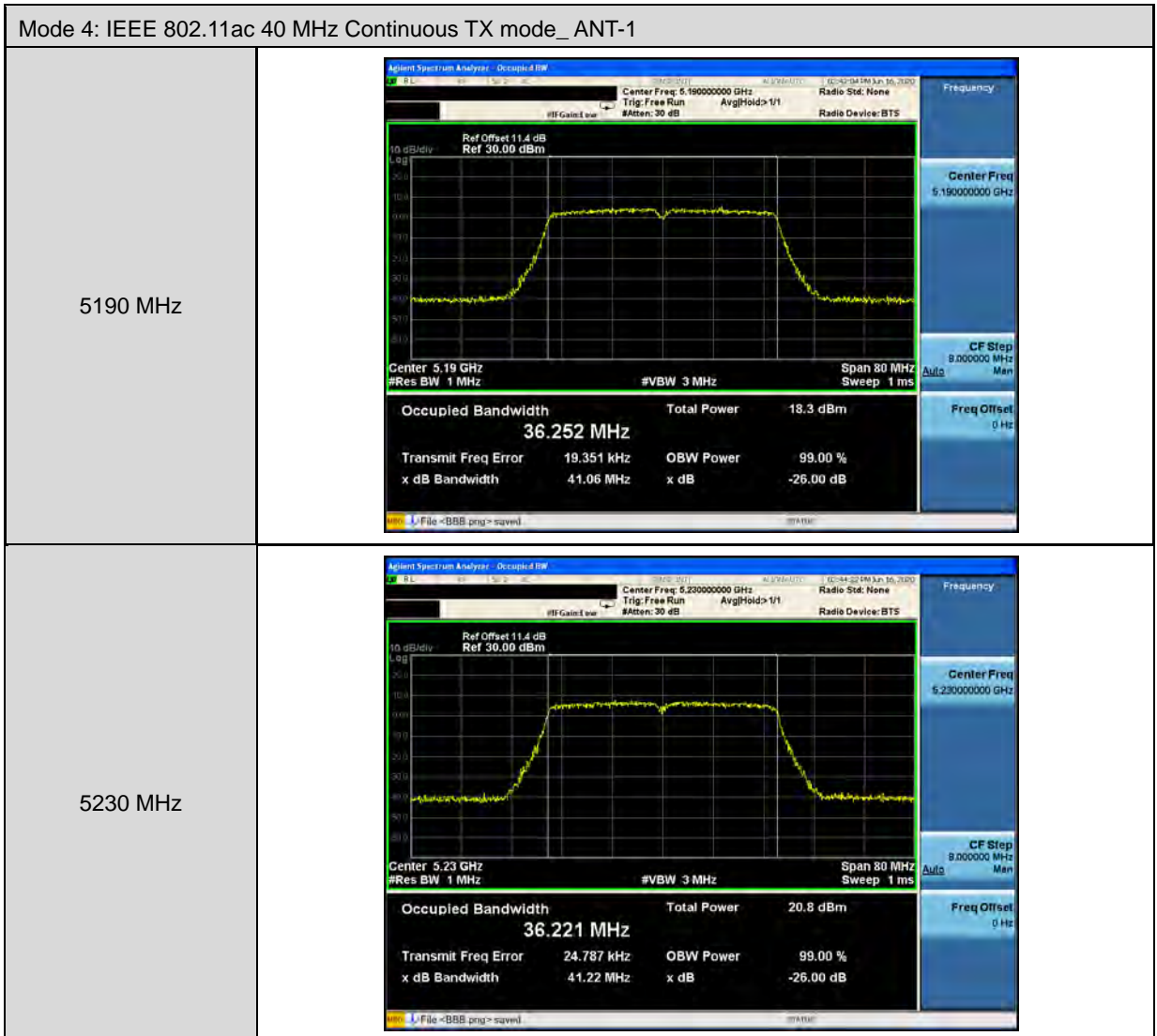



Mode 6: IEEE 802.11ax 20 MHz Continuous TX mode_ ANT-1	
5180 MHz	<p>Center Freq: 5.18000000 GHz</p> <p>Center 5.18 GHz</p> <p>Occupied Bandwidth: 18.979 MHz</p> <p>Total Power: 19.4 dBm</p> <p>Transmit Freq Error: 2.903 kHz</p> <p>OBW Power: 99.00 %</p> <p>x dB Bandwidth: 20.93 MHz</p> <p>x dB: -26.00 dB</p>
5200 MHz	<p>Center Freq: 5.20000000 GHz</p> <p>Center 5.2 GHz</p> <p>Occupied Bandwidth: 19.020 MHz</p> <p>Total Power: 21.0 dBm</p> <p>Transmit Freq Error: -11.070 kHz</p> <p>OBW Power: 99.00 %</p> <p>x dB Bandwidth: 21.04 MHz</p> <p>x dB: -26.00 dB</p>
5240 MHz	<p>Center Freq: 5.24000000 GHz</p> <p>Center 5.24 GHz</p> <p>Occupied Bandwidth: 18.930 MHz</p> <p>Total Power: 20.6 dBm</p> <p>Transmit Freq Error: 19.404 kHz</p> <p>OBW Power: 99.00 %</p> <p>x dB Bandwidth: 20.65 MHz</p> <p>x dB: -26.00 dB</p>



Mode 7: IEEE 802.11ax 40 MHz Continuous TX mode_ ANT-1

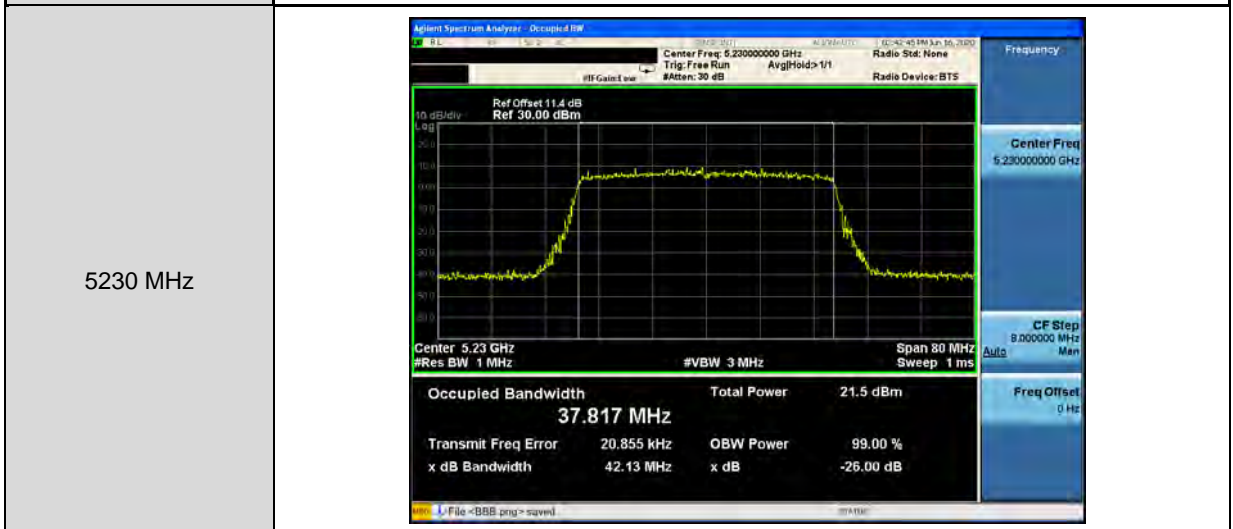
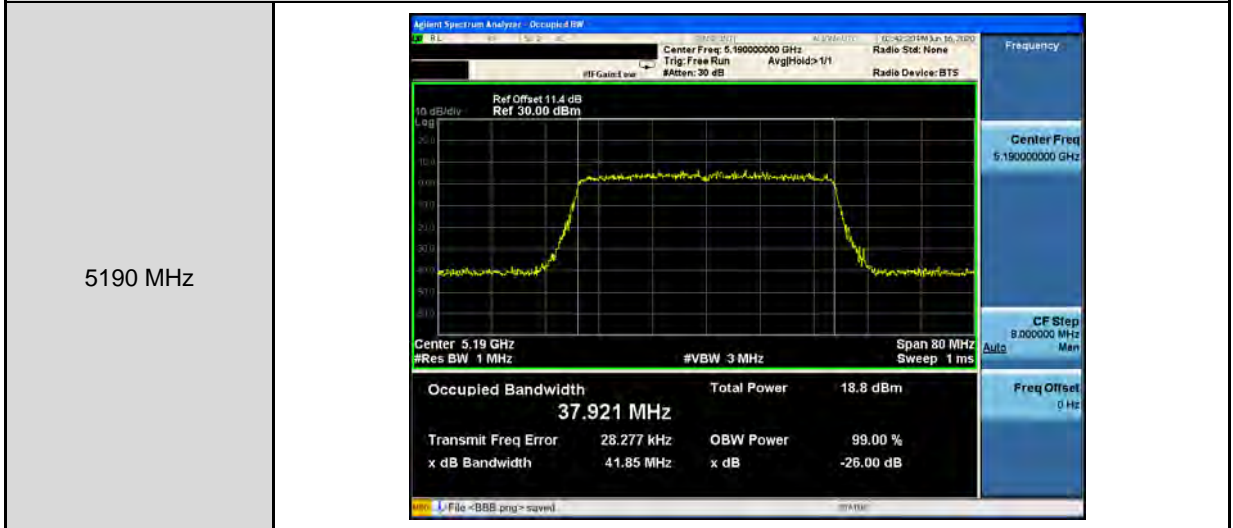

Mode 8: IEEE 802.11ax 80 MHz Continuous TX mode_ ANT-1

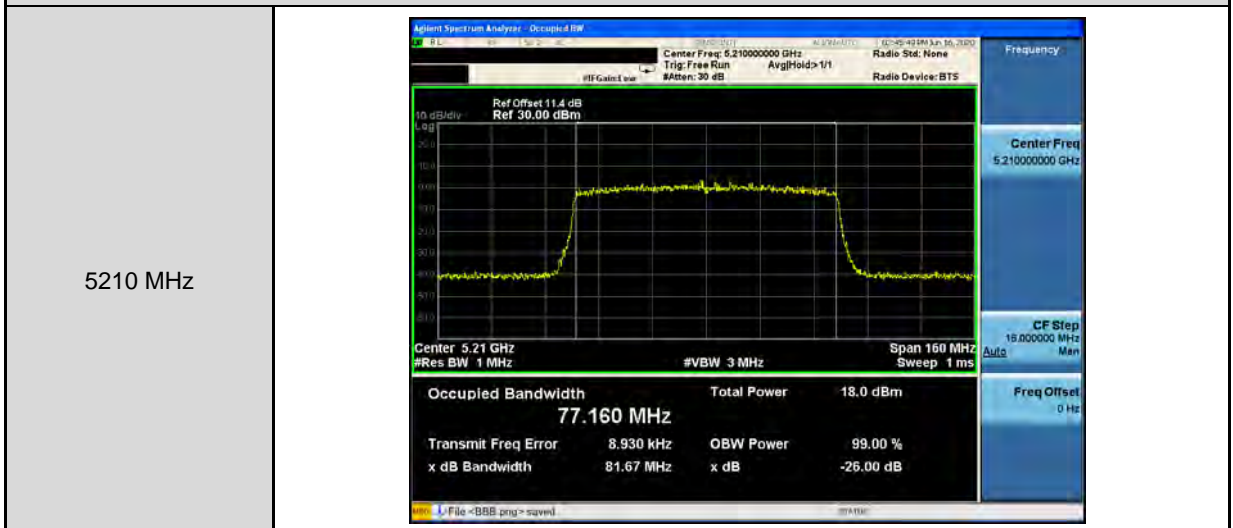



Mode 3: IEEE 802.11ac 20 MHz Continuous TX mode_ANT-2	
5180 MHz	<p>Agilent Spectrum Analyzer - Occupied BW</p> <p>Center Freq: 5.180000000 GHz Trig: Free Run #Attens: 30 dB Avg/Hold: 1/1 Radio Std: None Radio Device: BTS</p> <p>Ref Offset 11.4 dB Ref 30.00 dBm</p> <p>Center 5.18 GHz #Res BW 300 kHz #VBW 1 MHz Span 40 MHz Sweep 1 ms</p> <p>Occupied Bandwidth 17.604 MHz Total Power 18.8 dBm Transmit Freq Error -4.597 kHz OBW Power 99.00 % x dB Bandwidth 20.55 MHz x dB -26.00 dB</p> <p>File > BBS.png > saved</p>
5200 MHz	<p>Agilent Spectrum Analyzer - Occupied BW</p> <p>Center Freq: 5.200000000 GHz Trig: Free Run #Attens: 30 dB Avg/Hold: 1/1 Radio Std: None Radio Device: BTS</p> <p>Ref Offset 11.4 dB Ref 30.00 dBm</p> <p>Center 5.2 GHz #Res BW 300 kHz #VBW 1 MHz Span 40 MHz Sweep 1 ms</p> <p>Occupied Bandwidth 17.633 MHz Total Power 19.5 dBm Transmit Freq Error 8.630 kHz OBW Power 99.00 % x dB Bandwidth 20.33 MHz x dB -26.00 dB</p> <p>File > BBS.png > saved</p>
5240 MHz	<p>Agilent Spectrum Analyzer - Occupied BW</p> <p>Center Freq: 5.240000000 GHz Trig: Free Run #Attens: 30 dB Avg/Hold: 1/1 Radio Std: None Radio Device: BTS</p> <p>Ref Offset 11.4 dB Ref 30.00 dBm</p> <p>Center 5.24 GHz #Res BW 300 kHz #VBW 1 MHz Span 40 MHz Sweep 1 ms</p> <p>Occupied Bandwidth 17.651 MHz Total Power 19.4 dBm Transmit Freq Error 6.582 kHz OBW Power 99.00 % x dB Bandwidth 20.41 MHz x dB -26.00 dB</p> <p>File > BBS.png > saved</p>



Mode 4: IEEE 802.11ac 40 MHz Continuous TX mode_ ANT-2

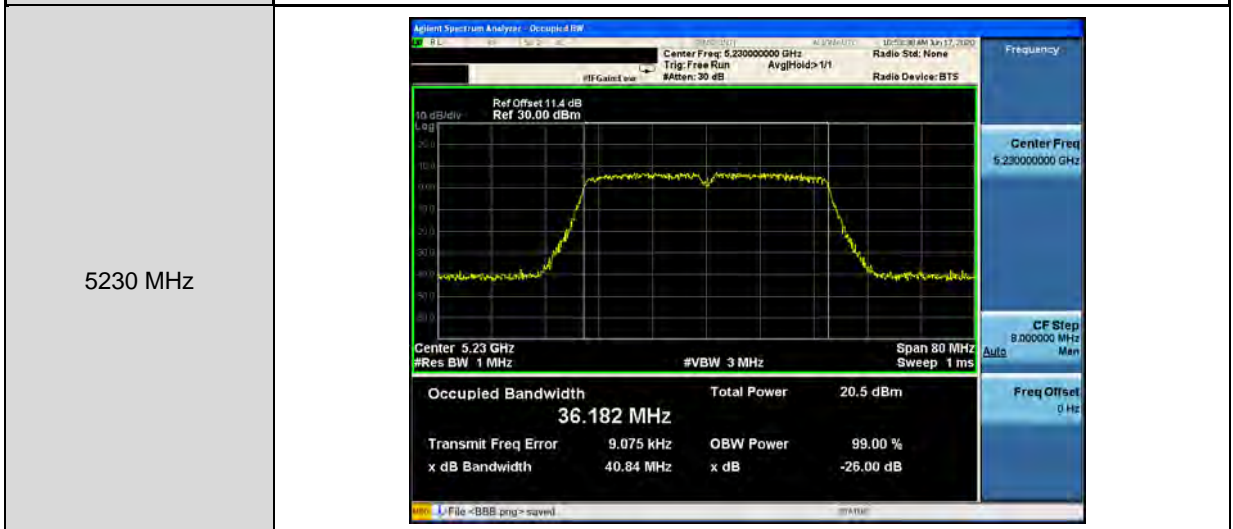
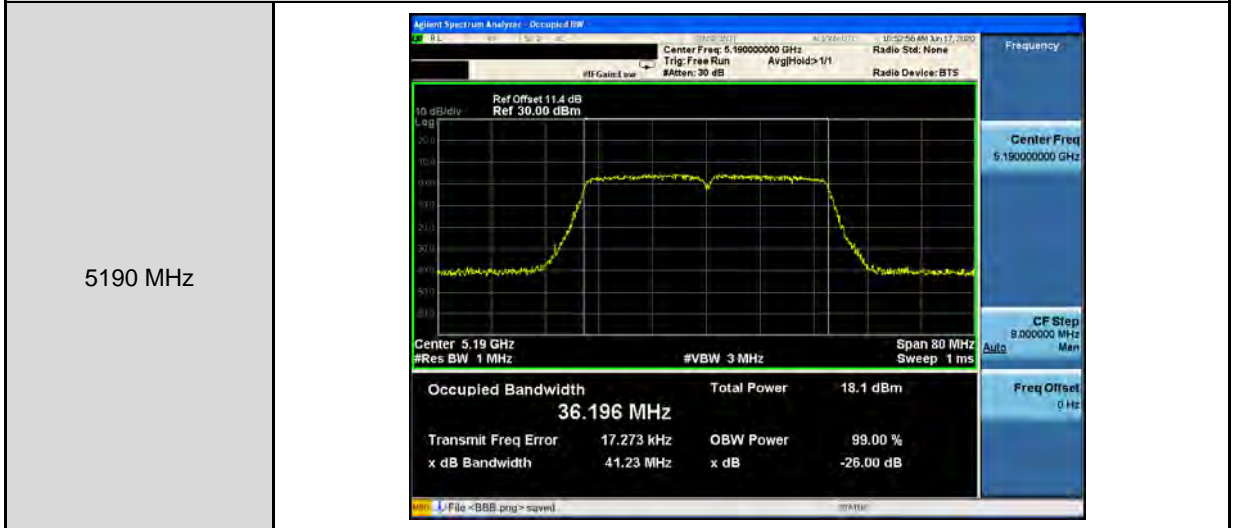

Mode 5: IEEE 802.11ac 80 MHz Continuous TX mode_ ANT-2

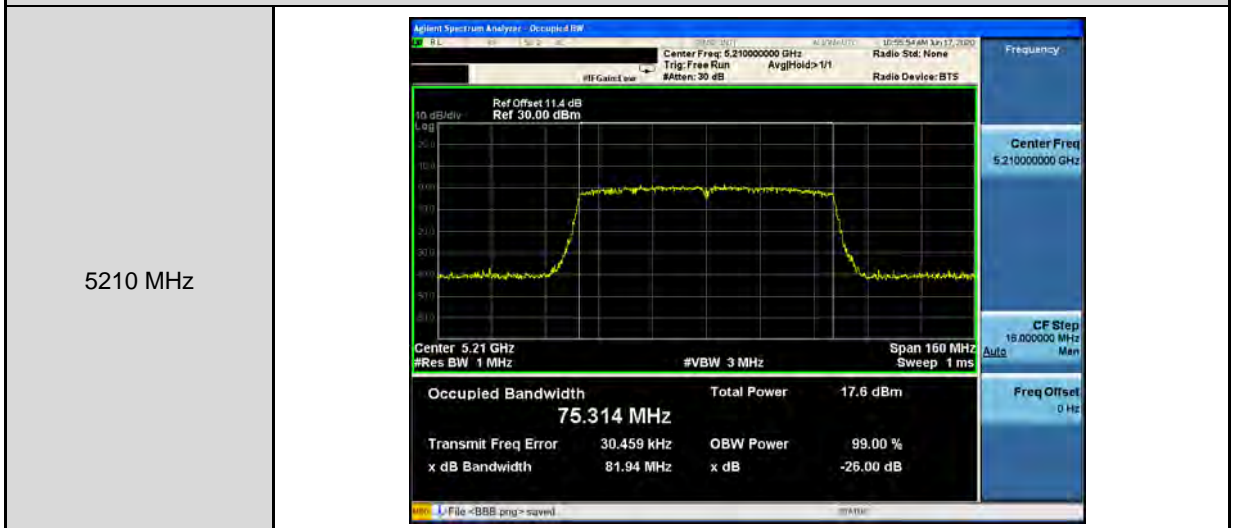

Mode 6: IEEE 802.11ax 20 MHz Continuous TX mode_ANT-2	
5180 MHz	<p>Center Freq: 5.18000000 GHz</p> <p>Occupied Bandwidth: 18.989 MHz</p> <p>Total Power: 18.9 dBm</p> <p>Transmit Freq Error: 9.138 kHz</p> <p>OBW Power: 99.00 %</p> <p>x dB Bandwidth: 21.58 MHz</p> <p>x dB: -26.00 dB</p>
5200 MHz	<p>Center Freq: 5.20000000 GHz</p> <p>Occupied Bandwidth: 18.968 MHz</p> <p>Total Power: 20.5 dBm</p> <p>Transmit Freq Error: 9.752 kHz</p> <p>OBW Power: 99.00 %</p> <p>x dB Bandwidth: 20.89 MHz</p> <p>x dB: -26.00 dB</p>
5240 MHz	<p>Center Freq: 5.24000000 GHz</p> <p>Occupied Bandwidth: 19.005 MHz</p> <p>Total Power: 20.1 dBm</p> <p>Transmit Freq Error: 12.160 kHz</p> <p>OBW Power: 99.00 %</p> <p>x dB Bandwidth: 21.21 MHz</p> <p>x dB: -26.00 dB</p>

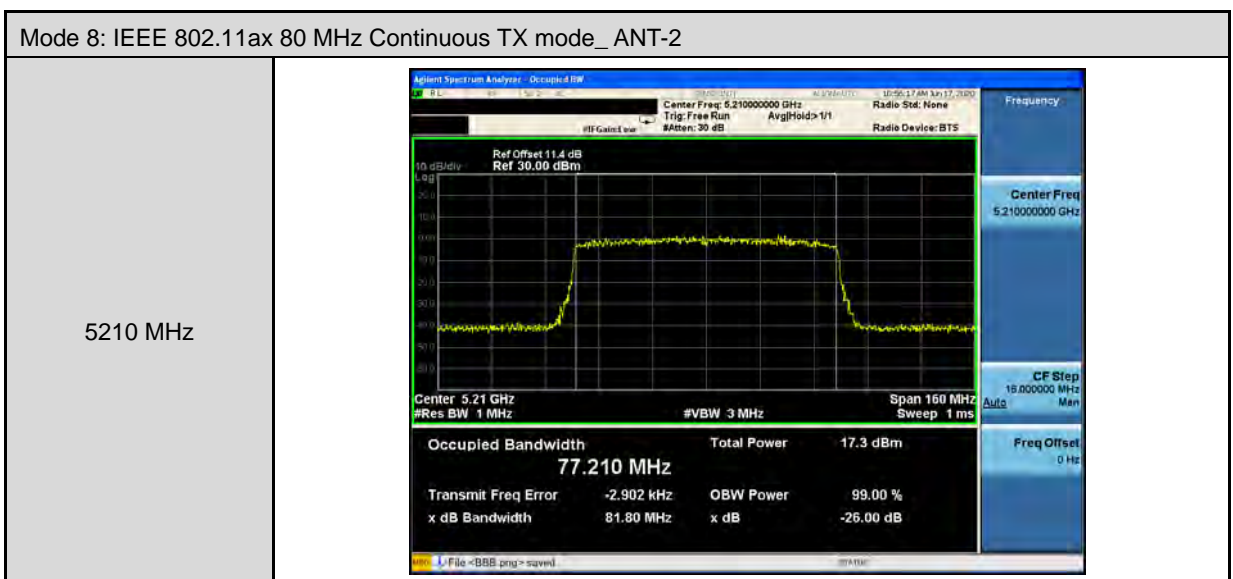
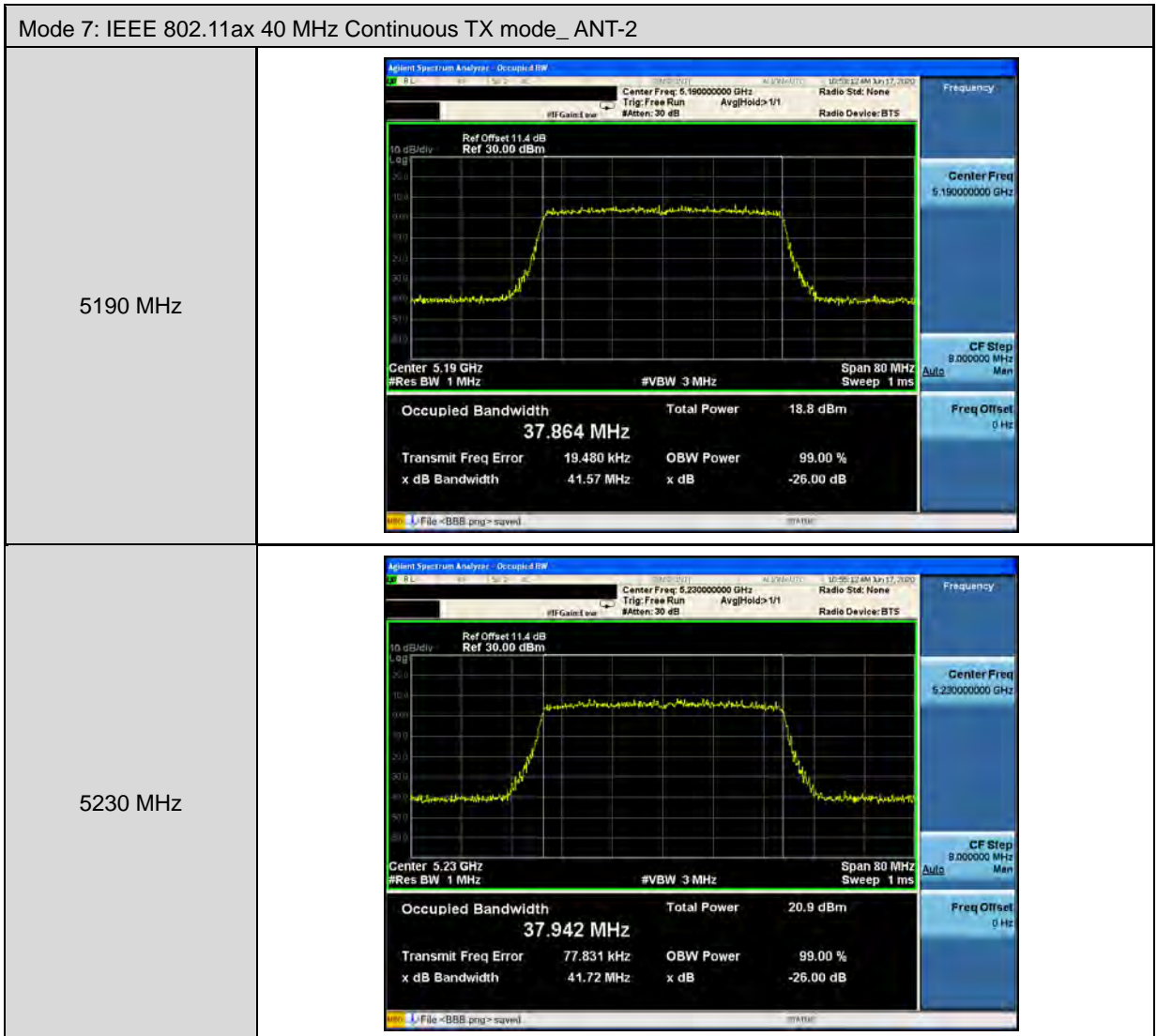



Mode 3: IEEE 802.11ac 20 MHz Continuous TX mode_ ANT-3	
5180 MHz	<p>Agilent Spectrum Analyzer - Occupied BW</p> <p>Center Freq: 5.180000000 GHz Trig: Free Run #Attens: 30 dB Avg/Hold: 1/1 Radio Std: None Radio Device: BTS</p> <p>Ref Offset 11.4 dB Ref 30.00 dBm</p> <p>Center 5.18 GHz #Res BW 300 kHz #VBW 1 MHz Span 40 MHz Sweep 1 ms</p> <p>Occupied Bandwidth: 17.636 MHz Total Power: 19.2 dBm Transmit Freq Error: 9.349 kHz x dB Bandwidth: 20.41 MHz OBW Power: 99.00 % x dB: -26.00 dB</p> <p>File > BBS.png > saved</p>
5200 MHz	<p>Agilent Spectrum Analyzer - Occupied BW</p> <p>Center Freq: 5.200000000 GHz Trig: Free Run #Attens: 30 dB Avg/Hold: 1/1 Radio Std: None Radio Device: BTS</p> <p>Ref Offset 11.4 dB Ref 30.00 dBm</p> <p>Center 5.2 GHz #Res BW 300 kHz #VBW 1 MHz Span 40 MHz Sweep 1 ms</p> <p>Occupied Bandwidth: 17.633 MHz Total Power: 19.8 dBm Transmit Freq Error: 3.360 kHz x dB Bandwidth: 20.55 MHz OBW Power: 99.00 % x dB: -26.00 dB</p> <p>File > BBS.png > saved</p>
5240 MHz	<p>Agilent Spectrum Analyzer - Occupied BW</p> <p>Center Freq: 5.240000000 GHz Trig: Free Run #Attens: 30 dB Avg/Hold: 1/1 Radio Std: None Radio Device: BTS</p> <p>Ref Offset 11.4 dB Ref 30.00 dBm</p> <p>Center 5.24 GHz #Res BW 300 kHz #VBW 1 MHz Span 40 MHz Sweep 1 ms</p> <p>Occupied Bandwidth: 17.610 MHz Total Power: 19.5 dBm Transmit Freq Error: 27.362 kHz x dB Bandwidth: 20.30 MHz OBW Power: 99.00 % x dB: -26.00 dB</p> <p>File > BBS.png > saved</p>



Mode 4: IEEE 802.11ac 40 MHz Continuous TX mode_ ANT-3

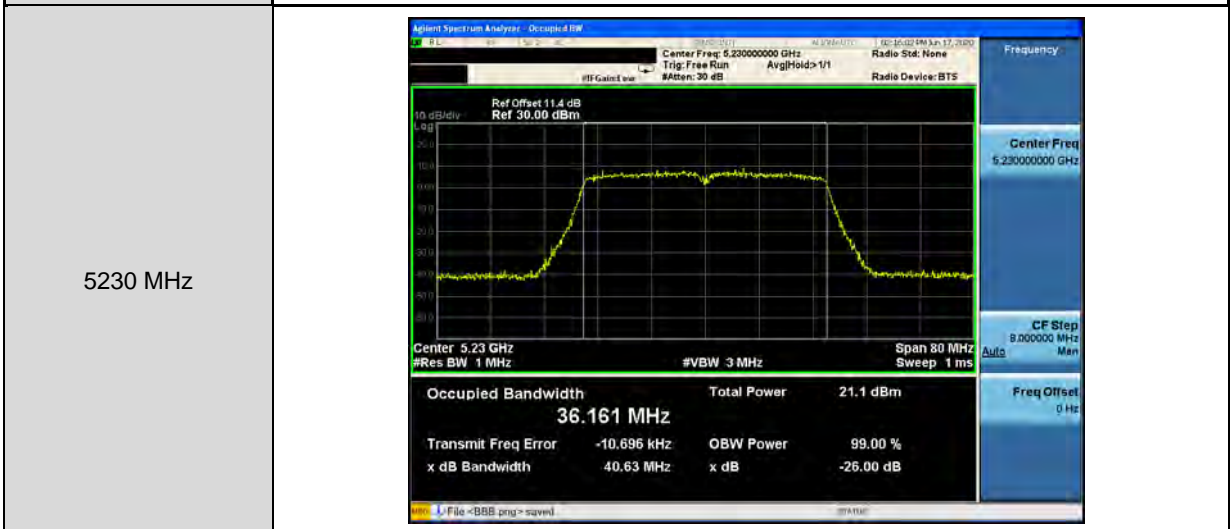
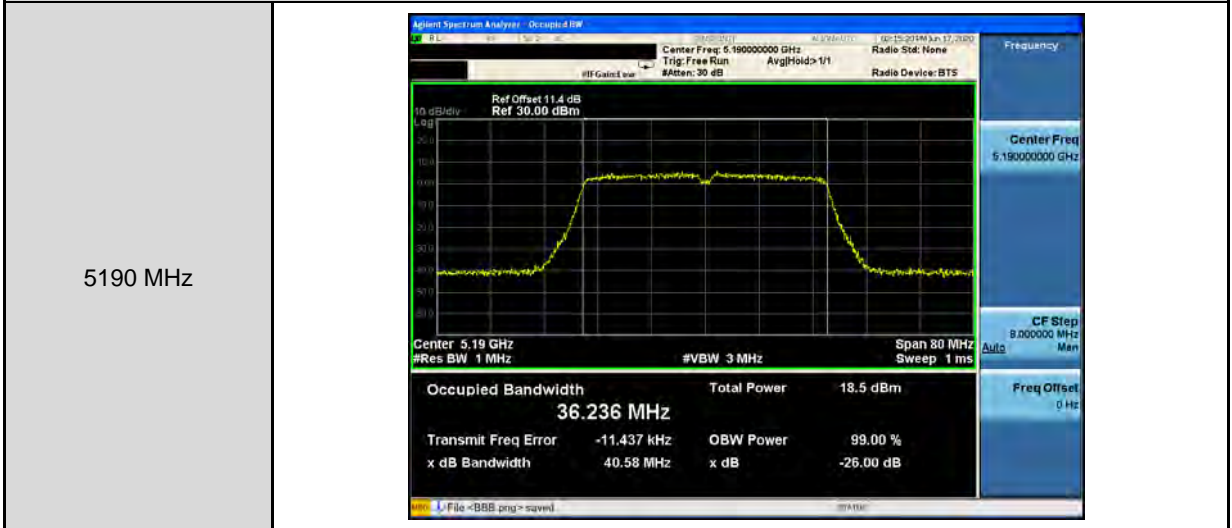

Mode 5: IEEE 802.11ac 80 MHz Continuous TX mode_ ANT-3

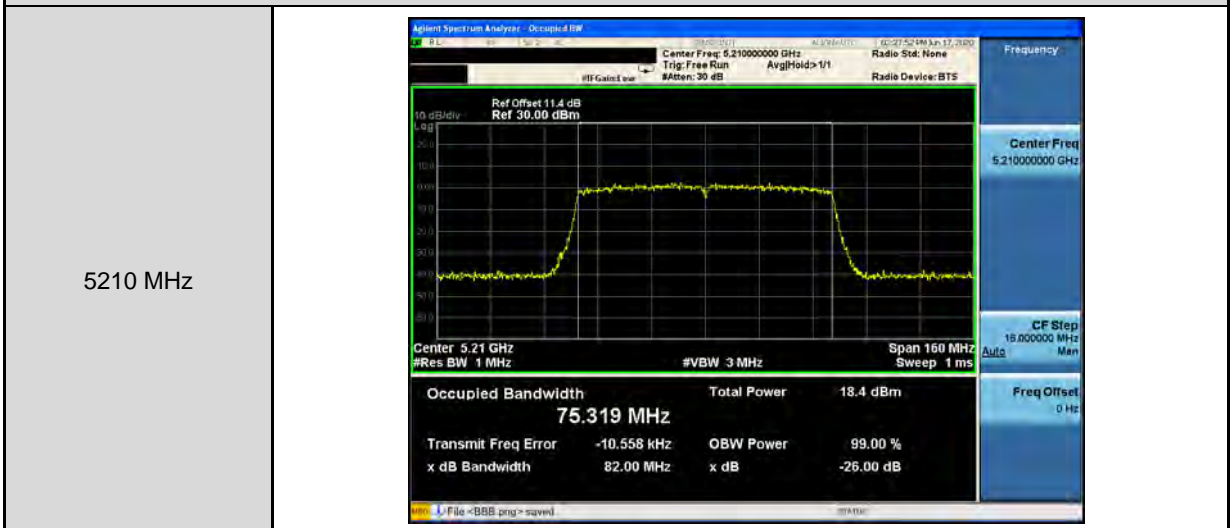



Mode 6: IEEE 802.11ax 20 MHz Continuous TX mode_ANT-3	
5180 MHz	<p>Agilent Spectrum Analyzer - Occupied BW</p> <p>Center Freq: 5.180000000 GHz Trig: Free Run #Attens: 30 dB Avg/Hold: 1/1 Radio Std: None Radio Device: BTS</p> <p>Ref Offset 11.4 dB Ref 30.00 dBm</p> <p>Center 5.18 GHz #Res BW 300 kHz #VBW 1 MHz Span 40 MHz Sweep 1 ms</p> <p>Occupied Bandwidth: 18.993 MHz Total Power: 19.7 dBm Transmit Freq Error: -12.373 kHz x dB Bandwidth: 20.74 MHz OBW Power: 99.00 % x dB: -26.00 dB</p> <p>File > BBS.png > saved</p>
5200 MHz	<p>Agilent Spectrum Analyzer - Occupied BW</p> <p>Center Freq: 5.200000000 GHz Trig: Free Run #Attens: 30 dB Avg/Hold: 1/1 Radio Std: None Radio Device: BTS</p> <p>Ref Offset 11.4 dB Ref 30.00 dBm</p> <p>Center 5.2 GHz #Res BW 300 kHz #VBW 1 MHz Span 40 MHz Sweep 1 ms</p> <p>Occupied Bandwidth: 18.975 MHz Total Power: 20.8 dBm Transmit Freq Error: -5.860 kHz x dB Bandwidth: 21.33 MHz OBW Power: 99.00 % x dB: -26.00 dB</p> <p>File > BBS.png > saved</p>
5240 MHz	<p>Agilent Spectrum Analyzer - Occupied BW</p> <p>Center Freq: 5.240000000 GHz Trig: Free Run #Attens: 30 dB Avg/Hold: 1/1 Radio Std: None Radio Device: BTS</p> <p>Ref Offset 11.4 dB Ref 30.00 dBm</p> <p>Center 5.24 GHz #Res BW 300 kHz #VBW 1 MHz Span 40 MHz Sweep 1 ms</p> <p>Occupied Bandwidth: 18.974 MHz Total Power: 20.4 dBm Transmit Freq Error: -1.774 kHz x dB Bandwidth: 21.24 MHz OBW Power: 99.00 % x dB: -26.00 dB</p> <p>File > BBS.png > saved</p>



Mode 7: IEEE 802.11ax 40 MHz Continuous TX mode_ ANT-3

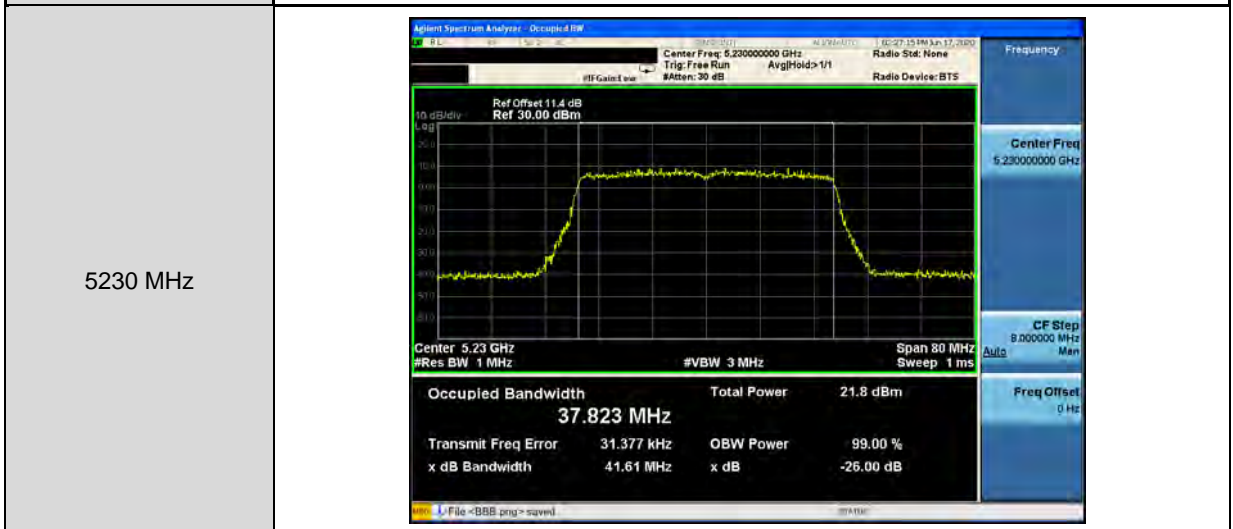
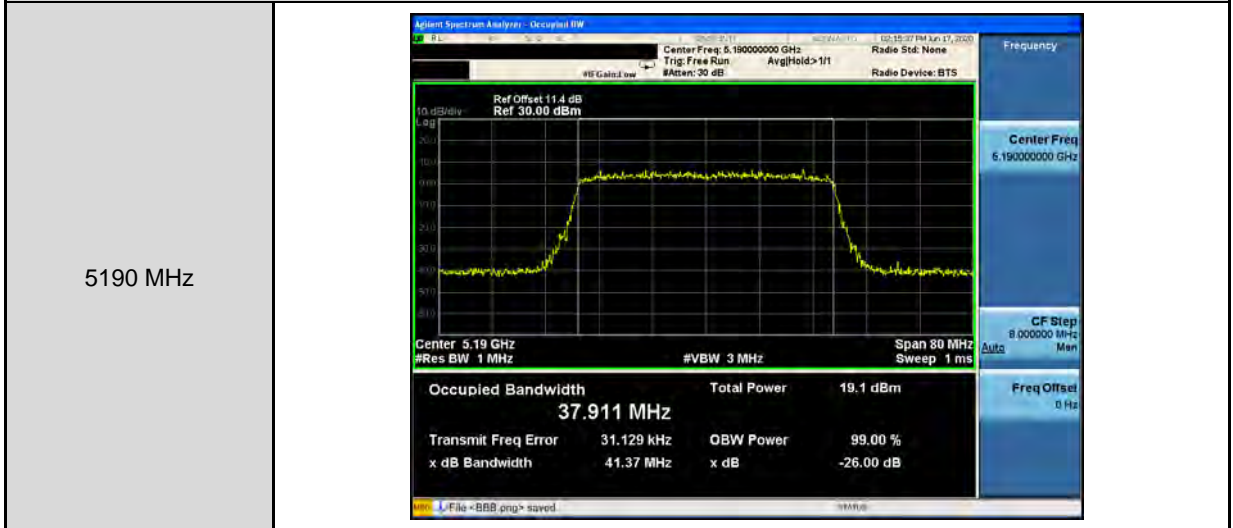

Mode 8: IEEE 802.11ax 80 MHz Continuous TX mode_ ANT-3

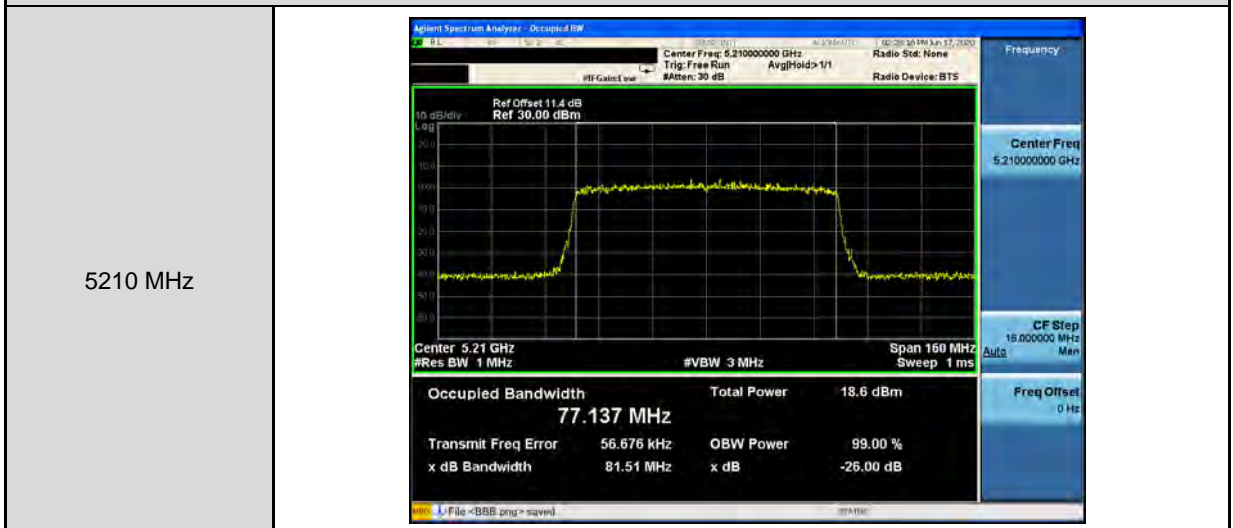



6 dB RF Bandwidth Measurement

Test Mode	Mode 2: IEEE 802.11a Continuous TX mode	
Frequency (MHz)	ANT-0	Limit (kHz)
5745.0	16350	≥ 500
5785.0	16050	≥ 500
5825.0	16380	≥ 500
Frequency (MHz)	ANT-1	Limit (kHz)
5745.0	16360	≥ 500
5785.0	16340	≥ 500
5825.0	16340	≥ 500
Frequency (MHz)	ANT-2	Limit (kHz)
5745.0	16370	≥ 500
5785.0	16360	≥ 500
5825.0	15940	≥ 500
Frequency (MHz)	ANT-3	Limit (kHz)
5745.0	16350	≥ 500
5785.0	16090	≥ 500
5825.0	16370	≥ 500



Test Mode	Mode 3: IEEE 802.11ac 20 MHz Continuous TX mode	
Frequency (MHz)	ANT-0	Limit (kHz)
5745.0	17660	≥ 500
5785.0	17560	≥ 500
5825.0	17780	≥ 500
Frequency (MHz)	ANT-1	Limit (kHz)
5745.0	16930	≥ 500
5785.0	16950	≥ 500
5825.0	17670	≥ 500
Frequency (MHz)	ANT-2	Limit (kHz)
5745.0	17610	≥ 500
5785.0	17620	≥ 500
5825.0	17620	≥ 500
Frequency (MHz)	ANT-3	Limit (kHz)
5745.0	17670	≥ 500
5785.0	17680	≥ 500
5825.0	17320	≥ 500



Test Mode	Mode 4: IEEE 802.11ac 40 MHz Continuous TX mode	
Frequency (MHz)	ANT-0	Limit (kHz)
5755.0	35760	≥ 500
5795.0	35730	≥ 500
Frequency (MHz)	ANT-1	Limit (kHz)
5755.0	36330	≥ 500
5795.0	36430	≥ 500
Frequency (MHz)	ANT-2	Limit (kHz)
5755.0	36430	≥ 500
5795.0	36340	≥ 500
Frequency (MHz)	ANT-3	Limit (kHz)
5755.0	36120	≥ 500
5795.0	36360	≥ 500

Test Mode	Mode 5: IEEE 802.11ac 80 MHz Continuous TX mode	
Frequency (MHz)	ANT-0	Limit (kHz)
5775.0	74400	≥ 500
Frequency (MHz)	ANT-1	Limit (kHz)
5775.0	75640	≥ 500
Frequency (MHz)	ANT-2	Limit (kHz)
5775.0	76020	≥ 500
Frequency (MHz)	ANT-3	Limit (kHz)
5775.0	75950	≥ 500



Test Mode	Mode 6: IEEE 802.11ax 20 MHz Continuous TX mode	
Frequency (MHz)	ANT-0	Limit (kHz)
5745.0	18780	≥ 500
5785.0	18860	≥ 500
5825.0	19060	≥ 500
Frequency (MHz)	ANT-1	Limit (kHz)
5745.0	19040	≥ 500
5785.0	18900	≥ 500
5825.0	19060	≥ 500
Frequency (MHz)	ANT-2	Limit (kHz)
5745.0	19030	≥ 500
5785.0	18810	≥ 500
5825.0	16900	≥ 500
Frequency (MHz)	ANT-3	Limit (kHz)
5745.0	18840	≥ 500
5785.0	18970	≥ 500
5825.0	18340	≥ 500



Test Mode	Mode 7: IEEE 802.11ax 40 MHz Continuous TX mode	
Frequency (MHz)	ANT-0	Limit (kHz)
5755.0	37280	≥ 500
5795.0	37620	≥ 500
Frequency (MHz)	ANT-1	Limit (kHz)
5755.0	37740	≥ 500
5795.0	38100	≥ 500
Frequency (MHz)	ANT-2	Limit (kHz)
5755.0	38110	≥ 500
5795.0	38200	≥ 500
Frequency (MHz)	ANT-3	Limit (kHz)
5755.0	37030	≥ 500
5795.0	37990	≥ 500

Test Mode	Mode 8: IEEE 802.11ax 80 MHz Continuous TX mode	
Frequency (MHz)	ANT-0	Limit (kHz)
5775.0	73050	≥ 500
Frequency (MHz)	ANT-1	Limit (kHz)
5775.0	77880	≥ 500
Frequency (MHz)	ANT-2	Limit (kHz)
5775.0	76090	≥ 500
Frequency (MHz)	ANT-3	Limit (kHz)
5775.0	74760	≥ 500



Beamforming on

Test Mode	Mode 3: IEEE 802.11ac 20 MHz Continuous TX mode	
Frequency (MHz)	ANT-0	Limit (kHz)
5745.0	17570	≥ 500
5785.0	17660	≥ 500
5825.0	17670	≥ 500
Frequency (MHz)	ANT-1	Limit (kHz)
5745.0	17630	≥ 500
5785.0	17130	≥ 500
5825.0	17560	≥ 500
Frequency (MHz)	ANT-2	Limit (kHz)
5745.0	17570	≥ 500
5785.0	17740	≥ 500
5825.0	17630	≥ 500
Frequency (MHz)	ANT-3	Limit (kHz)
5745.0	17570	≥ 500
5785.0	17600	≥ 500
5825.0	17620	≥ 500



Test Mode	Mode 4: IEEE 802.11ac 40 MHz Continuous TX mode	
Frequency (MHz)	ANT-0	Limit (kHz)
5755.0	35720	≥ 500
5795.0	35830	≥ 500
Frequency (MHz)	ANT-1	Limit (kHz)
5755.0	36110	≥ 500
5795.0	36380	≥ 500
Frequency (MHz)	ANT-2	Limit (kHz)
5755.0	35660	≥ 500
5795.0	36350	≥ 500
Frequency (MHz)	ANT-3	Limit (kHz)
5755.0	36360	≥ 500
5795.0	36420	≥ 500

Test Mode	Mode 5: IEEE 802.11ac 80 MHz Continuous TX mode	
Frequency (MHz)	ANT-0	Limit (kHz)
5775.0	72080	≥ 500
Frequency (MHz)	ANT-1	Limit (kHz)
5775.0	75520	≥ 500
Frequency (MHz)	ANT-2	Limit (kHz)
5775.0	75260	≥ 500
Frequency (MHz)	ANT-3	Limit (kHz)
5775.0	75990	≥ 500



Test Mode	Mode 6: IEEE 802.11ax 20 MHz Continuous TX mode	
Frequency (MHz)	ANT-0	Limit (kHz)
5745.0	18990	≥ 500
5785.0	18880	≥ 500
5825.0	18820	≥ 500
Frequency (MHz)	ANT-1	Limit (kHz)
5745.0	19010	≥ 500
5785.0	18860	≥ 500
5825.0	18870	≥ 500
Frequency (MHz)	ANT-2	Limit (kHz)
5745.0	18930	≥ 500
5785.0	19010	≥ 500
5825.0	19010	≥ 500
Frequency (MHz)	ANT-3	Limit (kHz)
5745.0	18640	≥ 500
5785.0	18510	≥ 500
5825.0	19000	≥ 500



Test Mode	Mode 7: IEEE 802.11ax 40 MHz Continuous TX mode	
Frequency (MHz)	ANT-0	Limit (kHz)
5755.0	37590	≥ 500
5795.0	37800	≥ 500
Frequency (MHz)	ANT-1	Limit (kHz)
5755.0	38020	≥ 500
5795.0	37690	≥ 500
Frequency (MHz)	ANT-2	Limit (kHz)
5755.0	37680	≥ 500
5795.0	38210	≥ 500
Frequency (MHz)	ANT-3	Limit (kHz)
5755.0	38030	≥ 500
5795.0	37930	≥ 500

Test Mode	Mode 8: IEEE 802.11ax 80 MHz Continuous TX mode	
Frequency (MHz)	ANT-0	Limit (kHz)
5775.0	77740	≥ 500
Frequency (MHz)	ANT-1	Limit (kHz)
5775.0	77550	≥ 500
Frequency (MHz)	ANT-2	Limit (kHz)
5775.0	77550	≥ 500
Frequency (MHz)	ANT-3	Limit (kHz)
5775.0	78090	≥ 500



■ Test Graphs

Mode 2: IEEE 802.11a Continuous TX mode_ANT-0	
5745 MHz	<p>Client Spectrum Analyzer - Occupied BW</p> <p>Center Freq: 5.745000000 GHz Trig: Free Run Avg/Hold: 1/1 #F Gate: Low #Atten: 30 dB</p> <p>Ref Offset 11.4 dB Ref 30.00 dBm</p> <p>Center 5.745 GHz #Res BW 100 kHz #VBW 300 kHz Span 40 MHz Sweep 3.867 ms</p> <p>Occupied Bandwidth 16.395 MHz Total Power 26.0 dBm</p> <p>Transmit Freq Error -10.920 kHz OBW Power 99.00 % x dB Bandwidth 16.35 MHz x dB -5.00 dB</p>
5785 MHz	<p>Client Spectrum Analyzer - Occupied BW</p> <p>Center Freq: 5.785000000 GHz Trig: Free Run Avg/Hold: 1/1 #F Gate: Low #Atten: 30 dB</p> <p>Ref Offset 11.4 dB Ref 30.00 dBm</p> <p>Center 5.785 GHz #Res BW 100 kHz #VBW 300 kHz Span 40 MHz Sweep 3.867 ms</p> <p>Occupied Bandwidth 16.420 MHz Total Power 25.8 dBm</p> <p>Transmit Freq Error -8.493 kHz OBW Power 99.00 % x dB Bandwidth 16.05 MHz x dB -6.00 dB</p>
5825 MHz	<p>Client Spectrum Analyzer - Occupied BW</p> <p>Center Freq: 5.825000000 GHz Trig: Free Run Avg/Hold: 1/1 #F Gate: Low #Atten: 30 dB</p> <p>Ref Offset 11.4 dB Ref 30.00 dBm</p> <p>Center 5.825 GHz #Res BW 100 kHz #VBW 300 kHz Span 40 MHz Sweep 3.867 ms</p> <p>Occupied Bandwidth 16.447 MHz Total Power 25.8 dBm</p> <p>Transmit Freq Error -5.443 kHz OBW Power 99.00 % x dB Bandwidth 16.38 MHz x dB -6.00 dB</p>



Mode 3: IEEE 802.11ac 20 MHz Continuous TX mode_ANT-0	
5745 MHz	<p>Center Freq: 5.745 GHz #Res BW: 100 kHz #VBW: 300 kHz Span: 40 MHz Sweep: 3.867 ms</p> <p>Occupied Bandwidth: 17.593 MHz Total Power: 26.0 dBm Transmit Freq Error: 3.430 kHz x dB Bandwidth: 17.66 MHz OBW Power: 99.00 % x dB: -6.00 dB</p>
5785 MHz	<p>Center Freq: 5.785 GHz #Res BW: 100 kHz #VBW: 300 kHz Span: 40 MHz Sweep: 3.867 ms</p> <p>Occupied Bandwidth: 17.617 MHz Total Power: 25.5 dBm Transmit Freq Error: -3.525 kHz x dB Bandwidth: 17.56 MHz OBW Power: 99.00 % x dB: -6.00 dB</p>
5825 MHz	<p>Center Freq: 5.825 GHz #Res BW: 100 kHz #VBW: 300 kHz Span: 40 MHz Sweep: 3.867 ms</p> <p>Occupied Bandwidth: 17.667 MHz Total Power: 25.4 dBm Transmit Freq Error: -2.708 kHz x dB Bandwidth: 17.78 MHz OBW Power: 99.00 % x dB: -6.00 dB</p>



Mode 4: IEEE 802.11ac 40 MHz Continuous TX mode_ANT-0

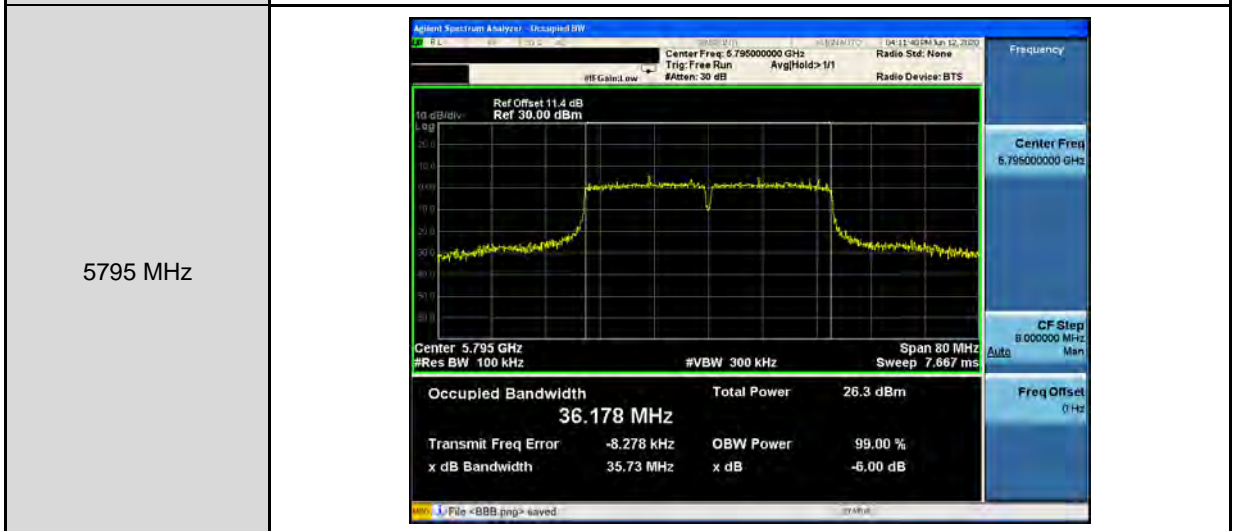
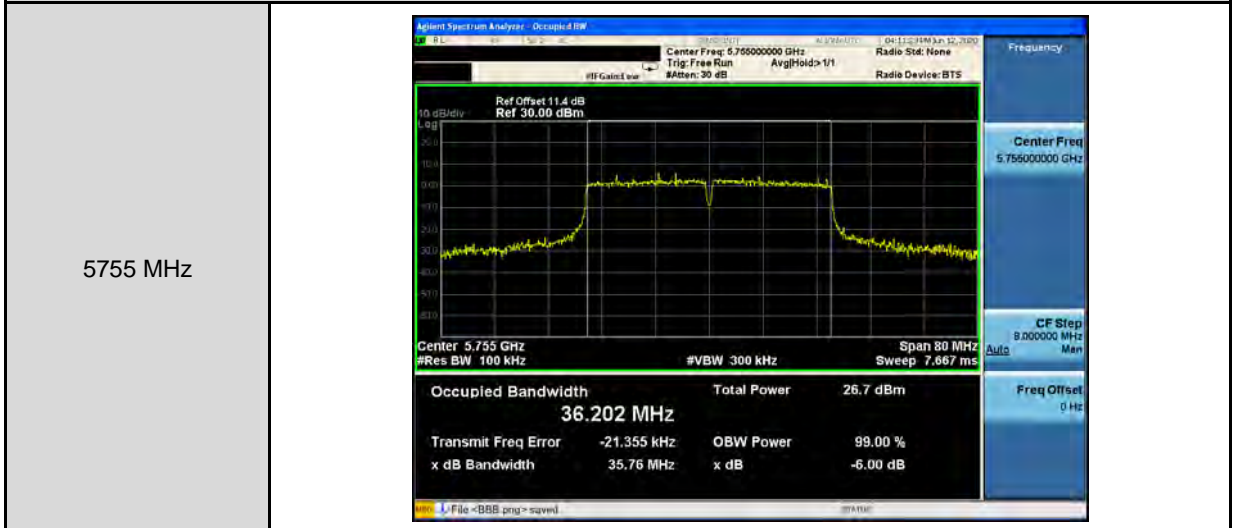

Mode 5: IEEE 802.11ac 80 MHz Continuous TX mode_ANT-0

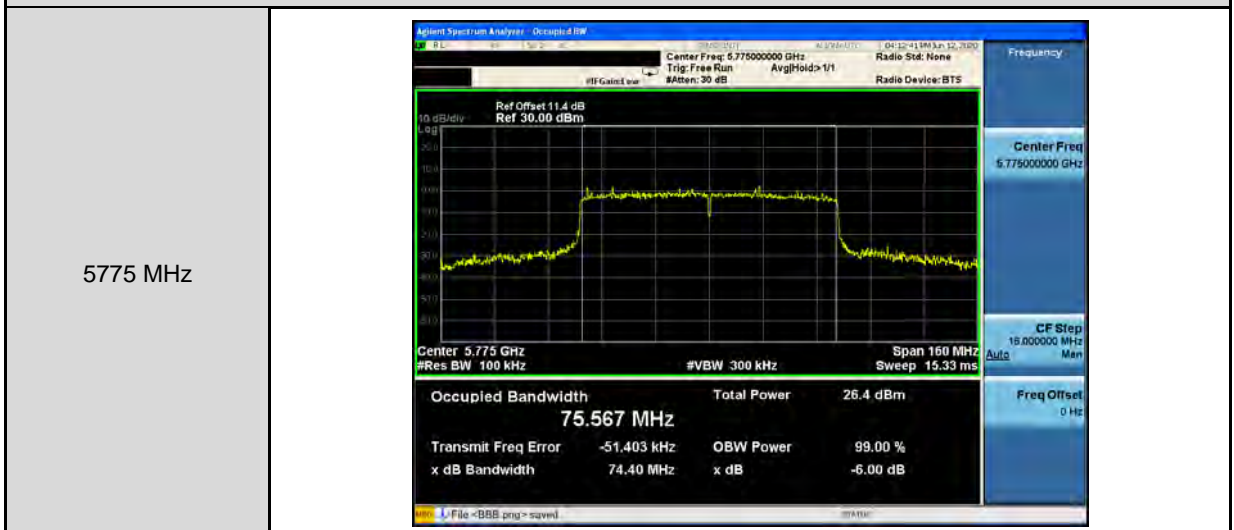



Mode 6: IEEE 802.11ax 20 MHz Continuous TX mode_ANT-0	
5745 MHz	<p>Agilent Spectrum Analyzer - Occupied BW</p> <p>Center Freq: 5.745000000 GHz Trig: Free Run Ave/Hold: 1/1 #Att: 30 dB Radio Std: None Radio Device: BTS</p> <p>Ref Offset 11.4 dB Ref 30.00 dBm</p> <p>Center: 5.745 GHz #Res BW 100 kHz #VBW 300 kHz Span 40 MHz Sweep 3.867 ms</p> <p>Occupied Bandwidth: 18.910 MHz Total Power: 26.7 dBm</p> <p>Transmit Freq Error: 2.912 kHz OBW Power: 99.00 % x dB Bandwidth: 18.78 MHz x dB: -6.00 dB</p> <p>File <BBS.png> saved</p>
5785 MHz	<p>Agilent Spectrum Analyzer - Occupied BW</p> <p>Center Freq: 5.785000000 GHz Trig: Free Run Ave/Hold: 1/1 #Att: 30 dB Radio Std: None Radio Device: BTS</p> <p>Ref Offset 11.4 dB Ref 30.00 dBm</p> <p>Center: 5.785 GHz #Res BW 100 kHz #VBW 300 kHz Span 40 MHz Sweep 3.867 ms</p> <p>Occupied Bandwidth: 18.971 MHz Total Power: 26.2 dBm</p> <p>Transmit Freq Error: 2.667 kHz OBW Power: 99.00 % x dB Bandwidth: 18.86 MHz x dB: -6.00 dB</p> <p>File <BBS.png> saved</p>
5825 MHz	<p>Agilent Spectrum Analyzer - Occupied BW</p> <p>Center Freq: 5.825000000 GHz Trig: Free Run Ave/Hold: 1/1 #Att: 30 dB Radio Std: None Radio Device: BTS</p> <p>Ref Offset 11.4 dB Ref 30.00 dBm</p> <p>Center: 5.825 GHz #Res BW 100 kHz #VBW 300 kHz Span 40 MHz Sweep 3.867 ms</p> <p>Occupied Bandwidth: 18.988 MHz Total Power: 26.2 dBm</p> <p>Transmit Freq Error: 9.488 kHz OBW Power: 99.00 % x dB Bandwidth: 19.06 MHz x dB: -6.00 dB</p> <p>File <BBS.png> saved</p>



Mode 7: IEEE 802.11ax 40 MHz Continuous TX mode_ANT-0

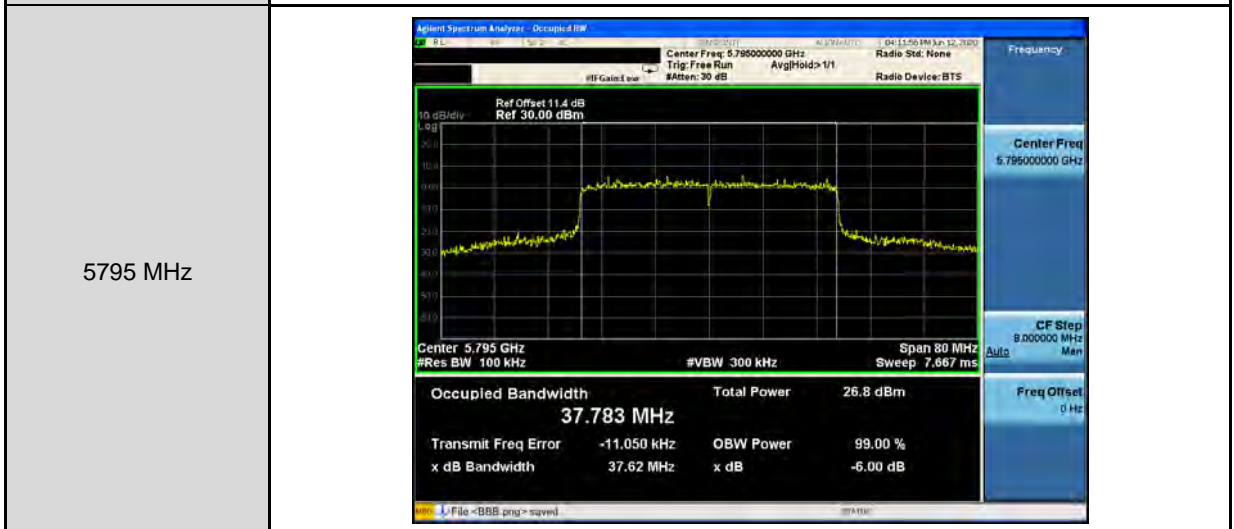
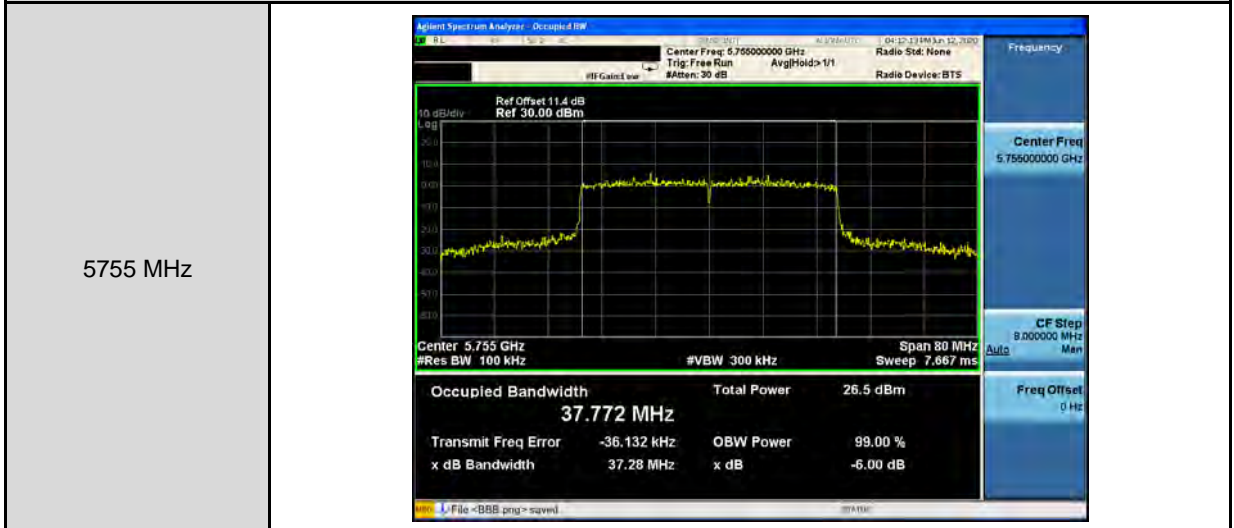

Mode 8: IEEE 802.11ax 80 MHz Continuous TX mode_ANT-0

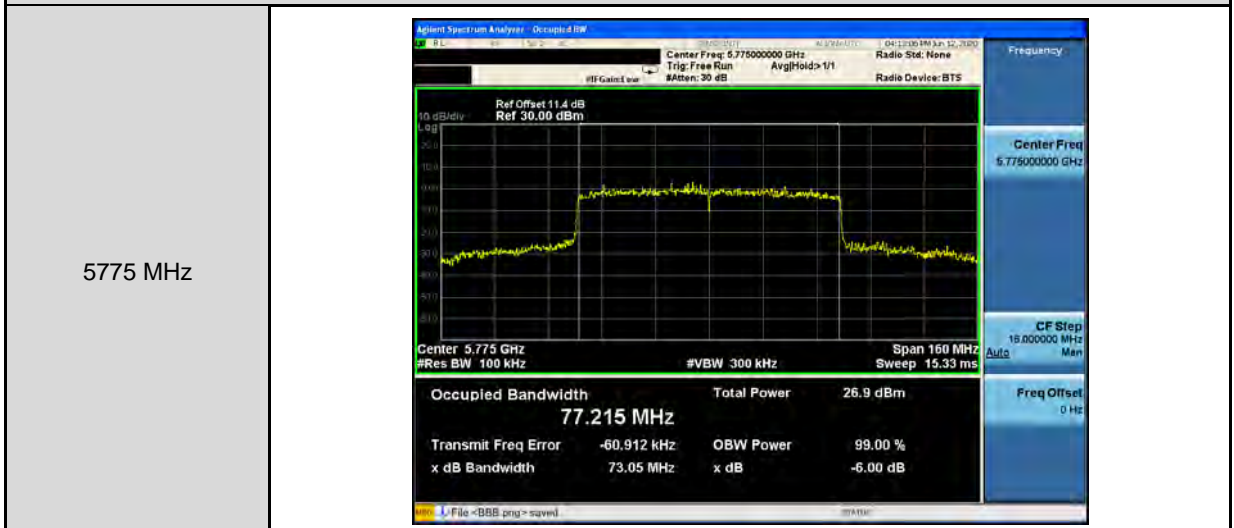



Mode 2: IEEE 802.11a Continuous TX mode_ANT-1	
5745 MHz	<p>Agilent Spectrum Analyzer - Occupied BW</p> <p>Center Freq: 5.745000000 GHz Trig: Free Run #IF Gate: 1 use #Atten: 30 dB Avg/Hold: 1/1 Radio Std: None Radio Device: BTS</p> <p>Ref Offset 11.4 dB Ref 30.00 dBm</p> <p>Center 5.745 GHz #Res BW 100 kHz #VBW 300 kHz Span 40 MHz Sweep 3.867 ms</p> <p>Occupied Bandwidth 16.455 MHz Total Power 25.9 dBm</p> <p>Transmit Freq Error -13.890 kHz OBW Power 99.00 % x dB Bandwidth 16.36 MHz x dB -6.00 dB</p> <p>File <BBS.png> saved</p>
5785 MHz	<p>Agilent Spectrum Analyzer - Occupied BW</p> <p>Center Freq: 5.785000000 GHz Trig: Free Run #IF Gate: 1 use #Atten: 30 dB Avg/Hold: 1/1 Radio Std: None Radio Device: BTS</p> <p>Ref Offset 11.4 dB Ref 30.00 dBm</p> <p>Center 5.785 GHz #Res BW 100 kHz #VBW 300 kHz Span 40 MHz Sweep 3.867 ms</p> <p>Occupied Bandwidth 16.461 MHz Total Power 25.3 dBm</p> <p>Transmit Freq Error -7.905 kHz OBW Power 99.00 % x dB Bandwidth 16.34 MHz x dB -6.00 dB</p> <p>File <BBS.png> saved</p>
5825 MHz	<p>Agilent Spectrum Analyzer - Occupied BW</p> <p>Center Freq: 5.825000000 GHz Trig: Free Run #IF Gate: 1 use #Atten: 30 dB Avg/Hold: 1/1 Radio Std: None Radio Device: BTS</p> <p>Ref Offset 11.4 dB Ref 30.00 dBm</p> <p>Center 5.825 GHz #Res BW 100 kHz #VBW 300 kHz Span 40 MHz Sweep 3.867 ms</p> <p>Occupied Bandwidth 16.489 MHz Total Power 25.3 dBm</p> <p>Transmit Freq Error 11.372 kHz OBW Power 99.00 % x dB Bandwidth 16.34 MHz x dB -6.00 dB</p> <p>File <BBS.png> saved</p>



Mode 3: IEEE 802.11ac 20 MHz Continuous TX mode_ANT-1	
5745 MHz	<p>Agilent Spectrum Analyzer - Occupied BW</p> <p>Center Freq: 5.745000000 GHz Trig: Free Run Ave/Hold: 1/1 #Att: 30 dB Radio Std: None Radio Device: BTS</p> <p>Ref Offset 11.4 dB Ref 30.00 dBm</p> <p>Center 5.745 GHz #Res BW 100 kHz #VBW 300 kHz Span 40 MHz Sweep 3.867 ms</p> <p>Occupied Bandwidth 17.631 MHz Total Power 25.7 dBm</p> <p>Transmit Freq Error -9.586 kHz OBW Power 99.00 % x dB Bandwidth 16.93 MHz x dB -6.00 dB</p> <p>File <BBS.png> saved</p>
5785 MHz	<p>Agilent Spectrum Analyzer - Occupied BW</p> <p>Center Freq: 5.785000000 GHz Trig: Free Run Ave/Hold: 1/1 #Att: 30 dB Radio Std: None Radio Device: BTS</p> <p>Ref Offset 11.4 dB Ref 30.00 dBm</p> <p>Center 5.785 GHz #Res BW 100 kHz #VBW 300 kHz Span 40 MHz Sweep 3.867 ms</p> <p>Occupied Bandwidth 17.615 MHz Total Power 25.4 dBm</p> <p>Transmit Freq Error -9.296 kHz OBW Power 99.00 % x dB Bandwidth 16.95 MHz x dB -6.00 dB</p> <p>File <BBS.png> saved</p>
5825 MHz	<p>Agilent Spectrum Analyzer - Occupied BW</p> <p>Center Freq: 5.825000000 GHz Trig: Free Run Ave/Hold: 1/1 #Att: 30 dB Radio Std: None Radio Device: BTS</p> <p>Ref Offset 11.4 dB Ref 30.00 dBm</p> <p>Center 5.825 GHz #Res BW 100 kHz #VBW 300 kHz Span 40 MHz Sweep 3.867 ms</p> <p>Occupied Bandwidth 17.654 MHz Total Power 25.2 dBm</p> <p>Transmit Freq Error 1.959 kHz OBW Power 99.00 % x dB Bandwidth 17.67 MHz x dB -6.00 dB</p> <p>File <BBS.png> saved</p>



Mode 4: IEEE 802.11ac 40 MHz Continuous TX mode_ANT-1

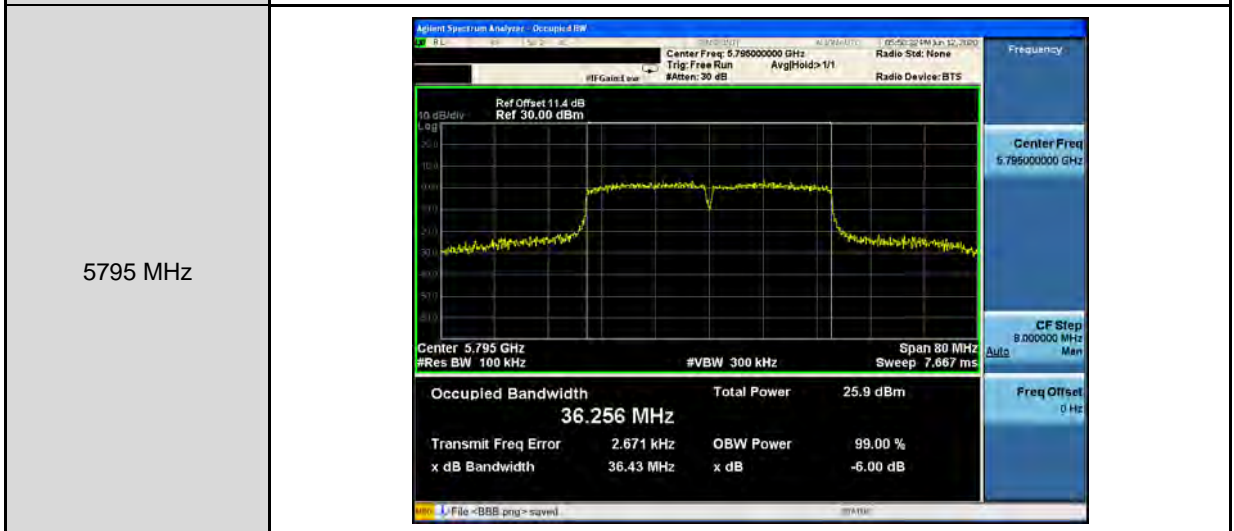
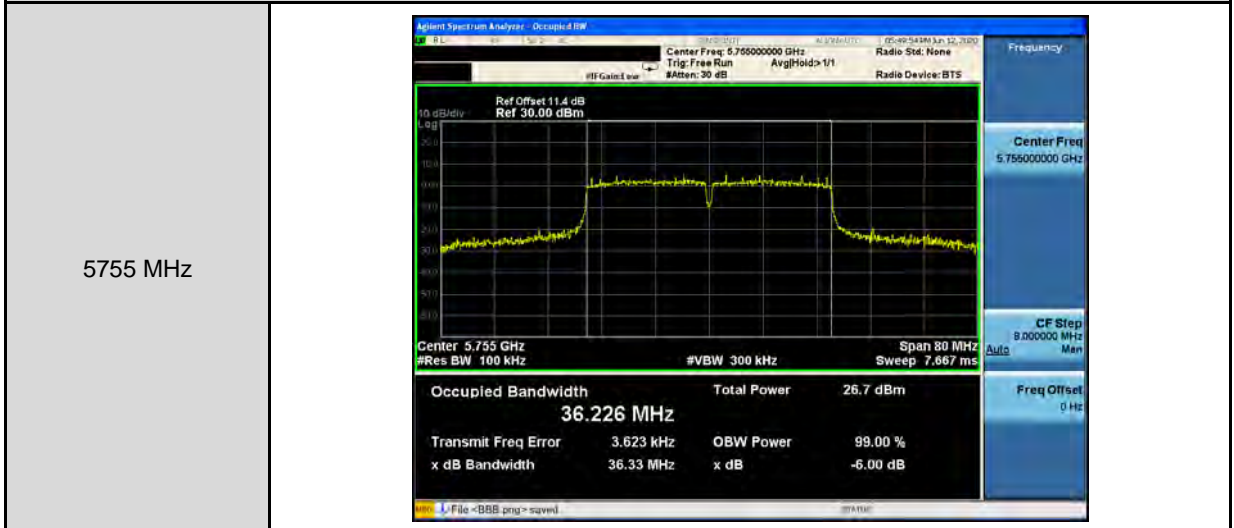

Mode 5: IEEE 802.11ac 80 MHz Continuous TX mode_ANT-1

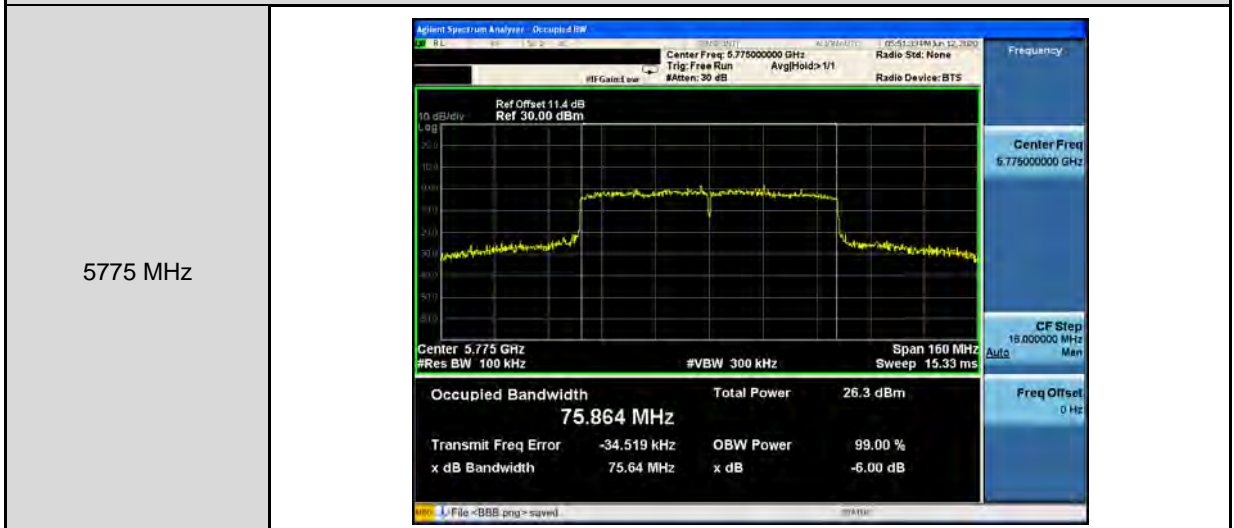



Mode 6: IEEE 802.11ax 20 MHz Continuous TX mode_ANT-1	
5745 MHz	<p>Center Freq: 5.745 GHz #Res BW: 100 kHz #VBW: 300 kHz Span: 40 MHz Sweep: 3.867 ms</p> <p>Occupied Bandwidth: 18.988 MHz Total Power: 25.8 dBm Transmit Freq Error: -2.745 kHz x dB Bandwidth: 19.04 MHz OBW Power: 99.00 % x dB: -6.00 dB</p>
5785 MHz	<p>Center Freq: 5.785 GHz #Res BW: 100 kHz #VBW: 300 kHz Span: 40 MHz Sweep: 3.867 ms</p> <p>Occupied Bandwidth: 19.029 MHz Total Power: 25.5 dBm Transmit Freq Error: 6.467 kHz x dB Bandwidth: 18.90 MHz OBW Power: 99.00 % x dB: -6.00 dB</p>
5825 MHz	<p>Center Freq: 5.825 GHz #Res BW: 100 kHz #VBW: 300 kHz Span: 40 MHz Sweep: 3.867 ms</p> <p>Occupied Bandwidth: 18.970 MHz Total Power: 25.4 dBm Transmit Freq Error: -5.497 kHz x dB Bandwidth: 19.06 MHz OBW Power: 99.00 % x dB: -6.00 dB</p>



Mode 7: IEEE 802.11ax 40 MHz Continuous TX mode_ANT-1

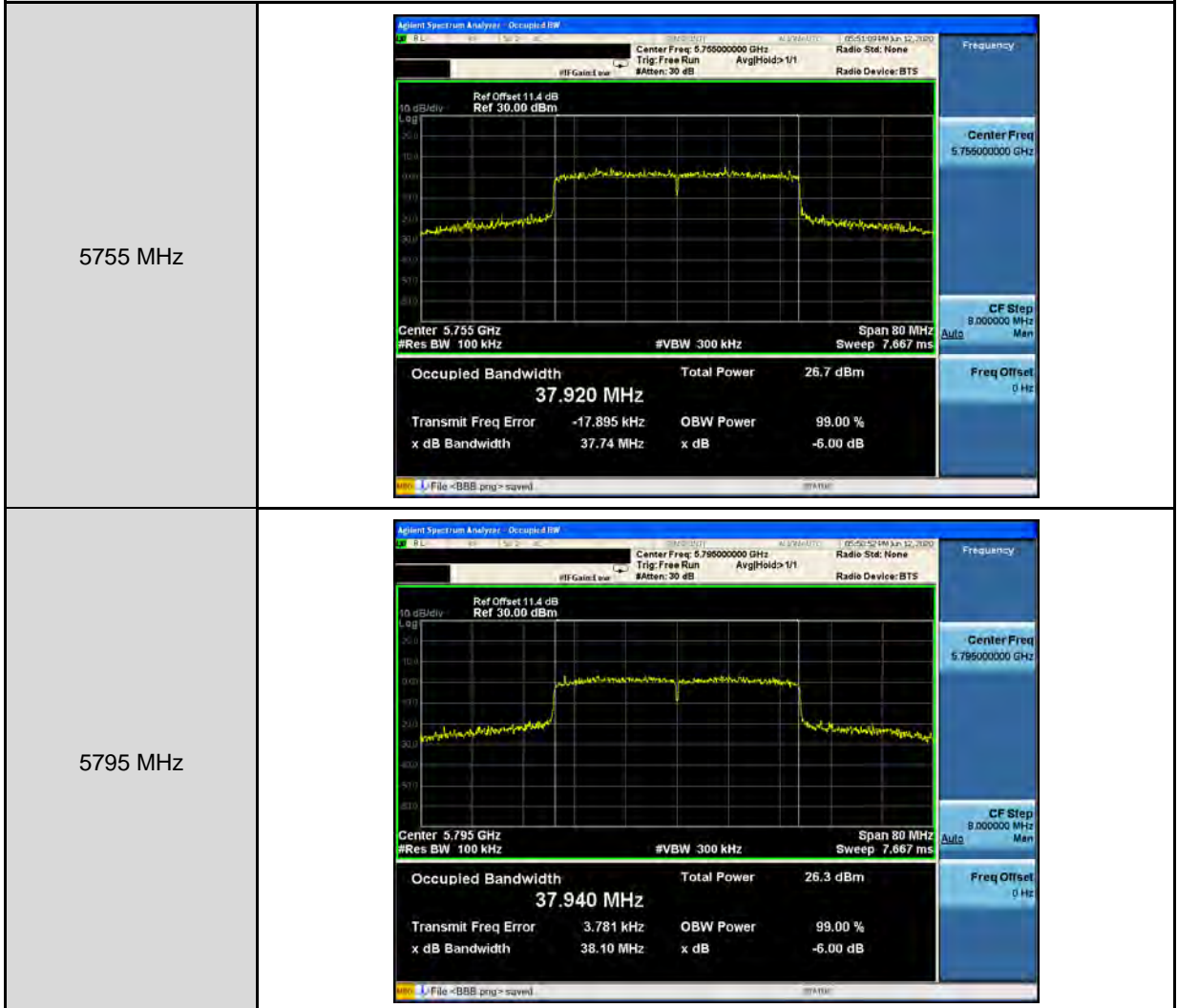

Mode 8: IEEE 802.11ax 80 MHz Continuous TX mode_ANT-1

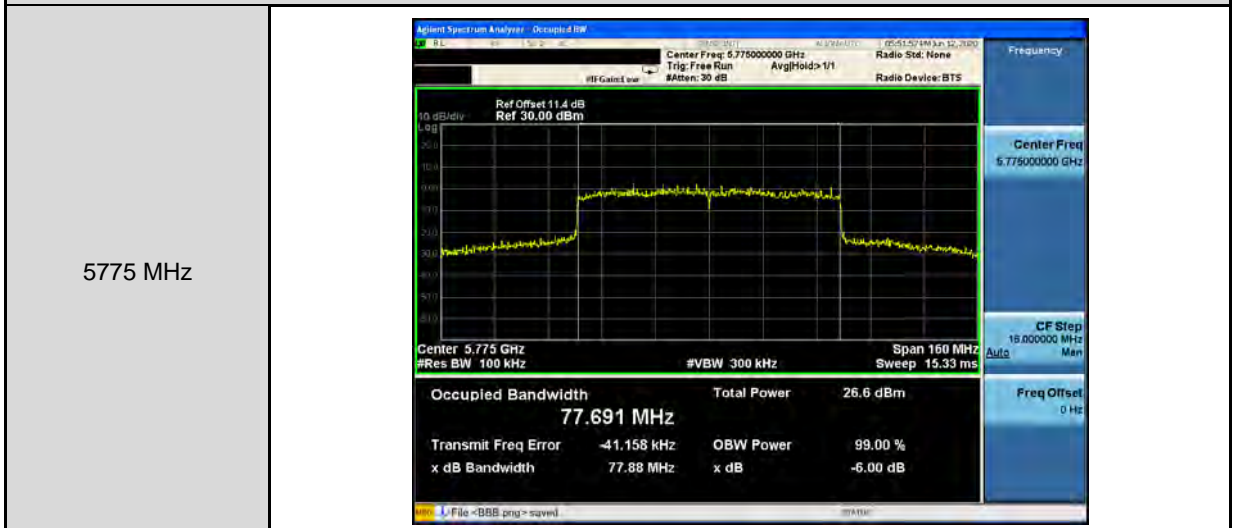



Mode 2: IEEE 802.11a Continuous TX mode_ANT-2	
5745 MHz	<p>Agilent Spectrum Analyzer - Occupied BW</p> <p>Center Freq: 5.745000000 GHz Trig: Free Run #Att: 30 dB Radio Std: None Radio Device: BTS</p> <p>Ref Offset 11.4 dB Ref 30.00 dBm</p> <p>Center 5.745 GHz #Res BW 100 kHz #VBW 300 kHz Span 40 MHz Sweep 3.867 ms</p> <p>Occupied Bandwidth 16.491 MHz Total Power 26.4 dBm</p> <p>Transmit Freq Error -5.486 kHz OBW Power 99.00 % x dB Bandwidth 16.37 MHz x dB -6.00 dB</p>
5785 MHz	<p>Agilent Spectrum Analyzer - Occupied BW</p> <p>Center Freq: 5.785000000 GHz Trig: Free Run #Att: 30 dB Radio Std: None Radio Device: BTS</p> <p>Ref Offset 11.4 dB Ref 30.00 dBm</p> <p>Center 5.785 GHz #Res BW 100 kHz #VBW 300 kHz Span 40 MHz Sweep 3.867 ms</p> <p>Occupied Bandwidth 16.555 MHz Total Power 26.2 dBm</p> <p>Transmit Freq Error 14.760 kHz OBW Power 99.00 % x dB Bandwidth 16.36 MHz x dB -6.00 dB</p>
5825 MHz	<p>Agilent Spectrum Analyzer - Occupied BW</p> <p>Center Freq: 5.825000000 GHz Trig: Free Run #Att: 30 dB Radio Std: None Radio Device: BTS</p> <p>Ref Offset 11.4 dB Ref 30.00 dBm</p> <p>Center 5.825 GHz #Res BW 100 kHz #VBW 300 kHz Span 40 MHz Sweep 3.867 ms</p> <p>Occupied Bandwidth 16.577 MHz Total Power 26.3 dBm</p> <p>Transmit Freq Error 16.748 kHz OBW Power 99.00 % x dB Bandwidth 15.94 MHz x dB -6.00 dB</p>



Mode 3: IEEE 802.11ac 20 MHz Continuous TX mode_ANT-2	
5745 MHz	<p>Agilent Spectrum Analyzer - Occupied BW</p> <p>Center Freq: 5.745000000 GHz Trig: Free Run #Att: 30 dB Avg/Hold: 1/1 Radio Std: None Radio Device: BTS</p> <p>Ref Offset 11.4 dB Ref 30.00 dBm</p> <p>Center 5.745 GHz #Res BW 100 kHz #VBW 300 kHz Span 40 MHz Sweep 3.867 ms</p> <p>Occupied Bandwidth 17.680 MHz Total Power 26.3 dBm</p> <p>Transmit Freq Error 10.017 kHz OBW Power 99.00 % x dB Bandwidth 17.61 MHz x dB -6.00 dB</p> <p>File <BBB.png> saved</p>
5785 MHz	<p>Agilent Spectrum Analyzer - Occupied BW</p> <p>Center Freq: 5.785000000 GHz Trig: Free Run #Att: 30 dB Avg/Hold: 1/1 Radio Std: None Radio Device: BTS</p> <p>Ref Offset 11.4 dB Ref 30.00 dBm</p> <p>Center 5.785 GHz #Res BW 100 kHz #VBW 300 kHz Span 40 MHz Sweep 3.867 ms</p> <p>Occupied Bandwidth 17.723 MHz Total Power 26.4 dBm</p> <p>Transmit Freq Error -12.547 kHz OBW Power 99.00 % x dB Bandwidth 17.62 MHz x dB -6.00 dB</p> <p>File <BBB.png> saved</p>
5825 MHz	<p>Agilent Spectrum Analyzer - Occupied BW</p> <p>Center Freq: 5.825000000 GHz Trig: Free Run #Att: 30 dB Avg/Hold: 1/1 Radio Std: None Radio Device: BTS</p> <p>Ref Offset 11.4 dB Ref 30.00 dBm</p> <p>Center 5.825 GHz #Res BW 100 kHz #VBW 300 kHz Span 40 MHz Sweep 3.867 ms</p> <p>Occupied Bandwidth 17.682 MHz Total Power 26.1 dBm</p> <p>Transmit Freq Error 6.588 kHz OBW Power 99.00 % x dB Bandwidth 17.62 MHz x dB -6.00 dB</p> <p>File <BBB.png> saved</p>



Mode 4: IEEE 802.11ac 40 MHz Continuous TX mode_ANT-2

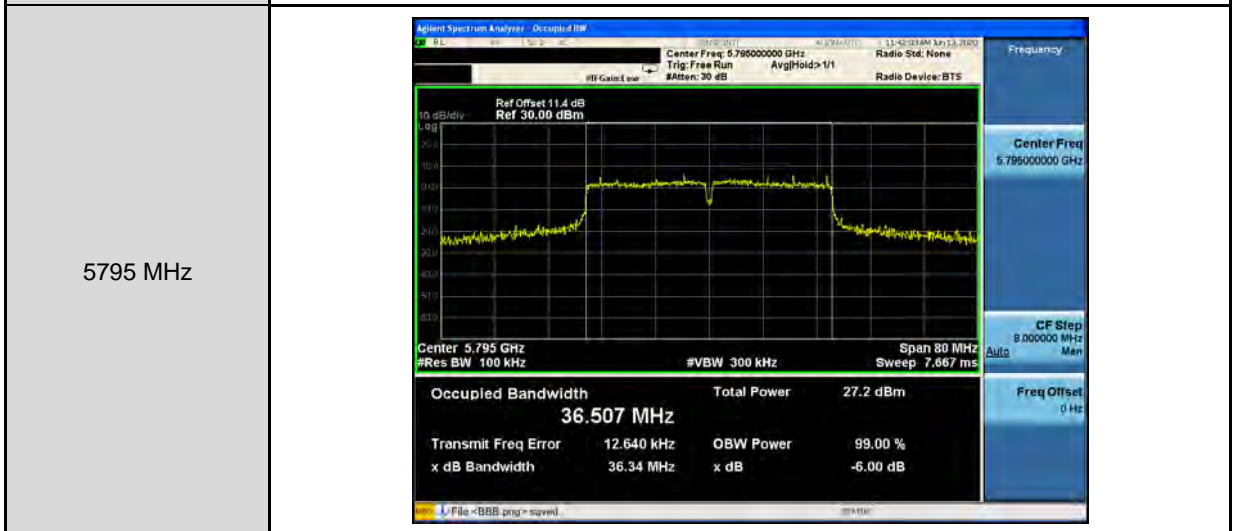
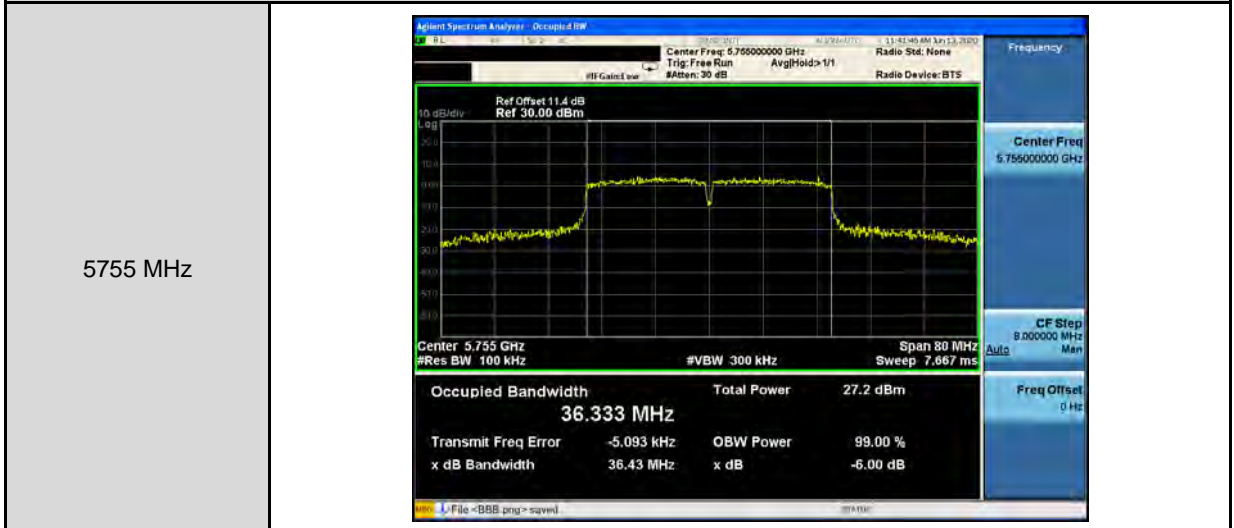

Mode 5: IEEE 802.11ac 80 MHz Continuous TX mode_ANT-2

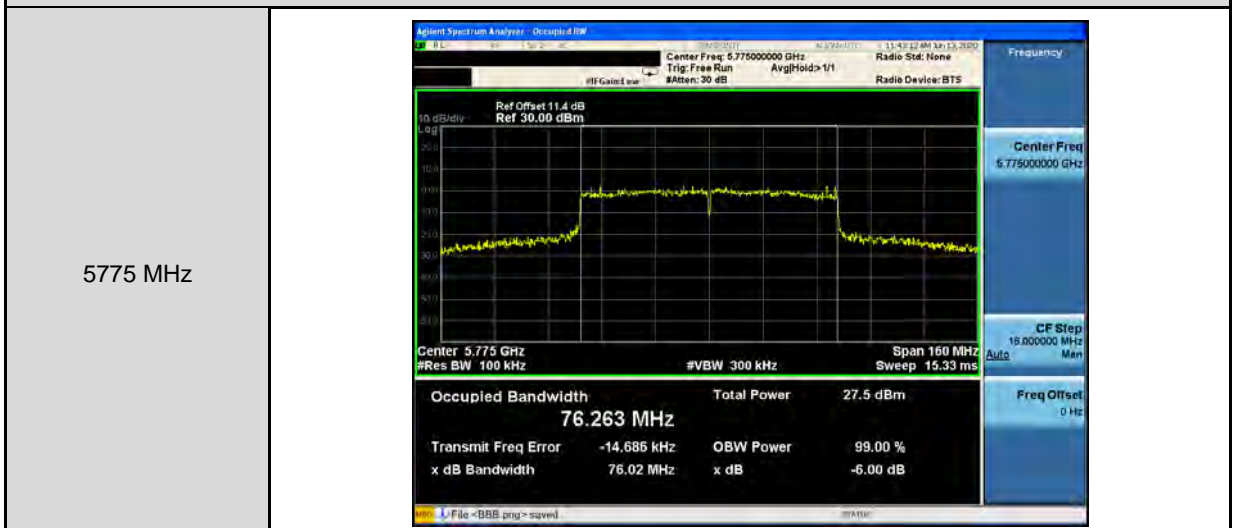



Mode 6: IEEE 802.11ax 20 MHz Continuous TX mode_ANT-2	
5745 MHz	<p>Agilent Spectrum Analyzer - Occupied BW</p> <p>Center Freq: 5.745000000 GHz Trig: Free Run #IF Gate: 1 use #Atten: 30 dB Avg/Hold: 1/1 Radio Std: None Radio Device: BTS</p> <p>Ref Offset 11.4 dB Ref 30.00 dBm</p> <p>Center: 5.745 GHz #Res BW 100 kHz #VBW 300 kHz Span 40 MHz Sweep 3.867 ms</p> <p>Occupied Bandwidth 19.008 MHz Total Power 26.5 dBm</p> <p>Transmit Freq Error -1.533 kHz OBW Power 99.00 % x dB Bandwidth 19.03 MHz x dB -6.00 dB</p> <p>File <BBS.png> saved</p>
5785 MHz	<p>Agilent Spectrum Analyzer - Occupied BW</p> <p>Center Freq: 5.785000000 GHz Trig: Free Run #IF Gate: 1 use #Atten: 30 dB Avg/Hold: 1/1 Radio Std: None Radio Device: BTS</p> <p>Ref Offset 11.4 dB Ref 30.00 dBm</p> <p>Center: 5.785 GHz #Res BW 100 kHz #VBW 300 kHz Span 40 MHz Sweep 3.867 ms</p> <p>Occupied Bandwidth 19.099 MHz Total Power 26.6 dBm</p> <p>Transmit Freq Error 409 Hz OBW Power 99.00 % x dB Bandwidth 18.81 MHz x dB -6.00 dB</p> <p>File <BBS.png> saved</p>
5825 MHz	<p>Agilent Spectrum Analyzer - Occupied BW</p> <p>Center Freq: 5.825000000 GHz Trig: Free Run #IF Gate: 1 use #Atten: 30 dB Avg/Hold: 1/1 Radio Std: None Radio Device: BTS</p> <p>Ref Offset 11.4 dB Ref 30.00 dBm</p> <p>Center: 5.825 GHz #Res BW 100 kHz #VBW 300 kHz Span 40 MHz Sweep 3.867 ms</p> <p>Occupied Bandwidth 19.033 MHz Total Power 26.4 dBm</p> <p>Transmit Freq Error 829 Hz OBW Power 99.00 % x dB Bandwidth 16.90 MHz x dB -6.00 dB</p> <p>File <BBS.png> saved</p>



Mode 7: IEEE 802.11ax 40 MHz Continuous TX mode_ANT-2

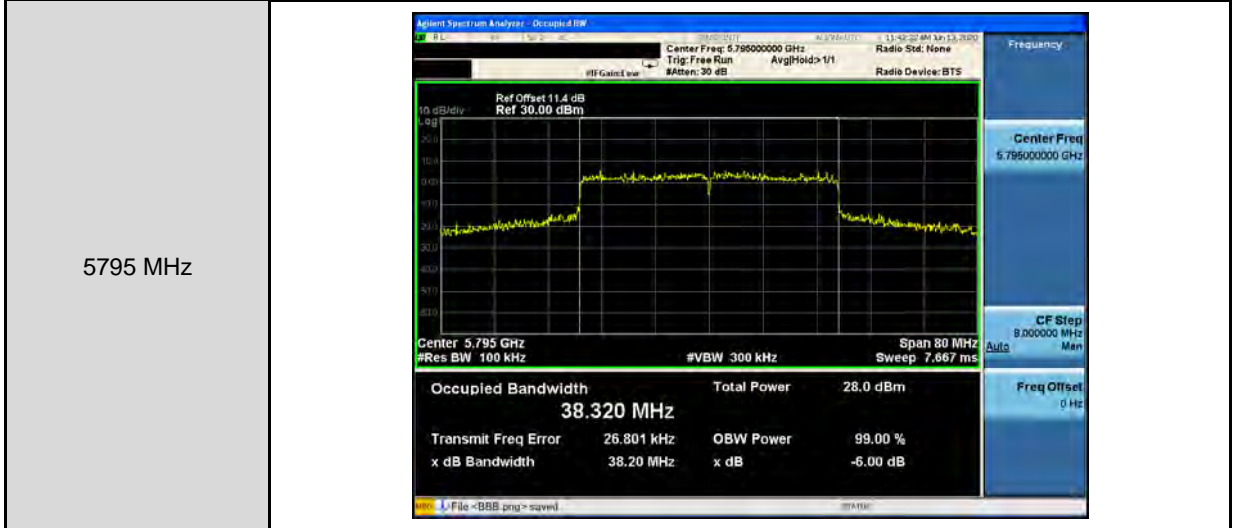
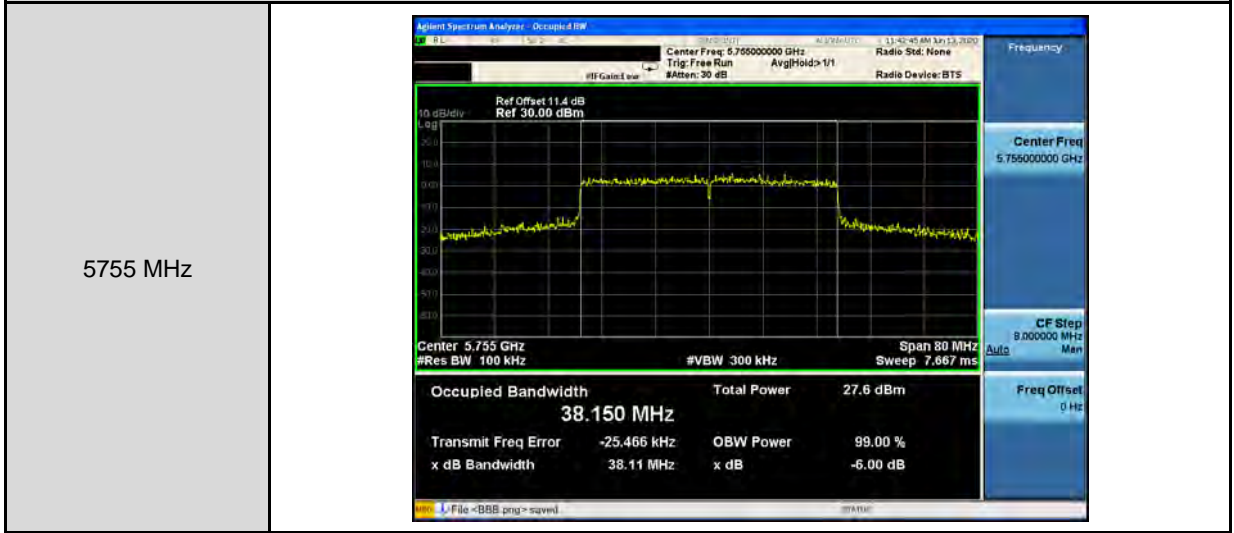

Mode 8: IEEE 802.11ax 80 MHz Continuous TX mode_ANT-2

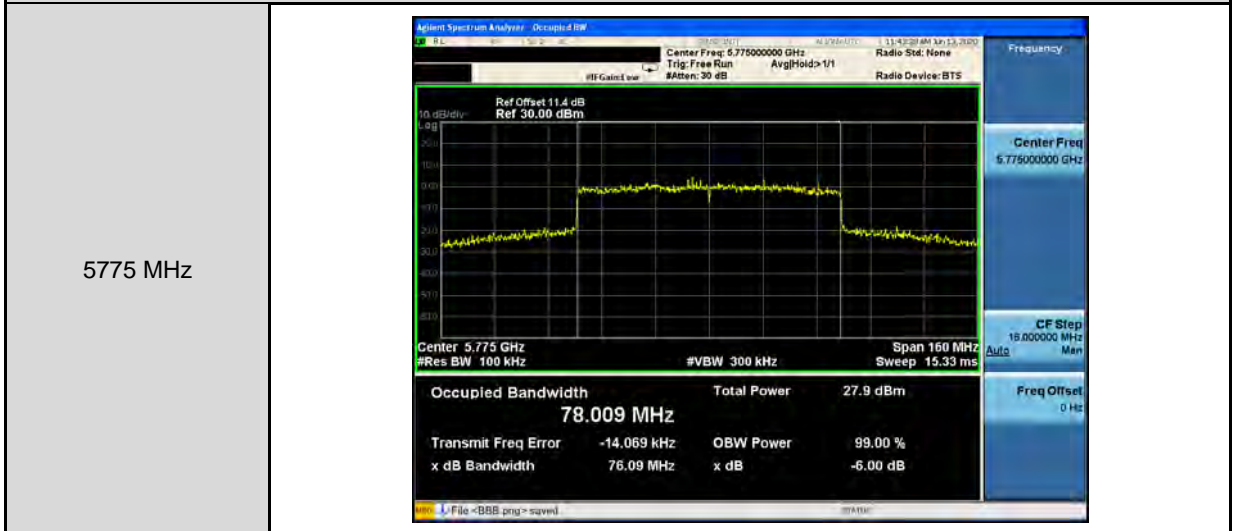



Mode 2: IEEE 802.11a Continuous TX mode_ANT-3	
5745 MHz	<p>Agilent Spectrum Analyzer - Occupied BW</p> <p>Center Freq: 5.745000000 GHz Trig: Free Run #Att: 30 dB</p> <p>Ref Offset 11.4 dB Ref 30.00 dBm</p> <p>Center 5.745 GHz #Res BW 100 kHz #VBW 300 kHz Span 40 MHz Sweep 3.867 ms</p> <p>Occupied Bandwidth: 16.454 MHz Total Power: 26.4 dBm</p> <p>Transmit Freq Error: -7.383 kHz OBW Power: 99.00 % x dB Bandwidth: 16.35 MHz x dB: -6.00 dB</p>
5785 MHz	<p>Agilent Spectrum Analyzer - Occupied BW</p> <p>Center Freq: 5.785000000 GHz Trig: Free Run #Att: 30 dB</p> <p>Ref Offset 11.4 dB Ref 30.00 dBm</p> <p>Center 5.785 GHz #Res BW 100 kHz #VBW 300 kHz Span 40 MHz Sweep 3.867 ms</p> <p>Occupied Bandwidth: 16.452 MHz Total Power: 26.0 dBm</p> <p>Transmit Freq Error: -5.208 kHz OBW Power: 99.00 % x dB Bandwidth: 16.09 MHz x dB: -6.00 dB</p>
5825 MHz	<p>Agilent Spectrum Analyzer - Occupied BW</p> <p>Center Freq: 5.825000000 GHz Trig: Free Run #Att: 30 dB</p> <p>Ref Offset 11.4 dB Ref 30.00 dBm</p> <p>Center 5.825 GHz #Res BW 100 kHz #VBW 300 kHz Span 40 MHz Sweep 3.867 ms</p> <p>Occupied Bandwidth: 16.473 MHz Total Power: 25.9 dBm</p> <p>Transmit Freq Error: 5.615 kHz OBW Power: 99.00 % x dB Bandwidth: 16.37 MHz x dB: -6.00 dB</p>



Mode 3: IEEE 802.11ac 20 MHz Continuous TX mode_ANT-3																			
5745 MHz	<p>Agilent Spectrum Analyzer - Occupied BW</p> <p>Center Freq: 5.745000000 GHz Trig: Free Run #Att: 30 dB Radio Std: None Radio Device: BTS</p> <p>Ref Offset 11.4 dB Ref 30.00 dBm</p> <p>Center 5.745 GHz #Res BW 100 kHz #VBW 300 kHz Span 40 MHz Sweep 3.867 ms</p> <table border="1"> <tr> <td>Occupied Bandwidth</td> <td>Total Power</td> <td>26.3 dBm</td> </tr> <tr> <td>17.649 MHz</td> <td></td> <td></td> </tr> <tr> <td>Transmit Freq Error</td> <td>OBW Power</td> <td>99.00 %</td> </tr> <tr> <td>903 Hz</td> <td>x dB</td> <td>-6.00 dB</td> </tr> <tr> <td>x dB Bandwidth</td> <td></td> <td></td> </tr> <tr> <td>17.67 MHz</td> <td></td> <td></td> </tr> </table>	Occupied Bandwidth	Total Power	26.3 dBm	17.649 MHz			Transmit Freq Error	OBW Power	99.00 %	903 Hz	x dB	-6.00 dB	x dB Bandwidth			17.67 MHz		
Occupied Bandwidth	Total Power	26.3 dBm																	
17.649 MHz																			
Transmit Freq Error	OBW Power	99.00 %																	
903 Hz	x dB	-6.00 dB																	
x dB Bandwidth																			
17.67 MHz																			
5785 MHz	<p>Agilent Spectrum Analyzer - Occupied BW</p> <p>Center Freq: 5.785000000 GHz Trig: Free Run #Att: 30 dB Radio Std: None Radio Device: BTS</p> <p>Ref Offset 11.4 dB Ref 30.00 dBm</p> <p>Center 5.785 GHz #Res BW 100 kHz #VBW 300 kHz Span 40 MHz Sweep 3.867 ms</p> <table border="1"> <tr> <td>Occupied Bandwidth</td> <td>Total Power</td> <td>25.7 dBm</td> </tr> <tr> <td>17.638 MHz</td> <td></td> <td></td> </tr> <tr> <td>Transmit Freq Error</td> <td>OBW Power</td> <td>99.00 %</td> </tr> <tr> <td>-8.753 kHz</td> <td>x dB</td> <td>-6.00 dB</td> </tr> <tr> <td>x dB Bandwidth</td> <td></td> <td></td> </tr> <tr> <td>17.68 MHz</td> <td></td> <td></td> </tr> </table>	Occupied Bandwidth	Total Power	25.7 dBm	17.638 MHz			Transmit Freq Error	OBW Power	99.00 %	-8.753 kHz	x dB	-6.00 dB	x dB Bandwidth			17.68 MHz		
Occupied Bandwidth	Total Power	25.7 dBm																	
17.638 MHz																			
Transmit Freq Error	OBW Power	99.00 %																	
-8.753 kHz	x dB	-6.00 dB																	
x dB Bandwidth																			
17.68 MHz																			
5825 MHz	<p>Agilent Spectrum Analyzer - Occupied BW</p> <p>Center Freq: 5.825000000 GHz Trig: Free Run #Att: 30 dB Radio Std: None Radio Device: BTS</p> <p>Ref Offset 11.4 dB Ref 30.00 dBm</p> <p>Center 5.825 GHz #Res BW 100 kHz #VBW 300 kHz Span 40 MHz Sweep 3.867 ms</p> <table border="1"> <tr> <td>Occupied Bandwidth</td> <td>Total Power</td> <td>25.9 dBm</td> </tr> <tr> <td>17.634 MHz</td> <td></td> <td></td> </tr> <tr> <td>Transmit Freq Error</td> <td>OBW Power</td> <td>99.00 %</td> </tr> <tr> <td>-2.914 kHz</td> <td>x dB</td> <td>-6.00 dB</td> </tr> <tr> <td>x dB Bandwidth</td> <td></td> <td></td> </tr> <tr> <td>17.32 MHz</td> <td></td> <td></td> </tr> </table>	Occupied Bandwidth	Total Power	25.9 dBm	17.634 MHz			Transmit Freq Error	OBW Power	99.00 %	-2.914 kHz	x dB	-6.00 dB	x dB Bandwidth			17.32 MHz		
Occupied Bandwidth	Total Power	25.9 dBm																	
17.634 MHz																			
Transmit Freq Error	OBW Power	99.00 %																	
-2.914 kHz	x dB	-6.00 dB																	
x dB Bandwidth																			
17.32 MHz																			

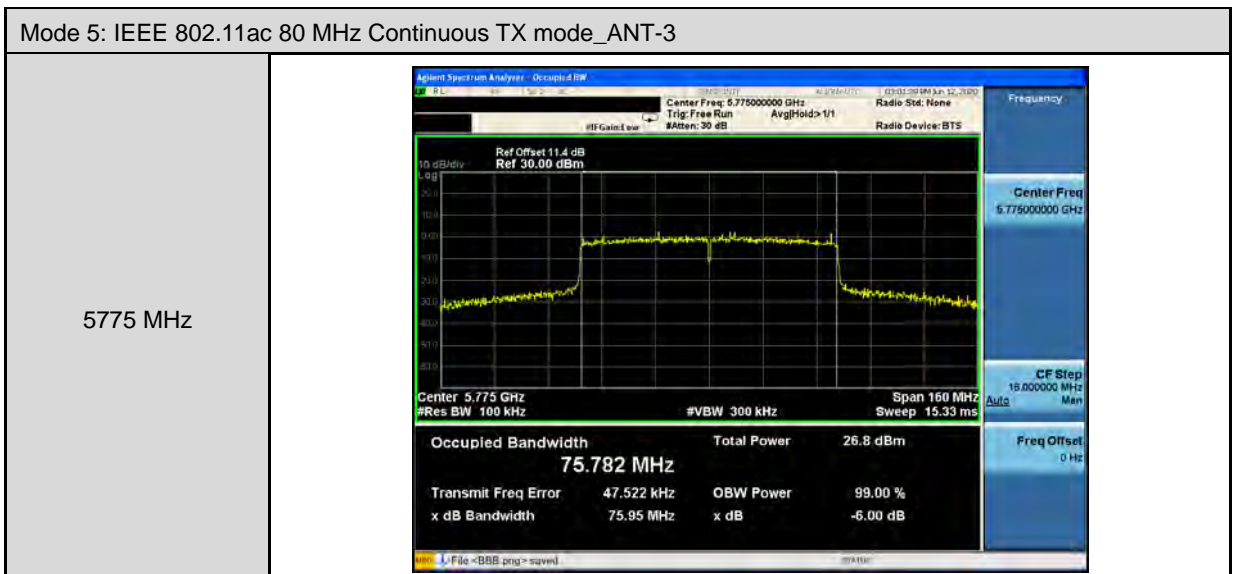
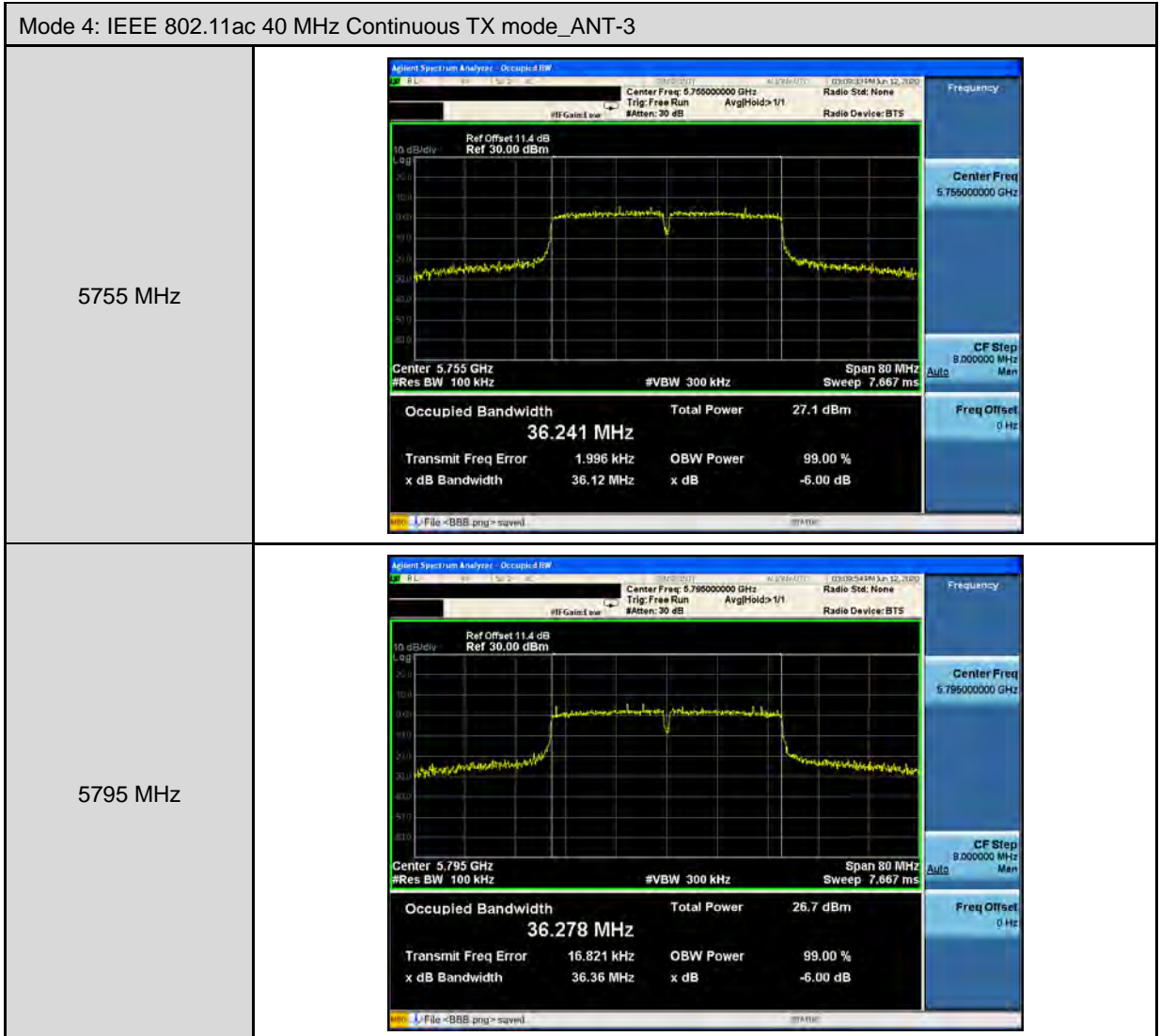



Mode 6: IEEE 802.11ax 20 MHz Continuous TX mode_ANT-3	
5745 MHz	<p>Agilent Spectrum Analyzer - Occupied BW</p> <p>Center Freq: 5.745000000 GHz Trig: Free Run Ave/Hold: 1/1 #Att: 30 dB Radio Std: None Radio Device: BTS</p> <p>Ref Offset 11.4 dB Ref 30.00 dBm</p> <p>Center 5.745 GHz #Res BW 100 kHz #VBW 300 kHz Span 40 MHz Sweep 3.867 ms</p> <p>Occupied Bandwidth 18.976 MHz Total Power 26.6 dBm</p> <p>Transmit Freq Error 2.287 kHz OBW Power 99.00 % x dB Bandwidth 18.84 MHz x dB -6.00 dB</p> <p>File <BBS.png> saved</p>
5785 MHz	<p>Agilent Spectrum Analyzer - Occupied BW</p> <p>Center Freq: 5.785000000 GHz Trig: Free Run Ave/Hold: 1/1 #Att: 30 dB Radio Std: None Radio Device: BTS</p> <p>Ref Offset 11.4 dB Ref 30.00 dBm</p> <p>Center 5.785 GHz #Res BW 100 kHz #VBW 300 kHz Span 40 MHz Sweep 3.867 ms</p> <p>Occupied Bandwidth 19.002 MHz Total Power 26.0 dBm</p> <p>Transmit Freq Error 13.937 kHz OBW Power 99.00 % x dB Bandwidth 18.97 MHz x dB -6.00 dB</p> <p>File <BBS.png> saved</p>
5825 MHz	<p>Agilent Spectrum Analyzer - Occupied BW</p> <p>Center Freq: 5.825000000 GHz Trig: Free Run Ave/Hold: 1/1 #Att: 30 dB Radio Std: None Radio Device: BTS</p> <p>Ref Offset 11.4 dB Ref 30.00 dBm</p> <p>Center 5.825 GHz #Res BW 100 kHz #VBW 300 kHz Span 40 MHz Sweep 3.867 ms</p> <p>Occupied Bandwidth 19.033 MHz Total Power 26.4 dBm</p> <p>Transmit Freq Error 9.340 kHz OBW Power 99.00 % x dB Bandwidth 18.34 MHz x dB -6.00 dB</p> <p>File <BBS.png> saved</p>



Mode 7: IEEE 802.11ax 40 MHz Continuous TX mode_ANT-3

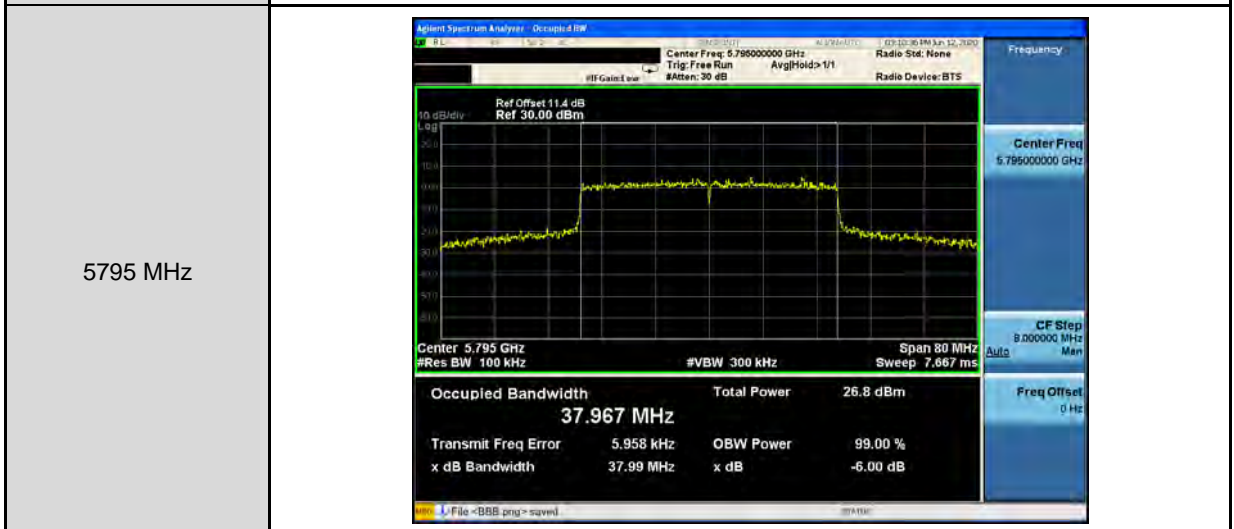
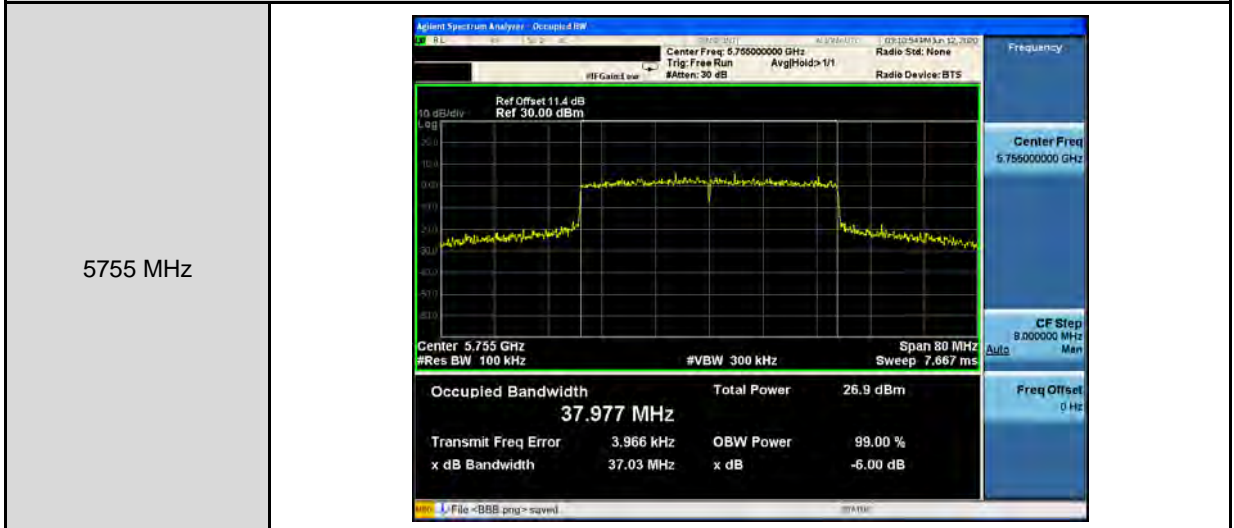

Mode 8: IEEE 802.11ax 80 MHz Continuous TX mode_ANT-3

