



<b>Prüfbericht-Nr.:</b> <i>Test report no.:</i>	CN21W8ZE (P15C-WiFi) 001	<b>Auftrags-Nr.:</b> <i>Order no.:</i>	238517914	Seite 1 von 35 Page 1 of 35
<b>Kunden-Referenz-Nr.:</b> <i>Client reference no.:</i>	N/A	<b>Auftragsdatum:</b> <i>Order date:</i>	2021-07-27	
<b>Auftraggeber:</b> <i>Client:</i>	Emplus Technologies, Inc Bld B, 10F, No.209, Sec.1, Nangang Rd., Taipei City, Taiwan			
<b>Prüfgegenstand:</b> <i>Test item:</i>	4x4 AX Dual band AP			
<b>Bezeichnung / Typ-Nr.:</b> <i>Identification / Type no.:</i>	WAP380			
<b>Auftrags-Inhalt:</b> <i>Order content:</i>	FCC Part 15C Test report (WiFi 2.4GHz)			
<b>Prüfgrundlage:</b> <i>Test specification:</i>	FCC 47CFR Part 15: Subpart C Section 15.247			
<b>Wareneingangsdatum:</b> <i>Date of sample receipt:</i>	2021-08-04			
<b>Prüfmuster-Nr.:</b> <i>Test sample no.:</i>	A003104381-001			
<b>Prüfzeitraum:</b> <i>Testing period:</i>	2021-08-26 - 2022-01-12			
<b>Ort der Prüfung:</b> <i>Place of testing:</i>	EMC/RF Taipei Testing Site			
<b>Prüflaboratorium:</b> <i>Testing laboratory:</i>	Taipei Testing Laboratories			
<b>Prüfergebnis*:</b> <i>Test result*:</i>	Pass			
<b>überprüft von:</b> <i>compiled by:</i>	<b>genehmigt von:</b> <i>authorized by:</i>			
<b>Datum:</b> <i>Date:</i> 2022-02-16	 Ethan Shao		 Brenda Chen	
<b>Stellung / Position:</b>	Assistant Project Engineer		Senior Project Manager	
<b>Sonstiges / Other:</b>				
<b>Zustand des Prüfgegenstandes bei Anlieferung:</b> <i>Condition of the test item at delivery:</i>		Prüfmuster vollständig und unbeschädigt <i>Test item complete and undamaged</i>		
* Legende:	1 = sehr gut P(ass) = entspricht o.g. Prüfgrundlage(n)	2 = gut F(ail) = entspricht nicht o.g. Prüfgrundlage(n)	3 = befriedigend N/A = nicht anwendbar	4 = ausreichend N/T = nicht getestet
* Legend:	1 = very good P(ass) = passed a.m. test specification(s)	2 = good F(ail) = failed a.m. test specification(s)	3 = satisfactory N/A = not applicable	4 = sufficient N/T = not tested
<b>Dieser Prüfbericht bezieht sich nur auf das o.g. Prüfmuster und darf ohne Genehmigung der Prüfstelle nicht auszugsweise vervielfältigt werden. Dieser Bericht berechtigt nicht zur Verwendung eines Prüfzeichens.</b> <i>This test report only relates to the a. m. test sample. Without permission of the test center this test report is not permitted to be duplicated in extracts. This test report does not entitle to carry any test mark.</i>				

## TEST SUMMARY

Report Section	FCC Clause	Test Item	Result
5.1.1	15.247(b) & 15.203	Antenna Requirement	Pass
5.1.2	15.247(b)(3)	Peak Output Power	Pass
5.1.3	15.247(a)(2)	6 dB Bandwidth	Pass
5.1.3	2.1049	99% Occupied Bandwidth	Pass
5.1.4	15.247(e)	Power Spectral Density	Pass
5.1.5	15.247(d)	Conducted Spurious Emissions and Band Edges	Pass
5.1.6	15.247(d) & 15.205 & 15.209	Radiated Spurious Emissions and Band Edges	Pass
5.2.1	15.207	Mains Conducted Emission	Pass

**Note:** Determining compliance based on the results of the compliance measurement, not taking into account measurement instrumentation uncertainty.

## Contents

<b>HISTORY OF THIS TEST REPORT .....</b>	<b>5</b>
<b>1. GENERAL REMARKS .....</b>	<b>6</b>
<b>1.1 COMPLEMENTARY MATERIALS.....</b>	<b>6</b>
<b>1.2 DECISION RULE OF CONFORMITY .....</b>	<b>6</b>
<b>2. TEST SITES .....</b>	<b>7</b>
<b>2.1 TEST LABORATORY .....</b>	<b>7</b>
<b>2.2 TEST FACILITY.....</b>	<b>7</b>
<b>2.3 TRACEABILITY .....</b>	<b>8</b>
<b>2.4 CALIBRATION .....</b>	<b>8</b>
<b>2.5 MEASUREMENT UNCERTAINTY .....</b>	<b>8</b>
<b>3. GENERAL PRODUCT INFORMATION.....</b>	<b>9</b>
<b>3.1 PRODUCT FUNCTION AND INTENDED USE .....</b>	<b>9</b>
<b>3.2 SYSTEM DETAILS AND RATINGS.....</b>	<b>9</b>
<b>3.3 NOISE GENERATING AND NOISE SUPPRESSING PARTS .....</b>	<b>10</b>
<b>3.4 SUBMITTED DOCUMENTS.....</b>	<b>10</b>
<b>4. TEST SET-UP AND OPERATION MODES.....</b>	<b>11</b>
<b>4.1 PRINCIPLE OF CONFIGURATION SELECTION .....</b>	<b>11</b>
<b>4.2 CARRIER FREQUENCY AND CHANNEL.....</b>	<b>11</b>
<b>4.3 TEST OPERATION AND TEST SOFTWARE.....</b>	<b>12</b>
<b>4.4 SPECIAL ACCESSORIES AND AUXILIARY EQUIPMENT .....</b>	<b>14</b>
<b>4.5 TEST SETUP DIAGRAM .....</b>	<b>14</b>
<b>4.6 DUTY CYCLE OF TEST SIGNAL .....</b>	<b>17</b>
<b>5. TEST RESULTS .....</b>	<b>19</b>
<b>5.1 TRANSMITTER REQUIREMENT &amp; TEST SUITES.....</b>	<b>19</b>
5.1.1 <i>Antenna Requirement .....</i>	<i>19</i>
5.1.2 <i>Peak Output Power .....</i>	<i>20</i>
5.1.3 <i>6 dB Bandwidth and 99% Occupied Bandwidth.....</i>	<i>26</i>
5.1.4 <i>Power Spectral Density.....</i>	<i>27</i>
5.1.5 <i>Conducted Spurious Emissions and Frequency Band Edges Measured in 100 kHz Bandwidth.....</i>	<i>28</i>
5.1.6 <i>Radiated Spurious Emissions and Band Edges .....</i>	<i>29</i>
<b>5.2 MAINS EMISSION .....</b>	<b>34</b>
5.2.1 <i>Mains Conducted Emission.....</i>	<i>34</i>

**Prüfbericht - Nr.: CN21W8ZE (P15C-WiFi) 001**  
Test Report No.

Seite 4 von 35  
Page 4 of 35

**APPENDIX A - TEST RESULT OF CONDUCTED**

**APPENDIX B - TEST RESULT OF RADIATED EMISSIONS & MAINS CONDUCTED EMISSION**

**APPENDIX SP - PHOTOGRAPHS OF TEST SETUP**

**APPENDIX EP - PHOTOGRAPHS OF EUT**

**Prüfbericht - Nr.: CN21W8ZE (P15C-WiFi) 001**  
Test Report No.

Seite 5 von 35  
Page 5 of 35

## HISTORY OF THIS TEST REPORT

Report No.	Description	Date Issued
CN21W8ZE (P15C-WiFi) 001	Original Release	2022-02-16

## 1. General Remarks

### 1.1 Complementary Materials

All attachments are integral parts of this test report. This applies especially to the following appendix:

**Appendix A - Test Result of Conducted**

**Appendix B - Test Result of Radiated Emissions & Mains Conducted Emission**

**Appendix SP - Photographs of Test Setup**

**Appendix EP - Photographs of EUT**

### Applied Standard and Test Levels

Radio
FCC 47CFR Part 15: Subpart C Section 15.247
FCC 47CFR Part 2: Subpart J Section 2.1049
ANSI C63.10:2013
KDB 558074 D01 15.247 Meas Guidance v05r02
KDB 662911 D01 Multiple Transmitter Output v02r01

### 1.2 Decision Rule of Conformity

The decision rule of conformity of this test report is following the requirements of the requested standard in the quotation, and agreed among testing laboratory and manufacturer (applicant) to exclude the consideration of Measurement Uncertainty, unless it is required by the specific standard.

## 2. Test Sites

### 2.1 Test Laboratory

Taipei Testing Laboratories

11F. No.758, Sec. 4, Bade Rd., Songshan Dist.  
Taipei City 105  
Taiwan (R.O.C.)

### 2.2 Test Facility

Taipei Testing Laboratories

No.458-18, Sec. 2, Fenliao Rd., Linkou Dist.,  
New Taipei City 244  
Taiwan (R.O.C.)  
FCC Registration No.: 226631  
ISED Registration No.: 25563

## 2.3 Traceability

All measurement equipment calibrations are traceable to NML(Taiwan)/NIST(USA) or where calibration is performed outside Taiwan, to equivalent nationally recognized standards organizations.

## 2.4 Calibration

Equipment requiring calibration is calibrated periodically in a suitably accredited Calibration Lab. Additionally all equipment is verified for proper performance on a regular basis using in house standards or comparisons.

## 2.5 Measurement Uncertainty

All measurement uncertainty values are shown with a coverage factor of  $k=2$  to indicate a 95% level of confidence.

### Emission Measurement Uncertainty

Parameter	Uncertainty
Radiated Emission (9 kHz ~ 30 MHz)	$\pm 1.15$ dB
Radiated Emission (30 MHz ~ 200 MHz)	$\pm 1.30$ dB
Radiated Emission (200 MHz ~ 1 GHz)	$\pm 1.30$ dB
Radiated Emission (1 GHz ~ 18 GHz)	$\pm 1.54$ dB
Radiated Emission (18 GHz ~ 40 GHz)	$\pm 2.52$ dB
Mains Conducted Emission	$\pm 1.65$ dB



### 3. General Product Information

#### 3.1 Product Function and Intended Use

The EUT is a 4x4 AX Dual band AP. It contains a WLAN compatible module enabling the user to communicate data through a Wireless interface.

For details refer to the User Guide, Data Sheet and Circuit Diagram.

#### 3.2 System Details and Ratings

##### Basic Information of EUT

Item	EUT information
Kind of Equipment/Test Item	4x4 AX Dual band AP
Type Identification	WAP380
FCC ID	2AL6XWAP380-A1

##### Technical Specification of EUT

Item	EUT information	
Operating Frequency	2412 MHz ~ 2462 MHz	
Channel Spacing	5 MHz	
Channel Number	802.11b/g/n/ax HT20/HE20: 11 802.11n/ax HT40/HE40: 7	
Data Rate	802.11b: 11.0 / 5.5 / 2.0 / 1.0 Mbps 802.11g: 54.0 / 48.0 / 36.0 / 24.0 / 18.0 / 12.0 / 9.0 / 6.0 Mbps 802.11n/ax: up to MCS11	
Operation Voltage	12 Vdc (Adapter) 54 Vdc (POE Injector)	
Modulation	DSSS (DBPSK, DQPSK, CCK) OFDM (BPSK, QPSK, 16QAM, 64QAM, 256QAM) OFDMA (1024QAM)	
Maximum Output Power (mW)	CDD Mode	802.11b: 589.63
		802.11g: 989.54
		802.11n HT20: 981.27
		802.11n HT40: 787.08
	Beamforming Mode	802.11ax HE20: 997.26
		802.11ax HE40: 742.59
		802.11n HT20: 245.35
		802.11n HT40: 196.8
		802.11ax HE20: 249.35
		802.11ax HE40: 185.67
Antenna Information	Refer to 5.1.1	
Accessory Device	Refer to 4.4	

### **3.3 Noise Generating and Noise Suppressing Parts**

Refer to the Circuit Diagram.

### **3.4 Submitted Documents**

- Circuit Diagram
- Instruction Manual
- Rating Label
- Technical Description

## 4. Test Set-up and Operation Modes

### 4.1 Principle of Configuration Selection

The test modes were adapted accordingly in reference to the instructions for use.

During testing, Channel and Power Controlling Software provided by the customer was used to control the operating channel as well as the output power level. The RF output power selection is for the setting of RF output expected by the customer and is going to be fixed on the firmware of the final end product.

**Table for Parameters of Test Software Setting**

802.11b		802.11g		802.11n HT20		802.11n HT40	
Channel	Power Setting	Channel	Power Setting	Channel	Power Setting	Channel	Power Setting
1	18.5	1	16.5	1	16.5	3	16
6	18.5	6	19.5	6	19.5	6	17.5
11	18.5	11	16.5	11	16.5	9	15.5
802.11ax HE20		802.11ax HE40					
Channel	Power Setting	Channel	Power Setting				
1	16	3	15.5				
6	19.5	6	16.5				
11	14.5	9	14				

### 4.2 Carrier Frequency and Channel

802.11b, 802.11g, 802.11n HT20, 802.11ax HE20:

Channel	Frequency (MHz)	Channel	Frequency (MHz)
1	2412	8	2447
2	2417	9	2452
3	2422	10	2457
4	2427	11	2462
5	2432		
6	2437		
7	2442		

802.11n HT40, 802.11ax HE40:

Channel	Frequency (MHz)	Channel	Frequency (MHz)
3	2422	7	2442
4	2427	8	2447
5	2432	9	2452
6	2437		

### 4.3 Test Operation and Test Software

Setup for testing: Test samples are provided with a LAN interface which makes it possible to control them through a test software installed on a notebook computer.

This software was running on the laptop computer connected to the EUT. It was used to enable the operation modes listed as below.

Test Software	QSPR 5.0-00197
---------------	----------------

The samples were used as follows:  
A003104381-001

Full test was applied on all test modes, but only worst case was shown.

The EUT incorporates a MIMO function. Physically, the EUT provides four completed transmitters and receivers.

Modulation Mode	Tx Function
802.11b	4TX (MIMO)
802.11g	4TX (MIMO)
802.11n HT20	4TX (MIMO)
802.11n HT40	4TX (MIMO)
802.11ax HE20	4TX (MIMO)
802.11ax HE40	4TX (MIMO)

\* The modulation and bandwidth are similar for 802.11n mode HT20/HT40 and 802.11ax mode HE20/HE40, therefore investigated worse case as representative mode in test report.

\*\* For Beamforming mode, only output power is evaluated and presented in this report.

EUT Configure Mode	Applicable To				Description
	Antenna Port Conducted Measurement	Radiated Spurious Emissions above 1 GHz	Radiated Spurious Emissions below 1 GHz	Mains Conducted Emission	
-	√	√	√	√	-

Note:

1. The EUT had been pre-tested on the positioned of each 3 axis. The worst case was found when position on **X-plane**.
2. "-" means no effect.
3. Only the worst case of Radiated Spurious Emissions and Mains Conducted Emission tests were verified for POE mode.

#### Antenna Port Conducted Measurement

- Pre-Scan full test was applied on all test modes, but only worst case was shown.
- Following channel(s) was (were) selected for the final test as listed below.

EUT Configure Mode	Mode	Available Channel	Tested Channel	Date Rate (Mbps)
CDD	802.11b	1 to 11	1, 6, 11	1.0
	802.11g	1 to 11	1, 6, 11	6.0
	802.11n HT20	1 to 11	1, 6, 11	MCS0
	802.11n HT40	3 to 9	3, 6, 9	MCS0
	802.11ax HE20	1 to 11	1, 6, 11	MCS0
	802.11ax HE40	3 to 9	3, 6, 9	MCS0
Beamforming (Power only)	802.11n HT20	1 to 11	1, 6, 11	MCS0
	802.11n HT40	3 to 9	3, 6, 9	MCS0
	802.11ax HE20	1 to 11	1, 6, 11	MCS0
	802.11ax HE40	3 to 9	3, 6, 9	MCS0

**Radiated Spurious Emissions (Above 1 GHz)**

- Pre-Scan full test was applied on all test modes, but only worst case was shown.  
 Following channel(s) was (were) selected for the final test as listed below.

EUT Configure Mode	Mode	Available Channel	Tested Channel	Date Rate (Mbps)
Adapter	802.11b	1 to 11	1, 6, 11	1.0
	802.11g	1 to 11	1, 6, 11	6.0
	802.11n HT20	1 to 11	1, 6, 11	MCS0
	802.11n HT40	3 to 9	3, 6, 9	MCS0
	802.11ax HE20	1 to 11	1, 6, 11	MCS0
	802.11ax HE40	3 to 9	3, 6, 9	MCS0
POE	802.11g	1 to 11	1	6.0

**Radiated Spurious Emissions (Below 1 GHz)**

- Pre-Scan full test was applied on all test modes, but only worst case was shown.  
 Following channel(s) was (were) selected for the final test as listed below.

EUT Configure Mode	Mode	Available Channel	Tested Channel	Date Rate (Mbps)
Adapter	802.11g	1 to 11	1	6.0
POE	802.11g	1 to 11	1	6.0

**Mains Conducted Emission**

- Pre-Scan full test was applied on all test modes, but only worst case was shown.  
 Following channel(s) was (were) selected for the final test as listed below.

EUT Configure Mode	Mode	Available Channel	Tested Channel	Date Rate (Mbps)
Adapter	802.11g	1 to 11	1	6.0
POE	802.11g	1 to 11	1	6.0

**Test Condition**

Test Item	Ambient Temperature	Relative Humidity	Tested by
Conducted Measurement	18-24.7 °C	53-58 %	Nick Hsu
Radiated Spurious Emissions above 1 GHz	23.1-25.1 °C	50-60 %	Simon Tsai & Hunter Wang
Radiated Spurious Emissions below 1 GHz	23.1-25.1 °C	50-60 %	Simon Tsai & Hunter Wang
Mains Conducted Emission	22.1 °C	59 %	Hunter Wang

## 4.4 Special Accessories and Auxiliary Equipment

The product has been tested together with the following additional accessories:

### Accessory of EUT

None

### Support Unit

Support Unit								
No	Description	Brand	Model	S/N	Shielded	Ferrite Core (Qty)	Length (cm)	Remark
Adapter Mode								
1	Notebook	Lenovo	TP00094A	SL10Q37402	-	-	-	Radiated
2	LAN Cable	TUV	TUV-010	N/A	NO	NO	300	
A	Adapter	DEE VAN Enterprise	DSA-30PFG-12 FUS	N/A	NO	NO	148	
1	LAN Cable	N/A	N/A	11801	NO	NO	95	Mains Conducted
2	Notebook	Lenovo	81BL	MP1DCD6Y	-	-	-	
A	Adapter	DEE VAN Enterprise	DSA-30PFG-12 FUS	N/A	NO	NO	148	
-	Notebook	HP	TPN-C135	CND9111RJB	-	-	-	Conducted
POE Mode								
1	LAN Cable	TUV-JP	TUV-JP-001	NO	NO	NO	143	Radiated
2	LAN Cable	TUV-JP	TUV-JP-001	NO	NO	NO	300	
3	Notebook	HP	15s-du0007TX	CND93662VF	-	-	-	
B	POE Adapter	EPA	EPA5006GAT	N/A	NO	NO	55	Mains Conducted
1	LAN Cable	TUV-JP	TUV-JP-001	NO	NO	NO	120	
2	LAN Cable	TUV-JP	TUV-JP-001	NO	NO	NO	180	
3	Notebook	HP	15s-du0007TX	CND93662VF	-	-	-	
B	POE Adapter	EPA	EPA5006GAT	N/A	NO	NO	55	

### 4.5 Test Setup Diagram

<Radiated Spurious Emissions mode>  
 Adapter Mode

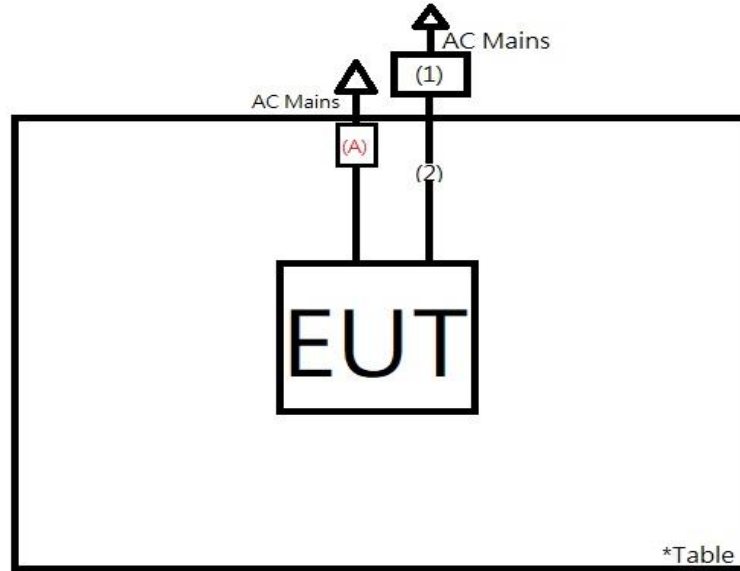

POE Mode

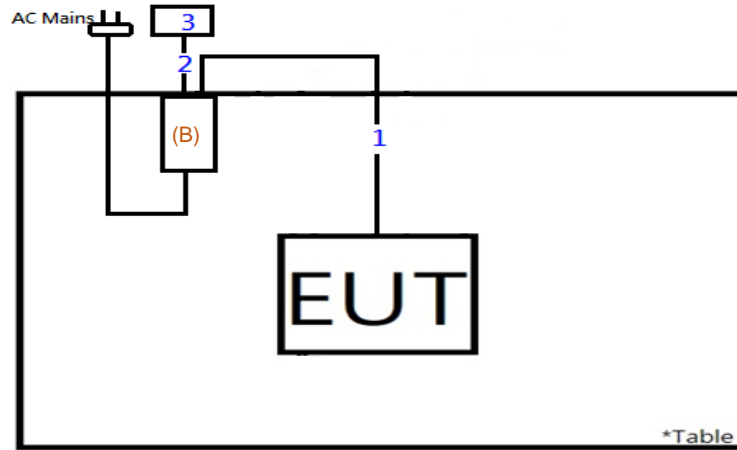

<Mains Conducted Emission mode>

Adapter Mode

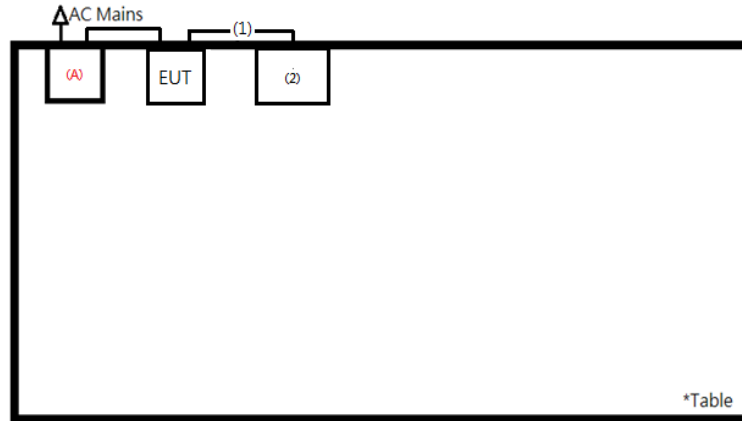

POE Mode

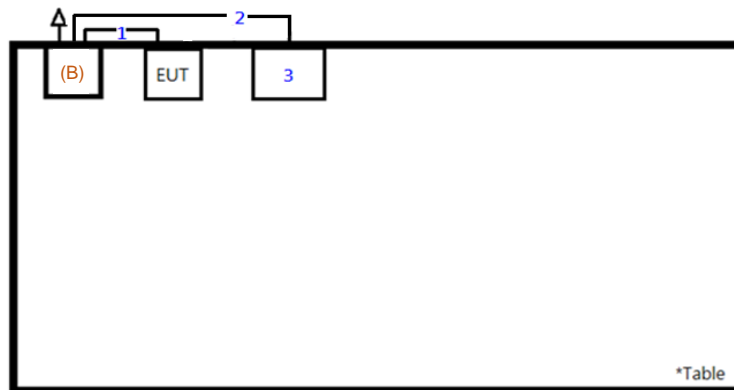



## 4.6 Duty Cycle of Test Signal

Mode	On + Off Time (ms)	On Time (ms)	Duty Cycle (%)	Duty Factor (dB)
802.11b	0.865	0.645	74.57	1.27
802.11g	1.56	1.405	90.06	0.45
802.11n HT20	5.82	5.41	92.96	0.32
802.11n HT40	5.8	5.4	93.10	0.31
802.11ax HE20	5.83	5.42	92.97	0.32
802.11ax HE40	5.7	5.41	94.91	0.23

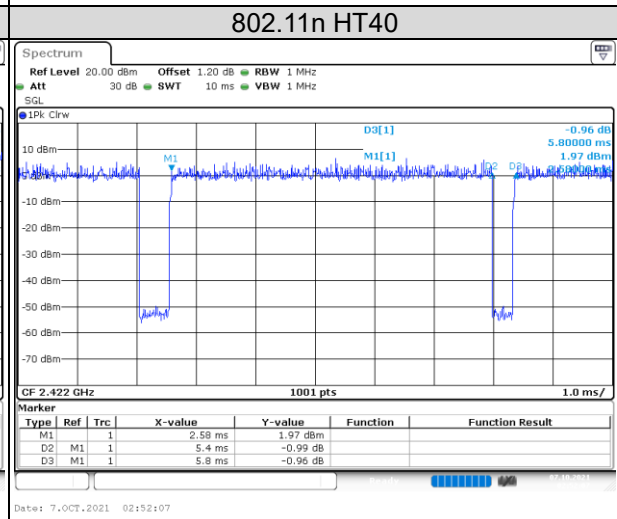
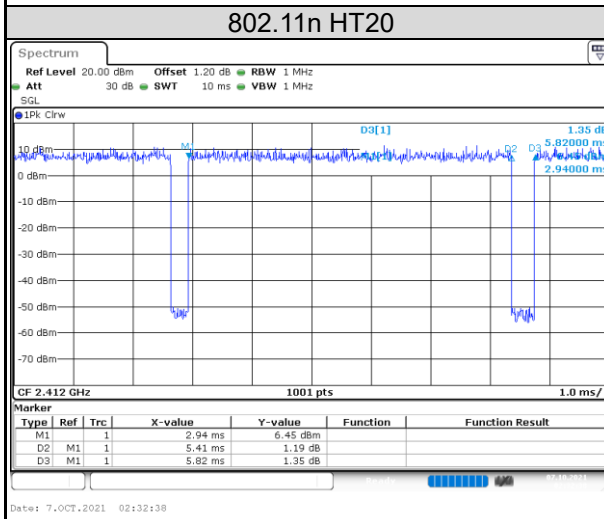
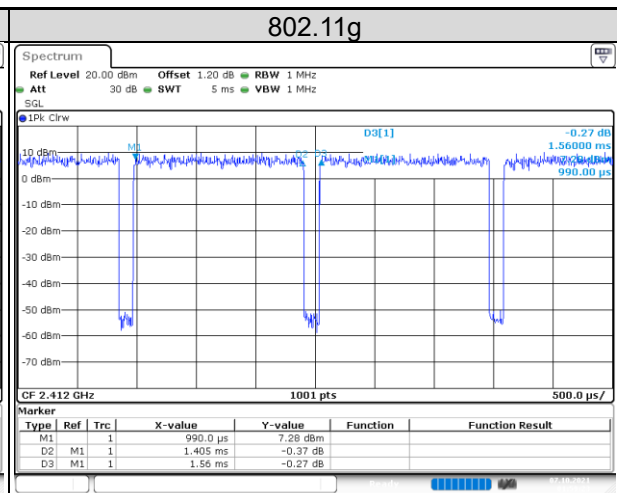
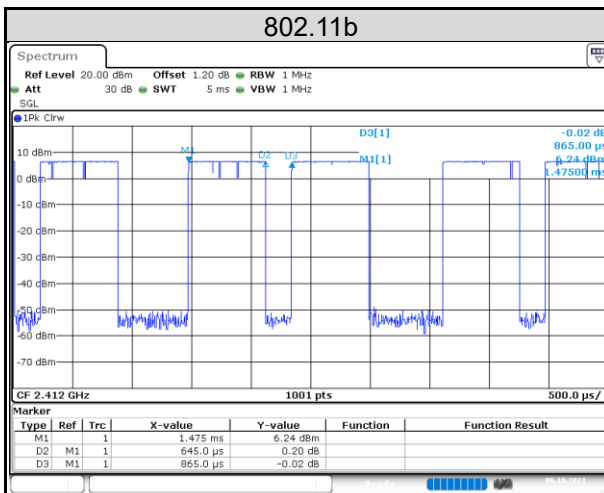

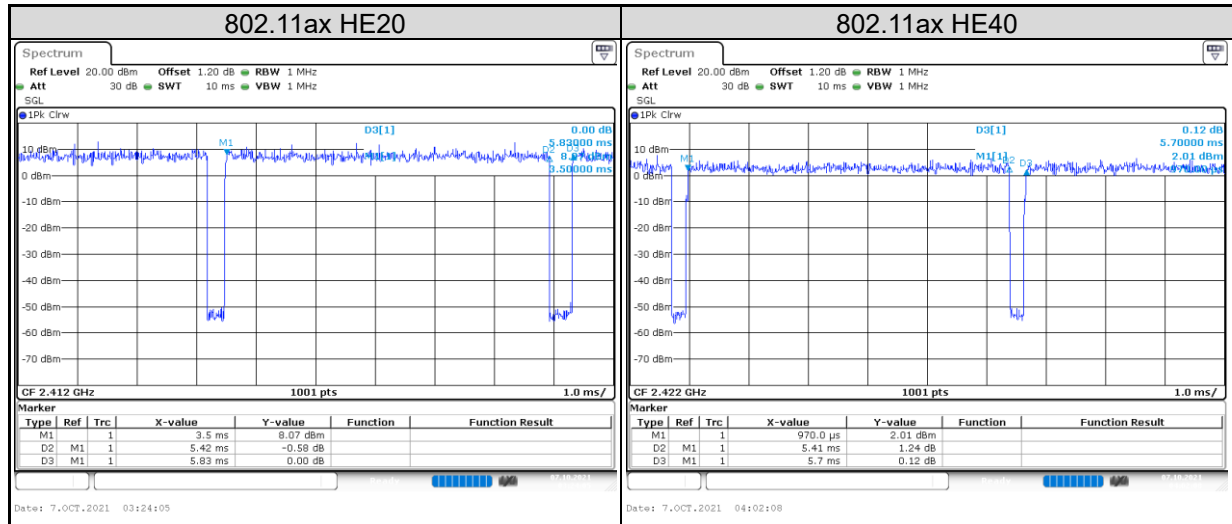

## 5. Test Results

### 5.1 Transmitter Requirement & Test Suites

#### 5.1.1 Antenna Requirement

**Requirement** Use of approved antennas only

According to the manufacturer declaration, the EUT's antenna specifications are described as below. The antenna is used with no possibility of replacement with a non-approved antenna by the end-user. Therefore, the EUT is considered to comply with this provision.

ANT		Gain (dBi)	Antenna Type
1		3.70	PIFA
2		4.08	PIFA
3		4.12	PIFA
4		5.01	PIFA
Max Peak Gain		5.01	-
CDD Mode	Power Directional Gain =	5.01	-
	PSD Directional Gain = $10\log[(10^{G1/20} + 10^{G2/20} + \dots + 10^{GN/20})^2 / N_{ANT}] =$	10.26	-
Beamforming Mode	Power Directional Gain = $10\log[(10^{G1/20} + 10^{G2/20} + \dots + 10^{GN/20})^2 / N_{ANT}] =$	10.26	-
	PSD Directional Gain = $10\log[(10^{G1/20} + 10^{G2/20} + \dots + 10^{GN/20})^2 / N_{ANT}] =$	10.26	-

Refer to EUT photo for details.

### 5.1.2 Peak Output Power

**Limit** 1 watt (30 dBm)

**Kind of Test Site** Shielded room

#### Test Setup



#### Test Instruments

Kind of Equipment	Manufacturer	Type	S/N	Calibration Date	Calibration Due Date	Test Date	
						From	Until
Power Meter	Anritsu	ML2495A	1901008	2021/3/24	2022/3/23	2021/8/26	2021/10/21
Power Sensor	Anritsu	MA2411B	1725269	2021/3/24	2022/3/23	2021/8/26	2021/10/21

#### Test Procedures

A peak power sensor was used on the output port of the EUT. A power meter was used to read the response of the peak power sensor. Record the power level.

Average power sensor was used to perform output power measurement, trigger and gating function of wide band power meter is enabled to measure max output power of TX on burst. Duty factor is not added to measured value.

**Test Result**
**Peak Output Power**
**CDD Mode**
**<802.11b>**

Channel	Channel Frequency (MHz)	Peak Output Power (dBm)				Total Power		Limit (dBm)
		Chain 0	Chain 1	Chain 2	Chain 3	(dBm)	(mW)	
1	2412	22.51	21.62	21.13	21.35	27.71	589.63	30
6	2437	21.02	21.25	20.84	21.05	27.06	508.51	30
11	2462	21.22	21.53	21.06	21.27	27.29	536.28	30

**<802.11g>**

Channel	Channel Frequency (MHz)	Peak Output Power (dBm)				Total Power		Limit (dBm)
		Chain 0	Chain 1	Chain 2	Chain 3	(dBm)	(mW)	
1	2412	23.11	23.68	23.11	23.18	29.30	850.60	30
6	2437	23.78	24.07	23.94	23.94	29.95	989.54	30
11	2462	22.82	23.07	23.15	23.08	29.05	803.97	30

**<802.11n HT20>**

Channel	Channel Frequency (MHz)	Peak Output Power (dBm)				Total Power		Limit (dBm)
		Chain 0	Chain 1	Chain 2	Chain 3	(dBm)	(mW)	
1	2412	23.10	23.15	22.86	22.94	29.03	800.70	30
6	2437	24.17	24.13	23.81	23.44	29.92	981.27	30
11	2462	22.39	22.32	22.64	22.75	28.55	716.01	30

**<802.11n HT40>**

Channel	Channel Frequency (MHz)	Peak Output Power (dBm)				Total Power		Limit (dBm)
		Chain 0	Chain 1	Chain 2	Chain 3	(dBm)	(mW)	
3	2422	22.35	22.54	22.42	22.25	28.41	693.73	30
6	2437	22.80	23.15	22.85	22.95	28.96	787.08	30
9	2452	21.82	21.93	21.98	21.93	27.94	621.73	30

**<802.11ax HE20>**

Channel	Channel Frequency (MHz)	Peak Output Power (dBm)				Total Power		Limit (dBm)
		Chain 0	Chain 1	Chain 2	Chain 3	(dBm)	(mW)	
1	2412	23.25	23.27	23.03	23.11	29.19	829.23	30
6	2437	24.05	24.16	24.03	23.61	29.99	997.26	30
11	2462	21.91	22.13	21.62	21.58	27.84	607.63	30

**<802.11ax HE40>**

Channel	Channel Frequency (MHz)	Peak Output Power (dBm)				Total Power		Limit (dBm)
		Chain 0	Chain 1	Chain 2	Chain 3	(dBm)	(mW)	
3	2422	22.04	22.24	22.81	22.86	28.52	711.63	30
6	2437	22.35	23.04	22.65	22.68	28.71	742.59	30
9	2452	20.82	20.56	20.79	20.71	26.74	472.25	30

**Average Power**
**<802.11b>**

Channel	Channel Frequency (MHz)	Average Power (dBm)				Total Power	
		Chain 0	Chain 1	Chain 2	Chain 3	(dBm)	(mW)
1	2412	19.76	18.84	18.34	18.61	24.94	312.03
6	2437	18.28	18.52	18.10	18.34	24.33	271.22
11	2462	18.52	18.81	18.37	18.58	24.59	287.97

**<802.11g>**

Channel	Channel Frequency (MHz)	Average Power (dBm)				Total Power	
		Chain 0	Chain 1	Chain 2	Chain 3	(dBm)	(mW)
1	2412	16.46	16.60	16.43	16.54	22.53	179.00
6	2437	18.94	19.01	18.76	19.05	24.96	313.47
11	2462	16.57	16.50	16.40	16.34	22.47	176.77

**<802.11n HT20>**

Channel	Channel Frequency (MHz)	Average Power (dBm)				Total Power	
		Chain 0	Chain 1	Chain 2	Chain 3	(dBm)	(mW)
1	2412	15.79	16.06	15.75	15.83	21.88	154.16
6	2437	18.98	19.02	18.88	18.66	24.91	309.59
11	2462	16.45	16.48	16.25	16.18	22.36	172.29

**<802.11n HT40>**

Channel	Channel Frequency (MHz)	Average Power (dBm)				Total Power	
		Chain 0	Chain 1	Chain 2	Chain 3	(dBm)	(mW)
3	2422	15.29	15.31	15.27	15.20	21.29	134.53
6	2437	17.13	17.23	17.12	17.17	23.18	208.13
9	2452	15.30	15.25	15.35	15.42	21.35	136.49

**<802.11ax HE20>**

Channel	Channel Frequency (MHz)	Average Power (dBm)				Total Power	
		Chain 0	Chain 1	Chain 2	Chain 3	(dBm)	(mW)
1	2412	15.43	15.67	15.39	15.39	21.49	141.00
6	2437	19.06	19.26	19.00	19.02	25.11	324.10
11	2462	14.41	14.61	14.36	14.45	20.48	111.66

**<802.11ax HE40>**

Channel	Channel Frequency (MHz)	Average Power (dBm)				Total Power	
		Chain 0	Chain 1	Chain 2	Chain 3	(dBm)	(mW)
3	2422	15.59	15.68	15.64	15.60	21.65	146.16
6	2437	16.21	16.57	16.38	16.69	22.49	177.29
9	2452	14.00	14.05	14.13	14.18	20.11	102.59

**Beamforming Mode**
**<802.11n HT20>**

Channel	Channel Frequency (MHz)	Peak Output Power (dBm)				Total Power		Limit (dBm)
		Chain 0	Chain 1	Chain 2	Chain 3	(dBm)	(mW)	
1	2412	17.08	17.13	16.84	16.92	23.01	200.20	25.74
6	2437	18.15	18.11	17.79	17.42	23.90	245.35	25.74
11	2462	16.37	16.30	16.62	16.73	22.53	179.03	25.74

**<802.11n HT40>**

Channel	Channel Frequency (MHz)	Peak Output Power (dBm)				Total Power		Limit (dBm)
		Chain 0	Chain 1	Chain 2	Chain 3	(dBm)	(mW)	
3	2422	16.33	16.52	16.40	16.23	22.39	173.46	25.74
6	2437	16.78	17.13	16.83	16.93	22.94	196.80	25.74
9	2452	15.80	15.91	15.96	15.91	21.92	155.45	25.74

**<802.11ax HE20>**

Channel	Channel Frequency (MHz)	Peak Output Power (dBm)				Total Power		Limit (dBm)
		Chain 0	Chain 1	Chain 2	Chain 3	(dBm)	(mW)	
1	2412	17.23	17.25	17.01	17.09	23.17	207.34	25.74
6	2437	18.03	18.14	18.01	17.59	23.97	249.35	25.74
11	2462	15.89	16.11	15.60	15.56	21.82	151.93	25.74

**<802.11ax HE40>**

Channel	Channel Frequency (MHz)	Peak Output Power (dBm)				Total Power		Limit (dBm)
		Chain 0	Chain 1	Chain 2	Chain 3	(dBm)	(mW)	
3	2422	16.02	16.22	16.79	16.84	22.50	177.93	25.74
6	2437	16.33	17.02	16.63	16.66	22.69	185.67	25.74
9	2452	14.80	14.54	14.77	14.69	20.72	118.08	25.74



**Average Power**
**<802.11n HT20>**

Channel	Channel Frequency (MHz)	Average Power (dBm)				Total Power	
		Chain 0	Chain 1	Chain 2	Chain 3	(dBm)	(mW)
1	2412	9.77	10.04	9.73	9.81	15.86	38.55
6	2437	12.96	13.00	12.86	12.64	18.89	77.41
11	2462	10.43	10.46	10.23	10.16	16.34	43.08

**<802.11n HT40>**

Channel	Channel Frequency (MHz)	Average Power (dBm)				Total Power	
		Chain 0	Chain 1	Chain 2	Chain 3	(dBm)	(mW)
3	2422	9.27	9.29	9.25	9.18	15.27	33.64
6	2437	11.11	11.21	11.10	11.15	17.16	52.04
9	2452	9.28	9.23	9.33	9.40	15.33	34.13

**<802.11ax HE20>**

Channel	Channel Frequency (MHz)	Average Power (dBm)				Total Power	
		Chain 0	Chain 1	Chain 2	Chain 3	(dBm)	(mW)
1	2412	9.41	9.65	9.37	9.37	15.47	35.25
6	2437	13.04	13.24	12.98	13.00	19.09	81.04
11	2462	8.39	8.59	8.34	8.43	14.46	27.92

**<802.11ax HE40>**

Channel	Channel Frequency (MHz)	Average Power (dBm)				Total Power	
		Chain 0	Chain 1	Chain 2	Chain 3	(dBm)	(mW)
3	2422	9.57	9.66	9.62	9.58	15.63	36.54
6	2437	10.19	10.55	10.36	10.67	16.47	44.33
9	2452	7.98	8.03	8.11	8.16	14.09	25.65

### 5.1.3 6 dB Bandwidth and 99% Occupied Bandwidth

**Limit** The minimum 6 dB bandwidth shall be at least 500 kHz.

**Kind of Test Site** Shielded room

#### Test Setup

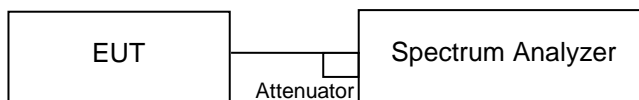

#### Test Instruments

Kind of Equipment	Manufacturer	Type	S/N	Calibration Date	Calibration Due Date	Test Date	
						From	Until
Spectrum Analyzer	R&S	FSV40	101512	2021/1/29	2022/1/28	2021/8/28	2021/10/21

#### Test Procedure

- a. Set resolution bandwidth (RBW) = 100 kHz
- b. Set the video bandwidth (VBW)  $\geq 3 \times$  RBW, Detector = Peak.
- c. Trace mode = max hold.
- d. Sweep = auto couple.
- e. Measure the maximum width of the emission that is constrained by the frequencies associated with the two amplitude points (upper and lower) that are attenuated by 6 dB relative to the maximum level measured in the fundamental emission.
- f. For 99% occupied bandwidth measurement, the transmitter output was connected to the spectrum analyzer through an attenuator. The bandwidth of the fundamental frequency was measured by spectrum analyzer with resolution bandwidth in the range of 1% to 5% of the anticipated emission bandwidth, and a video bandwidth at least 3x the resolution bandwidth and set the detector to PEAK. The width of a frequency band such that, below the lower and above the upper frequency limits, the mean powers emitted are each equal to a specified percentage 0.5% of the total mean power of a given emission.

#### Test Results

Please refer to Appendix A.

### 5.1.4 Power Spectral Density

**Limit**

The power spectral density shall not be greater than 8 dBm in any 3 kHz band.

**Kind of Test Site**                      Shielded room

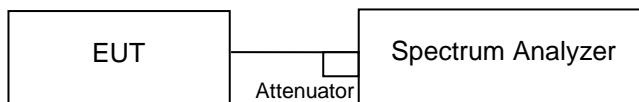
**Test Setup**

**Test Instruments**

Kind of Equipment	Manufacturer	Type	S/N	Calibration Date	Calibration Due Date	Test Date	
						From	Until
Spectrum Analyzer	R&S	FSV40	101512	2021/1/29	2022/1/28	2021/8/28	2021/10/21

**Test Procedure**

- a. Set analyzer center frequency to DTS channel center frequency.
- b. Set the span to 1.5 times the DTS bandwidth.
- c. Set the RBW to:  $3 \text{ kHz} \leq \text{RBW} \leq 100 \text{ kHz}$ .
- d. Set the VBW  $\geq 3 \times \text{RBW}$ .
- e. Detector = peak.
- f. Sweep time = auto couple.
- g. Trace mode = max hold.
- h. Allow trace to fully stabilize.
- i. Use the peak marker function to determine the maximum amplitude level within the RBW.

**Test Results**

Please refer to Appendix A.

## 5.1.5 Conducted Spurious Emissions and Frequency Band Edges Measured in 100 kHz Bandwidth

### Limit

20 dB (below that in the 100 kHz bandwidth within the band that contains the highest level of the desired power.)

**Kind of Test Site**                      Shielded room

### Test Setup

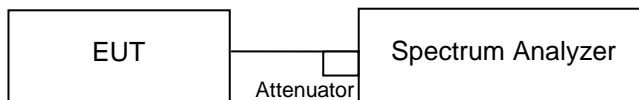

### Test Instruments

Kind of Equipment	Manufacturer	Type	S/N	Calibration Date	Calibration Due Date	Test Date	
						From	Until
Spectrum Analyzer	R&S	FSV40	101512	2021/1/29	2022/1/28	2021/8/28	2021/10/21

### Test Procedure

Measurement procedure REF

1. Set the RBW = 100 kHz.
2. Set the VBW  $\geq$  300 kHz.
3. Detector = peak.
4. Sweep time = auto couple.
5. Trace mode = max hold.
6. Allow trace to fully stabilize.
7. Use the peak marker function to determine the maximum power level in any 100 kHz band segment within the fundamental EBW.

Measurement procedure OOBE

1. Set RBW = 100 kHz.
2. Set VBW  $\geq$  300 kHz.
3. Detector = peak.
4. Sweep = auto couple.
5. Trace Mode = max hold.
6. Allow trace to fully stabilize.
7. Use the peak marker function to determine the maximum amplitude level.

### Test Results

Please refer to Appendix A.

## 5.1.6 Radiated Spurious Emissions and Band Edges

### Limit

Radiated emissions which fall in the restricted bands, as defined in §15.205(a), must comply with the radiated emission limits specified in §15.209(a).

Emissions radiated outside the restricted and authorized frequency bands must either comply with the radiated emission limits specified for the restricted bands or in §15.247(d).

**Kind of Test Site**                      3m Semi-Anechoic Chamber

### Test Setup

**<Radiated Emissions below 30 MHz>**

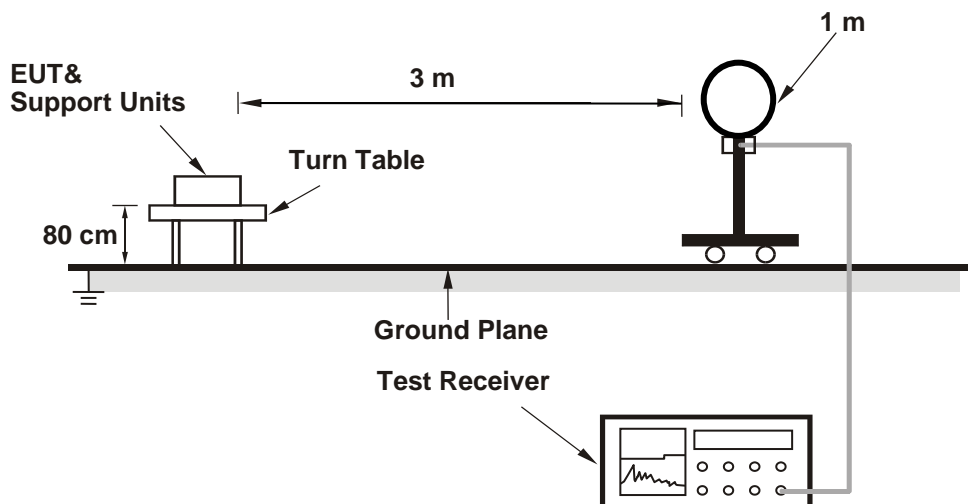

**<Radiated Emissions 30 MHz to 1 GHz>**

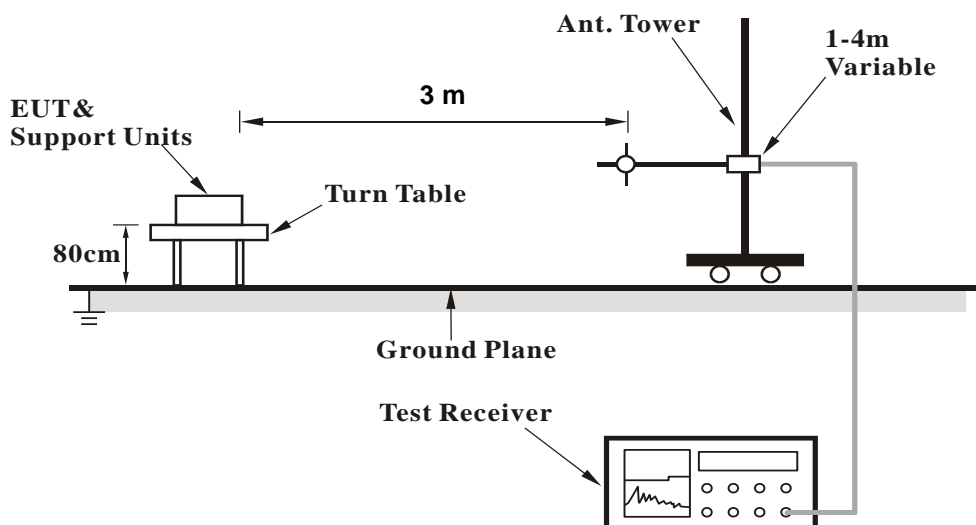

## &lt;Radiated Emissions above 1 GHz&gt;

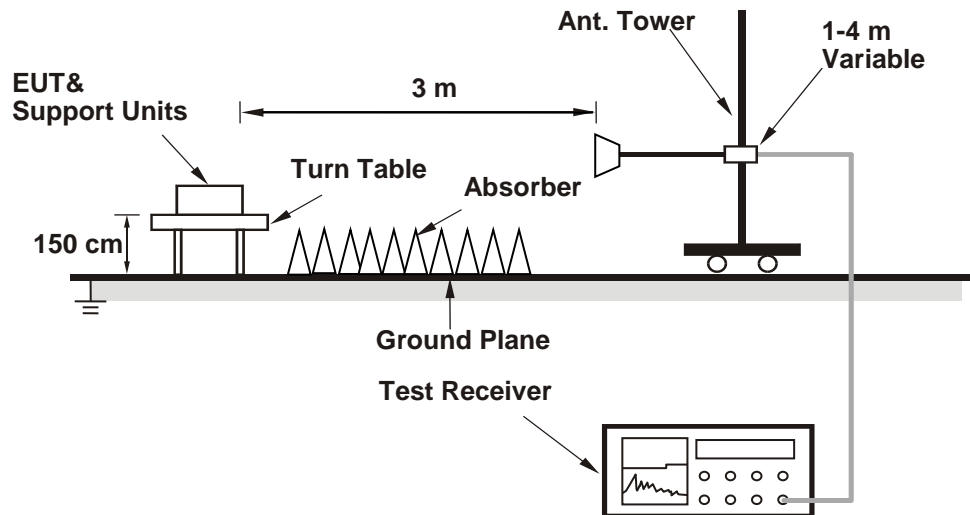

For the actual test configuration, please refer to the attached file (Test Setup Photo).

**Test Instruments**

Test Period: 2021-09-28 ~ 2021-12-11

Kind of Equipment	Manufacturer	Type	S/N	Calibration Date	Calibration Due Date
Signal Analyzer	R&S	FSV40	101508	2021/3/16	2022/3/15
Receiver	R&S	ESR7	102109	2021/3/16	2022/3/15
Bilog Antenna	SCHWARZBECK	VULB-9168	00951	2021/2/18	2022/2/17
Horn Antenna	ETS-Lindgren	3117	00218930	2020/12/1	2021/11/30
			00218929	2021/11/25	2022/11/24
LF-AMP	Agilent	8447D	2944A10772	2021/2/18	2022/2/17
HF-AMP + AC source	EMCI	EMC051845SE	980633	2021/2/9	2022/2/8
HF-AMP + AC source	EMCI	EMC184045SE	980657	2021/2/1	2022/1/31
Horn Antenna	SCHWARZBECK	BBHA 9170	00887	2021/4/8	2022/4/7
Microwave Cable	HUBER+SUHNER	SUCOFLEX 104EA	800056/4EA	2021/3/17	2022/3/16
Microwave Cable	HUBER+SUHNER	SUCOFLEX 104	804680/4	2021/3/17	2022/3/16
Microwave Cable	HUBER+SUHNER	SUCOFLEX 104	MY37202/4	2021/3/17	2022/3/16
Microwave Cable	HUBER+SUHNER	SUCOFLEX 102EA	800898/2EA	2021/4/16	2022/4/15
Microwave Cable	HUBER+SUHNER	SUCOFLEX 102EA	800901/2EA	2021/4/16	2022/4/15
Microwave Cable	HUBER+SUHNER	SUCOFLEX 102EA	801027/2EA	2021/4/16	2022/4/15
Loop Antenna	SCHWARZBECK	FNZB1519B	00215	2021/9/17	2022/9/16

**Test Procedures****For Radiated Emissions below 30 MHz**

- a. The EUT was placed on the top of a rotating table 0.8 meters above the ground at a 3 meter chamber room. The table was rotated 360 degrees to determine the position of the highest radiation.
- b. The EUT was set 3 meters away from the interference-receiving antenna, which was mounted on the top of a variable-height antenna tower.
- c. Parallel (OPEN), perpendicular (CLOSE), and ground-parallel (GROUND) orientations of the antenna are set to make the measurement.
- d. For each suspected emission, the EUT was arranged to its worst case and the rotatable table was turned from 0 degrees to 360 degrees to find the maximum reading.
- e. The test-receiver system was set to Quasi-Peak Detect Function and Specified Bandwidth with Maximum Hold Mode.

## Note:

1. The resolution bandwidth and video bandwidth of test receiver/spectrum analyzer is 9 kHz at frequency below 30 MHz.
2. All modes of operation were investigated and the worst-case emissions are reported.

**For Radiated Emissions above 30 MHz**

- a. The EUT was placed on the top of a rotating table 0.8 meters (for 30 MHz ~ 1 GHz) / 1.5 meters (for above 1 GHz) above the ground at 3 meter chamber room for test. The table was rotated 360 degrees to determine the position of the highest radiation.
- b. The EUT was set 3 meters away from the interference-receiving antenna, which was mounted on the top of a variable-height antenna tower.
- c. The height of antenna is varied from one meter to four meters above the ground to determine the maximum value of the field strength. Both horizontal and vertical polarizations of the antenna are set to make the measurement.
- d. For each suspected emission, the EUT was arranged to its worst case and then the antenna was tuned to heights from 1 meter to 4 meters and the rotatable table was turned from 0 degrees to 360 degrees to find the maximum reading.
- e. The test-receiver system was set to quasi-peak detect function and specified bandwidth with maximum hold mode when the test frequency is below 1 GHz.
- f. The test-receiver system was set to peak and average detected function and specified bandwidth with maximum hold mode when the test frequency is above 1 GHz. If the peak reading value also meets average limit, measurement with the average detector is unnecessary.

## Note:

1. The resolution bandwidth and video bandwidth of test receiver/spectrum analyzer is 120 kHz for Quasi-peak detection (QP) or Peak detection (PK) at frequency below 1 GHz.
2. The resolution bandwidth of test receiver/spectrum analyzer is 1 MHz and the video bandwidth is 3 MHz for Peak detection (PK) at frequency above 1 GHz.
3. The resolution bandwidth of test receiver/spectrum analyzer is 1 MHz and the video bandwidth is  $\geq 1/T$  (Duty cycle < 98 %) or 10 Hz (Duty cycle  $\geq 98$  %) for Average detection (AV) at frequency above 1 GHz.
4. All modes of operation were investigated and the worst-case emissions are reported.
5. The Radiated Emissions testing was performed in the X(E1), Y(H) and Z(E2) axis orientation. The worst-case Axis orientation is recorded in this test report.



**Prüfbericht - Nr.: CN21W8ZE (P15C-WiFi) 001**  
*Test Report No.*

**Seite 33 von 35**  
*Page 33 of 35*

**Test Results**

Factor (dB/m) = Antenna Factor (dB/m) + Cable Loss (dB)  
Level (dBuV/m) = Reading (dBuV) + Factor (dB/m)

Please refer to Appendix B.

## 5.2 Mains Emission

### 5.2.1 Mains Conducted Emission

#### Limit

Mains Conducted Emission as defined in §15.207 must comply with the mains conducted emission limits.

**Kind of Test Site**                      Shielded room

#### Test Setup

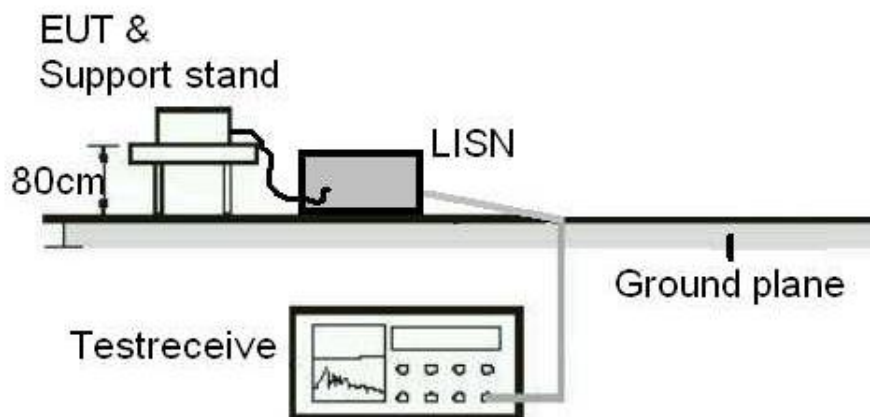

#### Test Instruments

Test Period: 2021-10-20

Kind of Equipment	Manufacturer	Type	S/N	Calibration Date	Calibration Due Date
TWO-LINE V-NETWORK	SCHWARZBECK	NSLK 8127	8127-00976	2020/11/3	2021/11/2
EMI Test Receiver	R&S	ESCI	1816063	2020/11/17	2021/11/16
RF Cable	N/A	N/A	EMC-003	2020/11/15	2021/11/14

Test Period: 2022-01-12

Kind of Equipment	Manufacturer	Type	S/N	Calibration Date	Calibration Due Date
RF Cable	N/A	N/A	EMC-003	2021/03/16	2022/03/15
Two-Line V-Network	Rohde & Schwarz	ENV216	101938	2021/09/23	2022/09/22
EMI Test Receiver	R&S	ESCI	1816063	2021/11/15	2022/11/14

#### **Test Procedures**

- a. The EUT was placed 0.4 meters from the conducting wall of the shielded room with EUT being connected to the power mains through a line impedance stabilization network (LISN). Other support units were connected to the power mains through another LISN. The two LISNs provide 50 ohm/50 uH of coupling impedance for the measuring instrument.
- b. Both lines of the power mains connected to the EUT were checked for maximum conducted interference.
- c. The frequency range from 150 kHz to 30 MHz was searched. Emission levels under (Limit – 20 dB) was not recorded.

Note: The resolution bandwidth and video bandwidth of test receiver is 9 kHz for quasi-peak detection (QP) and average detection (AV) at frequency 0.15 MHz – 30 MHz.

#### **Test Results**

Please refer to Appendix B.