

FCC 47 CFR PART 15 SUBPART E

Applicant : Emplus Technologies, Inc
Product Type : Dual Band AC2600 Access Point
Trade Name : emplus
Model Number : WAP373-C
Test Specification : FCC 47 CFR PART 15 SUBPART E
ANSI C63.10:2013
Receive Date : May 30, 2019
Test Period : Jun. 15 ~ Jul. 09, 2019
Issue Date : Jul. 15, 2019

Issue by

A Test Lab Techno Corp.
No. 140-1, Changan Street, Bade District,
Taoyuan City 33465, Taiwan (R.O.C.)
Tel : +86-3-2710188 / Fax : +86-3-2710190



Taiwan Accreditation Foundation accreditation number: 1330
Test Firm MRA designation number: TW0010

Note:

1. The test results are valid only for samples provided by customers and under the test conditions described in this report.
2. This report shall not be reproduced except in full, without the written approval of A Test Lab Technology Corporation.
3. The relevant information is provided by customers in this test report. According to the correctness, appropriateness or completeness of the information provided by the customer, if there is any doubt or error in the information which affects the validity of the test results, the laboratory does not take the responsibility.



Revision History

Rev.	Issue Date	Revisions	Revised By
00	Jul. 15, 2019	Initial Issue	Tobey Cheng

Verification of Compliance

Issued Date: Jul. 15, 2019

Applicant : Emplus Technologies, Inc
Product Type : Dual Band AC2600 Access Point
Trade Name : emplus
Model Number : WAP373-C
FCC ID : 2AL6XWAP373
EUT Rated Voltage : DC 12 V, 2 A
Test Voltage : 120 Vac / 60 Hz
Applicable Standard : FCC 47 CFR PART 15 SUBPART E
ANSI C63.10:2013
Test Result : Complied

Performing Lab. : A Test Lab Techno Corp.
No. 140-1, Changan Street, Bade District,
Taoyuan City 33465, Taiwan (R.O.C.)
Tel : +86-3-2710188 / Fax : +86-3-2710190



Taiwan Accreditation Foundation accreditation number: 1330
<http://www.atl-lab.com.tw/e-index.htm>

A Test Lab Techno Corp. tested the above equipment in accordance with the requirements set forth in the above standards. All indications of Pass/Fail in this report are opinions expressed by A Test Lab Techno Corp. based on interpretations and/or observations of test results. The test results show that the equipment tested is capable of demonstrating compliance with the requirements as documented in this report.

Approved By : Fly Lu Reviewed By : Eric Ou Yang
(Manager) (Fly Lu) (Testing Engineer) (Eric Ou Yang)



TABLE OF CONTENTS

1	General Information	5
1.1.	Summary of Test Result.....	5
1.2.	Measurement Uncertainty.....	6
2	EUT Description	7
3	Test Methodology.....	9
3.1.	Mode of Operation	9
3.2.	EUT Test Step.....	16
3.3.	Configuration of Test System Details	17
3.4.	Test Instruments	18
3.5.	Test Site Environment.....	19
4	Measurement Procedure.....	20
4.1.	AC Power Conducted Emission Measurement	20
4.2.	Transmitter Radiated Emissions Measurement.....	22
4.3.	Maximum Conducted Output Power Measurement.....	27
4.4.	26 dB RF Bandwidth Measurement & 99 % Occupied Bandwidth Measurement	28
4.5.	6 dB RF Bandwidth Measurement	29
4.6.	Maximum Power Spectral Density Measurement.....	30
4.7.	Automatically discontinue transmission.....	32
4.8.	Antenna Requirement.....	32
5	Test Results.....	34
	Annex A. Conducted Emission	34
	Annex B. Radiated Emission Measurement	36
	Annex C. Conducted Test Results	211



1 General Information

1.1. Summary of Test Result

Standard	Item	Result	Remark
15.407(b)(6) 15.207	AC Power Conducted Emission	PASS	---
15.407(b) 15.205 / 15.209	Transmitter Radiated Emissions	PASS	---
15.407(a)	Maximum Conducted Output Power	PASS	---
15.407(a)	26 dB RF Bandwidth & 99 % Occupied Bandwidth	Reference	---
15.407(e)	6 dB RF Bandwidth	PASS	---
15.407(a)	Maximum Power Spectral Density	PASS	---
15.407(c)	Automatically discontinue transmission	PASS	---
15.407(a) 15.203	Antenna Requirement	PASS	---

Standard	Description
CFR47, Part 15, Subpart C §15.247	Intentional Radiators
ANSI C63. 10: 2013	American National Standard of Procedures for Compliance Testing of Unlicensed Wireless Devices
KDB 558074 D01 v05	GUIDANCE FOR COMPLIANCE MEASUREMENTS ON DIGITAL TRANSMISSION SYSTEM, FREQUENCY HOPPING SPREAD SPECTRUM SYSTEM, AND HYBRID SYSTEM DEVICES OPERATING UNDER SECTION 15.247 OF THE FCC RULES

1.2. Measurement Uncertainty

Test Item	Frequency Range	Uncertainty (dB)
Conducted Emission	150 kHz ~ 30 MHz	2.8
Radiated Emission	9 kHz ~ 30 MHz	1.7
	30 MHz ~ 1000 MHz	5.7
	1000 MHz ~ 18000 MHz	5.6
	18000 MHz ~ 26500 MHz	4.9
	26500 MHz ~ 40000 MHz	4.8
Conducted Output Power		+0.27 dB / -0.28 dB
RF Bandwidth		4.96 %
Power Spectral Density		+0.71 dB / -0.77 dB
Frequency Stability		+ 2.212 x 10 ⁻⁷ % / - 2.170 x 10 ⁻⁷
Duty Cycle		1.06 %
Time Occupancy		1.40 %

Decision Rule

- Uncertainty is not included.
- Uncertainty is included.



2 EUT Description

Applicant	Emplus Technologies, Inc Bld B, 10F, No.209 Nangang Rd., Taipei City, Taiwan				
Manufacturer	Emplus Technologies, Inc Bld B, 10F, No.209 Nangang Rd., Taipei City, Taiwan				
Product Type	Dual Band AC2600 Access Point				
Trade Name	emplus				
Model No.	WAP373-C				
FCC ID	2AL6XWAP373				
Operate Frequency	Frequency Band			Frequency Range (MHz)	Number of Channels
	IEEE 802.11a	U-NII Band I		5180 – 5240	4
		U-NII Band III		5745 – 5825	5
	IEEE 802.11n 5 GHz 20 MHz / IEEE 802.11ac 20 MHz	U-NII Band I		5180 – 5240	4
		U-NII Band III		5745 – 5825	5
	IEEE 802.11n 5 GHz 40 MHz / IEEE 802.11ac 40 MHz	U-NII Band I		5190 – 5230	2
		U-NII Band III		5755 – 5795	2
	IEEE 802.11ac 80 MHz	U-NII Band I		5210	1
U-NII Band III		5775	1		
Modulation Type	OFDM				
Equipment Type	Master				
Antenna information	Antenna	Model	Type	Frequency Range (MHz)	Max. Gain (dBi)
	ANT-0	5718A0350300	PIFA Antenna	5150 – 5250	4.78
				5725 – 5850	5.07
	ANT-1	5718A0351300	PIFA Antenna	5150 – 5250	4.61
				5725 – 5850	5.50
	ANT-2	5718A0352300	PIFA Antenna	5150 – 5250	4.31
				5725 – 5850	5.36
	ANT-3	5718A0353300	PIFA Antenna	5150 – 5250	4.15
5725 – 5850				5.84	
Antenna Delivery	Reference section 3.1				
Frequency stability specification	± 20 ppm				
Operate Temp. Range	0 ~ +50 °C				



Frequency Band		RF Output Power (W)
IEEE 802.11a	U-NII Band I	0.180
	U-NII Band III	0.363
IEEE 802.11n 5 GHz 20 MHz	U-NII Band I	0.263
	U-NII Band III	0.263
IEEE 802.11n 5 GHz 40 MHz	U-NII Band I	0.249
	U-NII Band III	0.239
IEEE 802.11ac 20 MHz	U-NII Band I	0.275
	U-NII Band III	0.276
IEEE 802.11ac 40 MHz	U-NII Band I	0.258
	U-NII Band III	0.245
IEEE 802.11ac 80 MHz	U-NII Band I	0.106
	U-NII Band III	0.266

Beamforming on

Frequency Band		RF Output Power (W)
IEEE 802.11ac 20 MHz	U-NII Band I	0.060
	U-NII Band III	0.060
IEEE 802.11ac 40 MHz	U-NII Band I	0.056
	U-NII Band III	0.055
IEEE 802.11ac 80 MHz	U-NII Band I	0.023
	U-NII Band III	0.059

Equipment Type		
Outdoor access point	point-to-point	---
	point-to-multipoint	---
Indoor access point		V
Fixed point-to-point access points		---
Client devices		---

3 Test Methodology

3.1. Mode of Operation

Decision of Test ATL has verified the construction and function in typical operation. All the test modes were carried out with the EUT in normal operation, which was shown in this test report and defined as:

Test Mode
Mode 1: Transmit mode
Mode 2: IEEE 802.11a Continuous TX mode
Mode 3: IEEE 802.11n 5 GHz 20 MHz Continuous TX mode
Mode 4: IEEE 802.11n 5 GHz 40 MHz Continuous TX mode
Mode 5: IEEE 802.11ac 20 MHz Continuous TX mode
Mode 6: IEEE 802.11ac 40 MHz Continuous TX mode
Mode 7: IEEE 802.11ac 80 MHz Continuous TX mode

Software used to control the EUT for staying in continuous transmitting mode was programmed.

After verification, all tests were carried out with the worst case test modes.

Note: Investigation has been done on all the possible configurations for searching the worst cases (VHT20/40 covers HT20/40). The table is a list of the test modes show in this test report.

Test Mode	ANT-0	ANT-1	ANT-2	ANT-3	ANT-0+1+2+3
Mode 2	V	V	V	V	V
Mode 3	V	V	V	V	V
Mode 4	V	V	V	V	V
Mode 5	V	V	V	V	V
Mode 6	V	V	V	V	V
Mode 7	V	V	V	V	V



Test Mode	Antenna Delivery	Data Rate (Mbps)	Band	Test Channel
Mode 2	4TX / 4RX (CDD)	6	U-NII Band I	36, 40, 44, 48
			U-NII Band III	149, 153,157, 161, 165
Mode 3	4TX / 4RX (STBC)	26	U-NII Band I	36, 40, 44, 48
			U-NII Band III	149, 153,157, 161, 165
Mode 4	4TX / 4RX (STBC)	54	U-NII Band I	38, 46
			U-NII Band III	151,159
Mode 5	4TX / 4RX (STBC/Beamforming on)	26	U-NII Band I	36, 40, 44, 48
			U-NII Band III	149, 153,157, 161, 165
Mode 6	4TX / 4RX (STBC/Beamforming on)	54	U-NII Band I	38, 46
			U-NII Band III	151,159
Mode 7	4TX / 4RX (STBC/Beamforming on)	117.2	U-NII Band I	42
			U-NII Band III	155



Duty cycle

Test Mode	Frequency (MHz)	on time (ms)	on+off time (ms)	Duty cycle	Duty Factor (dB)	1/T Minimum VBW (kHz)
Mode 2	5180.0	2.080	2.120	0.981	0.083	0.010
Mode 5	5180.0	5.040	5.070	0.994	0.026	0.010
Mode 6	5190.0	2.460	2.510	0.980	0.087	0.010
Mode 7	5210.0	1.160	1.210	0.959	0.183	0.862

Beamforming on

Test Mode	Frequency (MHz)	on time (ms)	on+off time (ms)	Duty cycle	Duty Factor (dB)	1/T Minimum VBW (kHz)
Mode 5	5180.0	5.040	5.070	0.994	0.026	0.010
Mode 6	5190.0	2.460	2.510	0.980	0.087	0.010
Mode 7	5210.0	1.160	1.210	0.959	0.183	0.862

Duty Cycle Graphs

Mode 2: IEEE 802.11a Continuous TX mode

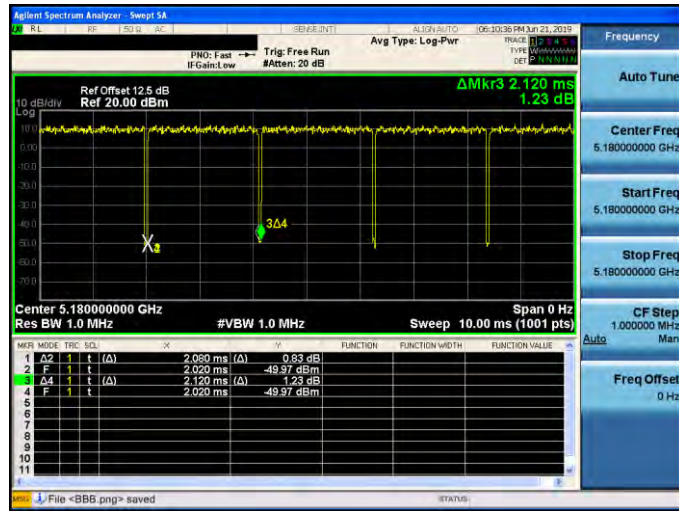

Mode 5: IEEE 802.11ac 20 MHz Continuous TX mode

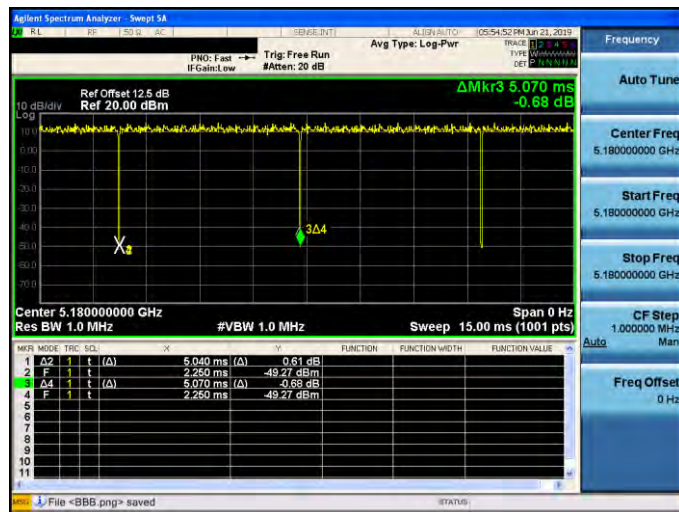



Mode 6: IEEE 802.11ac 40 MHz Continuous TX mode

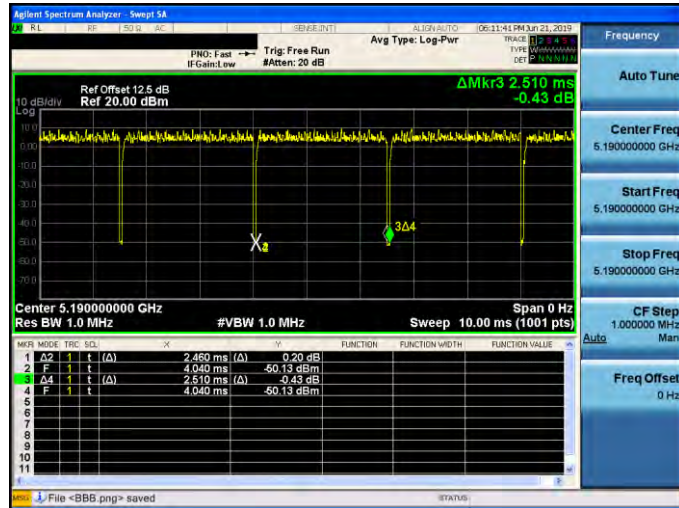

Mode 7: IEEE 802.11ac 80 MHz Continuous TX mode

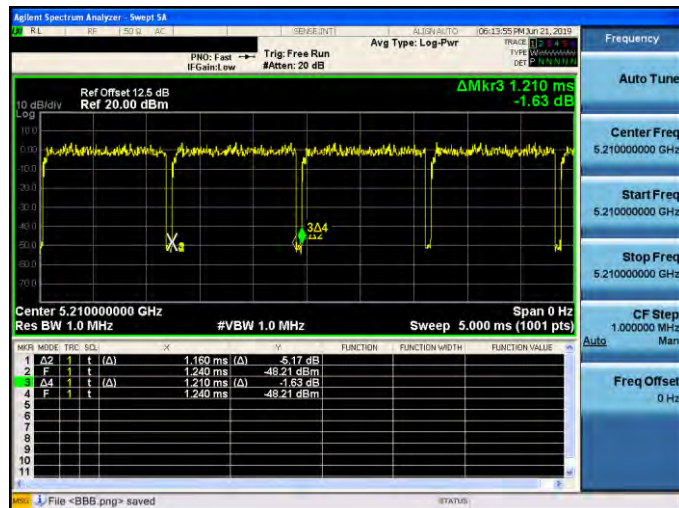

Beamforming on

Mode 5: IEEE 802.11ac 20 MHz Continuous TX mode

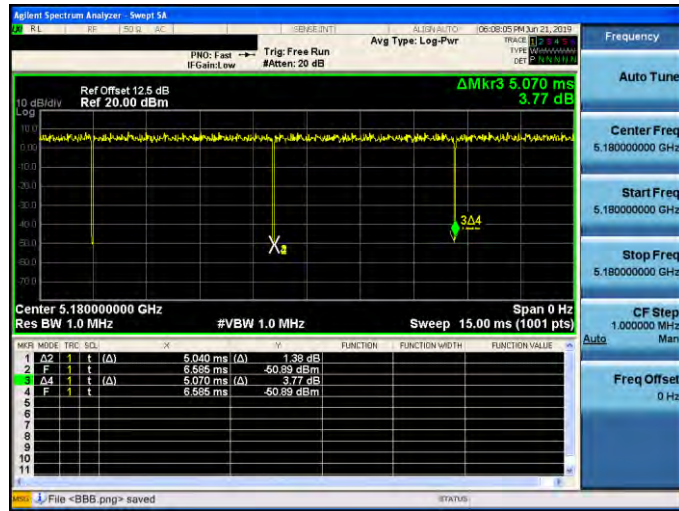

Mode 6: IEEE 802.11ac 40 MHz Continuous TX mode

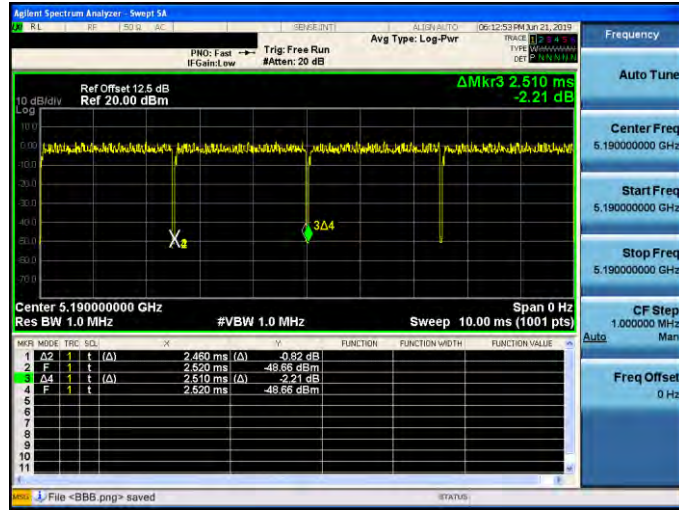

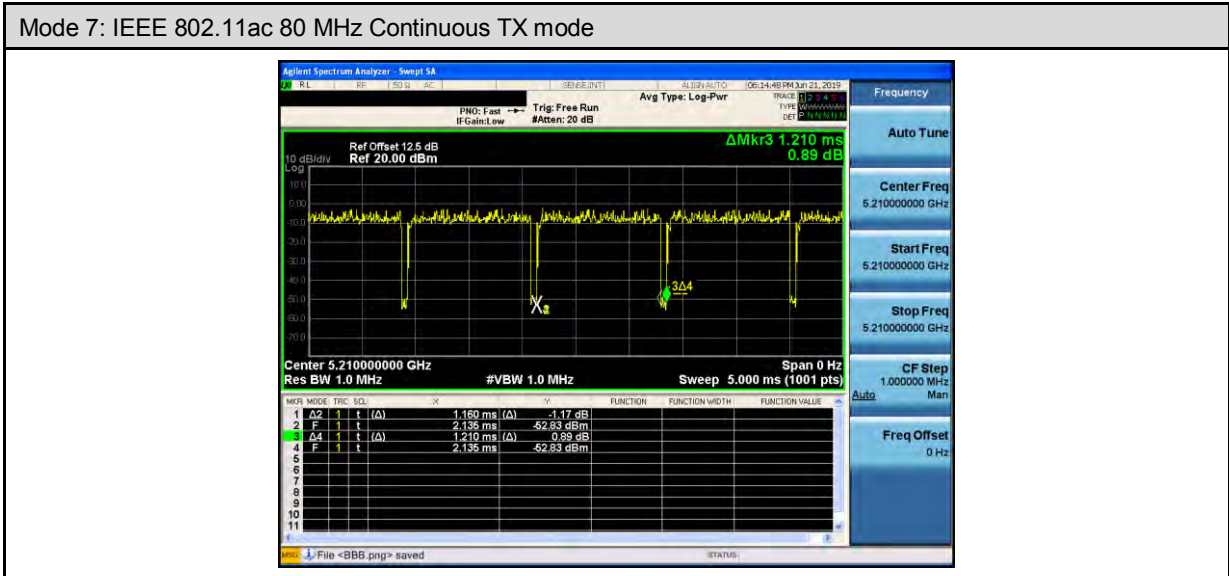



3.2. EUT Test Step

The EUT is operated in the engineering mode to fix the TX frequency for the purposes of measurement. According to its specifications, the EUT must comply with the requirements of Section 15.407 under the FCC Rules Part 15 Subpart E.

1.	Setup the EUT shown on "Configuration of Test System Details".
2.	Turn on the power of all equipment.
3.	Turn on TX function.
4.	EUT run test program.

Measurement Software			
No.	Description	Software	Version
1	Conducted Emission	EZ EMC	1.1.4.3
2	Radiated Emission	EZ EMC	1.1.4.4

3.3. Configuration of Test System Details

Conducted Emissions

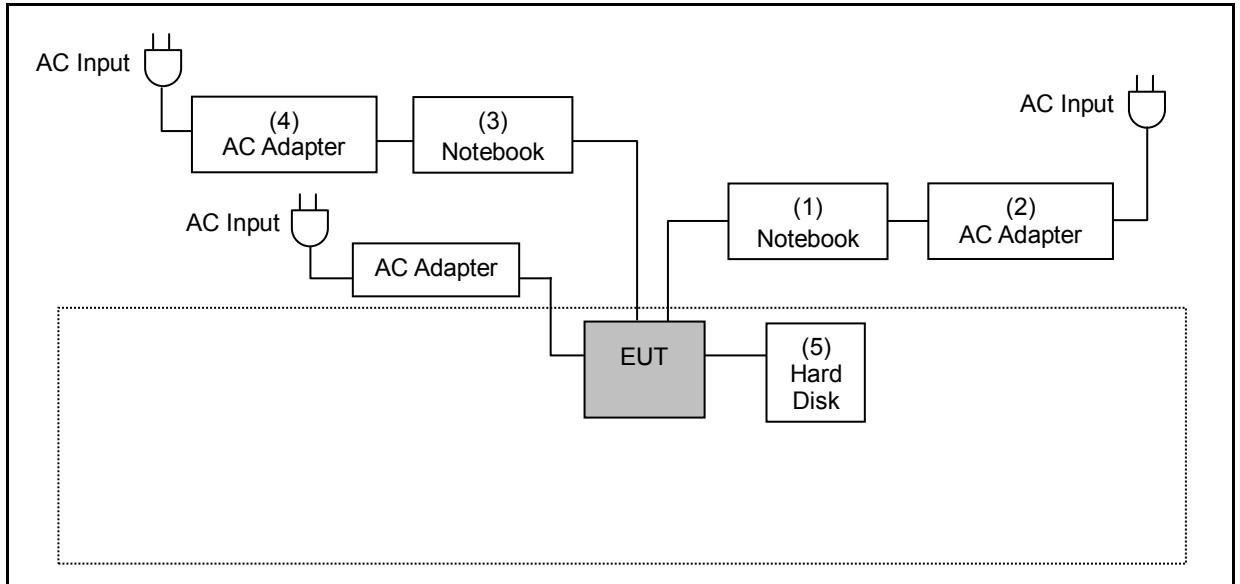

Radiated Emission

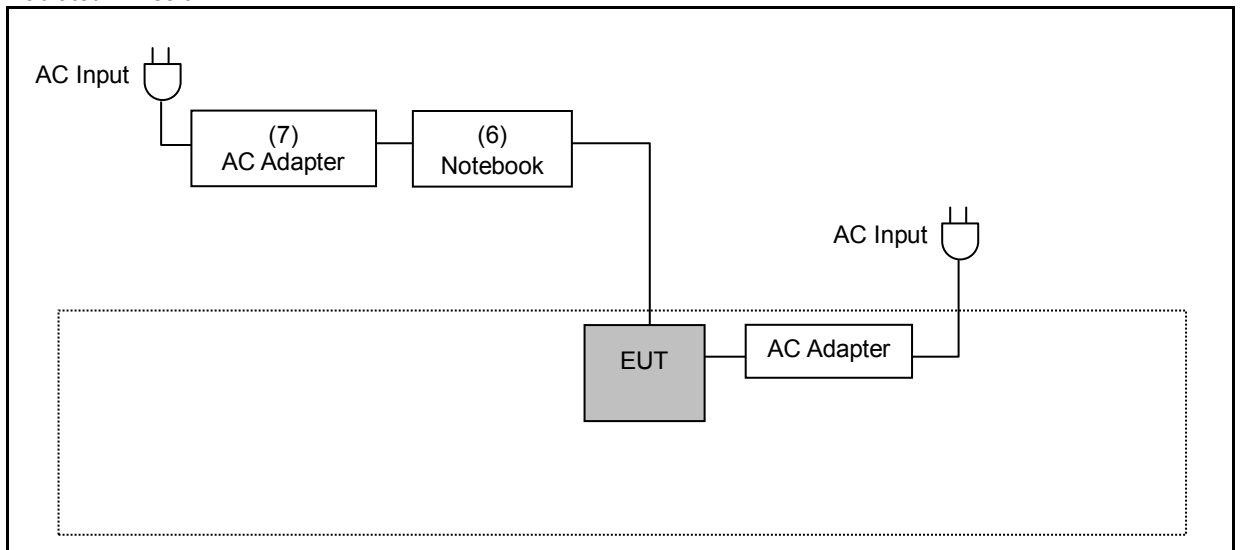

Devices Description					
	Product	Manufacturer	Model Number	Serial Number	Power Cord
(1)	Notebook	DELL	LATITUDE E6440	5HZBD72	---
(2)	AC Adapter	DELL	HA65NM130	---	Non-Shielded, 1.7 m
(3)	Notebook	DELL	LATITUDE E6440	48GBD72	---
(4)	AC Adapter	DELL	HA65NM130	---	Non-Shielded, 1.7 m
(5)	Hard Disk	Transend	TS1T5J25A3K-RU	D72654-0611	---
(6)	Notebook	DELL	LATITUDE E6440	5HZBD72	---
(7)	AC Adapter	DELL	HA65NM130	---	Non-Shielded, 0.8 m



3.4. Test Instruments

For Conducted Emission

Test Period: Jul. 09, 2019

Equipment	Manufacturer	Model Number	Serial Number	Cal. Date	Cal. Period
Test Receiver	R&S	ESCI	100367	05/23/2019	1 year
LISN	R&S	ENV216	101040	04/03/2019	1 year
LISN	R&S	ENV216	101041	03/28/2019	1 year
RF Cable	Woken	00100D1380194M	TE-02-03	05/23/2019	1 year

For Radiated Emissions

Test Period: Jun. 15 ~ Jun. 19, 2019

Equipment	Manufacturer	Model Number	Serial Number	Cal. Date	Cal. Period
Spectrum Analyzer (10 Hz~44 GHz)	Keysight	N9010A	MY52221312	01/14/2019	1 year
Pre Amplifier (1~26.5 GHz)	Agilent	8449B	3008A02237	10/16/2018	1 year
Pre Amplifier (100 kHz~1.3 GHz)	Agilent	8447D	2944A11119	01/14/2019	1 year
Pre Amplifier (26.5~40 GHz)	EMCI	EMC2654045	980028	08/23/2018	1 year
Broadband Antenna	Schwarzbeck	VULB9168	416	10/19/2018	1 year
Horn Antenna (1~18 GHz)	SCHWARZBECK MESS-ELEKTRONIK	BBHA9120D	9120D-550	08/23/2018	1 year
Horn Antenna (18~40 GHz)	SCHWARZBECK MESS-ELEKTRONIK	BBHA9170	9170-320	08/07/2018	1 year
Loop Antenna	COM-POWER CORPORATION	AL-130	121014	03/29/2019	1 year
RF Cable	EMCI	EMC104-N-N -6000	TE01-1	02/20/2019	1 year
Microwave Cable	EMCI	EMC104-SM -SM-13000	170814	10/30/2018	1 year
Microwave Cable	EMCI	EMC102-KM -KM-14000	151001	02/20/2019	1 year

Note: N.C.R. = No Calibration Request.



For Conducted

Test Period: Jun. 19 ~ Jun. 27, 2019

Equipment	Manufacturer	Model Number	Serial Number	Cal. Date	Cal. Period
Spectrum Analyzer (20 Hz~26.5 GHz)	Agilent	N9020A	US47520902	09/25/2018	1 year
Power Sensor	Anritsu	MA2411B	1126022	08/29/2018	1 year
Power Meter	Anritsu	ML2495A	1135009	08/29/2018	1 year

Note: N.C.R. = No Calibration Request.

3.5. Test Site Environment

Items	Required (IEC 60068-1)	Actual
Temperature (°C)	15-35	26
Humidity (%RH)	25-75	60
Barometric pressure (mbar)	860-1060	990

4 Measurement Procedure

4.1. AC Power Conducted Emission Measurement

■ Limit

Frequency (MHz)	Quasi-peak	Average
0.15 - 0.5	66 to 56	56 to 46
0.50 - 5.0	56	46
5.0 - 30.0	60	50

■ Test Setup

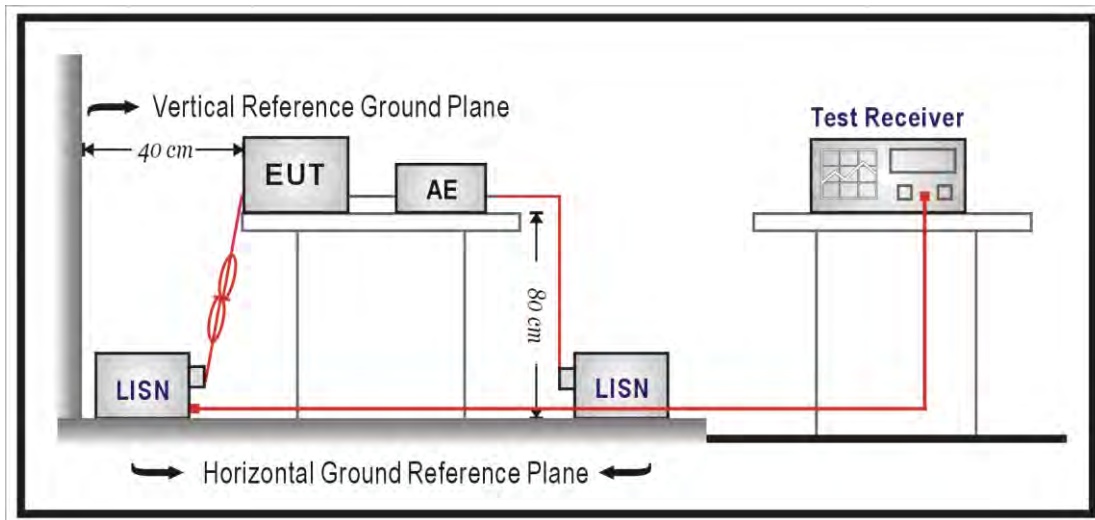

■ Test Procedure

The EUT and simulators are connected to the main power through a line impedance stabilization network (L.I.S.N.). This provides a $50 \Omega // 50 \mu\text{H}$ coupling impedance for the measuring equipment. The peripheral devices are also connected to the main power through a LISN that provides a $50 \Omega // 50 \mu\text{H}$ coupling impedance with 50 ohm termination.

Tabletop device shall be placed on a non-conducting platform, of nominal size 1 m by 1.5 m, raised 80 cm above the reference ground plane. The wall of screened room shall be located 40 cm to the rear of the EUT. Other surfaces of tabletop or floor standing EUT shall be at least 80 cm from any other ground conducting surface including one or more LISNs. For floor-standing device shall be placed under the EUT with a 12 mm insulating material.

Conducted emissions were investigated over the frequency range from 0.15 MHz to 30 MHz using a resolution bandwidth of 9 kHz. The equipment under test (EUT) shall be meet the limits in section 4.1, as applicable, including the average limit and the quasi-peak limit when using respectively, an average detector and quasi-peak detector measured in accordance with the methods described of related standard. When all of peak value were complied with quasi-peak and average limit from 150 kHz to 30 MHz then quasi-peak and average measurement was unnecessary.

The AMN shall be placed 0.8 m from the boundary of the unit under test and bonded to a ground reference plane for AMNs mounted on top of the ground reference plane. This distance is between the closest points of the AMN and the EUT. All other units of the EUT and associated equipment shall be at least 0.8 m from the AMN. If the mains power cable is longer than 1 m then the cable shall be folded back and forth at the centre of the lead to form a bundle no longer than 0.4 m. All of interconnecting cables that hang closer than 40 cm to the ground plane shall be folded back and forth in the center forming a bundle 30 cm to 40 cm long. All of EUT and AE shall be separate place more than 0.1 m. All 50Ω ports of the LISN shall be resistively terminated into 50Ω loads when not connected to the measuring instrument.

If the reading of the measuring receiver shows fluctuations close to the limit, the reading shall be observed for at least 15 s at each measurement frequency; the higher reading shall be recorded with the exception of any brief isolated high reading which shall be ignored

4.2. Transmitter Radiated Emissions Measurement

■ Limit

(1)Undesirable emission limits. Except as shown in paragraph (b)(7) of this section, the maximum emissions outside of the frequency bands of operation shall be attenuated in accordance with the following limits:

(a)For transmitters operating in the 5.15-5.25 GHz band: All emissions outside of the 5.15-5.35 GHz band shall not exceed an e.i.r.p. of -27 dBm/MHz.

(b)For transmitters operating in the 5.25-5.35 GHz band: All emissions outside of the 5.15-5.35 GHz band shall not exceed an e.i.r.p. of -27 dBm/MHz.

(c)For transmitters operating in the 5.47-5.725 GHz band: All emissions outside of the 5.47-5.725 GHz band shall not exceed an e.i.r.p. of -27 dBm/MHz.

(d)For transmitters operating in the 5.725-5.85 GHz band:

(i)All emissions shall be limited to a level of -27 dBm/MHz at 75 MHz or more above or below the band edge increasing linearly to 10 dBm/MHz at 25 MHz above or below the band edge, and from 25 MHz above or below the band edge increasing linearly to a level of 15.6 dBm/MHz at 5 MHz above or below the band edge, and from 5 MHz above or below the band edge increasing linearly to a level of 27 dBm/MHz at the band edge.

(2)Limits of Radiated Emission Measurement

Emissions radiated outside of the specified bands, shall be according to the general radiated limits in 15.209 as following:

Frequency Range (MHz)	Field Strength (microvolts/meter)	Measurement Distance (meters)
0.009 ~ 0.490	2400/F(kHz)	300
0.490 ~ 1.705	24000/F(kHz)	30
1.705 ~ 30.0	30	30
30 ~ 88	10	3
88 ~ 216	150	3
216 ~ 960	200	3
Above 960	500	3

- Note:
1. The lower limit shall apply at the transition frequencies.
 2. Emission level (dBuV/m) = 20 log Emission level (uV/m).
 3. As shown in 15.35(b), for frequencies above 1000 MHz, the field strength limits are based on average detector, however, the peak field strength of any emission shall not exceed the maximum permitted average limits, specified above by more than 20 dB under any condition of modulation.

■ Setup

9 kHz ~ 30 MHz

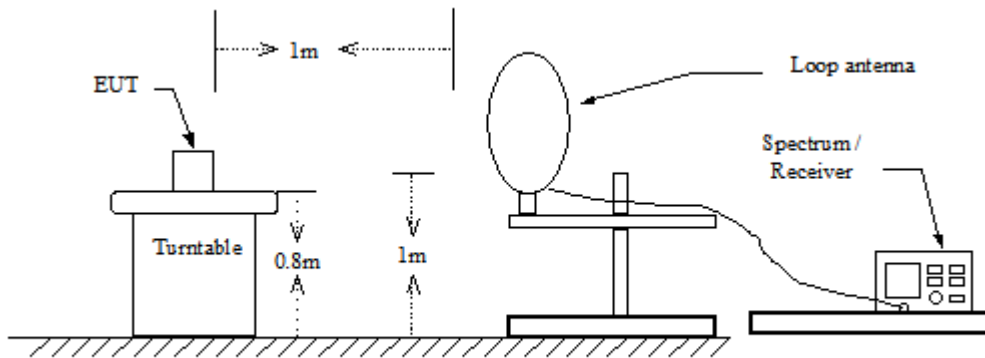

30 MHz ~ 1 GHz

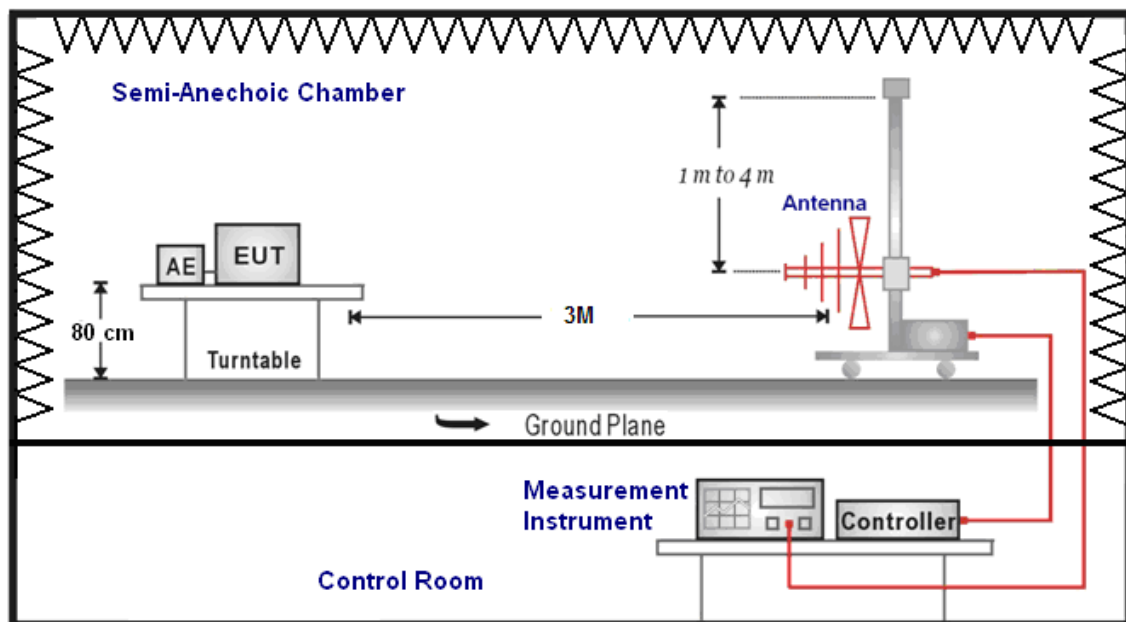

Above 1 GHz

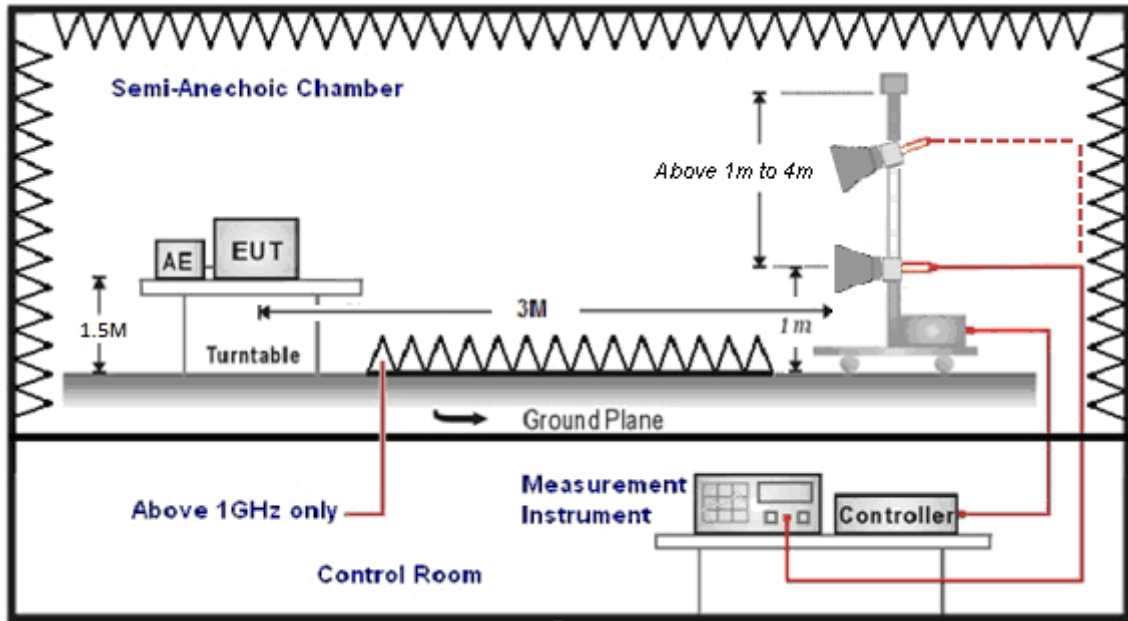

■ Test Procedure

Final radiation measurements were made on a three-meter, Semi Anechoic Chamber. The EUT system was placed on a nonconductive turntable which is 0.8 or 1.5 meters height (below 1 GHz use 0.8 m turntable / above 1 GHz use 1.5 m turntable), top surface 1.0 x 1.5 meter. The spectrum was examined from 250 MHz to 2.5 GHz in order to cover the whole spectrum below 10th harmonic which could generate from the EUT. During the test, EUT was set to transmit continuously & Measurements spectrum range from 9 kHz to 40 GHz is investigated.

For measurements below 1 GHz the resolution bandwidth is set to 100 kHz for peak detection measurements or 120 kHz for quasi-peak detection measurements. Peak detection is used unless otherwise noted as quasi-peak.

For restricted measurements above 1 GHz the resolution bandwidth is set to 1 MHz, and then the video bandwidth is set to 3 MHz for peak measurements and 10 Hz for average measurements when Duty cycle > 0.98 / 1/T for average measurements when Duty cycle < 0.98.

For out of band measurements above 1 GHz the resolution bandwidth is set to 1 MHz, and then the video bandwidth is set to 3 MHz for peak measurements.

A nonconductive material surrounded the EUT to supporting the EUT for standing on three orthogonal planes. At each condition, the EUT was rotated 360 degrees, and the antenna was raised and lowered from one to four meters to find the maximum emission levels. Measurements were taken using both horizontal and vertical antenna polarization.

SCHWARZBECK MESS-ELEKTRONIK Trilog-Broadband Antenna at 3 Meter and the ETS-Lindgren Double-Ridged Waveguide Horn antenna Schwarzbeck Mess-Elektronik Broadband Horn Antenna was used in frequencies 1 – 40 GHz at a distance of 3 meter. The antenna at an angle toward the source of the emission. All test results were extrapolated to equivalent signal at 3 meters utilizing an inverse linear distance extrapolation Factor (20 dB/decade).

For testing above 1 GHz, the emission level of the EUT in peak mode was 20 dB lower than average limit (that means the emission level in peak mode also complies with the limit in average mode), then testing will be stopped and peak values of EUT will be reported, otherwise, the emissions will be measured in average mode again and reported.

Appropriate preamplifiers were used for improving sensitivity and precautions were taken to avoid overloading or desensitizing the spectrum analyzer. No post – detector video filters were used in the test.

The spectrum analyzer's 6 dB bandwidth was set to 1 MHz, and the analyzer was operated in the peak detection mode, for frequencies both below and up 1 GHz. The average levels were obtained by subtracting the duty cycle correction factor from the peak readings.

The following procedures were used to convert the emission levels measured in decibels referenced to 1 microvolt (dBuV) into field intensity in micro volts per meter (uV/m).

The actual field intensity in decibels referenced to 1 microvolt in to field intensity in micro volts per meter (dBuV/m).



The actual field is intensity in referenced to 1 microvolt per meter (dBuV/m) is determined by algebraically adding the measured reading in dBuV, the antenna factor (dB), and cable loss (dB) and Subtracting the gain of preamplifier (dB) is auto calculate in spectrum analyzer.

(1) $\text{Amplitude (dBuV/m)} = \text{FI (dBuV)} + \text{AF (dBuV)} + \text{CL (dBuV)} - \text{Gain (dB)}$

FI= Reading of the field intensity.

AF= Antenna factor.

CL= Cable loss.

P.S Amplitude is auto calculate in spectrum analyzer.

(2) $\text{Actual Amplitude (dBuV/m)} = \text{Amplitude (dBuV)} - \text{Dis(dB)}$

The FCC specified emission limits were calculated according the EUT operating frequency and by following linear interpolation equations:

(a) For fundamental frequency : Transmitter Output < +30 dBm

(b) For spurious frequency : Spurious emission limits = fundamental emission limit /10

Measuring Instruments and setting

The following table is the setting of spectrum analyzer and receiver.

Spectrum Parameter	Setting
Attenuation	Auto
Start Frequency	1000 MHz
Stop Frequency	40 GHz
RBW/VBW(Emission in restricted band)	1 MHz / 3 MHz for Peak 1 MHz / (1/T) for Average
RBW/VBW(Emission in non-restricted band)	1 MHz / 3 MHz for Peak

4.3. Maximum Conducted Output Power Measurement

■ **Limit**

Frequency Range (MHz)	FCC Maximum Conducted Output Power Limit
	Client
5.150 ~ 5.250 GHz	The lesser of 250 mW (24 dBm)
5.725 ~ 5.850 GHz	The lesser of 1 W (30 dBm)

According to FCC KDB 662911 D01 v02r01 – for power measurements on IEEE802.11 devices,

IEEE 802.11a/IEEE 802.11n 5 GHz 20 MHz/IEEE 802.11n 5 GHz 40 MHz/IEEE 802.11ac 20 MHz/IEEE 802.11ac 40 MHz/ IEEE 802.11ac 80 MHz

Band I :

* Directional Gain = $10 \cdot \log\left\{\frac{10^{G1/10} + 10^{G2/10} + \dots + 10^{Gn/10}}{NANT}\right\} = 4.47 \text{ dBi} < 6 \text{ dBi}$

* Power Limit = 30 dBm

Band III :

* Directional Gain = $10 \cdot \log\left\{\frac{10^{G1/10} + 10^{G2/10} + \dots + 10^{Gn/10}}{NANT}\right\} = 5.45 \text{ dBi} < 6 \text{ dBi}$

* Power Limit = 30 dBm

Beamforming on

IEEE 802.11ac 20 MHz//IEEE 802.11ac 40 MHz/ IEEE 802.11ac 80 MHz

Band I :

* Directional Gain = $10 \cdot \log\left\{\frac{10^{G1/20} + 10^{G2/20} + \dots + 10^{Gn/20}}{NANT}\right\}^2 = 10.49 \text{ dBi} > 6 \text{ dBi}$

* Power Limit = $30 - 4.49 = 25.51 \text{ dBm}$

Band III :

* Directional Gain = $10 \cdot \log\left\{\frac{10^{G1/20} + 10^{G2/20} + \dots + 10^{Gn/20}}{NANT}\right\}^2 = 11.47 \text{ dBi} > 6 \text{ dBi}$

* Power Limit = $30 - 5.47 = 24.53 \text{ dBm}$

■ **Test Setup**

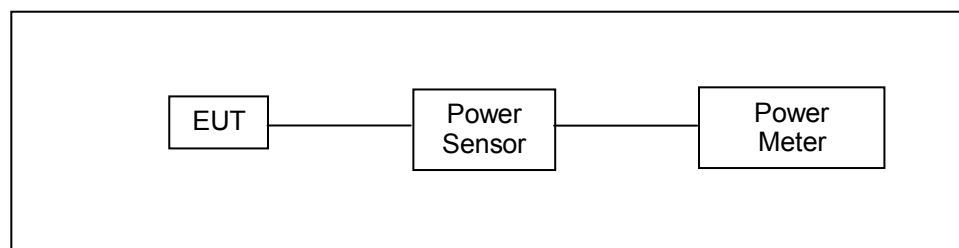

■ **Test Procedure**

The test is performed in accordance with ANSI C63.10:2013 section 12.3.3.2, Guidelines for Compliance Testing of Unlicensed National Information Infrastructure (U-NII) Devices

Section (E) Maximum Conducted Output Power

3. Measurement using a Power Meter (PM)

b) Method PM-G (Measurement using a gated RF average power meter)

4.4. 26 dB RF Bandwidth Measurement & 99 % Occupied Bandwidth Measurement

■ **Limit**

N/A

■ **Test Setup**

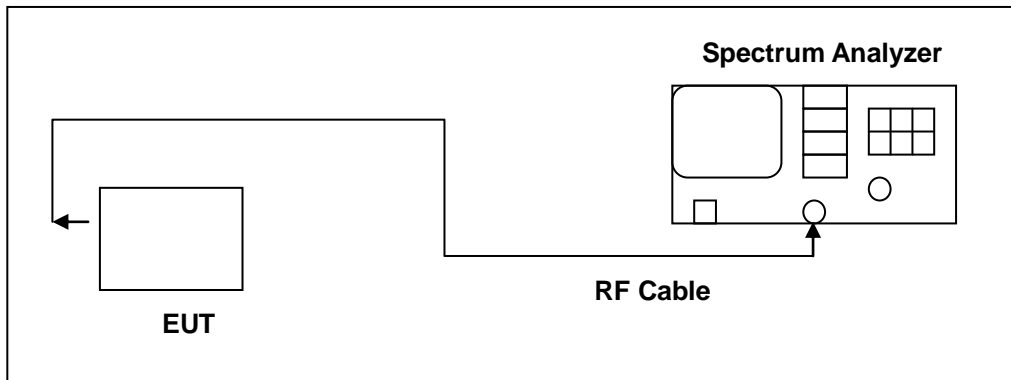

■ **Test Procedure**

The test is performed in accordance with ANSI C63.10:2013 section 12.4, Guidelines for Compliance Testing of Unlicensed National Information Infrastructure (U-NII) Devices - Part 15, Subpart E.

Spectrum Parameter	Setting
Attenuation	Auto
Span Frequency	>26 dB Bandwidth
RBW	Approximately 1 % of the emission bandwidth
VBW	VBW > RBW
Detector	Peak
Trace	Max Hold
Sweep Time	Auto

4.5. 6 dB RF Bandwidth Measurement

- Limit

6 dB RF Bandwidth

Systems using digital modulation techniques may operate in the 5725~5850 MHz bands. The minimum 6 dB band-width shall be at least 500 kHz.

- Test Setup

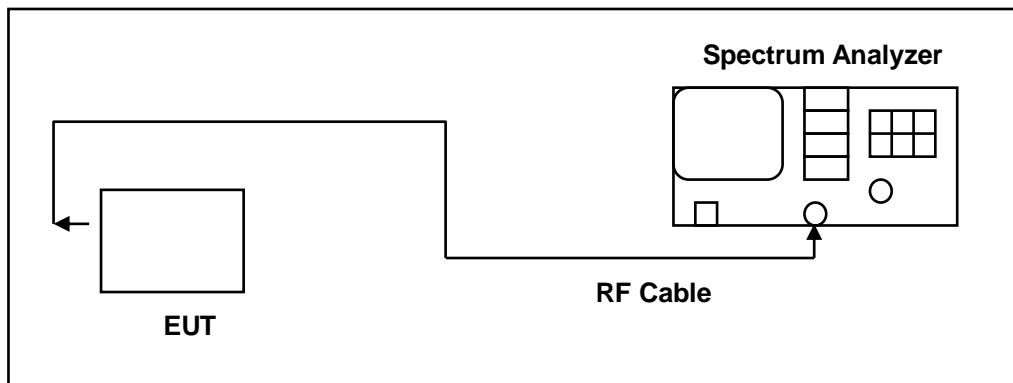

- Test Procedure

6 dB RF Bandwidth

The EUT tested to UNII test procedure of ANSI C63.10:2013 section 6.9.2 for compliance to FCC 47CFR 15.407 requirements.

The antenna port of the EUT was connected to the input of a spectrum analyzer. Analyzer RES BW was set to 100 kHz. For each RF output channel investigated, the spectrum analyzer center frequency was set to the channel carrier. A peak output reading was taken, a DISPLAY line was drawn 6 dB lower than peak level. The 6 dB bandwidth was determined from where the channel output spectrum intersected the display line.

The test was performed at 3 channels.



4.6. Maximum Power Spectral Density Measurement

■ Limit

Conducted power spectral density

Frequency Range (MHz)	FCC Limit
	Client
5.150 ~ 5.250 GHz	11 dBm/MHz
5.725 ~ 5.850 GHz	30 dBm/500 kHz

According FCC KDB 662911 D01 v02r01 – for power spectral density measurements on IEEE802.11 devices,

IEEE 802.11a

Band I :

* Directional Gain = $10 \cdot \log\{[10^{G1/20} + 10^{G2/20} + \dots + 10^{Gn/20}]^2 / NANT\}$ = 10.49 dBi > 6 dBi

* Conducted Power Spectral Density Limit = 17 - 4.49 = 12.51 dBm/MHz

Band III :

* Directional Gain = $10 \cdot \log\{[10^{G1/20} + 10^{G2/20} + \dots + 10^{Gn/20}]^2 / NANT\}$ = 11.47 dBi > 6 dBi

* Conducted Power Spectral Density Limit = 30 - 5.47 = 24.53 dBm/500 kHz

IEEE 802.11ac 20 MHz/IEEE 802.11ac 40 MHz/ IEEE 802.11ac 80 MHz

Band I :

* Directional Gain = $10 \cdot \log\{[10^{G1/10} + 10^{G2/10} + \dots + 10^{Gn/10}] / NANT\}$ = 4.47 dBi < 6 dBi

* Conducted Power Spectral Density Limit = 17 dBm/MHz

Band III :

* Directional Gain = $10 \cdot \log\{[10^{G1/10} + 10^{G2/10} + \dots + 10^{Gn/10}] / NANT\}$ = 5.45 dBi < 6 dBi

* Conducted Power Spectral Density Limit = 30 dBm/500 kHz

Beamforming on

IEEE 802.11ac 20 MHz//IEEE 802.11ac 40 MHz/ IEEE 802.11ac 80 MHz

Band I :

* Directional Gain = $10 \cdot \log\{[10^{G1/20} + 10^{G2/20} + \dots + 10^{Gn/20}]^2 / NANT\}$ = 10.49 dBi > 6 dBi;

* Conducted Power Spectral Density Limit = 17 - 4.49 = 12.51 dBm/MHz

Band III :

* Directional Gain = $10 \cdot \log\{[10^{G1/20} + 10^{G2/20} + \dots + 10^{Gn/20}]^2 / NANT\}$ = 11.47 dBi > 6 dBi

* Conducted Power Spectral Density Limit = 30 - 5.47 = 24.53 dBm/500 KHz

■ **Test Setup**

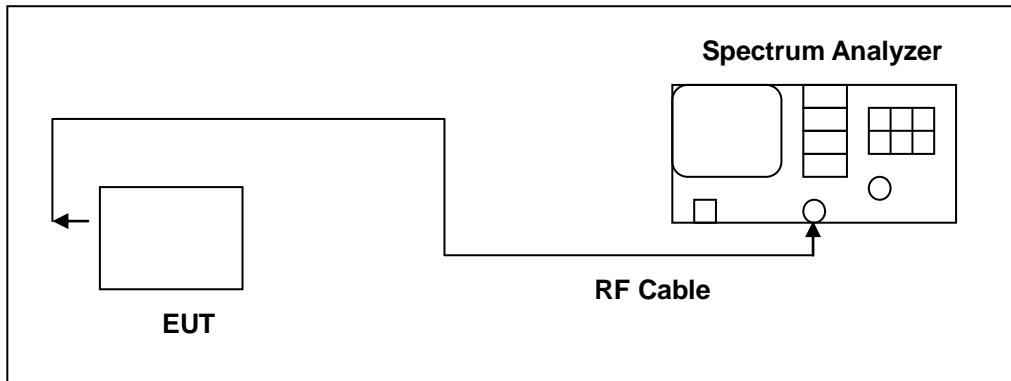

■ **Test Procedure**

The test is performed in accordance with ANSI C63.10:2013 section 12.5, Guidelines for Compliance Testing of Unlicensed National Information Infrastructure (U-NII) Devices - Part 15, Subpart E.

Spectrum Parameter	Setting
Attenuation	Auto
Span Frequency	Encompass the entire emissions bandwidth (EBW) of the signal
RBW	1 MHz (5725 ~ 5850 MHz use 100 kHz)
VBW	3 MHz (5725 ~ 5850 MHz use 300 kHz)
Detector	RMS
Trace	AVERAGE
Sweep Time	Auto
Trace Average	100 times
Note: If measurement bandwidth of Maximum PSD is specified in 500 kHz, add $10 \log(500 \text{ kHz}/100 \text{ kHz})$ to the measured result.	

4.7. Automatically discontinue transmission

The device shall automatically discontinue transmission in case of either absence of information to transmit or operational failure. These provisions are not intended to preclude the transmission of control or signalling information or the use of repetitive codes used by certain digital technologies to complete frame or burst intervals. Applicants shall include in their application for equipment authorization a description of how this requirement is met.

■ **Declare**

While the EUT is not transmitting any information, the EUT can automatically discontinue transmission and become standby mode for power saving.

The EUT can detect the controlling signal of ACK message transmitting from remote device and verify whether it shall resend or discontinue transmission.

4.8. Antenna Requirement

■ **Limit**

For intentional device, according to 15.203, an intentional radiator shall be designed to ensure that no antenna other than that furnished by the responsible party shall be used with the device.

And According to 15.407 (a), if transmitting antennas of directional gain greater than 6 dBi are used, the power shall be reduced by the amount in dB that the directional gain of the antenna exceeds 6 dBi.

■ **Antenna Connector Construction**

See section 2 – antenna information.

■ **Directional Gain Calculated**

For Maximum Conducted Output Power

$$\text{Directional Gain} = 10 \cdot \log\{[10^{(G1/10)} + 10^{(G2/10)} + \dots + 10^{(Gn/10)}] / NANT\}$$

Operate Freq. Band		Directional Gain (dBi)
IEEE 802.11a	U-NII Band I	4.47
	U-NII Band III	5.45
IEEE 802.11n 5 GHz 20 MHz	U-NII Band I	4.47
	U-NII Band III	5.45
IEEE 802.11n 5 GHz 40 MHz	U-NII Band I	4.47
	U-NII Band III	5.45
IEEE 802.11ac 20 MHz	U-NII Band I	4.47
	U-NII Band III	5.45
IEEE 802.11ac 40 MHz	U-NII Band I	4.47
	U-NII Band III	5.45
IEEE 802.11ac 80 MHz	U-NII Band I	4.47
	U-NII Band III	5.45



Beamforming on		
Directional Gain = $10 \cdot \log\{[10^{(G1/20)} + 10^{(G2/20)} + \dots + 10^{(Gn/20)}]^2 / NANT\}$		
Operate Freq. Band		Directional Gain (dBi)
IEEE 802.11ac 20 MHz	U-NII Band I	10.49
	U-NII Band III	11.47
IEEE 802.11ac 40 MHz	U-NII Band I	10.49
	U-NII Band III	11.47
IEEE 802.11ac 80 MHz	U-NII Band I	10.49
	U-NII Band III	11.47

For Maximum Power Density

Directional Gain = $10 \cdot \log\{[10^{(G1/10)} + 10^{(G2/10)} + \dots + 10^{(Gn/10)}] / NANT\}$

Operate Freq. Band		Directional Gain (dBi)
IEEE 802.11a	U-NII Band I	10.49
	U-NII Band III	11.47
IEEE 802.11ac 20 MHz	U-NII Band I	4.47
	U-NII Band III	5.45
IEEE 802.11ac 40 MHz	U-NII Band I	4.47
	U-NII Band III	5.45
IEEE 802.11ac 80 MHz	U-NII Band I	4.47
	U-NII Band III	5.45

Beamforming on		
Directional Gain = $10 \cdot \log\{[10^{(G1/20)} + 10^{(G2/20)} + \dots + 10^{(Gn/20)}]^2 / NANT\}$		
Operate Freq. Band		Directional Gain (dBi)
IEEE 802.11ac 20 MHz	U-NII Band I	10.49
	U-NII Band III	11.47
IEEE 802.11ac 40 MHz	U-NII Band I	10.49
	U-NII Band III	11.47
IEEE 802.11ac 80 MHz	U-NII Band I	10.49
	U-NII Band III	11.47



5 Test Results

Annex A. Conducted Emission

Standard:	FCC Part 15.407	Line:	L1
Test item:	Conducted Emission	Power:	AC 120 V/60 Hz
Test Mode:	Mode 1	Temp.(°C)/Hum.(%RH):	26(°C)/60 %RH
Description:			

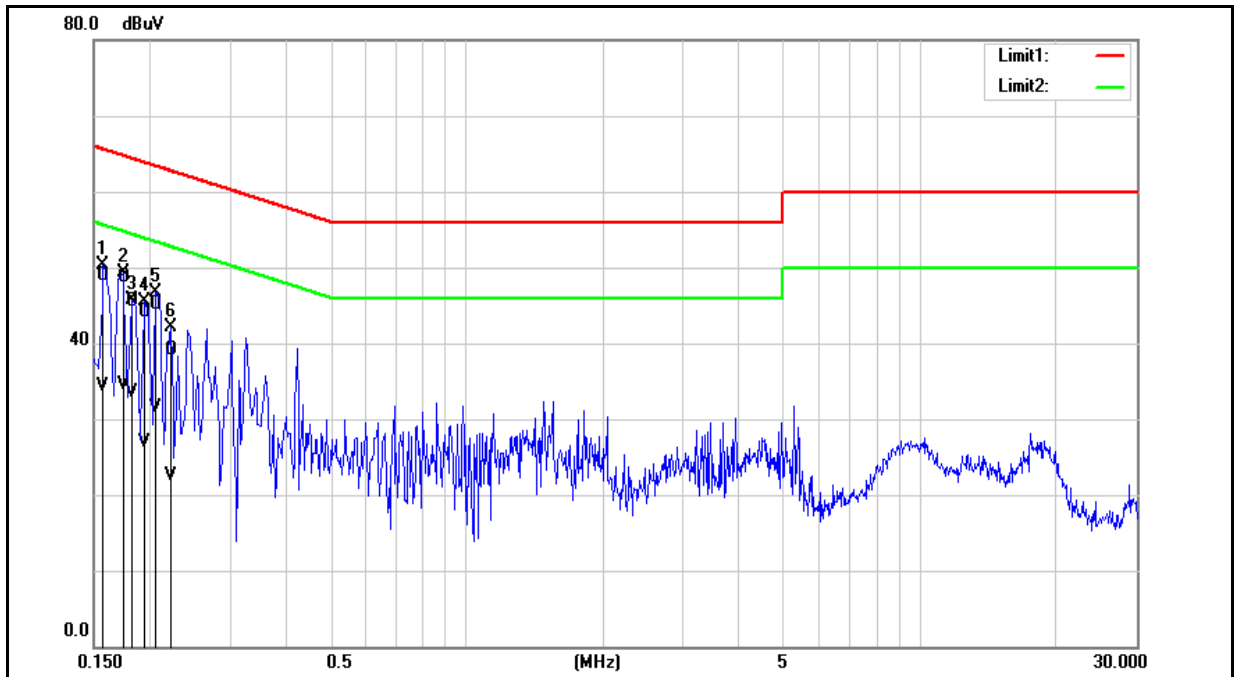

No.	Frequency (MHz)	QP reading (dBuV)	AVG reading (dBuV)	Correction factor (dB)	QP result (dBuV)	AVG result (dBuV)	QP limit (dBuV)	AVG limit (dBuV)	QP margin (dB)	AVG margin (dB)	Remark
1	0.1580	39.27	24.66	9.65	48.92	34.31	65.57	55.57	-16.65	-21.26	Pass
2	0.1740	39.06	24.79	9.65	48.71	34.44	64.77	54.77	-16.06	-20.33	Pass
3	0.1820	35.84	23.80	9.64	45.48	33.44	64.39	54.39	-18.91	-20.95	Pass
4	0.1940	34.55	17.34	9.64	44.19	26.98	63.86	53.86	-19.67	-26.88	Pass
5	0.2060	35.40	21.86	9.64	45.04	31.50	63.37	53.37	-18.33	-21.87	Pass
6	0.2220	29.44	12.90	9.64	39.08	22.54	62.74	52.74	-23.66	-30.20	Pass

Note: 1. Result (dBuV) = Correction factor (dB) + Reading(dBuV).

2. Correction factor (dB) = Cable loss (dB) + L.I.S.N. factor (dB).

Standard:	FCC Part 15.407	Line:	N
Test item:	Conducted Emission	Power:	AC 120 V/60 Hz
Test Mode:	Mode 1	Temp.(°C)/Hum.(%RH):	26(°C)/60 %RH
Description:			

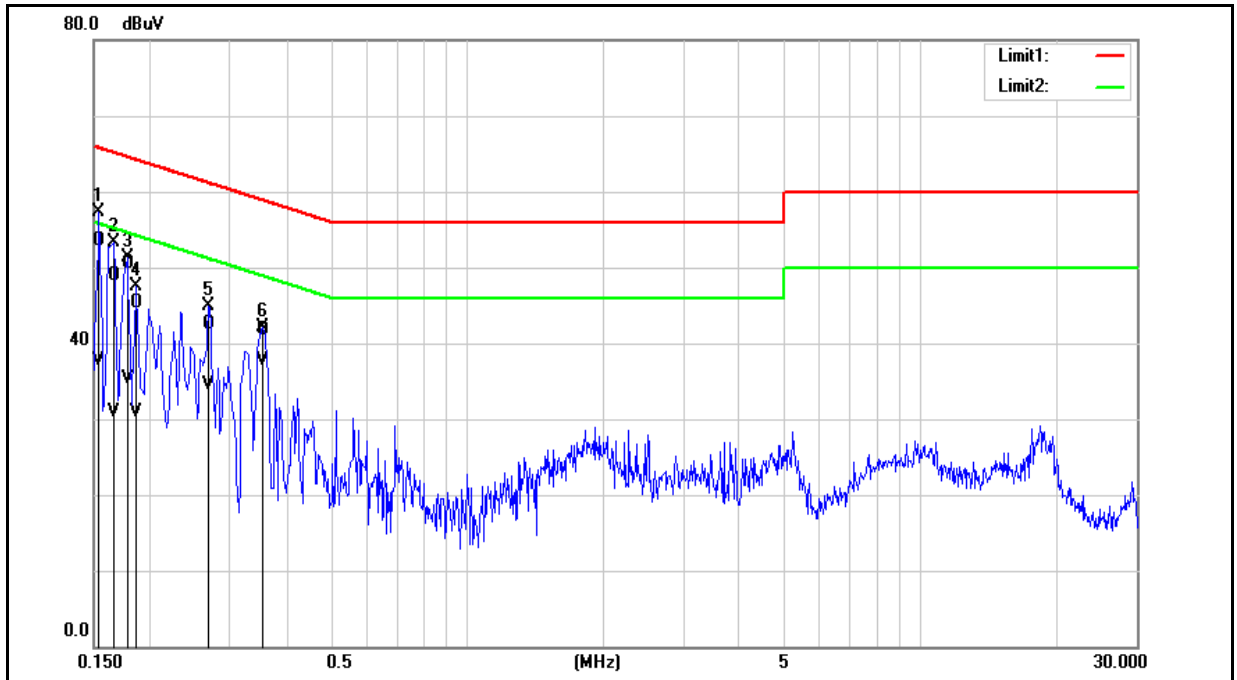

No.	Frequency (MHz)	QP reading (dBuV)	AVG reading (dBuV)	Correction factor (dB)	QP result (dBuV)	AVG result (dBuV)	QP limit (dBuV)	AVG limit (dBuV)	QP margin (dB)	AVG margin (dB)	Remark
1	0.1540	43.84	28.00	9.68	53.52	37.68	65.78	55.78	-12.26	-18.10	Pass
2	0.1660	39.15	21.32	9.68	48.83	31.00	65.16	55.16	-16.33	-24.16	Pass
3	0.1780	40.83	25.70	9.67	50.50	35.37	64.58	54.58	-14.08	-19.21	Pass
4	0.1860	35.70	21.28	9.67	45.37	30.95	64.21	54.21	-18.84	-23.26	Pass
5	0.2700	32.87	24.80	9.67	42.54	34.47	61.12	51.12	-18.58	-16.65	Pass
6	0.3540	32.08	28.01	9.68	41.76	37.69	58.87	48.87	-17.11	-11.18	Pass

Note: 1. Result (dBuV) = Correction factor (dB) + Reading(dBuV).

2. Correction factor (dB) = Cable loss (dB) + L.I.S.N. factor (dB).



Annex B. Radiated Emission Measurement

Harmonic

Below 1 GHz

Standard:	FCC Part 15.407	Test Distance:	3 m
Test item:	Harmonic	Power:	AC 120 V/60 Hz
Frequency:	5240 MHz	Temp.(°C)/Hum.(%RH):	26(°C)/60 %RH
Test Mode:	Mode 2		

Frequency (MHz)	Reading (dBuV)	Correct Factor (dB/m)	Result (dBuV/m)	Limit (dBuV/m)	Margin (dB)	Remark	Ant.Polar. H / V
128.9400	43.89	-7.58	36.31	43.50	-7.19	QP	H
224.0000	41.97	-7.41	34.56	46.00	-11.44	QP	H
437.4000	35.81	-1.27	34.54	46.00	-11.46	QP	H
520.8200	36.27	0.03	36.30	46.00	-9.70	QP	H
674.0800	29.70	3.13	32.83	46.00	-13.17	QP	H
792.4200	28.96	5.68	34.64	46.00	-11.36	QP	H
40.6700	40.72	-6.88	33.84	40.00	-6.16	QP	V
93.0500	45.06	-11.94	33.12	43.50	-10.38	QP	V
128.9400	44.56	-7.58	36.98	43.50	-6.52	QP	V
224.0000	47.58	-7.41	40.17	46.00	-5.83	QP	V
434.4900	37.06	-1.35	35.71	46.00	-10.29	QP	V
522.7600	37.28	0.06	37.34	46.00	-8.66	QP	V

Note:1.Result (dBuV/m) = Correct Factor (dB/m) + Reading(dBuV).

Example: 36.31 = -7.58 + 43.89

2.Correction factor (dB/m) = Antenna Factor (dB/m) + Cable loss (dB) – Pre-Amplifier gain (dB).

3.When the peak results are less than average limit, so not need to evaluate the average.



Beamforming on

Standard:	FCC Part 15.407	Test Distance:	3 m
Test item:	Harmonic	Power:	AC 120 V/60 Hz
Frequency:	5180 MHz	Temp.(°C)/Hum.(%RH):	26(°C)/60 %RH
Test Mode:	Mode 5		

Frequency (MHz)	Reading (dBuV)	Correct Factor (dB/m)	Result (dBuV/m)	Limit (dBuV/m)	Margin (dB)	Remark	Ant.Polar. H / V
93.0500	44.60	-11.94	32.66	43.50	-10.84	QP	H
129.9100	42.85	-7.49	35.36	43.50	-8.14	QP	H
221.0900	47.34	-7.49	39.85	46.00	-6.15	QP	H
435.4600	37.25	-1.33	35.92	46.00	-10.08	QP	H
521.7900	36.88	0.05	36.93	46.00	-9.07	QP	H
772.0500	28.56	5.34	33.90	46.00	-12.10	QP	H
127.9700	42.69	-7.66	35.03	43.50	-8.47	QP	V
221.0900	43.57	-7.49	36.08	46.00	-9.92	QP	V
300.6300	33.91	-4.03	29.88	46.00	-16.12	QP	V
440.3100	35.20	-1.20	34.00	46.00	-12.00	QP	V
524.7000	36.51	0.10	36.61	46.00	-9.39	QP	V
769.1400	28.43	5.29	33.72	46.00	-12.28	QP	V

Note:1.Result (dBuV/m) = Correct Factor (dB/m) + Reading(dBuV).

Example: 32.66 = -11.94 + 44.60

2.Correction factor (dB/m) = Antenna Factor (dB/m) + Cable loss (dB) – Pre-Amplifier gain (dB).

3.When the peak results are less than average limit, so not need to evaluate the average.



Above 1 GHz

Standard:	FCC Part 15.407	Test Distance:	3 m
Test item:	Harmonic	Power:	AC 120 V/60 Hz
Frequency:	5180 MHz	Temp.(°C)/Hum.(%RH):	26(°C)/60 %RH
Mode:	Mode 2	Date:	
Ant.Polar.:	Horizontal		

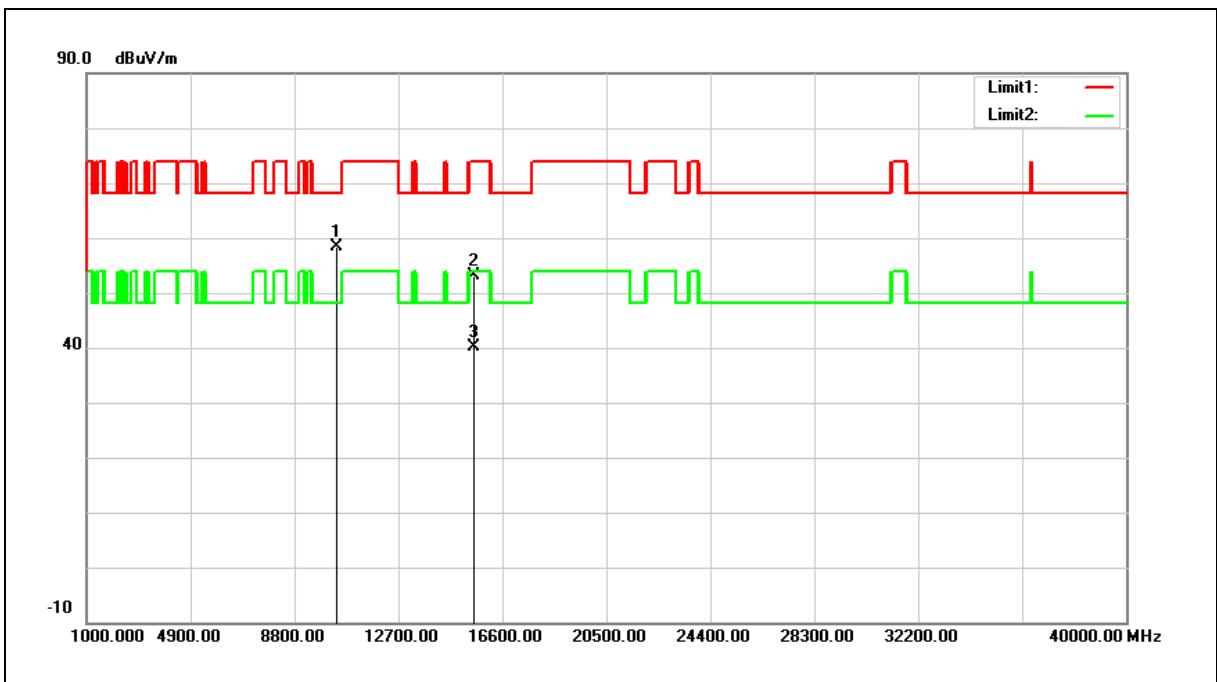

No.	Frequency (MHz)	Reading (dBuV)	Correct Factor (dB/m)	Result (dBuV/m)	Limit (dBuV/m)	Margin (dB)	Remark
1	10360.000	41.56	16.92	58.48	68.20	-9.72	peak
2	15540.000	33.88	19.18	53.06	74.00	-20.94	peak
3	15540.000	20.87	19.18	40.05	54.00	-13.95	AVG

Note:1.Result (dBuV/m) = Correct Factor (dB/m) + Reading(dBuV).

2.Correction factor (dB/m) = Antenna Factor (dB/m) + Cable loss (dB) – Pre-Amplifier gain (dB).

3. When the peak results are less than average limit, so not need to evaluate the average.



Standard:	FCC Part 15.407	Test Distance:	3 m
Test item:	Harmonic	Power:	AC 120 V/60 Hz
Frequency:	5180 MHz	Temp.(°C)/Hum.(%RH):	26(°C)/60 %RH
Mode:	Mode 2	Date:	
Ant.Polar.:	Vertical		

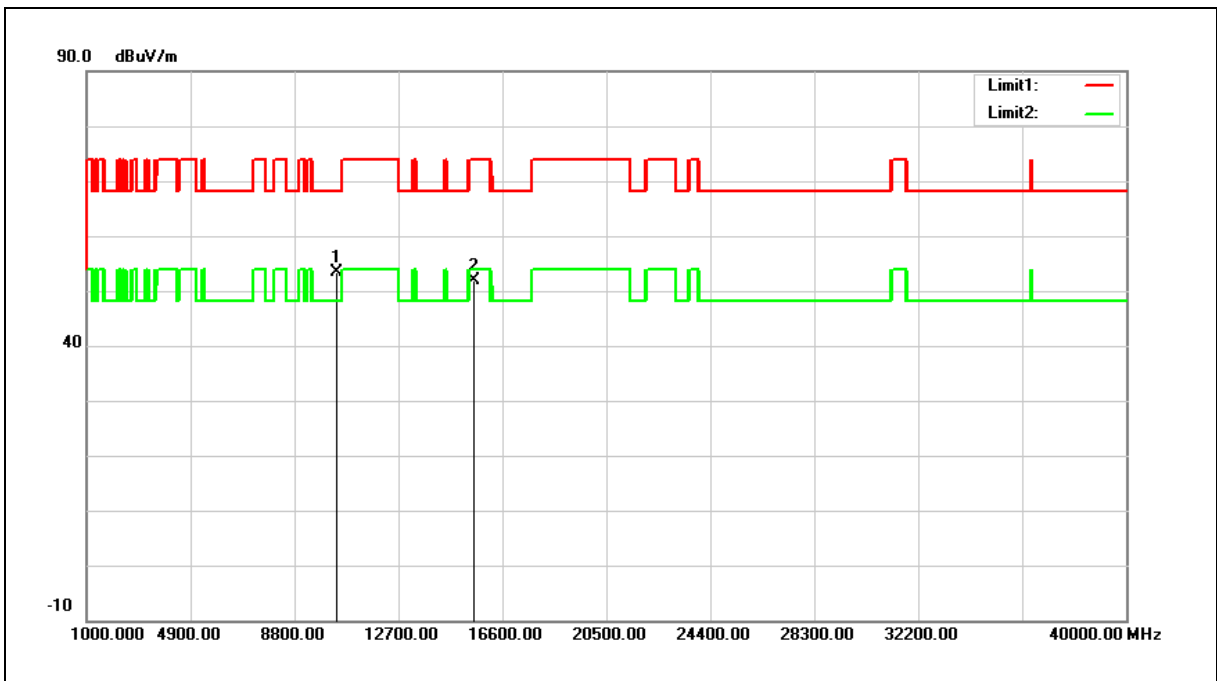

No.	Frequency (MHz)	Reading (dBuV)	Correct Factor (dB/m)	Result (dBuV/m)	Limit (dBuV/m)	Margin (dB)	Remark
1	10360.000	36.46	16.92	53.38	68.20	-14.82	peak
2	15540.000	32.80	19.18	51.98	74.00	-22.02	peak

Note:1.Result (dBuV/m) = Correct Factor (dB/m) + Reading(dBuV).

2.Correction factor (dB/m) = Antenna Factor (dB/m) + Cable loss (dB) – Pre-Amplifier gain (dB).

3. When the peak results are less than average limit, so not need to evaluate the average.



Standard:	FCC Part 15.407	Test Distance:	3 m
Test item:	Harmonic	Power:	AC 120 V/60 Hz
Frequency:	5200 MHz	Temp.(°C)/Hum.(%RH):	26(°C)/60 %RH
Mode:	Mode 2	Date:	
Ant.Polar.:	Horizontal		

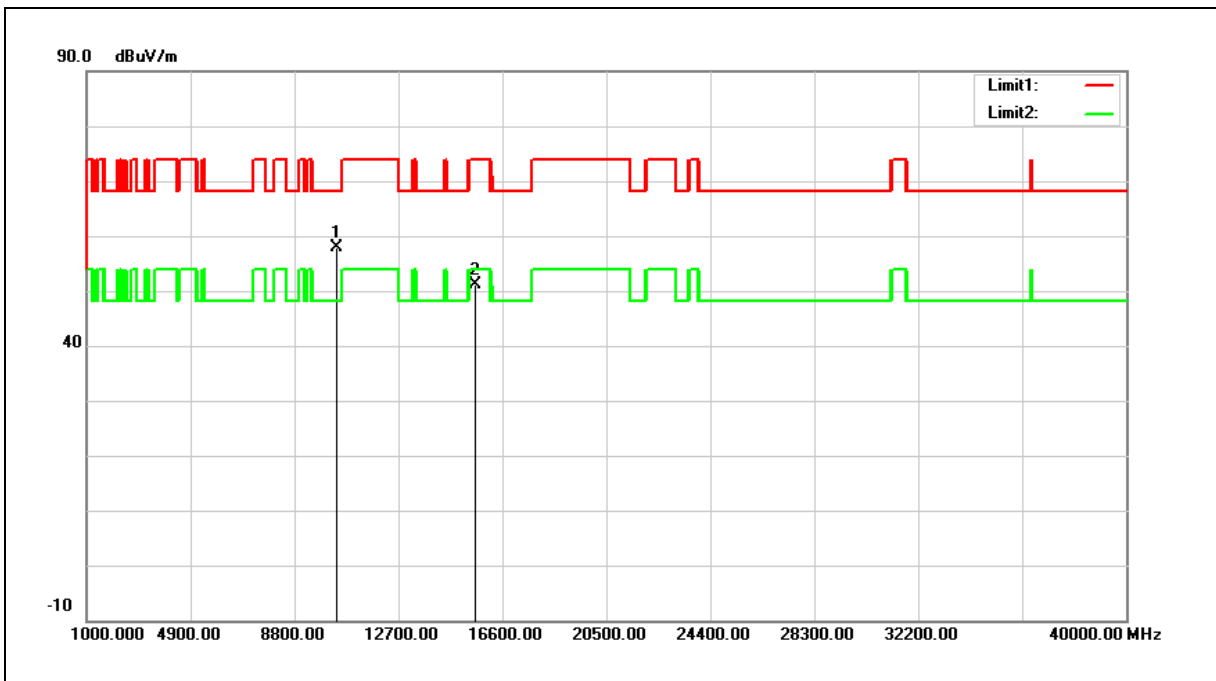

No.	Frequency (MHz)	Reading (dBuV)	Correct Factor (dB/m)	Result (dBuV/m)	Limit (dBuV/m)	Margin (dB)	Remark
1	10400.000	40.85	17.06	57.91	68.20	-10.29	peak
2	15600.000	32.10	19.02	51.12	74.00	-22.88	peak

- Note:1.Result (dBuV/m) = Correct Factor (dB/m) + Reading(dBuV).
- 2.Correction factor (dB/m) = Antenna Factor (dB/m) + Cable loss (dB) – Pre-Amplifier gain (dB).
3. When the peak results are less than average limit, so not need to evaluate the average.



Standard:	FCC Part 15.407	Test Distance:	3 m
Test item:	Harmonic	Power:	AC 120 V/60 Hz
Frequency:	5200 MHz	Temp.(°C)/Hum.(%RH):	26(°C)/60 %RH
Mode:	Mode 2	Date:	
Ant.Polar.:	Vertical		

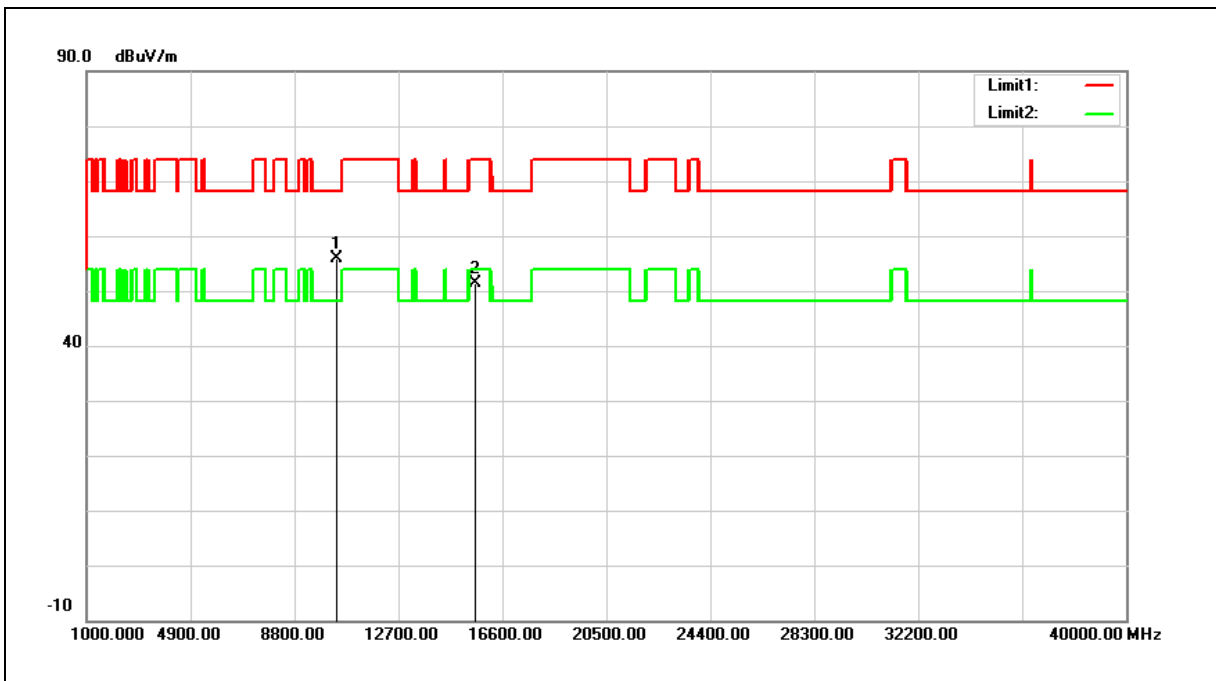

No.	Frequency (MHz)	Reading (dBuV)	Correct Factor (dB/m)	Result (dBuV/m)	Limit (dBuV/m)	Margin (dB)	Remark
1	10400.000	38.75	17.06	55.81	68.20	-12.39	peak
2	15600.000	32.33	19.02	51.35	74.00	-22.65	peak

Note:1.Result (dBuV/m) = Correct Factor (dB/m) + Reading(dBuV).

2.Correction factor (dB/m) = Antenna Factor (dB/m) + Cable loss (dB) – Pre-Amplifier gain (dB).

3. When the peak results are less than average limit, so not need to evaluate the average.



Standard:	FCC Part 15.407	Test Distance:	3 m
Test item:	Harmonic	Power:	AC 120 V/60 Hz
Frequency:	5240 MHz	Temp.(°C)/Hum.(%RH):	26(°C)/60 %RH
Mode:	Mode 2	Date:	
Ant.Polar.:	Horizontal		

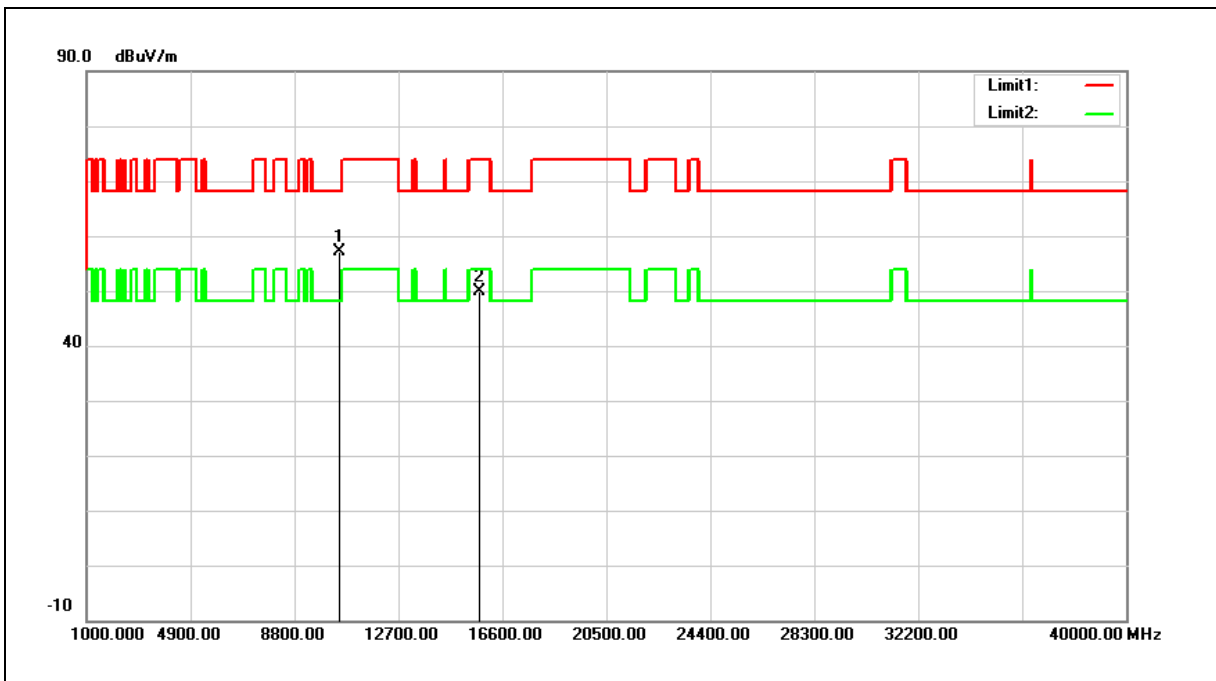

No.	Frequency (MHz)	Reading (dBuV)	Correct Factor (dB/m)	Result (dBuV/m)	Limit (dBuV/m)	Margin (dB)	Remark
1	10480.000	39.87	17.35	57.22	68.20	-10.98	peak
2	15720.000	31.18	18.71	49.89	74.00	-24.11	peak

- Note:1.Result (dBuV/m) = Correct Factor (dB/m) + Reading(dBuV).
- 2.Correction factor (dB/m) = Antenna Factor (dB/m) + Cable loss (dB) – Pre-Amplifier gain (dB).
3. When the peak results are less than average limit, so not need to evaluate the average.



Standard:	FCC Part 15.407	Test Distance:	3 m
Test item:	Harmonic	Power:	AC 120 V/60 Hz
Frequency:	5240 MHz	Temp.(°C)/Hum.(%RH):	26(°C)/60 %RH
Mode:	Mode 2	Date:	
Ant.Polar.:	Vertical		

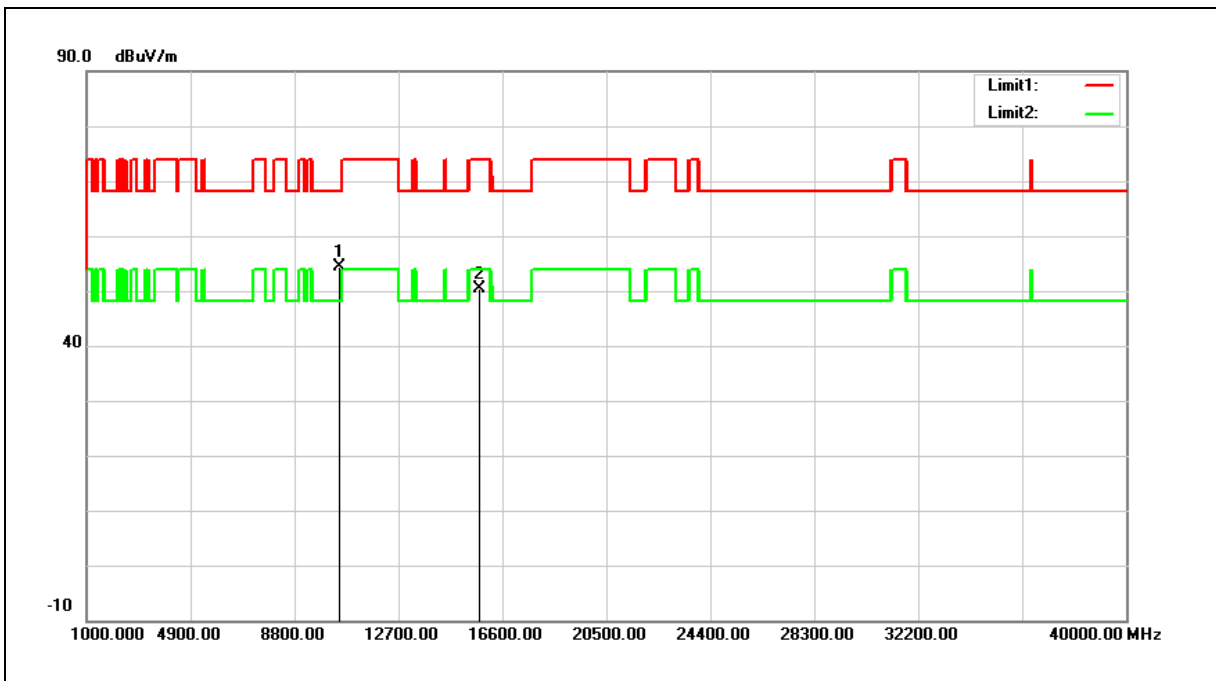

No.	Frequency (MHz)	Reading (dBuV)	Correct Factor (dB/m)	Result (dBuV/m)	Limit (dBuV/m)	Margin (dB)	Remark
1	10480.000	36.98	17.35	54.33	68.20	-13.87	peak
2	15720.000	31.69	18.71	50.40	74.00	-23.60	peak

- Note:1.Result (dBuV/m) = Correct Factor (dB/m) + Reading(dBuV).
- 2.Correction factor (dB/m) = Antenna Factor (dB/m) + Cable loss (dB) – Pre-Amplifier gain (dB).
3. When the peak results are less than average limit, so not need to evaluate the average.



Standard:	FCC Part 15.407	Test Distance:	3 m
Test item:	Harmonic	Power:	AC 120 V/60 Hz
Frequency:	5745 MHz	Temp.(°C)/Hum.(%RH):	26(°C)/60 %RH
Mode:	Mode 2	Date:	
Ant.Polar.:	Horizontal		

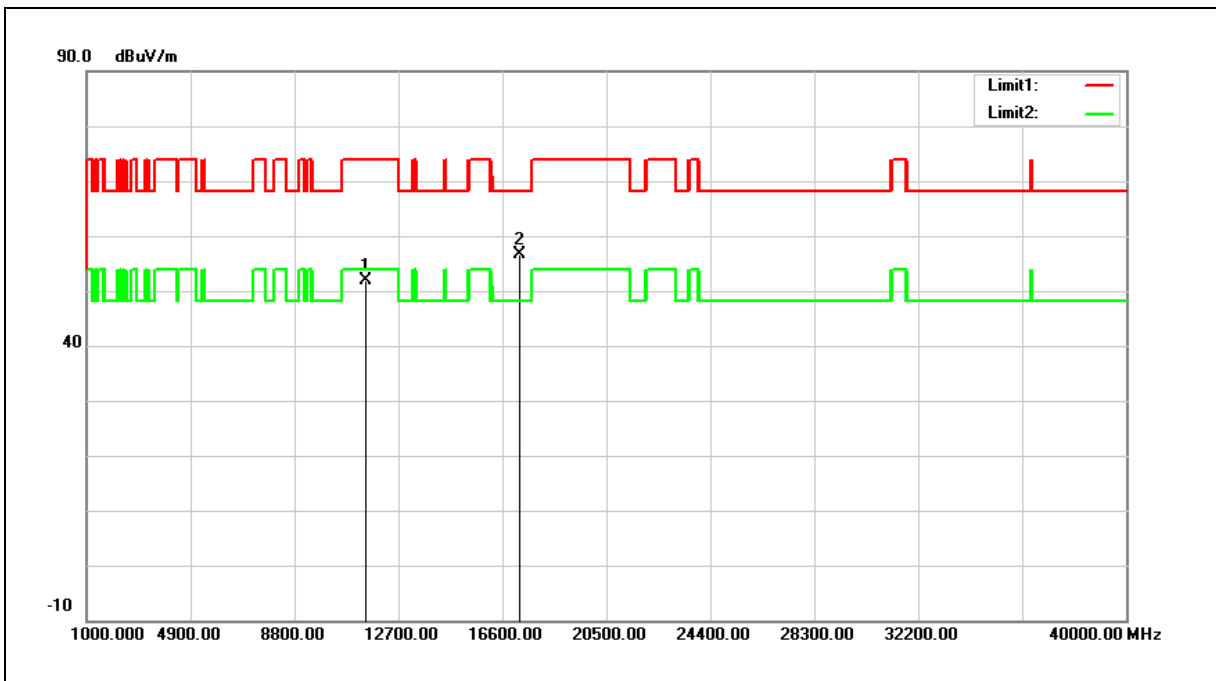

No.	Frequency (MHz)	Reading (dBuV)	Correct Factor (dB/m)	Result (dBuV/m)	Limit (dBuV/m)	Margin (dB)	Remark
1	11490.000	33.46	18.50	51.96	74.00	-22.04	peak
2	17235.000	32.41	24.31	56.72	68.20	-11.48	peak

Note:1.Result (dBuV/m) = Correct Factor (dB/m) + Reading(dBuV).

2.Correction factor (dB/m) = Antenna Factor (dB/m) + Cable loss (dB) – Pre-Amplifier gain (dB).

3. When the peak results are less than average limit, so not need to evaluate the average.



Standard:	FCC Part 15.407	Test Distance:	3 m
Test item:	Harmonic	Power:	AC 120 V/60 Hz
Frequency:	5745 MHz	Temp.(°C)/Hum.(%RH):	26(°C)/60 %RH
Mode:	Mode 2	Date:	
Ant.Polar.:	Vertical		

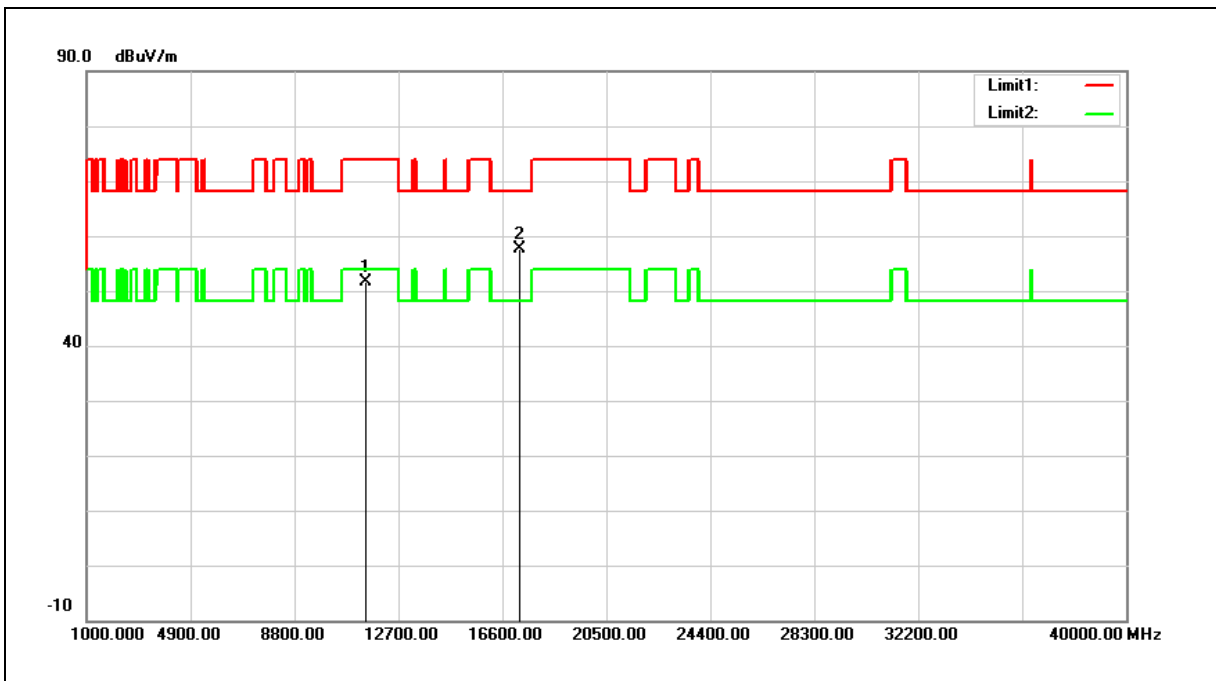

No.	Frequency (MHz)	Reading (dBuV)	Correct Factor (dB/m)	Result (dBuV/m)	Limit (dBuV/m)	Margin (dB)	Remark
1	11490.000	33.03	18.50	51.53	74.00	-22.47	peak
2	17235.000	33.30	24.31	57.61	68.20	-10.59	peak

Note:1.Result (dBuV/m) = Correct Factor (dB/m) + Reading(dBuV).

2.Correction factor (dB/m) = Antenna Factor (dB/m) + Cable loss (dB) – Pre-Amplifier gain (dB).

3. When the peak results are less than average limit, so not need to evaluate the average.



Standard:	FCC Part 15.407	Test Distance:	3 m
Test item:	Harmonic	Power:	AC 120 V/60 Hz
Frequency:	5785 MHz	Temp.(°C)/Hum.(%RH):	26(°C)/60 %RH
Mode:	Mode 2	Date:	
Ant.Polar.:	Horizontal		

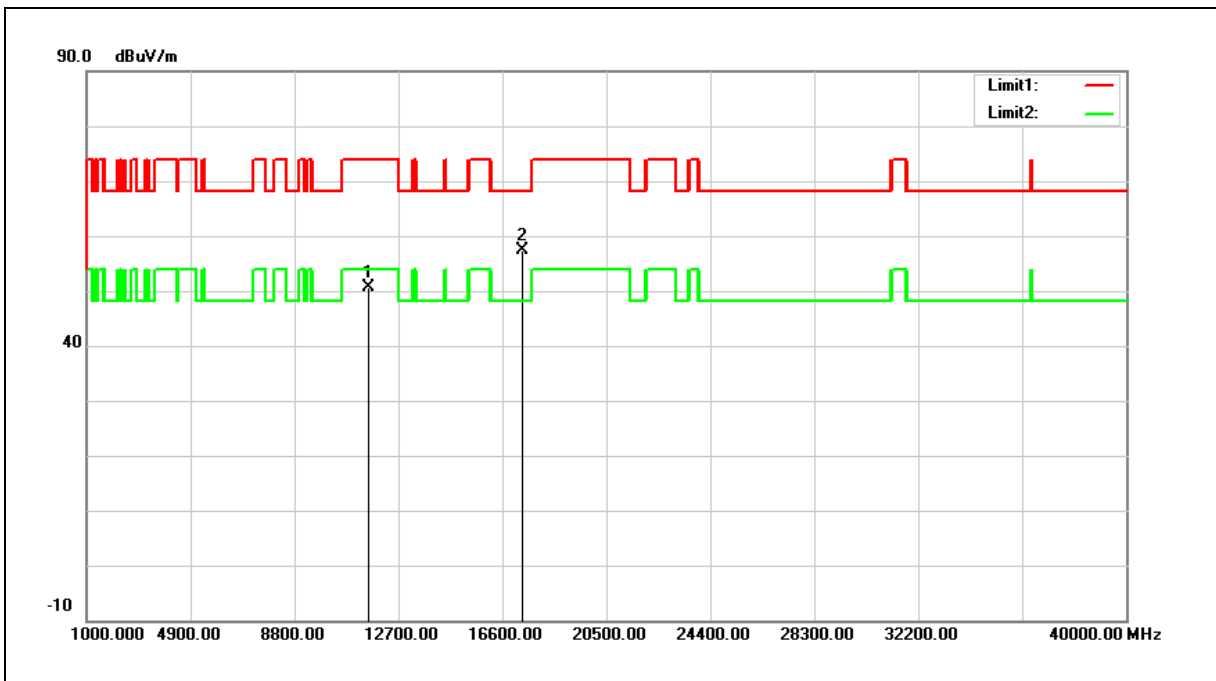

No.	Frequency (MHz)	Reading (dBuV)	Correct Factor (dB/m)	Result (dBuV/m)	Limit (dBuV/m)	Margin (dB)	Remark
1	11570.000	32.29	18.44	50.73	74.00	-23.27	peak
2	17355.000	32.58	24.79	57.37	68.20	-10.83	peak

Note:1.Result (dBuV/m) = Correct Factor (dB/m) + Reading(dBuV).

2.Correction factor (dB/m) = Antenna Factor (dB/m) + Cable loss (dB) – Pre-Amplifier gain (dB).

3. When the peak results are less than average limit, so not need to evaluate the average.



Standard:	FCC Part 15.407	Test Distance:	3 m
Test item:	Harmonic	Power:	AC 120 V/60 Hz
Frequency:	5785 MHz	Temp.(°C)/Hum.(%RH):	26(°C)/60 %RH
Mode:	Mode 2	Date:	
Ant.Polar.:	Vertical		

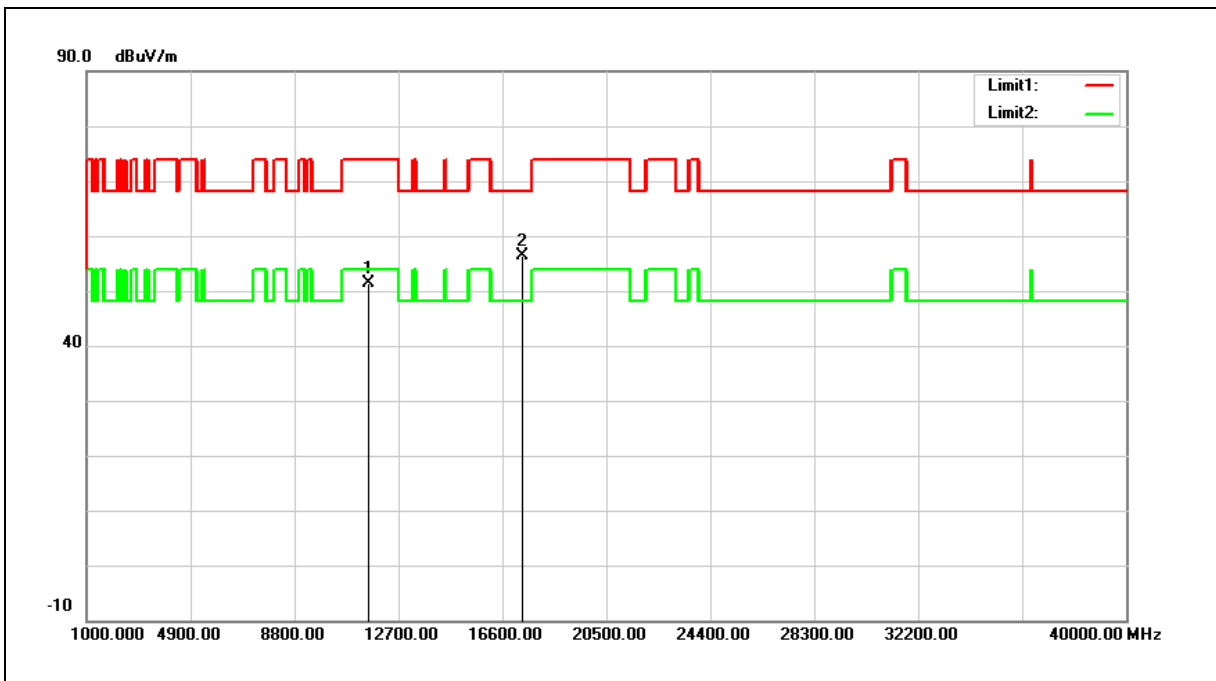

No.	Frequency (MHz)	Reading (dBuV)	Correct Factor (dB/m)	Result (dBuV/m)	Limit (dBuV/m)	Margin (dB)	Remark
1	11570.000	32.87	18.44	51.31	74.00	-22.69	peak
2	17355.000	31.62	24.79	56.41	68.20	-11.79	peak

Note:1.Result (dBuV/m) = Correct Factor (dB/m) + Reading(dBuV).

2.Correction factor (dB/m) = Antenna Factor (dB/m) + Cable loss (dB) – Pre-Amplifier gain (dB).

3. When the peak results are less than average limit, so not need to evaluate the average.



Standard:	FCC Part 15.407	Test Distance:	3 m
Test item:	Harmonic	Power:	AC 120 V/60 Hz
Frequency:	5825 MHz	Temp.(°C)/Hum.(%RH):	26(°C)/60 %RH
Mode:	Mode 2	Date:	
Ant.Polar.:	Horizontal		

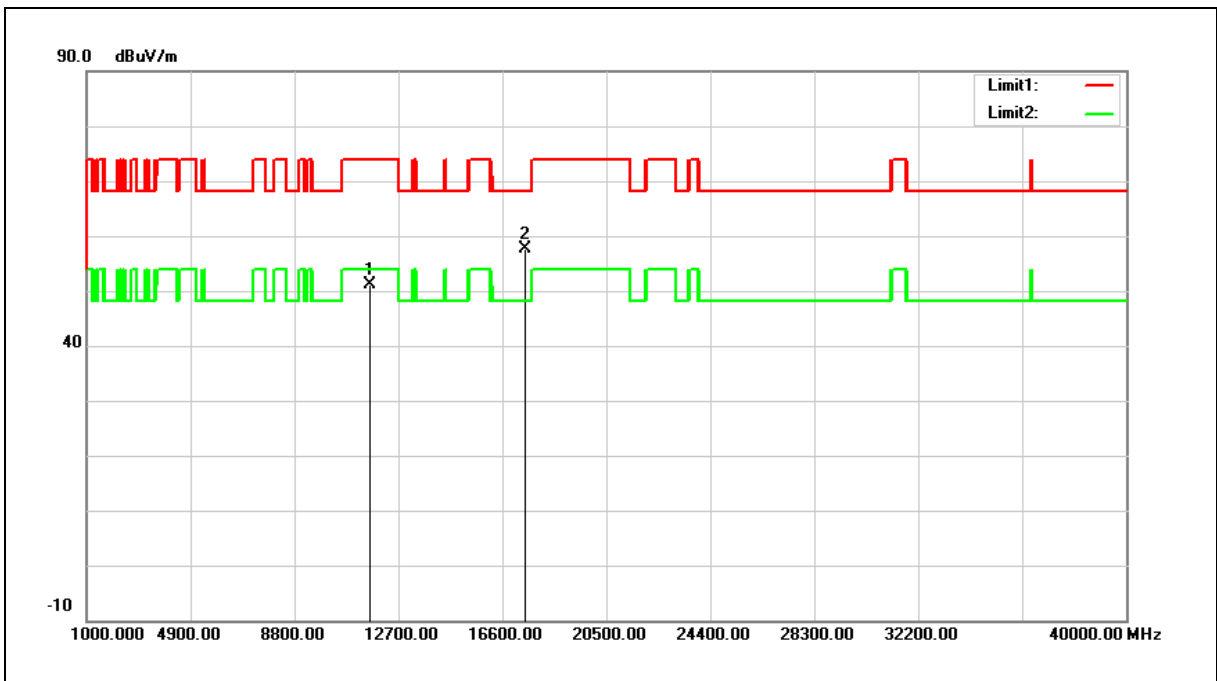

No.	Frequency (MHz)	Reading (dBuV)	Correct Factor (dB/m)	Result (dBuV/m)	Limit (dBuV/m)	Margin (dB)	Remark
1	11650.000	32.76	18.38	51.14	74.00	-22.86	peak
2	17475.000	32.33	25.26	57.59	68.20	-10.61	peak

Note:1.Result (dBuV/m) = Correct Factor (dB/m) + Reading(dBuV).

2.Correction factor (dB/m) = Antenna Factor (dB/m) + Cable loss (dB) – Pre-Amplifier gain (dB).

3. When the peak results are less than average limit, so not need to evaluate the average.



Standard:	FCC Part 15.407	Test Distance:	3 m
Test item:	Harmonic	Power:	AC 120 V/60 Hz
Frequency:	5825 MHz	Temp.(°C)/Hum.(%RH):	26(°C)/60 %RH
Mode:	Mode 2	Date:	
Ant.Polar.:	Vertical		

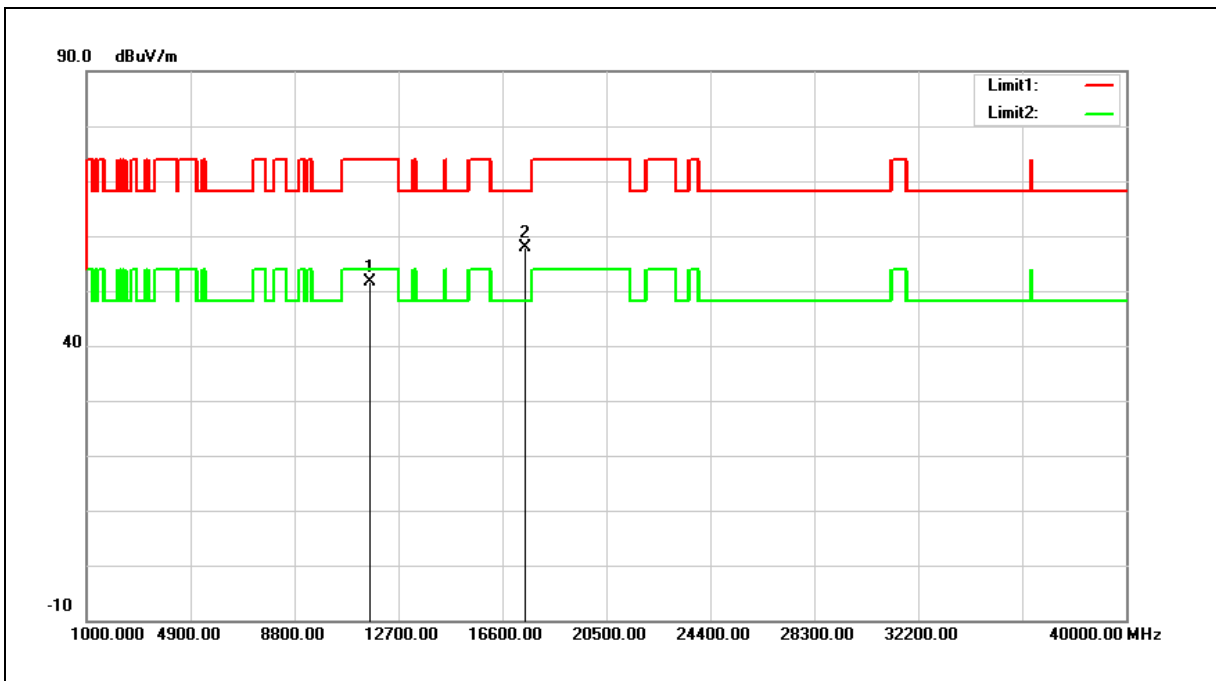

No.	Frequency (MHz)	Reading (dBuV)	Correct Factor (dB/m)	Result (dBuV/m)	Limit (dBuV/m)	Margin (dB)	Remark
1	11650.000	33.20	18.38	51.58	74.00	-22.42	peak
2	17475.000	32.64	25.26	57.90	68.20	-10.30	peak

- Note:1.Result (dBuV/m) = Correct Factor (dB/m) + Reading(dBuV).
- 2.Correction factor (dB/m) = Antenna Factor (dB/m) + Cable loss (dB) – Pre-Amplifier gain (dB).
3. When the peak results are less than average limit, so not need to evaluate the average.



Standard:	FCC Part 15.407	Test Distance:	3 m
Test item:	Harmonic	Power:	AC 120 V/60 Hz
Frequency:	5180 MHz	Temp.(°C)/Hum.(%RH):	26(°C)/60 %RH
Mode:	Mode 5	Date:	
Ant.Polar.:	Horizontal		

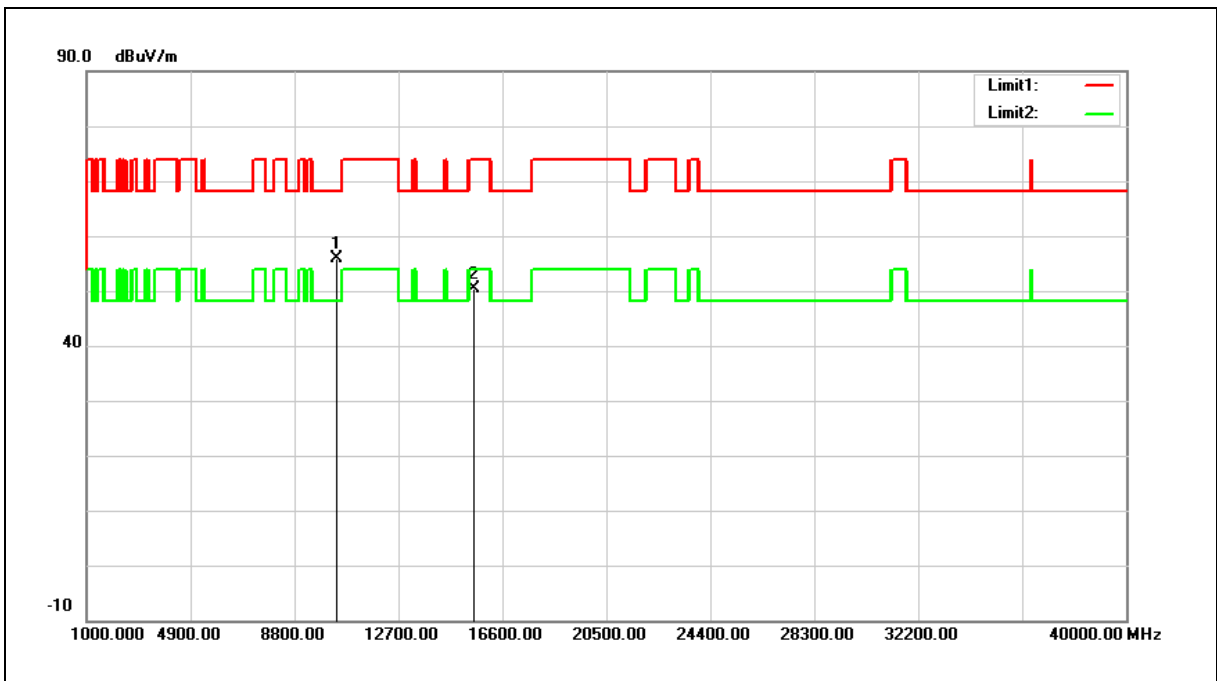

No.	Frequency (MHz)	Reading (dBuV)	Correct Factor (dB/m)	Result (dBuV/m)	Limit (dBuV/m)	Margin (dB)	Remark
1	10360.000	38.94	16.92	55.86	68.20	-12.34	peak
2	15540.000	31.22	19.18	50.40	74.00	-23.60	peak

Note:1.Result (dBuV/m) = Correct Factor (dB/m) + Reading(dBuV).

2.Correction factor (dB/m) = Antenna Factor (dB/m) + Cable loss (dB) – Pre-Amplifier gain (dB).

3. When the peak results are less than average limit, so not need to evaluate the average.



Standard:	FCC Part 15.407	Test Distance:	3 m
Test item:	Harmonic	Power:	AC 120 V/60 Hz
Frequency:	5180 MHz	Temp.(°C)/Hum.(%RH):	26(°C)/60 %RH
Mode:	Mode 5	Date:	
Ant.Polar.:	Vertical		

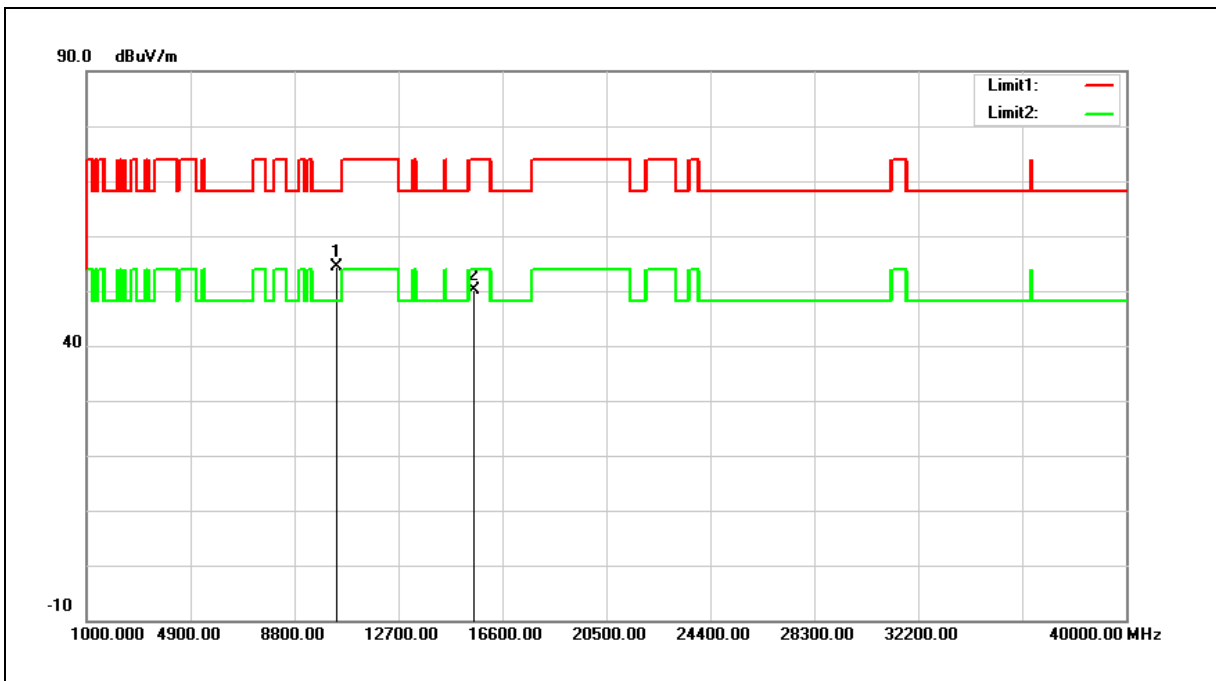

No.	Frequency (MHz)	Reading (dBuV)	Correct Factor (dB/m)	Result (dBuV/m)	Limit (dBuV/m)	Margin (dB)	Remark
1	10360.000	37.38	16.92	54.30	68.20	-13.90	peak
2	15540.000	31.07	19.18	50.25	74.00	-23.75	peak

- Note:1.Result (dBuV/m) = Correct Factor (dB/m) + Reading(dBuV).
 2.Correction factor (dB/m) = Antenna Factor (dB/m) + Cable loss (dB) – Pre-Amplifier gain (dB).
 3. When the peak results are less than average limit, so not need to evaluate the average.



Standard:	FCC Part 15.407	Test Distance:	3 m
Test item:	Harmonic	Power:	AC 120 V/60 Hz
Frequency:	5200 MHz	Temp.(°C)/Hum.(%RH):	26(°C)/60 %RH
Mode:	Mode 5	Date:	
Ant.Polar.:	Horizontal		

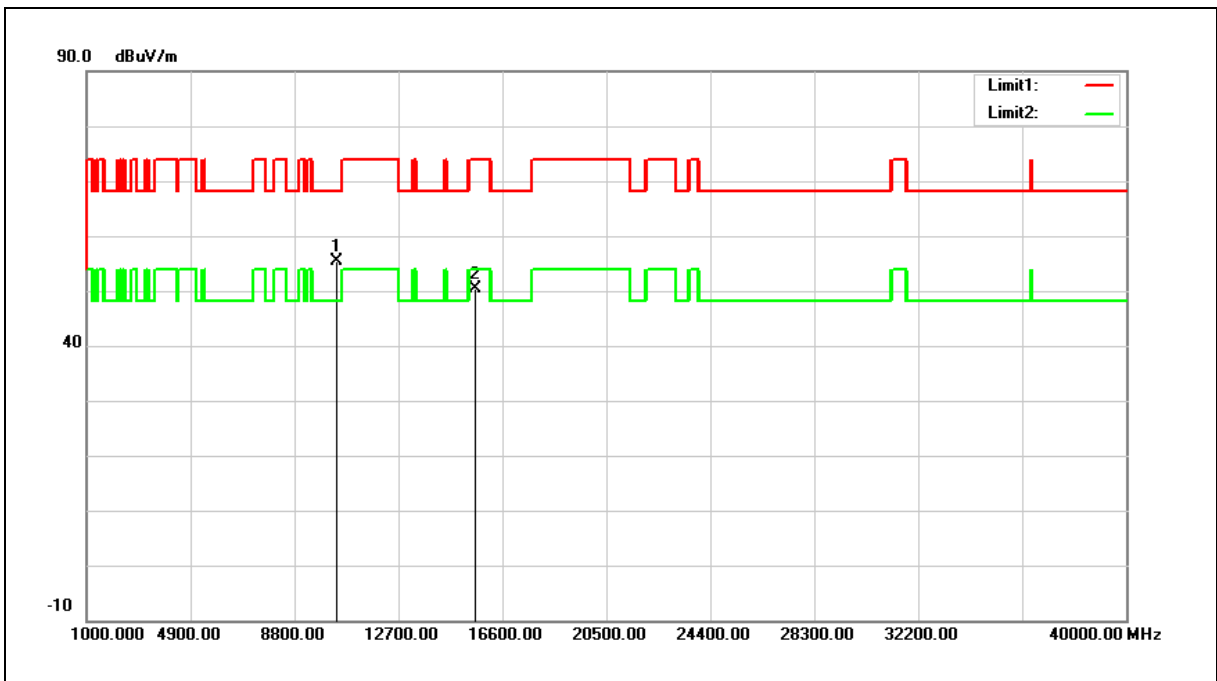

No.	Frequency (MHz)	Reading (dBuV)	Correct Factor (dB/m)	Result (dBuV/m)	Limit (dBuV/m)	Margin (dB)	Remark
1	10400.000	38.36	17.06	55.42	68.20	-12.78	peak
2	15600.000	31.44	19.02	50.46	74.00	-23.54	peak

Note:1.Result (dBuV/m) = Correct Factor (dB/m) + Reading(dBuV).

2.Correction factor (dB/m) = Antenna Factor (dB/m) + Cable loss (dB) – Pre-Amplifier gain (dB).

3. When the peak results are less than average limit, so not need to evaluate the average.



Standard:	FCC Part 15.407	Test Distance:	3 m
Test item:	Harmonic	Power:	AC 120 V/60 Hz
Frequency:	5200 MHz	Temp.(°C)/Hum.(%RH):	26(°C)/60 %RH
Mode:	Mode 5	Date:	
Ant.Polar.:	Vertical		

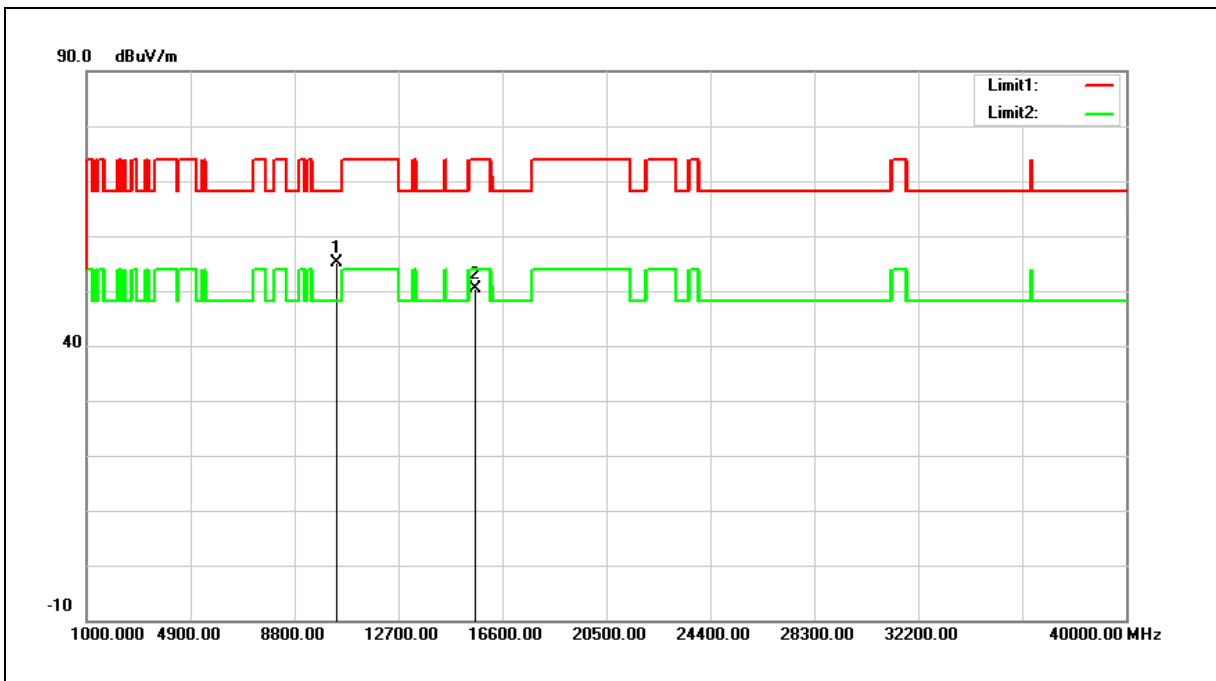

No.	Frequency (MHz)	Reading (dBuV)	Correct Factor (dB/m)	Result (dBuV/m)	Limit (dBuV/m)	Margin (dB)	Remark
1	10400.000	38.10	17.06	55.16	68.20	-13.04	peak
2	15600.000	31.28	19.02	50.30	74.00	-23.70	peak

- Note:1.Result (dBuV/m) = Correct Factor (dB/m) + Reading(dBuV).
 2.Correction factor (dB/m) = Antenna Factor (dB/m) + Cable loss (dB) – Pre-Amplifier gain (dB).
 3. When the peak results are less than average limit, so not need to evaluate the average.



Standard:	FCC Part 15.407	Test Distance:	3 m
Test item:	Harmonic	Power:	AC 120 V/60 Hz
Frequency:	5240 MHz	Temp.(°C)/Hum.(%RH):	26(°C)/60 %RH
Mode:	Mode 5	Date:	
Ant.Polar.:	Horizontal		

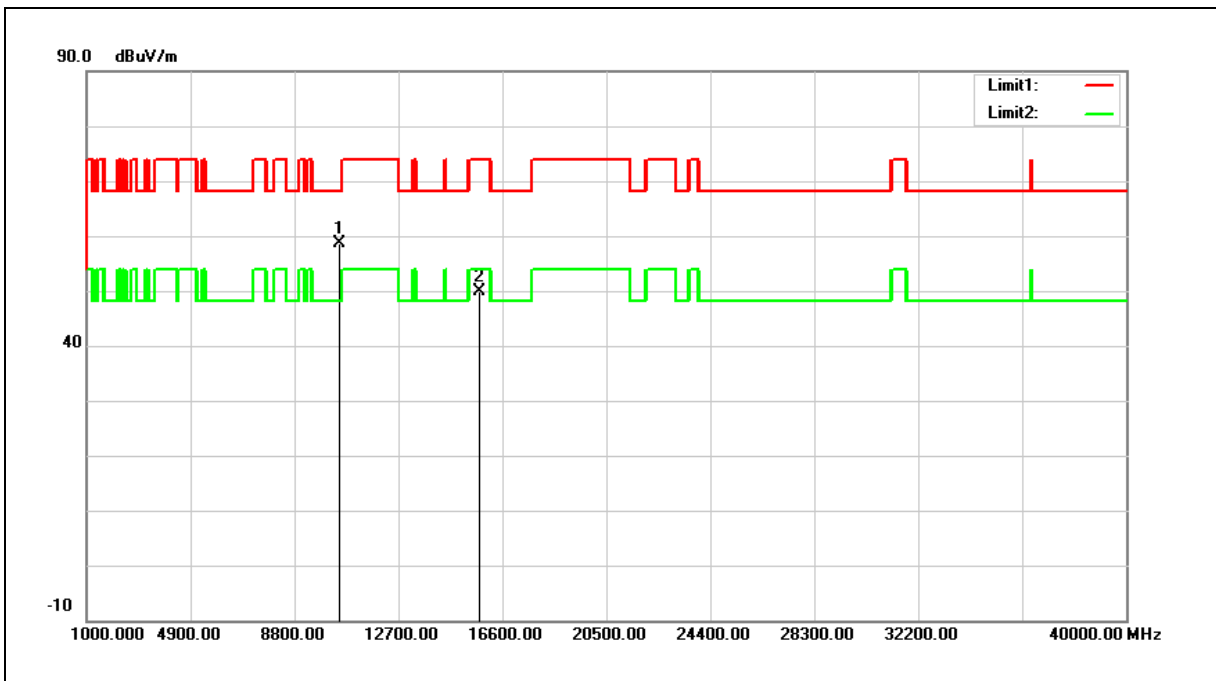

No.	Frequency (MHz)	Reading (dBuV)	Correct Factor (dB/m)	Result (dBuV/m)	Limit (dBuV/m)	Margin (dB)	Remark
1	10480.000	41.35	17.35	58.70	68.20	-9.50	peak
2	15720.000	31.26	18.71	49.97	74.00	-24.03	peak

- Note:1.Result (dBuV/m) = Correct Factor (dB/m) + Reading(dBuV).
 2.Correction factor (dB/m) = Antenna Factor (dB/m) + Cable loss (dB) – Pre-Amplifier gain (dB).
 3. When the peak results are less than average limit, so not need to evaluate the average.



Standard:	FCC Part 15.407	Test Distance:	3 m
Test item:	Harmonic	Power:	AC 120 V/60 Hz
Frequency:	5240 MHz	Temp.(°C)/Hum.(%RH):	26(°C)/60 %RH
Mode:	Mode 5	Date:	
Ant.Polar.:	Vertical		

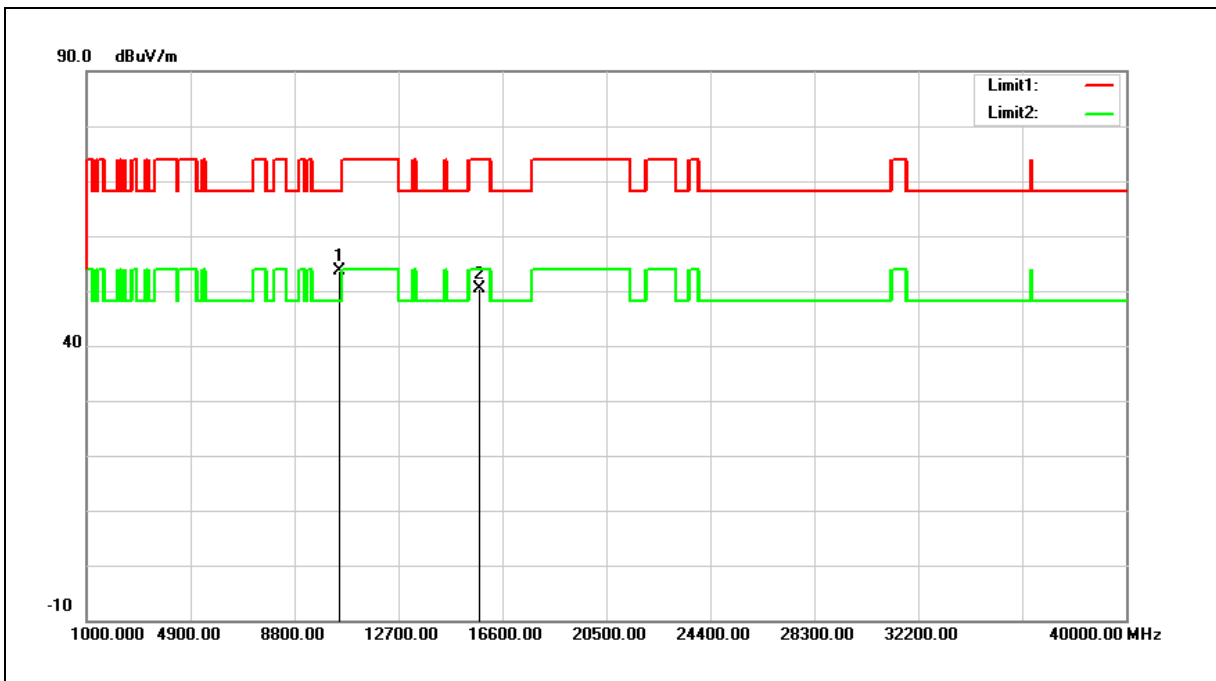

No.	Frequency (MHz)	Reading (dBuV)	Correct Factor (dB/m)	Result (dBuV/m)	Limit (dBuV/m)	Margin (dB)	Remark
1	10480.000	36.37	17.35	53.72	68.20	-14.48	peak
2	15720.000	31.64	18.71	50.35	74.00	-23.65	peak

- Note:1.Result (dBuV/m) = Correct Factor (dB/m) + Reading(dBuV).
- 2.Correction factor (dB/m) = Antenna Factor (dB/m) + Cable loss (dB) – Pre-Amplifier gain (dB).
3. When the peak results are less than average limit, so not need to evaluate the average.



Standard:	FCC Part 15.407	Test Distance:	3 m
Test item:	Harmonic	Power:	AC 120 V/60 Hz
Frequency:	5745 MHz	Temp.(°C)/Hum.(%RH):	26(°C)/60 %RH
Mode:	Mode 5	Date:	
Ant.Polar.:	Horizontal		

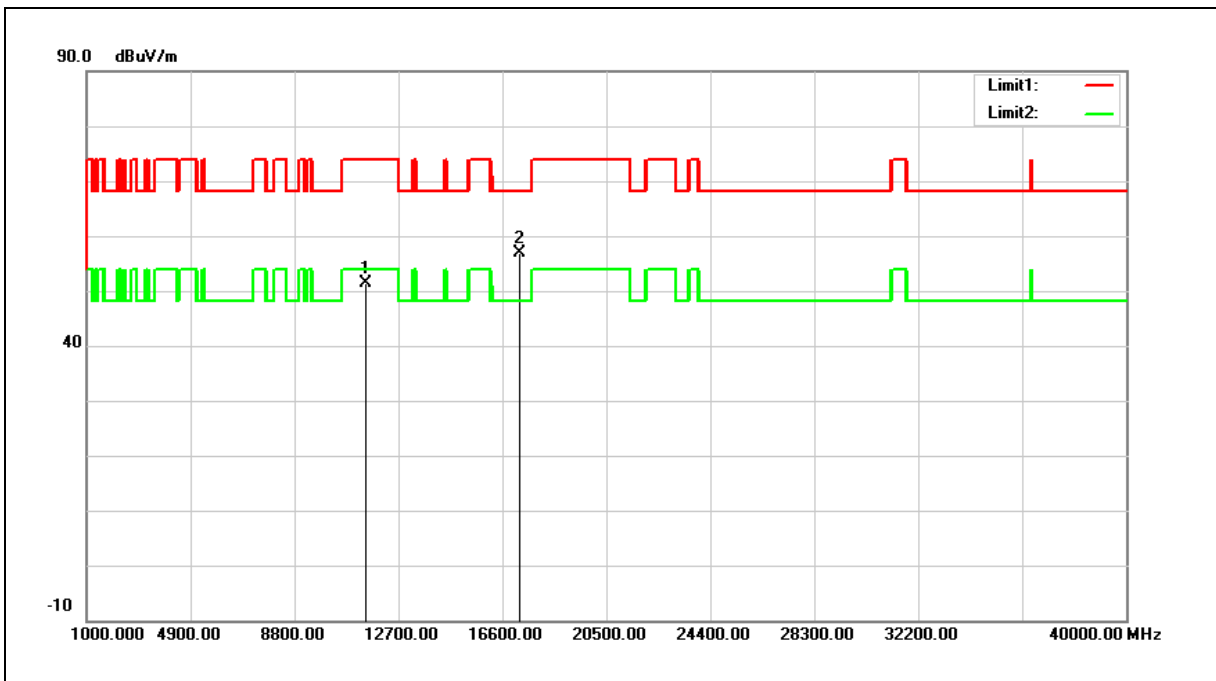

No.	Frequency (MHz)	Reading (dBuV)	Correct Factor (dB/m)	Result (dBuV/m)	Limit (dBuV/m)	Margin (dB)	Remark
1	11490.000	32.83	18.50	51.33	74.00	-22.67	peak
2	17235.000	32.63	24.31	56.94	68.20	-11.26	peak

Note:1.Result (dBuV/m) = Correct Factor (dB/m) + Reading(dBuV).

2.Correction factor (dB/m) = Antenna Factor (dB/m) + Cable loss (dB) – Pre-Amplifier gain (dB).

3. When the peak results are less than average limit, so not need to evaluate the average.



Standard:	FCC Part 15.407	Test Distance:	3 m
Test item:	Harmonic	Power:	AC 120 V/60 Hz
Frequency:	5745 MHz	Temp.(°C)/Hum.(%RH):	26(°C)/60 %RH
Mode:	Mode 5	Date:	
Ant.Polar.:	Vertical		

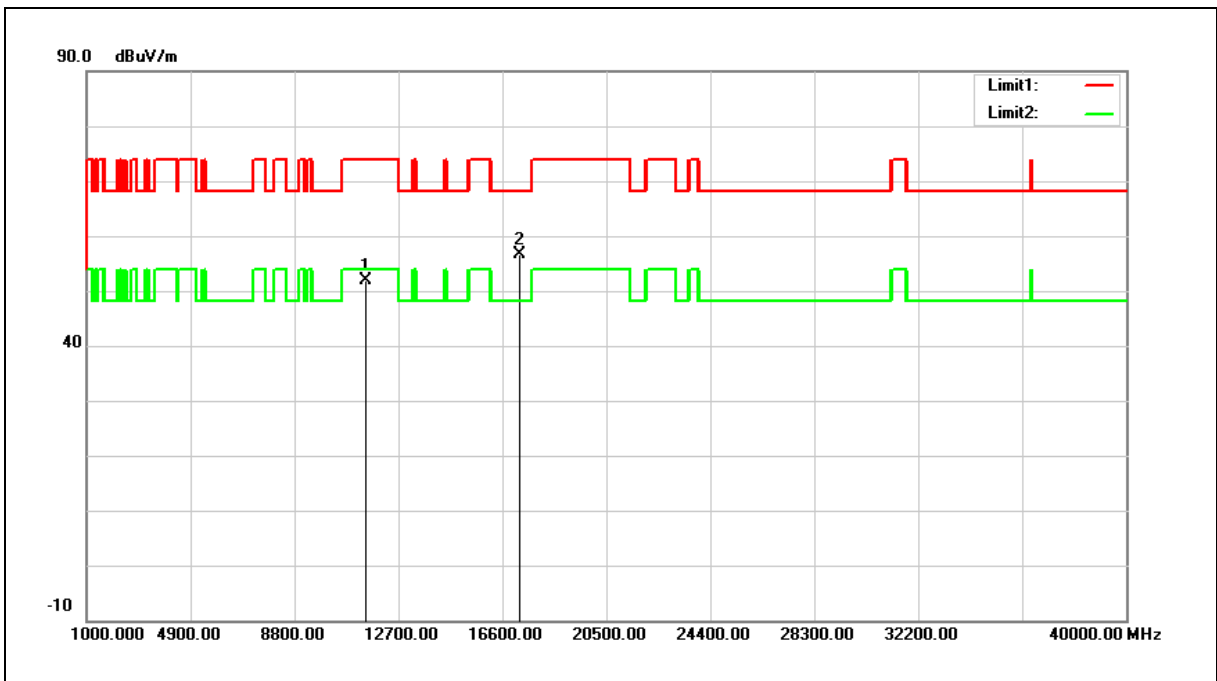

No.	Frequency (MHz)	Reading (dBuV)	Correct Factor (dB/m)	Result (dBuV/m)	Limit (dBuV/m)	Margin (dB)	Remark
1	11490.000	33.31	18.50	51.81	74.00	-22.19	peak
2	17235.000	32.42	24.31	56.73	68.20	-11.47	peak

Note:1.Result (dBuV/m) = Correct Factor (dB/m) + Reading(dBuV).

2.Correction factor (dB/m) = Antenna Factor (dB/m) + Cable loss (dB) – Pre-Amplifier gain (dB).

3. When the peak results are less than average limit, so not need to evaluate the average.



Standard:	FCC Part 15.407	Test Distance:	3 m
Test item:	Harmonic	Power:	AC 120 V/60 Hz
Frequency:	5785 MHz	Temp.(°C)/Hum.(%RH):	26(°C)/60 %RH
Mode:	Mode 5	Date:	
Ant.Polar.:	Horizontal		

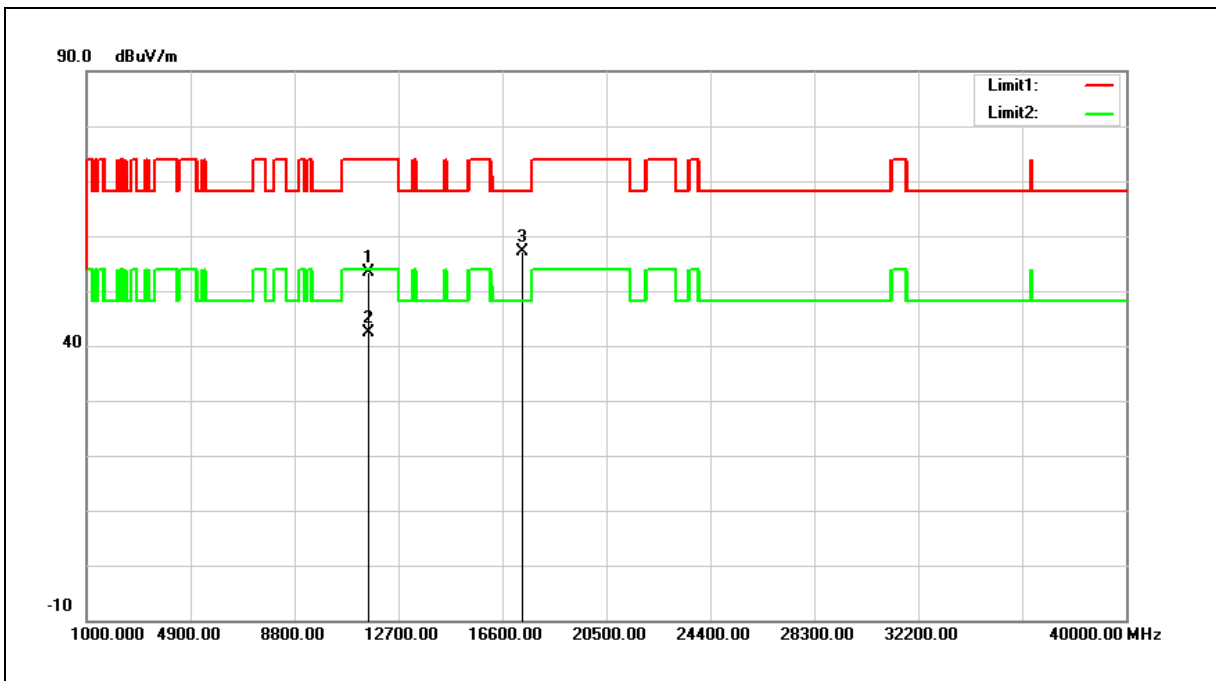

No.	Frequency (MHz)	Reading (dBuV)	Correct Factor (dB/m)	Result (dBuV/m)	Limit (dBuV/m)	Margin (dB)	Remark
1	11570.000	34.92	18.44	53.36	74.00	-20.64	peak
2	11570.000	23.87	18.44	42.31	54.00	-11.69	AVG
3	17355.000	32.42	24.79	57.21	68.20	-10.99	peak

Note:1.Result (dBuV/m) = Correct Factor (dB/m) + Reading(dBuV).

2.Correction factor (dB/m) = Antenna Factor (dB/m) + Cable loss (dB) – Pre-Amplifier gain (dB).

3. When the peak results are less than average limit, so not need to evaluate the average.



Standard:	FCC Part 15.407	Test Distance:	3 m
Test item:	Harmonic	Power:	AC 120 V/60 Hz
Frequency:	5785 MHz	Temp.(°C)/Hum.(%RH):	26(°C)/60 %RH
Mode:	Mode 5	Date:	
Ant.Polar.:	Vertical		

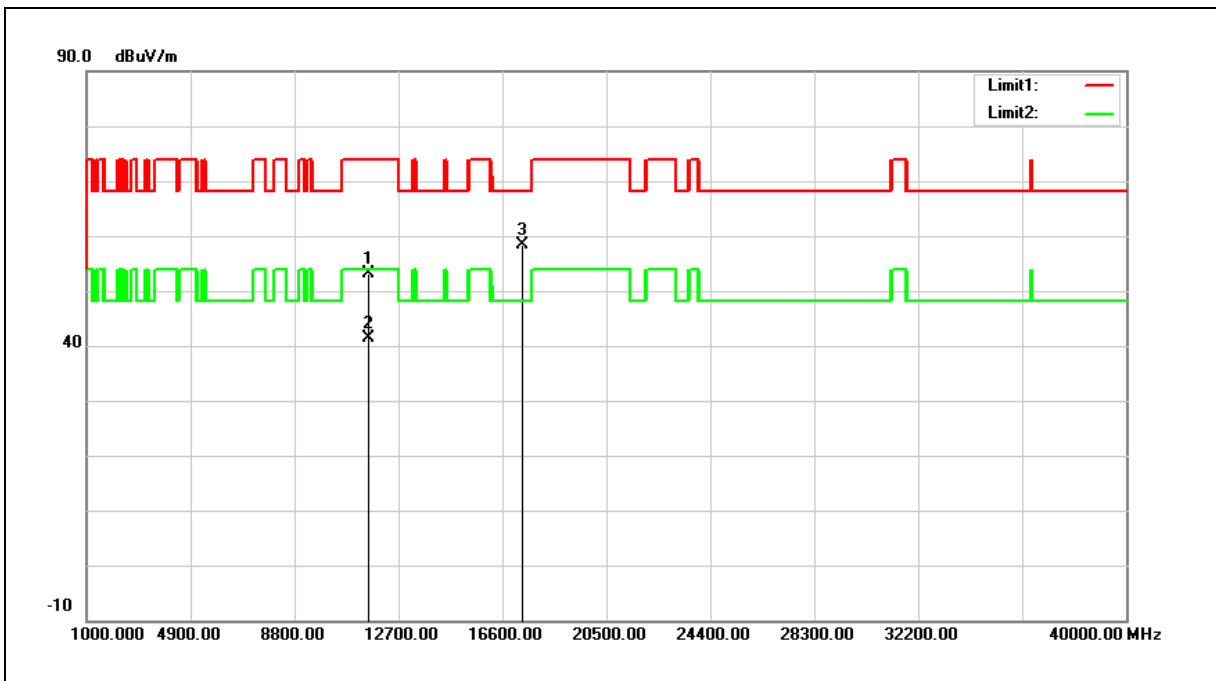

No.	Frequency (MHz)	Reading (dBuV)	Correct Factor (dB/m)	Result (dBuV/m)	Limit (dBuV/m)	Margin (dB)	Remark
1	11570.000	34.67	18.44	53.11	74.00	-20.89	peak
2	11570.000	22.83	18.44	41.27	54.00	-12.73	AVG
3	17355.000	33.51	24.79	58.30	68.20	-9.90	peak

Note:1.Result (dBuV/m) = Correct Factor (dB/m) + Reading(dBuV).

2.Correction factor (dB/m) = Antenna Factor (dB/m) + Cable loss (dB) – Pre-Amplifier gain (dB).

3. When the peak results are less than average limit, so not need to evaluate the average.



Standard:	FCC Part 15.407	Test Distance:	3 m
Test item:	Harmonic	Power:	AC 120 V/60 Hz
Frequency:	5825 MHz	Temp.(°C)/Hum.(%RH):	26(°C)/60 %RH
Mode:	Mode 5	Date:	
Ant.Polar.:	Horizontal		

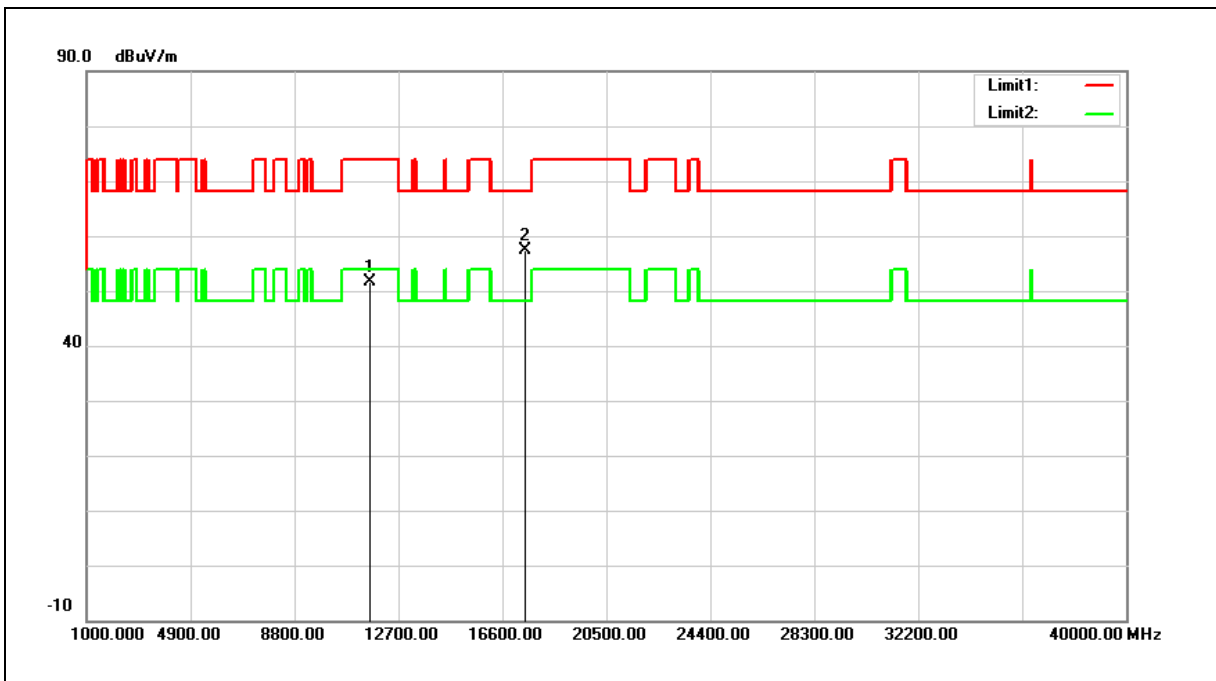

No.	Frequency (MHz)	Reading (dBuV)	Correct Factor (dB/m)	Result (dBuV/m)	Limit (dBuV/m)	Margin (dB)	Remark
1	11650.000	33.27	18.38	51.65	74.00	-22.35	peak
2	17475.000	32.02	25.26	57.28	68.20	-10.92	peak

- Note:1.Result (dBuV/m) = Correct Factor (dB/m) + Reading(dBuV).
- 2.Correction factor (dB/m) = Antenna Factor (dB/m) + Cable loss (dB) – Pre-Amplifier gain (dB).
3. When the peak results are less than average limit, so not need to evaluate the average.



Standard:	FCC Part 15.407	Test Distance:	3 m
Test item:	Harmonic	Power:	AC 120 V/60 Hz
Frequency:	5825 MHz	Temp.(°C)/Hum.(%RH):	26(°C)/60 %RH
Mode:	Mode 5	Date:	
Ant.Polar.:	Vertical		

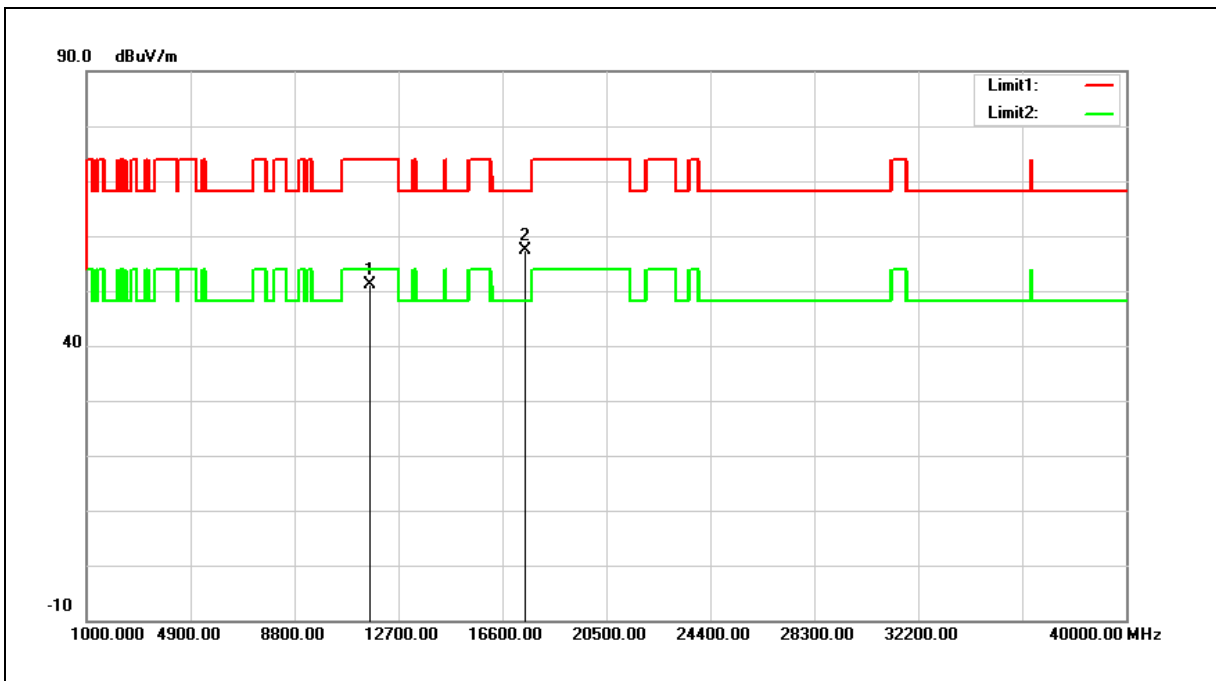

No.	Frequency (MHz)	Reading (dBuV)	Correct Factor (dB/m)	Result (dBuV/m)	Limit (dBuV/m)	Margin (dB)	Remark
1	11650.000	32.83	18.38	51.21	74.00	-22.79	peak
2	17475.000	32.13	25.26	57.39	68.20	-10.81	peak

Note:1.Result (dBuV/m) = Correct Factor (dB/m) + Reading(dBuV).

2.Correction factor (dB/m) = Antenna Factor (dB/m) + Cable loss (dB) – Pre-Amplifier gain (dB).

3. When the peak results are less than average limit, so not need to evaluate the average.



Standard:	FCC Part 15.407	Test Distance:	3 m
Test item:	Harmonic	Power:	AC 120 V/60 Hz
Frequency:	5190 MHz	Temp.(°C)/Hum.(%RH):	26(°C)/60 %RH
Mode:	Mode 6	Date:	
Ant.Polar.:	Horizontal		

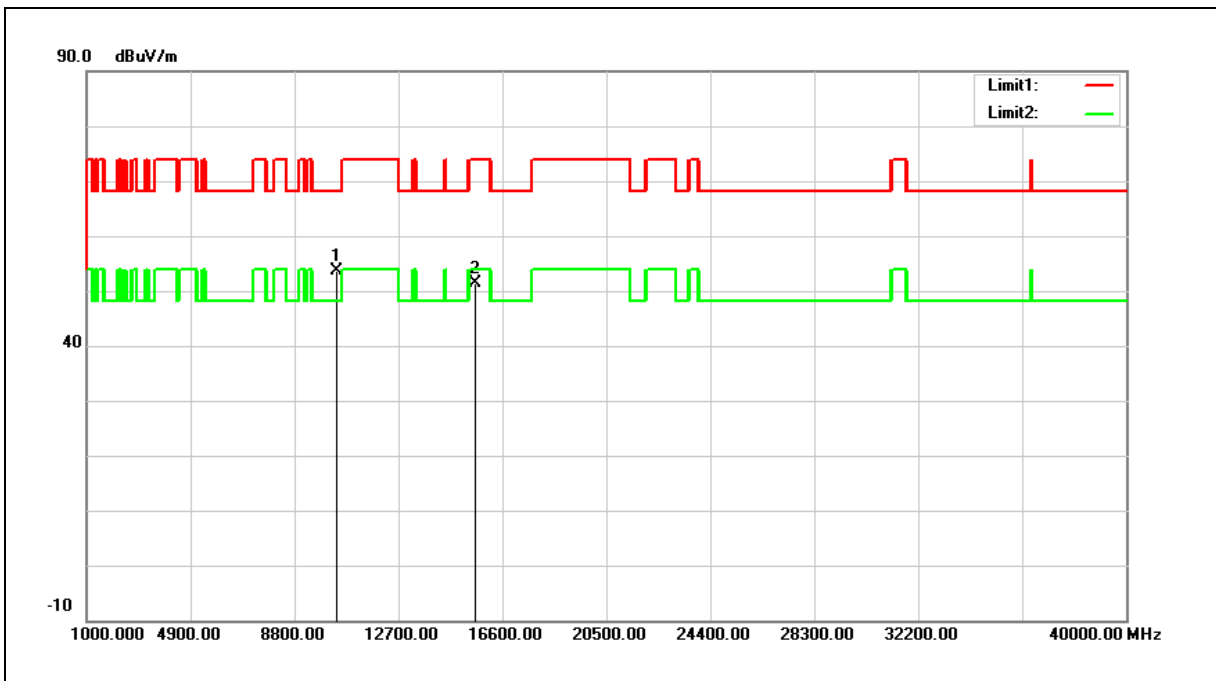

No.	Frequency (MHz)	Reading (dBuV)	Correct Factor (dB/m)	Result (dBuV/m)	Limit (dBuV/m)	Margin (dB)	Remark
1	10380.000	36.77	16.98	53.75	68.20	-14.45	peak
2	15570.000	32.22	19.11	51.33	74.00	-22.67	peak

Note:1.Result (dBuV/m) = Correct Factor (dB/m) + Reading(dBuV).

2.Correction factor (dB/m) = Antenna Factor (dB/m) + Cable loss (dB) – Pre-Amplifier gain (dB).

3. When the peak results are less than average limit, so not need to evaluate the average.



Standard:	FCC Part 15.407	Test Distance:	3 m
Test item:	Harmonic	Power:	AC 120 V/60 Hz
Frequency:	5190 MHz	Temp.(°C)/Hum.(%RH):	26(°C)/60 %RH
Mode:	Mode 6	Date:	
Ant.Polar.:	Vertical		

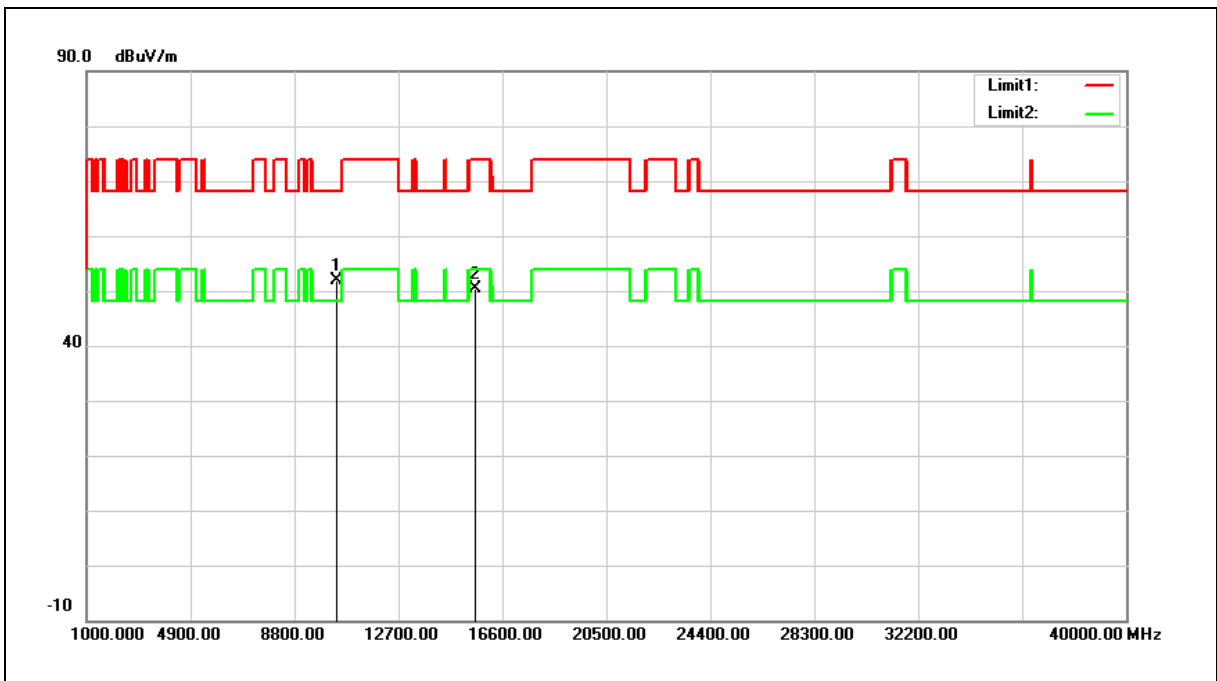

No.	Frequency (MHz)	Reading (dBuV)	Correct Factor (dB/m)	Result (dBuV/m)	Limit (dBuV/m)	Margin (dB)	Remark
1	10380.000	34.83	16.98	51.81	68.20	-16.39	peak
2	15570.000	31.15	19.11	50.26	74.00	-23.74	peak

Note:1.Result (dBuV/m) = Correct Factor (dB/m) + Reading(dBuV).

2.Correction factor (dB/m) = Antenna Factor (dB/m) + Cable loss (dB) – Pre-Amplifier gain (dB).

3. When the peak results are less than average limit, so not need to evaluate the average.



Standard:	FCC Part 15.407	Test Distance:	3 m
Test item:	Harmonic	Power:	AC 120 V/60 Hz
Frequency:	5230 MHz	Temp.(°C)/Hum.(%RH):	26(°C)/60 %RH
Mode:	Mode 6	Date:	
Ant.Polar.:	Horizontal		

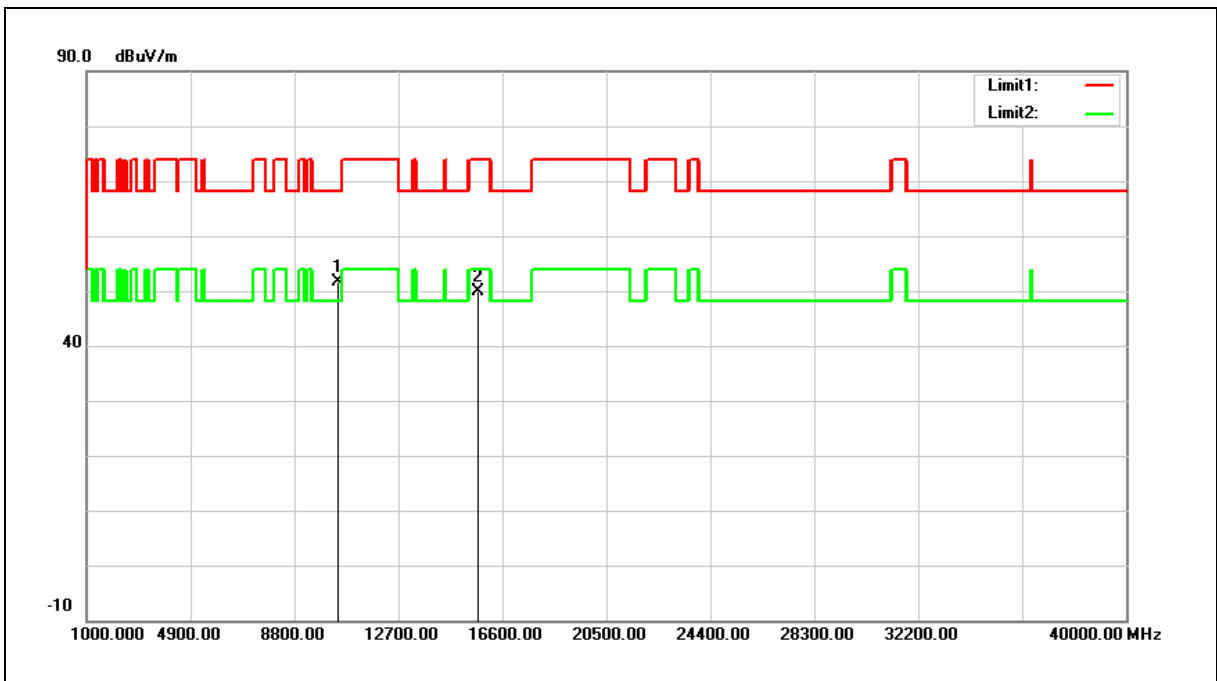

No.	Frequency (MHz)	Reading (dBuV)	Correct Factor (dB/m)	Result (dBuV/m)	Limit (dBuV/m)	Margin (dB)	Remark
1	10460.000	34.34	17.27	51.61	68.20	-16.59	peak
2	15690.000	31.13	18.78	49.91	74.00	-24.09	peak

Note:1.Result (dBuV/m) = Correct Factor (dB/m) + Reading(dBuV).

2.Correction factor (dB/m) = Antenna Factor (dB/m) + Cable loss (dB) – Pre-Amplifier gain (dB).

3. When the peak results are less than average limit, so not need to evaluate the average.



Standard:	FCC Part 15.407	Test Distance:	3 m
Test item:	Harmonic	Power:	AC 120 V/60 Hz
Frequency:	5230 MHz	Temp.(°C)/Hum.(%RH):	26(°C)/60 %RH
Mode:	Mode 6	Date:	
Ant.Polar.:	Vertical		

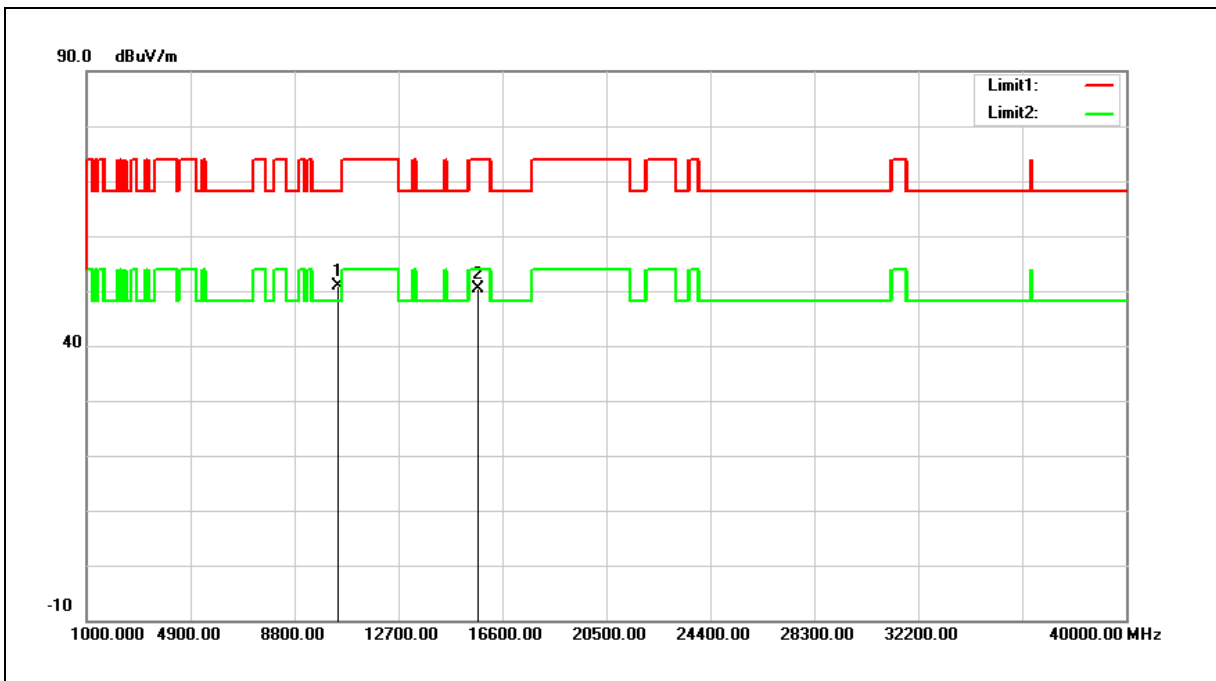

No.	Frequency (MHz)	Reading (dBuV)	Correct Factor (dB/m)	Result (dBuV/m)	Limit (dBuV/m)	Margin (dB)	Remark
1	10460.000	33.59	17.27	50.86	68.20	-17.34	peak
2	15690.000	31.49	18.78	50.27	74.00	-23.73	peak

- Note:1.Result (dBuV/m) = Correct Factor (dB/m) + Reading(dBuV).
 2.Correction factor (dB/m) = Antenna Factor (dB/m) + Cable loss (dB) – Pre-Amplifier gain (dB).
 3. When the peak results are less than average limit, so not need to evaluate the average.



Standard:	FCC Part 15.407	Test Distance:	3 m
Test item:	Harmonic	Power:	AC 120 V/60 Hz
Frequency:	5270 MHz	Temp.(°C)/Hum.(%RH):	26(°C)/60 %RH
Mode:	Mode 6	Date:	
Ant.Polar.:	Horizontal		

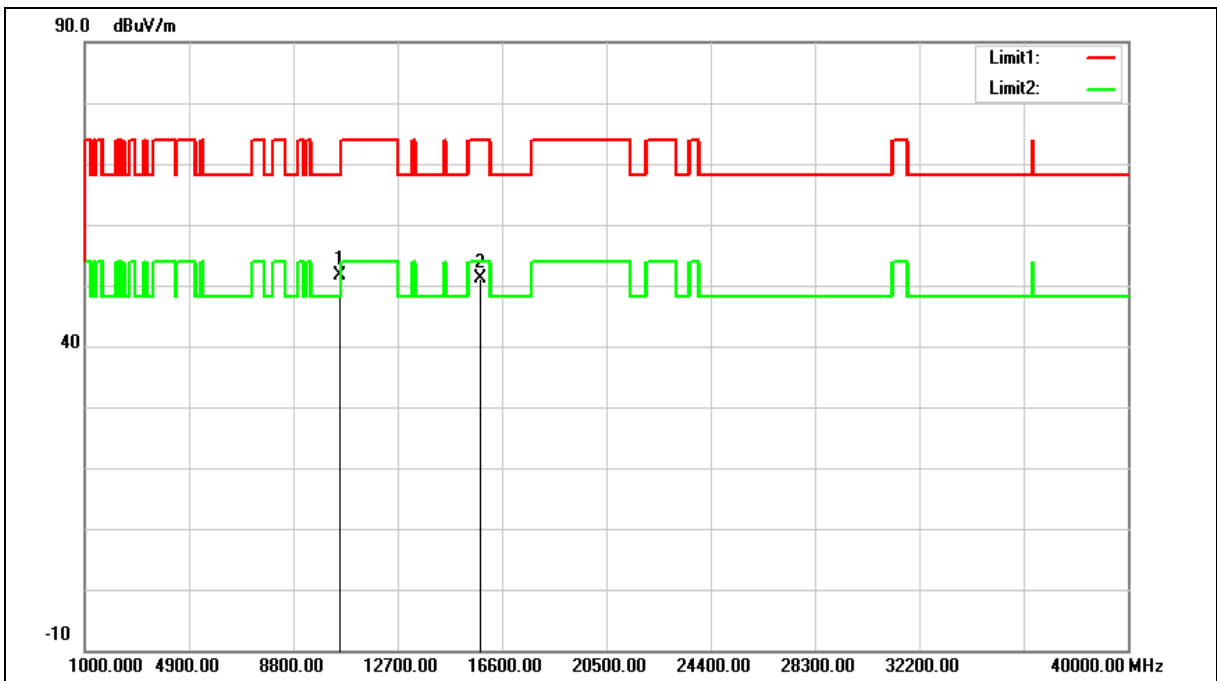

No.	Frequency (MHz)	Reading (dBuV)	Correct Factor (dB/m)	Result (dBuV/m)	Limit (dBuV/m)	Margin (dB)	Remark
1	10540.000	34.06	17.52	51.58	68.20	-16.62	peak
2	15810.000	32.62	18.47	51.09	74.00	-22.91	peak

Note:1.Result (dBuV/m) = Correct Factor (dB/m) + Reading(dBuV).

2.Correction factor (dB/m) = Antenna Factor (dB/m) + Cable loss (dB) – Pre-Amplifier gain (dB).

3. When the peak results are less than average limit, so not need to evaluate the average.



Standard:	FCC Part 15.407	Test Distance:	3 m
Test item:	Harmonic	Power:	AC 120 V/60 Hz
Frequency:	5270 MHz	Temp.(°C)/Hum.(%RH):	26(°C)/60 %RH
Mode:	Mode 6	Date:	
Ant.Polar.:	Vertical		

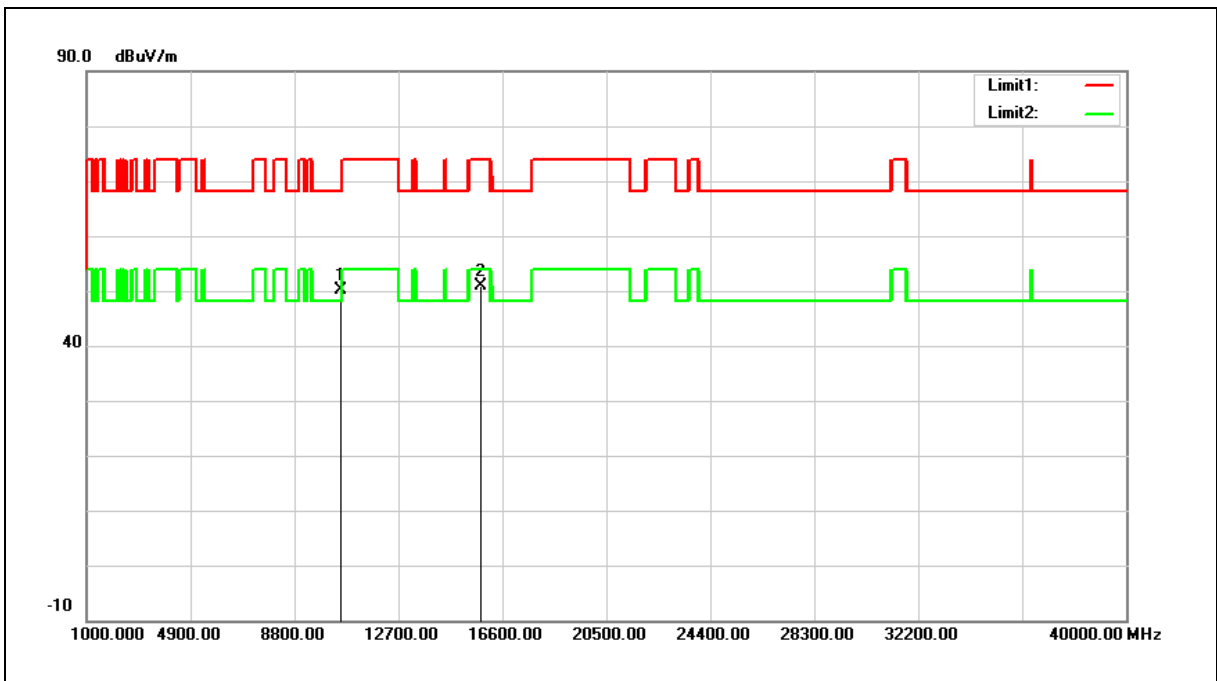

No.	Frequency (MHz)	Reading (dBuV)	Correct Factor (dB/m)	Result (dBuV/m)	Limit (dBuV/m)	Margin (dB)	Remark
1	10540.000	32.70	17.52	50.22	68.20	-17.98	peak
2	15810.000	32.36	18.47	50.83	74.00	-23.17	peak

Note:1.Result (dBuV/m) = Correct Factor (dB/m) + Reading(dBuV).

2.Correction factor (dB/m) = Antenna Factor (dB/m) + Cable loss (dB) – Pre-Amplifier gain (dB).

3. When the peak results are less than average limit, so not need to evaluate the average.



Standard:	FCC Part 15.407	Test Distance:	3 m
Test item:	Harmonic	Power:	AC 120 V/60 Hz
Frequency:	5755 MHz	Temp.(°C)/Hum.(%RH):	26(°C)/60 %RH
Mode:	Mode 6	Date:	
Ant.Polar.:	Horizontal		

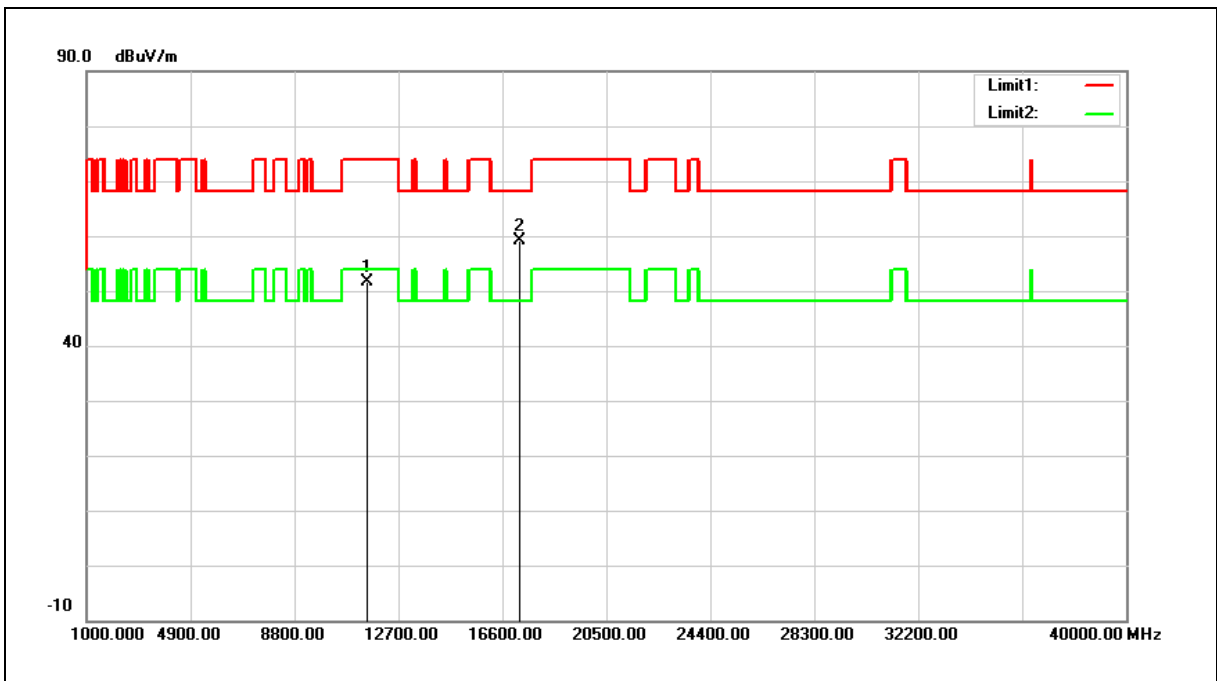

No.	Frequency (MHz)	Reading (dBuV)	Correct Factor (dB/m)	Result (dBuV/m)	Limit (dBuV/m)	Margin (dB)	Remark
1	11510.000	33.03	18.49	51.52	74.00	-22.48	peak
2	17265.000	34.61	24.44	59.05	68.20	-9.15	peak

Note:1.Result (dBuV/m) = Correct Factor (dB/m) + Reading(dBuV).

2.Correction factor (dB/m) = Antenna Factor (dB/m) + Cable loss (dB) – Pre-Amplifier gain (dB).

3. When the peak results are less than average limit, so not need to evaluate the average.



Standard:	FCC Part 15.407	Test Distance:	3 m
Test item:	Harmonic	Power:	AC 120 V/60 Hz
Frequency:	5755 MHz	Temp.(°C)/Hum.(%RH):	26(°C)/60 %RH
Mode:	Mode 6	Date:	
Ant.Polar.:	Vertical		

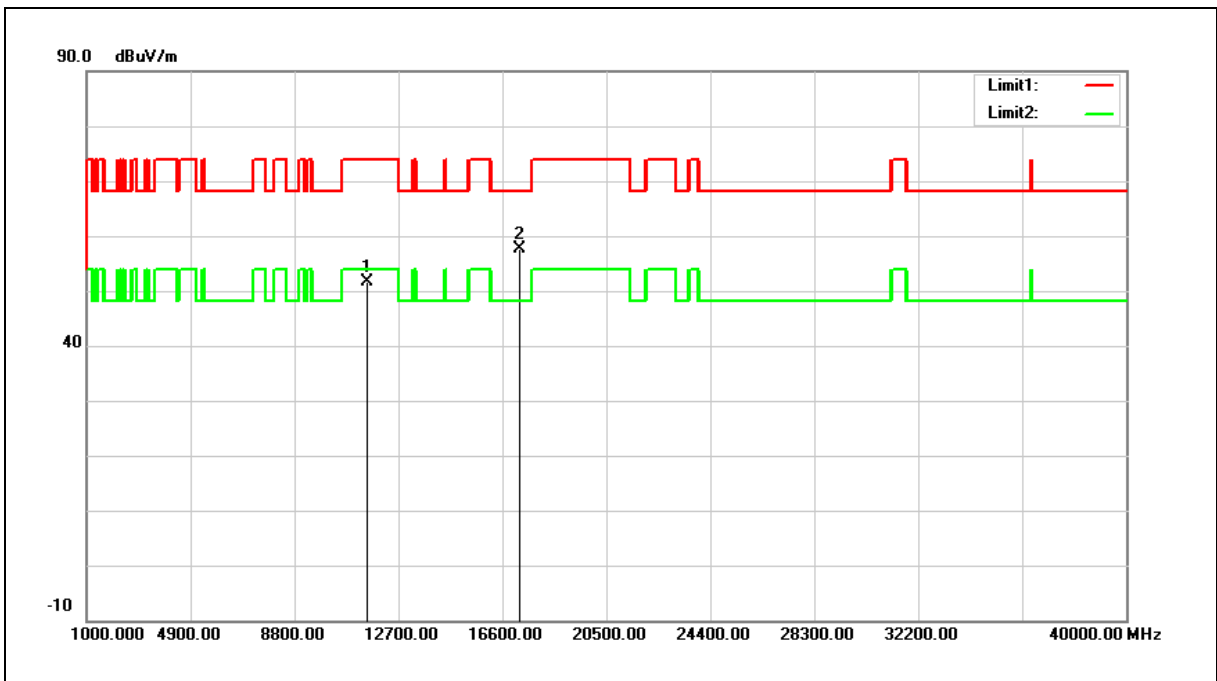

No.	Frequency (MHz)	Reading (dBuV)	Correct Factor (dB/m)	Result (dBuV/m)	Limit (dBuV/m)	Margin (dB)	Remark
1	11510.000	33.13	18.49	51.62	74.00	-22.38	peak
2	17265.000	33.22	24.44	57.66	68.20	-10.54	peak

Note:1.Result (dBuV/m) = Correct Factor (dB/m) + Reading(dBuV).

2.Correction factor (dB/m) = Antenna Factor (dB/m) + Cable loss (dB) – Pre-Amplifier gain (dB).

3. When the peak results are less than average limit, so not need to evaluate the average.



Standard:	FCC Part 15.407	Test Distance:	3 m
Test item:	Harmonic	Power:	AC 120 V/60 Hz
Frequency:	5795 MHz	Temp.(°C)/Hum.(%RH):	26(°C)/60 %RH
Mode:	Mode 6	Date:	
Ant.Polar.:	Horizontal		

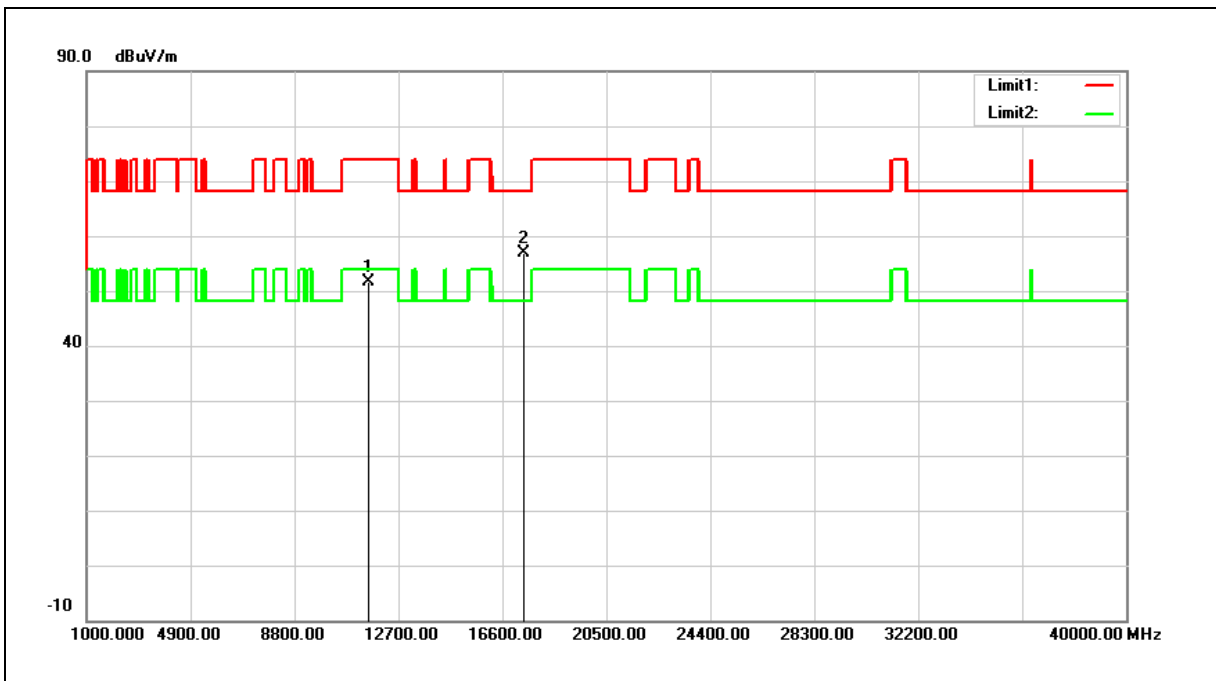

No.	Frequency (MHz)	Reading (dBuV)	Correct Factor (dB/m)	Result (dBuV/m)	Limit (dBuV/m)	Margin (dB)	Remark
1	11590.000	33.16	18.43	51.59	74.00	-22.41	peak
2	17385.000	32.01	24.90	56.91	68.20	-11.29	peak

Note:1.Result (dBuV/m) = Correct Factor (dB/m) + Reading(dBuV).

2.Correction factor (dB/m) = Antenna Factor (dB/m) + Cable loss (dB) – Pre-Amplifier gain (dB).

3. When the peak results are less than average limit, so not need to evaluate the average.



Standard:	FCC Part 15.407	Test Distance:	3 m
Test item:	Harmonic	Power:	AC 120 V/60 Hz
Frequency:	5795 MHz	Temp.(°C)/Hum.(%RH):	26(°C)/60 %RH
Mode:	Mode 6	Date:	
Ant.Polar.:	Vertical		

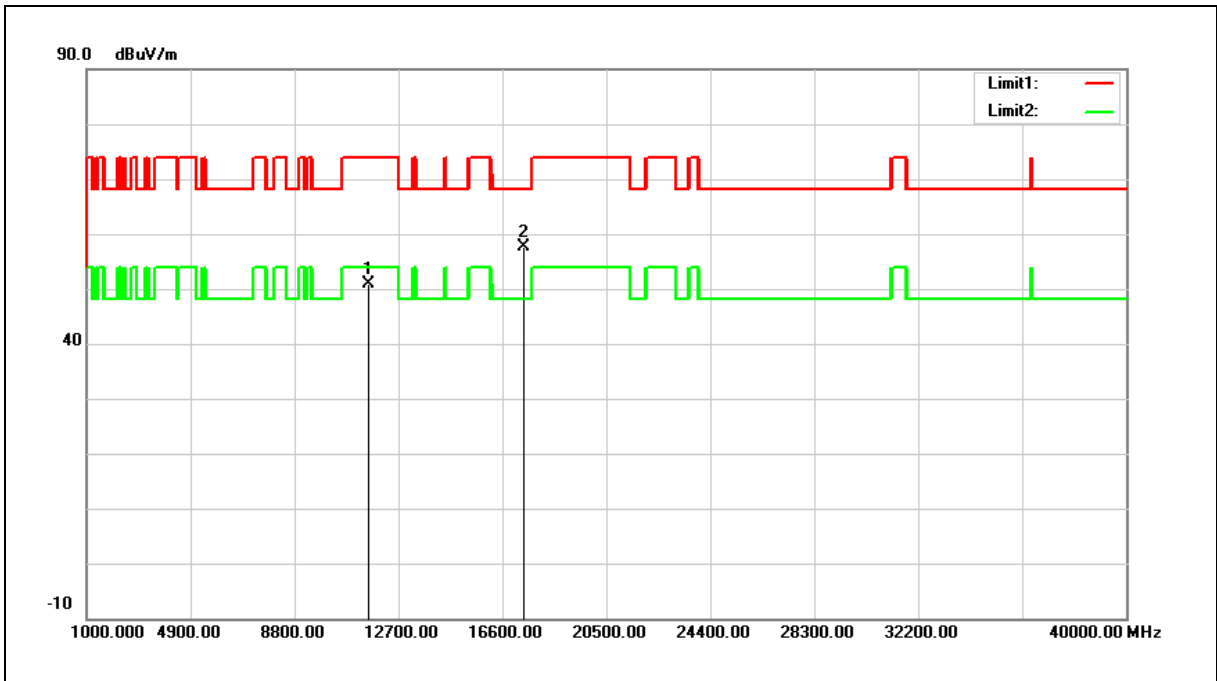

No.	Frequency (MHz)	Reading (dBuV)	Correct Factor (dB/m)	Result (dBuV/m)	Limit (dBuV/m)	Margin (dB)	Remark
1	11590.000	32.40	18.43	50.83	74.00	-23.17	peak
2	17385.000	32.68	24.90	57.58	68.20	-10.62	peak

Note:1.Result (dBuV/m) = Correct Factor (dB/m) + Reading(dBuV).

2.Correction factor (dB/m) = Antenna Factor (dB/m) + Cable loss (dB) – Pre-Amplifier gain (dB).

3. When the peak results are less than average limit, so not need to evaluate the average.



Standard:	FCC Part 15.407	Test Distance:	3 m
Test item:	Harmonic	Power:	AC 120 V/60 Hz
Frequency:	5210 MHz	Temp.(°C)/Hum.(%RH):	26(°C)/60 %RH
Mode:	Mode 7	Date:	
Ant.Polar.:	Horizontal		

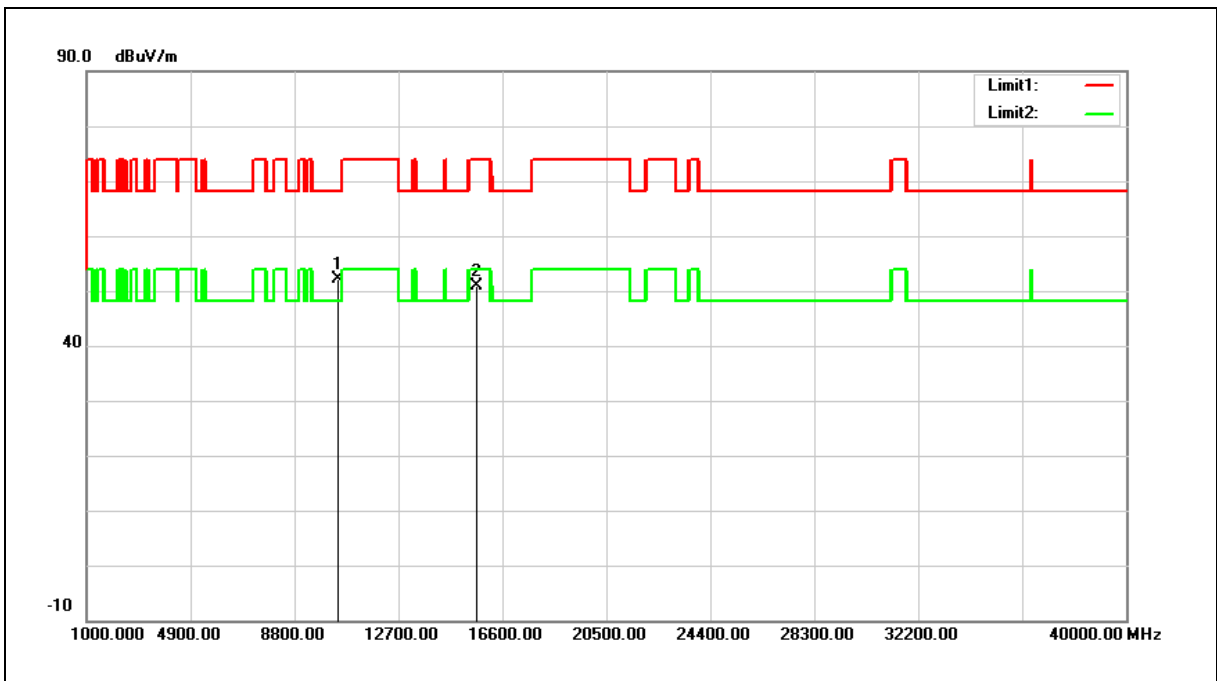

No.	Frequency (MHz)	Reading (dBuV)	Correct Factor (dB/m)	Result (dBuV/m)	Limit (dBuV/m)	Margin (dB)	Remark
1	10420.000	35.04	17.13	52.17	68.20	-16.03	peak
2	15630.000	31.89	18.94	50.83	74.00	-23.17	peak

Note:1.Result (dBuV/m) = Correct Factor (dB/m) + Reading(dBuV).

2.Correction factor (dB/m) = Antenna Factor (dB/m) + Cable loss (dB) – Pre-Amplifier gain (dB).

3. When the peak results are less than average limit, so not need to evaluate the average.



Standard:	FCC Part 15.407	Test Distance:	3 m
Test item:	Harmonic	Power:	AC 120 V/60 Hz
Frequency:	5210 MHz	Temp.(°C)/Hum.(%RH):	26(°C)/60 %RH
Mode:	Mode 7	Date:	
Ant.Polar.:	Vertical		

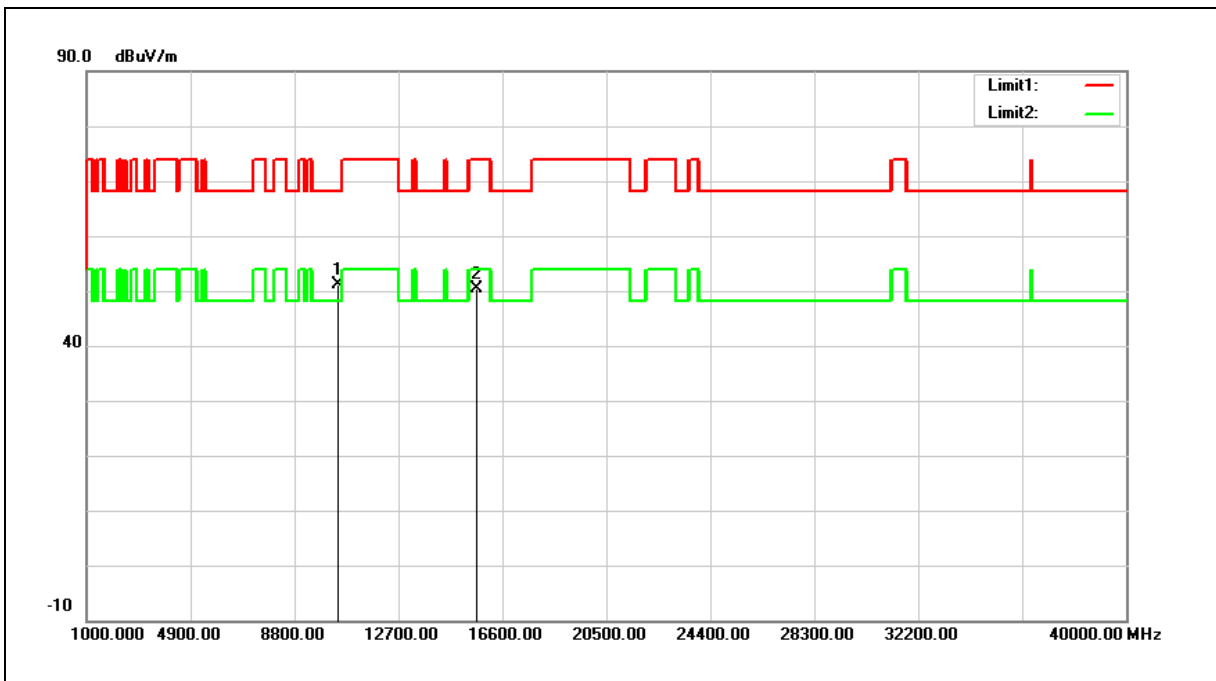

No.	Frequency (MHz)	Reading (dBuV)	Correct Factor (dB/m)	Result (dBuV/m)	Limit (dBuV/m)	Margin (dB)	Remark
1	10420.000	34.08	17.13	51.21	68.20	-16.99	peak
2	15630.000	31.48	18.94	50.42	74.00	-23.58	peak

- Note:1.Result (dBuV/m) = Correct Factor (dB/m) + Reading(dBuV).
- 2.Correction factor (dB/m) = Antenna Factor (dB/m) + Cable loss (dB) – Pre-Amplifier gain (dB).
3. When the peak results are less than average limit, so not need to evaluate the average.



Standard:	FCC Part 15.407	Test Distance:	3 m
Test item:	Harmonic	Power:	AC 120 V/60 Hz
Frequency:	5775 MHz	Temp.(°C)/Hum.(%RH):	26(°C)/60 %RH
Mode:	Mode 7	Date:	
Ant.Polar.:	Horizontal		

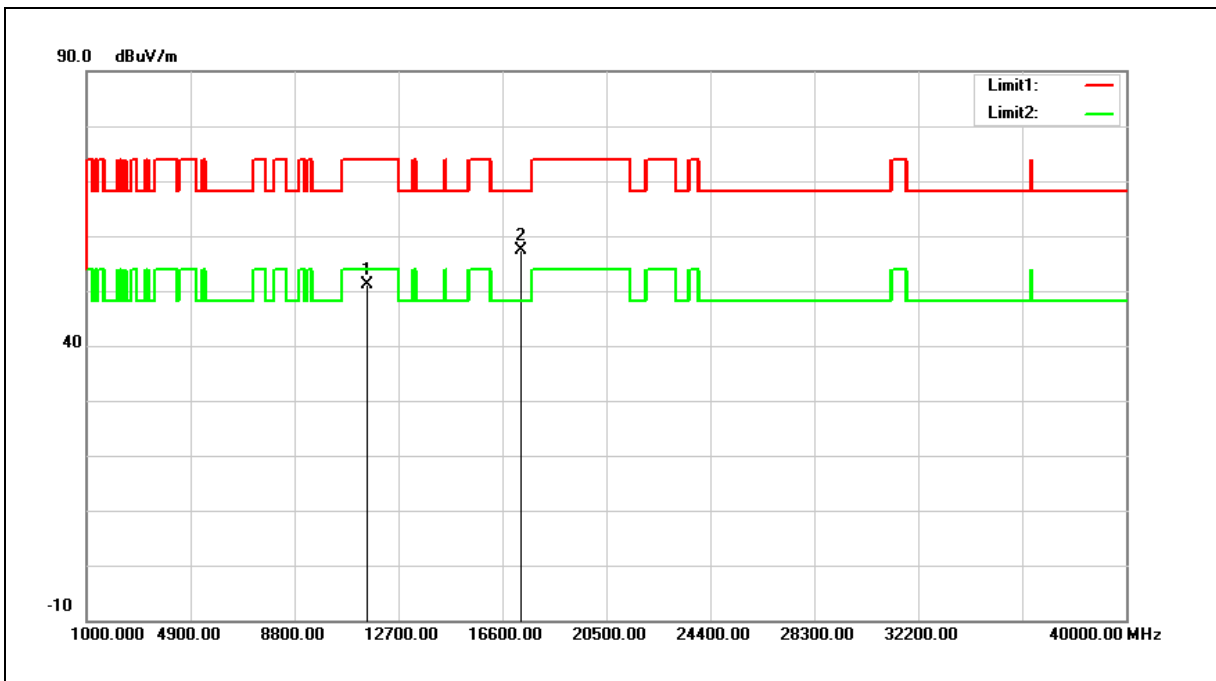

No.	Frequency (MHz)	Reading (dBuV)	Correct Factor (dB/m)	Result (dBuV/m)	Limit (dBuV/m)	Margin (dB)	Remark
1	11550.000	32.69	18.46	51.15	74.00	-22.85	peak
2	17325.000	32.68	24.68	57.36	68.20	-10.84	peak

- Note:1.Result (dBuV/m) = Correct Factor (dB/m) + Reading(dBuV).
- 2.Correction factor (dB/m) = Antenna Factor (dB/m) + Cable loss (dB) – Pre-Amplifier gain (dB).
3. When the peak results are less than average limit, so not need to evaluate the average.



Standard:	FCC Part 15.407	Test Distance:	3 m
Test item:	Harmonic	Power:	AC 120 V/60 Hz
Frequency:	5775 MHz	Temp.(°C)/Hum.(%RH):	26(°C)/60 %RH
Mode:	Mode 7	Date:	
Ant.Polar.:	Vertical		

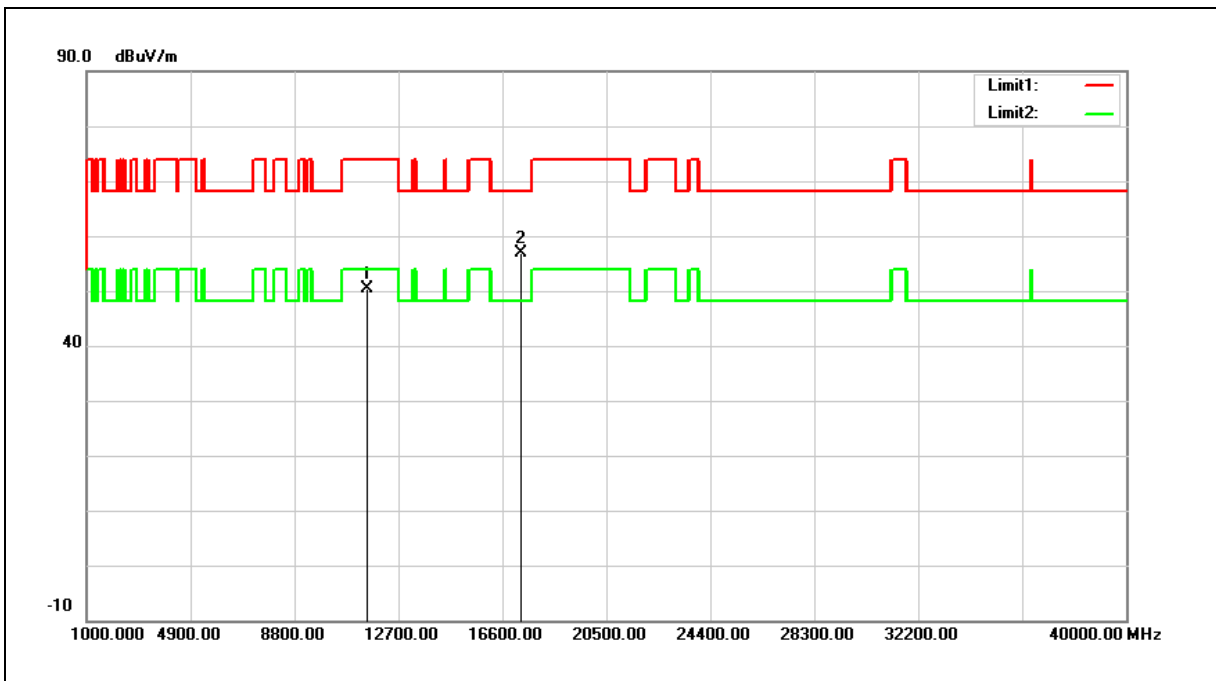

No.	Frequency (MHz)	Reading (dBuV)	Correct Factor (dB/m)	Result (dBuV/m)	Limit (dBuV/m)	Margin (dB)	Remark
1	11550.000	31.82	18.46	50.28	74.00	-23.72	peak
2	17325.000	32.12	24.68	56.80	68.20	-11.40	peak

Note:1.Result (dBuV/m) = Correct Factor (dB/m) + Reading(dBuV).

2.Correction factor (dB/m) = Antenna Factor (dB/m) + Cable loss (dB) – Pre-Amplifier gain (dB).

3. When the peak results are less than average limit, so not need to evaluate the average.



Standard:	FCC Part 15.407	Test Distance:	3 m
Test item:	Transmitter Unwanted Emissions	Power:	AC 120 V/60 Hz
Frequency:	Simultaneous Transmitting	Temp.(°C)/Hum.(%RH):	26(°C)/60 %RH
Mode:	(WLAN 2.4 GHz + 5 GHz)		
Ant.Polar.:	Horizontal		

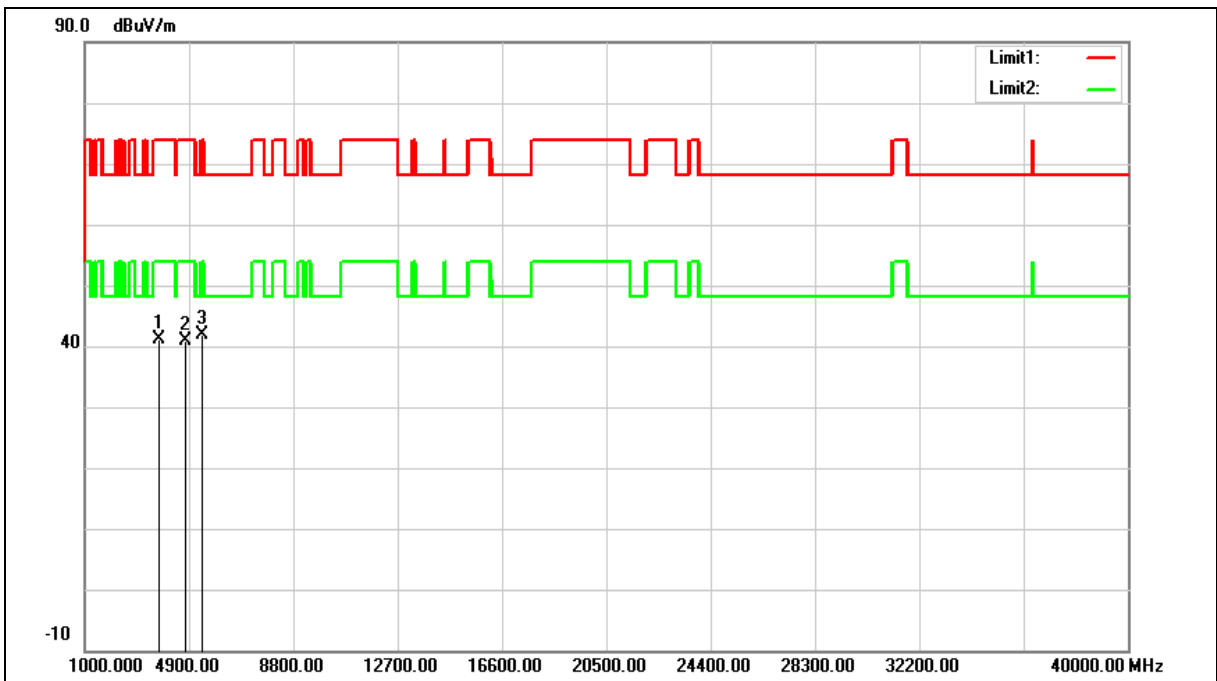

No.	Frequency (MHz)	Reading (dBuV)	Correct Factor (dB/m)	Result (dBuV/m)	Limit (dBuV/m)	Margin (dB)	Remark
1	3754.000	38.60	2.52	41.12	74.00	-32.88	peak
2	4791.000	35.48	5.51	40.99	74.00	-33.01	peak
3	5386.000	35.11	6.82	41.93	74.00	-32.07	peak

Note:1.Result (dBuV/m) = Correct Factor (dB/m) + Reading(dBuV).

2.Correction factor (dB/m) = Antenna Factor (dB/m) + Cable loss (dB) – Pre-Amplifier gain (dB).

3. When the peak results are less than average limit, so not need to evaluate the average.



Standard:	FCC Part 15.407	Test Distance:	3 m
Test item:	Transmitter Unwanted Emissions	Power:	AC 120 V/60 Hz
Frequency:	Simultaneous Transmitting	Temp.(°C)/Hum.(%RH):	26(°C)/60 %RH
Mode:	(WLAN 2.4 GHz + 5 GHz)		
Ant.Polar.:	Vertical		

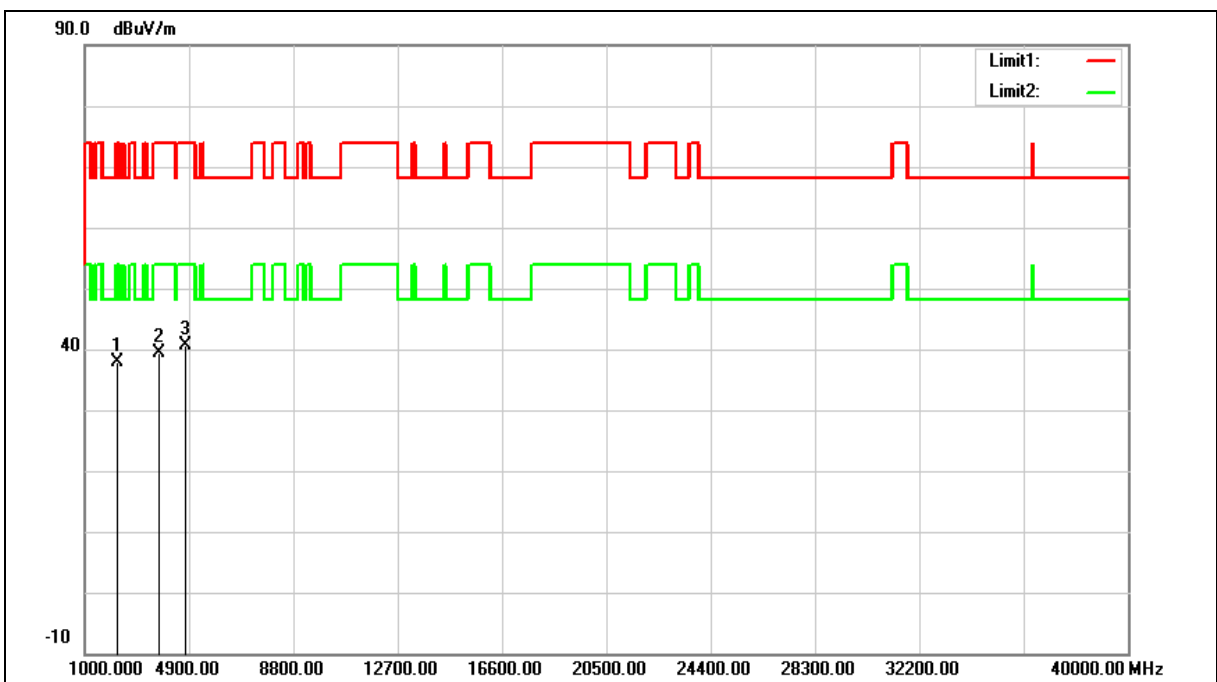

No.	Frequency (MHz)	Reading (dBuV)	Correct Factor (dB/m)	Result (dBuV/m)	Limit (dBuV/m)	Margin (dB)	Remark
1	2207.000	39.63	-1.71	37.92	74.00	-36.08	peak
2	3805.000	36.65	2.66	39.31	74.00	-34.69	peak
3	4757.000	35.11	5.44	40.55	74.00	-33.45	peak

Note:1.Result (dBuV/m) = Correct Factor (dB/m) + Reading(dBuV).

2.Correction factor (dB/m) = Antenna Factor (dB/m) + Cable loss (dB) – Pre-Amplifier gain (dB).

3. When the peak results are less than average limit, so not need to evaluate the average.

Beamforming on

Standard:	FCC Part 15.407	Test Distance:	3 m
Test item:	Harmonic	Power:	AC 120 V/60 Hz
Frequency:	5180 MHz	Temp.(°C)/Hum.(%RH):	26(°C)/60 %RH
Mode:	Mode 5		
Ant.Polar.:	Horizontal		

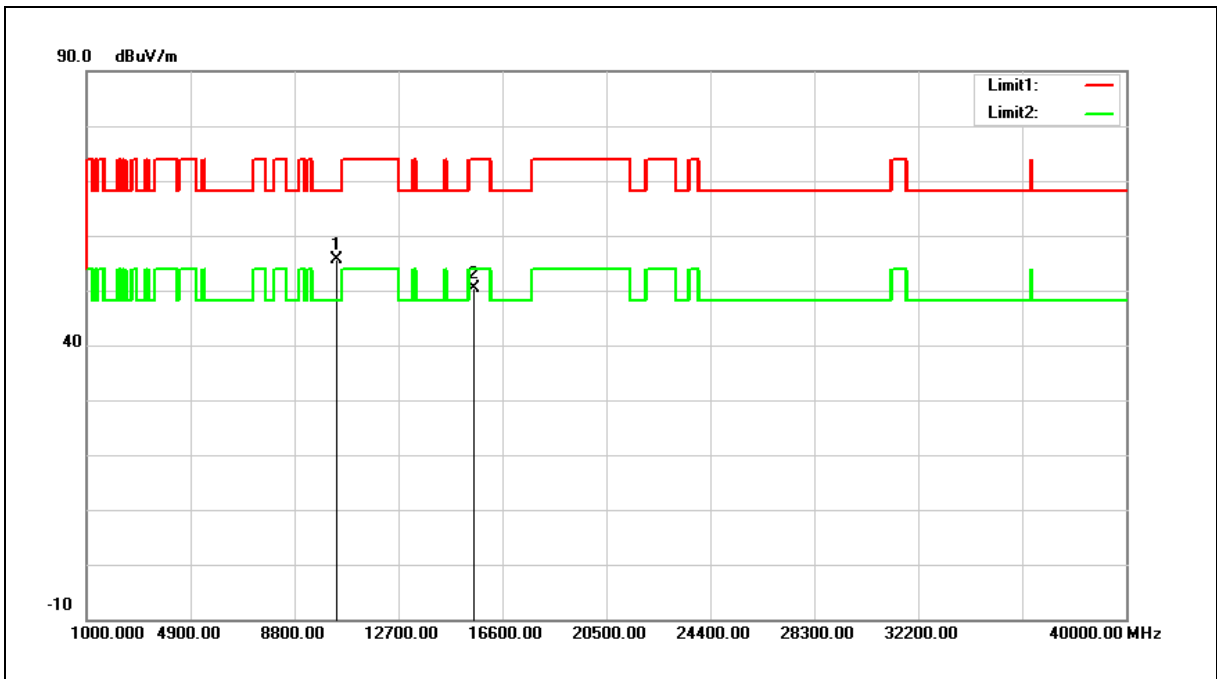

No.	Frequency (MHz)	Reading (dBuV)	Correct Factor (dB/m)	Result (dBuV/m)	Limit (dBuV/m)	Margin (dB)	Remark
1	10360.000	38.80	16.92	55.72	68.20	-12.48	peak
2	15540.000	31.24	19.18	50.42	74.00	-23.58	peak

Note:1.Result (dBuV/m) = Correct Factor (dB/m) + Reading(dBuV).

2.Correction factor (dB/m) = Antenna Factor (dB/m) + Cable loss (dB) – Pre-Amplifier gain (dB).

3. When the peak results are less than average limit, so not need to evaluate the average.



Standard:	FCC Part 15.407	Test Distance:	3 m
Test item:	Harmonic	Power:	AC 120 V/60 Hz
Frequency:	5180 MHz	Temp.(°C)/Hum.(%RH):	26(°C)/60 %RH
Mode:	Mode 5		
Ant.Polar.:	Vertical		

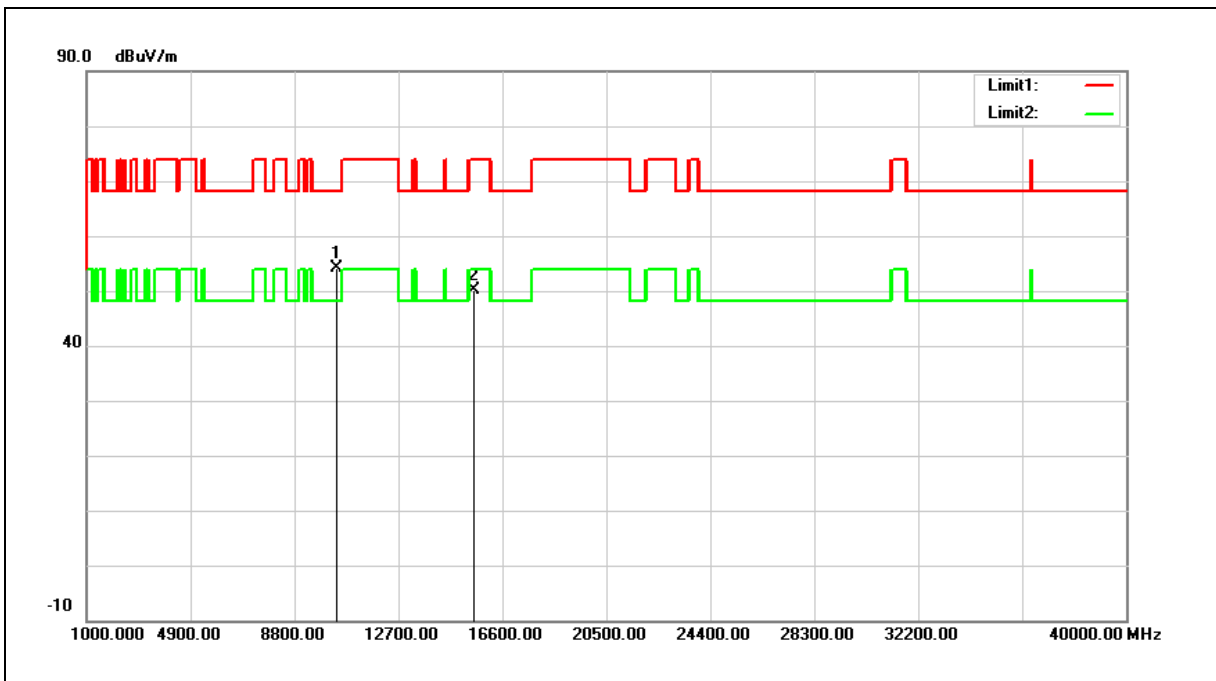

No.	Frequency (MHz)	Reading (dBuV)	Correct Factor (dB/m)	Result (dBuV/m)	Limit (dBuV/m)	Margin (dB)	Remark
1	10360.000	37.19	16.92	54.11	68.20	-14.09	peak
2	15540.000	30.91	19.18	50.09	74.00	-23.91	peak

- Note:1.Result (dBuV/m) = Correct Factor (dB/m) + Reading(dBuV).
 2.Correction factor (dB/m) = Antenna Factor (dB/m) + Cable loss (dB) – Pre-Amplifier gain (dB).
 3. When the peak results are less than average limit, so not need to evaluate the average.

Standard:	FCC Part 15.407	Test Distance:	3 m
Test item:	Harmonic	Power:	AC 120 V/60 Hz
Frequency:	5200 MHz	Temp.(°C)/Hum.(%RH):	26(°C)/60 %RH
Mode:	Mode 5		
Ant.Polar.:	Horizontal		

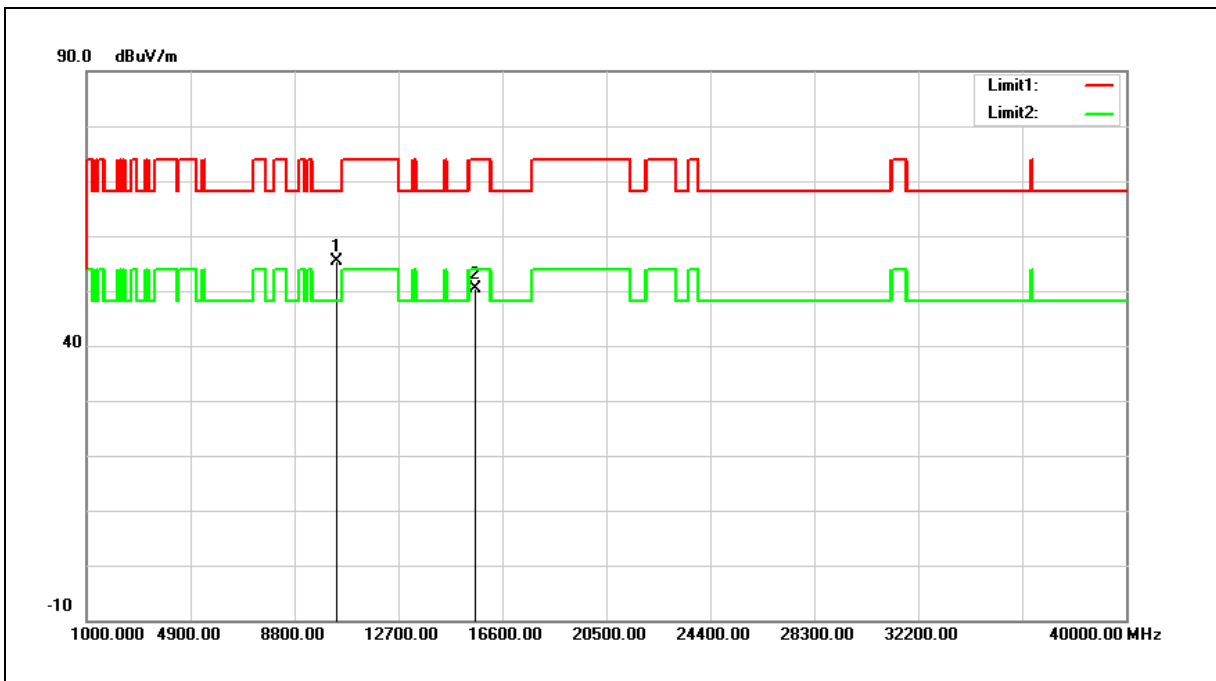

No.	Frequency (MHz)	Reading (dBuV)	Correct Factor (dB/m)	Result (dBuV/m)	Limit (dBuV/m)	Margin (dB)	Remark
1	10400.000	38.25	17.06	55.31	68.20	-12.89	peak
2	15600.000	31.38	19.02	50.40	74.00	-23.60	peak

Note:1.Result (dBuV/m) = Correct Factor (dB/m) + Reading(dBuV).

2.Correction factor (dB/m) = Antenna Factor (dB/m) + Cable loss (dB) – Pre-Amplifier gain (dB).

3. When the peak results are less than average limit, so not need to evaluate the average.



Standard:	FCC Part 15.407	Test Distance:	3 m
Test item:	Harmonic	Power:	AC 120 V/60 Hz
Frequency:	5200 MHz	Temp.(°C)/Hum.(%RH):	26(°C)/60 %RH
Mode:	Mode 5		
Ant.Polar.:	Vertical		

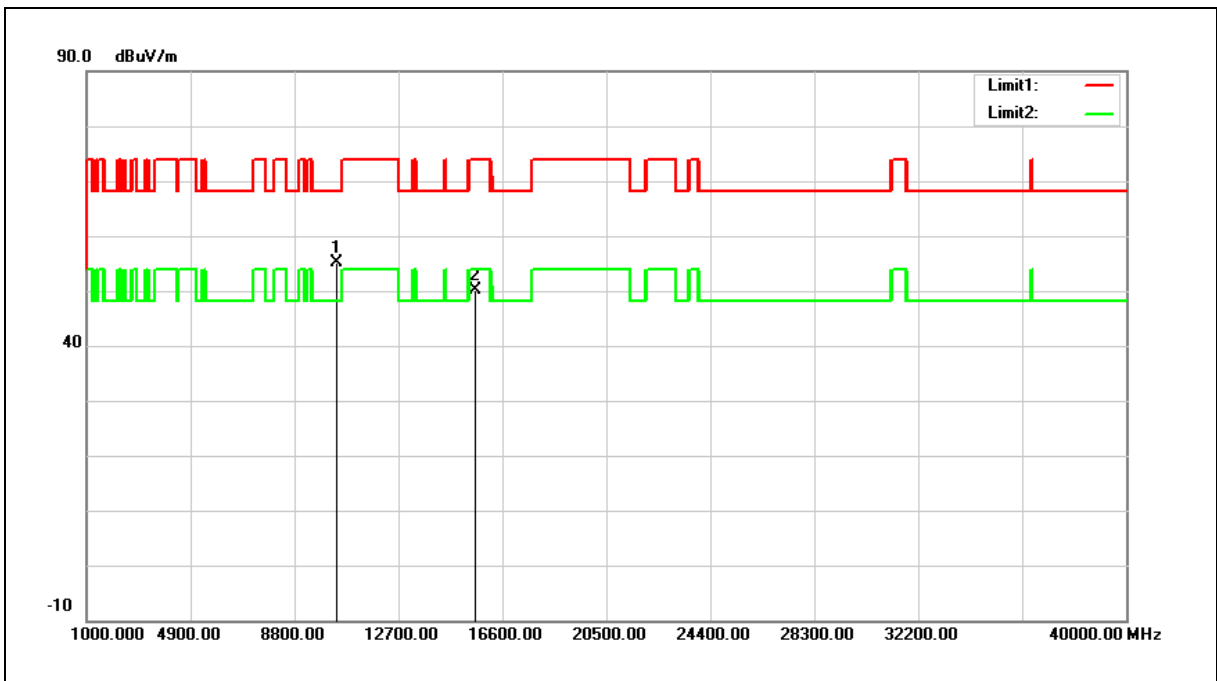

No.	Frequency (MHz)	Reading (dBuV)	Correct Factor (dB/m)	Result (dBuV/m)	Limit (dBuV/m)	Margin (dB)	Remark
1	10400.000	38.14	17.06	55.20	68.20	-13.00	peak
2	15600.000	31.17	19.02	50.19	74.00	-23.81	peak

Note:1.Result (dBuV/m) = Correct Factor (dB/m) + Reading(dBuV).

2.Correction factor (dB/m) = Antenna Factor (dB/m) + Cable loss (dB) – Pre-Amplifier gain (dB).

3. When the peak results are less than average limit, so not need to evaluate the average.



Standard:	FCC Part 15.407	Test Distance:	3 m
Test item:	Harmonic	Power:	AC 120 V/60 Hz
Frequency:	5240 MHz	Temp.(°C)/Hum.(%RH):	26(°C)/60 %RH
Mode:	Mode 5		
Ant.Polar.:	Horizontal		

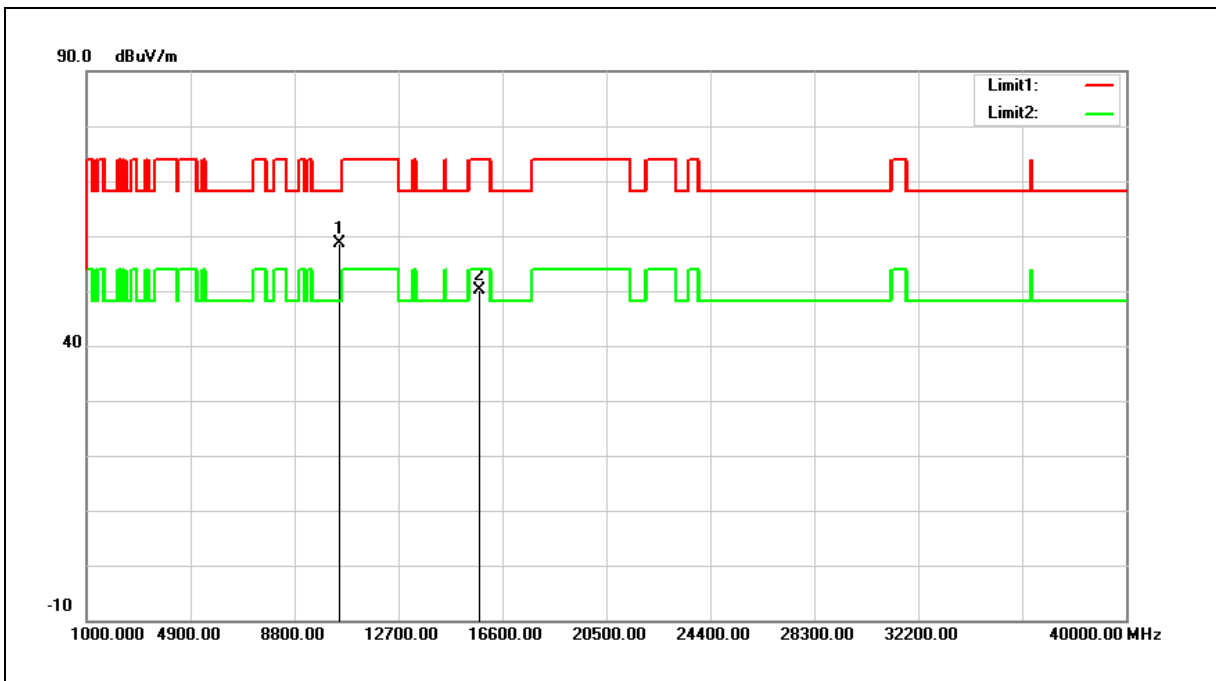

No.	Frequency (MHz)	Reading (dBuV)	Correct Factor (dB/m)	Result (dBuV/m)	Limit (dBuV/m)	Margin (dB)	Remark
1	10480.000	41.25	17.35	58.60	68.20	-9.60	peak
2	15720.000	31.36	18.71	50.07	74.00	-23.93	peak

Note:1.Result (dBuV/m) = Correct Factor (dB/m) + Reading(dBuV).

2.Correction factor (dB/m) = Antenna Factor (dB/m) + Cable loss (dB) – Pre-Amplifier gain (dB).

3. When the peak results are less than average limit, so not need to evaluate the average.



Standard:	FCC Part 15.407	Test Distance:	3 m
Test item:	Harmonic	Power:	AC 120 V/60 Hz
Frequency:	5240 MHz	Temp.(°C)/Hum.(%RH):	26(°C)/60 %RH
Mode:	Mode 5		
Ant.Polar.:	Vertical		

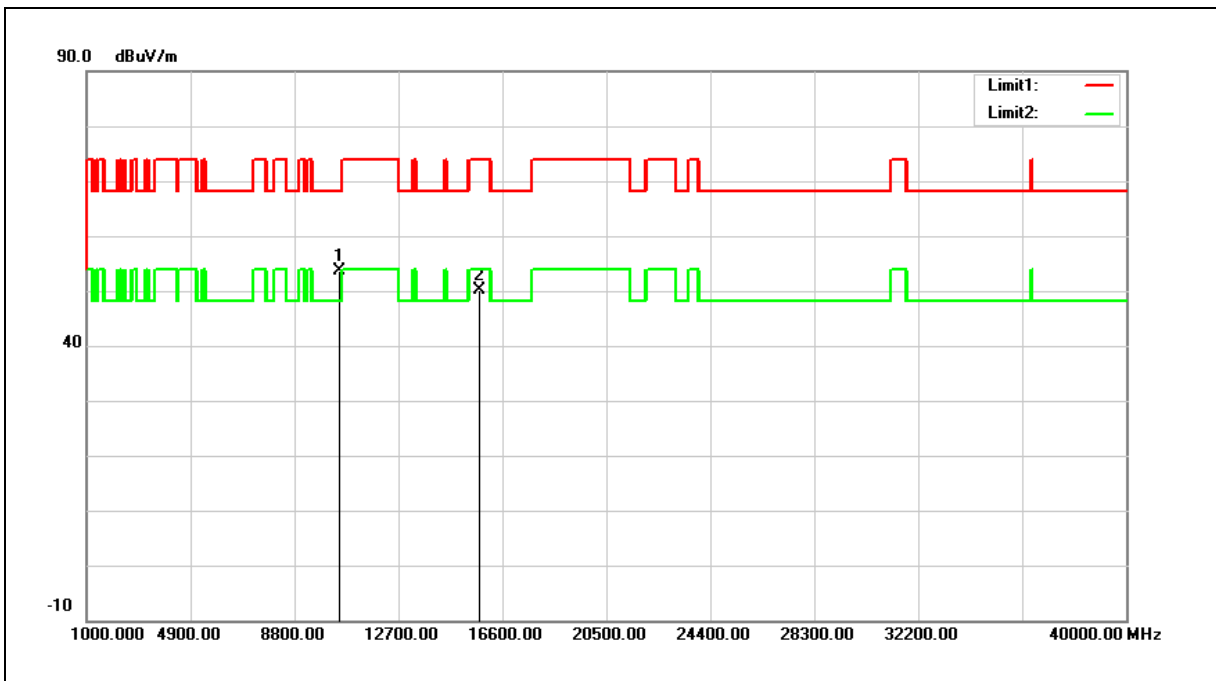

No.	Frequency (MHz)	Reading (dBuV)	Correct Factor (dB/m)	Result (dBuV/m)	Limit (dBuV/m)	Margin (dB)	Remark
1	10480.000	36.20	17.35	53.55	68.20	-14.65	peak
2	15720.000	31.52	18.71	50.23	74.00	-23.77	peak

- Note:1.Result (dBuV/m) = Correct Factor (dB/m) + Reading(dBuV).
 2.Correction factor (dB/m) = Antenna Factor (dB/m) + Cable loss (dB) – Pre-Amplifier gain (dB).
 3. When the peak results are less than average limit, so not need to evaluate the average.



Standard:	FCC Part 15.407	Test Distance:	3 m
Test item:	Harmonic	Power:	AC 120 V/60 Hz
Frequency:	5745 MHz	Temp.(°C)/Hum.(%RH):	26(°C)/60 %RH
Mode:	Mode 5		
Ant.Polar.:	Horizontal		

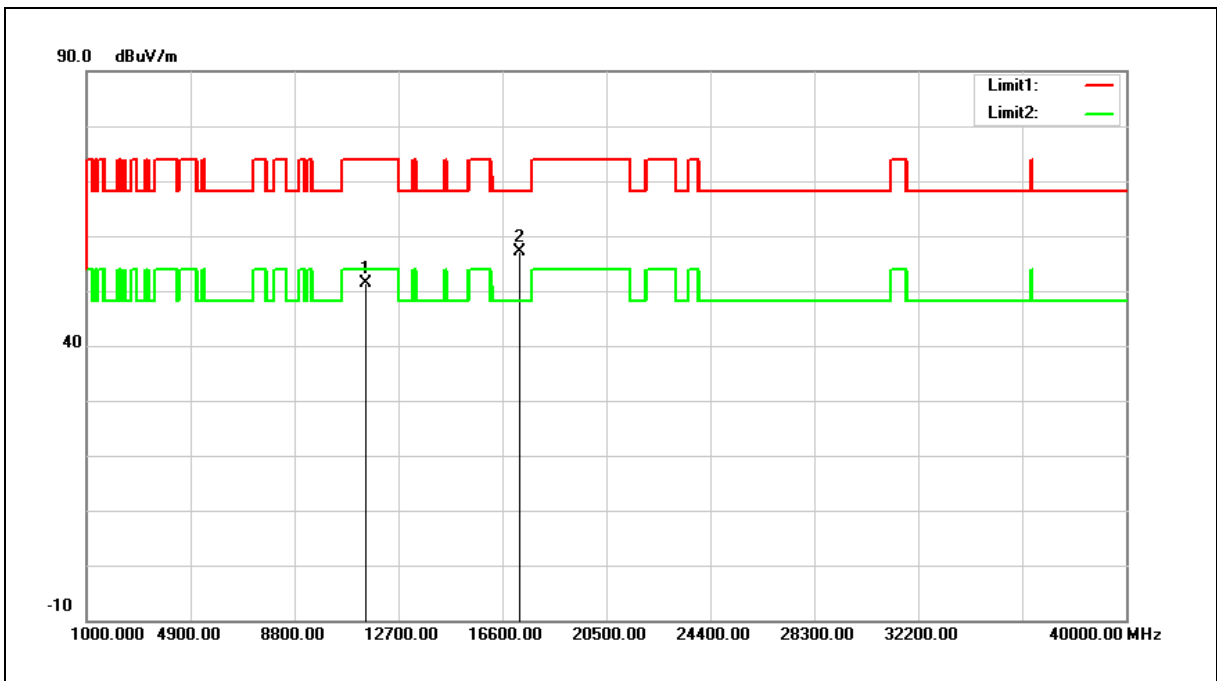

No.	Frequency (MHz)	Reading (dBuV)	Correct Factor (dB/m)	Result (dBuV/m)	Limit (dBuV/m)	Margin (dB)	Remark
1	11490.000	32.92	18.50	51.42	74.00	-22.58	peak
2	17235.000	32.73	24.31	57.04	68.20	-11.16	peak

- Note:1.Result (dBuV/m) = Correct Factor (dB/m) + Reading(dBuV).
- 2.Correction factor (dB/m) = Antenna Factor (dB/m) + Cable loss (dB) – Pre-Amplifier gain (dB).
3. When the peak results are less than average limit, so not need to evaluate the average.



Standard:	FCC Part 15.407	Test Distance:	3 m
Test item:	Harmonic	Power:	AC 120 V/60 Hz
Frequency:	5745 MHz	Temp.(°C)/Hum.(%RH):	26(°C)/60 %RH
Mode:	Mode 5		
Ant.Polar.:	Vertical		

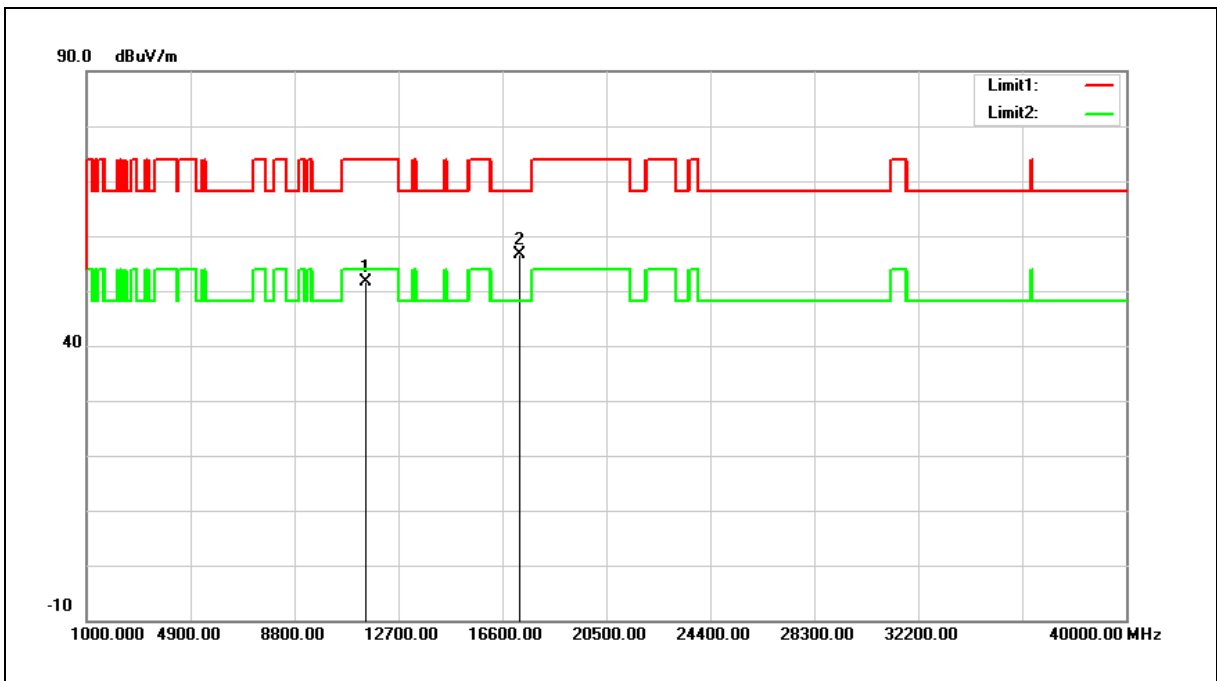

No.	Frequency (MHz)	Reading (dBuV)	Correct Factor (dB/m)	Result (dBuV/m)	Limit (dBuV/m)	Margin (dB)	Remark
1	11490.000	33.18	18.50	51.68	74.00	-22.32	peak
2	17235.000	32.35	24.31	56.66	68.20	-11.54	peak

Note:1.Result (dBuV/m) = Correct Factor (dB/m) + Reading(dBuV).

2.Correction factor (dB/m) = Antenna Factor (dB/m) + Cable loss (dB) – Pre-Amplifier gain (dB).

3. When the peak results are less than average limit, so not need to evaluate the average.



Standard:	FCC Part 15.407	Test Distance:	3 m
Test item:	Harmonic	Power:	AC 120 V/60 Hz
Frequency:	5785 MHz	Temp.(°C)/Hum.(%RH):	26(°C)/60 %RH
Mode:	Mode 5		
Ant.Polar.:	Horizontal		

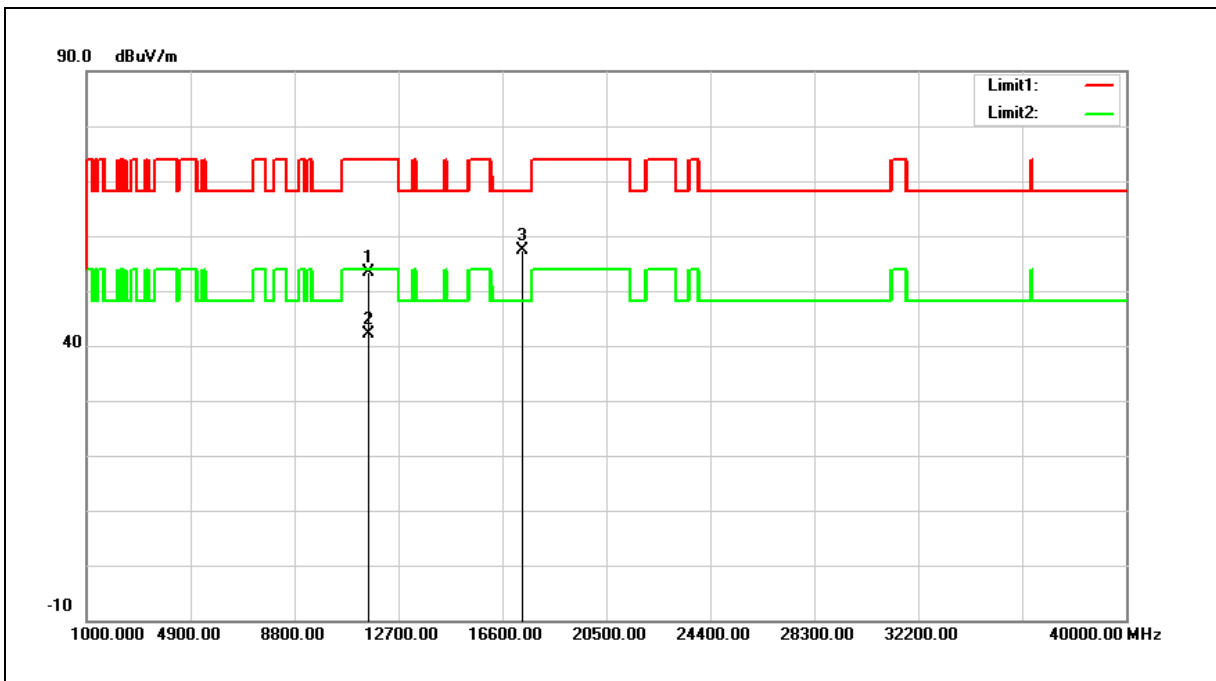

No.	Frequency (MHz)	Reading (dBuV)	Correct Factor (dB/m)	Result (dBuV/m)	Limit (dBuV/m)	Margin (dB)	Remark
1	11570.000	34.98	18.44	53.42	74.00	-20.58	peak
2	11570.000	23.77	18.44	42.21	54.00	-11.79	AVG
3	17355.000	32.54	24.79	57.33	68.20	-10.87	peak

Note:1.Result (dBuV/m) = Correct Factor (dB/m) + Reading(dBuV).

2.Correction factor (dB/m) = Antenna Factor (dB/m) + Cable loss (dB) – Pre-Amplifier gain (dB).

3. When the peak results are less than average limit, so not need to evaluate the average.



Standard:	FCC Part 15.407	Test Distance:	3 m
Test item:	Harmonic	Power:	AC 120 V/60 Hz
Frequency:	5785 MHz	Temp.(°C)/Hum.(%RH):	26(°C)/60 %RH
Mode:	Mode 5		
Ant.Polar.:	Vertical		

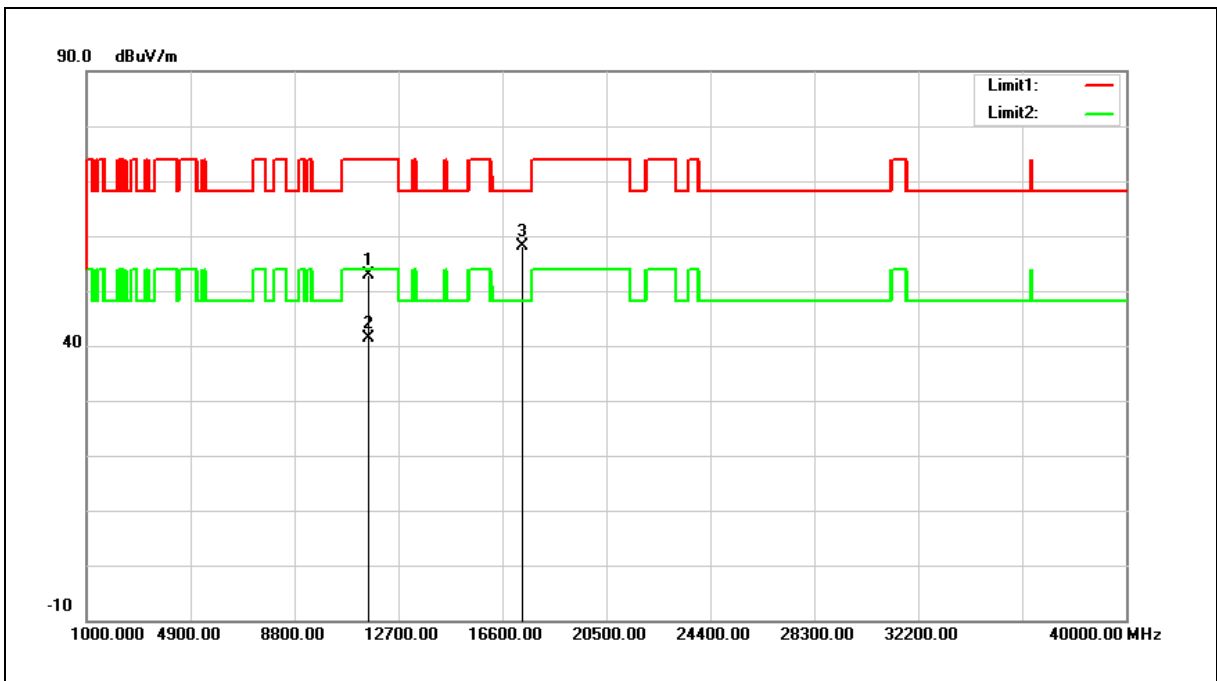

No.	Frequency (MHz)	Reading (dBuV)	Correct Factor (dB/m)	Result (dBuV/m)	Limit (dBuV/m)	Margin (dB)	Remark
1	11570.000	34.53	18.44	52.97	74.00	-21.03	peak
2	11570.000	22.94	18.44	41.38	54.00	-12.62	AVG
3	17355.000	33.33	24.79	58.12	68.20	-10.08	peak

Note:1.Result (dBuV/m) = Correct Factor (dB/m) + Reading(dBuV).

2.Correction factor (dB/m) = Antenna Factor (dB/m) + Cable loss (dB) – Pre-Amplifier gain (dB).

3. When the peak results are less than average limit, so not need to evaluate the average.



Standard:	FCC Part 15.407	Test Distance:	3 m
Test item:	Harmonic	Power:	AC 120 V/60 Hz
Frequency:	5825 MHz	Temp.(°C)/Hum.(%RH):	26(°C)/60 %RH
Mode:	Mode 5		
Ant.Polar.:	Horizontal		

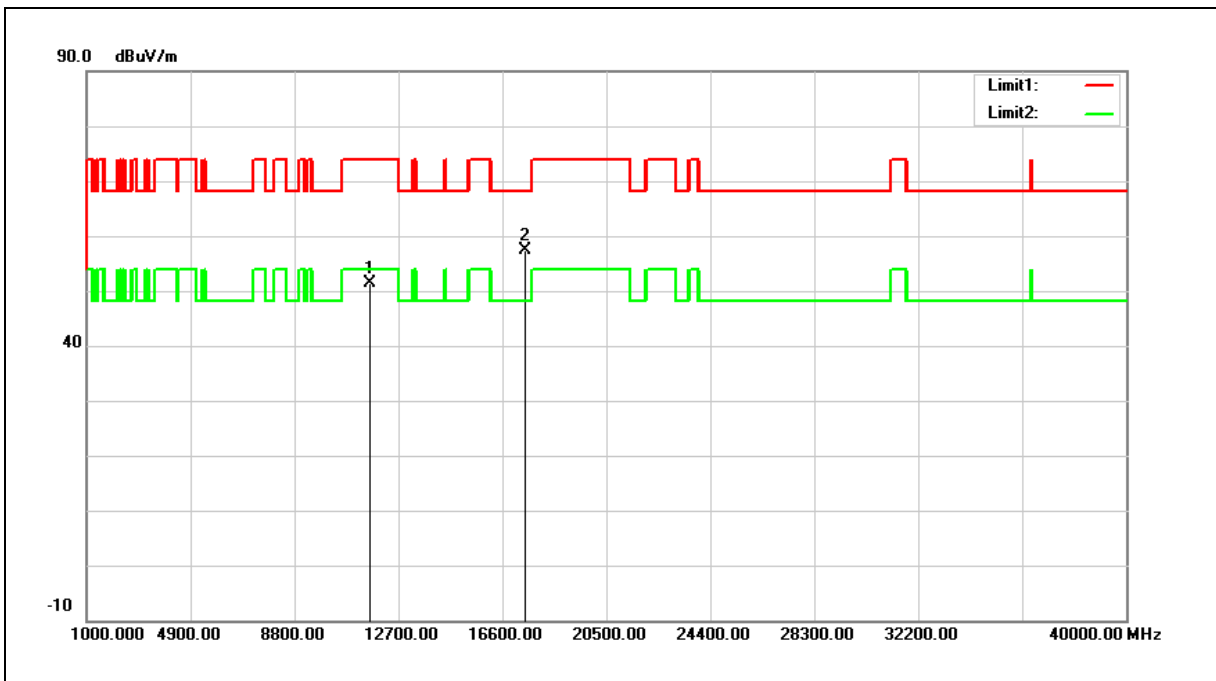

No.	Frequency (MHz)	Reading (dBuV)	Correct Factor (dB/m)	Result (dBuV/m)	Limit (dBuV/m)	Margin (dB)	Remark
1	11650.000	33.09	18.38	51.47	74.00	-22.53	peak
2	17475.000	32.10	25.26	57.36	68.20	-10.84	peak

- Note:1.Result (dBuV/m) = Correct Factor (dB/m) + Reading(dBuV).
- 2.Correction factor (dB/m) = Antenna Factor (dB/m) + Cable loss (dB) – Pre-Amplifier gain (dB).
3. When the peak results are less than average limit, so not need to evaluate the average.



Standard:	FCC Part 15.407	Test Distance:	3 m
Test item:	Harmonic	Power:	AC 120 V/60 Hz
Frequency:	5825 MHz	Temp.(°C)/Hum.(%RH):	26(°C)/60 %RH
Mode:	Mode 5		
Ant.Polar.:	Vertical		

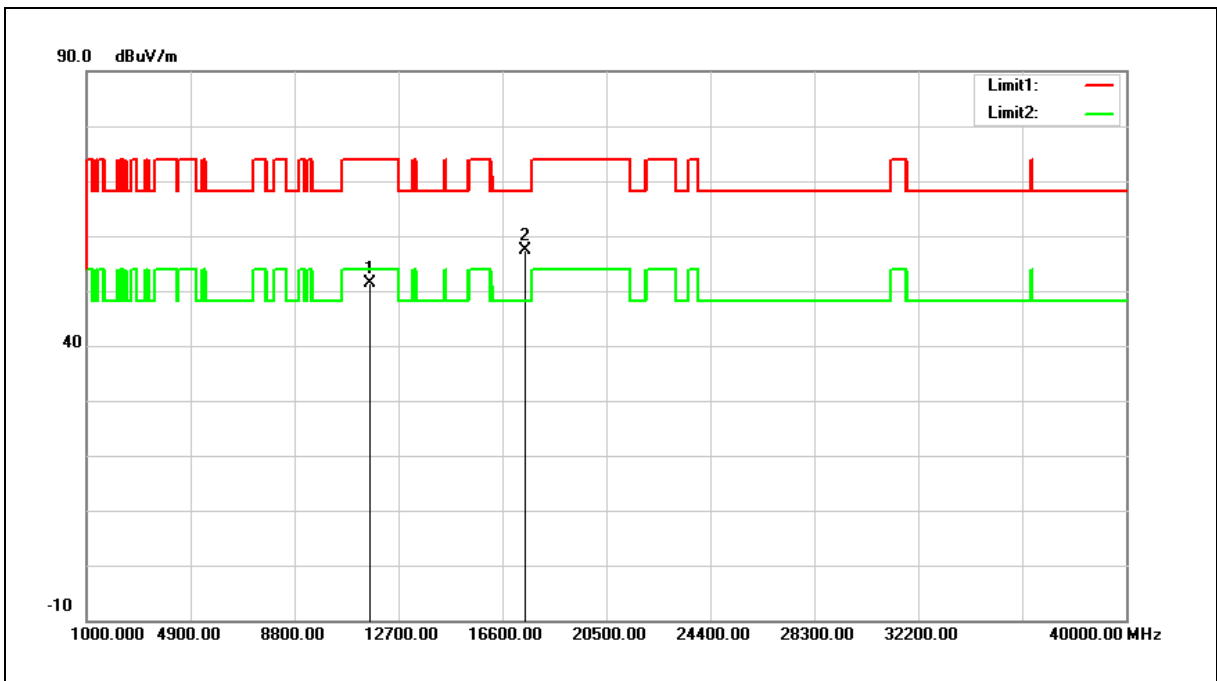

No.	Frequency (MHz)	Reading (dBuV)	Correct Factor (dB/m)	Result (dBuV/m)	Limit (dBuV/m)	Margin (dB)	Remark
1	11650.000	32.97	18.38	51.35	74.00	-22.65	peak
2	17475.000	32.21	25.26	57.47	68.20	-10.73	peak

Note:1.Result (dBuV/m) = Correct Factor (dB/m) + Reading(dBuV).

2.Correction factor (dB/m) = Antenna Factor (dB/m) + Cable loss (dB) – Pre-Amplifier gain (dB).

3. When the peak results are less than average limit, so not need to evaluate the average.



Standard:	FCC Part 15.407	Test Distance:	3 m
Test item:	Harmonic	Power:	AC 120 V/60 Hz
Frequency:	5190 MHz	Temp.(°C)/Hum.(%RH):	26(°C)/60 %RH
Mode:	Mode 6		
Ant.Polar.:	Horizontal		

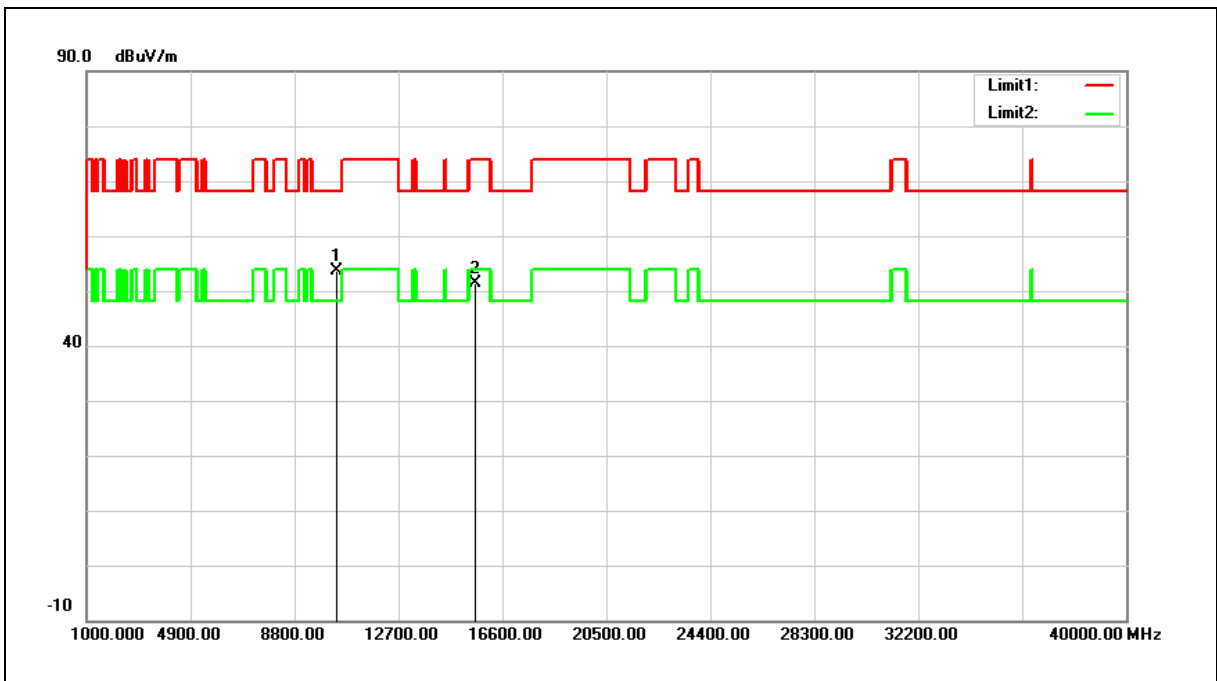

No.	Frequency (MHz)	Reading (dBuV)	Correct Factor (dB/m)	Result (dBuV/m)	Limit (dBuV/m)	Margin (dB)	Remark
1	10380.000	36.73	16.98	53.71	68.20	-14.49	peak
2	15570.000	32.28	19.11	51.39	74.00	-22.61	peak

Note:1.Result (dBuV/m) = Correct Factor (dB/m) + Reading(dBuV).

2.Correction factor (dB/m) = Antenna Factor (dB/m) + Cable loss (dB) – Pre-Amplifier gain (dB).

3. When the peak results are less than average limit, so not need to evaluate the average.



Standard:	FCC Part 15.407	Test Distance:	3 m
Test item:	Harmonic	Power:	AC 120 V/60 Hz
Frequency:	5190 MHz	Temp.(°C)/Hum.(%RH):	26(°C)/60 %RH
Mode:	Mode 6		
Ant.Polar.:	Vertical		

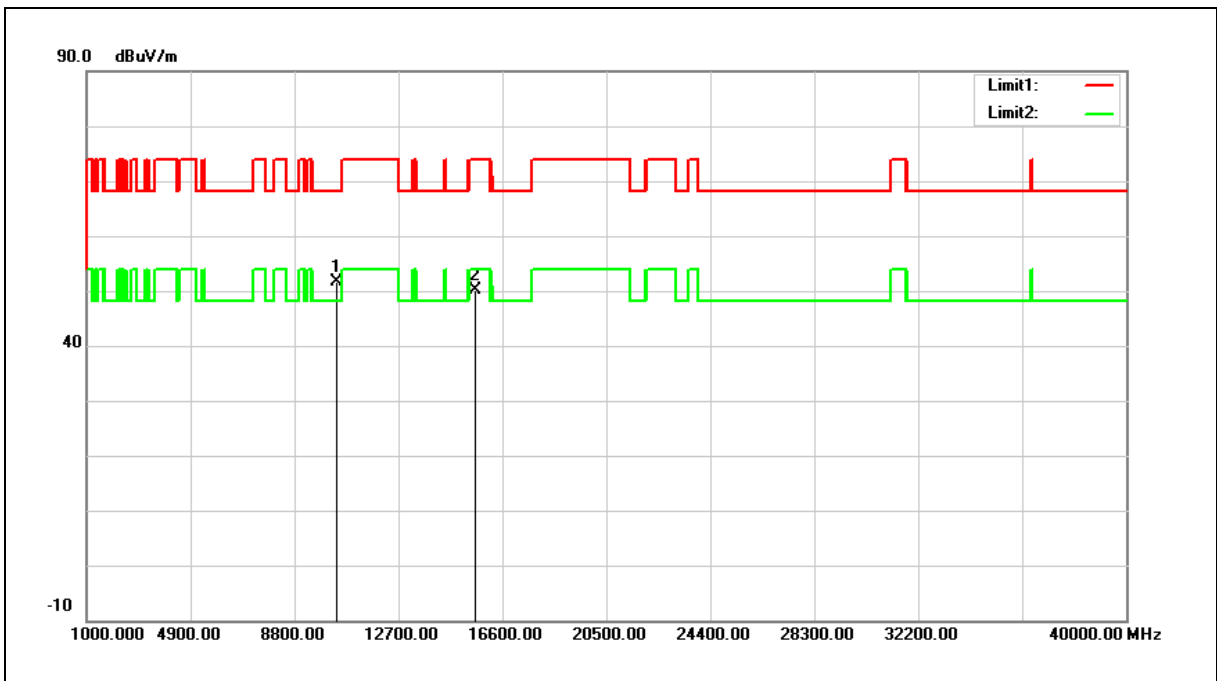

No.	Frequency (MHz)	Reading (dBuV)	Correct Factor (dB/m)	Result (dBuV/m)	Limit (dBuV/m)	Margin (dB)	Remark
1	10380.000	34.69	16.98	51.67	68.20	-16.53	peak
2	15570.000	31.07	19.11	50.18	74.00	-23.82	peak

Note:1.Result (dBuV/m) = Correct Factor (dB/m) + Reading(dBuV).

2.Correction factor (dB/m) = Antenna Factor (dB/m) + Cable loss (dB) – Pre-Amplifier gain (dB).

3. When the peak results are less than average limit, so not need to evaluate the average.



Standard:	FCC Part 15.407	Test Distance:	3 m
Test item:	Harmonic	Power:	AC 120 V/60 Hz
Frequency:	5230 MHz	Temp.(°C)/Hum.(%RH):	26(°C)/60 %RH
Mode:	Mode 6		
Ant.Polar.:	Horizontal		

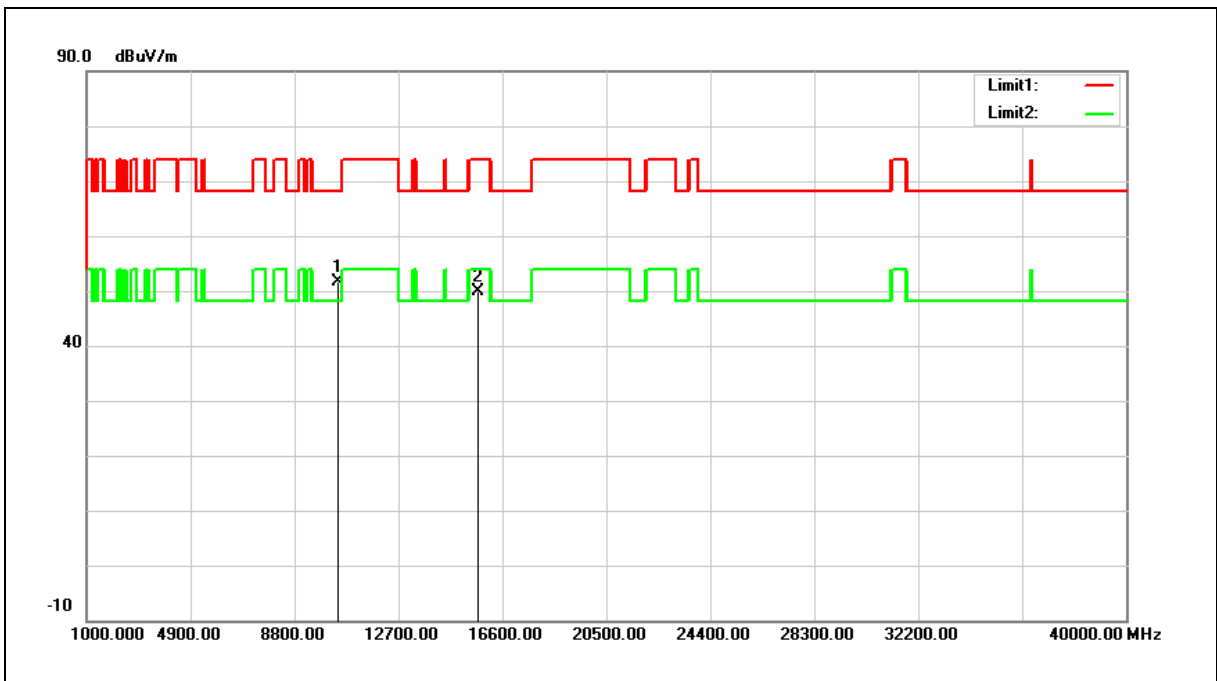

No.	Frequency (MHz)	Reading (dBuV)	Correct Factor (dB/m)	Result (dBuV/m)	Limit (dBuV/m)	Margin (dB)	Remark
1	10460.000	34.28	17.27	51.55	68.20	-16.65	peak
2	15690.000	31.04	18.78	49.82	74.00	-24.18	peak

Note:1.Result (dBuV/m) = Correct Factor (dB/m) + Reading(dBuV).

2.Correction factor (dB/m) = Antenna Factor (dB/m) + Cable loss (dB) – Pre-Amplifier gain (dB).

3. When the peak results are less than average limit, so not need to evaluate the average.



Standard:	FCC Part 15.407	Test Distance:	3 m
Test item:	Harmonic	Power:	AC 120 V/60 Hz
Frequency:	5230 MHz	Temp.(°C)/Hum.(%RH):	26(°C)/60 %RH
Mode:	Mode 6		
Ant.Polar.:	Vertical		

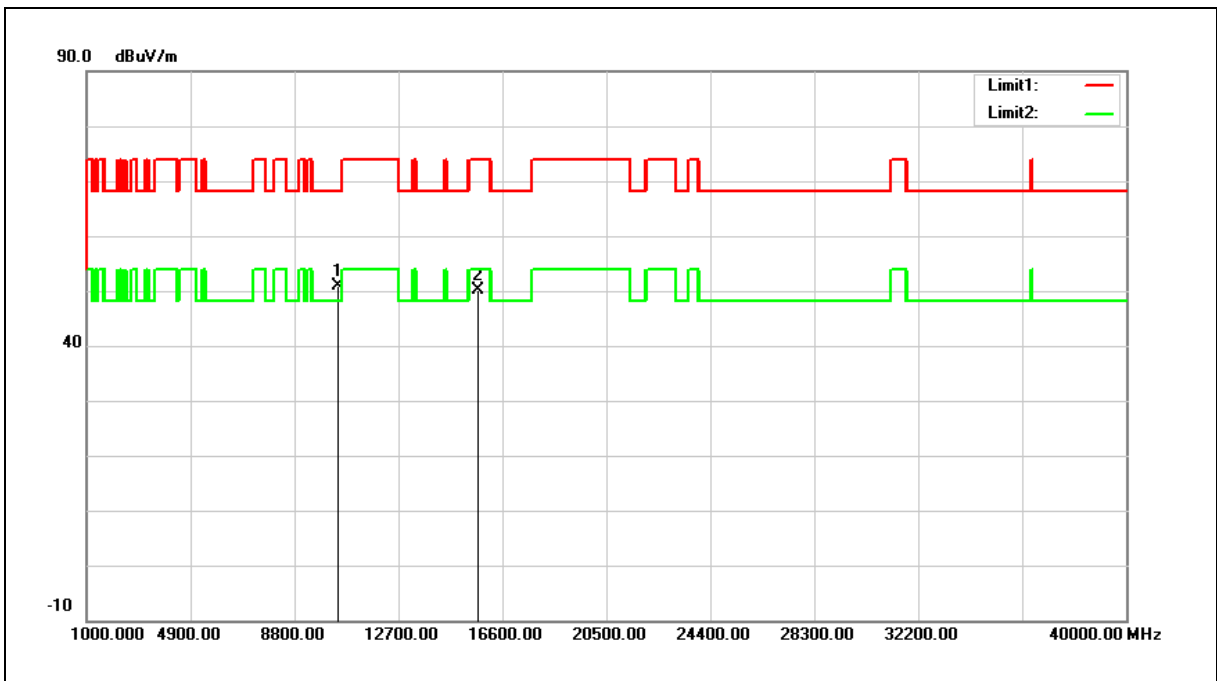

No.	Frequency (MHz)	Reading (dBuV)	Correct Factor (dB/m)	Result (dBuV/m)	Limit (dBuV/m)	Margin (dB)	Remark
1	10460.000	33.64	17.27	50.91	68.20	-17.29	peak
2	15690.000	31.32	18.78	50.10	74.00	-23.90	peak

Note:1.Result (dBuV/m) = Correct Factor (dB/m) + Reading(dBuV).

2.Correction factor (dB/m) = Antenna Factor (dB/m) + Cable loss (dB) – Pre-Amplifier gain (dB).

3. When the peak results are less than average limit, so not need to evaluate the average.



Standard:	FCC Part 15.407	Test Distance:	3 m
Test item:	Harmonic	Power:	AC 120 V/60 Hz
Frequency:	5755 MHz	Temp.(°C)/Hum.(%RH):	26(°C)/60 %RH
Mode:	Mode 6		
Ant.Polar.:	Horizontal		

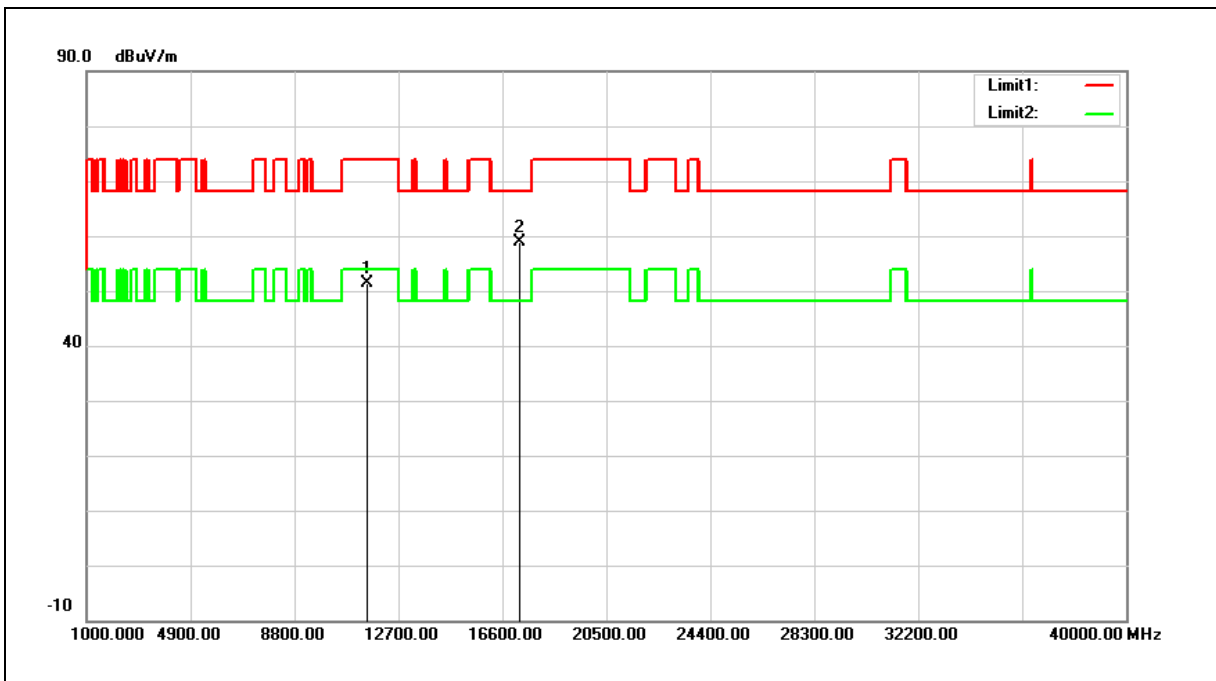

No.	Frequency (MHz)	Reading (dBuV)	Correct Factor (dB/m)	Result (dBuV/m)	Limit (dBuV/m)	Margin (dB)	Remark
1	11510.000	32.87	18.49	51.36	74.00	-22.64	peak
2	17265.000	34.47	24.44	58.91	68.20	-9.29	peak

Note:1.Result (dBuV/m) = Correct Factor (dB/m) + Reading(dBuV).

2.Correction factor (dB/m) = Antenna Factor (dB/m) + Cable loss (dB) – Pre-Amplifier gain (dB).

3. When the peak results are less than average limit, so not need to evaluate the average.



Standard:	FCC Part 15.407	Test Distance:	3 m
Test item:	Harmonic	Power:	AC 120 V/60 Hz
Frequency:	5755 MHz	Temp.(°C)/Hum.(%RH):	26(°C)/60 %RH
Mode:	Mode 6		
Ant.Polar.:	Vertical		

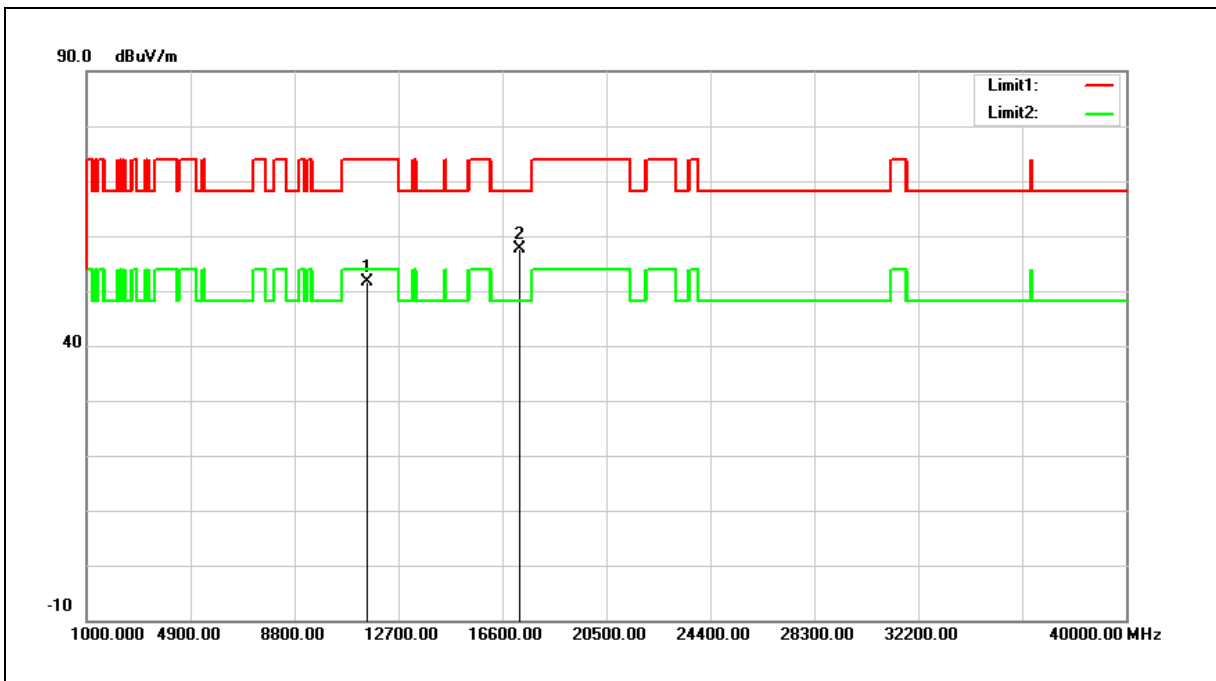

No.	Frequency (MHz)	Reading (dBuV)	Correct Factor (dB/m)	Result (dBuV/m)	Limit (dBuV/m)	Margin (dB)	Remark
1	11510.000	33.23	18.49	51.72	74.00	-22.28	peak
2	17265.000	33.26	24.44	57.70	68.20	-10.50	peak

Note:1.Result (dBuV/m) = Correct Factor (dB/m) + Reading(dBuV).

2.Correction factor (dB/m) = Antenna Factor (dB/m) + Cable loss (dB) – Pre-Amplifier gain (dB).

3. When the peak results are less than average limit, so not need to evaluate the average.



Standard:	FCC Part 15.407	Test Distance:	3 m
Test item:	Harmonic	Power:	AC 120 V/60 Hz
Frequency:	5795 MHz	Temp.(°C)/Hum.(%RH):	26(°C)/60 %RH
Mode:	Mode 6		
Ant.Polar.:	Horizontal		

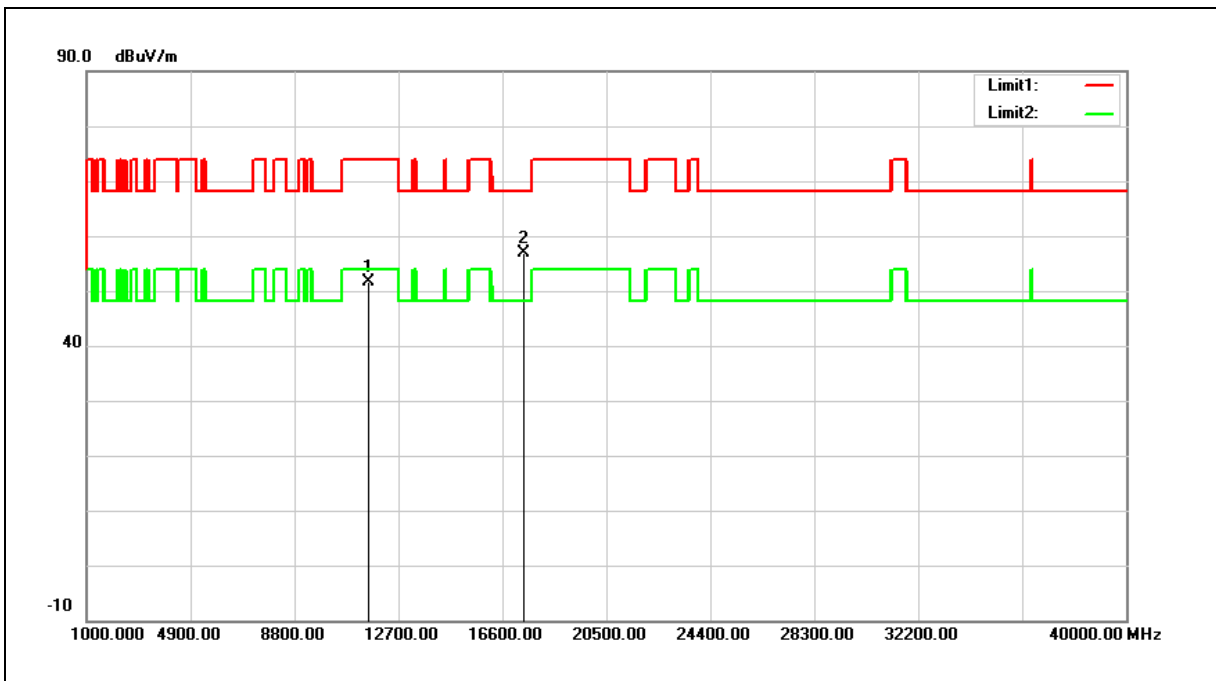

No.	Frequency (MHz)	Reading (dBuV)	Correct Factor (dB/m)	Result (dBuV/m)	Limit (dBuV/m)	Margin (dB)	Remark
1	11590.000	33.09	18.43	51.52	74.00	-22.48	peak
2	17385.000	31.89	24.90	56.79	68.20	-11.41	peak

Note:1.Result (dBuV/m) = Correct Factor (dB/m) + Reading(dBuV).

2.Correction factor (dB/m) = Antenna Factor (dB/m) + Cable loss (dB) – Pre-Amplifier gain (dB).

3. When the peak results are less than average limit, so not need to evaluate the average.



Standard:	FCC Part 15.407	Test Distance:	3 m
Test item:	Harmonic	Power:	AC 120 V/60 Hz
Frequency:	5795 MHz	Temp.(°C)/Hum.(%RH):	26(°C)/60 %RH
Mode:	Mode 6		
Ant.Polar.:	Vertical		

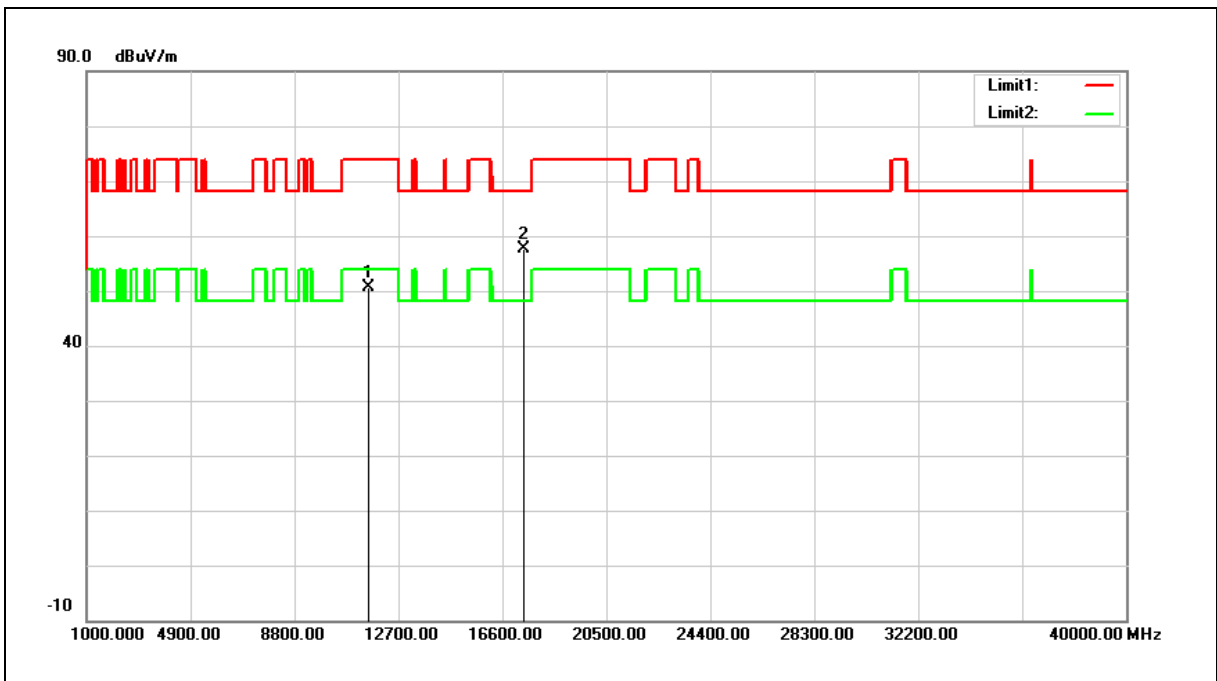

No.	Frequency (MHz)	Reading (dBuV)	Correct Factor (dB/m)	Result (dBuV/m)	Limit (dBuV/m)	Margin (dB)	Remark
1	11590.000	32.27	18.43	50.70	74.00	-23.30	peak
2	17385.000	32.62	24.90	57.52	68.20	-10.68	peak

Note:1.Result (dBuV/m) = Correct Factor (dB/m) + Reading(dBuV).

2.Correction factor (dB/m) = Antenna Factor (dB/m) + Cable loss (dB) – Pre-Amplifier gain (dB).

3. When the peak results are less than average limit, so not need to evaluate the average.



Standard:	FCC Part 15.407	Test Distance:	3 m
Test item:	Harmonic	Power:	AC 120 V/60 Hz
Frequency:	5210 MHz	Temp.(°C)/Hum.(%RH):	26(°C)/60 %RH
Mode:	Mode 7		
Ant.Polar.:	Horizontal		

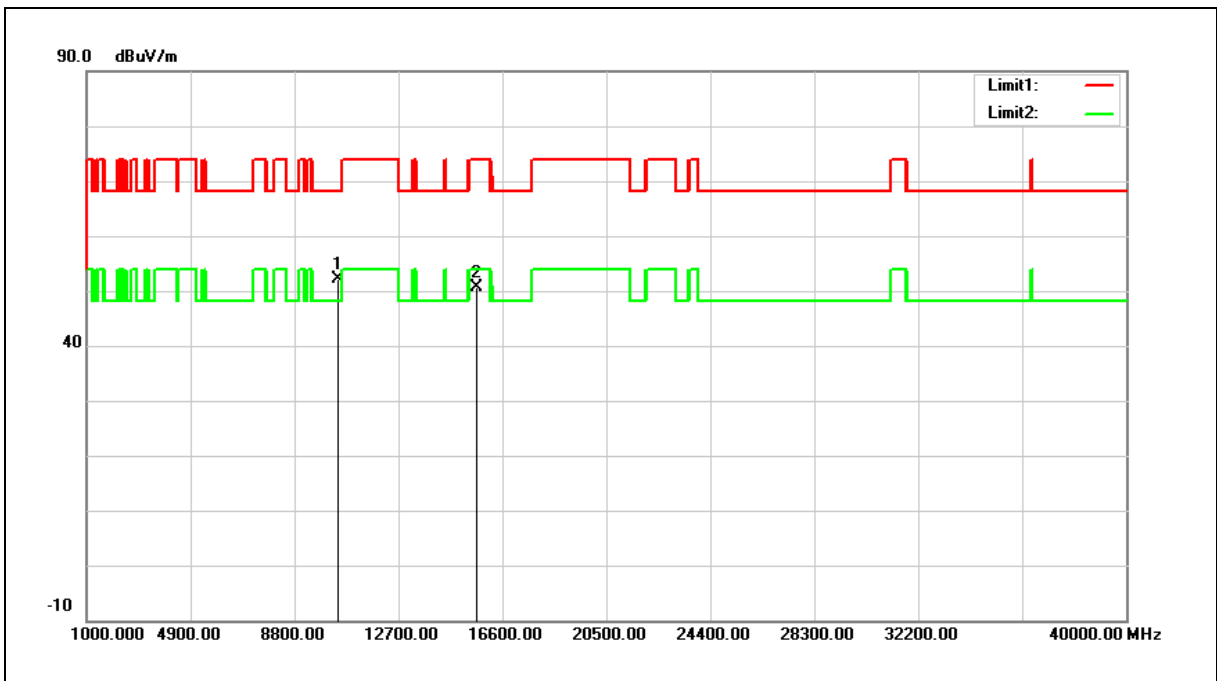

No.	Frequency (MHz)	Reading (dBuV)	Correct Factor (dB/m)	Result (dBuV/m)	Limit (dBuV/m)	Margin (dB)	Remark
1	10420.000	34.90	17.13	52.03	68.20	-16.17	peak
2	15630.000	31.72	18.94	50.66	74.00	-23.34	peak

Note:1.Result (dBuV/m) = Correct Factor (dB/m) + Reading(dBuV).

2.Correction factor (dB/m) = Antenna Factor (dB/m) + Cable loss (dB) – Pre-Amplifier gain (dB).

3. When the peak results are less than average limit, so not need to evaluate the average.



Standard:	FCC Part 15.407	Test Distance:	3 m
Test item:	Harmonic	Power:	AC 120 V/60 Hz
Frequency:	5210 MHz	Temp.(°C)/Hum.(%RH):	26(°C)/60 %RH
Mode:	Mode 7		
Ant.Polar.:	Vertical		

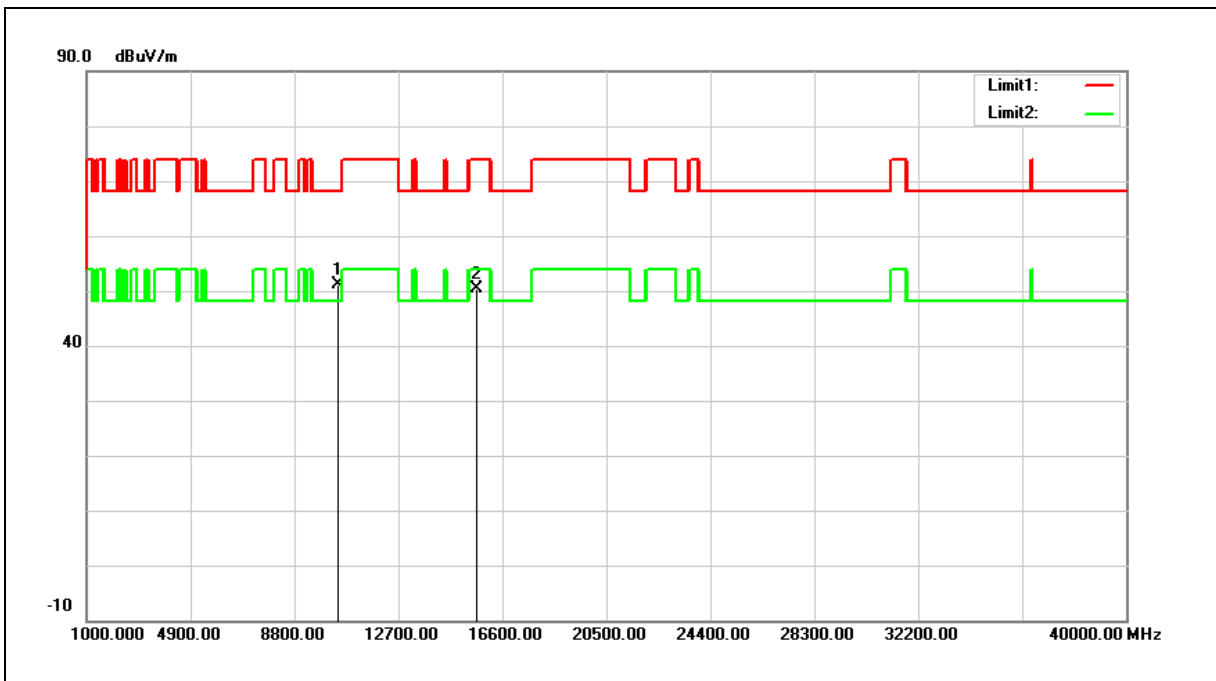

No.	Frequency (MHz)	Reading (dBuV)	Correct Factor (dB/m)	Result (dBuV/m)	Limit (dBuV/m)	Margin (dB)	Remark
1	10420.000	34.01	17.13	51.14	68.20	-17.06	peak
2	15630.000	31.33	18.94	50.27	74.00	-23.73	peak

- Note:1.Result (dBuV/m) = Correct Factor (dB/m) + Reading(dBuV).
- 2.Correction factor (dB/m) = Antenna Factor (dB/m) + Cable loss (dB) – Pre-Amplifier gain (dB).
3. When the peak results are less than average limit, so not need to evaluate the average.



Standard:	FCC Part 15.407	Test Distance:	3 m
Test item:	Harmonic	Power:	AC 120 V/60 Hz
Frequency:	5775 MHz	Temp.(°C)/Hum.(%RH):	26(°C)/60 %RH
Mode:	Mode 7		
Ant.Polar.:	Horizontal		

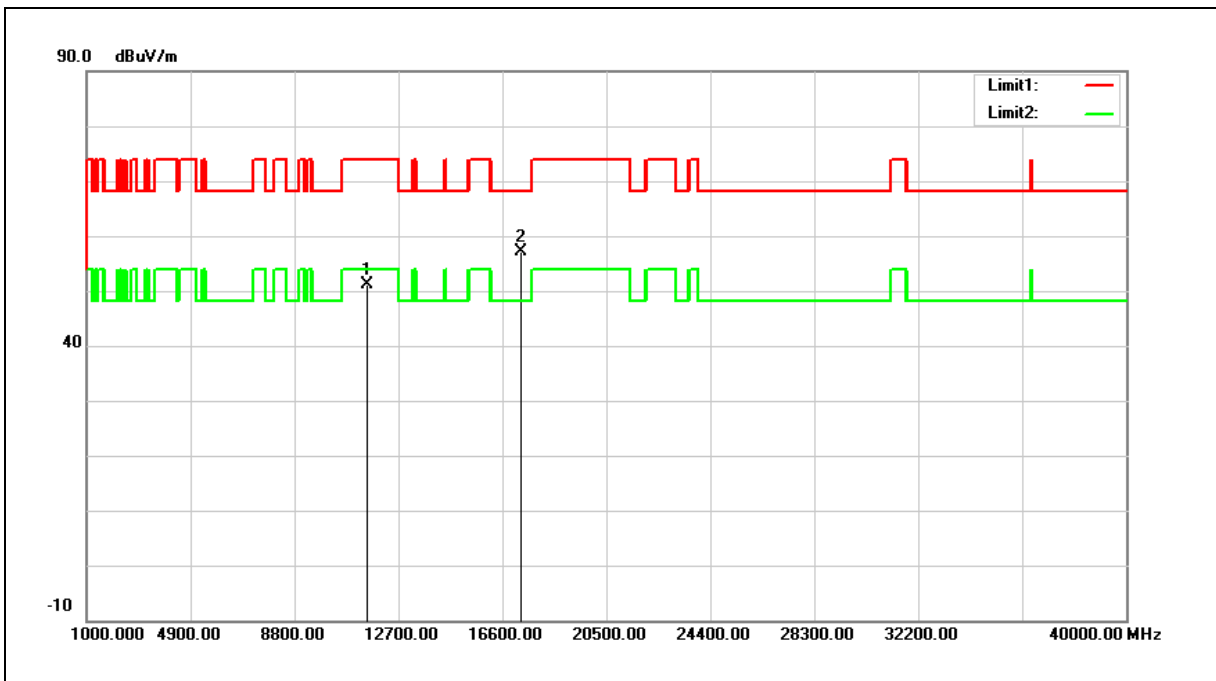

No.	Frequency (MHz)	Reading (dBuV)	Correct Factor (dB/m)	Result (dBuV/m)	Limit (dBuV/m)	Margin (dB)	Remark
1	11550.000	32.60	18.46	51.06	74.00	-22.94	peak
2	17325.000	32.57	24.68	57.25	68.20	-10.95	peak

- Note:1.Result (dBuV/m) = Correct Factor (dB/m) + Reading(dBuV).
- 2.Correction factor (dB/m) = Antenna Factor (dB/m) + Cable loss (dB) – Pre-Amplifier gain (dB).
3. When the peak results are less than average limit, so not need to evaluate the average.



Standard:	FCC Part 15.407	Test Distance:	3 m
Test item:	Harmonic	Power:	AC 120 V/60 Hz
Frequency:	5775 MHz	Temp.(°C)/Hum.(%RH):	26(°C)/60 %RH
Mode:	Mode 7		
Ant.Polar.:	Vertical		

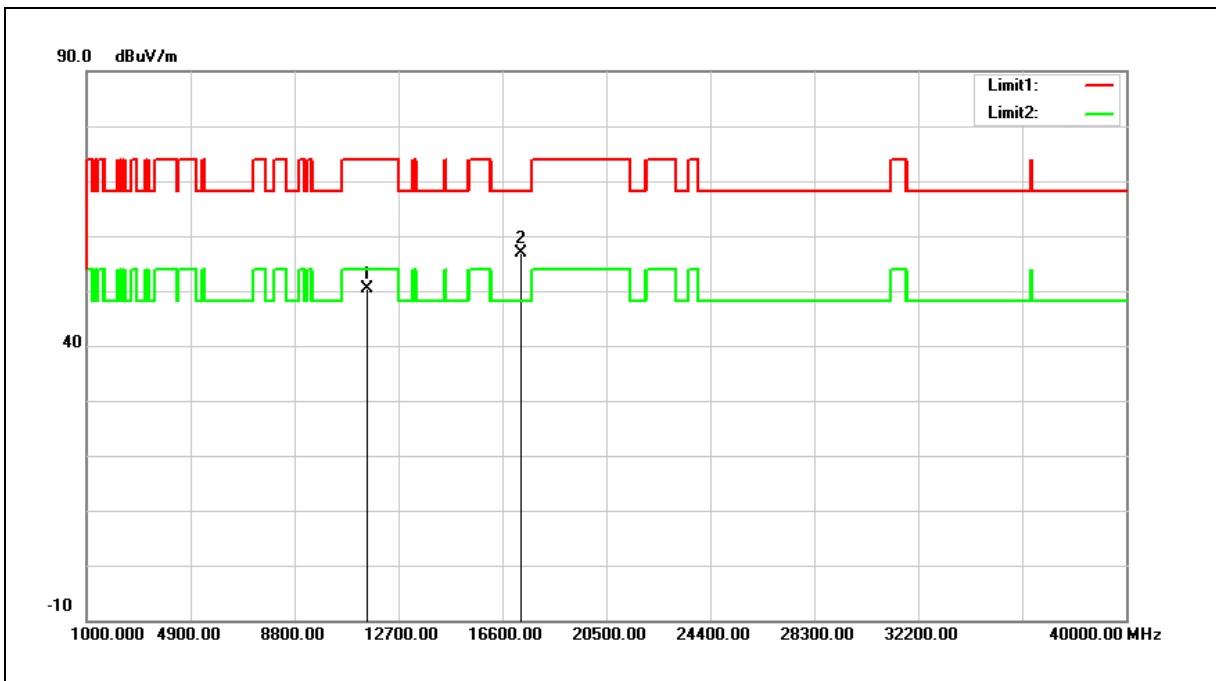

No.	Frequency (MHz)	Reading (dBuV)	Correct Factor (dB/m)	Result (dBuV/m)	Limit (dBuV/m)	Margin (dB)	Remark
1	11550.000	31.82	18.46	50.28	74.00	-23.72	peak
2	17325.000	32.12	24.68	56.80	68.20	-11.40	peak

- Note:1.Result (dBuV/m) = Correct Factor (dB/m) + Reading(dBuV).
 2.Correction factor (dB/m) = Antenna Factor (dB/m) + Cable loss (dB) – Pre-Amplifier gain (dB).
 3. When the peak results are less than average limit, so not need to evaluate the average.

Standard:	FCC Part 15.407	Test Distance:	3 m
Test item:	Transmitter Unwanted Emissions	Power:	AC 120 V/60 Hz
Frequency:	Simultaneous Transmitting	Temp.(°C)/Hum.(%RH):	26(°C)/60 %RH
Mode:	(WLAN 2.4 GHz + 5 GHz)		
Ant.Polar.:	Horizontal		

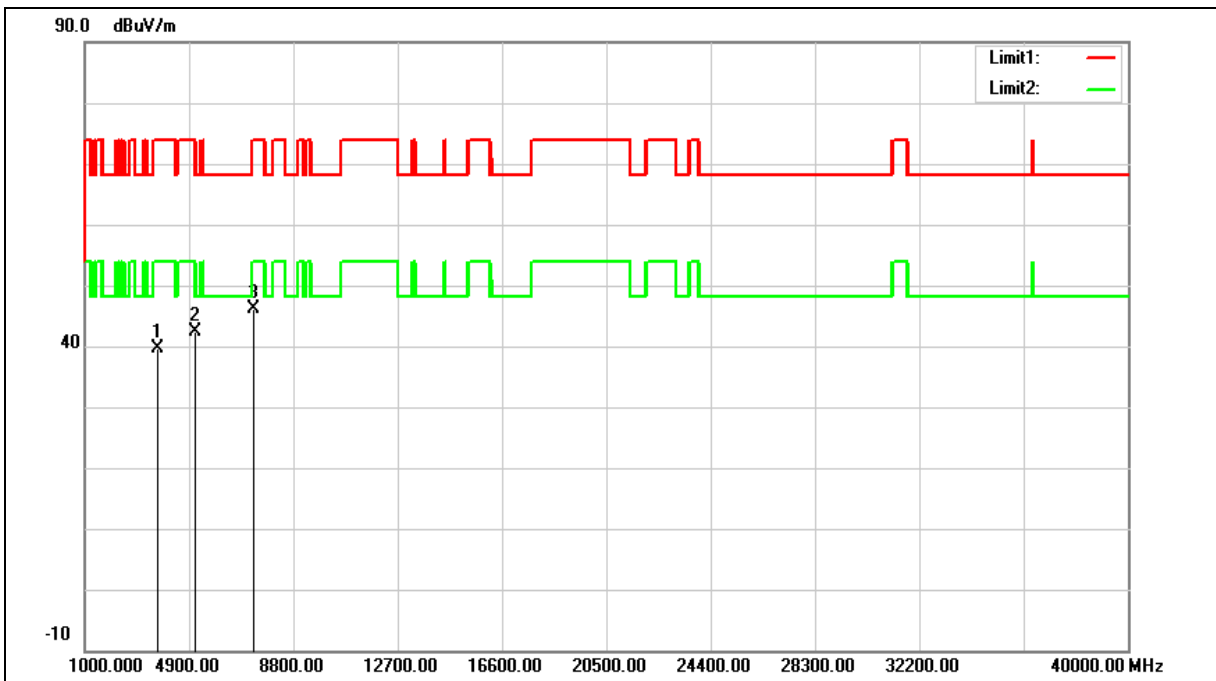

No.	Frequency (MHz)	Reading (dBuV)	Correct Factor (dB/m)	Result (dBuV/m)	Limit (dBuV/m)	Margin (dB)	Remark
1	3754.000	37.12	2.52	39.64	74.00	-34.36	peak
2	5114.000	36.22	6.19	42.41	74.00	-31.59	peak
3	7307.000	33.93	12.14	46.07	74.00	-27.93	peak

Note:1.Result (dBuV/m) = Correct Factor (dB/m) + Reading(dBuV).

2.Correction factor (dB/m) = Antenna Factor (dB/m) + Cable loss (dB) – Pre-Amplifier gain (dB).

3. When the peak results are less than average limit, so not need to evaluate the average.



Standard:	FCC Part 15.407	Test Distance:	3 m
Test item:	Transmitter Unwanted Emissions	Power:	AC 120 V/60 Hz
Frequency:	Simultaneous Transmitting	Temp.(°C)/Hum.(%RH):	26(°C)/60 %RH
Mode:	(WLAN 2.4 GHz + 5 GHz)		
Ant.Polar.:	Vertical		

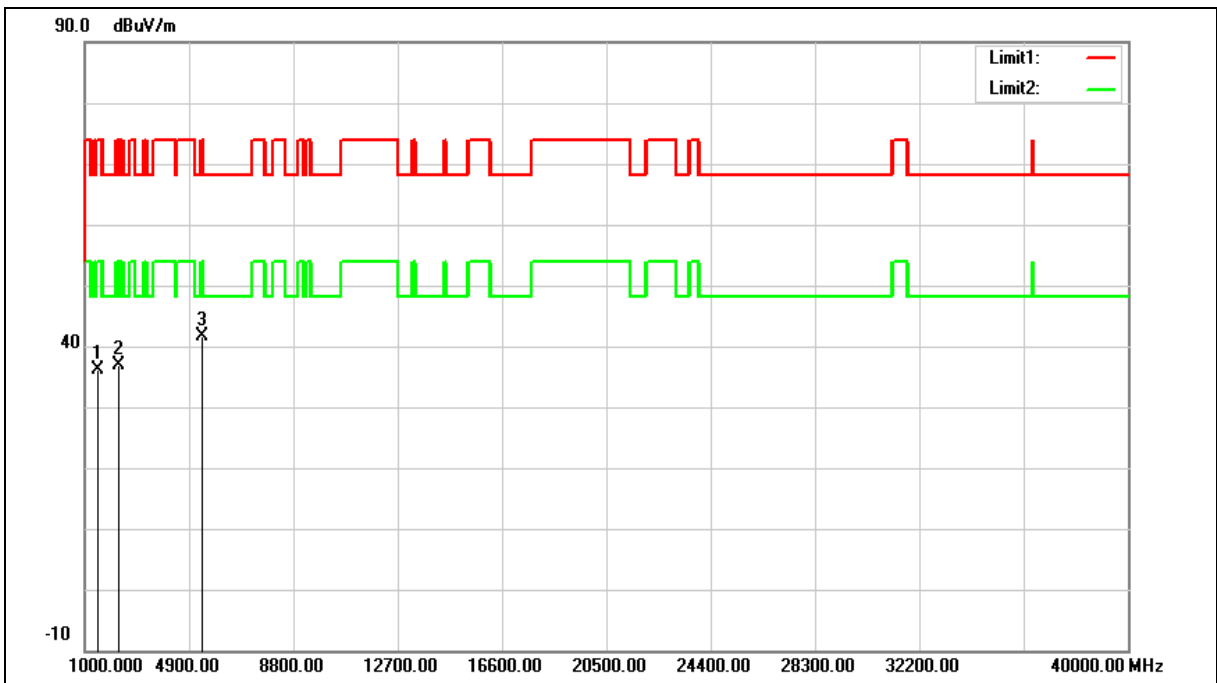

No.	Frequency (MHz)	Reading (dBuV)	Correct Factor (dB/m)	Result (dBuV/m)	Limit (dBuV/m)	Margin (dB)	Remark
1	1493.000	40.65	-4.53	36.12	74.00	-37.88	peak
2	2258.000	38.46	-1.53	36.93	74.00	-37.07	peak
3	5403.000	34.65	6.86	41.51	74.00	-32.49	peak

Note:1.Result (dBuV/m) = Correct Factor (dB/m) + Reading(dBuV).

2.Correction factor (dB/m) = Antenna Factor (dB/m) + Cable loss (dB) – Pre-Amplifier gain (dB).

3. When the peak results are less than average limit, so not need to evaluate the average.



Band Edge

Standard:	FCC Part 15.407	Test Distance:	3 m
Test item:	Band edge	Power:	AC 120 V/60 Hz
Frequency:	5180 MHz	Temp.(°C)/Hum.(%RH):	26(°C)/60 %RH
Mode:	Mode 2		
Ant.Polar.:	Horizontal		

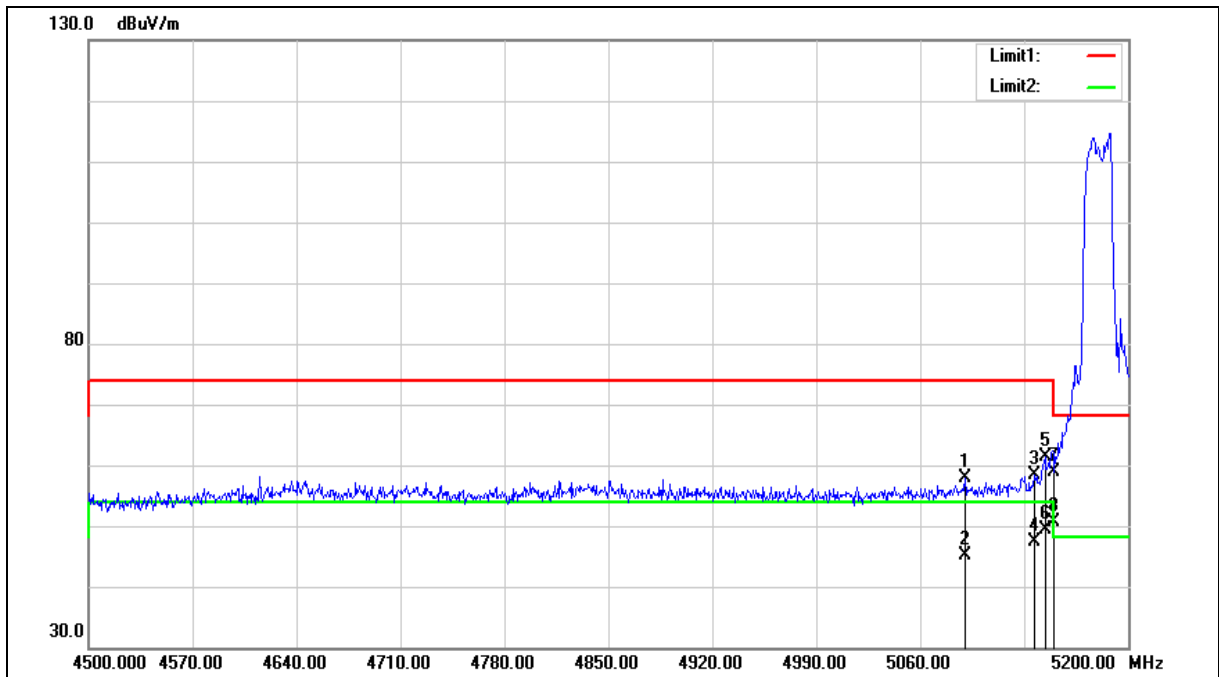



Standard:	FCC Part 15.407	Test Distance:	3 m
Test item:	Band edge	Power:	AC 120 V/60 Hz
Frequency:	5180 MHz	Temp.(°C)/Hum.(%RH):	26(°C)/60 %RH
Mode:	Mode 2		
Ant.Polar.:	Horizontal		

No.	Frequency (MHz)	Reading (dBuV)	Correct Factor (dB/m)	Result (dBuV/m)	Limit (dBuV/m)	Margin (dB)	Remark
1	5090.100	51.74	6.13	57.87	74.00	-16.13	peak
2	5090.100	39.05	6.13	45.18	54.00	-8.82	AVG
3	5137.000	52.09	6.23	58.32	74.00	-15.68	peak
4	5137.000	41.17	6.23	47.40	54.00	-6.60	AVG
5	5144.000	55.16	6.26	61.42	74.00	-12.58	peak
6	5144.000	43.21	6.26	49.47	54.00	-4.53	AVG
7	5150.000	52.54	6.27	58.81	74.00	-15.19	peak
8	5150.000	44.40	6.27	50.67	54.00	-3.33	AVG

Note:1.Result (dBuV/m) = Correct Factor (dB/m) + Reading(dBuV).

2.Correction factor (dB/m) = Antenna Factor (dB/m) + Cable loss (dB) – Pre-Amplifier gain (dB).

3.When the peak results are less than average limit, there is no need to evaluate the average.

4.The average measurement was not performed when the peak measured data is under the limit of average detection.

5.The emission level of other frequencies is much lower than the limit and not shown in test report.

Standard:	FCC Part 15.407	Test Distance:	3 m
Test item:	Band edge	Power:	AC 120 V/60 Hz
Frequency:	5180 MHz	Temp.(°C)/Hum.(%RH):	26(°C)/60 %RH
Mode:	Mode 2		
Ant.Polar.:	Vertical		

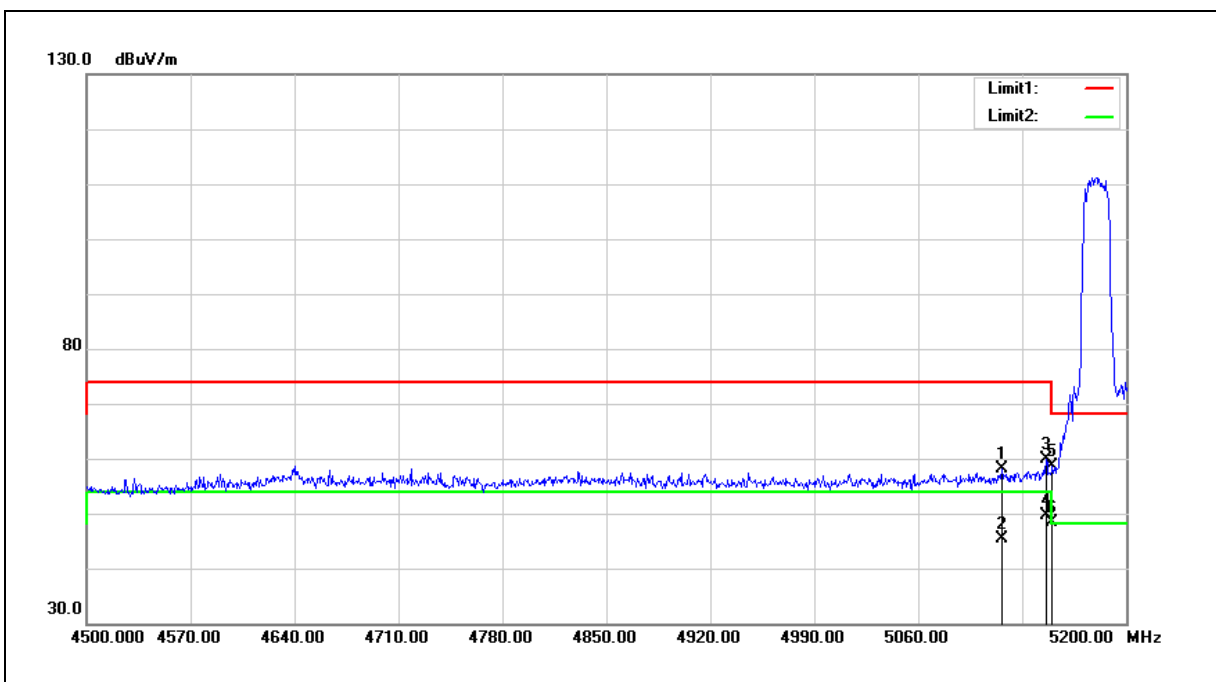

No.	Frequency (MHz)	Reading (dBuV)	Correct Factor (dB/m)	Result (dBuV/m)	Limit (dBuV/m)	Margin (dB)	Remark
1	5116.700	51.83	6.19	58.02	74.00	-15.98	peak
2	5116.700	39.20	6.19	45.39	54.00	-8.61	AVG
3	5146.100	53.55	6.26	59.81	74.00	-14.19	peak
4	5146.100	43.30	6.26	49.56	54.00	-4.44	AVG
5	5150.000	52.45	6.27	58.72	74.00	-15.28	peak
6	5150.000	42.14	6.27	48.41	54.00	-5.59	AVG

Note:1.Result (dBuV/m) = Correct Factor (dB/m) + Reading(dBuV).

2.Correction factor (dB/m) = Antenna Factor (dB/m) + Cable loss (dB) – Pre-Amplifier gain (dB).

3.When the peak results are less than average limit, there is no need to evaluate the average.

4.The average measurement was not performed when the peak measured data is under the limit of average detection.

5.The emission level of other frequencies is much lower than the limit and not shown in test report.



Standard:	FCC Part 15.407	Test Distance:	3 m
Test item:	Band edge	Power:	AC 120 V/60 Hz
Frequency:	5200 MHz	Temp.(°C)/Hum.(%RH):	26(°C)/60 %RH
Mode:	Mode 2		
Ant.Polar.:	Horizontal		

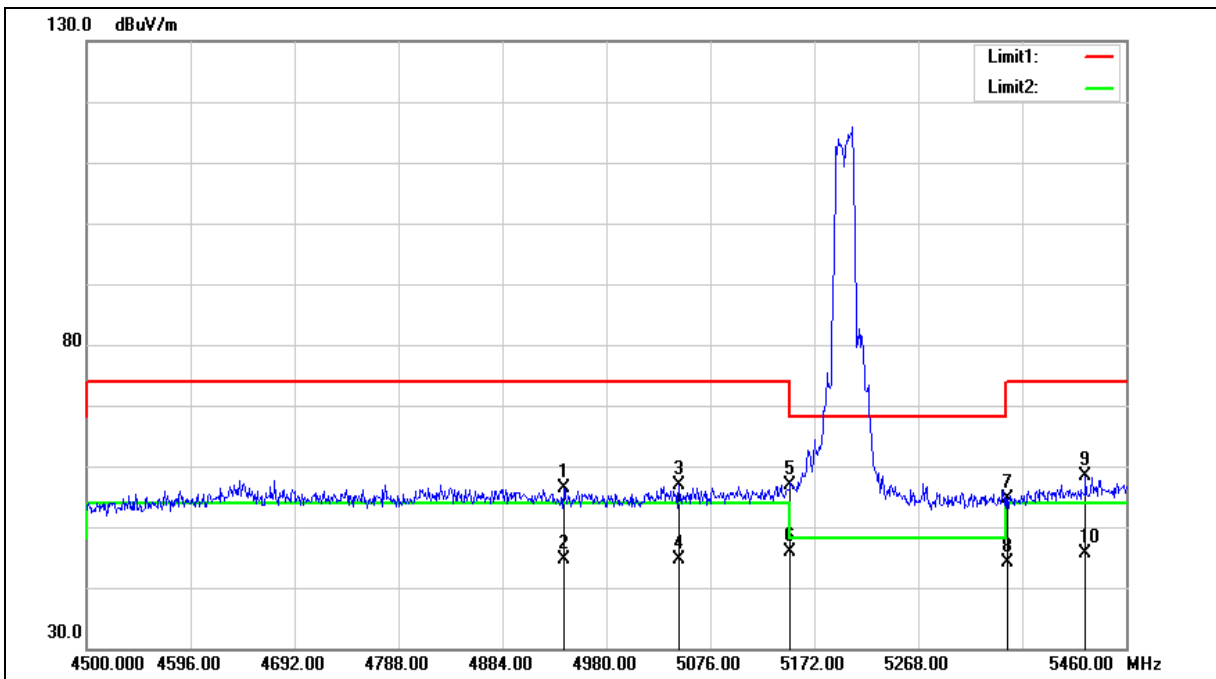



Standard:	FCC Part 15.407	Test Distance:	3 m
Test item:	Band edge	Power:	AC 120 V/60 Hz
Frequency:	5200 MHz	Temp.(°C)/Hum.(%RH):	26(°C)/60 %RH
Mode:	Mode 2		
Ant.Polar.:	Horizontal		

No.	Frequency (MHz)	Reading (dBuV)	Correct Factor (dB/m)	Result (dBuV/m)	Limit (dBuV/m)	Margin (dB)	Remark
1	4940.640	50.58	5.79	56.37	74.00	-17.63	peak
2	4940.640	38.72	5.79	44.51	54.00	-9.49	AVG
3	5047.200	50.97	6.02	56.99	74.00	-17.01	peak
4	5047.200	38.56	6.02	44.58	54.00	-9.42	AVG
5	5150.000	50.60	6.27	56.87	74.00	-17.13	peak
6	5150.000	39.57	6.27	45.84	54.00	-8.16	AVG
7	5350.000	47.79	6.74	54.53	74.00	-19.47	peak
8	5350.000	37.32	6.74	44.06	54.00	-9.94	AVG
9	5422.560	51.46	6.92	58.38	74.00	-15.62	peak
10	5422.560	38.79	6.92	45.71	54.00	-8.29	AVG

Note:1.Result (dBuV/m) = Correct Factor (dB/m) + Reading(dBuV).

2.Correction factor (dB/m) = Antenna Factor (dB/m) + Cable loss (dB) – Pre-Amplifier gain (dB).

3.When the peak results are less than average limit, there is no need to evaluate the average.

4.The average measurement was not performed when the peak measured data is under the limit of average detection.

5.The emission level of other frequencies is much lower than the limit and not shown in test report.



Standard:	FCC Part 15.407	Test Distance:	3 m
Test item:	Band edge	Power:	AC 120 V/60 Hz
Frequency:	5200 MHz	Temp.(°C)/Hum.(%RH):	26(°C)/60 %RH
Mode:	Mode 2		
Ant.Polar.:	Vertical		

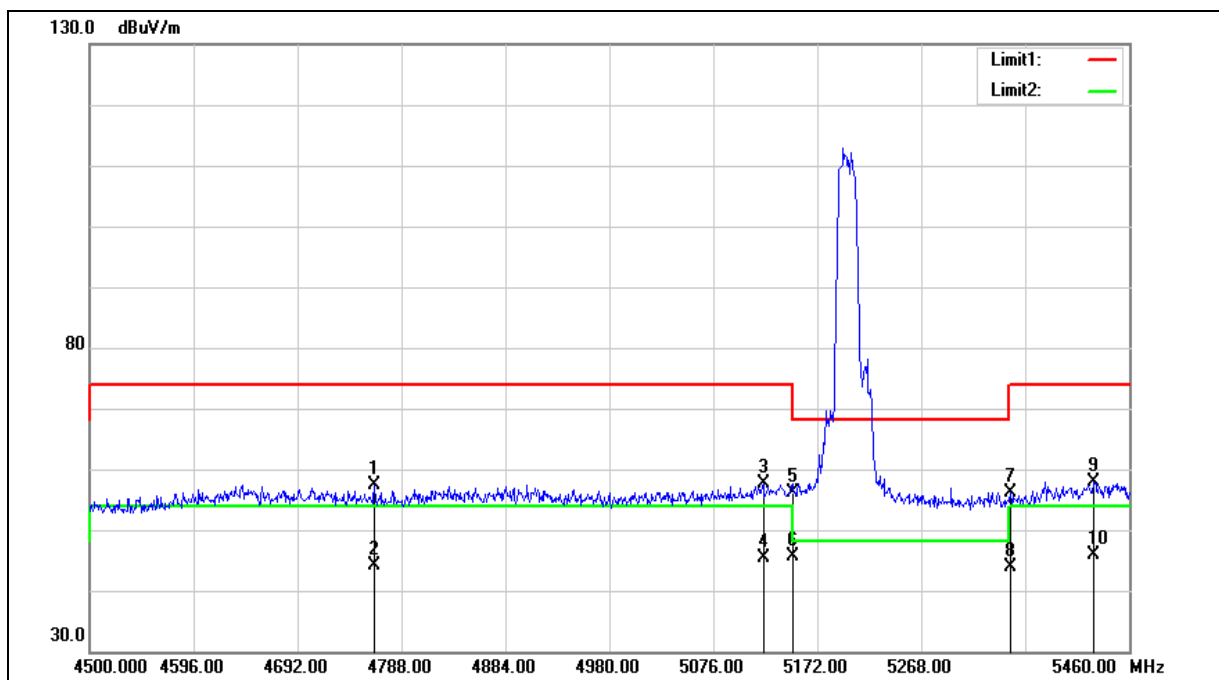



Standard:	FCC Part 15.407	Test Distance:	3 m
Test item:	Band edge	Power:	AC 120 V/60 Hz
Frequency:	5200 MHz	Temp.(°C)/Hum.(%RH):	26(°C)/60 %RH
Mode:	Mode 2		
Ant.Polar.:	Vertical		

No.	Frequency (MHz)	Reading (dBuV)	Correct Factor (dB/m)	Result (dBuV/m)	Limit (dBuV/m)	Margin (dB)	Remark
1	4763.040	52.03	5.46	57.49	74.00	-16.51	peak
2	4763.040	38.69	5.46	44.15	54.00	-9.85	AVG
3	5122.080	51.33	6.20	57.53	74.00	-16.47	peak
4	5122.080	39.15	6.20	45.35	54.00	-8.65	AVG
5	5150.000	49.91	6.27	56.18	74.00	-17.82	peak
6	5150.000	39.43	6.27	45.70	54.00	-8.30	AVG
7	5350.000	49.39	6.74	56.13	74.00	-17.87	peak
8	5350.000	37.20	6.74	43.94	54.00	-10.06	AVG
9	5427.360	50.99	6.93	57.92	74.00	-16.08	peak
10	5427.360	38.94	6.93	45.87	54.00	-8.13	AVG

Note:1.Result (dBuV/m) = Correct Factor (dB/m) + Reading(dBuV).

2.Correction factor (dB/m) = Antenna Factor (dB/m) + Cable loss (dB) – Pre-Amplifier gain (dB).

3.When the peak results are less than average limit, there is no need to evaluate the average.

4.The average measurement was not performed when the peak measured data is under the limit of average detection.

5.The emission level of other frequencies is much lower than the limit and not shown in test report.



Standard:	FCC Part 15.407	Test Distance:	3 m
Test item:	Band edge	Power:	AC 120 V/60 Hz
Frequency:	5240 MHz	Temp.(°C)/Hum.(%RH):	26(°C)/60 %RH
Mode:	Mode 2		
Ant.Polar.:	Horizontal		

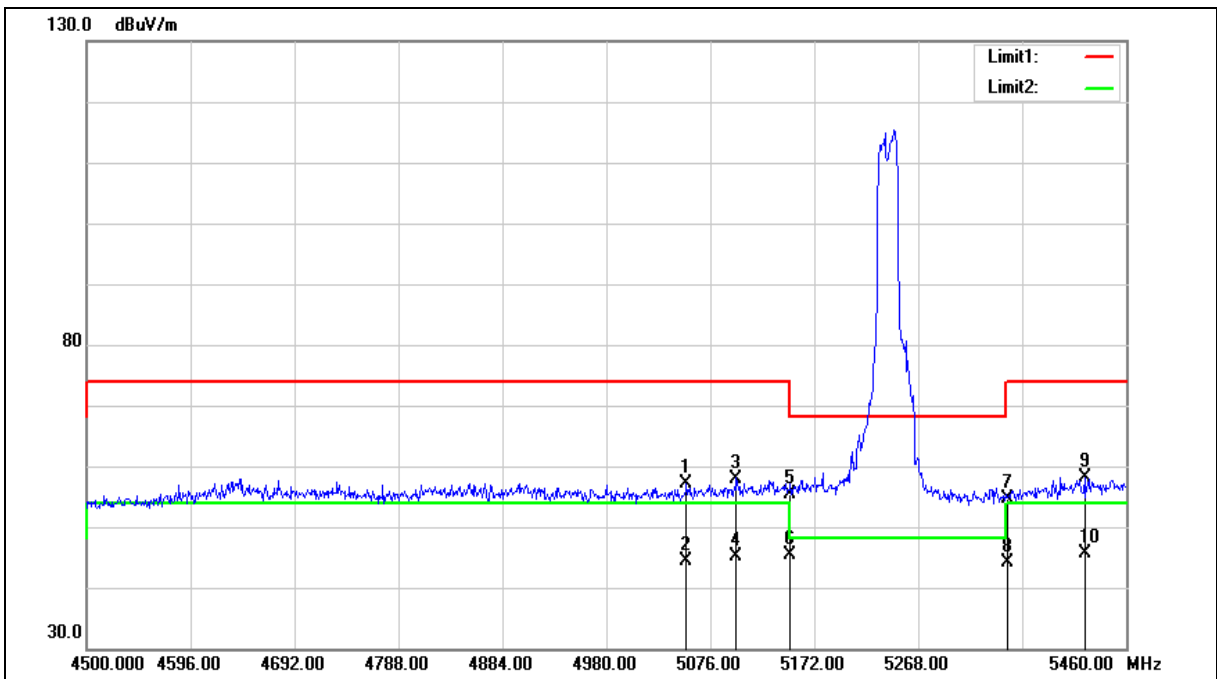



Standard:	FCC Part 15.407	Test Distance:	3 m
Test item:	Band edge	Power:	AC 120 V/60 Hz
Frequency:	5240 MHz	Temp.(°C)/Hum.(%RH):	26(°C)/60 %RH
Mode:	Mode 2		
Ant.Polar.:	Horizontal		

No.	Frequency (MHz)	Reading (dBuV)	Correct Factor (dB/m)	Result (dBuV/m)	Limit (dBuV/m)	Margin (dB)	Remark
1	5053.920	51.01	6.03	57.04	74.00	-16.96	peak
2	5053.920	38.42	6.03	44.45	54.00	-9.55	AVG
3	5100.000	51.85	6.15	58.00	74.00	-16.00	peak
4	5100.000	38.95	6.15	45.10	54.00	-8.90	AVG
5	5150.000	49.05	6.27	55.32	74.00	-18.68	peak
6	5150.000	39.12	6.27	45.39	54.00	-8.61	AVG
7	5350.000	48.01	6.74	54.75	74.00	-19.25	peak
8	5350.000	37.31	6.74	44.05	54.00	-9.95	AVG
9	5421.600	51.19	6.92	58.11	74.00	-15.89	peak
10	5421.600	38.78	6.92	45.70	54.00	-8.30	AVG

Note:1.Result (dBuV/m) = Correct Factor (dB/m) + Reading(dBuV).

2.Correction factor (dB/m) = Antenna Factor (dB/m) + Cable loss (dB) – Pre-Amplifier gain (dB).

3.When the peak results are less than average limit, there is no need to evaluate the average.

4.The average measurement was not performed when the peak measured data is under the limit of average detection.

5.The emission level of other frequencies is much lower than the limit and not shown in test report.



Standard:	FCC Part 15.407	Test Distance:	3 m
Test item:	Band edge	Power:	AC 120 V/60 Hz
Frequency:	5240 MHz	Temp.(°C)/Hum.(%RH):	26(°C)/60 %RH
Mode:	Mode 2		
Ant.Polar.:	Vertical		

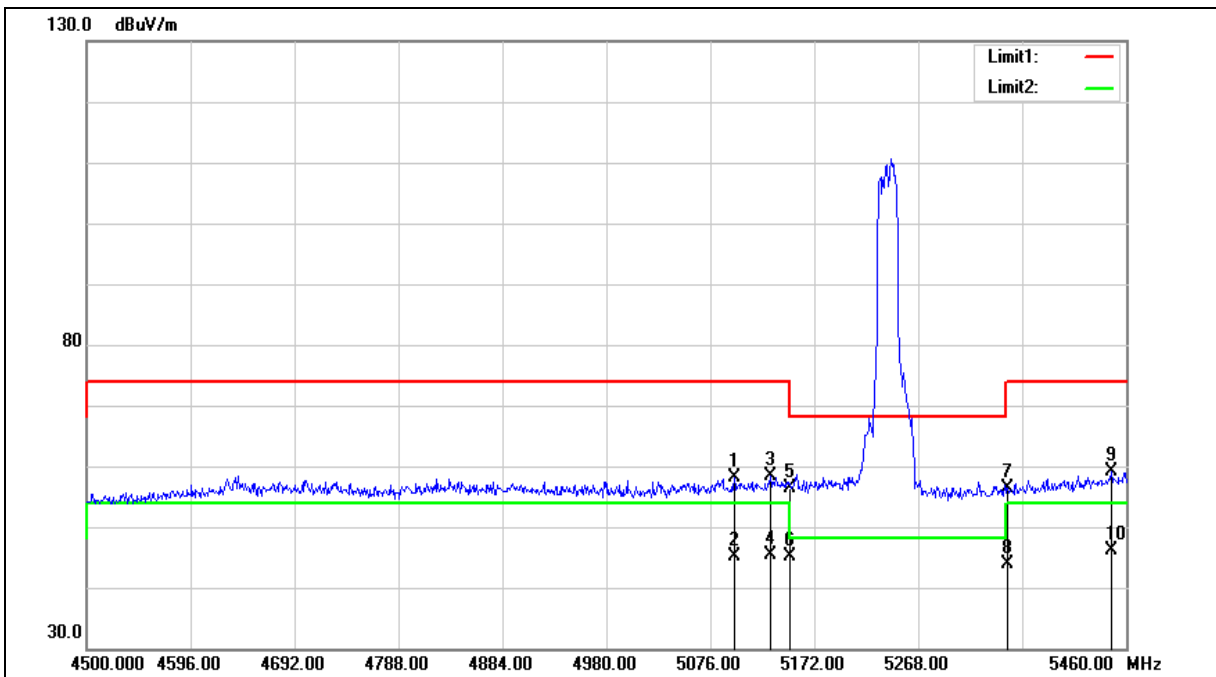



Standard:	FCC Part 15.407	Test Distance:	3 m
Test item:	Band edge	Power:	AC 120 V/60 Hz
Frequency:	5240 MHz	Temp.(°C)/Hum.(%RH):	26(°C)/60 %RH
Mode:	Mode 2		
Ant.Polar.:	Vertical		

No.	Frequency (MHz)	Reading (dBuV)	Correct Factor (dB/m)	Result (dBuV/m)	Limit (dBuV/m)	Margin (dB)	Remark
1	5098.080	51.91	6.15	58.06	74.00	-15.94	peak
2	5098.080	38.89	6.15	45.04	54.00	-8.96	AVG
3	5131.680	52.21	6.22	58.43	74.00	-15.57	peak
4	5131.680	39.18	6.22	45.40	54.00	-8.60	AVG
5	5150.000	50.10	6.27	56.37	74.00	-17.63	peak
6	5150.000	38.90	6.27	45.17	54.00	-8.83	AVG
7	5350.000	49.53	6.74	56.27	74.00	-17.73	peak
8	5350.000	37.22	6.74	43.96	54.00	-10.04	AVG
9	5446.560	52.11	6.98	59.09	74.00	-14.91	peak
10	5446.560	39.07	6.98	46.05	54.00	-7.95	AVG

Note:1.Result (dBuV/m) = Correct Factor (dB/m) + Reading(dBuV).

2.Correction factor (dB/m) = Antenna Factor (dB/m) + Cable loss (dB) – Pre-Amplifier gain (dB).

3.When the peak results are less than average limit, there is no need to evaluate the average.

4.The average measurement was not performed when the peak measured data is under the limit of average detection.

5.The emission level of other frequencies is much lower than the limit and not shown in test report.



Standard:	FCC Part 15.407	Test Distance:	3 m
Test item:	Band edge	Power:	AC 120 V/60 Hz
Frequency:	5745 MHz	Temp.(°C)/Hum.(%RH):	26(°C)/60 %RH
Mode:	Mode 2		
Ant.Polar.:	Horizontal		

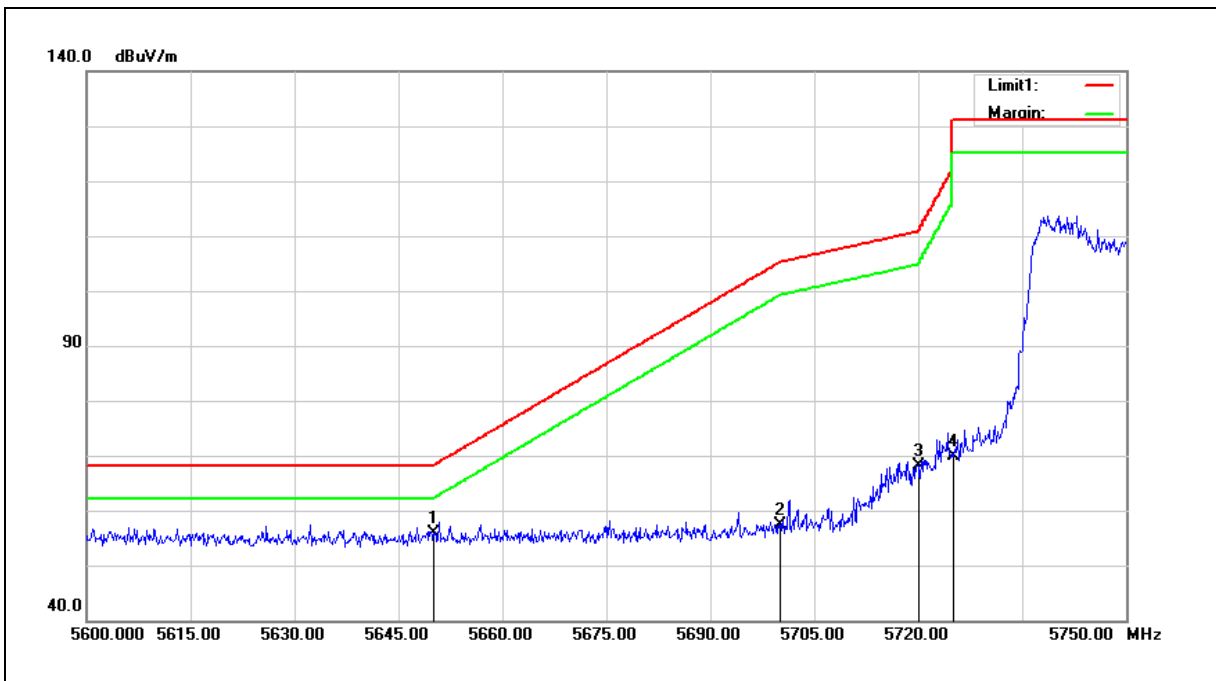

No.	Frequency (MHz)	Reading (dBuV)	Correct Factor (dB/m)	Result (dBuV/m)	Limit (dBuV/m)	Margin (dB)	Remark
1	5650.000	48.42	7.42	55.84	68.20	-12.36	peak
2	5700.000	49.91	7.52	57.43	105.20	-47.77	peak
3	5720.000	60.47	7.56	68.03	110.80	-42.77	peak
4	5725.000	62.19	7.57	69.76	122.20	-52.44	peak

Note:1.Result (dBuV/m) = Correct Factor (dB/m) + Reading(dBuV).

2.Correction factor (dB/m) = Antenna Factor (dB/m) + Cable loss (dB) – Pre-Amplifier gain (dB).

3.When the peak results are less than average limit, there is no need to evaluate the average.

4.The average measurement was not performed when the peak measured data is under the limit of average detection.

5.The emission level of other frequencies is much lower than the limit and not shown in test report.



Standard:	FCC Part 15.407	Test Distance:	3 m
Test item:	Band edge	Power:	AC 120 V/60 Hz
Frequency:	5745 MHz	Temp.(°C)/Hum.(%RH):	26(°C)/60 %RH
Mode:	Mode 2		
Ant.Polar.:	Vertical		

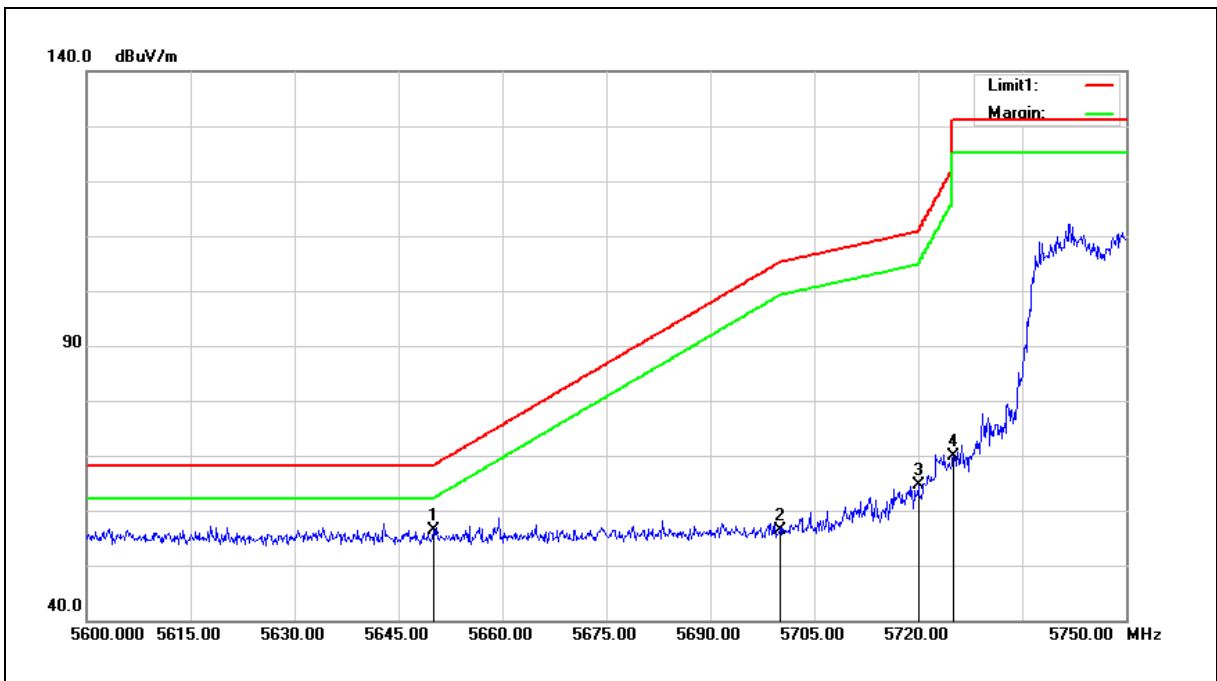

No.	Frequency (MHz)	Reading (dBuV)	Correct Factor (dB/m)	Result (dBuV/m)	Limit (dBuV/m)	Margin (dB)	Remark
1	5650.000	48.98	7.42	56.40	68.20	-11.80	peak
2	5700.000	48.92	7.52	56.44	105.20	-48.76	peak
3	5720.000	56.97	7.56	64.53	110.80	-46.27	peak
4	5725.000	62.38	7.57	69.95	122.20	-52.25	peak

Note:1.Result (dBuV/m) = Correct Factor (dB/m) + Reading(dBuV).

2.Correction factor (dB/m) = Antenna Factor (dB/m) + Cable loss (dB) – Pre-Amplifier gain (dB).

3.When the peak results are less than average limit, there is no need to evaluate the average.

4.The average measurement was not performed when the peak measured data is under the limit of average detection.

5.The emission level of other frequencies is much lower than the limit and not shown in test report.



Standard:	FCC Part 15.407	Test Distance:	3 m
Test item:	Band edge	Power:	AC 120 V/60 Hz
Frequency:	5785 MHz	Temp.(°C)/Hum.(%RH):	26(°C)/60 %RH
Mode:	Mode 2		
Ant.Polar.:	Horizontal		

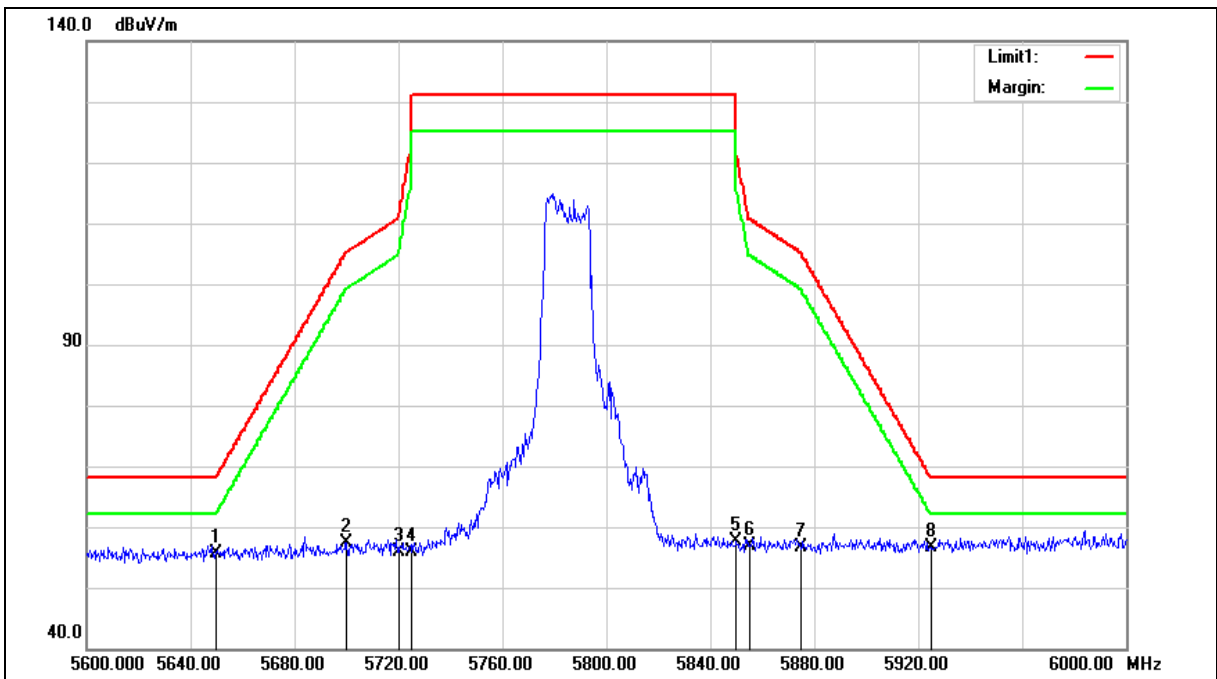



Standard:	FCC Part 15.407	Test Distance:	3 m
Test item:	Band edge	Power:	AC 120 V/60 Hz
Frequency:	5785 MHz	Temp.(°C)/Hum.(%RH):	26(°C)/60 %RH
Mode:	Mode 2		
Ant.Polar.:	Horizontal		

No.	Frequency (MHz)	Reading (dBuV)	Correct Factor (dB/m)	Result (dBuV/m)	Limit (dBuV/m)	Margin (dB)	Remark
1	5650.000	48.30	7.42	55.72	68.20	-12.48	peak
2	5700.000	49.94	7.52	57.46	105.20	-47.74	peak
3	5720.000	48.26	7.56	55.82	110.80	-54.98	peak
4	5725.000	48.39	7.57	55.96	122.20	-66.24	peak
5	5850.000	49.77	7.83	57.60	122.20	-64.60	peak
6	5855.000	49.00	7.85	56.85	110.80	-53.95	peak
7	5875.000	48.77	7.88	56.65	105.20	-48.55	peak
8	5925.000	48.52	8.00	56.52	68.20	-11.68	peak

Note:1.Result (dBuV/m) = Correct Factor (dB/m) + Reading(dBuV).

2.Correction factor (dB/m) = Antenna Factor (dB/m) + Cable loss (dB) – Pre-Amplifier gain (dB).

3.When the peak results are less than average limit, there is no need to evaluate the average.

4.The average measurement was not performed when the peak measured data is under the limit of average detection.

5.The emission level of other frequencies is much lower than the limit and not shown in test report.



Standard:	FCC Part 15.407	Test Distance:	3 m
Test item:	Band edge	Power:	AC 120 V/60 Hz
Frequency:	5785 MHz	Temp.(°C)/Hum.(%RH):	26(°C)/60 %RH
Mode:	Mode 2		
Ant.Polar.:	Vertical		

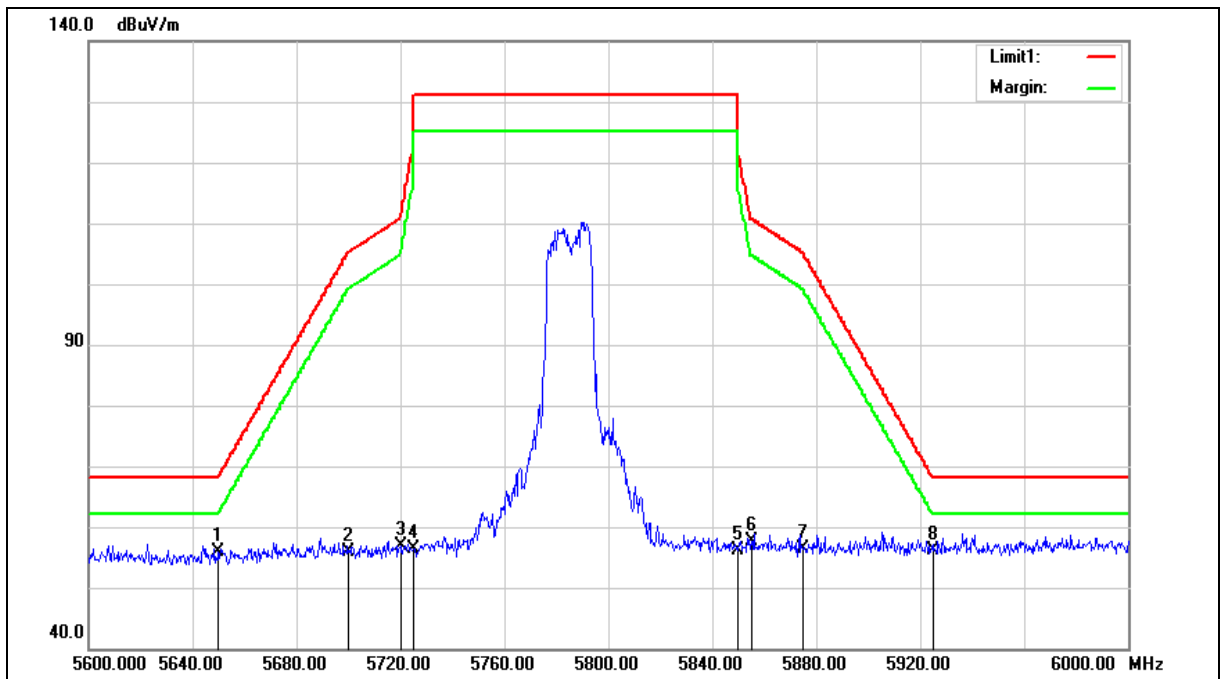



Standard:	FCC Part 15.407	Test Distance:	3 m
Test item:	Band edge	Power:	AC 120 V/60 Hz
Frequency:	5785 MHz	Temp.(°C)/Hum.(%RH):	26(°C)/60 %RH
Mode:	Mode 2		
Ant.Polar.:	Vertical		

No.	Frequency (MHz)	Reading (dBuV)	Correct Factor (dB/m)	Result (dBuV/m)	Limit (dBuV/m)	Margin (dB)	Remark
1	5650.000	48.52	7.42	55.94	68.20	-12.26	peak
2	5700.000	48.47	7.52	55.99	105.20	-49.21	peak
3	5720.000	49.29	7.56	56.85	110.80	-53.95	peak
4	5725.000	48.70	7.57	56.27	122.20	-65.93	peak
5	5850.000	48.33	7.83	56.16	122.20	-66.04	peak
6	5855.000	49.89	7.85	57.74	110.80	-53.06	peak
7	5875.000	48.42	7.88	56.30	105.20	-48.90	peak
8	5925.000	48.15	8.00	56.15	68.20	-12.05	peak

Note:1.Result (dBuV/m) = Correct Factor (dB/m) + Reading(dBuV).

2.Correction factor (dB/m) = Antenna Factor (dB/m) + Cable loss (dB) – Pre-Amplifier gain (dB).

3.When the peak results are less than average limit, there is no need to evaluate the average.

4.The average measurement was not performed when the peak measured data is under the limit of average detection.

5.The emission level of other frequencies is much lower than the limit and not shown in test report.



Standard:	FCC Part 15.407	Test Distance:	3 m
Test item:	Band edge	Power:	AC 120 V/60 Hz
Frequency:	5825 MHz	Temp.(°C)/Hum.(%RH):	26(°C)/60 %RH
Mode:	Mode 2		
Ant.Polar.:	Horizontal		

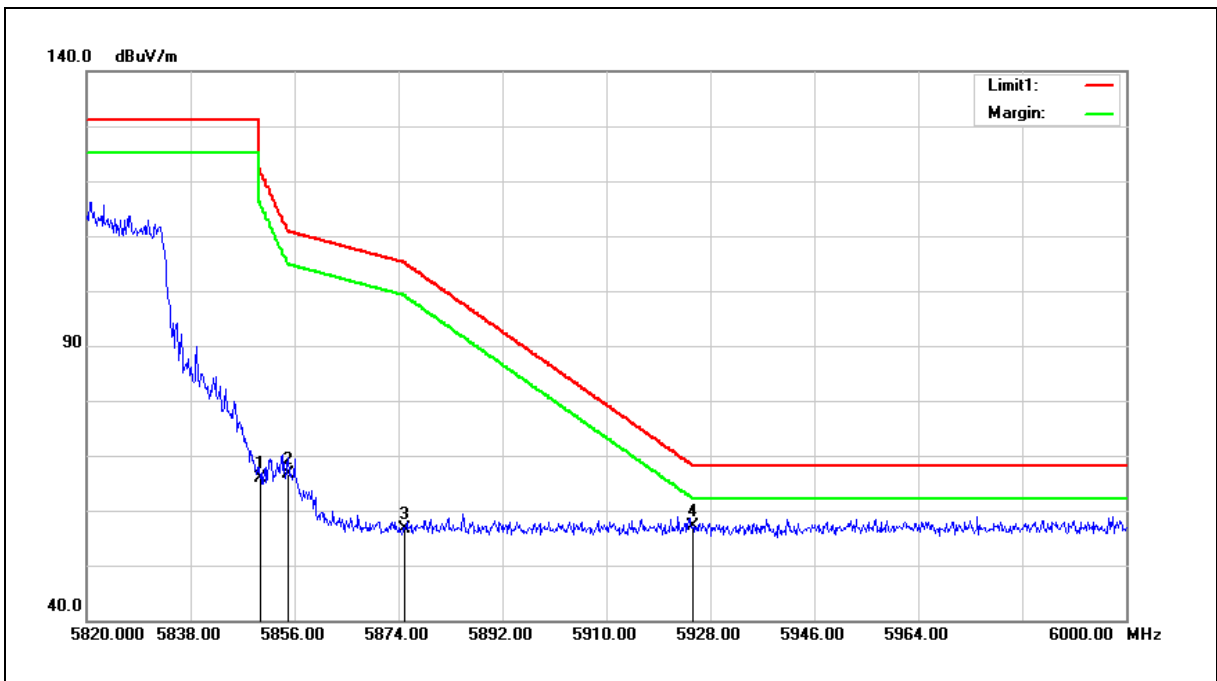

No.	Frequency (MHz)	Reading (dBuV)	Correct Factor (dB/m)	Result (dBuV/m)	Limit (dBuV/m)	Margin (dB)	Remark
1	5850.000	57.94	7.83	65.77	122.20	-56.43	peak
2	5855.000	58.66	7.85	66.51	110.80	-44.29	peak
3	5875.000	48.78	7.88	56.66	105.20	-48.54	peak
4	5925.000	49.09	8.00	57.09	68.20	-11.11	peak

Note:1.Result (dBuV/m) = Correct Factor (dB/m) + Reading(dBuV).

2.Correction factor (dB/m) = Antenna Factor (dB/m) + Cable loss (dB) – Pre-Amplifier gain (dB).

3.When the peak results are less than average limit, there is no need to evaluate the average.

4.The average measurement was not performed when the peak measured data is under the limit of average detection.

5.The emission level of other frequencies is much lower than the limit and not shown in test report.



Standard:	FCC Part 15.407	Test Distance:	3 m
Test item:	Band edge	Power:	AC 120 V/60 Hz
Frequency:	5825 MHz	Temp.(°C)/Hum.(%RH):	26(°C)/60 %RH
Mode:	Mode 2		
Ant.Polar.:	Vertical		

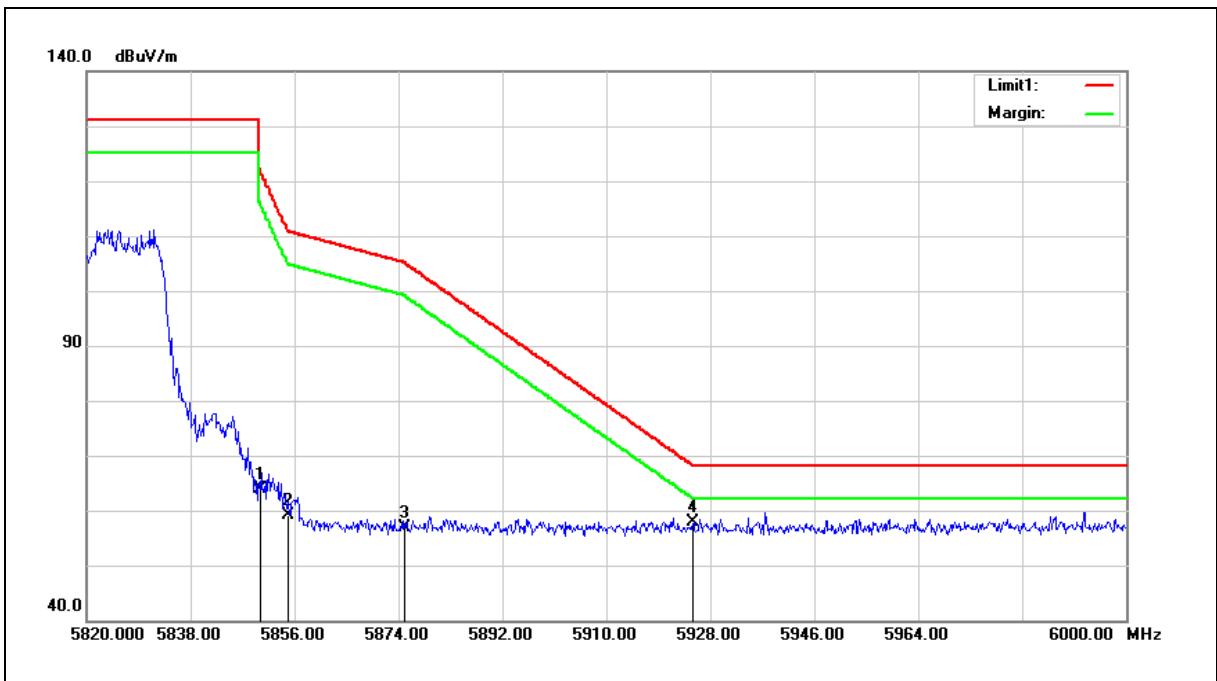

No.	Frequency (MHz)	Reading (dBuV)	Correct Factor (dB/m)	Result (dBuV/m)	Limit (dBuV/m)	Margin (dB)	Remark
1	5850.000	56.00	7.83	63.83	122.20	-58.37	peak
2	5855.000	51.36	7.85	59.21	110.80	-51.59	peak
3	5875.000	48.97	7.88	56.85	105.20	-48.35	peak
4	5925.000	49.83	8.00	57.83	68.20	-10.37	peak

Note:1.Result (dBuV/m) = Correct Factor (dB/m) + Reading(dBuV).

2.Correction factor (dB/m) = Antenna Factor (dB/m) + Cable loss (dB) – Pre-Amplifier gain (dB).

3.When the peak results are less than average limit, there is no need to evaluate the average.

4.The average measurement was not performed when the peak measured data is under the limit of average detection.

5.The emission level of other frequencies is much lower than the limit and not shown in test report.



Standard:	FCC Part 15.407	Test Distance:	3 m
Test item:	Band edge	Power:	AC 120 V/60 Hz
Frequency:	5180 MHz	Temp.(°C)/Hum.(%RH):	26(°C)/60 %RH
Mode:	Mode 5		
Ant.Polar.:	Horizontal		

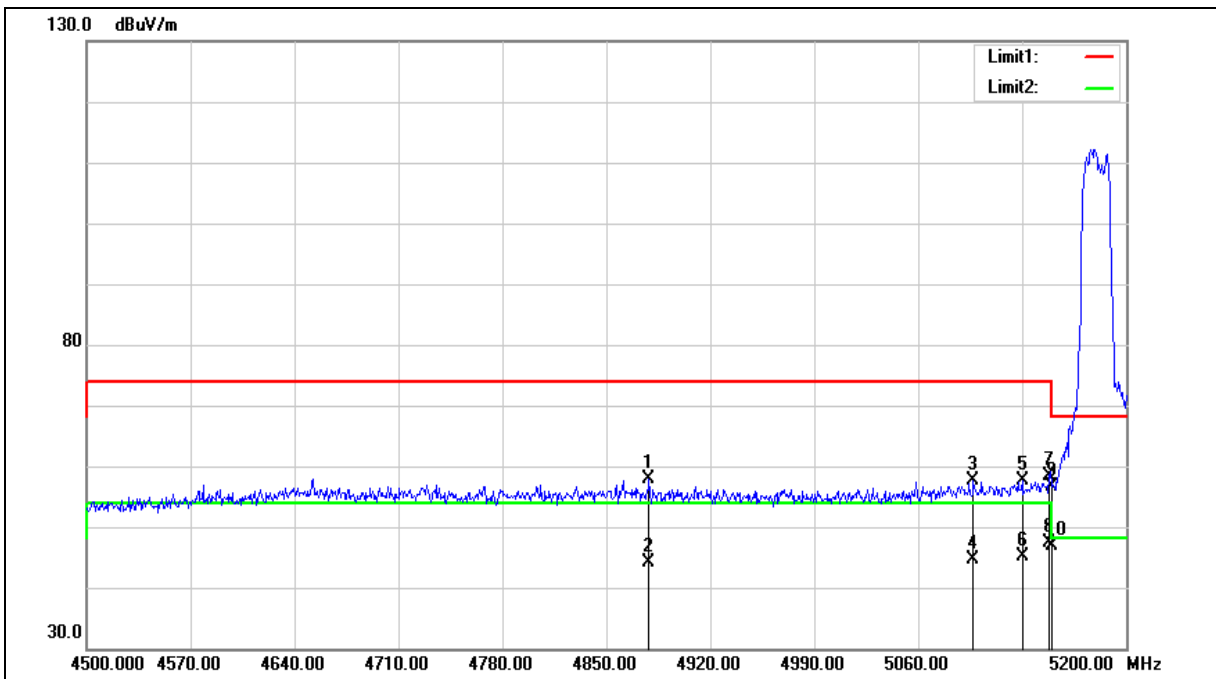



Standard:	FCC Part 15.407	Test Distance:	3 m
Test item:	Band edge	Power:	AC 120 V/60 Hz
Frequency:	5180 MHz	Temp.(°C)/Hum.(%RH):	26(°C)/60 %RH
Mode:	Mode 5		
Ant.Polar.:	Horizontal		

No.	Frequency (MHz)	Reading (dBuV)	Correct Factor (dB/m)	Result (dBuV/m)	Limit (dBuV/m)	Margin (dB)	Remark
1	4878.700	52.08	5.68	57.76	74.00	-16.24	peak
2	4878.700	38.39	5.68	44.07	54.00	-9.93	AVG
3	5097.100	51.36	6.15	57.51	74.00	-16.49	peak
4	5097.100	38.41	6.15	44.56	54.00	-9.44	AVG
5	5130.000	51.31	6.22	57.53	74.00	-16.47	peak
6	5130.000	39.02	6.22	45.24	54.00	-8.76	AVG
7	5148.200	52.00	6.26	58.26	74.00	-15.74	peak
8	5148.200	41.04	6.26	47.30	54.00	-6.70	AVG
9	5150.000	50.44	6.27	56.71	74.00	-17.29	peak
10	5150.000	40.51	6.27	46.78	54.00	-7.22	AVG

Note:1.Result (dBuV/m) = Correct Factor (dB/m) + Reading(dBuV).

2.Correction factor (dB/m) = Antenna Factor (dB/m) + Cable loss (dB) – Pre-Amplifier gain (dB).

3.When the peak results are less than average limit, there is no need to evaluate the average.

4.The average measurement was not performed when the peak measured data is under the limit of average detection.

5.The emission level of other frequencies is much lower than the limit and not shown in test report.



Standard:	FCC Part 15.407	Test Distance:	3 m
Test item:	Band edge	Power:	AC 120 V/60 Hz
Frequency:	5180 MHz	Temp.(°C)/Hum.(%RH):	26(°C)/60 %RH
Mode:	Mode 5		
Ant.Polar.:	Vertical		

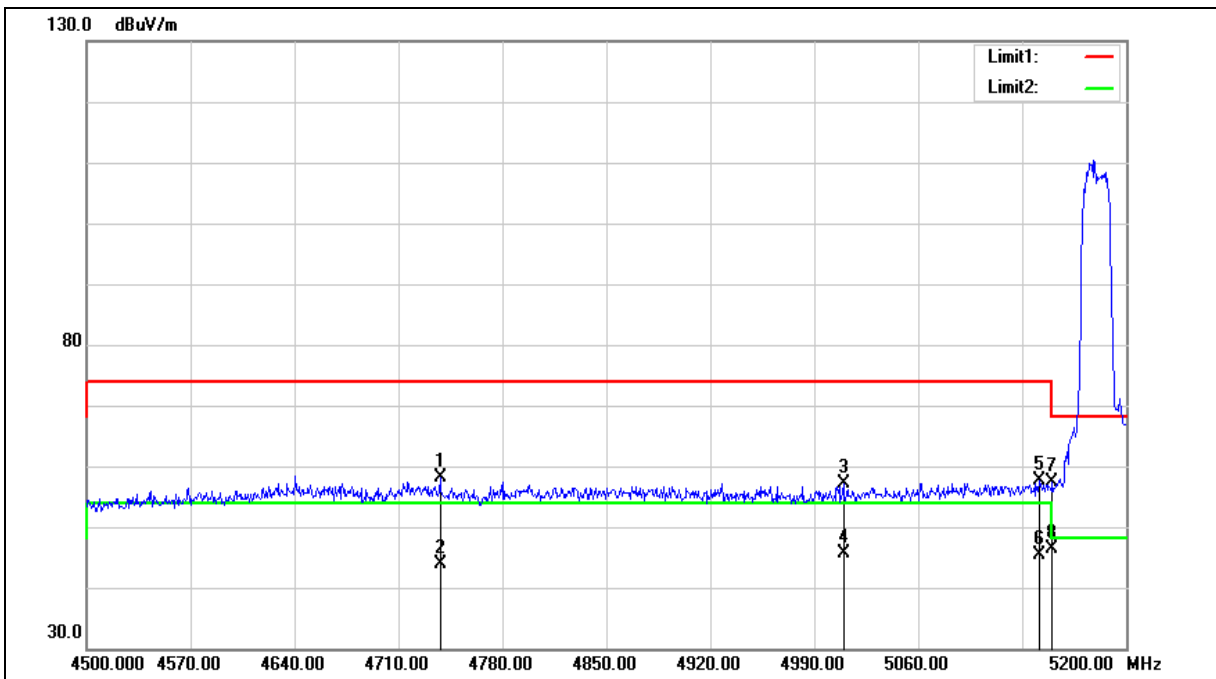



Standard:	FCC Part 15.407	Test Distance:	3 m
Test item:	Band edge	Power:	AC 120 V/60 Hz
Frequency:	5180 MHz	Temp.(°C)/Hum.(%RH):	26(°C)/60 %RH
Mode:	Mode 5		
Ant.Polar.:	Vertical		

No.	Frequency (MHz)	Reading (dBuV)	Correct Factor (dB/m)	Result (dBuV/m)	Limit (dBuV/m)	Margin (dB)	Remark
1	4738.000	52.72	5.41	58.13	74.00	-15.87	peak
2	4738.000	38.37	5.41	43.78	54.00	-10.22	AVG
3	5009.600	51.09	5.93	57.02	74.00	-16.98	peak
4	5009.600	39.64	5.93	45.57	54.00	-8.43	AVG
5	5141.200	51.46	6.25	57.71	74.00	-16.29	peak
6	5141.200	39.07	6.25	45.32	54.00	-8.68	AVG
7	5150.000	51.11	6.27	57.38	74.00	-16.62	peak
8	5150.000	40.18	6.27	46.45	54.00	-7.55	AVG

Note:1.Result (dBuV/m) = Correct Factor (dB/m) + Reading(dBuV).

2.Correction factor (dB/m) = Antenna Factor (dB/m) + Cable loss (dB) – Pre-Amplifier gain (dB).

3.When the peak results are less than average limit, there is no need to evaluate the average.

4.The average measurement was not performed when the peak measured data is under the limit of average detection.

5.The emission level of other frequencies is much lower than the limit and not shown in test report.



Standard:	FCC Part 15.407	Test Distance:	3 m
Test item:	Band edge	Power:	AC 120 V/60 Hz
Frequency:	5200 MHz	Temp.(°C)/Hum.(%RH):	26(°C)/60 %RH
Mode:	Mode 5		
Ant.Polar.:	Horizontal		

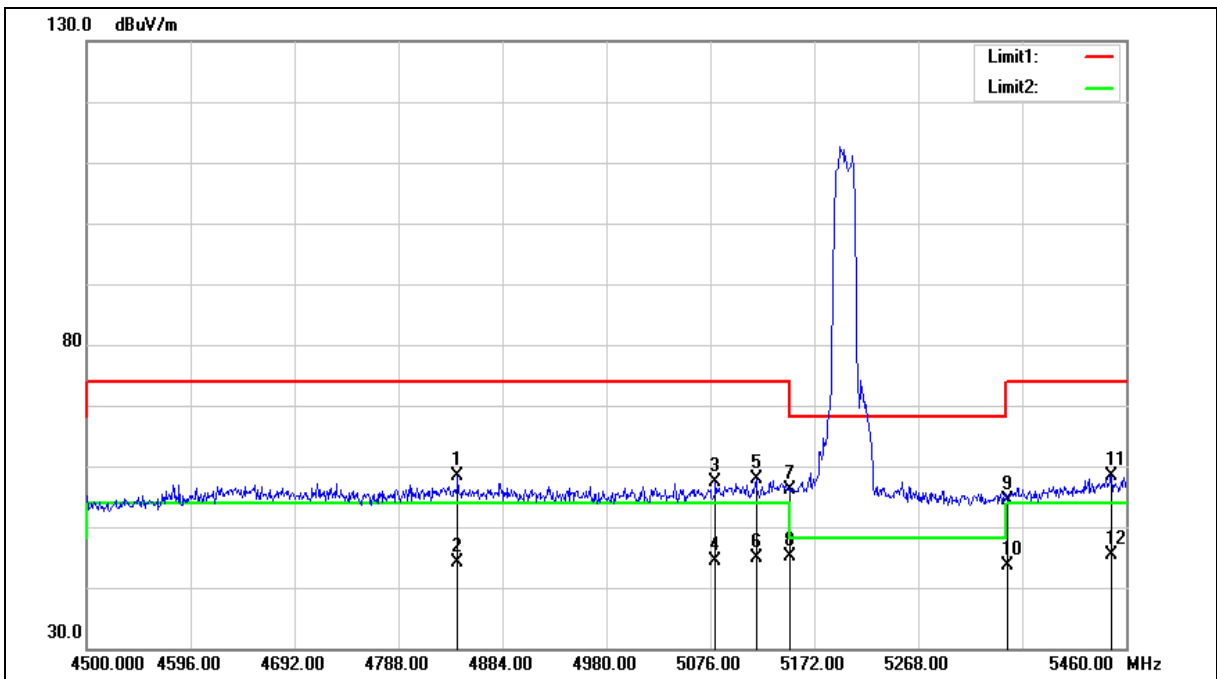



Standard:	FCC Part 15.407	Test Distance:	3 m
Test item:	Band edge	Power:	AC 120 V/60 Hz
Frequency:	5200 MHz	Temp.(°C)/Hum.(%RH):	26(°C)/60 %RH
Mode:	Mode 5		
Ant.Polar.:	Horizontal		

No.	Frequency (MHz)	Reading (dBuV)	Correct Factor (dB/m)	Result (dBuV/m)	Limit (dBuV/m)	Margin (dB)	Remark
1	4842.720	52.71	5.62	58.33	74.00	-15.67	peak
2	4842.720	38.52	5.62	44.14	54.00	-9.86	AVG
3	5080.800	51.37	6.10	57.47	74.00	-16.53	peak
4	5080.800	38.19	6.10	44.29	54.00	-9.71	AVG
5	5118.240	51.64	6.20	57.84	74.00	-16.16	peak
6	5118.240	38.59	6.20	44.79	54.00	-9.21	AVG
7	5150.000	49.74	6.27	56.01	74.00	-17.99	peak
8	5150.000	38.81	6.27	45.08	54.00	-8.92	AVG
9	5350.000	47.67	6.74	54.41	74.00	-19.59	peak
10	5350.000	36.82	6.74	43.56	54.00	-10.44	AVG
11	5446.560	51.43	6.98	58.41	74.00	-15.59	peak
12	5446.560	38.40	6.98	45.38	54.00	-8.62	AVG

Note:1.Result (dBuV/m) = Correct Factor (dB/m) + Reading(dBuV).

2.Correction factor (dB/m) = Antenna Factor (dB/m) + Cable loss (dB) – Pre-Amplifier gain (dB).

3.When the peak results are less than average limit, there is no need to evaluate the average.

4.The average measurement was not performed when the peak measured data is under the limit of average detection.

5.The emission level of other frequencies is much lower than the limit and not shown in test report.



Standard:	FCC Part 15.407	Test Distance:	3 m
Test item:	Band edge	Power:	AC 120 V/60 Hz
Frequency:	5200 MHz	Temp.(°C)/Hum.(%RH):	26(°C)/60 %RH
Mode:	Mode 5		
Ant.Polar.:	Vertical		

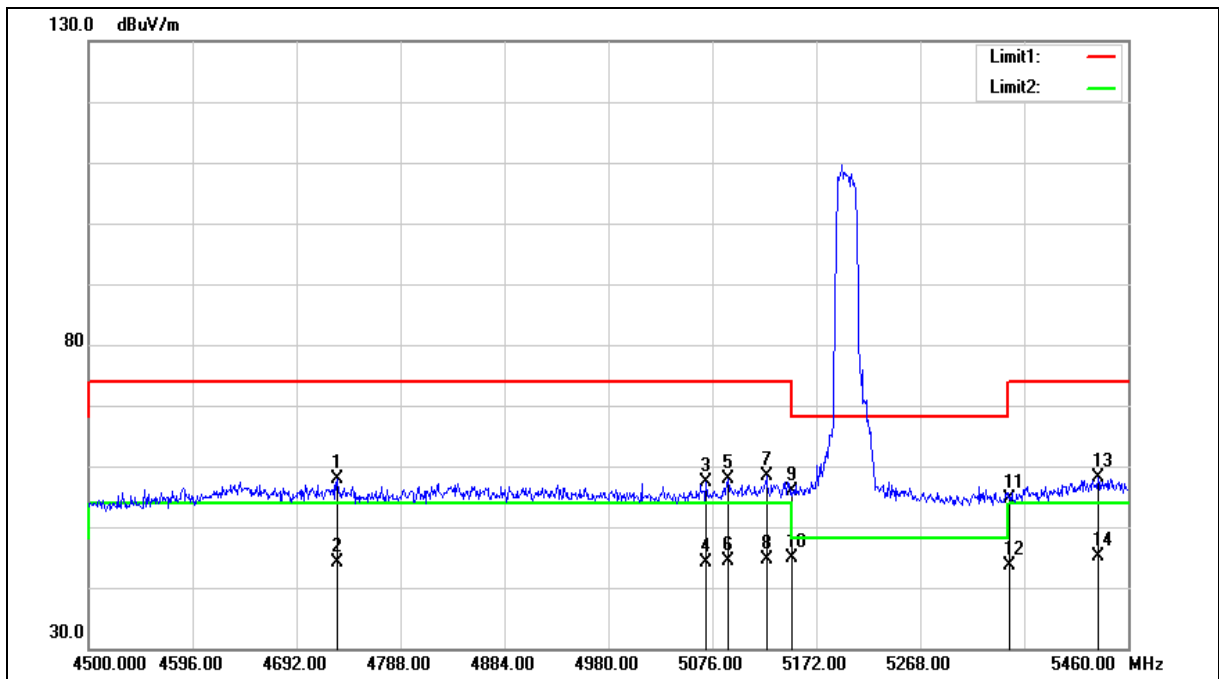



Standard:	FCC Part 15.407	Test Distance:	3 m
Test item:	Band edge	Power:	AC 120 V/60 Hz
Frequency:	5200 MHz	Temp.(°C)/Hum.(%RH):	26(°C)/60 %RH
Mode:	Mode 5		
Ant.Polar.:	Vertical		

No.	Frequency (MHz)	Reading (dBUV)	Correct Factor (dB/m)	Result (dBUV/m)	Limit (dBUV/m)	Margin (dB)	Remark
1	4729.440	52.60	5.39	57.99	74.00	-16.01	peak
2	4729.440	38.65	5.39	44.04	54.00	-9.96	AVG
3	5070.240	51.22	6.07	57.29	74.00	-16.71	peak
4	5070.240	38.07	6.07	44.14	54.00	-9.86	AVG
5	5090.400	51.65	6.13	57.78	74.00	-16.22	peak
6	5090.400	38.21	6.13	44.34	54.00	-9.66	AVG
7	5125.920	52.24	6.21	58.45	74.00	-15.55	peak
8	5125.920	38.52	6.21	44.73	54.00	-9.27	AVG
9	5150.000	49.50	6.27	55.77	74.00	-18.23	peak
10	5150.000	38.63	6.27	44.90	54.00	-9.10	AVG
11	5350.000	47.81	6.74	54.55	74.00	-19.45	peak
12	5350.000	36.78	6.74	43.52	54.00	-10.48	AVG
13	5432.160	51.27	6.94	58.21	74.00	-15.79	peak
14	5432.160	38.25	6.94	45.19	54.00	-8.81	AVG

Note:1.Result (dBUV/m) = Correct Factor (dB/m) + Reading(dBUV).

2.Correction factor (dB/m) = Antenna Factor (dB/m) + Cable loss (dB) – Pre-Amplifier gain (dB).

3.When the peak results are less than average limit, there is no need to evaluate the average.

4.The average measurement was not performed when the peak measured data is under the limit of average detection.

5.The emission level of other frequencies is much lower than the limit and not shown in test report.



Standard:	FCC Part 15.407	Test Distance:	3 m
Test item:	Band edge	Power:	AC 120 V/60 Hz
Frequency:	5240 MHz	Temp.(°C)/Hum.(%RH):	26(°C)/60 %RH
Mode:	Mode 5		
Ant.Polar.:	Horizontal		

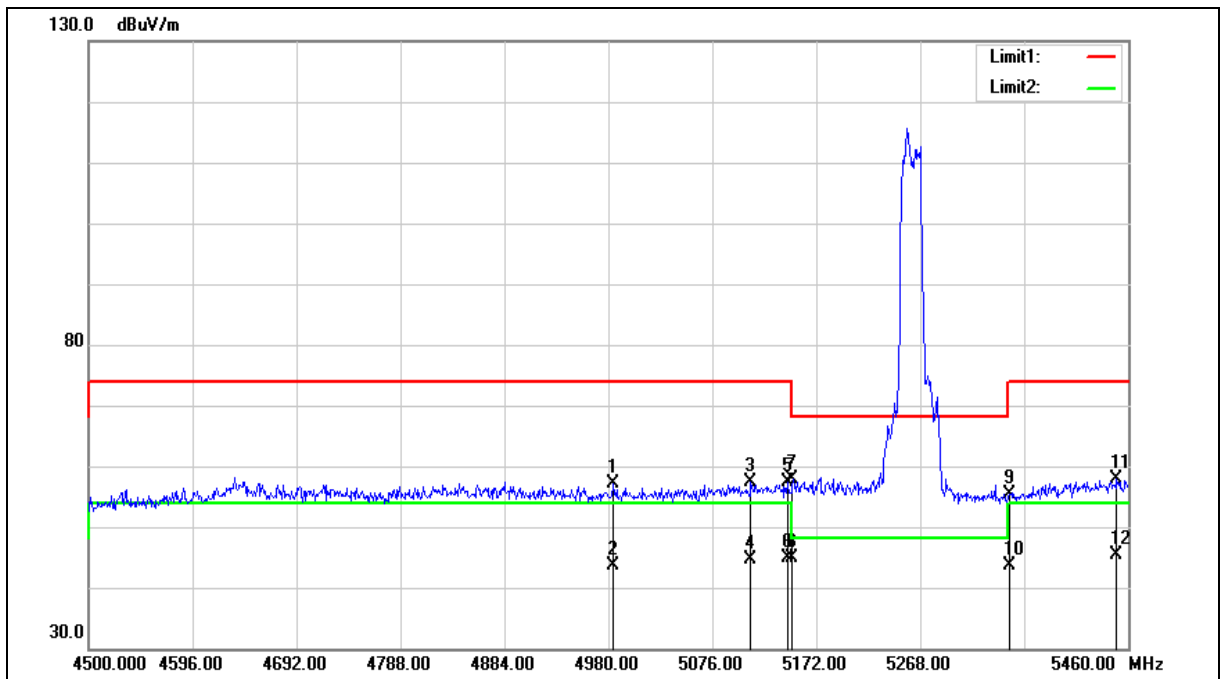



Standard:	FCC Part 15.407	Test Distance:	3 m
Test item:	Band edge	Power:	AC 120 V/60 Hz
Frequency:	5240 MHz	Temp.(°C)/Hum.(%RH):	26(°C)/60 %RH
Mode:	Mode 5		
Ant.Polar.:	Horizontal		

No.	Frequency (MHz)	Reading (dBUV)	Correct Factor (dB/m)	Result (dBUV/m)	Limit (dBUV/m)	Margin (dB)	Remark
1	4984.800	51.27	5.88	57.15	74.00	-16.85	peak
2	4984.800	37.79	5.88	43.67	54.00	-10.33	AVG
3	5111.520	51.17	6.17	57.34	74.00	-16.66	peak
4	5111.520	38.44	6.17	44.61	54.00	-9.39	AVG
5	5145.120	51.19	6.26	57.45	74.00	-16.55	peak
6	5145.120	38.66	6.26	44.92	54.00	-9.08	AVG
7	5150.000	51.72	6.27	57.99	74.00	-16.01	peak
8	5150.000	38.60	6.27	44.87	54.00	-9.13	AVG
9	5350.000	48.56	6.74	55.30	74.00	-18.70	peak
10	5350.000	37.00	6.74	43.74	54.00	-10.26	AVG
11	5449.440	50.92	6.98	57.90	74.00	-16.10	peak
12	5449.440	38.46	6.98	45.44	54.00	-8.56	AVG

Note:1.Result (dBUV/m) = Correct Factor (dB/m) + Reading(dBUV).

2.Correction factor (dB/m) = Antenna Factor (dB/m) + Cable loss (dB) – Pre-Amplifier gain (dB).

3.When the peak results are less than average limit, there is no need to evaluate the average.

4.The average measurement was not performed when the peak measured data is under the limit of average detection.

5.The emission level of other frequencies is much lower than the limit and not shown in test report.



Standard:	FCC Part 15.407	Test Distance:	3 m
Test item:	Band edge	Power:	AC 120 V/60 Hz
Frequency:	5240 MHz	Temp.(°C)/Hum.(%RH):	26(°C)/60 %RH
Mode:	Mode 5		
Ant.Polar.:	Vertical		

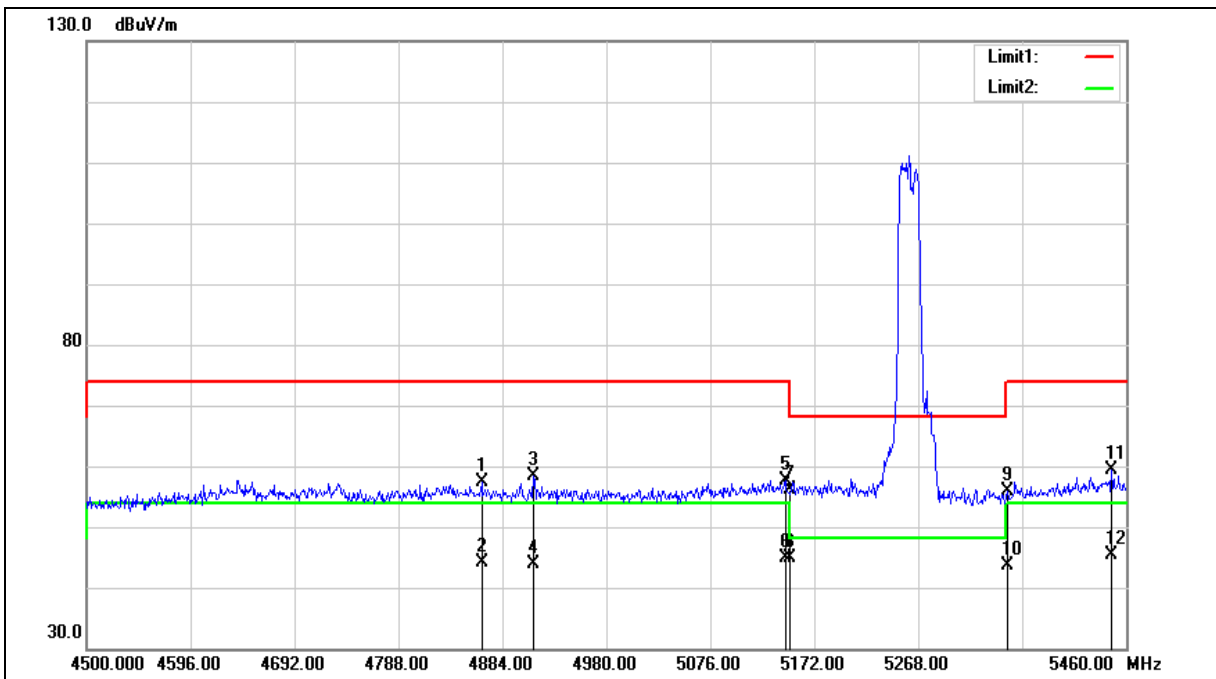



Standard:	FCC Part 15.407	Test Distance:	3 m
Test item:	Band edge	Power:	AC 120 V/60 Hz
Frequency:	5240 MHz	Temp.(°C)/Hum.(%RH):	26(°C)/60 %RH
Mode:	Mode 5		
Ant.Polar.:	Vertical		

No.	Frequency (MHz)	Reading (dBuV)	Correct Factor (dB/m)	Result (dBuV/m)	Limit (dBuV/m)	Margin (dB)	Remark
1	4864.800	51.65	5.65	57.30	74.00	-16.70	peak
2	4864.800	38.56	5.65	44.21	54.00	-9.79	AVG
3	4912.800	52.55	5.75	58.30	74.00	-15.70	peak
4	4912.800	38.20	5.75	43.95	54.00	-10.05	AVG
5	5145.120	51.43	6.26	57.69	74.00	-16.31	peak
6	5145.120	38.51	6.26	44.77	54.00	-9.23	AVG
7	5150.000	49.82	6.27	56.09	74.00	-17.91	peak
8	5150.000	38.51	6.27	44.78	54.00	-9.22	AVG
9	5350.000	49.03	6.74	55.77	74.00	-18.23	peak
10	5350.000	36.81	6.74	43.55	54.00	-10.45	AVG
11	5446.560	52.51	6.98	59.49	74.00	-14.51	peak
12	5446.560	38.36	6.98	45.34	54.00	-8.66	AVG

Note:1.Result (dBuV/m) = Correct Factor (dB/m) + Reading(dBuV).

2.Correction factor (dB/m) = Antenna Factor (dB/m) + Cable loss (dB) – Pre-Amplifier gain (dB).

3.When the peak results are less than average limit, there is no need to evaluate the average.

4.The average measurement was not performed when the peak measured data is under the limit of average detection.

5.The emission level of other frequencies is much lower than the limit and not shown in test report.



Standard:	FCC Part 15.407	Test Distance:	3 m
Test item:	Band edge	Power:	AC 120 V/60 Hz
Frequency:	5745 MHz	Temp.(°C)/Hum.(%RH):	26(°C)/60 %RH
Mode:	Mode 5		
Ant.Polar.:	Horizontal		

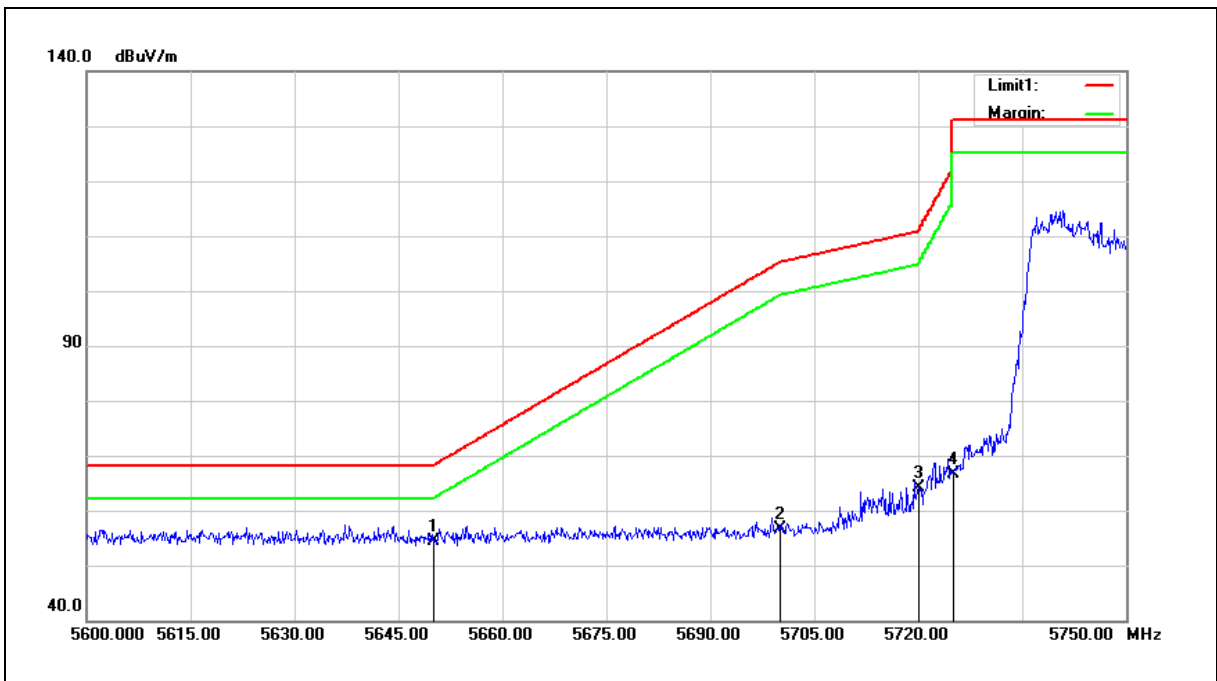

No.	Frequency (MHz)	Reading (dBuV)	Correct Factor (dB/m)	Result (dBuV/m)	Limit (dBuV/m)	Margin (dB)	Remark
1	5650.000	46.93	7.42	54.35	68.20	-13.85	peak
2	5700.000	49.00	7.52	56.52	105.20	-48.68	peak
3	5720.000	56.58	7.56	64.14	110.80	-46.66	peak
4	5725.000	59.05	7.57	66.62	122.20	-55.58	peak

Note:1.Result (dBuV/m) = Correct Factor (dB/m) + Reading(dBuV).

2.Correction factor (dB/m) = Antenna Factor (dB/m) + Cable loss (dB) – Pre-Amplifier gain (dB).

3.When the peak results are less than average limit, there is no need to evaluate the average.

4.The average measurement was not performed when the peak measured data is under the limit of average detection.

5.The emission level of other frequencies is much lower than the limit and not shown in test report.



Standard:	FCC Part 15.407	Test Distance:	3 m
Test item:	Band edge	Power:	AC 120 V/60 Hz
Frequency:	5745 MHz	Temp.(°C)/Hum.(%RH):	26(°C)/60 %RH
Mode:	Mode 5		
Ant.Polar.:	Vertical		

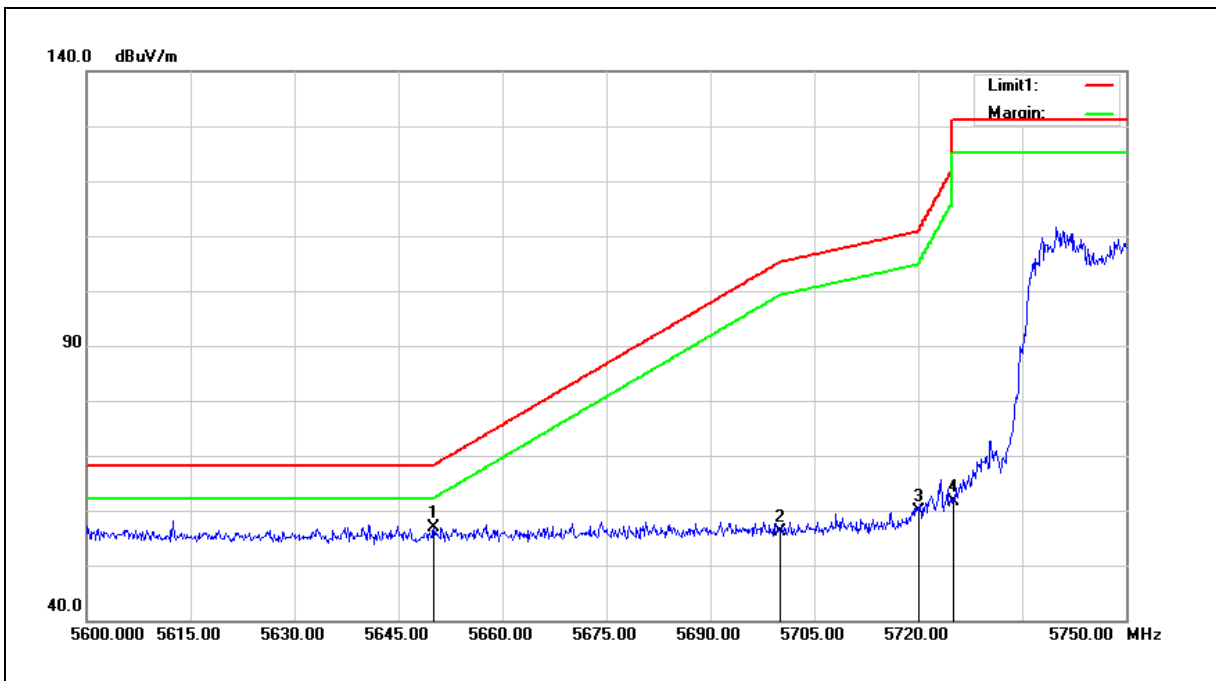

No.	Frequency (MHz)	Reading (dBuV)	Correct Factor (dB/m)	Result (dBuV/m)	Limit (dBuV/m)	Margin (dB)	Remark
1	5650.000	49.46	7.42	56.88	68.20	-11.32	peak
2	5700.000	48.51	7.52	56.03	105.20	-49.17	peak
3	5720.000	52.41	7.56	59.97	110.80	-50.83	peak
4	5725.000	54.04	7.57	61.61	122.20	-60.59	peak

Note:1.Result (dBuV/m) = Correct Factor (dB/m) + Reading(dBuV).

2.Correction factor (dB/m) = Antenna Factor (dB/m) + Cable loss (dB) – Pre-Amplifier gain (dB).

3.When the peak results are less than average limit, there is no need to evaluate the average.

4.The average measurement was not performed when the peak measured data is under the limit of average detection.

5.The emission level of other frequencies is much lower than the limit and not shown in test report.



Standard:	FCC Part 15.407	Test Distance:	3 m
Test item:	Band edge	Power:	AC 120 V/60 Hz
Frequency:	5785 MHz	Temp.(°C)/Hum.(%RH):	26(°C)/60 %RH
Mode:	Mode 5		
Ant.Polar.:	Horizontal		

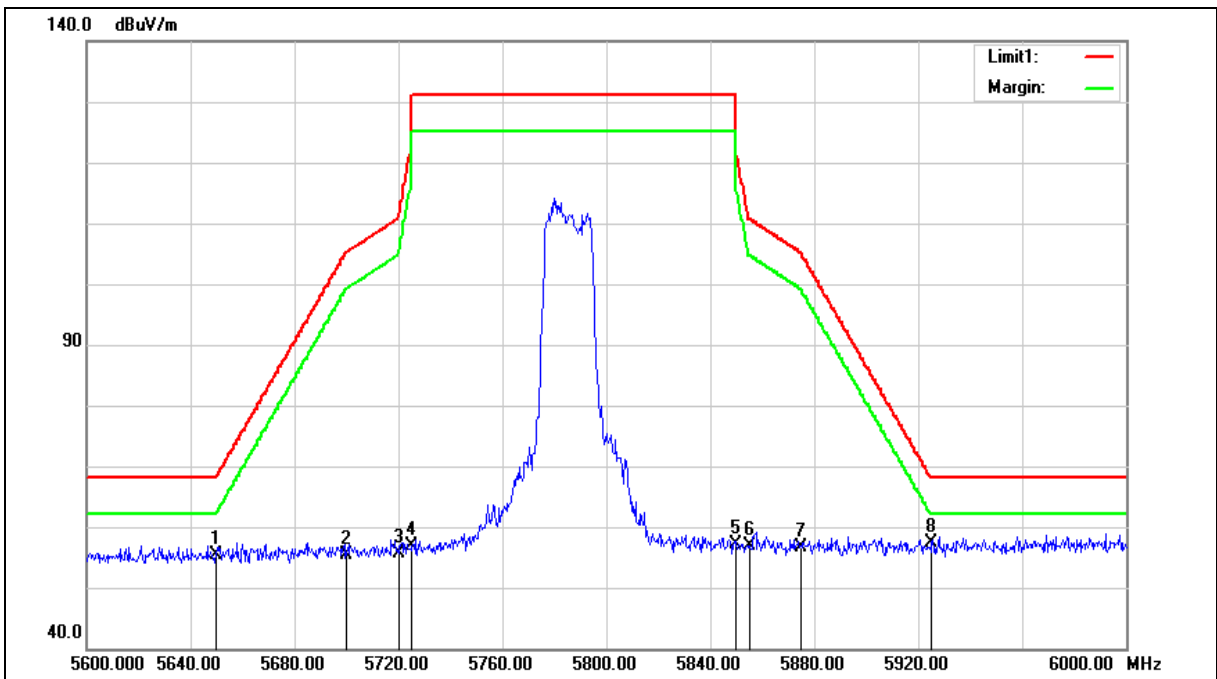



Standard:	FCC Part 15.407	Test Distance:	3 m
Test item:	Band edge	Power:	AC 120 V/60 Hz
Frequency:	5785 MHz	Temp.(°C)/Hum.(%RH):	26(°C)/60 %RH
Mode:	Mode 5		
Ant.Polar.:	Horizontal		

No.	Frequency (MHz)	Reading (dBuV)	Correct Factor (dB/m)	Result (dBuV/m)	Limit (dBuV/m)	Margin (dB)	Remark
1	5650.000	48.03	7.42	55.45	68.20	-12.75	peak
2	5700.000	47.90	7.52	55.42	105.20	-49.78	peak
3	5720.000	48.18	7.56	55.74	110.80	-55.06	peak
4	5725.000	49.30	7.57	56.87	122.20	-65.33	peak
5	5850.000	49.36	7.83	57.19	122.20	-65.01	peak
6	5855.000	48.95	7.85	56.80	110.80	-54.00	peak
7	5875.000	48.74	7.88	56.62	105.20	-48.58	peak
8	5925.000	49.30	8.00	57.30	68.20	-10.90	peak

Note:1.Result (dBuV/m) = Correct Factor (dB/m) + Reading(dBuV).

2.Correction factor (dB/m) = Antenna Factor (dB/m) + Cable loss (dB) – Pre-Amplifier gain (dB).

3.When the peak results are less than average limit, there is no need to evaluate the average.

4.The average measurement was not performed when the peak measured data is under the limit of average detection.

5.The emission level of other frequencies is much lower than the limit and not shown in test report.



Standard:	FCC Part 15.407	Test Distance:	3 m
Test item:	Band edge	Power:	AC 120 V/60 Hz
Frequency:	5785 MHz	Temp.(°C)/Hum.(%RH):	26(°C)/60 %RH
Mode:	Mode 5		
Ant.Polar.:	Vertical		

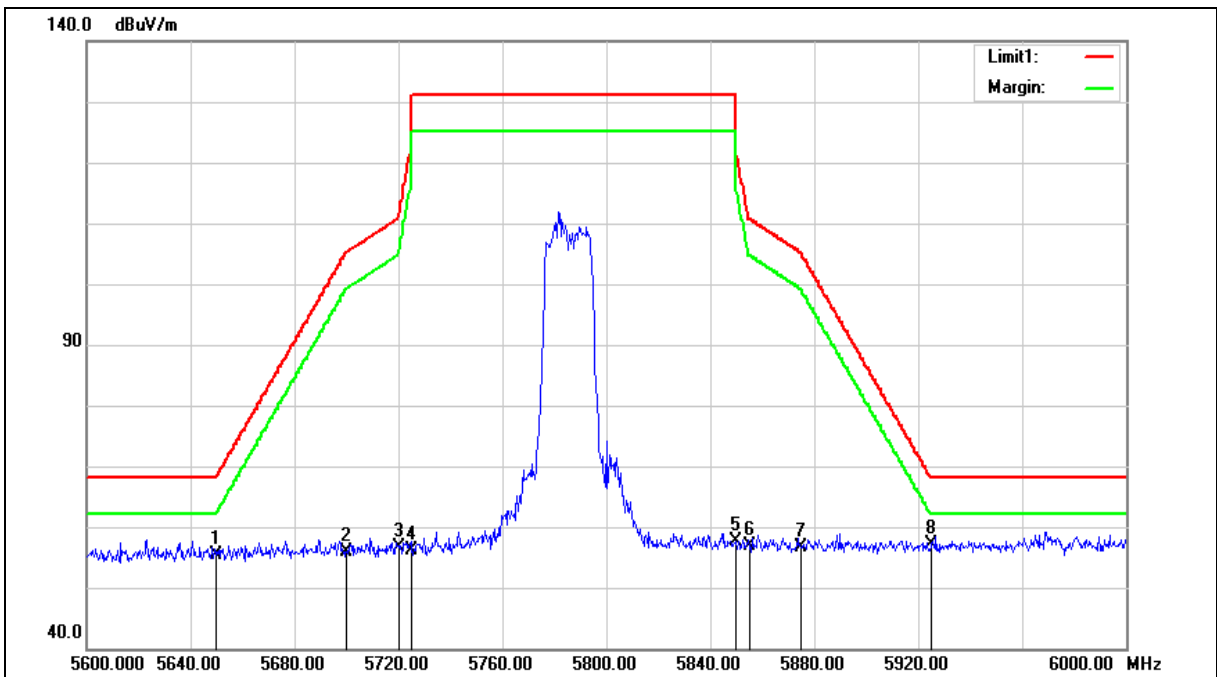



Standard:	FCC Part 15.407	Test Distance:	3 m
Test item:	Band edge	Power:	AC 120 V/60 Hz
Frequency:	5785 MHz	Temp.(°C)/Hum.(%RH):	26(°C)/60 %RH
Mode:	Mode 5		
Ant.Polar.:	Vertical		

No.	Frequency (MHz)	Reading (dBuV)	Correct Factor (dB/m)	Result (dBuV/m)	Limit (dBuV/m)	Margin (dB)	Remark
1	5650.000	48.02	7.42	55.44	68.20	-12.76	peak
2	5700.000	48.38	7.52	55.90	105.20	-49.30	peak
3	5720.000	49.17	7.56	56.73	110.80	-54.07	peak
4	5725.000	48.54	7.57	56.11	122.20	-66.09	peak
5	5850.000	49.75	7.83	57.58	122.20	-64.62	peak
6	5855.000	49.04	7.85	56.89	110.80	-53.91	peak
7	5875.000	48.65	7.88	56.53	105.20	-48.67	peak
8	5925.000	49.04	8.00	57.04	68.20	-11.16	peak

Note:1.Result (dBuV/m) = Correct Factor (dB/m) + Reading(dBuV).

2.Correction factor (dB/m) = Antenna Factor (dB/m) + Cable loss (dB) – Pre-Amplifier gain (dB).

3.When the peak results are less than average limit, there is no need to evaluate the average.

4.The average measurement was not performed when the peak measured data is under the limit of average detection.

5.The emission level of other frequencies is much lower than the limit and not shown in test report.



Standard:	FCC Part 15.407	Test Distance:	3 m
Test item:	Band edge	Power:	AC 120 V/60 Hz
Frequency:	5825 MHz	Temp.(°C)/Hum.(%RH):	26(°C)/60 %RH
Mode:	Mode 5		
Ant.Polar.:	Horizontal		

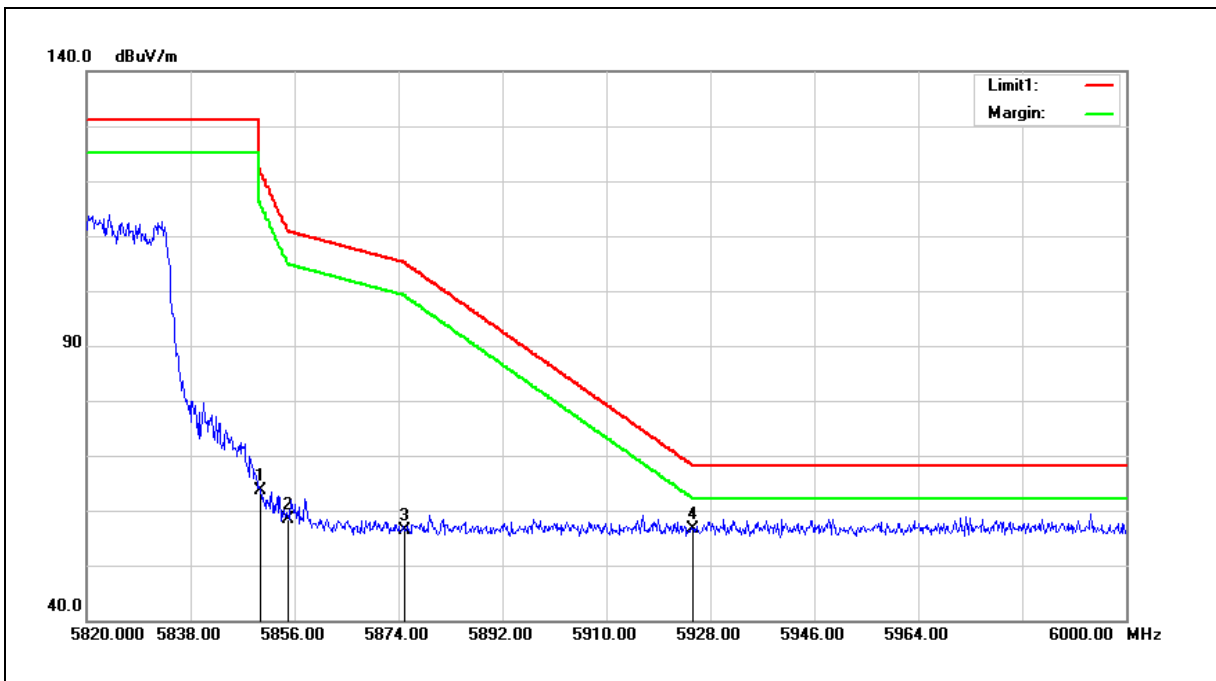

No.	Frequency (MHz)	Reading (dBuV)	Correct Factor (dB/m)	Result (dBuV/m)	Limit (dBuV/m)	Margin (dB)	Remark
1	5850.000	55.86	7.83	63.69	122.20	-58.51	peak
2	5855.000	50.44	7.85	58.29	110.80	-52.51	peak
3	5875.000	48.54	7.88	56.42	105.20	-48.78	peak
4	5925.000	48.67	8.00	56.67	68.20	-11.53	peak

Note:1.Result (dBuV/m) = Correct Factor (dB/m) + Reading(dBuV).

2.Correction factor (dB/m) = Antenna Factor (dB/m) + Cable loss (dB) – Pre-Amplifier gain (dB).

3.When the peak results are less than average limit, there is no need to evaluate the average.

4.The average measurement was not performed when the peak measured data is under the limit of average detection.

5.The emission level of other frequencies is much lower than the limit and not shown in test report.



Standard:	FCC Part 15.407	Test Distance:	3 m
Test item:	Band edge	Power:	AC 120 V/60 Hz
Frequency:	5825 MHz	Temp.(°C)/Hum.(%RH):	26(°C)/60 %RH
Mode:	Mode 5		
Ant.Polar.:	Vertical		

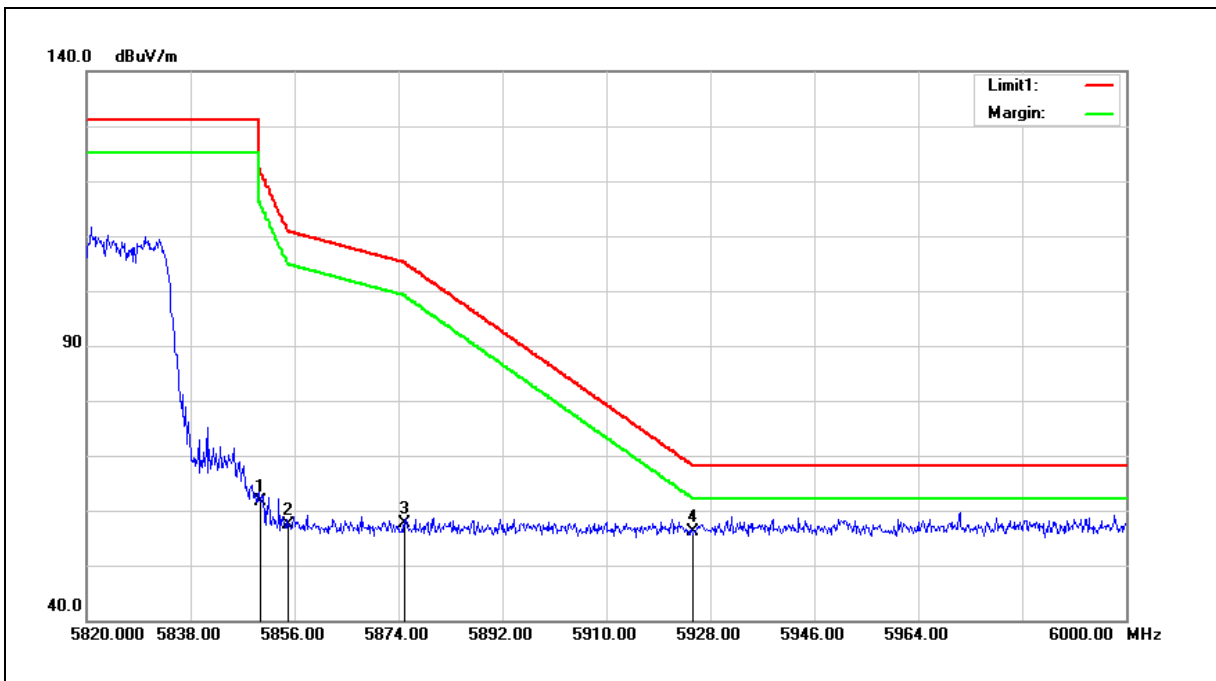

No.	Frequency (MHz)	Reading (dBuV)	Correct Factor (dB/m)	Result (dBuV/m)	Limit (dBuV/m)	Margin (dB)	Remark
1	5850.000	53.83	7.83	61.66	122.20	-60.54	peak
2	5855.000	49.59	7.85	57.44	110.80	-53.36	peak
3	5875.000	49.82	7.88	57.70	105.20	-47.50	peak
4	5925.000	48.25	8.00	56.25	68.20	-11.95	peak

Note:1.Result (dBuV/m) = Correct Factor (dB/m) + Reading(dBuV).

2.Correction factor (dB/m) = Antenna Factor (dB/m) + Cable loss (dB) – Pre-Amplifier gain (dB).

3.When the peak results are less than average limit, there is no need to evaluate the average.

4.The average measurement was not performed when the peak measured data is under the limit of average detection.

5.The emission level of other frequencies is much lower than the limit and not shown in test report.



Standard:	FCC Part 15.407	Test Distance:	3 m
Test item:	Band edge	Power:	AC 120 V/60 Hz
Frequency:	5190 MHz	Temp.(°C)/Hum.(%RH):	26(°C)/60 %RH
Mode:	Mode 6		
Ant.Polar.:	Horizontal		

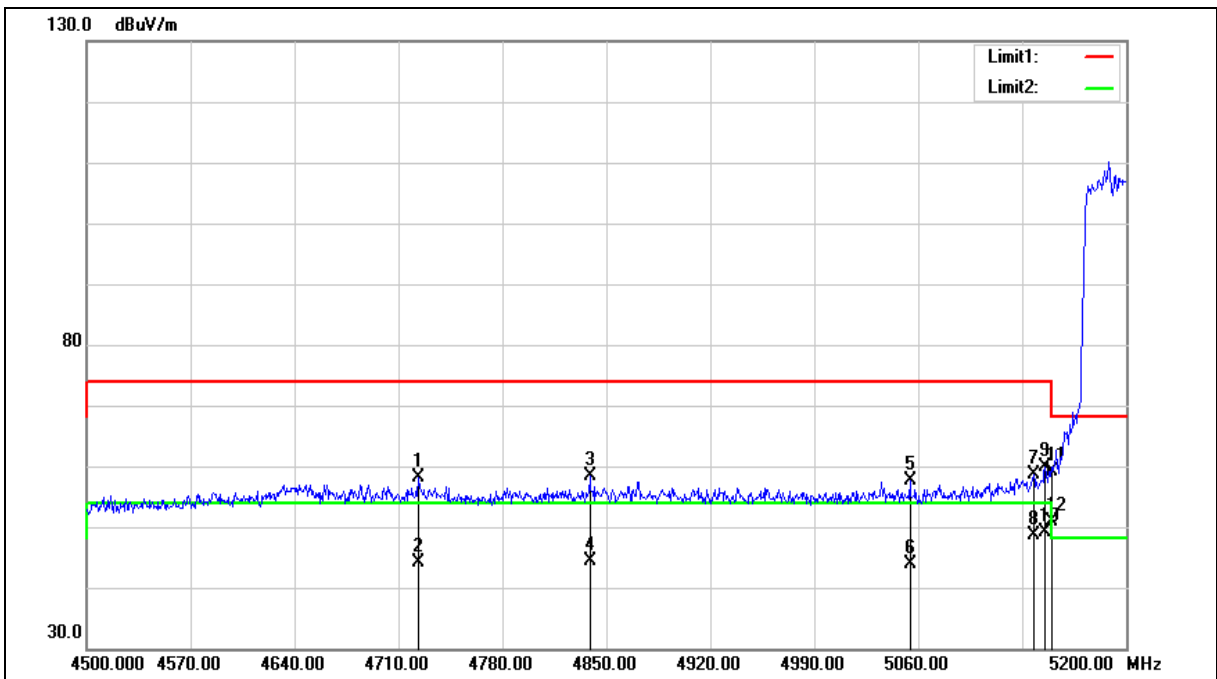



Standard:	FCC Part 15.407	Test Distance:	3 m
Test item:	Band edge	Power:	AC 120 V/60 Hz
Frequency:	5190 MHz	Temp.(°C)/Hum.(%RH):	26(°C)/60 %RH
Mode:	Mode 6		
Ant.Polar.:	Horizontal		

No.	Frequency (MHz)	Reading (dBuV)	Correct Factor (dB/m)	Result (dBuV/m)	Limit (dBuV/m)	Margin (dB)	Remark
1	4723.300	52.80	5.39	58.19	74.00	-15.81	peak
2	4723.300	38.64	5.39	44.03	54.00	-9.97	AVG
3	4838.800	52.83	5.61	58.44	74.00	-15.56	peak
4	4838.800	38.65	5.61	44.26	54.00	-9.74	AVG
5	5054.400	51.71	6.03	57.74	74.00	-16.26	peak
6	5054.400	37.93	6.03	43.96	54.00	-10.04	AVG
7	5137.700	52.46	6.24	58.70	74.00	-15.30	peak
8	5137.700	42.27	6.24	48.51	54.00	-5.49	AVG
9	5145.400	53.51	6.26	59.77	74.00	-14.23	peak
10	5145.400	42.94	6.26	49.20	54.00	-4.80	AVG
11	5150.000	52.91	6.27	59.18	74.00	-14.82	peak
12	5150.000	44.50	6.27	50.77	54.00	-3.23	AVG

Note:1.Result (dBuV/m) = Correct Factor (dB/m) + Reading(dBuV).

2.Correction factor (dB/m) = Antenna Factor (dB/m) + Cable loss (dB) – Pre-Amplifier gain (dB).

3.When the peak results are less than average limit, there is no need to evaluate the average.

4.The average measurement was not performed when the peak measured data is under the limit of average detection.

5.The emission level of other frequencies is much lower than the limit and not shown in test report.



Standard:	FCC Part 15.407	Test Distance:	3 m
Test item:	Band edge	Power:	AC 120 V/60 Hz
Frequency:	5190 MHz	Temp.(°C)/Hum.(%RH):	26(°C)/60 %RH
Mode:	Mode 6		
Ant.Polar.:	Vertical		

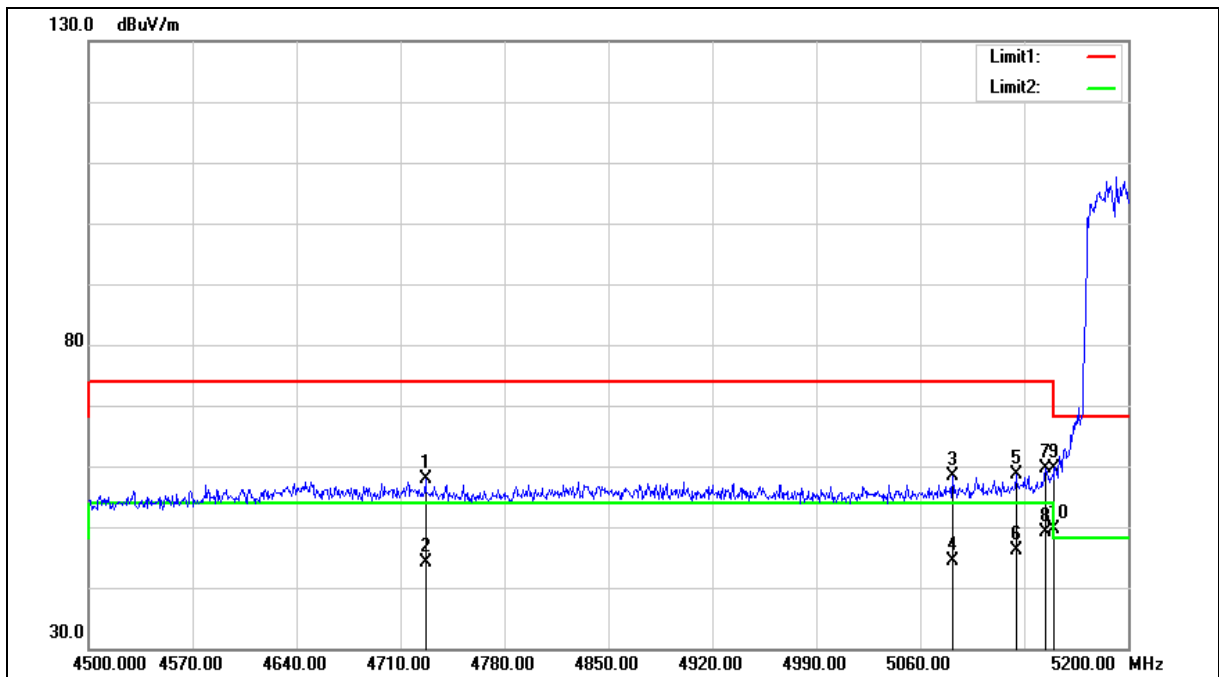



Standard:	FCC Part 15.407	Test Distance:	3 m
Test item:	Band edge	Power:	AC 120 V/60 Hz
Frequency:	5190 MHz	Temp.(°C)/Hum.(%RH):	26(°C)/60 %RH
Mode:	Mode 6		
Ant.Polar.:	Vertical		

No.	Frequency (MHz)	Reading (dBuV)	Correct Factor (dB/m)	Result (dBuV/m)	Limit (dBuV/m)	Margin (dB)	Remark
1	4726.800	52.54	5.39	57.93	74.00	-16.07	peak
2	4726.800	38.63	5.39	44.02	54.00	-9.98	AVG
3	5081.700	52.39	6.10	58.49	74.00	-15.51	peak
4	5081.700	38.19	6.10	44.29	54.00	-9.71	AVG
5	5124.400	52.37	6.21	58.58	74.00	-15.42	peak
6	5124.400	39.96	6.21	46.17	54.00	-7.83	AVG
7	5144.700	53.48	6.26	59.74	74.00	-14.26	peak
8	5144.700	42.98	6.26	49.24	54.00	-4.76	AVG
9	5150.000	53.44	6.27	59.71	74.00	-14.29	peak
10	5150.000	43.28	6.27	49.55	54.00	-4.45	AVG

Note:1.Result (dBuV/m) = Correct Factor (dB/m) + Reading(dBuV).

2.Correction factor (dB/m) = Antenna Factor (dB/m) + Cable loss (dB) – Pre-Amplifier gain (dB).

3.When the peak results are less than average limit, there is no need to evaluate the average.

4.The average measurement was not performed when the peak measured data is under the limit of average detection.

5.The emission level of other frequencies is much lower than the limit and not shown in test report.



Standard:	FCC Part 15.407	Test Distance:	3 m
Test item:	Band edge	Power:	AC 120 V/60 Hz
Frequency:	5230 MHz	Temp.(°C)/Hum.(%RH):	26(°C)/60 %RH
Mode:	Mode 6		
Ant.Polar.:	Horizontal		

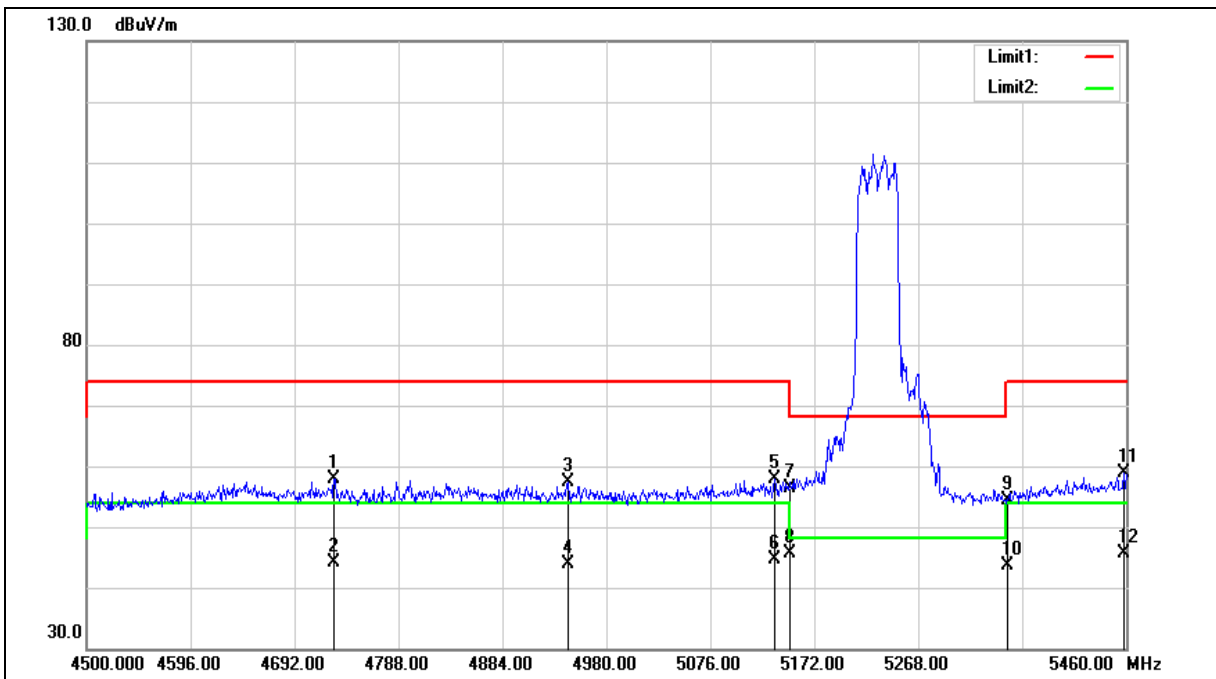



Standard:	FCC Part 15.407	Test Distance:	3 m
Test item:	Band edge	Power:	AC 120 V/60 Hz
Frequency:	5230 MHz	Temp.(°C)/Hum.(%RH):	26(°C)/60 %RH
Mode:	Mode 6		
Ant.Polar.:	Horizontal		

No.	Frequency (MHz)	Reading (dBuV)	Correct Factor (dB/m)	Result (dBuV/m)	Limit (dBuV/m)	Margin (dB)	Remark
1	4728.480	52.49	5.40	57.89	74.00	-16.11	peak
2	4728.480	38.68	5.40	44.08	54.00	-9.92	AVG
3	4944.480	51.58	5.80	57.38	74.00	-16.62	peak
4	4944.480	37.99	5.80	43.79	54.00	-10.21	AVG
5	5135.520	51.74	6.23	57.97	74.00	-16.03	peak
6	5135.520	38.50	6.23	44.73	54.00	-9.27	AVG
7	5150.000	50.22	6.27	56.49	74.00	-17.51	peak
8	5150.000	39.30	6.27	45.57	54.00	-8.43	AVG
9	5350.000	47.60	6.74	54.34	74.00	-19.66	peak
10	5350.000	36.93	6.74	43.67	54.00	-10.33	AVG
11	5458.080	51.77	7.00	58.77	74.00	-15.23	peak
12	5458.080	38.51	7.00	45.51	54.00	-8.49	AVG

Note:1.Result (dBuV/m) = Correct Factor (dB/m) + Reading(dBuV).

2.Correction factor (dB/m) = Antenna Factor (dB/m) + Cable loss (dB) – Pre-Amplifier gain (dB).

3.When the peak results are less than average limit, there is no need to evaluate the average.

4.The average measurement was not performed when the peak measured data is under the limit of average detection.

5.The emission level of other frequencies is much lower than the limit and not shown in test report.



Standard:	FCC Part 15.407	Test Distance:	3 m
Test item:	Band edge	Power:	AC 120 V/60 Hz
Frequency:	5230 MHz	Temp.(°C)/Hum.(%RH):	26(°C)/60 %RH
Mode:	Mode 6		
Ant.Polar.:	Vertical		

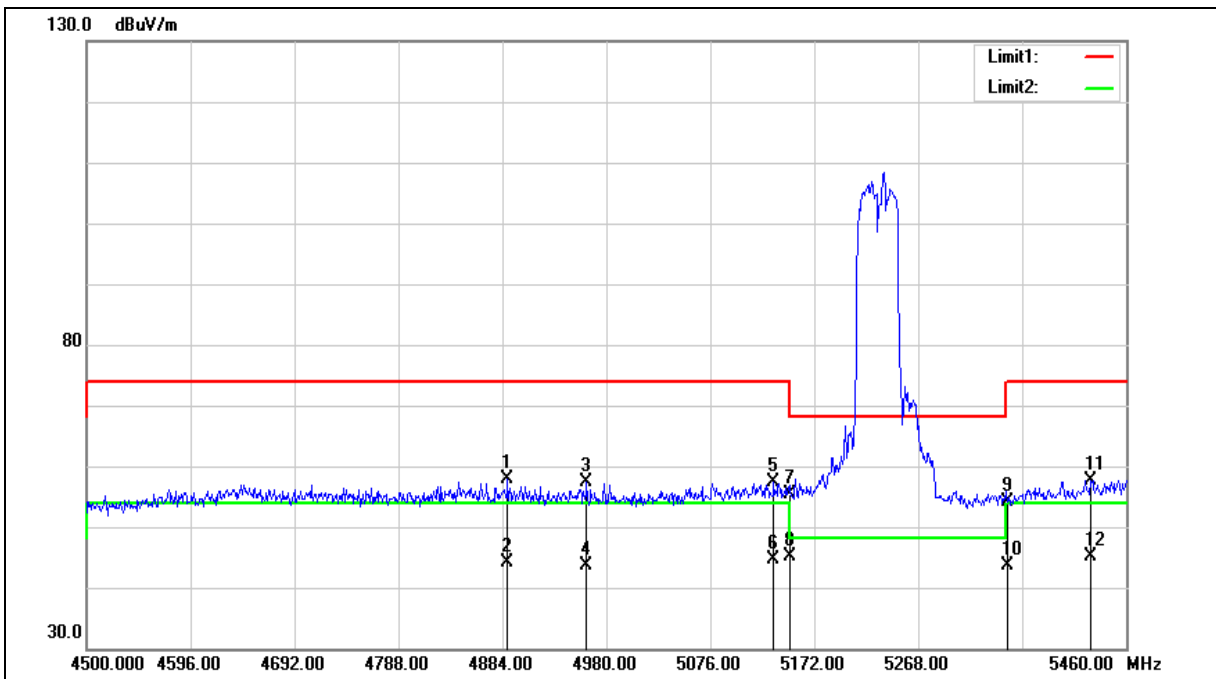



Standard:	FCC Part 15.407	Test Distance:	3 m
Test item:	Band edge	Power:	AC 120 V/60 Hz
Frequency:	5230 MHz	Temp.(°C)/Hum.(%RH):	26(°C)/60 %RH
Mode:	Mode 6		
Ant.Polar.:	Vertical		

No.	Frequency (MHz)	Reading (dBuV)	Correct Factor (dB/m)	Result (dBuV/m)	Limit (dBuV/m)	Margin (dB)	Remark
1	4888.800	52.11	5.70	57.81	74.00	-16.19	peak
2	4888.800	38.36	5.70	44.06	54.00	-9.94	AVG
3	4961.760	51.53	5.83	57.36	74.00	-16.64	peak
4	4961.760	37.86	5.83	43.69	54.00	-10.31	AVG
5	5134.560	51.12	6.23	57.35	74.00	-16.65	peak
6	5134.560	38.49	6.23	44.72	54.00	-9.28	AVG
7	5150.000	49.20	6.27	55.47	74.00	-18.53	peak
8	5150.000	38.96	6.27	45.23	54.00	-8.77	AVG
9	5350.000	47.36	6.74	54.10	74.00	-19.90	peak
10	5350.000	36.81	6.74	43.55	54.00	-10.45	AVG
11	5427.360	50.80	6.93	57.73	74.00	-16.27	peak
12	5427.360	38.19	6.93	45.12	54.00	-8.88	AVG

Note:1.Result (dBuV/m) = Correct Factor (dB/m) + Reading(dBuV).

2.Correction factor (dB/m) = Antenna Factor (dB/m) + Cable loss (dB) – Pre-Amplifier gain (dB).

3.When the peak results are less than average limit, there is no need to evaluate the average.

4.The average measurement was not performed when the peak measured data is under the limit of average detection.

5.The emission level of other frequencies is much lower than the limit and not shown in test report.



Standard:	FCC Part 15.407	Test Distance:	3 m
Test item:	Band edge	Power:	AC 120 V/60 Hz
Frequency:	5270 MHz	Temp.(°C)/Hum.(%RH):	26(°C)/60 %RH
Mode:	Mode 6		
Ant.Polar.:	Horizontal		

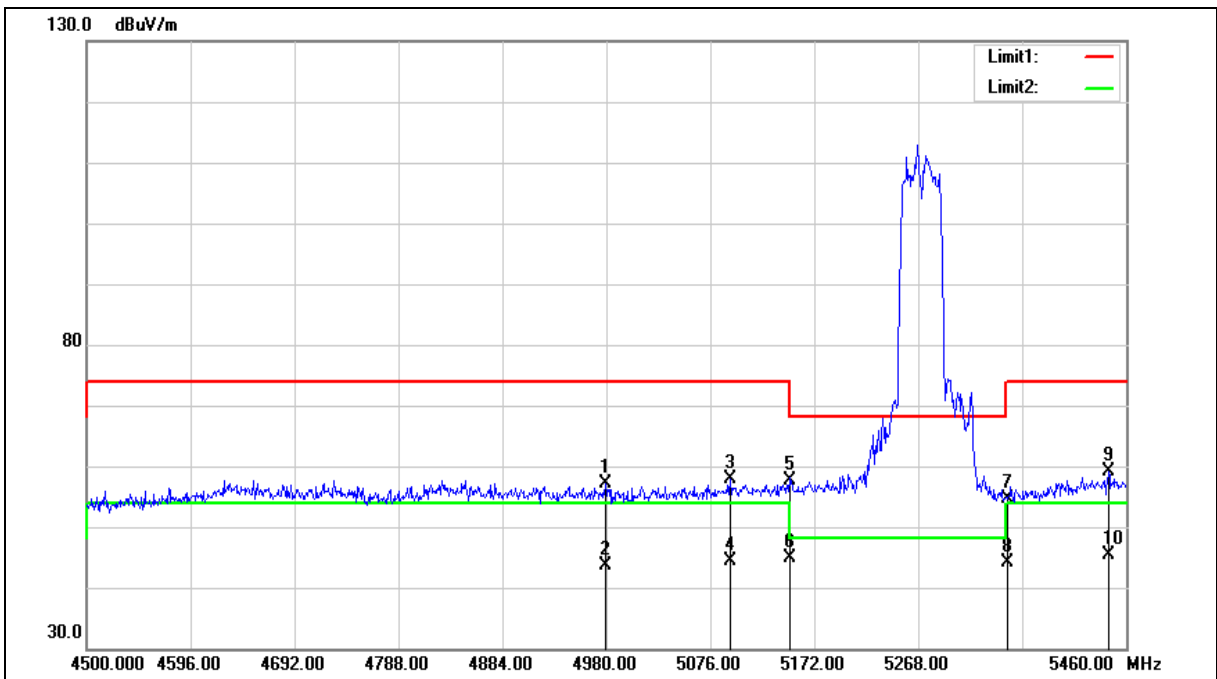



Standard:	FCC Part 15.407	Test Distance:	3 m
Test item:	Band edge	Power:	AC 120 V/60 Hz
Frequency:	5270 MHz	Temp.(°C)/Hum.(%RH):	26(°C)/60 %RH
Mode:	Mode 6		
Ant.Polar.:	Horizontal		

No.	Frequency (MHz)	Reading (dBuV)	Correct Factor (dB/m)	Result (dBuV/m)	Limit (dBuV/m)	Margin (dB)	Remark
1	4979.040	51.16	5.88	57.04	74.00	-16.96	peak
2	4979.040	37.74	5.88	43.62	54.00	-10.38	AVG
3	5094.240	51.81	6.14	57.95	74.00	-16.05	peak
4	5094.240	38.36	6.14	44.50	54.00	-9.50	AVG
5	5150.000	51.30	6.27	57.57	74.00	-16.43	peak
6	5150.000	38.60	6.27	44.87	54.00	-9.13	AVG
7	5350.000	47.81	6.74	54.55	74.00	-19.45	peak
8	5350.000	37.36	6.74	44.10	54.00	-9.90	AVG
9	5443.680	52.15	6.97	59.12	74.00	-14.88	peak
10	5443.680	38.38	6.97	45.35	54.00	-8.65	AVG

Note:1.Result (dBuV/m) = Correct Factor (dB/m) + Reading(dBuV).

2.Correction factor (dB/m) = Antenna Factor (dB/m) + Cable loss (dB) – Pre-Amplifier gain (dB).

3.When the peak results are less than average limit, there is no need to evaluate the average.

4.The average measurement was not performed when the peak measured data is under the limit of average detection.

5.The emission level of other frequencies is much lower than the limit and not shown in test report.



Standard:	FCC Part 15.407	Test Distance:	3 m
Test item:	Band edge	Power:	AC 120 V/60 Hz
Frequency:	5270 MHz	Temp.(°C)/Hum.(%RH):	26(°C)/60 %RH
Mode:	Mode 6		
Ant.Polar.:	Vertical		

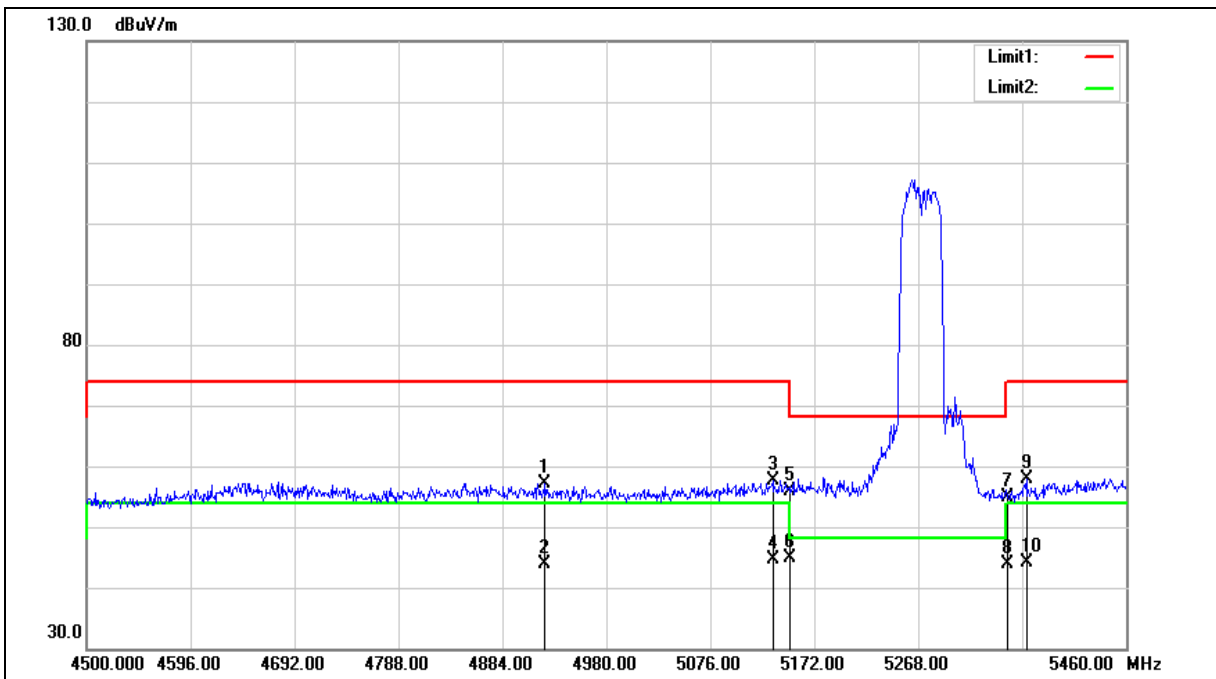



Standard:	FCC Part 15.407	Test Distance:	3 m
Test item:	Band edge	Power:	AC 120 V/60 Hz
Frequency:	5270 MHz	Temp.(°C)/Hum.(%RH):	26(°C)/60 %RH
Mode:	Mode 6		
Ant.Polar.:	Vertical		

No.	Frequency (MHz)	Reading (dBuV)	Correct Factor (dB/m)	Result (dBuV/m)	Limit (dBuV/m)	Margin (dB)	Remark
1	4923.360	51.42	5.77	57.19	74.00	-16.81	peak
2	4923.360	38.16	5.77	43.93	54.00	-10.07	AVG
3	5133.600	51.40	6.23	57.63	74.00	-16.37	peak
4	5133.600	38.49	6.23	44.72	54.00	-9.28	AVG
5	5150.000	49.68	6.27	55.95	74.00	-18.05	peak
6	5150.000	38.51	6.27	44.78	54.00	-9.22	AVG
7	5350.000	48.17	6.74	54.91	74.00	-19.09	peak
8	5350.000	37.03	6.74	43.77	54.00	-10.23	AVG
9	5367.840	51.19	6.79	57.98	74.00	-16.02	peak
10	5367.840	37.24	6.79	44.03	54.00	-9.97	AVG

Note:1.Result (dBuV/m) = Correct Factor (dB/m) + Reading(dBuV).

2.Correction factor (dB/m) = Antenna Factor (dB/m) + Cable loss (dB) – Pre-Amplifier gain (dB).

3.When the peak results are less than average limit, there is no need to evaluate the average.

4.The average measurement was not performed when the peak measured data is under the limit of average detection.

5.The emission level of other frequencies is much lower than the limit and not shown in test report.



Standard:	FCC Part 15.407	Test Distance:	3 m
Test item:	Band edge	Power:	AC 120 V/60 Hz
Frequency:	5755 MHz	Temp.(°C)/Hum.(%RH):	26(°C)/60 %RH
Mode:	Mode 6		
Ant.Polar.:	Horizontal		

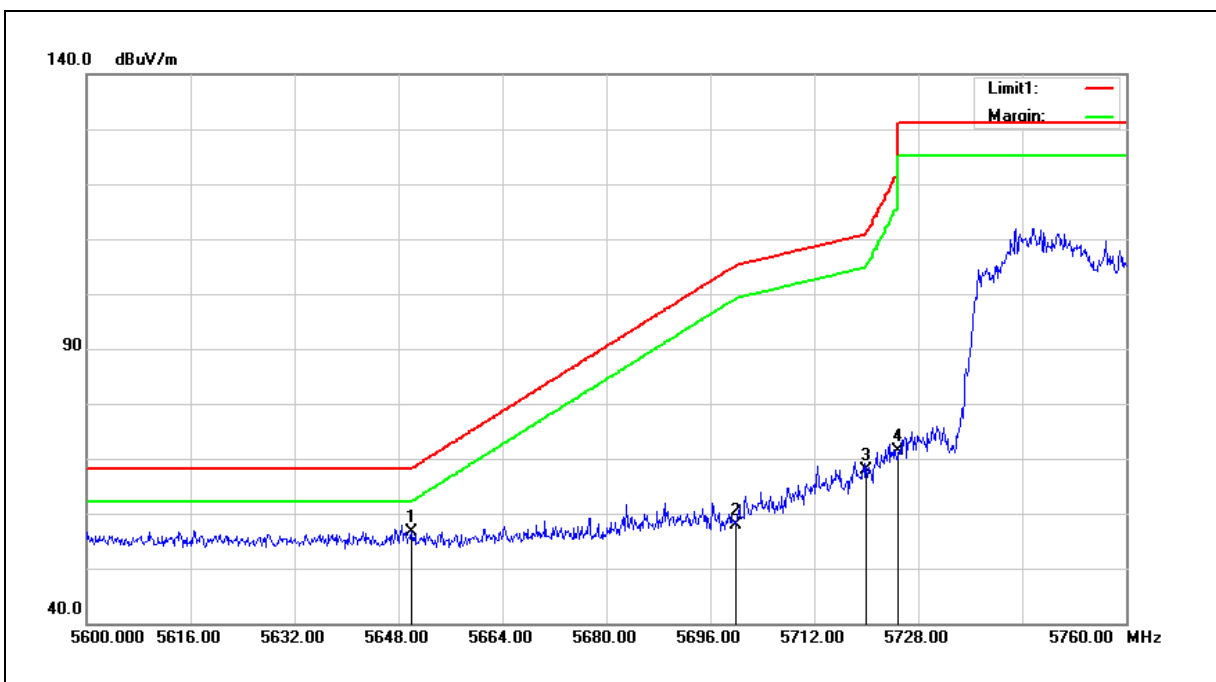

No.	Frequency (MHz)	Reading (dBuV)	Correct Factor (dB/m)	Result (dBuV/m)	Limit (dBuV/m)	Margin (dB)	Remark
1	5650.000	49.29	7.42	56.71	68.20	-11.49	peak
2	5700.000	50.31	7.52	57.83	105.20	-47.37	peak
3	5720.000	60.42	7.56	67.98	110.80	-42.82	peak
4	5725.000	63.80	7.57	71.37	122.20	-50.83	peak

Note:1.Result (dBuV/m) = Correct Factor (dB/m) + Reading(dBuV).

2.Correction factor (dB/m) = Antenna Factor (dB/m) + Cable loss (dB) – Pre-Amplifier gain (dB).

3.When the peak results are less than average limit, there is no need to evaluate the average.

4.The average measurement was not performed when the peak measured data is under the limit of average detection.

5.The emission level of other frequencies is much lower than the limit and not shown in test report.



Standard:	FCC Part 15.407	Test Distance:	3 m
Test item:	Band edge	Power:	AC 120 V/60 Hz
Frequency:	5755 MHz	Temp.(°C)/Hum.(%RH):	26(°C)/60 %RH
Mode:	Mode 6		
Ant.Polar.:	Vertical		

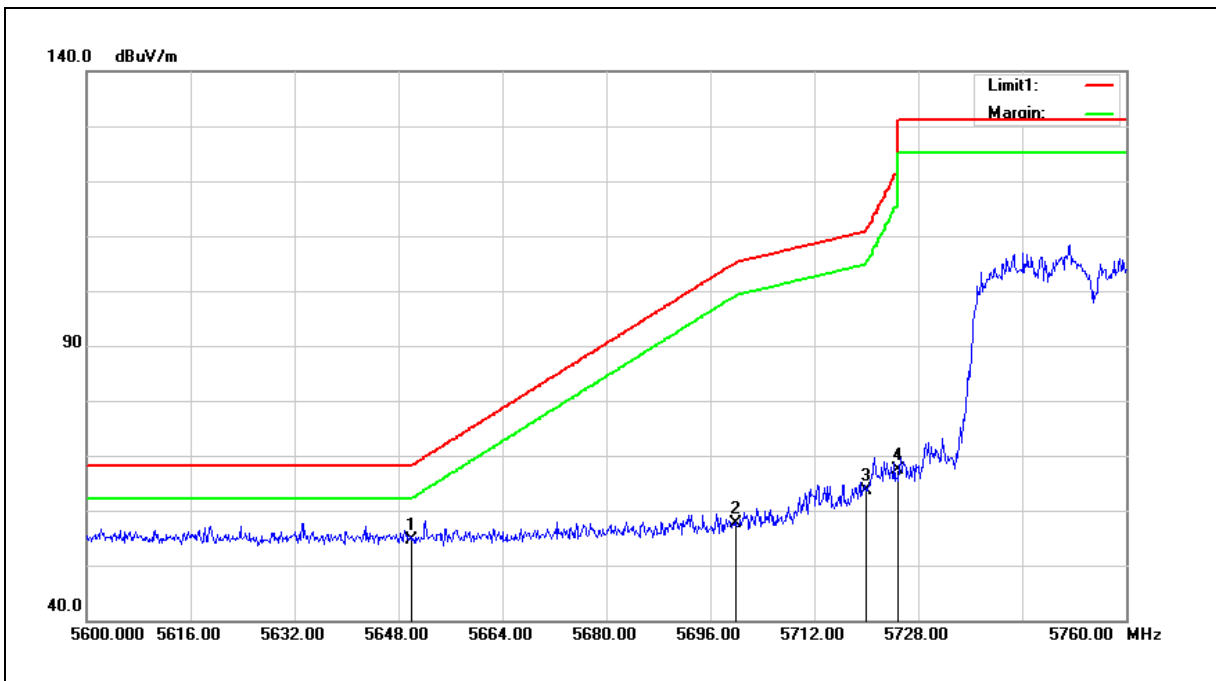

No.	Frequency (MHz)	Reading (dBuV)	Correct Factor (dB/m)	Result (dBuV/m)	Limit (dBuV/m)	Margin (dB)	Remark
1	5650.000	47.25	7.42	54.67	68.20	-13.53	peak
2	5700.000	50.20	7.52	57.72	105.20	-47.48	peak
3	5720.000	56.18	7.56	63.74	110.80	-47.06	peak
4	5725.000	59.92	7.57	67.49	122.20	-54.71	peak

Note:1.Result (dBuV/m) = Correct Factor (dB/m) + Reading(dBuV).

2.Correction factor (dB/m) = Antenna Factor (dB/m) + Cable loss (dB) – Pre-Amplifier gain (dB).

3.When the peak results are less than average limit, there is no need to evaluate the average.

4.The average measurement was not performed when the peak measured data is under the limit of average detection.

5.The emission level of other frequencies is much lower than the limit and not shown in test report.



Standard:	FCC Part 15.407	Test Distance:	3 m
Test item:	Band edge	Power:	AC 120 V/60 Hz
Frequency:	5795 MHz	Temp.(°C)/Hum.(%RH):	26(°C)/60 %RH
Mode:	Mode 6		
Ant.Polar.:	Horizontal		

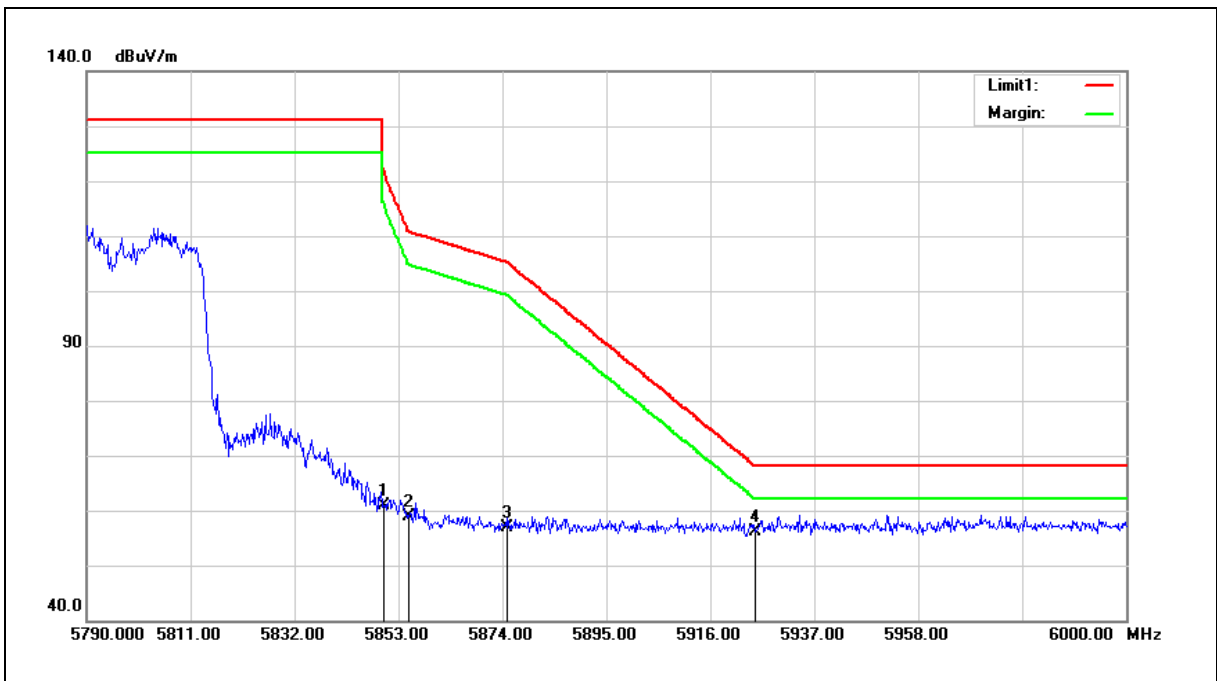

No.	Frequency (MHz)	Reading (dBuV)	Correct Factor (dB/m)	Result (dBuV/m)	Limit (dBuV/m)	Margin (dB)	Remark
1	5850.000	53.02	7.83	60.85	122.20	-61.35	peak
2	5855.000	51.02	7.85	58.87	110.80	-51.93	peak
3	5875.000	49.04	7.88	56.92	105.20	-48.28	peak
4	5925.000	48.23	8.00	56.23	68.20	-11.97	peak

Note:1.Result (dBuV/m) = Correct Factor (dB/m) + Reading(dBuV).

2.Correction factor (dB/m) = Antenna Factor (dB/m) + Cable loss (dB) – Pre-Amplifier gain (dB).

3.When the peak results are less than average limit, there is no need to evaluate the average.

4.The average measurement was not performed when the peak measured data is under the limit of average detection.

5.The emission level of other frequencies is much lower than the limit and not shown in test report.



Standard:	FCC Part 15.407	Test Distance:	3 m
Test item:	Band edge	Power:	AC 120 V/60 Hz
Frequency:	5795 MHz	Temp.(°C)/Hum.(%RH):	26(°C)/60 %RH
Mode:	Mode 6		
Ant.Polar.:	Vertical		

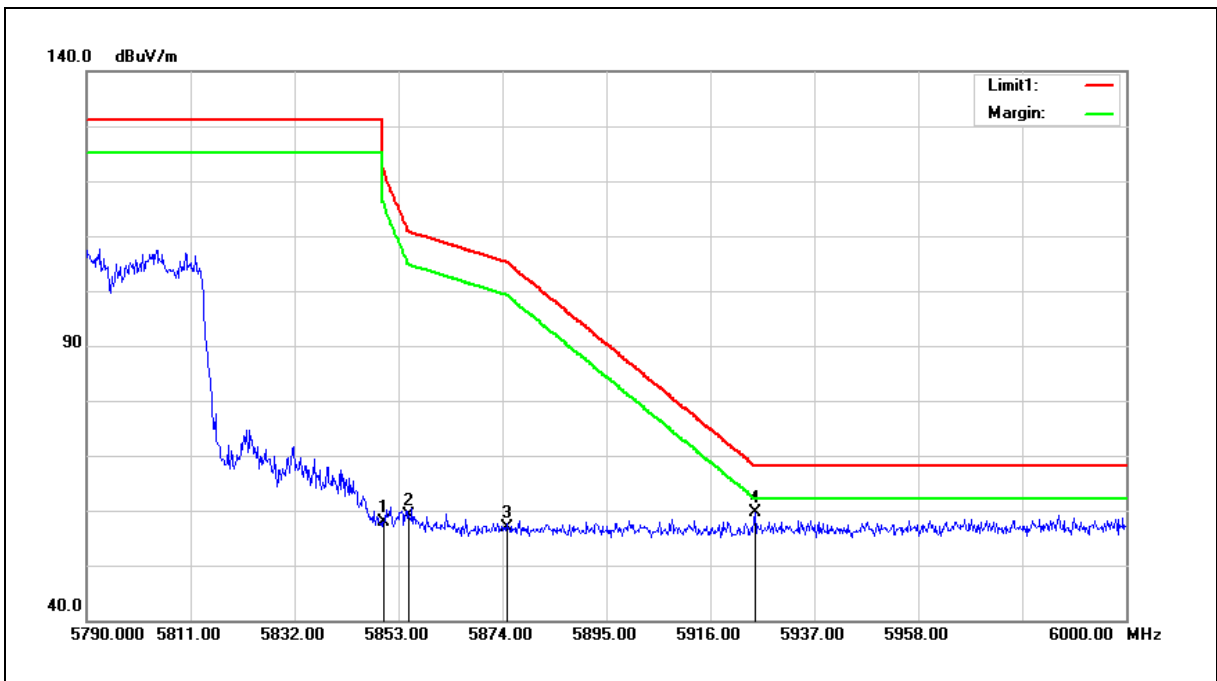

No.	Frequency (MHz)	Reading (dBuV)	Correct Factor (dB/m)	Result (dBuV/m)	Limit (dBuV/m)	Margin (dB)	Remark
1	5850.000	49.99	7.83	57.82	122.20	-64.38	peak
2	5855.000	51.17	7.85	59.02	110.80	-51.78	peak
3	5875.000	48.94	7.88	56.82	105.20	-48.38	peak
4	5925.000	51.53	8.00	59.53	68.20	-8.67	peak

Note:1.Result (dBuV/m) = Correct Factor (dB/m) + Reading(dBuV).

2.Correction factor (dB/m) = Antenna Factor (dB/m) + Cable loss (dB) – Pre-Amplifier gain (dB).

3.When the peak results are less than average limit, there is no need to evaluate the average.

4.The average measurement was not performed when the peak measured data is under the limit of average detection.

5.The emission level of other frequencies is much lower than the limit and not shown in test report.



Standard:	FCC Part 15.407	Test Distance:	3 m
Test item:	Band edge	Power:	AC 120 V/60 Hz
Frequency:	5210 MHz	Temp.(°C)/Hum.(%RH):	26(°C)/60 %RH
Mode:	Mode 7		
Ant.Polar.:	Horizontal		

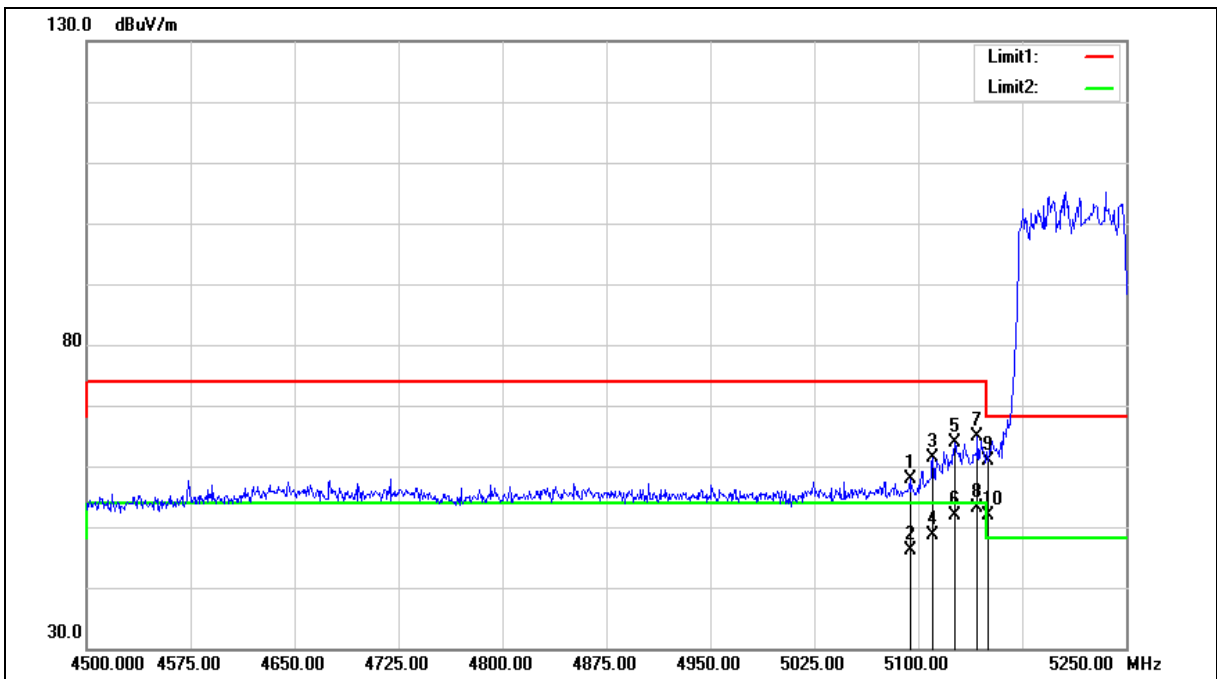



Standard:	FCC Part 15.407	Test Distance:	3 m
Test item:	Band edge	Power:	AC 120 V/60 Hz
Frequency:	5210 MHz	Temp.(°C)/Hum.(%RH):	26(°C)/60 %RH
Mode:	Mode 7		
Ant.Polar.:	Horizontal		

No.	Frequency (MHz)	Reading (dBuV)	Correct Factor (dB/m)	Result (dBuV/m)	Limit (dBuV/m)	Margin (dB)	Remark
1	5094.000	51.65	6.14	57.79	74.00	-16.21	peak
2	5094.000	39.98	6.14	46.12	54.00	-7.88	AVG
3	5110.500	55.26	6.17	61.43	74.00	-12.57	peak
4	5110.500	42.51	6.17	48.68	54.00	-5.32	AVG
5	5126.250	57.65	6.21	63.86	74.00	-10.14	peak
6	5126.250	45.64	6.21	51.85	54.00	-2.15	AVG
7	5142.750	58.56	6.25	64.81	74.00	-9.19	peak
8	5142.750	46.76	6.25	53.01	54.00	-0.99	AVG
9	5150.000	54.62	6.27	60.89	74.00	-13.11	peak
10	5150.000	45.70	6.27	51.97	54.00	-2.03	AVG

Note:1.Result (dBuV/m) = Correct Factor (dB/m) + Reading(dBuV).

2.Correction factor (dB/m) = Antenna Factor (dB/m) + Cable loss (dB) – Pre-Amplifier gain (dB).

3.When the peak results are less than average limit, there is no need to evaluate the average.

4.The average measurement was not performed when the peak measured data is under the limit of average detection.

5.The emission level of other frequencies is much lower than the limit and not shown in test report.



Standard:	FCC Part 15.407	Test Distance:	3 m
Test item:	Band edge	Power:	AC 120 V/60 Hz
Frequency:	5210 MHz	Temp.(°C)/Hum.(%RH):	26(°C)/60 %RH
Mode:	Mode 7		
Ant.Polar.:	Vertical		

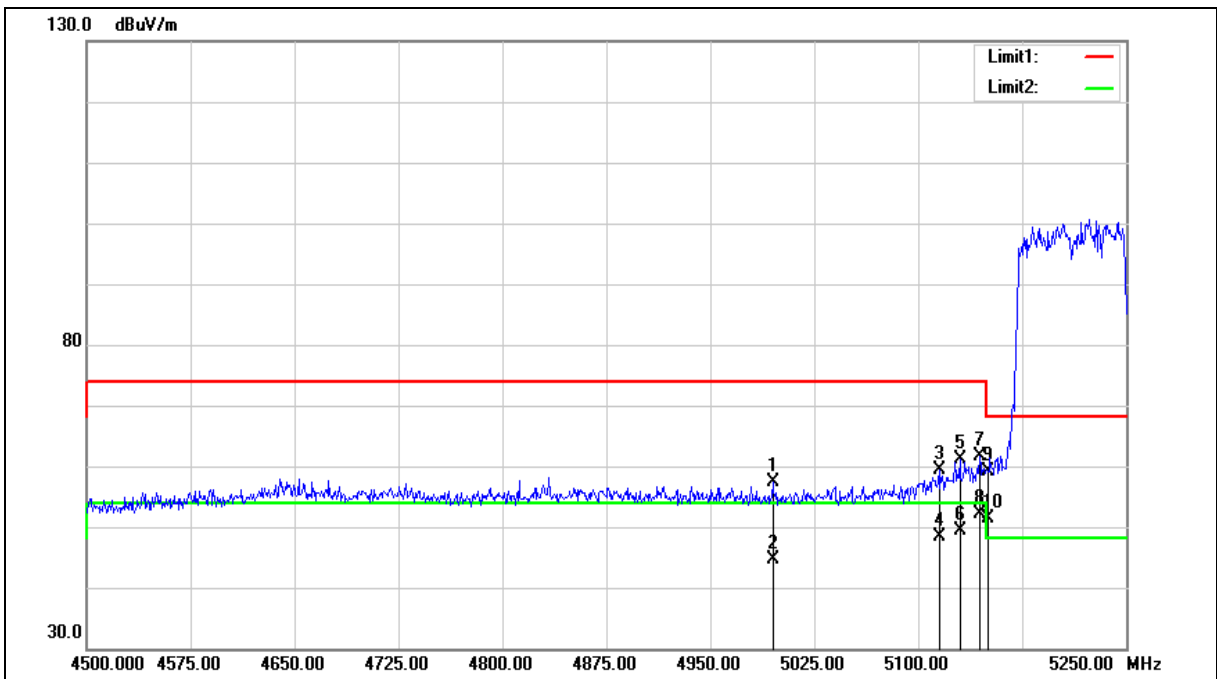



Standard:	FCC Part 15.407	Test Distance:	3 m
Test item:	Band edge	Power:	AC 120 V/60 Hz
Frequency:	5210 MHz	Temp.(°C)/Hum.(%RH):	26(°C)/60 %RH
Mode:	Mode 7		
Ant.Polar.:	Vertical		

No.	Frequency (MHz)	Reading (dBuV)	Correct Factor (dB/m)	Result (dBuV/m)	Limit (dBuV/m)	Margin (dB)	Remark
1	4995.000	51.57	5.90	57.47	74.00	-16.53	peak
2	4995.000	38.74	5.90	44.64	54.00	-9.36	AVG
3	5115.000	53.21	6.19	59.40	74.00	-14.60	peak
4	5115.000	42.19	6.19	48.38	54.00	-5.62	AVG
5	5130.000	54.98	6.22	61.20	74.00	-12.80	peak
6	5130.000	43.04	6.22	49.26	54.00	-4.74	AVG
7	5144.250	55.49	6.26	61.75	74.00	-12.25	peak
8	5144.250	45.97	6.26	52.23	54.00	-1.77	AVG
9	5150.000	52.75	6.27	59.02	74.00	-14.98	peak
10	5150.000	45.15	6.27	51.42	54.00	-2.58	AVG

Note:1.Result (dBuV/m) = Correct Factor (dB/m) + Reading(dBuV).

2.Correction factor (dB/m) = Antenna Factor (dB/m) + Cable loss (dB) – Pre-Amplifier gain (dB).

3.When the peak results are less than average limit, there is no need to evaluate the average.

4.The average measurement was not performed when the peak measured data is under the limit of average detection.

5.The emission level of other frequencies is much lower than the limit and not shown in test report.



Standard:	FCC Part 15.407	Test Distance:	3 m
Test item:	Band edge	Power:	AC 120 V/60 Hz
Frequency:	5775 MHz	Temp.(°C)/Hum.(%RH):	26(°C)/60 %RH
Mode:	Mode 7		
Ant.Polar.:	Horizontal		

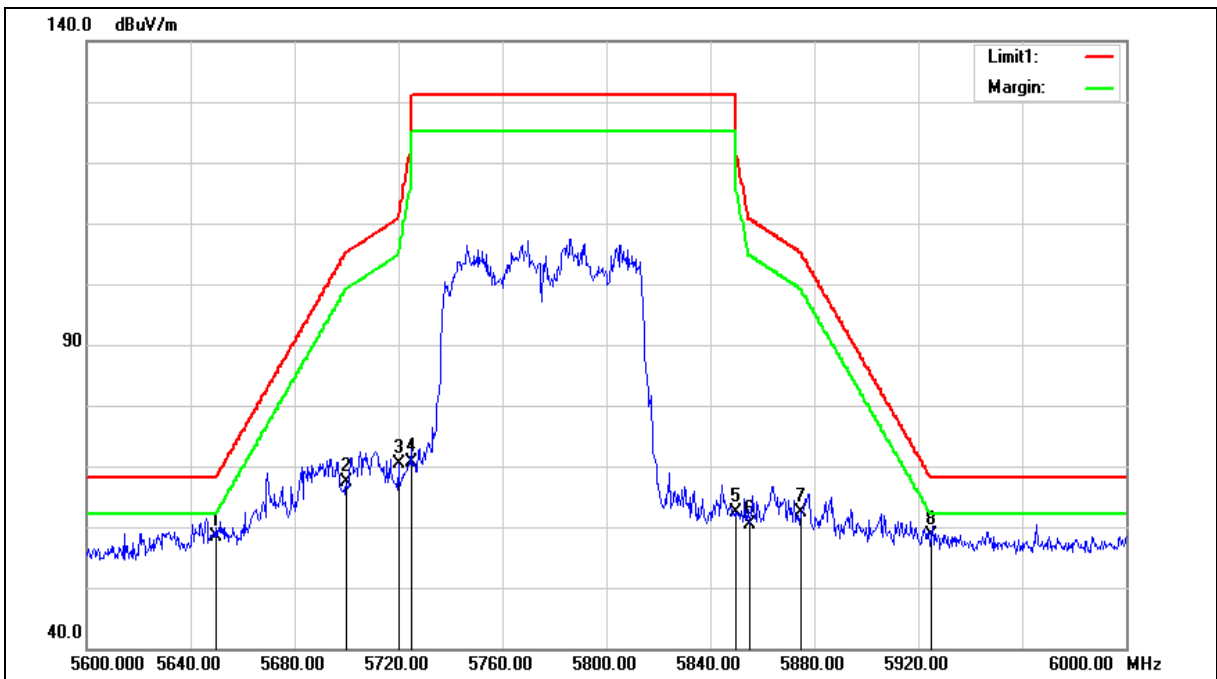



Standard:	FCC Part 15.407	Test Distance:	3 m
Test item:	Band edge	Power:	AC 120 V/60 Hz
Frequency:	5775 MHz	Temp.(°C)/Hum.(%RH):	26(°C)/60 %RH
Mode:	Mode 7		
Ant.Polar.:	Horizontal		

No.	Frequency (MHz)	Reading (dBuV)	Correct Factor (dB/m)	Result (dBuV/m)	Limit (dBuV/m)	Margin (dB)	Remark
1	5650.000	51.03	7.42	58.45	68.20	-9.75	peak
2	5700.000	59.84	7.52	67.36	105.20	-37.84	peak
3	5720.000	62.86	7.56	70.42	110.80	-40.38	peak
4	5725.000	63.06	7.57	70.63	122.20	-51.57	peak
5	5850.000	54.56	7.83	62.39	122.20	-59.81	peak
6	5855.000	52.65	7.85	60.50	110.80	-50.30	peak
7	5875.000	54.47	7.88	62.35	105.20	-42.85	peak
8	5925.000	50.52	8.00	58.52	68.20	-9.68	peak

Note:1.Result (dBuV/m) = Correct Factor (dB/m) + Reading(dBuV).

2.Correction factor (dB/m) = Antenna Factor (dB/m) + Cable loss (dB) – Pre-Amplifier gain (dB).

3.When the peak results are less than average limit, there is no need to evaluate the average.

4.The average measurement was not performed when the peak measured data is under the limit of average detection.

5.The emission level of other frequencies is much lower than the limit and not shown in test report.



Standard:	FCC Part 15.407	Test Distance:	3 m
Test item:	Band edge	Power:	AC 120 V/60 Hz
Frequency:	5775 MHz	Temp.(°C)/Hum.(%RH):	26(°C)/60 %RH
Mode:	Mode 7		
Ant.Polar.:	Vertical		

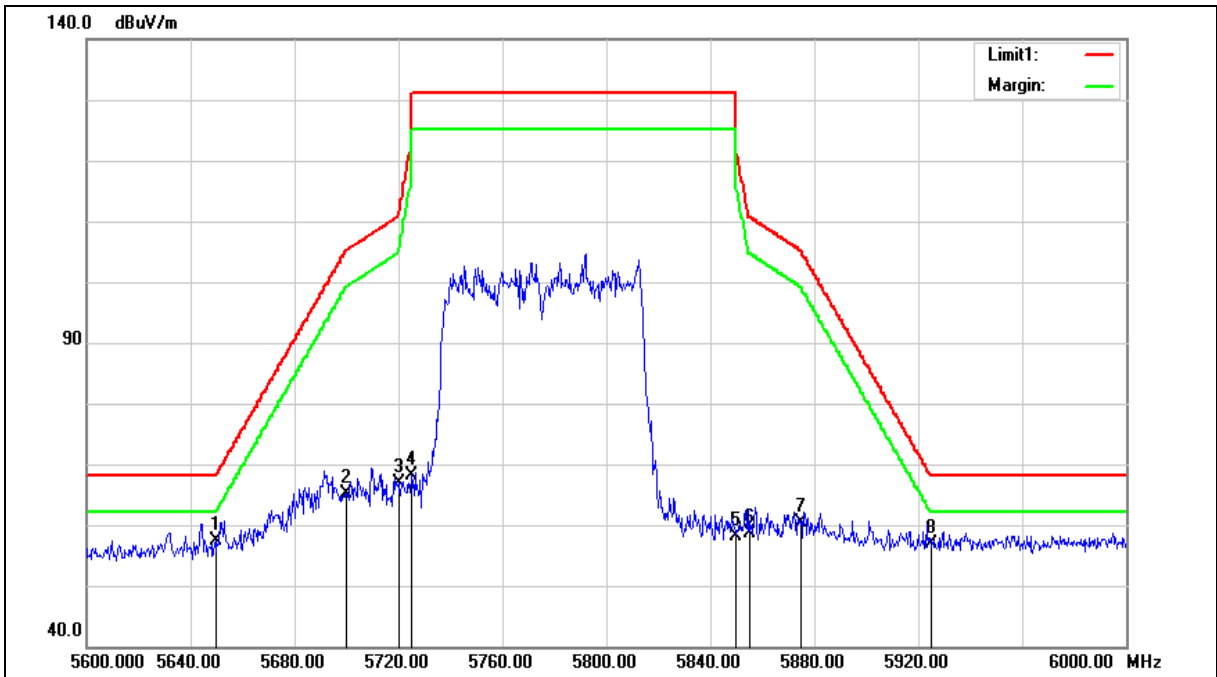



Standard:	FCC Part 15.407	Test Distance:	3 m
Test item:	Band edge	Power:	AC 120 V/60 Hz
Frequency:	5775 MHz	Temp.(°C)/Hum.(%RH):	26(°C)/60 %RH
Mode:	Mode 7		
Ant.Polar.:	Vertical		

No.	Frequency (MHz)	Reading (dBuV)	Correct Factor (dB/m)	Result (dBuV/m)	Limit (dBuV/m)	Margin (dB)	Remark
1	5650.000	49.89	7.42	57.31	68.20	-10.89	peak
2	5700.000	57.59	7.52	65.11	105.20	-40.09	peak
3	5720.000	59.20	7.56	66.76	110.80	-44.04	peak
4	5725.000	60.57	7.57	68.14	122.20	-54.06	peak
5	5850.000	50.27	7.83	58.10	122.20	-64.10	peak
6	5855.000	50.87	7.85	58.72	110.80	-52.08	peak
7	5875.000	52.62	7.88	60.50	105.20	-44.70	peak
8	5925.000	48.81	8.00	56.81	68.20	-11.39	peak

Note:1.Result (dBuV/m) = Correct Factor (dB/m) + Reading(dBuV).

2.Correction factor (dB/m) = Antenna Factor (dB/m) + Cable loss (dB) – Pre-Amplifier gain (dB).

3.When the peak results are less than average limit, there is no need to evaluate the average.

4.The average measurement was not performed when the peak measured data is under the limit of average detection.

5.The emission level of other frequencies is much lower than the limit and not shown in test report.