

FCC 47 CFR PART 15 SUBPART E

Applicant : Emplus Technologies, Inc
Product Type : dual band AC1300 access point
Trade Name : emplus
Model Number : WAP353
Test Specification : FCC 47 CFR PART 15 SUBPART E
ANSI C63.10:2013
Receive Date : Aug. 29, 2017
Test Period : Feb. 02 ~ Mar. 19, 2018
Issue Date : Sep. 04, 2018

Issue by

A Test Lab Techno Corp.
No. 140-1, Changan Street, Bade District,
Taoyuan City 33465, Taiwan (R.O.C)
Tel : +86-3-2710188 / Fax : +86-3-2710190



Taiwan Accreditation Foundation accreditation number: 1330
Test Firm MRA designation number: TW0010

Note: This report shall not be reproduced except in full, without the written approval of A Test Lab Techno Corp. This document may be altered or revised by A Test Lab Techno Corp. personnel only, and shall be noted in the revision section of the document. The client should not use it to claim product endorsement by TAF, or any government agencies. The test results in the report only apply to the tested sample.



Revision History

Rev.	Issue Date	Revisions	Revised By
00	Mar. 26, 2018	Initial Issue	Janet Chao
01	Sep. 04, 2018	Revised Report Information	Janet Chao

Verification of Compliance

Issued Date: Sep. 04, 2018

Applicant : Emplus Technologies, Inc
Product Type : dual band AC1300 access point
Trade Name : emplus
Model Number : WAP353
FCC ID : 2AL6XWAP353
EUT Rated Voltage : DC 12V, 1.25A
Test Voltage : 120 Vac / 60 Hz
Applicable Standard : FCC 47 CFR PART 15 SUBPART E
ANSI C63.10:2013
Test Result : Complied

Performing Lab. : A Test Lab Techno Corp.
No. 140-1, Changan Street, Bade District,
Taoyuan City 33465, Taiwan (R.O.C)
Tel : +86-3-2710188 / Fax : +86-3-2710190



Taiwan Accreditation Foundation accreditation number: 1330

<http://www.atl-lab.com.tw/e-index.htm>

A Test Lab Techno Corp. tested the above equipment in accordance with the requirements set forth in the above standards. All indications of Pass/Fail in this report are opinions expressed by A Test Lab Techno Corp. based on interpretations and/or observations of test results. Measurement Uncertainties were not taken into account and are published for informational purposes only. The test results show that the equipment tested is capable of demonstrating compliance with the requirements as documented in this report.

Approved By : Fly Lu Reviewed By : Eric Ou Yang
(Manager) (Fly Lu) (Testing Engineer) (Eric Ou Yang)



TABLE OF CONTENTS

1	General Information	5
1.1.	Summary of Test Result.....	5
1.2.	Measurement Uncertainty	5
2	EUT Description	6
3	Test Methodology.....	8
3.1.	Mode of Operation	8
3.2.	EUT Exercise Software.....	17
3.3.	Configuration of Test System Details	18
3.4.	Test Instruments	19
3.5.	Test Site Environment.....	20
4	Measurement Procedure.....	21
4.1.	AC Power Conducted Emission Measurement	21
4.2.	Transmitter Radiated Emissions Measurement.....	23
4.3.	Maximum Conducted Output Power Measurement.....	28
4.4.	26dB RF Bandwidth Measurement & 99 % Occupied Bandwidth Measurement	29
4.5.	6dB RF Bandwidth Measurement	30
4.6.	Maximum Power Spectral Density Measurement.....	31
4.7.	Frequency Stability Measurement.....	33
4.8.	Automatically discontinue transmission.....	34
4.9.	Antenna Requirement.....	34
5	Test Results.....	35
5.1.	AC Power Conducted Emission Measurement	35
5.2.	Transmitter Radiated Emissions Measurement.....	41
5.3.	Maximum Conducted Output Power Measurement.....	198
5.4.	26dB RF Bandwidth Measurement & 99 % Occupied Bandwidth Measurement	203
5.5.	6dB RF Bandwidth Measurement	215
5.6.	Maximum Power Spectral Density Measurement.....	227
5.7.	Frequency Stability Measurement.....	261
5.8.	Automatically discontinue transmission.....	263
5.9.	Antenna Requirement.....	263



1 General Information

1.1. Summary of Test Result

Standard	Item	Result	Remark
FCC			
15.407(b)(6) 15.207	AC Power Conducted Emission	PASS	---
15.407(b) 15.205 / 15.209	Transmitter Radiated Emissions	PASS	---
15.407(a)	Maximum Conducted Output Power	PASS	---
15.407(a)	26dB RF Bandwidth	Reference	---
15.407(e)	6dB RF Bandwidth	PASS	----
15.407(a)	Maximum Power Spectral Density	PASS	---
15.407(g)	Frequency Stability	PASS	---
15.407(c)	Automatically discontinue transmission	PASS	---
15.407(a) 15.203	Antenna Requirement	PASS	---

The test results of this report relate only to the tested sample(s) identified in this report. Manufacturer or whom it may concern should recognize the pass or fail of the test result.

1.2. Measurement Uncertainty

Test Item	Frequency Range	Uncertainty (dB)
Conducted Emission	9kHz ~ 150KHz	2.7
	150kHz ~ 30MHz	2.7
Radiated Emission	9kHz ~ 30MHz	1.7
	30MHz ~ 1000MHz	5.7
	1000MHz ~ 18000MHz	5.5
	18000MHz ~ 26500MHz	4.8
	26500MHz ~ 40000MHz	4.8
Conducted Output Power		+0.27 dB / -0.28 dB
RF Bandwidth		4.96%
Power Spectral Density		+0.71 dB / -0.77 dB
Frequency Stability		+ 2.212 x 10 ⁻⁷ % / - 2.170 x 10 ⁻⁷ %
Duty Cycle		1.06%
Time Occupancy		1.40%



2 EUT Description

Applicant	Emplus Technologies, Inc Bld B, 10F, No.209 Nangang Rd. , Taipei City, Taiwan			
Manufacturer	Emplus Technologies, Inc Bld B, 10F, No.209 Nangang Rd. , Taipei City, Taiwan			
Product Type	dual band AC1300 access point			
Trade Name	emplus			
Model No.	WAP353			
FCC ID	2AL6XWAP353			
Operate Frequency	Frequency Band		Frequency Range (MHz)	Number of Channels
	IEEE 802.11a	U-NII Band I	5180 – 5240	4
		U-NII Band III	5745 – 5825	5
	IEEE 802.11n 5GHz 20 MHz / IEEE 802.11ac 20 MHz	U-NII Band I	5180 – 5240	4
		U-NII Band III	5745 – 5825	5
	IEEE 802.11n 5GHz 40 MHz / IEEE 802.11ac 40 MHz	U-NII Band I	5190 – 5230	2
		U-NII Band III	5755 – 5795	2
	IEEE 802.11ac 80 MHz	U-NII Band I	5210	1
U-NII Band III		5775	1	
Modulation Type	OFDM			
Equipment Type	Master			
Antenna information	Antenna	Type	Max. Gain (dBi)	
	ANT-0	Metal PIFA Antenna	U-NII Band I	4.47
	ANT-1	Metal PIFA Antenna	U-NII Band I	5.38
	G _{ANT}		U-NII Band I	4.95
	ANT-0	Metal PIFA Antenna	U-NII Band III	4.86
	ANT-1	Metal PIFA Antenna	U-NII Band III	5.62
	G _{ANT}		U-NII Band III	5.26
	Antenna Delivery	Reference section 3.1		
Frequency stability specification	± 20 ppm			
Operate Temp. Range	0 ~ +40 °C			



Frequency Band		RF Output Power (W)
IEEE 802.11a	U-NII Band I	0.310
	U-NII Band III	0.312
IEEE 802.11ac 20 MHz	U-NII Band I	0.298
	U-NII Band III	0.346
IEEE 802.11ac 40 MHz	U-NII Band I	0.252
	U-NII Band III	0.251
IEEE 802.11ac 80 MHz	U-NII Band I	0.113
	U-NII Band III	0.226

Beamforming on

Frequency Band		RF Output Power (W)
IEEE 802.11ac 20 MHz	U-NII Band I	0.144
	U-NII Band III	0.169
IEEE 802.11ac 40 MHz	U-NII Band I	0.123
	U-NII Band III	0.118
IEEE 802.11ac 80 MHz	U-NII Band I	0.052
	U-NII Band III	0.110

3 Test Methodology

3.1. Mode of Operation

Decision of Test ATL has verified the construction and function in typical operation. All the test modes were carried out with the EUT in normal operation, which was shown in this test report and defined as:

Test Mode
Mode 1: Transmit mode
Mode 2: IEEE 802.11a Continuous TX mode
Mode 3: IEEE 802.11ac 20MHz Continuous TX mode
Mode 4: IEEE 802.11ac 40MHz Continuous TX mode
Mode 5: IEEE 802.11ac 80MHz Continuous TX mode

Software used to control the EUT for staying in continuous transmitting mode was programmed.

After verification, all tests were carried out with the worst case test modes as shown below except radiated spurious emission below 1GHz and power line conducted emissions below 30MHz, which worst case was in normal link mode only.

Note: Adapter Model Number: PA1015-120HUB125 is worst case.

Equipment Type	
Outdoor access point	---
Indoor access point	V
Fixed point-to-point access points	---
Client devices	---

Test Mode	ANT-0	ANT-1	ANT-0+1
Mode 2	V	V	V
Mode 3	V	V	V
Mode 4	V	V	V
Mode 5	V	V	V

Test Mode	Antenna Delivery		Data Rate	Band	Test Channel
	Normal	Beamforming on			
Mode 2	2TX(CDD)	---	6M	U-NII Band I	36, 40, 44, 48
				U-NII Band III	149,153,157,161,165
Mode 3	2TX(CDD)	2TX(MIMO)	13M	U-NII Band I	36, 40, 44, 48
				U-NII Band III	149,153,157,161,165
Mode 4	2TX(CDD)	2TX(MIMO)	27M	U-NII Band I	38, 46
				U-NII Band III	151,159
Mode 5	2TX(CDD)	2TX(MIMO)	58.6M	U-NII Band I	42
				U-NII Band III	155

**Duty cycle**

Test Mode	Frequency (MHz)	on time (ms)	on+off time (ms)	Duty cycle	Duty Factor (dB)	1/T Minimum VBW (kHz)
Mode 2	5180.0	2.050	2.100	0.976	0.105	0.488
Mode 3	5180.0	5.010	5.055	0.991	0.039	0.010
Mode 4	5190.0	2.430	2.490	0.976	0.106	0.412
Mode 5	5210.0	1.145	1.210	0.946	0.240	0.873

Beamforming on

Test Mode	Frequency (MHz)	on time (ms)	on+off time (ms)	Duty cycle	Duty Factor (dB)	1/T Minimum VBW (kHz)
Mode 3	5180.0	5.010	5.055	0.991	0.039	0.010
Mode 4	5190.0	2.430	2.490	0.976	0.106	0.412
Mode 5	5210.0	1.145	1.210	0.946	0.240	0.873

Duty Cycle Graphs

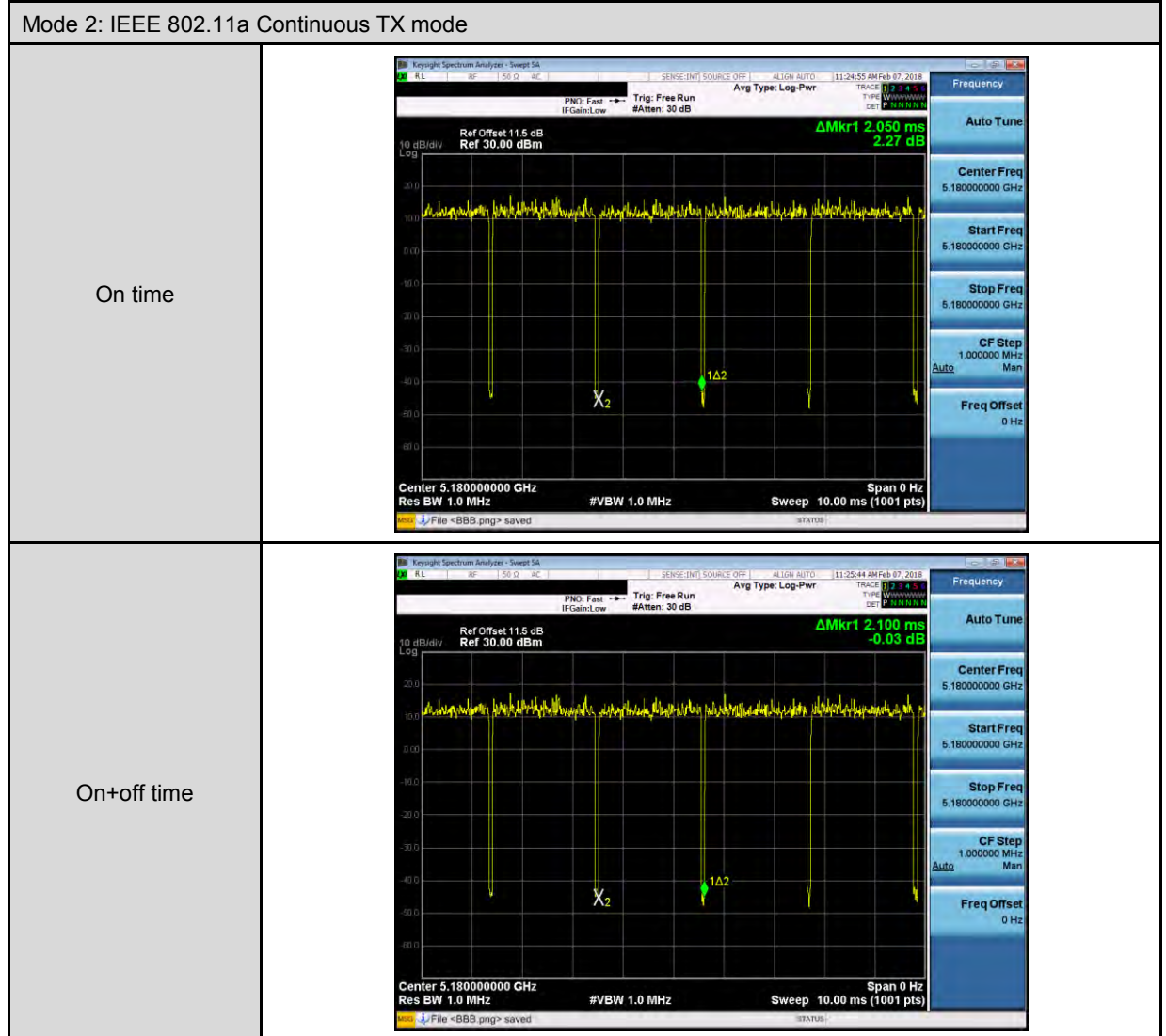



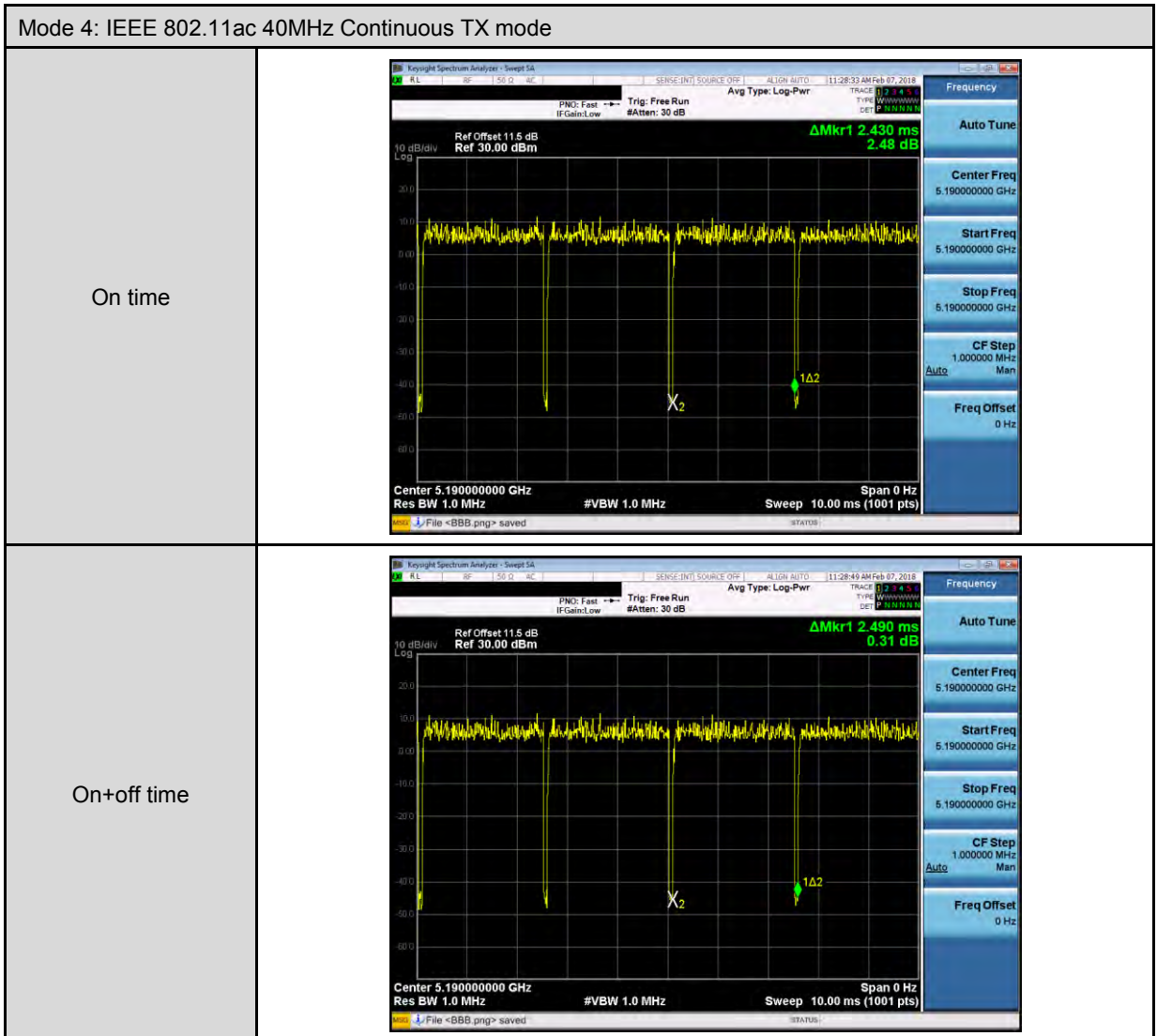

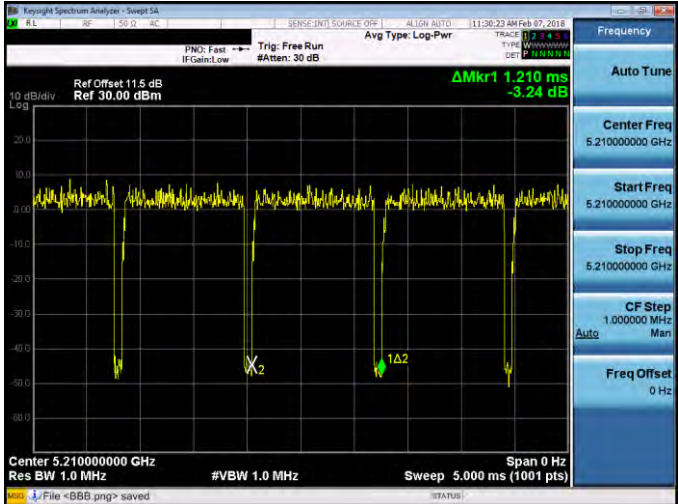
Mode 5: IEEE 802.11ac 80MHz Continuous TX mode	
<p>On time</p>	
<p>On+off time</p>	

Beamforming on

Mode 3: IEEE 802.11ac 20MHz Continuous TX mode

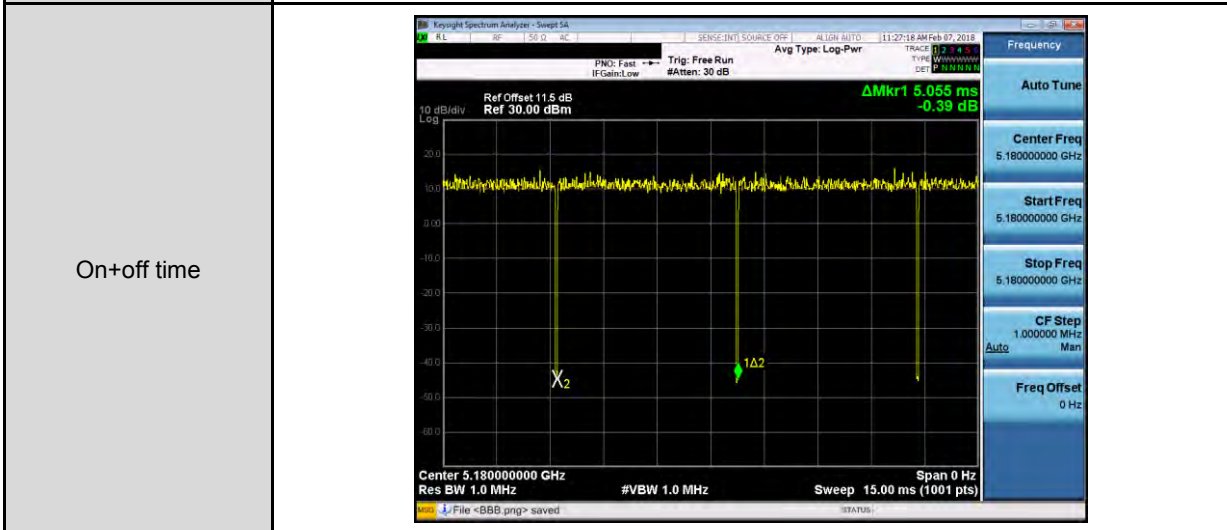
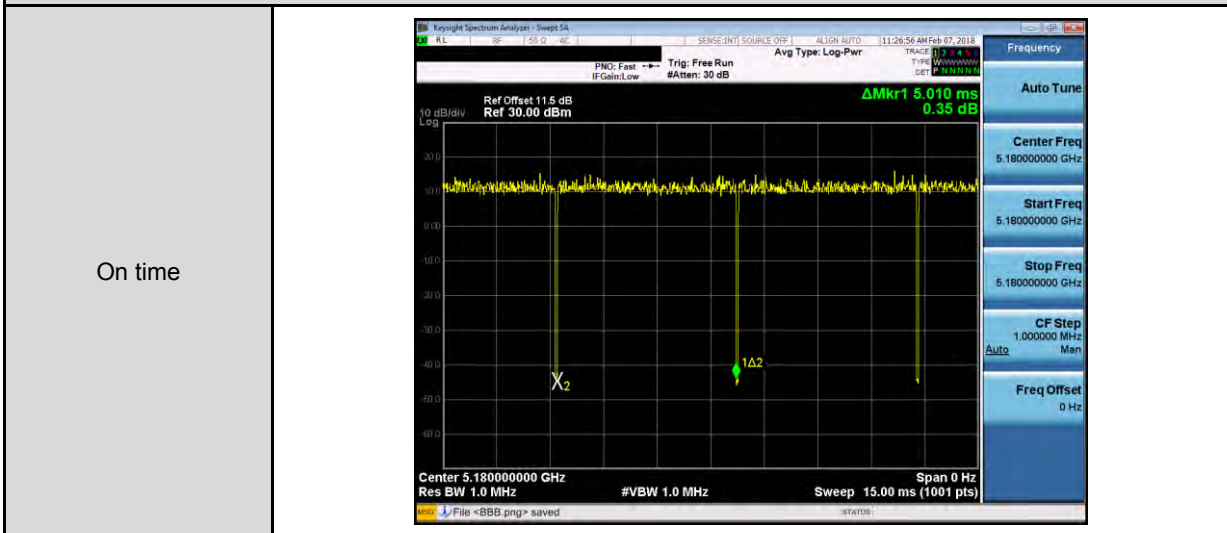

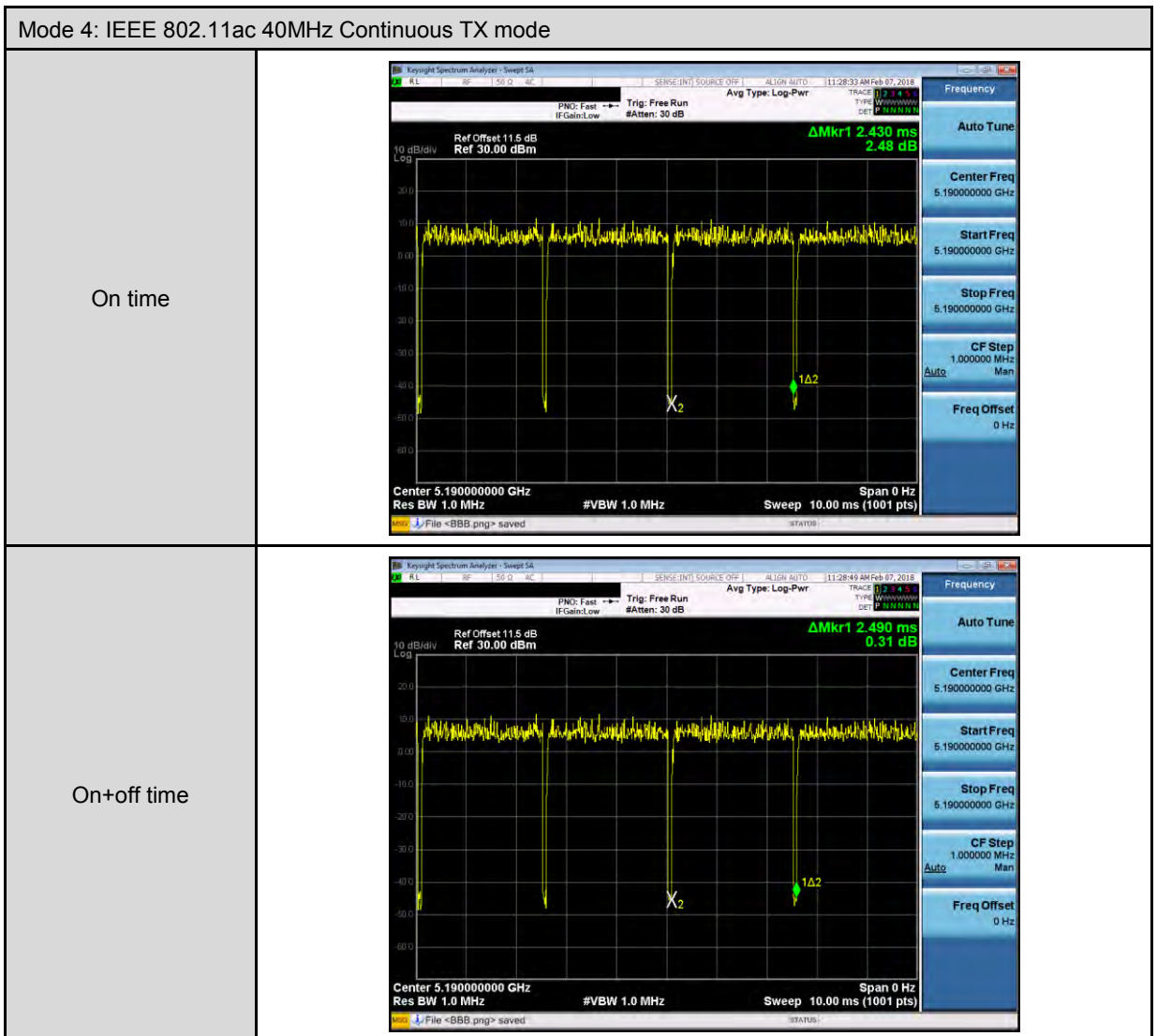

Mode 5: IEEE 802.11ac 80MHz Continuous TX mode	
On time	<p> Frequency: 5.21000000 GHz Center Freq: 5.21000000 GHz Start Freq: 5.21000000 GHz Stop Freq: 5.21000000 GHz CF Step: 1.000000 MHz Freq Offset: 0 Hz Center: 5.21000000 GHz Res BW: 1.0 MHz #VBW: 1.0 MHz Sweep: 5.000 ms (1001 pts) </p>
On+off time	<p> Frequency: 5.21000000 GHz Center Freq: 5.21000000 GHz Start Freq: 5.21000000 GHz Stop Freq: 5.21000000 GHz CF Step: 1.000000 MHz Freq Offset: 0 Hz Center: 5.21000000 GHz Res BW: 1.0 MHz #VBW: 1.0 MHz Sweep: 5.000 ms (1001 pts) </p>



3.2. EUT Exercise Software

The EUT is operated in the engineering mode to fix the TX frequency for the purposes of measurement. According to its specifications, the EUT must comply with the requirements of Section 15.407 under the FCC Rules Part 15 Subpart E.

1.	Setup the EUT shown on "Configuration of Test System Details"
2.	Turn on the power of all equipment.
3.	Turn on TX function.
4.	EUT run test program.

Measurement Software	
1	EZ-EMC Ver. ATL-03A1-1
2	EZ-EMC Ver ATL-ITC-3A1-1

3.3. Configuration of Test System Details

Conducted Emission

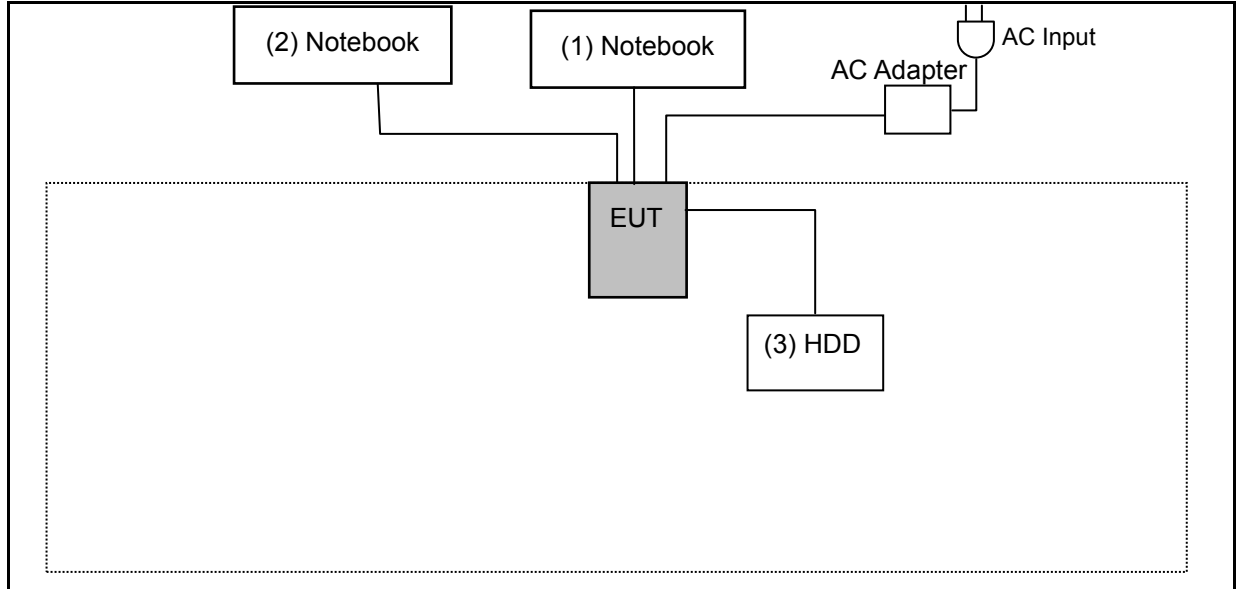

Radiated Emission

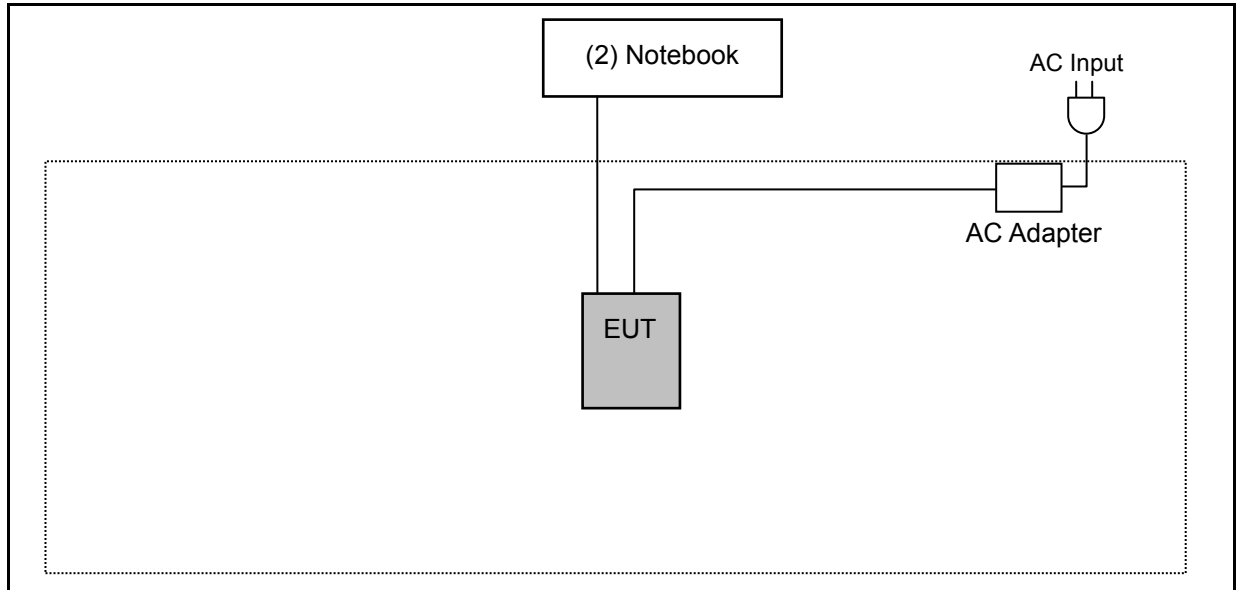

Devices Description					
	Product	Manufacturer	Model Number	Serial Number	Power Cord
(1)	Notebook	DELL	LAPTITU	25627158361	Non-Shielded, 0.8m
(2)	Notebook	DELL	LAPTITU E5440	6699565657	Non-Shielded, 1.8m
(3)	Hard Drive	WD	My Passport	S/N:WX71EB3RM271	Power by EUT



3.4. Test Instruments

For Conducted Emission

Equipment	Manufacturer	Model Number	Serial Number	Cal. Date	Cal. Period
Test Receiver	R&S	ESCI	100367	05/18/2017	1 year
LISN	R&S	ENV216	101040	04/01/2017	1 year
RF Cable	Woken	00100D1380194M	TE-02-02	05/19/2017	1 year

For Radiated Emissions

Equipment	Manufacturer	Model Number	Serial Number	Cal. Date	Cal. Period
Spectrum Analyzer (10Hz~44GHz)	Keysight	N9010A	MY52221312	01/15/2018	1 year
Pre Amplifier (1~26.5GHz)	Agilent	8449B	3008A02237	10/16/2017	1 year
Pre Amplifier (100KHz~1.3GHz)	Agilent	8447D	2944A11119	01/10/2018	1 year
Pre Amplifier (26.5~40GHz)	EMCI	EMC2654045	980028	08/29/2017	1 year
Pre Amplifier (1~26.5GHz)	EMCI	EMC012645SE	980289	01/17/2018	1 year
Broadband Antenna	Schwarzbeck	VULB9168	416	10/26/2017	1 year
Horn Antenna (1~18GHz)	SCHWARZBECK MESS-ELEKTRONIK	BBHA9120D	9120D-550	06/20/2017	1 year
Horn Antenna (18~40GHz)	ETS	3116	86467	09/19/2017	1 year

For Conducted

Equipment	Manufacturer	Model Number	Serial Number	Cal. Date	Cal. Period
Power Sensor	Anritsu	MA2411B	1126022	08/28/2017	1 year
Power Meter	Anritsu	ML2495A	1135009	08/28/2017	1 year
Spectrum Analyzer (10Hz~44GHz)	Agilent	N9010A	MY52221312	01/16/2018	1 year
Temperature & Humidity Chamber	TAICHY	MHU-225LA	980729	04/17/2017	1 year



3.5. Test Site Environment

Items	Required (IEC 60068-1)	Actual
Temperature (°C)	15-35	26
Humidity (%RH)	25-75	60
Barometric pressure (mbar)	860-1060	950

4 Measurement Procedure

4.1. AC Power Conducted Emission Measurement

■ Limit

Frequency (MHz)	Quasi-peak	Average
0.15 - 0.5	66 to 56	56 to 46
0.50 - 5.0	56	46
5.0 - 30.0	60	50

■ Test Setup

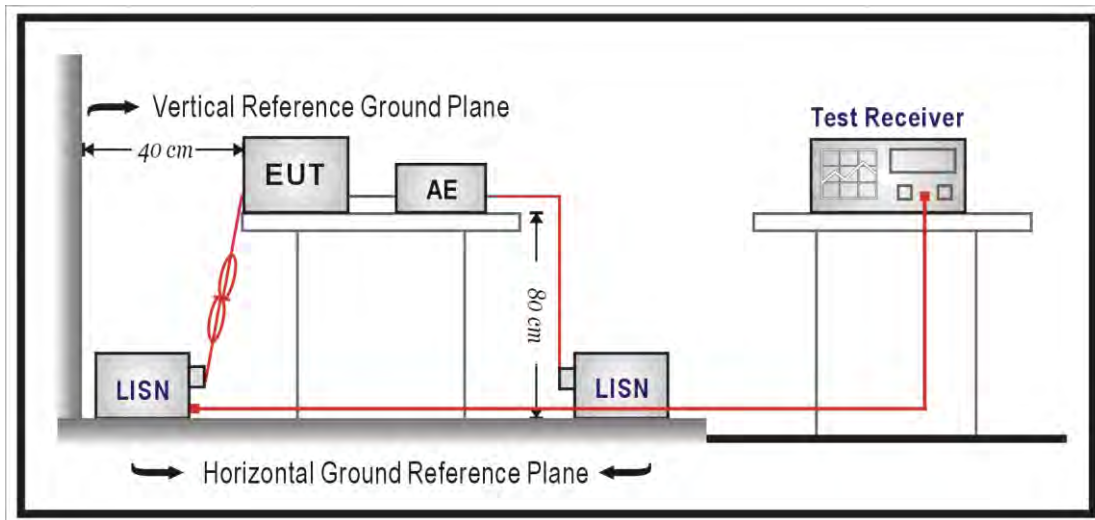

■ Test Procedure

The EUT and simulators are connected to the main power through a line impedance stabilization network (L.I.S.N.). This provides a $50\Omega // 50\mu\text{H}$ coupling impedance for the measuring equipment. The peripheral devices are also connected to the main power through a LISN that provides a $50\Omega // 50\mu\text{H}$ coupling impedance with 50ohm termination.

Tabletop device shall be placed on a non-conducting platform, of nominal size 1 m by 1.5 m, raised 80 cm above the reference ground plane. The wall of screened room shall be located 40cm to the rear of the EUT. Other surfaces of tabletop or floor standing EUT shall be at least 80cm from any other ground conducting surface including one or more LISNs. For floor-standing device shall be placed under the EUT with a 12mm insulating material.

Conducted emissions were investigated over the frequency range from 0.15 MHz to 30 MHz using a resolution bandwidth of 9 kHz. The equipment under test (EUT) shall be meet the limits in section 4.1, as applicable, including the average limit and the quasi-peak limit when using respectively, an average detector and quasi-peak detector measured in accordance with the methods described of related standard. When all of peak value were complied with quasi-peak and average limit from 150kHz to 30MHz then quasi-peak and average measurement was unnecessary.

The AMN shall be placed 0,8 m from the boundary of the unit under test and bonded to a ground reference plane for AMNs mounted on top of the ground reference plane. This distance is between the closest points of the AMN and the EUT. All other units of the EUT and associated equipment shall be at least 0,8 m from the AMN. If the mains power cable is longer than 1m then the cable shall be folded back and forth at the centre of the lead to form a bundle no longer than 0.4m. All of interconnecting cables that hang closer than 40cm to the ground plane shall be folded back and forth in the center forming a bundle 30 cm to 40 cm long. All of EUT and AE shall be separate place more than 0.1m. All 50Ω ports of the LISN shall be resistively terminated into 50Ω loads when not connected to the measuring instrument.

If the reading of the measuring receiver shows fluctuations close to the limit, the reading shall be observed for at least 15 s at each measurement frequency; the higher reading shall be recorded with the exception of any brief isolated high reading which shall be ignored.

4.2. Transmitter Radiated Emissions Measurement

■ Limit

(1)Undesirable emission limits. Except as shown in paragraph (b)(7) of this section, the maximum emissions outside of the frequency bands of operation shall be attenuated in accordance with the following limits:

(a)For transmitters operating in the 5.15-5.25 GHz band: All emissions outside of the 5.15-5.35 GHz band shall not exceed an e.i.r.p. of -27 dBm/MHz.

(b)For transmitters operating in the 5.25-5.35 GHz band: All emissions outside of the 5.15-5.35 GHz band shall not exceed an e.i.r.p. of -27 dBm/MHz.

(c)For transmitters operating in the 5.47-5.725 GHz band: All emissions outside of the 5.47-5.725 GHz band shall not exceed an e.i.r.p. of -27 dBm/MHz.

(d)For transmitters operating in the 5.725-5.85 GHz band:

(i)All emissions shall be limited to a level of -27 dBm/MHz at 75 MHz or more above or below the band edge increasing linearly to 10 dBm/MHz at 25 MHz above or below the band edge, and from 25 MHz above or below the band edge increasing linearly to a level of 15.6 dBm/MHz at 5 MHz above or below the band edge, and from 5 MHz above or below the band edge increasing linearly to a level of 27 dBm/MHz at the band edge.

(2)Limits of Radiated Emission Measurement

Emissions radiated outside of the specified bands, shall be according to the general radiated limits in 15.209 as following:

Frequency Range (MHz)	Field Strength (microvolts/meter)	Measurement Distance (meters)
0.009 ~ 0.490	2400/F(kHz)	300
0.490 ~ 1.705	24000/F(kHz)	30
1.705 ~ 30.0	30	30
30 ~ 88	10	3
88 ~ 216	150	3
216 ~ 960	200	3
Above 960	500	3

Note: 1. The lower limit shall apply at the transition frequencies.

2. Emission level (dBuV/m) = 20 log Emission level (uV/m).

3. As shown in 15.35(b), for frequencies above 1000MHz, the field strength limits are based on average detector, however, the peak field strength of any emission shall not exceed the maximum permitted average limits, specified above by more than 20dB under any condition of modulation.

■ Setup

9kHz ~ 30MHz

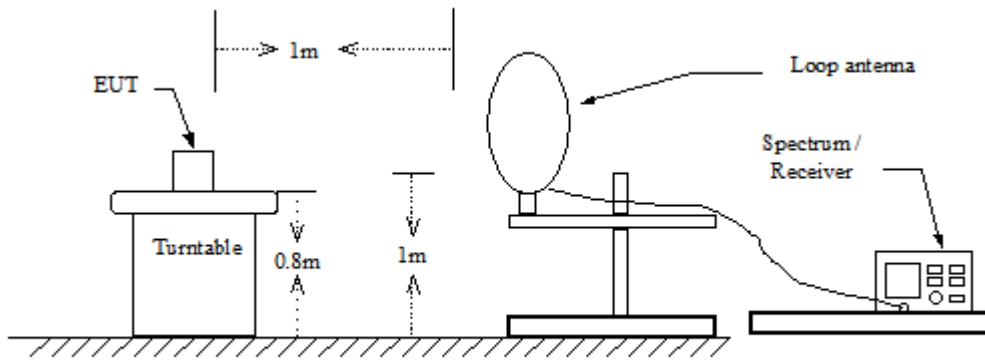

30MHz ~ 1GHz

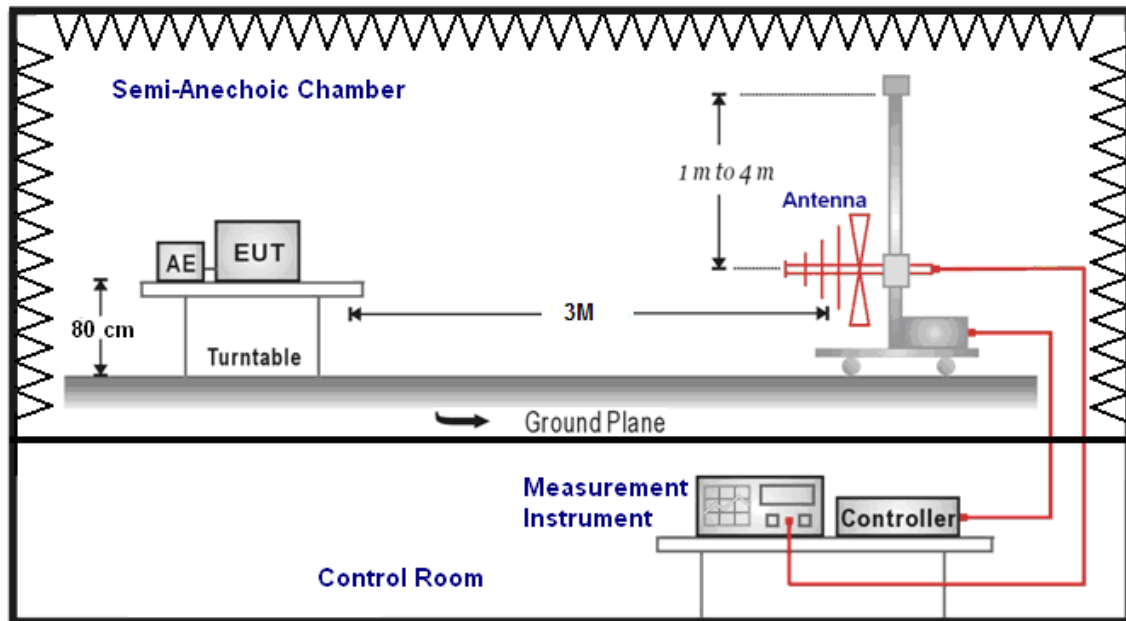

Above 1GHz

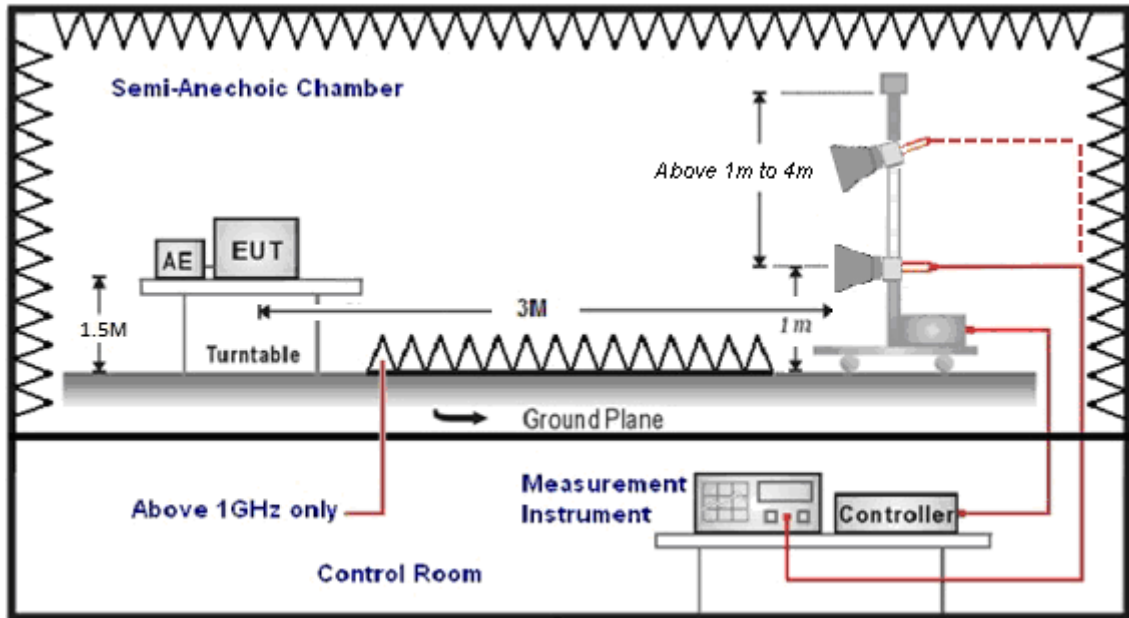

■ Test Procedure

Final radiation measurements were made on a three-meter, Semi Anechoic Chamber. The EUT system was placed on a nonconductive turntable which is 0.8 or 1.5 meters height (below 1GHz use 0.8m turntable / above 1GHz use 1.5m turntable), top surface 1.0 x 1.5 meter. The spectrum was examined from 250 MHz to 2.5 GHz in order to cover the whole spectrum below 10th harmonic which could generate from the EUT. During the test, EUT was set to transmit continuously & Measurements spectrum range from 9 kHz to 40 GHz is investigated.

For measurements below 1 GHz the resolution bandwidth is set to 100 kHz for peak detection measurements or 120 kHz for quasi-peak detection measurements. Peak detection is used unless otherwise noted as quasi-peak.

For restricted measurements above 1 GHz the resolution bandwidth is set to 1 MHz, and then the video bandwidth is set to 3 MHz for peak measurements and 10 Hz for average measurements when Duty cycle > 0.98 / 1/T for average measurements when Duty cycle < 0.98.

For out of band measurements above 1 GHz the resolution bandwidth is set to 1 MHz, and then the video bandwidth is set to 3 MHz for peak measurements.

A nonconductive material surrounded the EUT to supporting the EUT for standing on three orthogonal planes. At each condition, the EUT was rotated 360 degrees, and the antenna was raised and lowered from one to four meters to find the maximum emission levels. Measurements were taken using both horizontal and vertical antenna polarization.

SCHWARZBECK MESS-ELEKTRONIK Trilog-Broadband Antenna at 3 Meter and the ETS-Lindgren Double-Ridged Waveguide Horn antenna Schwarzbeck Mess-Elektronik Broadband Horn Antenna was used in frequencies 1 – 40 GHz at a distance of 3 meter. The antenna at an angle toward the source of the emission. All test results were extrapolated to equivalent signal at 3 meters utilizing an inverse linear distance extrapolation Factor (20dB/decade).

For testing above 1GHz, the emission level of the EUT in peak mode was 20dB lower than average limit (that means the emission level in peak mode also complies with the limit in average mode), then testing will be stopped and peak values of EUT will be reported, otherwise, the emissions will be measured in average mode again and reported.

Appropriate preamplifiers were used for improving sensitivity and precautions were taken to avoid overloading or desensitizing the spectrum analyzer. No post – detector video filters were used in the test.

The spectrum analyzer's 6 dB bandwidth was set to 1 MHz, and the analyzer was operated in the peak detection mode, for frequencies both below and up 1 GHz. The average levels were obtained by subtracting the duty cycle correction factor from the peak readings.

The following procedures were used to convert the emission levels measured in decibels referenced to 1 microvolt (dBuV) into field intensity in micro volts per meter (uV/m).

The actual field intensity in decibels referenced to 1 microvolt in to field intensity in micro volts per meter (dBuV/m).



The actual field intensity in referenced to 1 microvolt per meter (dBuV/m) is determined by algebraically adding the measured reading in dBuV, the antenna factor (dB), and cable loss (dB) and Subtracting the gain of preamplifier (dB) is auto calculate in spectrum analyzer.

$$(1) \text{ Amplitude (dBuV/m) = FI (dBuV) +AF (dBuV) +CL (dBuV)-Gain (dB)}$$

FI= Reading of the field intensity.

AF= Antenna factor.

CL= Cable loss.

P.S Amplitude is auto calculate in spectrum analyzer.

$$(2) \text{ Actual Amplitude (dBuV/m) = Amplitude (dBuV)-Dis(dB)}$$

The FCC specified emission limits were calculated according the EUT operating frequency and by following linear interpolation equations:

(a) For fundamental frequency : Transmitter Output < +30dBm

(b) For spurious frequency : Spurious emission limits = fundamental emission limit /10

Measuring Instruments and setting

The following table is the setting of spectrum analyzer and receiver.

Spectrum Parameter	Setting
Attenuation	Auto
Start Frequency	1000MHz
Stop Frequency	40GHz
RBW/VBW(Emission in restricted band)	1MHz / 3MHz for Peak 1MHz / (1/T) for Average
RBW/VBW(Emission in non-restricted band)	1MHz / 3MHz for Peak

4.3. Maximum Conducted Output Power Measurement

■ **Limit**

Frequency Range (MHz)	FCC Maximum Conducted Output Power Limit
	Master
5.150 ~ 5.250 GHz	The lesser of 1W (30dBm)
5.725 ~ 5.850 GHz	The lesser of 1W (30dBm)

According FCC KDB 662911 D01 v02r01 – for power measurements on IEEE802.11 devices

MIMO/Beamforming on

5.150 ~ 5.250 GHz

* Directional Gain = $10 \cdot \log\{[10^{(G1/20)} + 10^{(G2/20)} + \dots + 10^{(Gn/20)}]^2 / NANT\}$ = 7.95 dBi > 6dBi

* power limit shall be reduced = $30 - 1.95 = 28.05$ dBm

5.725 ~ 5.850 GHz

* Directional Gain = $10 \cdot \log\{[10^{(G1/20)} + 10^{(G2/20)} + \dots + 10^{(Gn/20)}]^2 / NANT\}$ = 8.26 dBi > 6dBi

* power limit shall be reduced = $30 - 2.26 = 27.74$ dBm

■ **Test Setup**

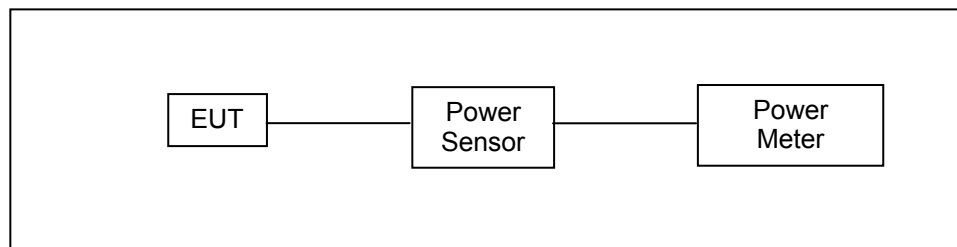

■ **Test Procedure**

The test is performed in accordance with KDB789033: D02 General UNII Test Procedures New Rules v02r01, Guidelines for Compliance Testing of Unlicensed National Information Infrastructure (U-NII) Devices

Section (E) Maximum Conducted Output Power

3. Measurement using a Power Meter (PM)

b) Method PM-G (Measurement using a gated RF average power meter)

4.4. 26dB RF Bandwidth Measurement & 99 % Occupied Bandwidth Measurement

■ **Limit**

N/A

■ **Test Setup**

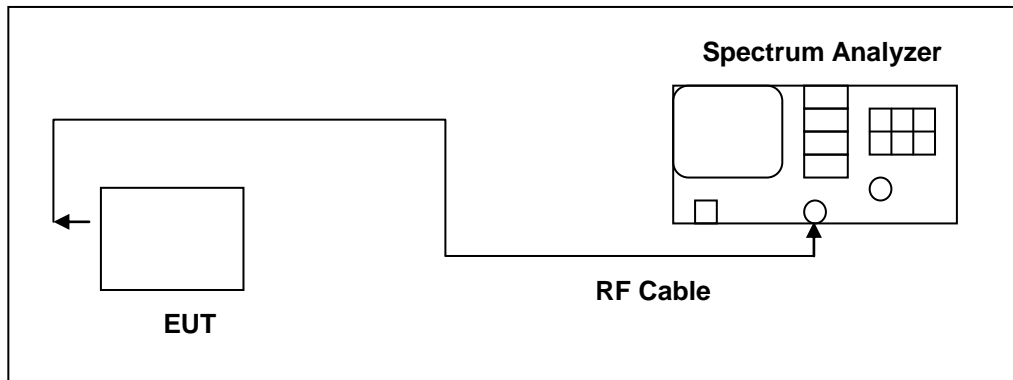

■ **Test Procedure**

The test is performed in accordance with KDB789033: D02 General UNII Test Procedures New Rules v02r01, Guidelines for Compliance Testing of Unlicensed National Information Infrastructure (U-NII) Devices - Part 15, Subpart E.

Spectrum Parameter	Setting
Attenuation	Auto
Span Frequency	>26dB Bandwidth
RBW	Approximately 1% of the emission bandwidth
VBW	VBW > RBW
Detector	Peak
Trace	Max Hold
Sweep Time	Auto

4.5. 6dB RF Bandwidth Measurement

- **Limit**

- 6dB RF Bandwidth**

- Systems using digital modulation techniques may operate in the 5725~5850MHz bands. The minimum 6 dB band-width shall be at least 500 kHz.

- **Test Setup**

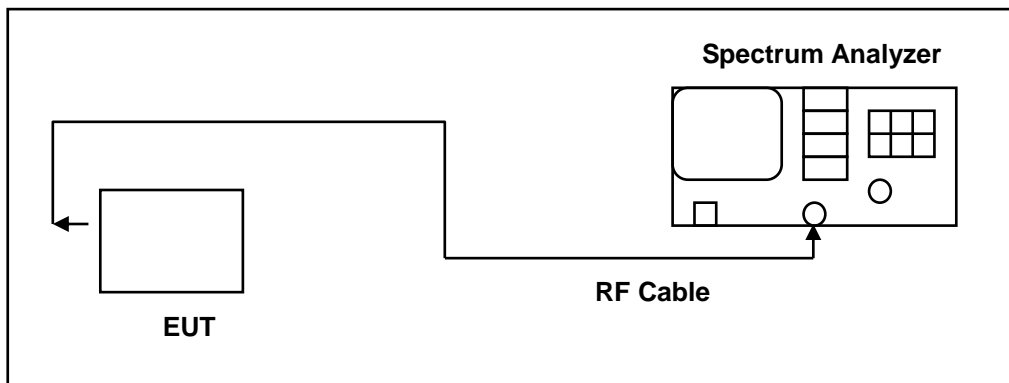

- **Test Procedure**

- 6dB RF Bandwidth**

- The EUT tested to UNII test procedure of KDB789033 D02 for compliance to FCC 47CFR 15.407 requirements.

- The antenna port of the EUT was connected to the input of a spectrum analyzer. Analyzer RES BW was set to 100 kHz. For each RF output channel investigated, the spectrum analyzer center frequency was set to the channel carrier. A peak output reading was taken, a DISPLAY line was drawn 6 dB lower than peak level. The 6 dB bandwidth was determined from where the channel output spectrum intersected the display line.

- The test was performed at 3 channels.

4.6. Maximum Power Spectral Density Measurement

■ Limit

Conducted power spectral density

Frequency Range (MHz)	FCC Limit
	Master
5.150 ~ 5.250 GHz	17 dBm/MHz
5.725 ~ 5.850 GHz	30 dBm/500KHz

According FCC KDB 662911 D01 v02r01 – for power spectral density measurements on IEEE802.11 devices,

CDD/MIMO/Beamforming on

5.150 ~ 5.250 GHz

- * Directional Gain = $10 \cdot \log\{[10^{G1/20} + 10^{G2/20} + \dots + 10^{Gn/20}]^2 / NANT\}$ = 7.95 dBi > 6dBi
- * power spectral density limit shall be reduced = $17 - 1.95 = 15.05$ dBm/MHz

5.725 ~ 5.850 GHz

- * Directional Gain = $10 \cdot \log\{[10^{G1/20} + 10^{G2/20} + \dots + 10^{Gn/20}]^2 / NANT\}$ = 8.26 dBi > 6dBi
- * power spectral density limit shall be reduced = $30 - 2.26 = 27.74$ dBm/500KHz

■ Test Setup

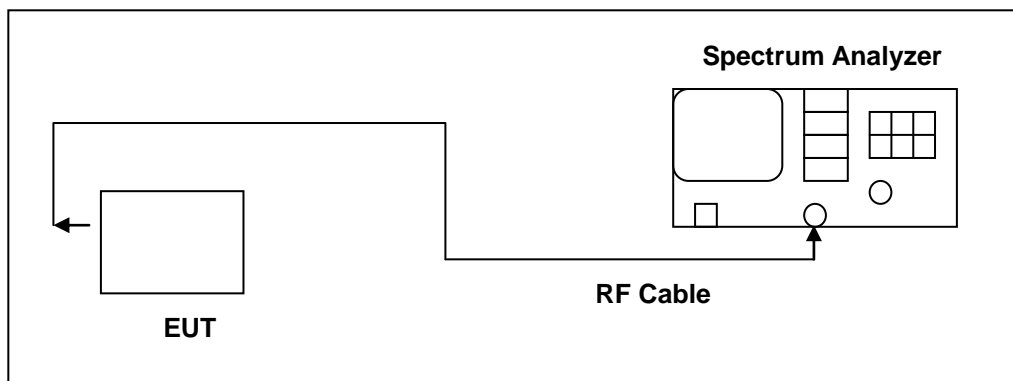

**■ Test Procedure**

The test is performed in accordance with KDB789033: D02 General UNII Test Procedures New Rules v02r01, Guidelines for Compliance Testing of Unlicensed National Information Infrastructure (U-NII) Devices - Part 15, Subpart E.

Spectrum Parameter	Setting
Attenuation	Auto
Span Frequency	Encompass the entire emissions bandwidth (EBW) of the signal
RBW	1 MHz (5725 ~ 5850MHz use 100 kHz)
VBW	3 MHz (5725 ~ 5850MHz use 300 kHz)
Detector	RMS
Trace	AVERAGE
Sweep Time	Auto
Trace Average	100 times
Note: If measurement bandwidth of Maximum PSD is specified in 500 kHz, add $10\log(500\text{kHz}/100\text{kHz})$ to the measured result.	

4.7. Frequency Stability Measurement

■ Limit

Manufacturers of U-NII devices are responsible for ensuring frequency stability such that an emission is maintained within the band of operation under all conditions of normal operation as specified in the users manual.

■ Test Setup

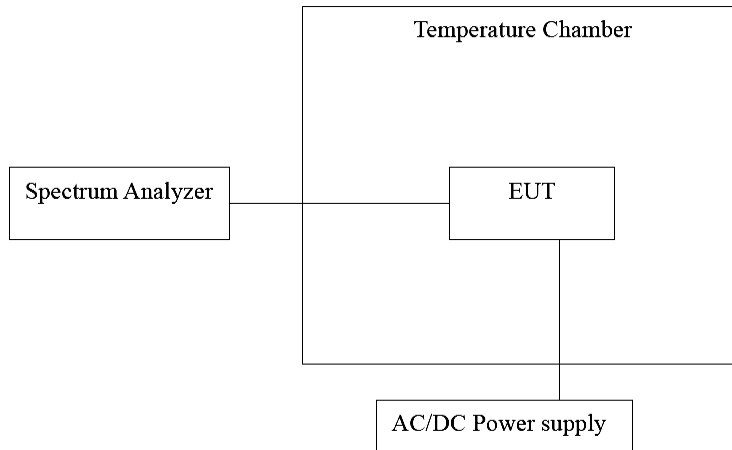

■ Test Procedure

1. The EUT was placed inside the environmental test chamber and powered by nominal AC/DC voltage.
2. Turn the EUT on and couple its output to a spectrum analyzer.
3. Turn the EUT off and set the chamber to the highest temperature specified.
4. Allow sufficient time (approximately 30 min) for the temperature of the chamber to stabilize.
5. Repeat step 2 and 3 with the temperature chamber set to the lowest temperature.
6. The test chamber was allowed to stabilize at +20 degree C for a minimum of 30 minutes. The supply voltage was then adjusted on the EUT from 85% to 115% and the frequency record.



4.8. Automatically discontinue transmission

The device shall automatically discontinue transmission in case of either absence of information to transmit or operational failure. These provisions are not intended to preclude the transmission of control or signalling information or the use of repetitive codes used by certain digital technologies to complete frame or burst intervals. Applicants shall include in their application for equipment authorization a description of how this requirement is met.

4.9. Antenna Requirement

- **Limit**

For intentional device, according to 15.203, an intentional radiator shall be designed to ensure that no antenna other than that furnished by the responsible party shall be used with the device.

And According to 15.407 (a), if transmitting antennas of directional gain greater than 6 dBi are used, the power shall be reduced by the amount in dB that the directional gain of the antenna exceeds 6dBi.

5 Test Results

5.1. AC Power Conducted Emission Measurement

Standard:	FCC Part 15.407	Line:	L1
Test item:	Conducted Emission	Power:	AC 120V/60Hz
Mode:	Mode 1	Temp.(°C)/Hum.(%RH):	26(°C)/60%RH
Description:	Adapter Model Number: DSA-12PFT-12 FUS 120100		

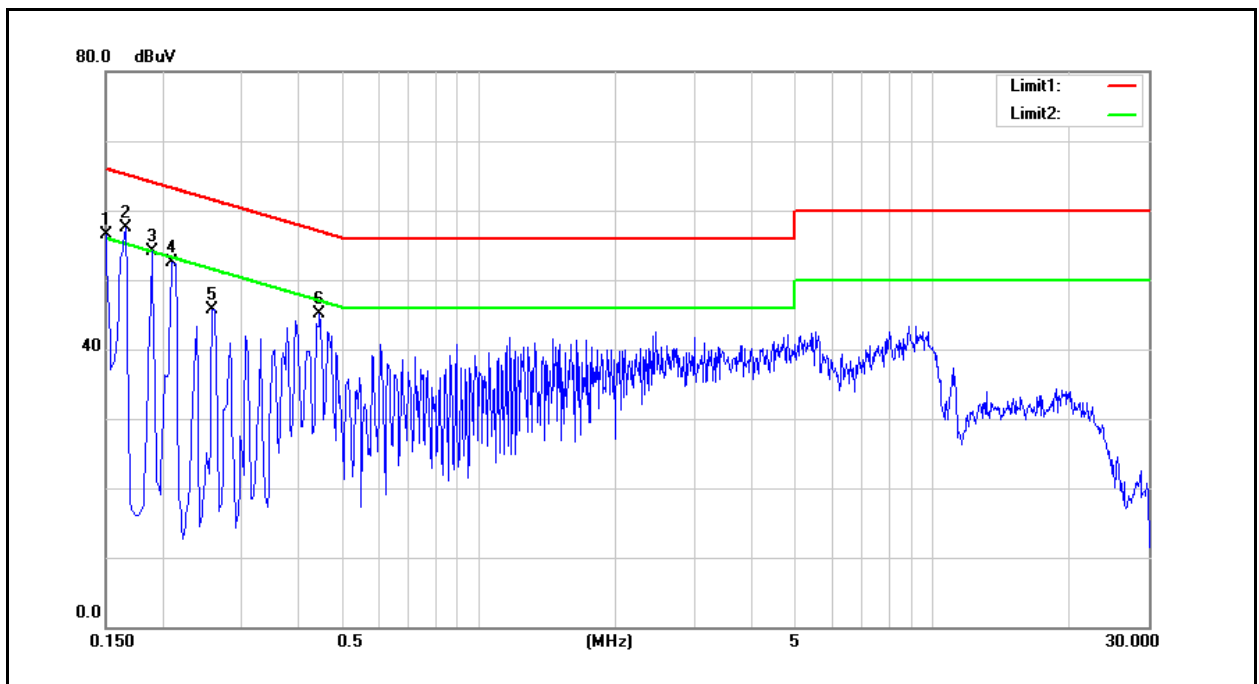

No.	Frequency (MHz)	QP reading (dBuV)	AVG reading (dBuV)	Correction factor (dB)	QP result (dBuV)	AVG result (dBuV)	QP limit (dBuV)	AVG limit (dBuV)	QP margin (dB)	AVG margin (dB)	Remark
1	0.1500	43.07	23.82	9.53	52.60	33.35	66.00	56.00	-13.40	-22.65	Pass
2	0.1660	44.53	27.99	9.54	54.07	37.53	65.16	55.16	-11.09	-17.63	Pass
3	0.1900	31.47	8.09	9.53	41.00	17.62	64.04	54.04	-23.04	-36.42	Pass
4	0.2100	40.52	26.11	9.53	50.05	35.64	63.21	53.21	-13.16	-17.57	Pass
5	0.2580	33.95	17.63	9.53	43.48	27.16	61.50	51.50	-18.02	-24.34	Pass
6	0.4460	28.31	19.13	9.54	37.85	28.67	56.95	46.95	-19.10	-18.28	Pass

Note: 1. Result (dBuV/m) = Correct Factor (dB/m) + Reading(dBuV).

2. Correction factor (dB) = Cable loss (dB) + L.I.S.N. factor (dB).



Standard:	FCC Part 15.407	Line:	N
Test item:	Conducted Emission	Power:	AC 120V/60Hz
Mode:	Mode 1	Temp.(°C)/Hum.(%RH):	26(°C)/60%RH
Description:		Adapter Model Number: DSA-12PFT-12 FUS 120100	

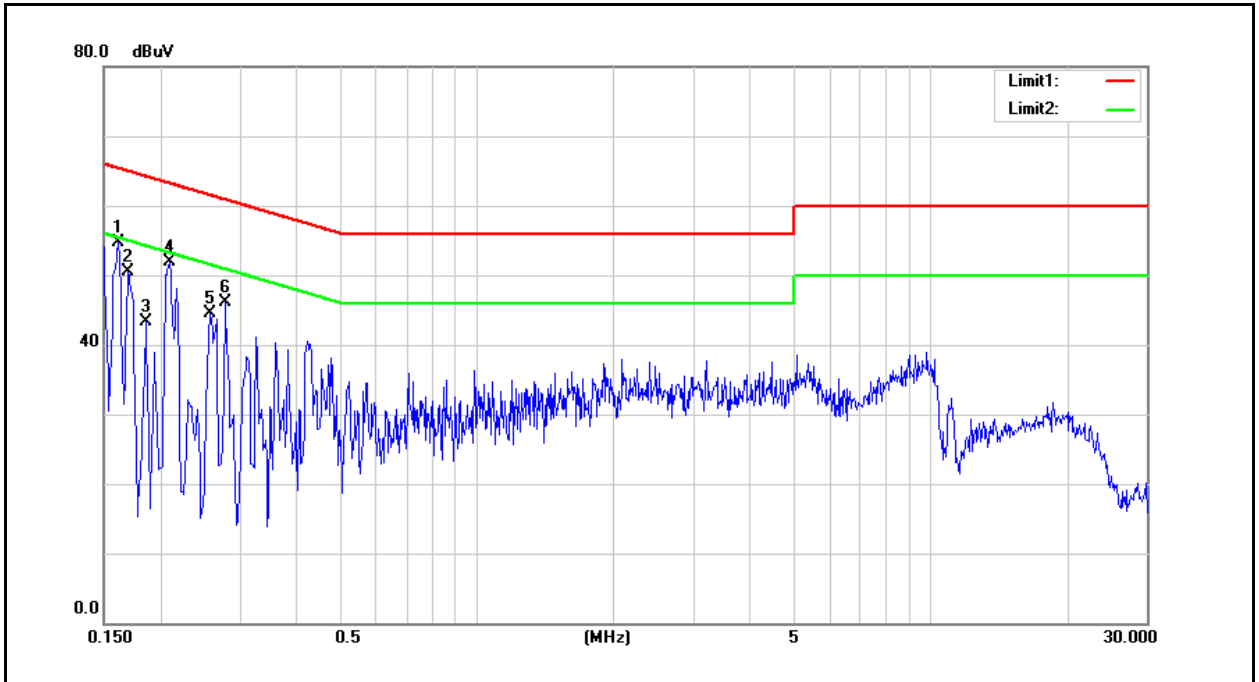

No.	Frequency (MHz)	QP reading (dBuV)	AVG reading (dBuV)	Correction factor (dB)	QP result (dBuV)	AVG result (dBuV)	QP limit (dBuV)	AVG limit (dBuV)	QP margin (dB)	AVG margin (dB)	Remark
1	0.1620	45.17	31.04	9.63	54.80	40.67	65.36	55.36	-10.56	-14.69	Pass
2	0.1700	40.57	20.94	9.63	50.20	30.57	64.96	54.96	-14.76	-24.39	Pass
3	0.1860	30.82	9.79	9.63	40.45	19.42	64.21	54.21	-23.76	-34.79	Pass
4	0.2100	38.94	23.91	9.63	48.57	33.54	63.21	53.21	-14.64	-19.67	Pass
5	0.2580	32.75	16.28	9.63	42.38	25.91	61.50	51.50	-19.12	-25.59	Pass
6	0.2780	29.74	12.64	9.63	39.37	22.27	60.88	50.88	-21.51	-28.61	Pass

Note: 1. Result (dBuV/m) = Correct Factor (dB/m) + Reading(dBuV).
 2. Correction factor (dB) = Cable loss (dB) + L.I.S.N. factor (dB).



Standard:	FCC Part 15.407	Line:	L1
Test item:	Conducted Emission	Power:	AC 120V/60Hz
Mode:	Mode 1	Temp.(°C)/Hum.(%RH):	26(°C)/60%RH
Description:		Adapter Model Number: PA1015-120HUB125	

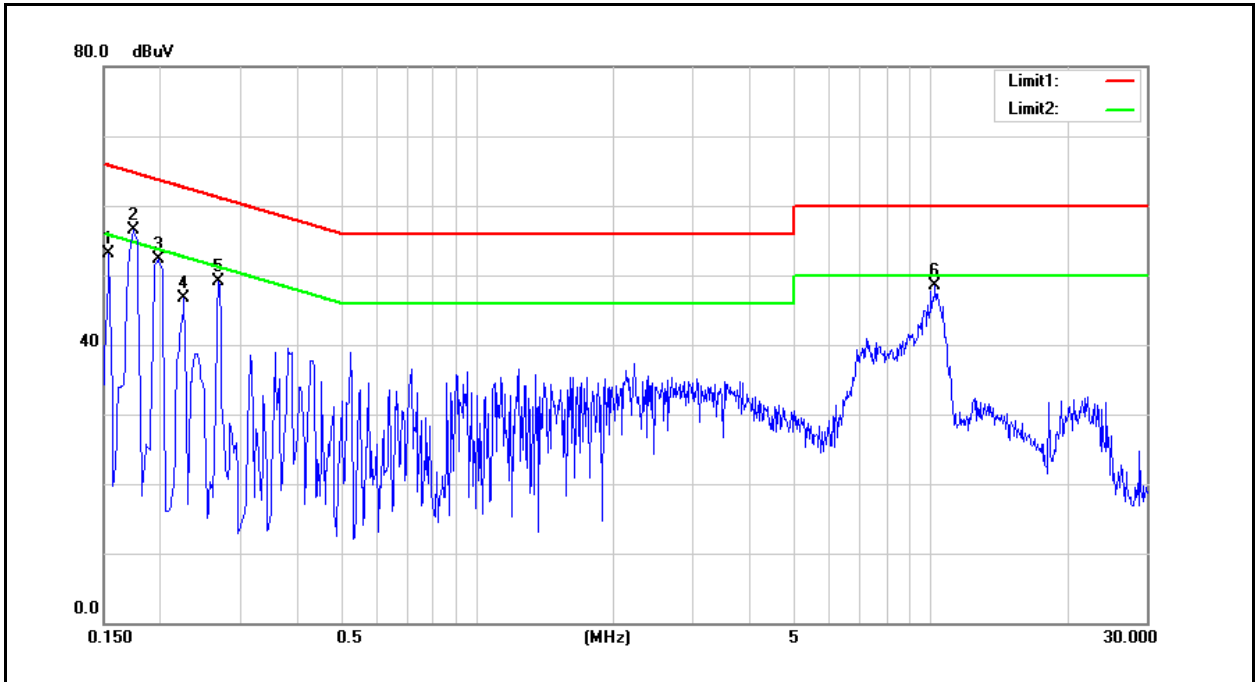

No.	Frequency (MHz)	QP reading (dBuV)	AVG reading (dBuV)	Correction factor (dB)	QP result (dBuV)	AVG result (dBuV)	QP limit (dBuV)	AVG limit (dBuV)	QP margin (dB)	AVG margin (dB)	Remark
1	0.1540	45.99	30.14	9.54	55.53	39.68	65.78	55.78	-10.25	-16.10	Pass
2	0.1740	38.47	18.49	9.54	48.01	28.03	64.77	54.77	-16.76	-26.74	Pass
3	0.1980	40.80	24.01	9.53	50.33	33.54	63.69	53.69	-13.36	-20.15	Pass
4	0.2260	28.51	14.95	9.53	38.04	24.48	62.60	52.60	-24.56	-28.12	Pass
5	0.2700	37.19	23.95	9.53	46.72	33.48	61.12	51.12	-14.40	-17.64	Pass
6	10.2700	33.53	22.93	9.80	43.33	32.73	60.00	50.00	-16.67	-17.27	Pass

Note: 1. Result (dBuV/m) = Correct Factor (dB/m) + Reading(dBuV).
 2. Correction factor (dB) = Cable loss (dB) + L.I.S.N. factor (dB).



Standard:	FCC Part 15.407	Line:	N
Test item:	Conducted Emission	Power:	AC 120V/60Hz
Mode:	Mode 1	Temp.(°C)/Hum.(%RH):	26(°C)/60%RH
Description:	Adapter Model Number: PA1015-120HUB125		

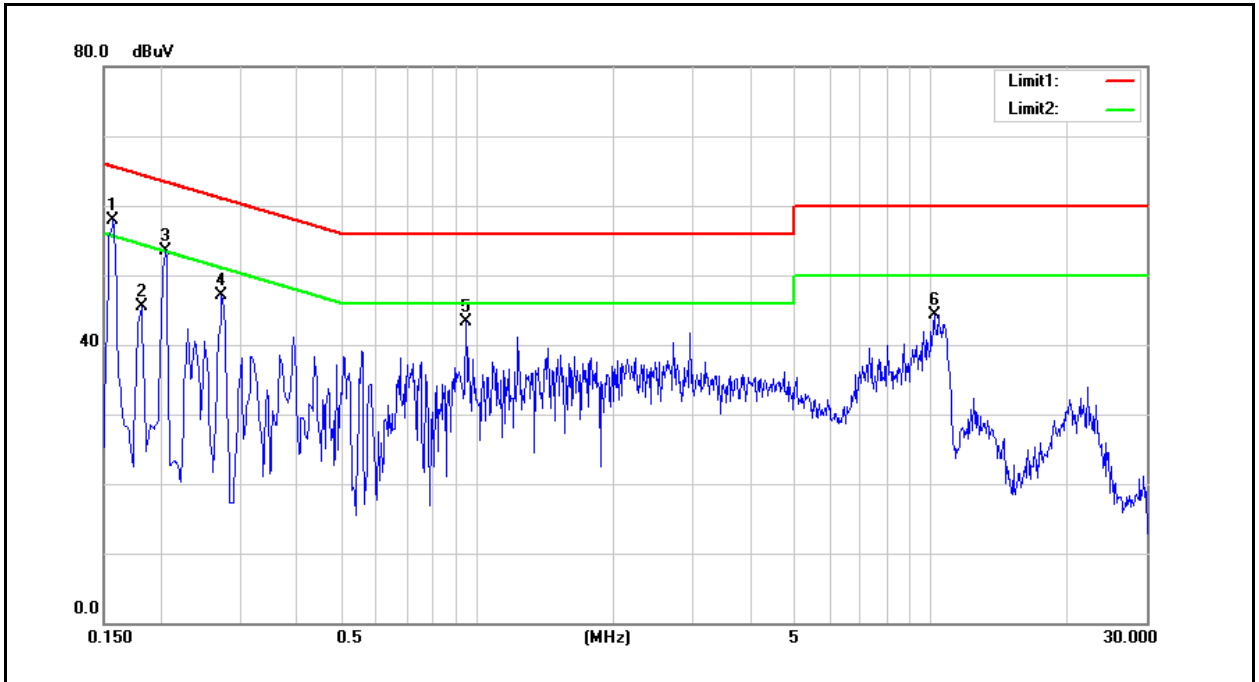

No.	Frequency (MHz)	QP reading (dBuV)	AVG reading (dBuV)	Correction factor (dB)	QP result (dBuV)	AVG result (dBuV)	QP limit (dBuV)	AVG limit (dBuV)	QP margin (dB)	AVG margin (dB)	Remark
1	0.1580	45.96	29.55	9.63	55.59	39.18	65.57	55.57	-9.98	-16.39	Pass
2	0.1820	35.42	19.17	9.63	45.05	28.80	64.39	54.39	-19.34	-25.59	Pass
3	0.2060	33.79	13.93	9.63	43.42	23.56	63.37	53.37	-19.95	-29.81	Pass
4	0.2740	37.54	30.45	9.63	47.17	40.08	61.00	51.00	-13.83	-10.92	Pass
5	0.9460	26.43	18.85	9.67	36.10	28.52	56.00	46.00	-19.90	-17.48	Pass
6	10.2180	28.15	17.54	9.93	38.08	27.47	60.00	50.00	-21.92	-22.53	Pass

Note: 1. Result (dBuV/m) = Correct Factor (dB/m) + Reading(dBuV).
 2. Correction factor (dB) = Cable loss (dB) + L.I.S.N. factor (dB).



Standard:	FCC Part 15.407	Line:	L1
Test item:	Conducted Emission	Power:	AC 120V/60Hz
Mode:	Mode 1	Temp.(°C)/Hum.(%RH):	26(°C)/60%RH
Description:		Adapter Model Number: PS1012-120HUB100	

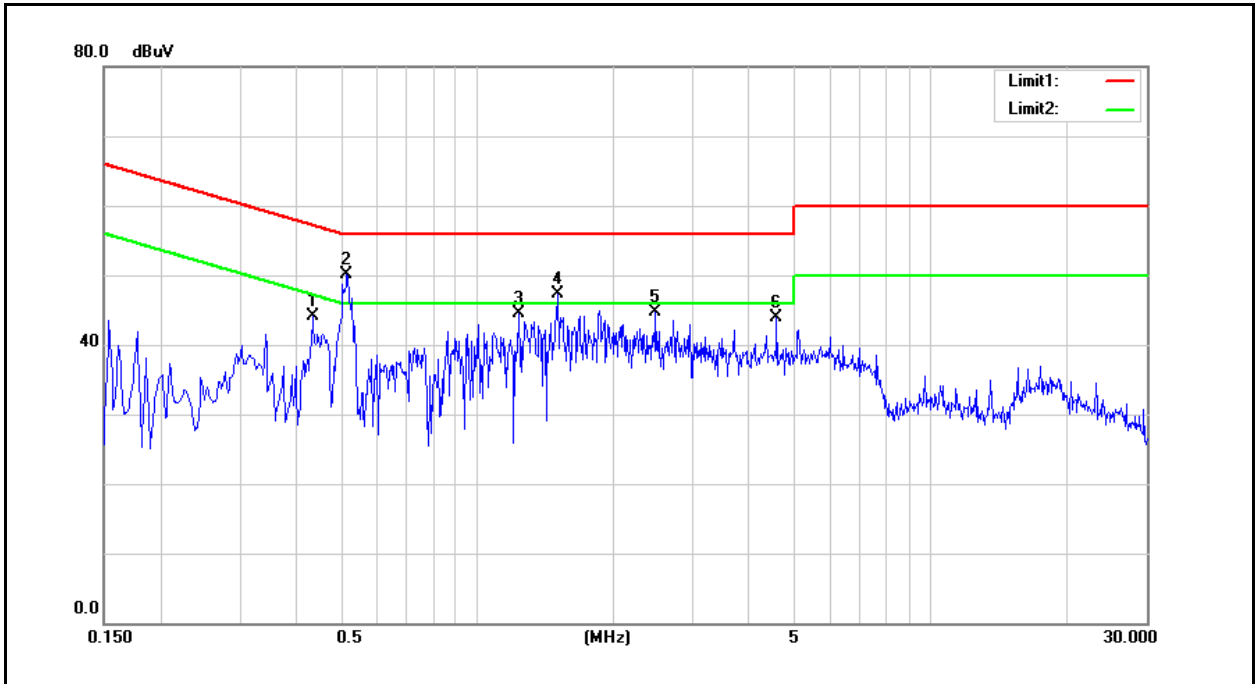

No.	Frequency (MHz)	QP reading (dBuV)	AVG reading (dBuV)	Correction factor (dB)	QP result (dBuV)	AVG result (dBuV)	QP limit (dBuV)	AVG limit (dBuV)	QP margin (dB)	AVG margin (dB)	Remark
1	0.4340	28.52	20.42	9.54	38.06	29.96	57.18	47.18	-19.12	-17.22	Pass
2	0.5180	37.24	29.54	9.54	46.78	39.08	56.00	46.00	-9.22	-6.92	Pass
3	1.2420	29.19	19.25	9.58	38.77	28.83	56.00	46.00	-17.23	-17.17	Pass
4	1.5100	31.86	22.23	9.60	41.46	31.83	56.00	46.00	-14.54	-14.17	Pass
5	2.4860	29.38	20.17	9.62	39.00	29.79	56.00	46.00	-17.00	-16.21	Pass
6	4.5900	25.39	16.90	9.68	35.07	26.58	56.00	46.00	-20.93	-19.42	Pass

Note: 1. Result (dBuV/m) = Correct Factor (dB/m) + Reading(dBuV).
 2. Correction factor (dB) = Cable loss (dB) + L.I.S.N. factor (dB).



Standard:	FCC Part 15.407	Line:	N
Test item:	Conducted Emission	Power:	AC 120V/60Hz
Mode:	Mode 1	Temp.(°C)/Hum.(%RH):	26(°C)/60%RH
Description:		Adapter Model Number: PS1012-120HUB100	

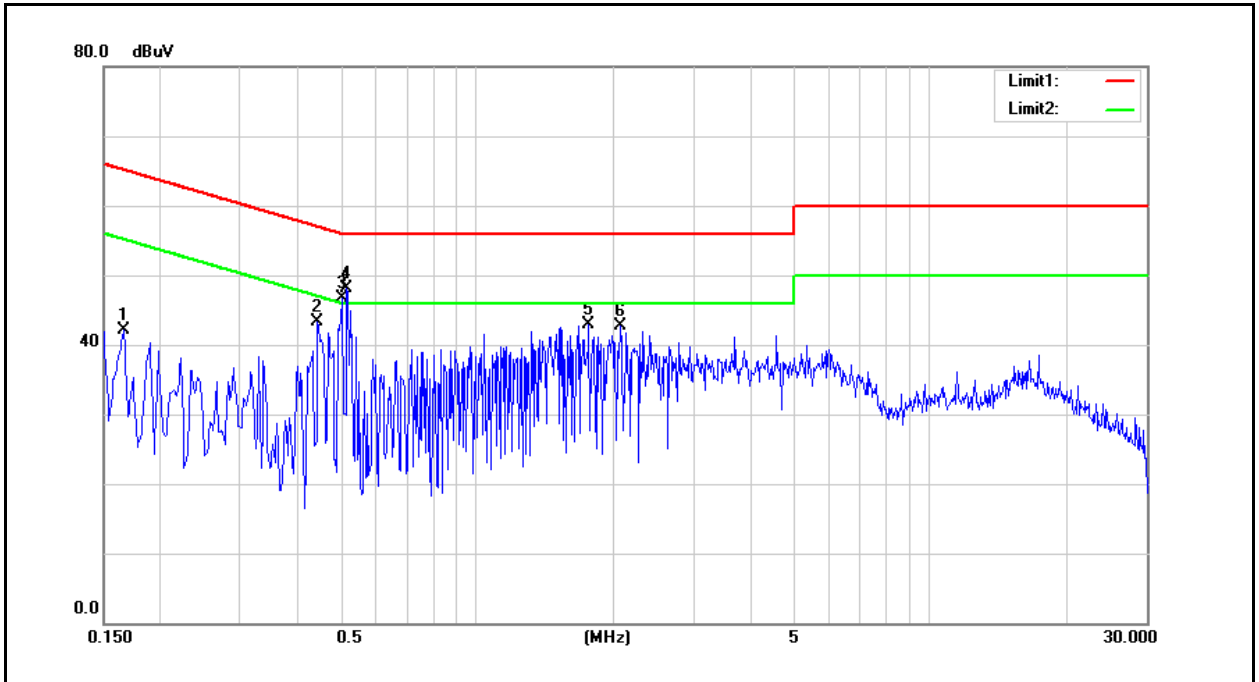

No.	Frequency (MHz)	QP reading (dBuV)	AVG reading (dBuV)	Correction factor (dB)	QP result (dBuV)	AVG result (dBuV)	QP limit (dBuV)	AVG limit (dBuV)	QP margin (dB)	AVG margin (dB)	Remark
1	0.1660	32.51	18.88	9.63	42.14	28.51	65.16	55.16	-23.02	-26.65	Pass
2	0.4460	28.94	15.47	9.64	38.58	25.11	56.95	46.95	-18.37	-21.84	Pass
3	0.5020	33.82	20.48	9.64	43.46	30.12	56.00	46.00	-12.54	-15.88	Pass
4	0.5180	35.82	22.18	9.64	45.46	31.82	56.00	46.00	-10.54	-14.18	Pass
5	1.7700	28.26	16.00	9.70	37.96	25.70	56.00	46.00	-18.04	-20.30	Pass
6	2.0740	26.55	14.12	9.71	36.26	23.83	56.00	46.00	-19.74	-22.17	Pass

Note: 1. Result (dBuV/m) = Correct Factor (dB/m) + Reading(dBuV).

2. Correction factor (dB) = Cable loss (dB) + L.I.S.N. factor (dB).



5.2. Transmitter Radiated Emissions Measurement

Below 1GHz

Standard:	FCC Part 15.407	Test Distance:	3m				
Test item:	Harmonic	Power:	AC 120V/60Hz				
Test Mode:	Mode 1	Temp.(°C)/Hum.(%RH):	26(°C)/60%RH				
Description:	Adapter Model Number: DSA-12PFT-12 FUS 120100						
Frequency (MHz)	Reading (dBuV)	Correct Factor (dB/m)	Result (dBuV/m)	Limit (dBuV/m)	Margin (dB)	Remark	Ant.Polar. H / V
141.5500	34.48	-5.71	28.77	43.50	-14.73	QP	H
159.0100	32.46	-5.08	27.38	43.50	-16.12	QP	H
184.2300	32.41	-6.72	25.69	43.50	-17.81	QP	H
341.3700	26.51	-2.43	24.08	46.00	-21.92	QP	H
568.3500	28.02	2.06	30.08	46.00	-15.92	QP	H
800.1800	27.31	6.50	33.81	46.00	-12.19	QP	H
89.1700	41.67	-11.92	29.75	43.50	-13.75	QP	V
138.6400	36.82	-5.96	30.86	43.50	-12.64	QP	V
187.1400	38.20	-6.90	31.30	43.50	-12.20	QP	V
231.7600	35.30	-6.14	29.16	46.00	-16.84	QP	V
431.5800	30.15	-0.48	29.67	46.00	-16.33	QP	V
744.8900	26.67	5.74	32.41	46.00	-13.59	QP	V

Note:1.Result (dBuV/m) = Correct Factor (dB/m) + Reading(dBuV).

2.Correction factor (dB/m) = Antenna Factor (dB/m) + Cable loss (dB) – Pre-Amplifier gain (dB).

3. When the peak results are less than average limit, so not need to evaluate the average.



Standard:		FCC Part 15.407		Test Distance:		3m	
Test item:		Harmonic		Power:		AC 120V/60Hz	
Test Mode:		Mode 1		Temp.(°C)/Hum.(%RH):		26(°C)/60%RH	
Description:		Adapter Model Number: PA1015-120HUB125					
Frequency (MHz)	Reading (dBuV)	Correct Factor (dB/m)	Result (dBuV/m)	Limit (dBuV/m)	Margin (dB)	Remark	Ant.Polar. H / V
140.5800	43.01	-5.77	37.24	43.50	-6.26	QP	H
206.5400	36.66	-7.09	29.57	43.50	-13.93	QP	H
402.4800	32.17	-1.09	31.08	46.00	-14.92	QP	H
499.4800	34.79	0.66	35.45	46.00	-10.55	QP	H
515.9700	32.10	0.96	33.06	46.00	-12.94	QP	H
907.8500	27.78	8.82	36.60	46.00	-9.40	QP	H
402.4800	32.93	-1.09	31.84	46.00	-14.16	QP	V
493.6600	34.58	0.57	35.15	46.00	-10.85	QP	V
499.4800	37.95	0.66	38.61	46.00	-7.39	QP	V
516.9400	31.93	0.97	32.90	46.00	-13.10	QP	V
648.8600	28.59	3.56	32.15	46.00	-13.85	QP	V
886.5100	27.69	8.38	36.07	46.00	-9.93	QP	V

Note:1.Result (dBuV/m) = Correct Factor (dB/m) + Reading(dBuV).

2.Correction factor (dB/m) = Antenna Factor (dB/m) + Cable loss (dB) – Pre-Amplifier gain (dB).

3. When the peak results are less than average limit, so not need to evaluate the average.



Standard:		FCC Part 15.407		Test Distance:		3m	
Test item:		Harmonic		Power:		AC 120V/60Hz	
Test Mode:		Mode 1		Temp.(°C)/Hum.(%RH):		26(°C)/60%RH	
Description:		Adapter Model Number: PS1012-120HUB100					
Frequency (MHz)	Reading (dBuV)	Correct Factor (dB/m)	Result (dBuV/m)	Limit (dBuV/m)	Margin (dB)	Remark	Ant.Polar. H / V
127.9700	38.65	-7.12	31.53	43.50	-11.97	QP	H
182.2900	34.48	-6.59	27.89	43.50	-15.61	QP	H
277.3500	28.85	-3.87	24.98	46.00	-21.02	QP	H
499.4800	30.51	0.66	31.17	46.00	-14.83	QP	H
655.6500	26.61	3.70	30.31	46.00	-15.69	QP	H
860.3200	26.53	7.78	34.31	46.00	-11.69	QP	H
127.0000	43.07	-7.22	35.85	43.50	-7.65	QP	V
190.0500	40.91	-7.07	33.84	43.50	-9.66	QP	V
241.4600	33.88	-5.45	28.43	46.00	-17.57	QP	V
274.4400	30.24	-4.00	26.24	46.00	-19.76	QP	V
513.0600	28.07	0.91	28.98	46.00	-17.02	QP	V
818.6100	26.67	6.89	33.56	46.00	-12.44	QP	V

Note:1.Result (dBuV/m) = Correct Factor (dB/m) + Reading(dBuV).

2.Correction factor (dB/m) = Antenna Factor (dB/m) + Cable loss (dB) – Pre-Amplifier gain (dB).

3. When the peak results are less than average limit, so not need to evaluate the average.



Above 1GHz

Standard:	FCC Part 15.407	Test Distance:	3m
Test item:	Harmonic	Power:	AC 120V/60Hz
Frequency:	5180MHz	Temp.(°C)/Hum.(%RH):	26(°C)/60%RH
Mode:	Mode 2		
Ant.Polar.:	Horizontal		

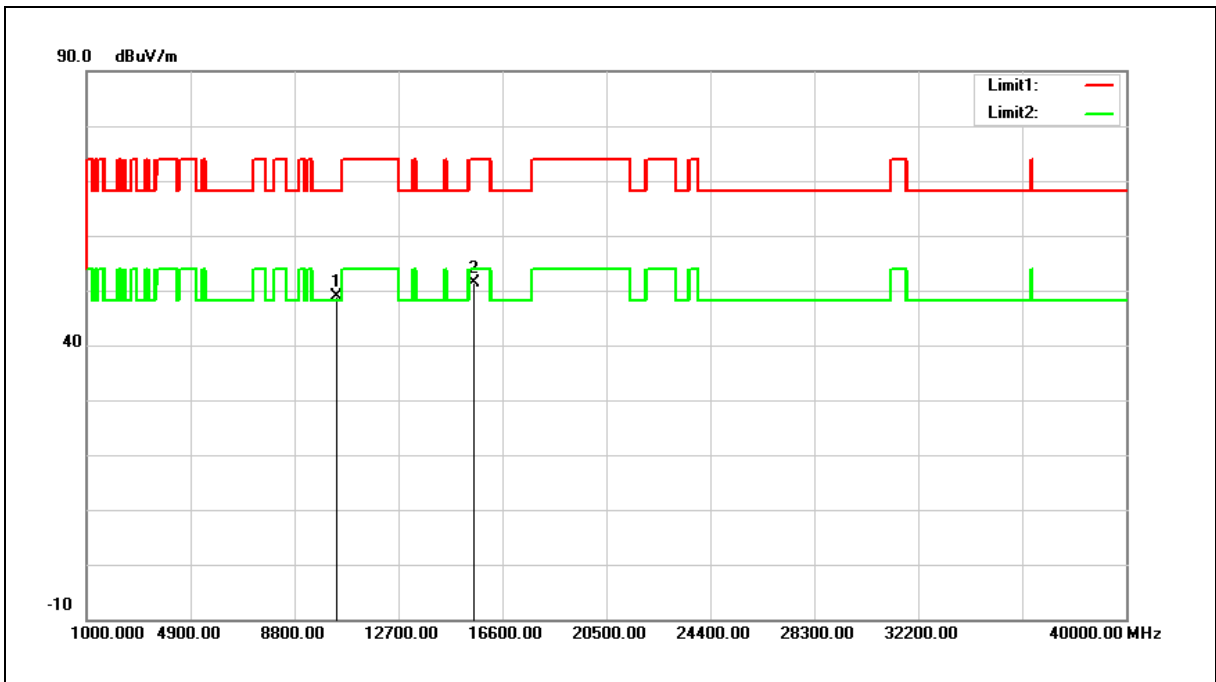

No.	Frequency (MHz)	Reading (dBuV)	Correct Factor (dB/m)	Result (dBuV/m)	Limit (dBuV/m)	Margin (dB)	Remark
1	10360.000	32.85	16.09	48.94	68.20	-19.26	peak
2	15540.000	33.14	18.35	51.49	74.00	-22.51	peak

Note: 1.Result (dBuV/m) = Correct Factor (dB/m) + Reading(dBuV).

2.Correction factor (dB/m) = Antenna Factor (dB/m) + Cable loss (dB) – Pre-Amplifier gain (dB).

3.When the peak results are less than average limit, so not need to evaluate the average.



Standard:	FCC Part 15.407	Test Distance:	3m
Test item:	Harmonic	Power:	AC 120V/60Hz
Frequency:	5180MHz	Temp.(°C)/Hum. (%RH):	26(°C)/60%RH
Mode:	Mode 2		
Ant.Polar.:	Vertical		

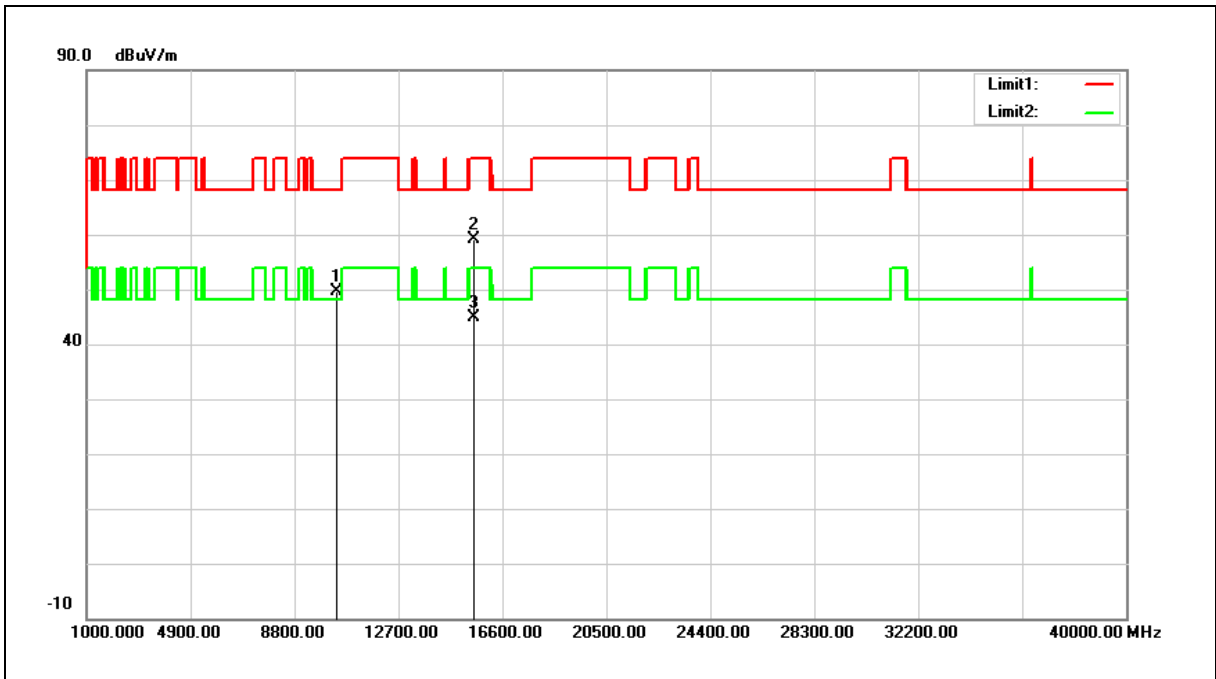

No.	Frequency (MHz)	Reading (dBuV)	Correct Factor (dB/m)	Result (dBuV/m)	Limit (dBuV/m)	Margin (dB)	Remark
1	10360.000	33.42	16.09	49.51	68.20	-18.69	peak
2	15540.000	40.74	18.35	59.09	74.00	-14.91	peak
3	15540.000	26.61	18.35	44.96	54.00	-9.04	AVG

Note:1.Result (dBuV/m) = Correct Factor (dB/m) + Reading(dBuV).

2.Correction factor (dB/m) = Antenna Factor (dB/m) + Cable loss (dB) – Pre-Amplifier gain (dB).

3.When the peak results are less than average limit, so not need to evaluate the average.



Standard:	FCC Part 15.407	Test Distance:	3m
Test item:	Harmonic	Power:	AC 120V/60Hz
Frequency:	5200MHz	Temp.(°C)/Hum.(%RH):	26(°C)/60%RH
Mode:	Mode 2		
Ant.Polar.:	Horizontal		

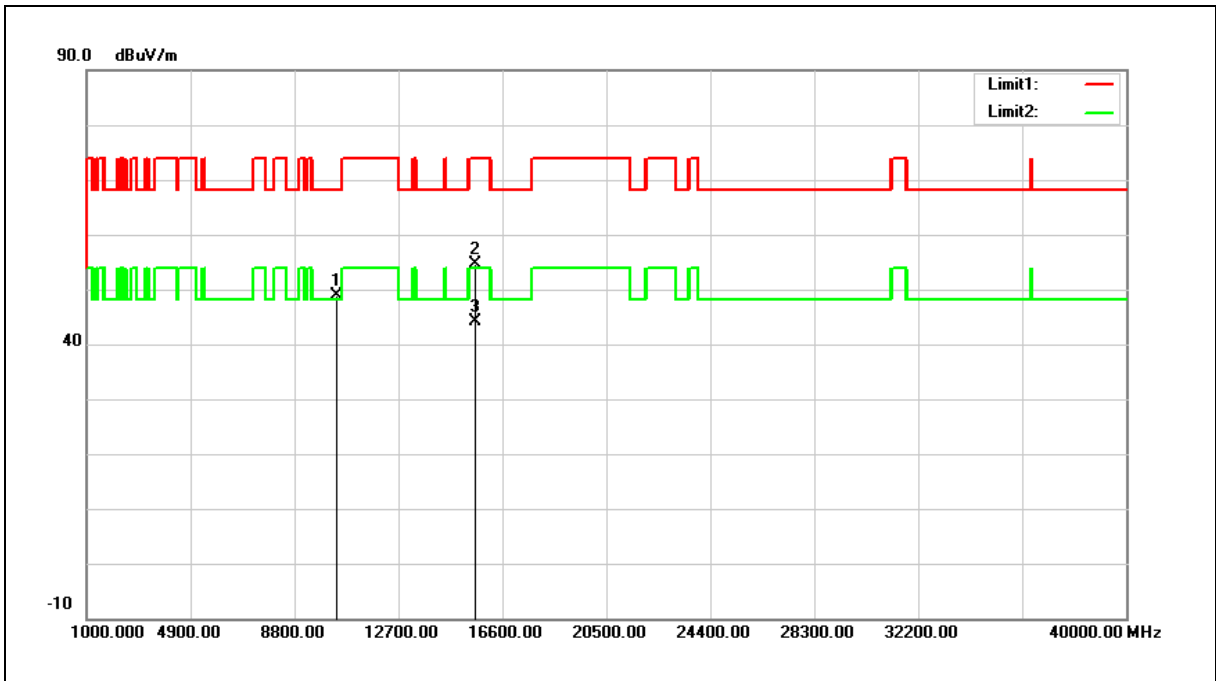

No.	Frequency (MHz)	Reading (dBuV)	Correct Factor (dB/m)	Result (dBuV/m)	Limit (dBuV/m)	Margin (dB)	Remark
1	10400.000	32.73	16.22	48.95	68.20	-19.25	peak
2	15600.000	36.35	18.19	54.54	74.00	-19.46	peak
3	15600.000	26.05	18.19	44.24	54.00	-9.76	AVG

Note:1.Result (dBuV/m) = Correct Factor (dB/m) + Reading(dBuV).

2.Correction factor (dB/m) = Antenna Factor (dB/m) + Cable loss (dB) – Pre-Amplifier gain (dB).

3.When the peak results are less than average limit, so not need to evaluate the average.



Standard:	FCC Part 15.407	Test Distance:	3m
Test item:	Harmonic	Power:	AC 120V/60Hz
Frequency:	5200MHz	Temp.(°C)/Hum.(%RH):	26(°C)/60%RH
Mode:	Mode 2		
Ant.Polar.:	Vertical		

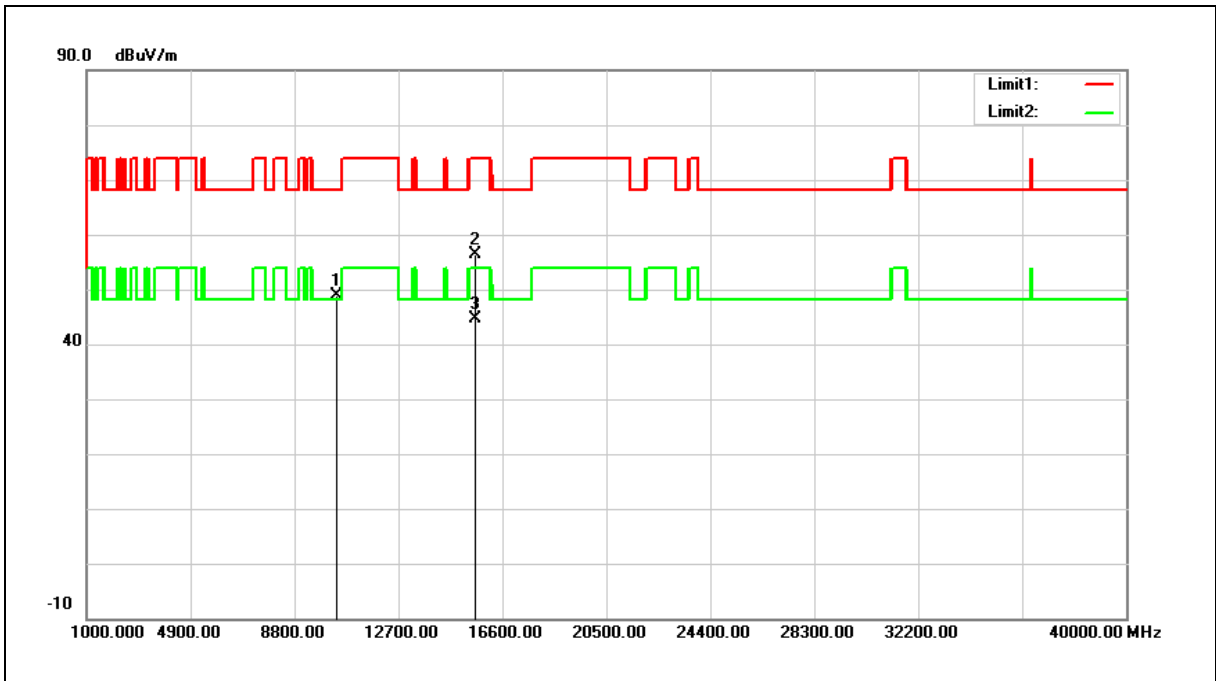

No.	Frequency (MHz)	Reading (dBuV)	Correct Factor (dB/m)	Result (dBuV/m)	Limit (dBuV/m)	Margin (dB)	Remark
1	10400.000	32.73	16.22	48.95	68.20	-19.25	peak
2	15600.000	38.28	18.19	56.47	74.00	-17.53	peak
3	15600.000	26.55	18.19	44.74	54.00	-9.26	AVG

Note:1.Result (dBuV/m) = Correct Factor (dB/m) + Reading(dBuV).

2.Correction factor (dB/m) = Antenna Factor (dB/m) + Cable loss (dB) – Pre-Amplifier gain (dB).

3.When the peak results are less than average limit, so not need to evaluate the average.



Standard:	FCC Part 15.407	Test Distance:	3m
Test item:	Harmonic	Power:	AC 120V/60Hz
Frequency:	5240MHz	Temp.(°C)/Hum.(%RH):	26(°C)/60%RH
Mode:	Mode 2		
Ant.Polar.:	Horizontal		

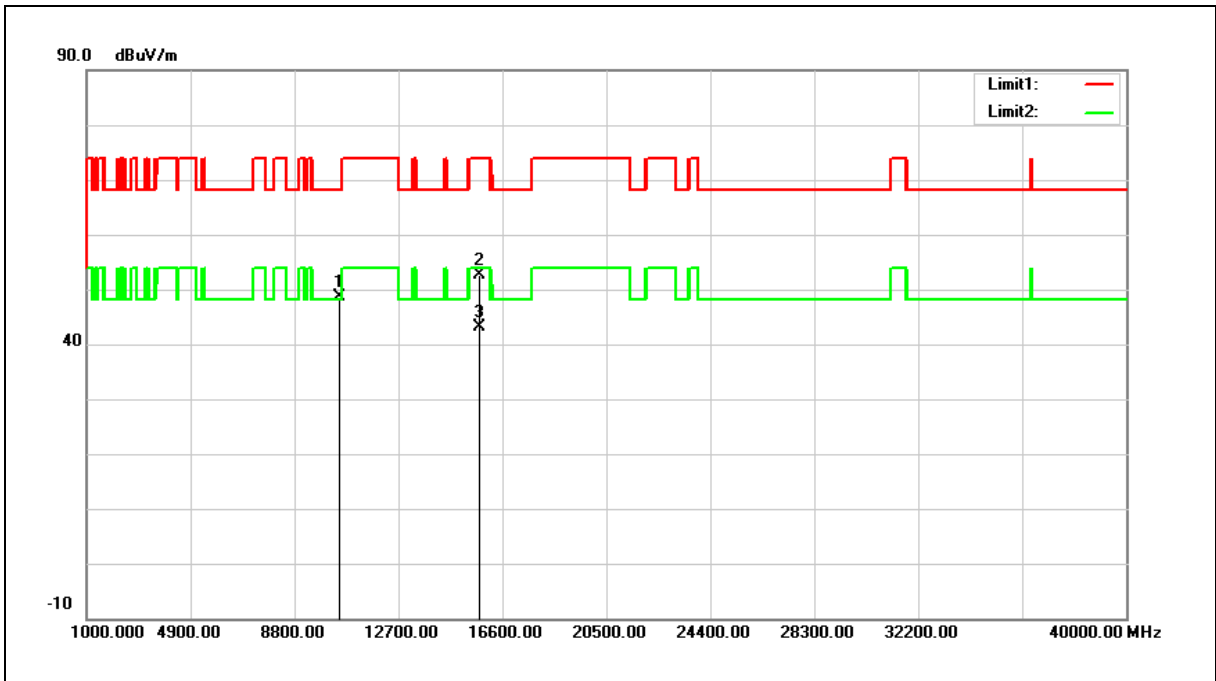

No.	Frequency (MHz)	Reading (dBuV)	Correct Factor (dB/m)	Result (dBuV/m)	Limit (dBuV/m)	Margin (dB)	Remark
1	10480.000	32.10	16.47	48.57	68.20	-19.63	peak
2	15720.000	34.67	17.88	52.55	74.00	-21.45	peak
3	15720.000	25.19	17.88	43.07	54.00	-10.93	AVG

Note:1.Result (dBuV/m) = Correct Factor (dB/m) + Reading(dBuV).

2.Correction factor (dB/m) = Antenna Factor (dB/m) + Cable loss (dB) – Pre-Amplifier gain (dB).

3.When the peak results are less than average limit, so not need to evaluate the average.



Standard:	FCC Part 15.407	Test Distance:	3m
Test item:	Harmonic	Power:	AC 120V/60Hz
Frequency:	5240MHz	Temp.(°C)/Hum.(%RH):	26(°C)/60%RH
Mode:	Mode 2		
Ant.Polar.:	Vertical		

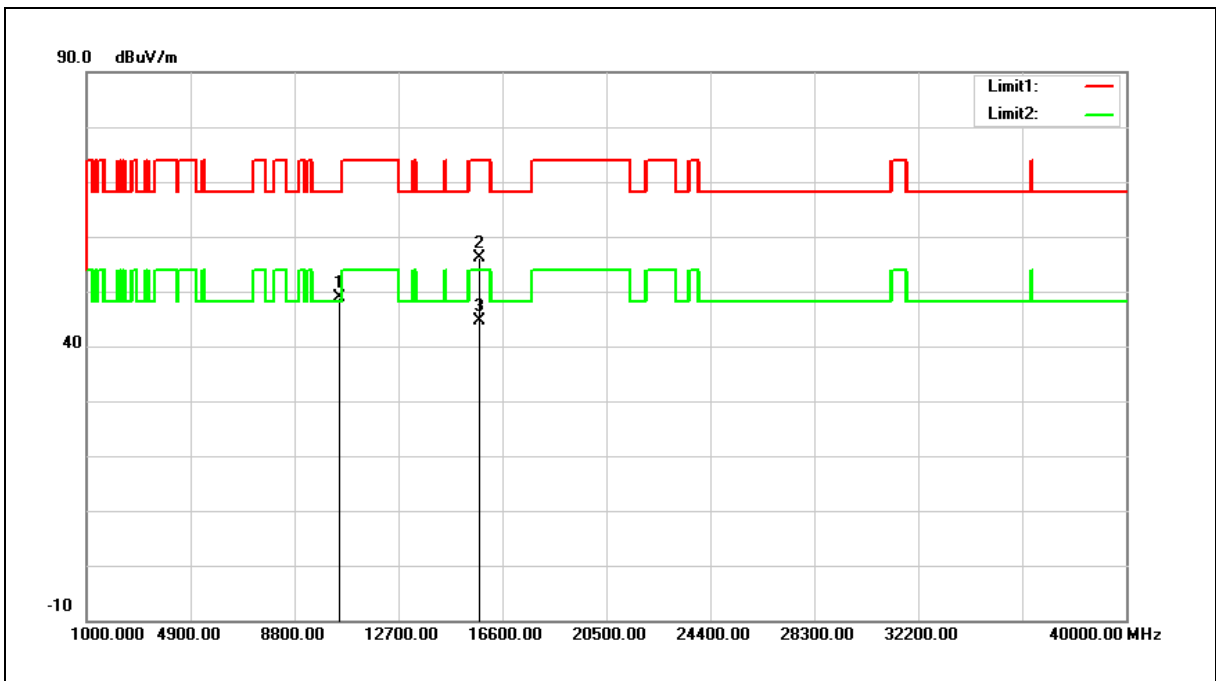

No.	Frequency (MHz)	Reading (dBuV)	Correct Factor (dB/m)	Result (dBuV/m)	Limit (dBuV/m)	Margin (dB)	Remark
1	10480.000	32.38	16.47	48.85	68.20	-19.35	peak
2	15720.000	38.20	17.88	56.08	74.00	-17.92	peak
3	15720.000	26.74	17.88	44.62	54.00	-9.38	AVG

Note:1.Result (dBuV/m) = Correct Factor (dB/m) + Reading(dBuV).
 2.Correction factor (dB/m) = Antenna Factor (dB/m) + Cable loss (dB) – Pre-Amplifier gain (dB).
 3.When the peak results are less than average limit, so not need to evaluate the average.



Standard:	FCC Part 15.407	Test Distance:	3m
Test item:	Harmonic	Power:	AC 120V/60Hz
Frequency:	5745MHz	Temp.(°C)/Hum.(%RH):	26(°C)/60%RH
Mode:	Mode 2		
Ant.Polar.:	Horizontal		

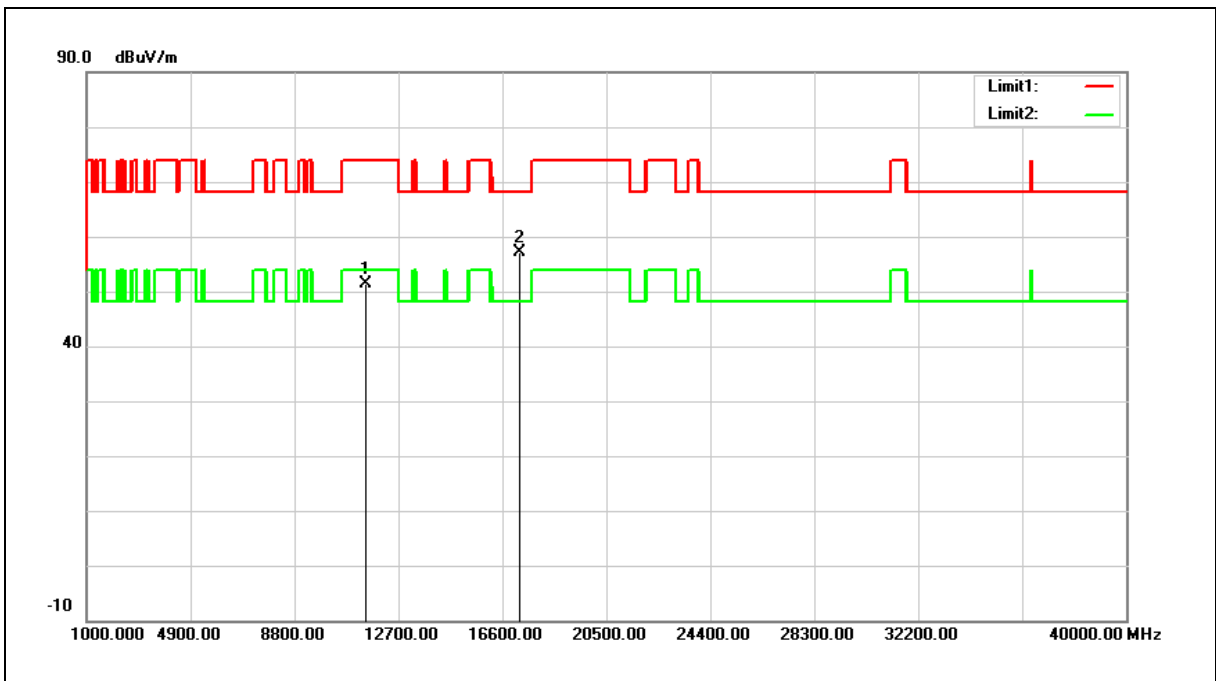

No.	Frequency (MHz)	Reading (dBuV)	Correct Factor (dB/m)	Result (dBuV/m)	Limit (dBuV/m)	Margin (dB)	Remark
1	11490.000	33.35	18.11	51.46	74.00	-22.54	peak
2	17235.000	34.16	22.86	57.02	68.20	-11.18	peak

Note: 1.Result (dBuV/m) = Correct Factor (dB/m) + Reading(dBuV).

2.Correction factor (dB/m) = Antenna Factor (dB/m) + Cable loss (dB) – Pre-Amplifier gain (dB).

3.When the peak results are less than average limit, so not need to evaluate the average.



Standard:	FCC Part 15.407	Test Distance:	3m
Test item:	Harmonic	Power:	AC 120V/60Hz
Frequency:	5745MHz	Temp.(°C)/Hum.(%RH):	26(°C)/60%RH
Mode:	Mode 2		
Ant.Polar.:	Vertical		

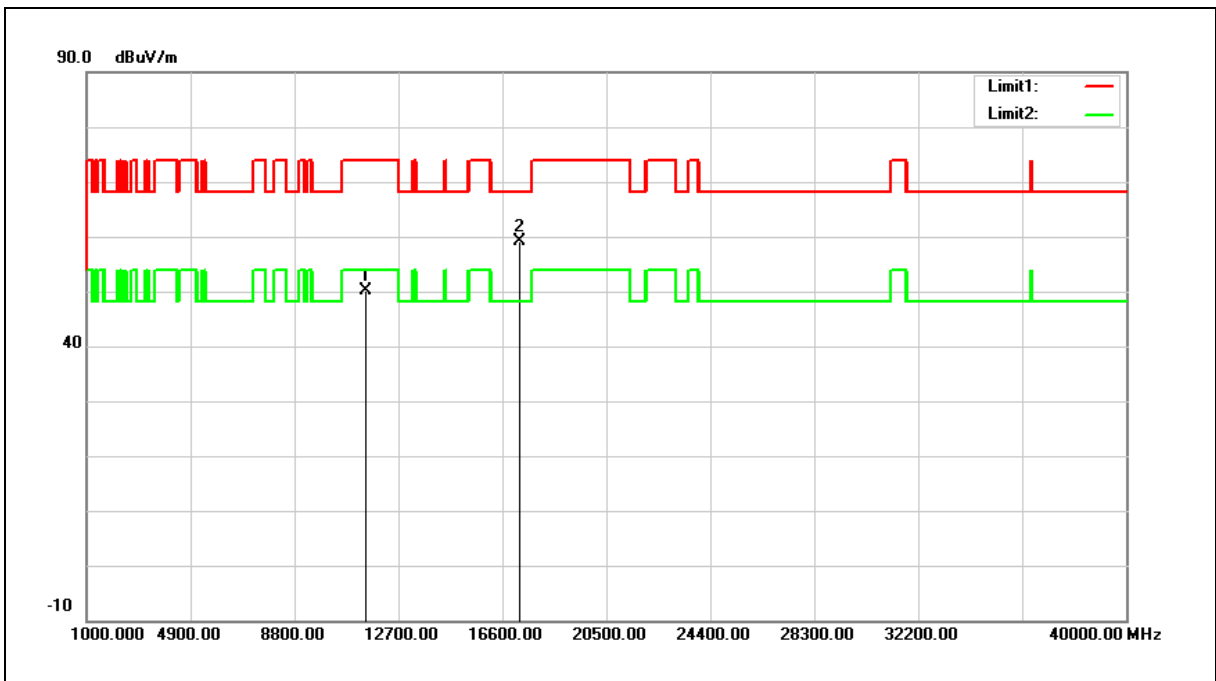

No.	Frequency (MHz)	Reading (dBuV)	Correct Factor (dB/m)	Result (dBuV/m)	Limit (dBuV/m)	Margin (dB)	Remark
1	11490.000	32.07	18.11	50.18	74.00	-23.82	peak
2	17235.000	36.31	22.86	59.17	68.20	-9.03	peak

Note: 1.Result (dBuV/m) = Correct Factor (dB/m) + Reading(dBuV).

2.Correction factor (dB/m) = Antenna Factor (dB/m) + Cable loss (dB) – Pre-Amplifier gain (dB).

3.When the peak results are less than average limit, so not need to evaluate the average.



Standard:	FCC Part 15.407	Test Distance:	3m
Test item:	Harmonic	Power:	AC 120V/60Hz
Frequency:	5785MHz	Temp.(°C)/Hum.(%RH):	26(°C)/60%RH
Mode:	Mode 2		
Ant.Polar.:	Horizontal		

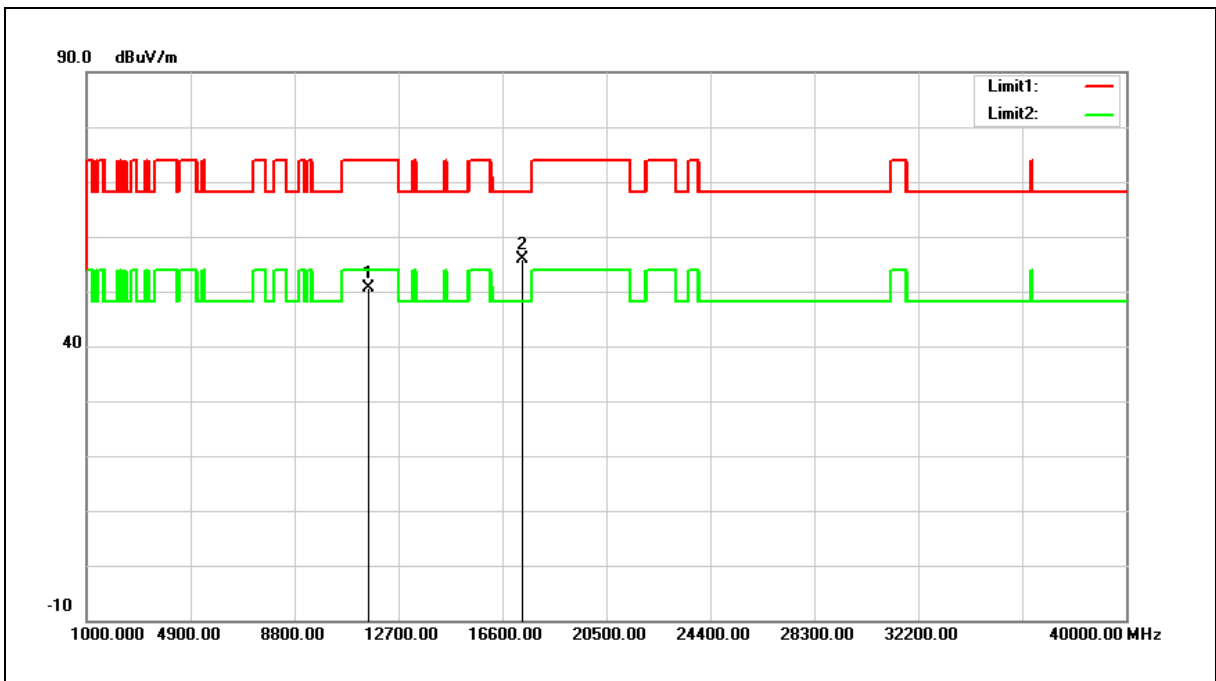

No.	Frequency (MHz)	Reading (dBuV)	Correct Factor (dB/m)	Result (dBuV/m)	Limit (dBuV/m)	Margin (dB)	Remark
1	11570.000	32.70	18.03	50.73	74.00	-23.27	peak
2	17355.000	32.38	23.45	55.83	68.20	-12.37	peak

Note: 1.Result (dBuV/m) = Correct Factor (dB/m) + Reading(dBuV).

2.Correction factor (dB/m) = Antenna Factor (dB/m) + Cable loss (dB) – Pre-Amplifier gain (dB).

3.When the peak results are less than average limit, so not need to evaluate the average.



Standard:	FCC Part 15.407	Test Distance:	3m
Test item:	Harmonic	Power:	AC 120V/60Hz
Frequency:	5785MHz	Temp.(°C)/Hum.(%RH):	26(°C)/60%RH
Mode:	Mode 2		
Ant.Polar.:	Vertical		

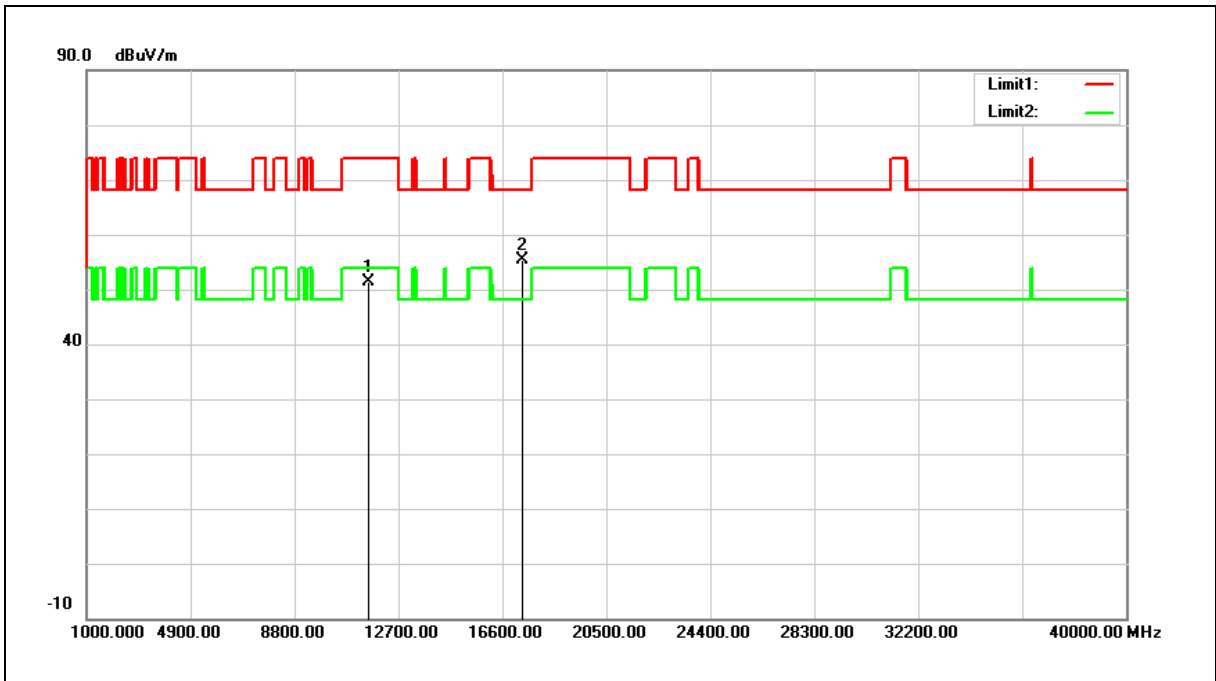

No.	Frequency (MHz)	Reading (dBuV)	Correct Factor (dB/m)	Result (dBuV/m)	Limit (dBuV/m)	Margin (dB)	Remark
1	11570.000	33.43	18.03	51.46	74.00	-22.54	peak
2	17355.000	32.01	23.45	55.46	68.20	-12.74	peak

Note: 1.Result (dBuV/m) = Correct Factor (dB/m) + Reading(dBuV).

2.Correction factor (dB/m) = Antenna Factor (dB/m) + Cable loss (dB) – Pre-Amplifier gain (dB).

3.When the peak results are less than average limit, so not need to evaluate the average.



Standard:	FCC Part 15.407	Test Distance:	3m
Test item:	Harmonic	Power:	AC 120V/60Hz
Frequency:	5825MHz	Temp.(°C)/Hum.(%RH):	26(°C)/60%RH
Mode:	Mode 2		
Ant.Polar.:	Horizontal		

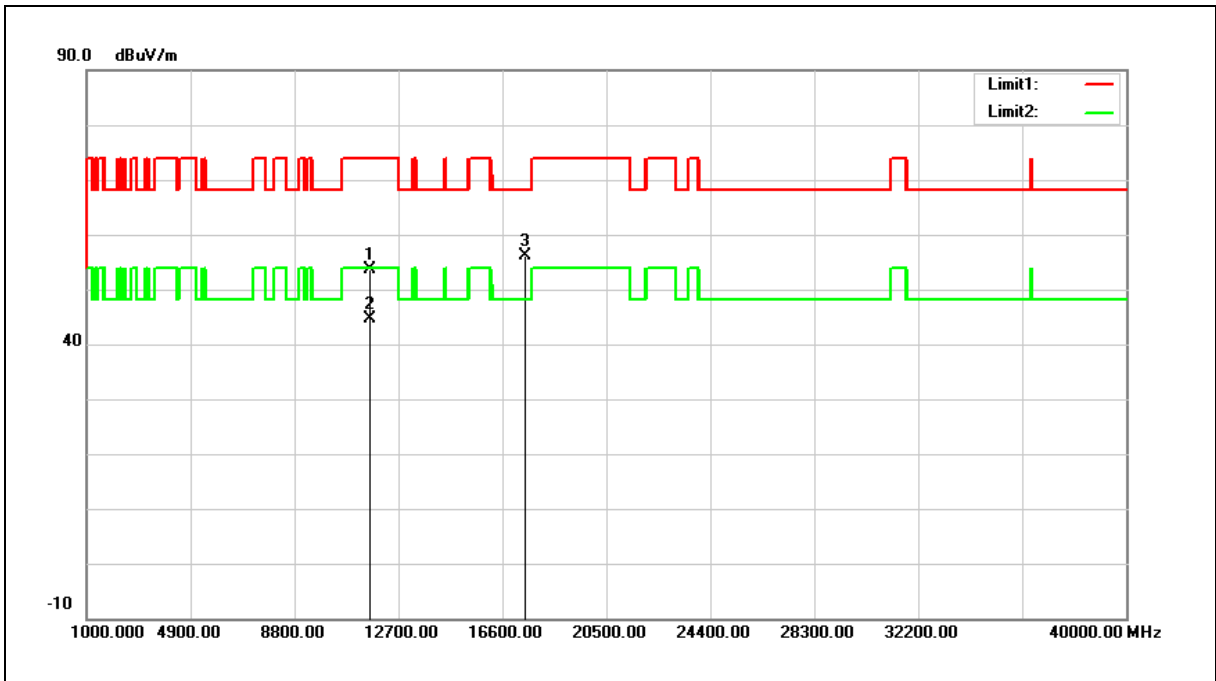

No.	Frequency (MHz)	Reading (dBuV)	Correct Factor (dB/m)	Result (dBuV/m)	Limit (dBuV/m)	Margin (dB)	Remark
1	11650.000	35.73	17.93	53.66	74.00	-20.34	peak
2	11650.000	26.62	17.93	44.55	54.00	-9.45	AVG
3	17475.000	32.09	24.04	56.13	68.20	-12.07	peak

Note:1.Result (dBuV/m) = Correct Factor (dB/m) + Reading(dBuV).

2.Correction factor (dB/m) = Antenna Factor (dB/m) + Cable loss (dB) – Pre-Amplifier gain (dB).

3.When the peak results are less than average limit, so not need to evaluate the average.



Standard:	FCC Part 15.407	Test Distance:	3m
Test item:	Harmonic	Power:	AC 120V/60Hz
Frequency:	5825MHz	Temp.(°C)/Hum.(%RH):	26(°C)/60%RH
Mode:	Mode 2		
Ant.Polar.:	Vertical		

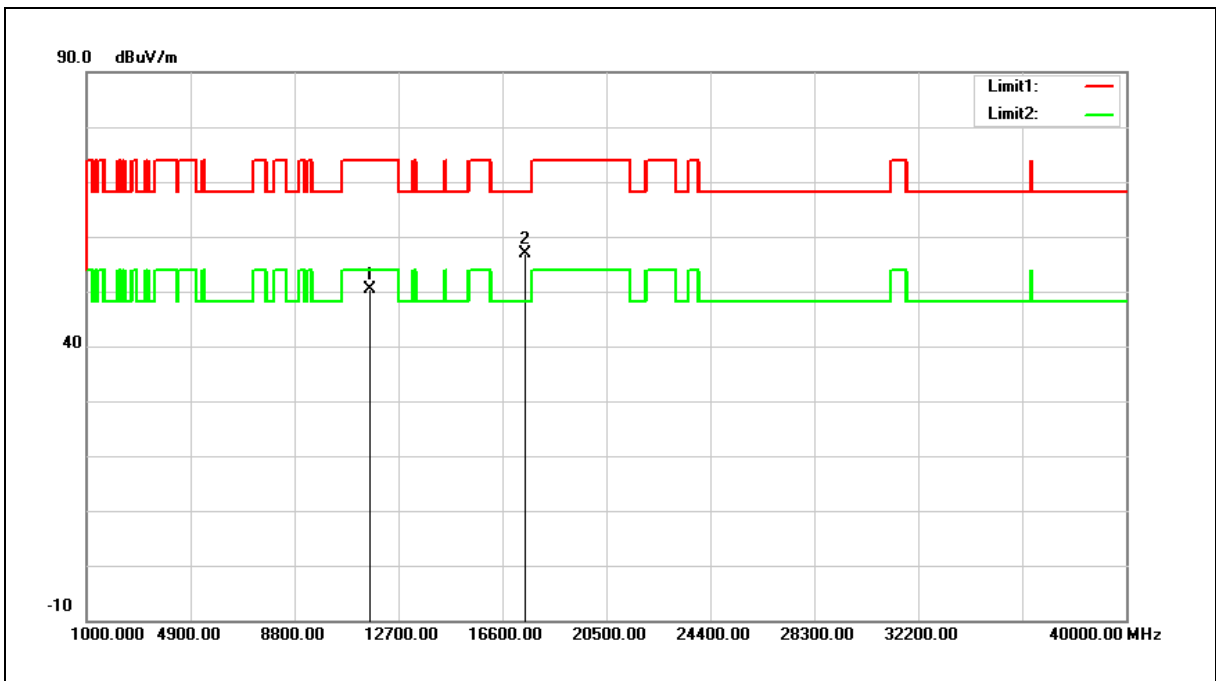

No.	Frequency (MHz)	Reading (dBuV)	Correct Factor (dB/m)	Result (dBuV/m)	Limit (dBuV/m)	Margin (dB)	Remark
1	11650.000	32.56	17.93	50.49	74.00	-23.51	peak
2	17475.000	32.81	24.04	56.85	68.20	-11.35	peak

- Note: 1.Result (dBuV/m) = Correct Factor (dB/m) + Reading(dBuV).
 2.Correction factor (dB/m) = Antenna Factor (dB/m) + Cable loss (dB) – Pre-Amplifier gain (dB).
 3.When the peak results are less than average limit, so not need to evaluate the average.



Standard:	FCC Part 15.407	Test Distance:	3m
Test item:	Harmonic	Power:	AC 120V/60Hz
Frequency:	5180MHz	Temp.(°C)/Hum.(%RH):	26(°C)/60%RH
Mode:	Mode 3		
Ant.Polar.:	Horizontal		

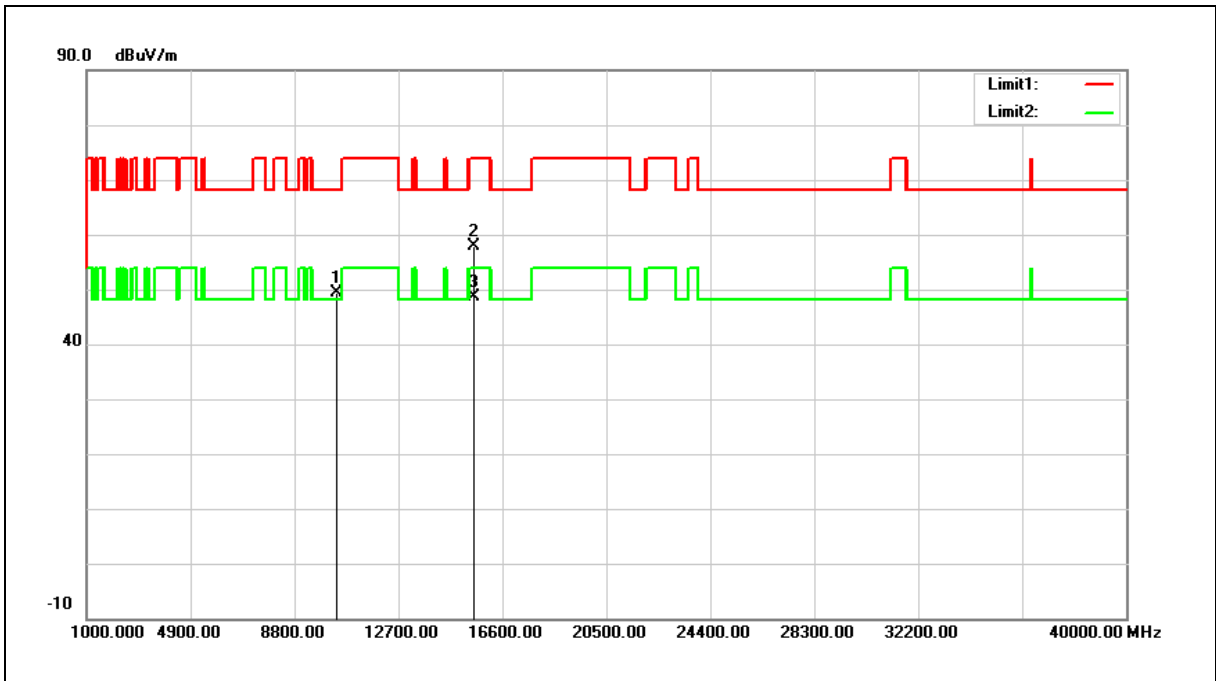

No.	Frequency (MHz)	Reading (dBuV)	Correct Factor (dB/m)	Result (dBuV/m)	Limit (dBuV/m)	Margin (dB)	Remark
1	10360.000	33.35	16.09	49.44	68.20	-18.76	peak
2	15540.000	39.59	18.35	57.94	74.00	-16.06	peak
3	15540.000	30.30	18.35	48.65	54.00	-5.35	AVG

Note:1.Result (dBuV/m) = Correct Factor (dB/m) + Reading(dBuV).

2.Correction factor (dB/m) = Antenna Factor (dB/m) + Cable loss (dB) – Pre-Amplifier gain (dB).

3.When the peak results are less than average limit, so not need to evaluate the average.



Standard:	FCC Part 15.407	Test Distance:	3m
Test item:	Harmonic	Power:	AC 120V/60Hz
Frequency:	5180MHz	Temp.(°C)/Hum.(%RH):	26(°C)/60%RH
Mode:	Mode 3		
Ant.Polar.:	Vertical		

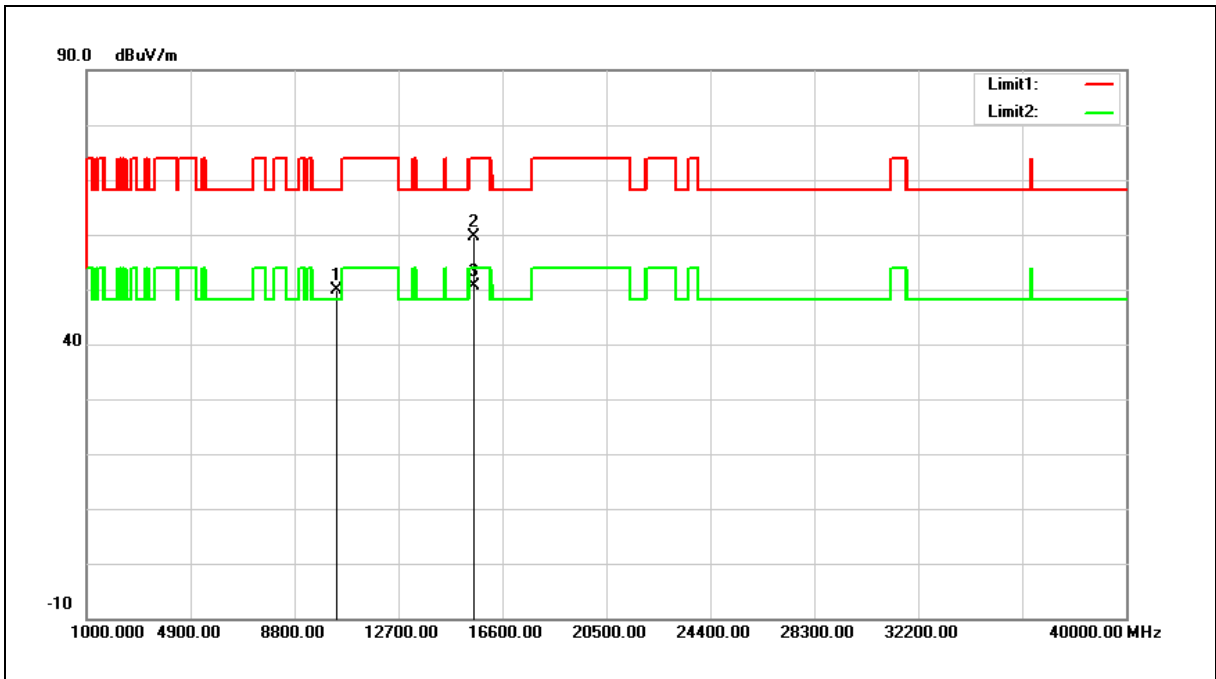

No.	Frequency (MHz)	Reading (dBuV)	Correct Factor (dB/m)	Result (dBuV/m)	Limit (dBuV/m)	Margin (dB)	Remark
1	10360.000	33.75	16.09	49.84	68.20	-18.36	peak
2	15540.000	41.28	18.35	59.63	74.00	-14.37	peak
3	15540.000	32.25	18.35	50.60	54.00	-3.40	AVG

Note:1.Result (dBuV/m) = Correct Factor (dB/m) + Reading(dBuV).

2.Correction factor (dB/m) = Antenna Factor (dB/m) + Cable loss (dB) – Pre-Amplifier gain (dB).

3.When the peak results are less than average limit, so not need to evaluate the average.



Standard:	FCC Part 15.407	Test Distance:	3m
Test item:	Harmonic	Power:	AC 120V/60Hz
Frequency:	5200MHz	Temp.(°C)/Hum.(%RH):	26(°C)/60%RH
Mode:	Mode 3		
Ant.Polar.:	Horizontal		

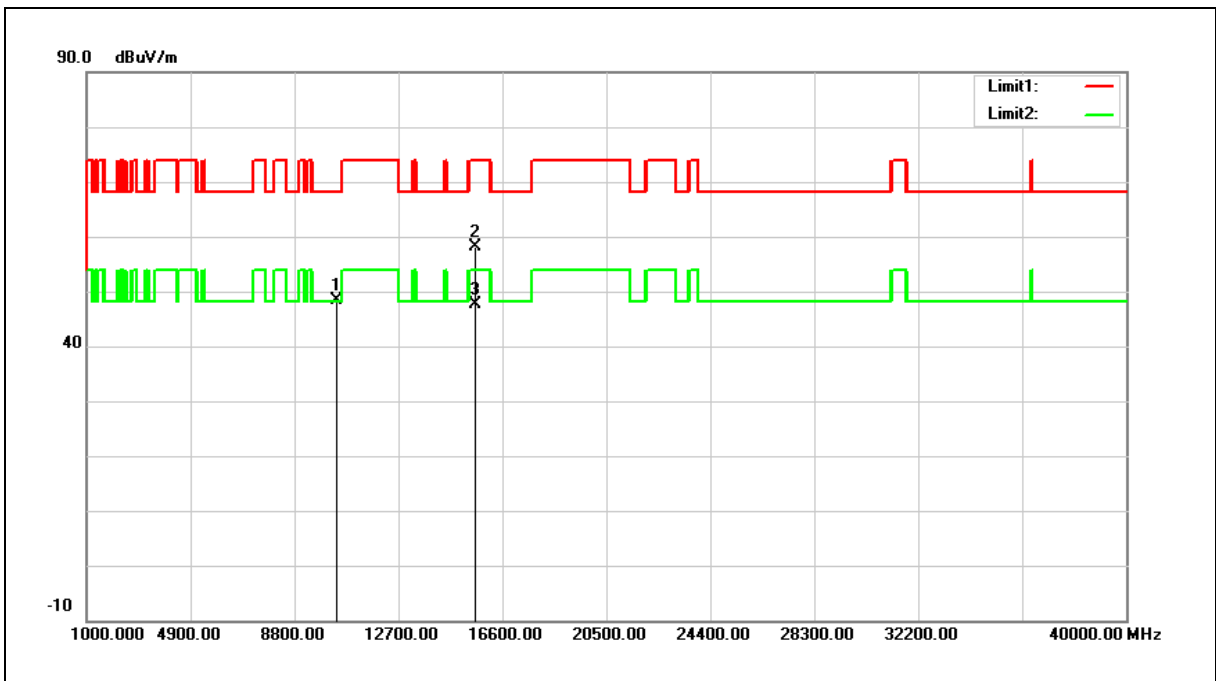

No.	Frequency (MHz)	Reading (dBuV)	Correct Factor (dB/m)	Result (dBuV/m)	Limit (dBuV/m)	Margin (dB)	Remark
1	10400.000	32.06	16.22	48.28	68.20	-19.92	peak
2	15600.000	39.84	18.19	58.03	74.00	-15.97	peak
3	15600.000	29.34	18.19	47.53	54.00	-6.47	AVG

Note:1.Result (dBuV/m) = Correct Factor (dB/m) + Reading(dBuV).
 2.Correction factor (dB/m) = Antenna Factor (dB/m) + Cable loss (dB) – Pre-Amplifier gain (dB).
 3.When the peak results are less than average limit, so not need to evaluate the average.



Standard:	FCC Part 15.407	Test Distance:	3m
Test item:	Harmonic	Power:	AC 120V/60Hz
Frequency:	5200MHz	Temp.(°C)/Hum.(%RH):	26(°C)/60%RH
Mode:	Mode 3		
Ant.Polar.:	Vertical		

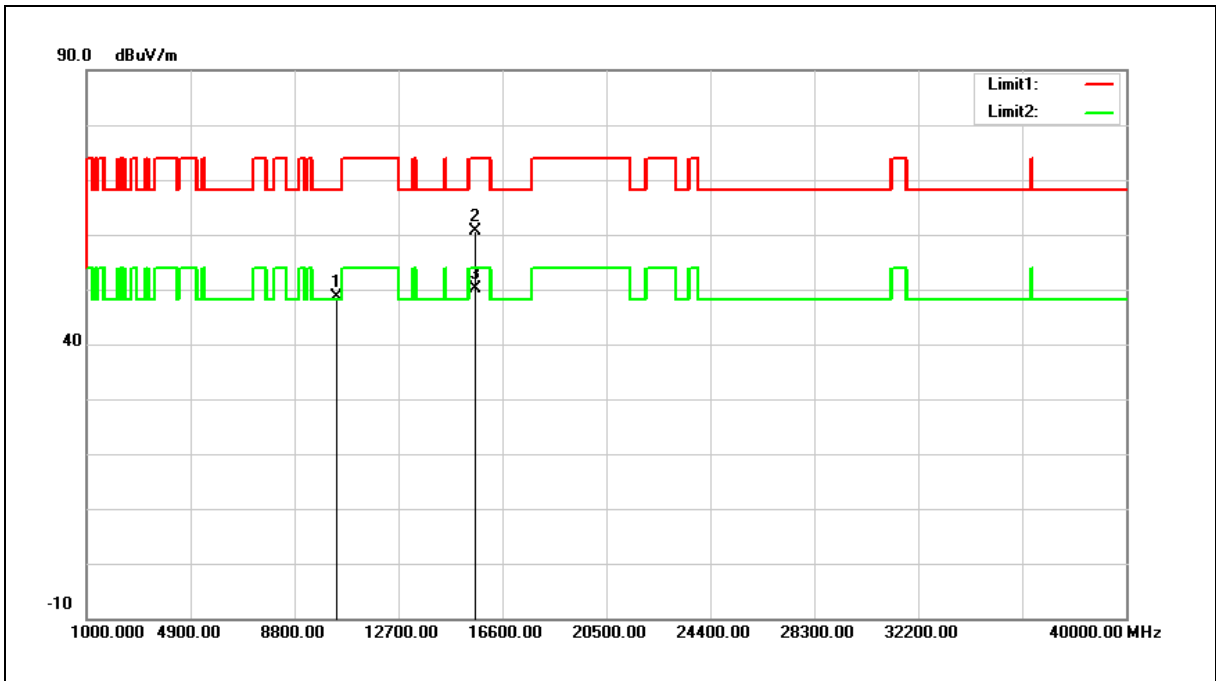

No.	Frequency (MHz)	Reading (dBuV)	Correct Factor (dB/m)	Result (dBuV/m)	Limit (dBuV/m)	Margin (dB)	Remark
1	10400.000	32.48	16.22	48.70	68.20	-19.50	peak
2	15600.000	42.48	18.19	60.67	74.00	-13.33	peak
3	15600.000	32.06	18.19	50.25	54.00	-3.75	AVG

Note:1.Result (dBuV/m) = Correct Factor (dB/m) + Reading(dBuV).

2.Correction factor (dB/m) = Antenna Factor (dB/m) + Cable loss (dB) – Pre-Amplifier gain (dB).

3.When the peak results are less than average limit, so not need to evaluate the average.



Standard:	FCC Part 15.407	Test Distance:	3m
Test item:	Harmonic	Power:	AC 120V/60Hz
Frequency:	5240MHz	Temp.(°C)/Hum.(%RH):	26(°C)/60%RH
Mode:	Mode 3		
Ant.Polar.:	Horizontal		

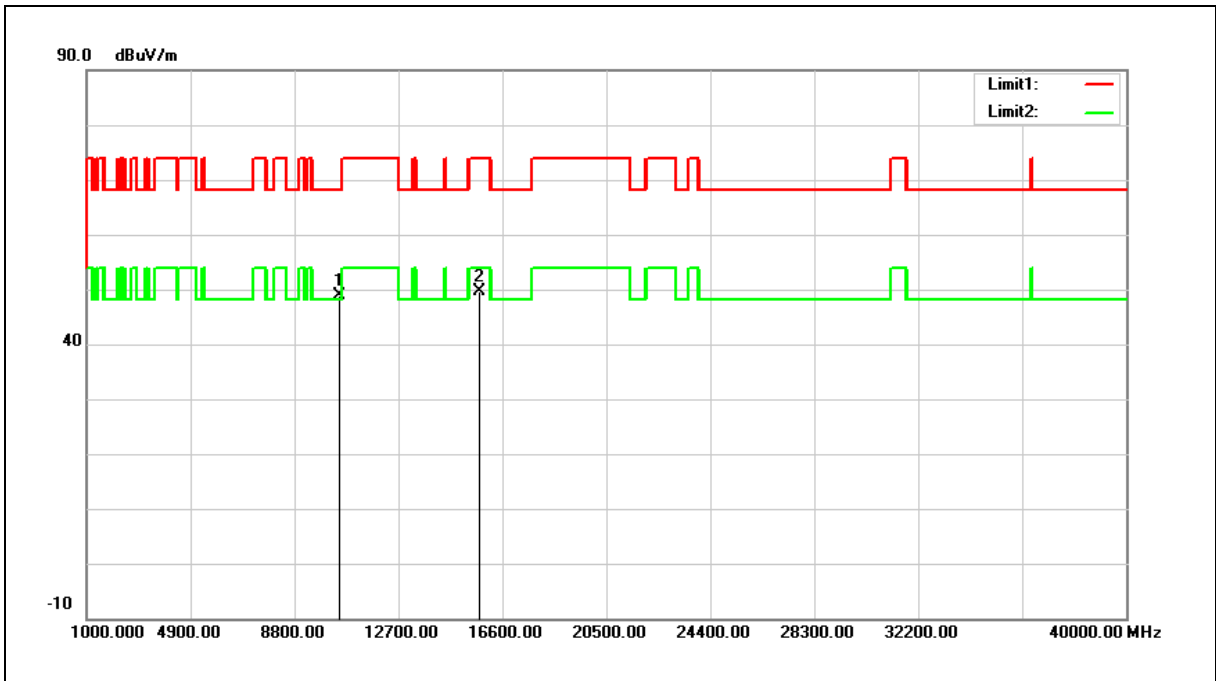

No.	Frequency (MHz)	Reading (dBuV)	Correct Factor (dB/m)	Result (dBuV/m)	Limit (dBuV/m)	Margin (dB)	Remark
1	10480.000	32.45	16.47	48.92	68.20	-19.28	peak
2	15720.000	31.87	17.88	49.75	74.00	-24.25	peak

Note: 1.Result (dBuV/m) = Correct Factor (dB/m) + Reading(dBuV).

2.Correction factor (dB/m) = Antenna Factor (dB/m) + Cable loss (dB) – Pre-Amplifier gain (dB).

3.When the peak results are less than average limit, so not need to evaluate the average.



Standard:	FCC Part 15.407	Test Distance:	3m
Test item:	Harmonic	Power:	AC 120V/60Hz
Frequency:	5240MHz	Temp.(°C)/Hum.(%RH):	26(°C)/60%RH
Mode:	Mode 3		
Ant.Polar.:	Vertical		

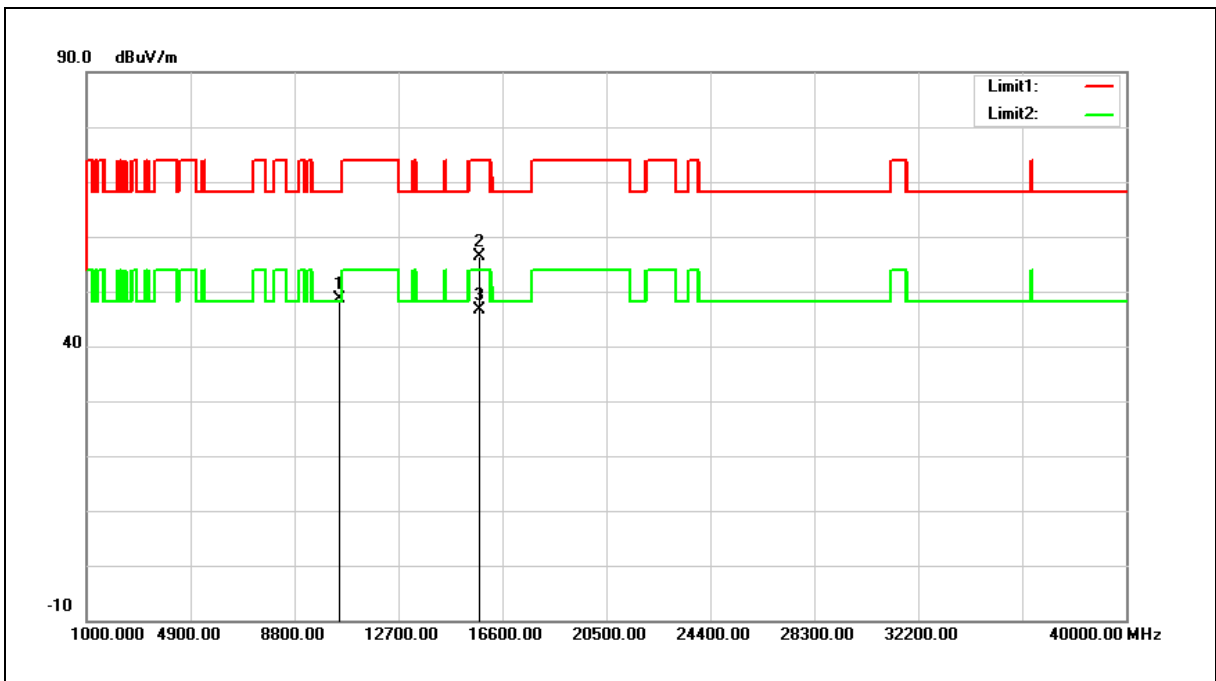

No.	Frequency (MHz)	Reading (dBuV)	Correct Factor (dB/m)	Result (dBuV/m)	Limit (dBuV/m)	Margin (dB)	Remark
1	10480.000	32.23	16.47	48.70	68.20	-19.50	peak
2	15720.000	38.39	17.88	56.27	74.00	-17.73	peak
3	15720.000	28.66	17.88	46.54	54.00	-7.46	AVG

Note:1.Result (dBuV/m) = Correct Factor (dB/m) + Reading(dBuV).

2.Correction factor (dB/m) = Antenna Factor (dB/m) + Cable loss (dB) – Pre-Amplifier gain (dB).

3.When the peak results are less than average limit, so not need to evaluate the average.



Standard:	FCC Part 15.407	Test Distance:	3m
Test item:	Harmonic	Power:	AC 120V/60Hz
Frequency:	5745MHz	Temp.(°C)/Hum.(%RH):	26(°C)/60%RH
Mode:	Mode 3		
Ant.Polar.:	Horizontal		

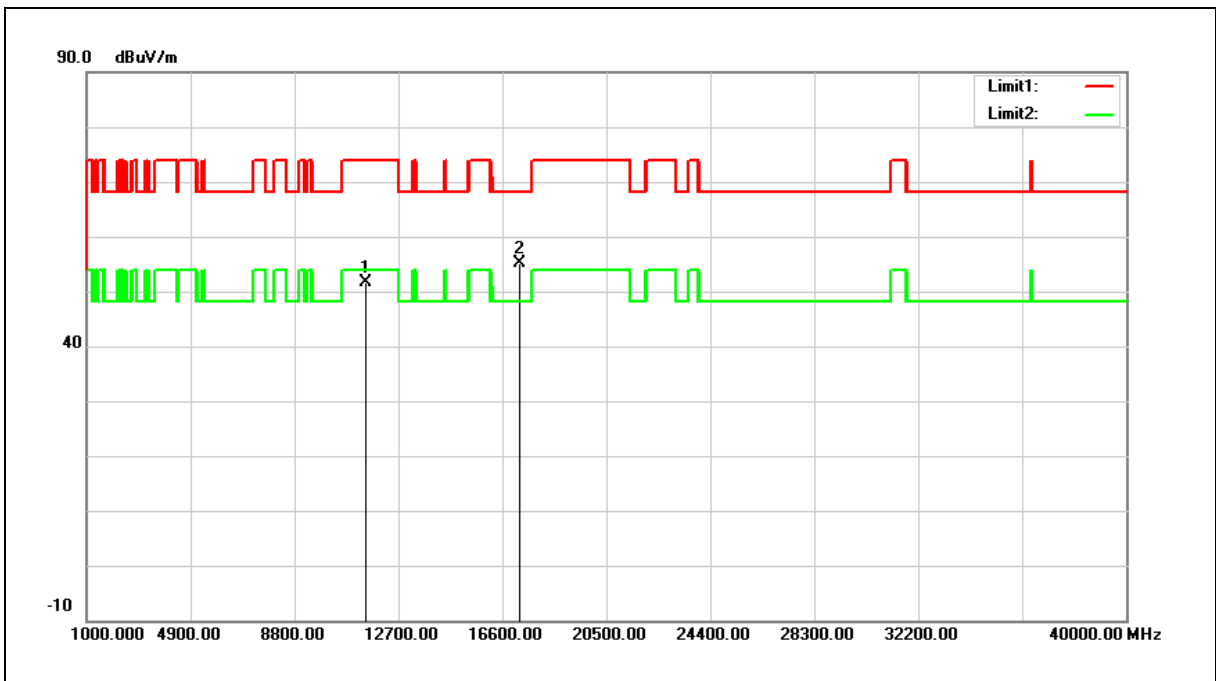

No.	Frequency (MHz)	Reading (dBuV)	Correct Factor (dB/m)	Result (dBuV/m)	Limit (dBuV/m)	Margin (dB)	Remark
1	11490.000	33.59	18.11	51.70	74.00	-22.30	peak
2	17235.000	32.25	22.86	55.11	68.20	-13.09	peak

Note: 1.Result (dBuV/m) = Correct Factor (dB/m) + Reading(dBuV).

2.Correction factor (dB/m) = Antenna Factor (dB/m) + Cable loss (dB) – Pre-Amplifier gain (dB).

3.When the peak results are less than average limit, so not need to evaluate the average.



Standard:	FCC Part 15.407	Test Distance:	3m
Test item:	Harmonic	Power:	AC 120V/60Hz
Frequency:	5745MHz	Temp.(°C)/Hum.(%RH):	26(°C)/60%RH
Mode:	Mode 3		
Ant.Polar.:	Vertical		

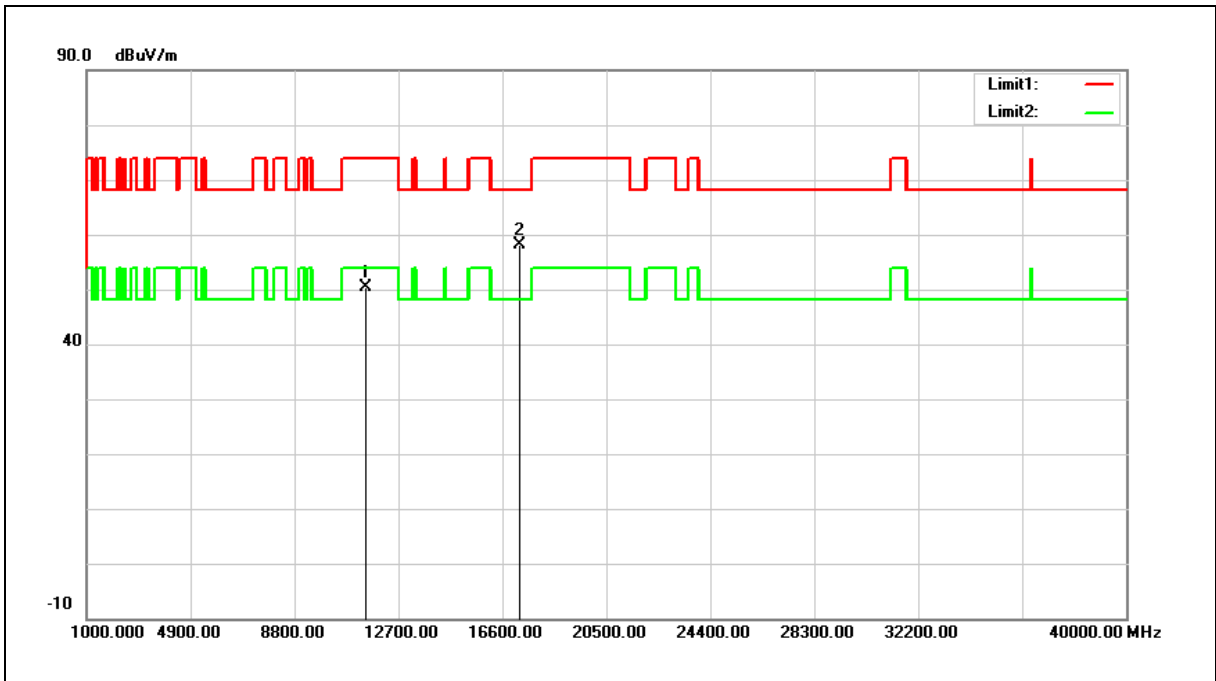

No.	Frequency (MHz)	Reading (dBuV)	Correct Factor (dB/m)	Result (dBuV/m)	Limit (dBuV/m)	Margin (dB)	Remark
1	11490.000	32.31	18.11	50.42	74.00	-23.58	peak
2	17235.000	35.15	22.86	58.01	68.20	-10.19	peak

Note: 1.Result (dBuV/m) = Correct Factor (dB/m) + Reading(dBuV).

2.Correction factor (dB/m) = Antenna Factor (dB/m) + Cable loss (dB) – Pre-Amplifier gain (dB).

3.When the peak results are less than average limit, so not need to evaluate the average.



Standard:	FCC Part 15.407	Test Distance:	3m
Test item:	Harmonic	Power:	AC 120V/60Hz
Frequency:	5785MHz	Temp.(°C)/Hum.(%RH):	26(°C)/60%RH
Mode:	Mode 3		
Ant.Polar.:	Horizontal		

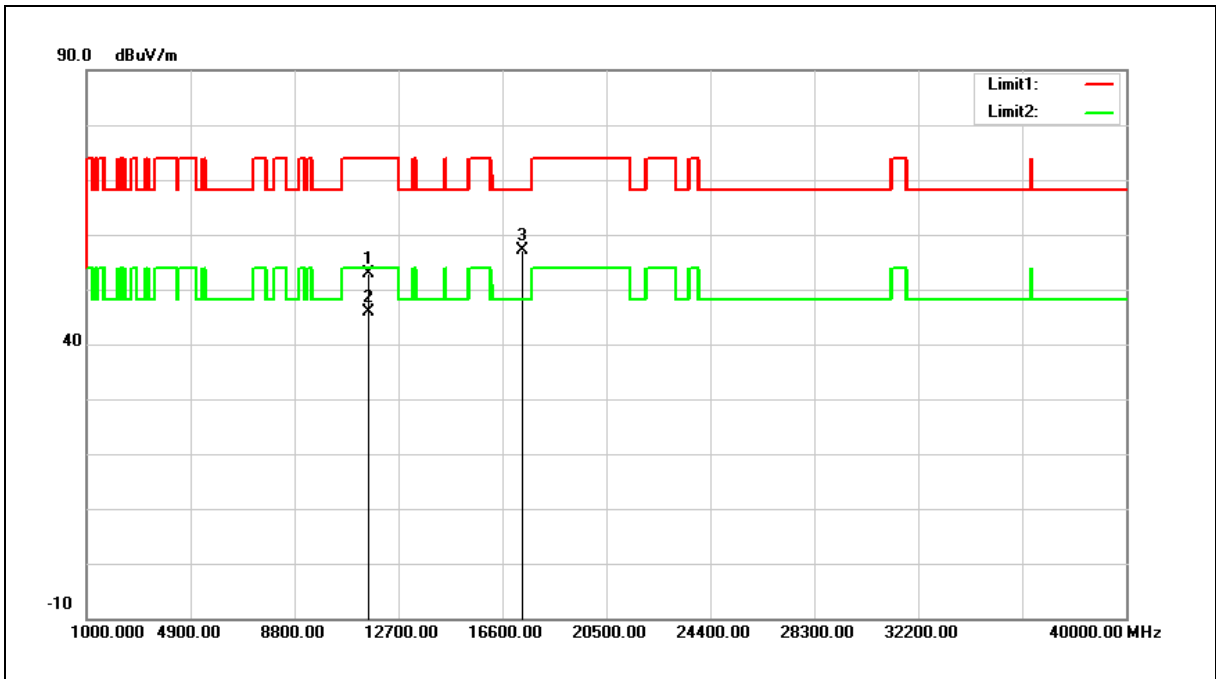

No.	Frequency (MHz)	Reading (dBuV)	Correct Factor (dB/m)	Result (dBuV/m)	Limit (dBuV/m)	Margin (dB)	Remark
1	11570.000	34.88	18.03	52.91	74.00	-21.09	peak
2	11570.000	27.85	18.03	45.88	54.00	-8.12	AVG
3	17355.000	33.70	23.45	57.15	68.20	-11.05	peak

Note:1.Result (dBuV/m) = Correct Factor (dB/m) + Reading(dBuV).

2.Correction factor (dB/m) = Antenna Factor (dB/m) + Cable loss (dB) – Pre-Amplifier gain (dB).

3.When the peak results are less than average limit, so not need to evaluate the average.



Standard:	FCC Part 15.407	Test Distance:	3m
Test item:	Harmonic	Power:	AC 120V/60Hz
Frequency:	5785MHz	Temp.(°C)/Hum.(%RH):	26(°C)/60%RH
Mode:	Mode 3		
Ant.Polar.:	Vertical		

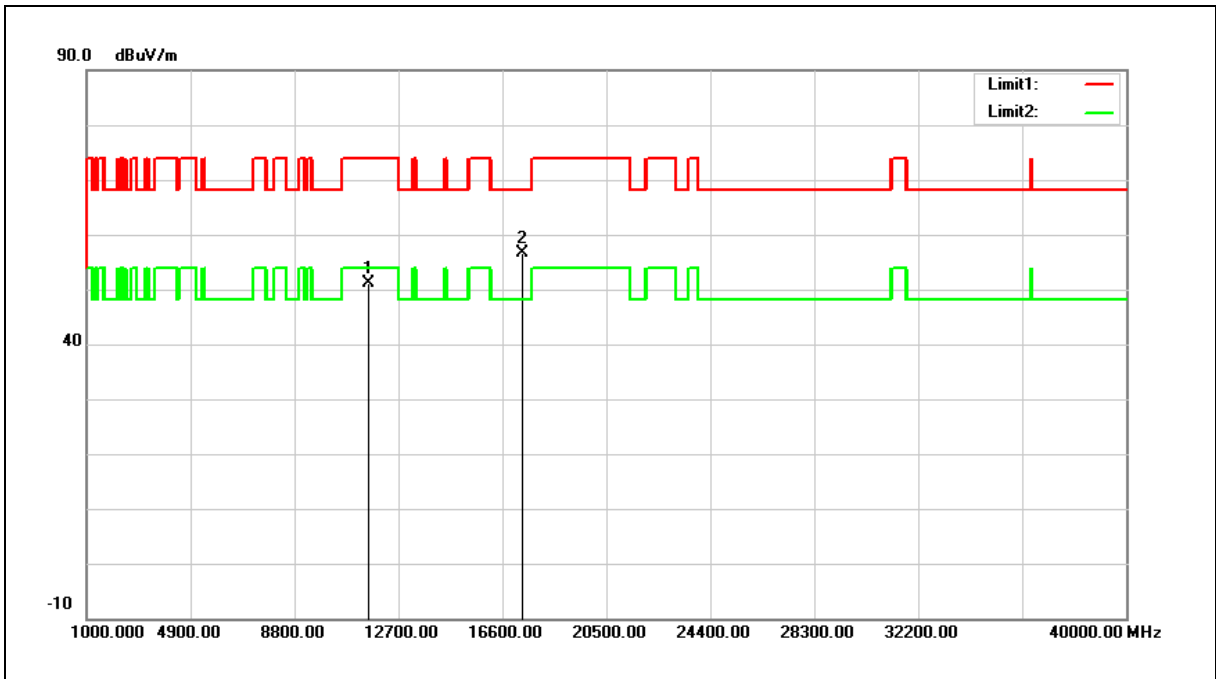

No.	Frequency (MHz)	Reading (dBuV)	Correct Factor (dB/m)	Result (dBuV/m)	Limit (dBuV/m)	Margin (dB)	Remark
1	11570.000	33.13	18.03	51.16	74.00	-22.84	peak
2	17355.000	33.23	23.45	56.68	68.20	-11.52	peak

- Note: 1.Result (dBuV/m) = Correct Factor (dB/m) + Reading(dBuV).
 2.Correction factor (dB/m) = Antenna Factor (dB/m) + Cable loss (dB) – Pre-Amplifier gain (dB).
 3.When the peak results are less than average limit, so not need to evaluate the average.



Standard:	FCC Part 15.407	Test Distance:	3m
Test item:	Harmonic	Power:	AC 120V/60Hz
Frequency:	5825MHz	Temp.(°C)/Hum.(%RH):	26(°C)/60%RH
Mode:	Mode 3		
Ant.Polar.:	Horizontal		

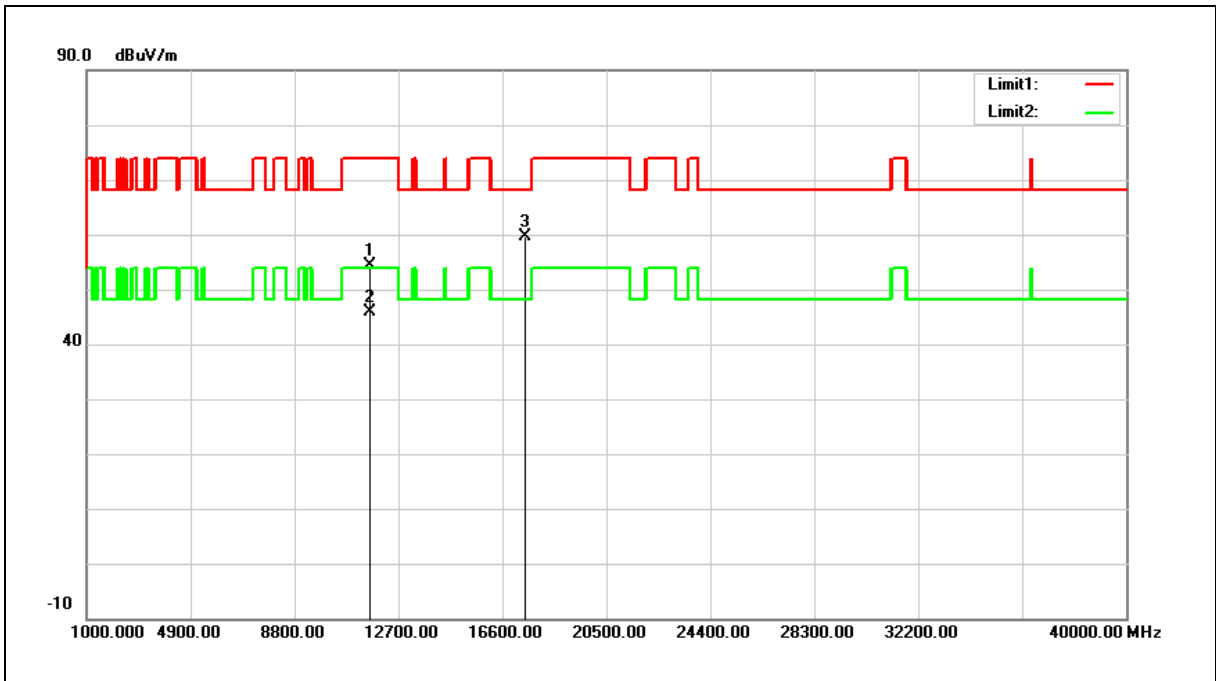

No.	Frequency (MHz)	Reading (dBuV)	Correct Factor (dB/m)	Result (dBuV/m)	Limit (dBuV/m)	Margin (dB)	Remark
1	11650.000	36.43	17.93	54.36	74.00	-19.64	peak
2	11650.000	27.84	17.93	45.77	54.00	-8.23	AVG
3	17475.000	35.59	24.04	59.63	68.20	-8.57	peak

Note:1.Result (dBuV/m) = Correct Factor (dB/m) + Reading(dBuV).

2.Correction factor (dB/m) = Antenna Factor (dB/m) + Cable loss (dB) – Pre-Amplifier gain (dB).

3.When the peak results are less than average limit, so not need to evaluate the average.



Standard:	FCC Part 15.407	Test Distance:	3m
Test item:	Harmonic	Power:	AC 120V/60Hz
Frequency:	5825MHz	Temp.(°C)/Hum.(%RH):	26(°C)/60%RH
Mode:	Mode 3		
Ant.Polar.:	Vertical		

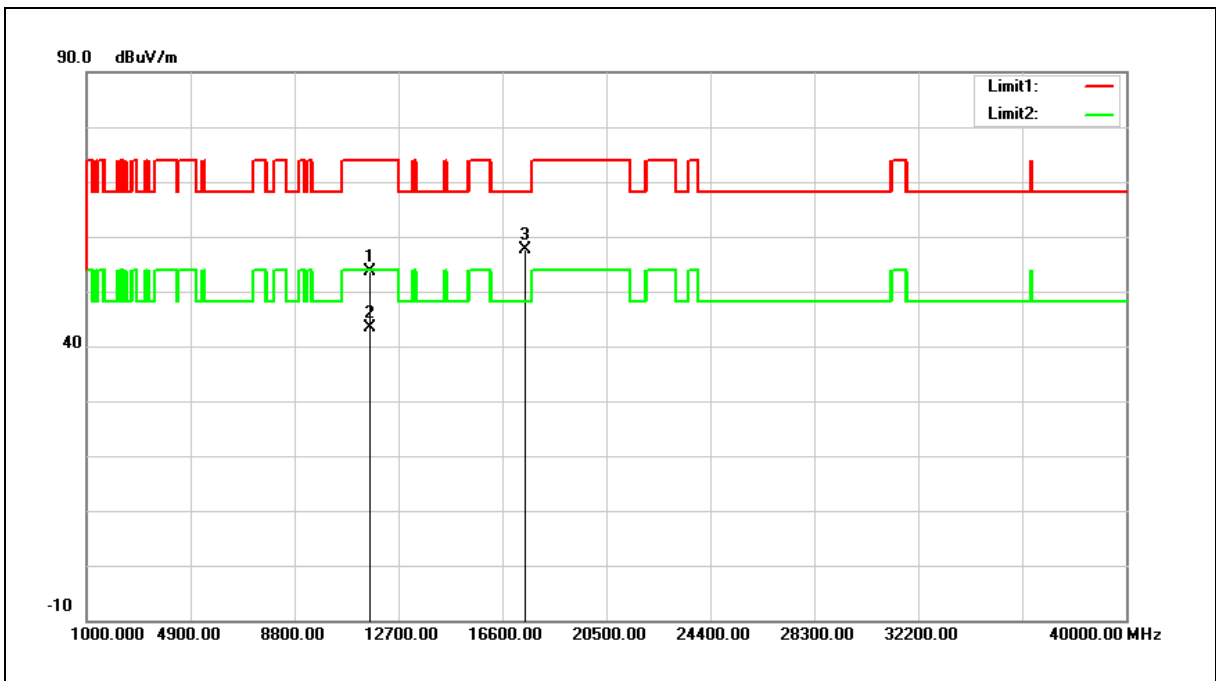

No.	Frequency (MHz)	Reading (dBuV)	Correct Factor (dB/m)	Result (dBuV/m)	Limit (dBuV/m)	Margin (dB)	Remark
1	11650.000	35.73	17.93	53.66	74.00	-20.34	peak
2	11650.000	25.56	17.93	43.49	54.00	-10.51	AVG
3	17475.000	33.51	24.04	57.55	68.20	-10.65	peak

Note:1.Result (dBuV/m) = Correct Factor (dB/m) + Reading(dBuV).

2.Correction factor (dB/m) = Antenna Factor (dB/m) + Cable loss (dB) – Pre-Amplifier gain (dB).

3.When the peak results are less than average limit, so not need to evaluate the average.

Standard:	FCC Part 15.407	Test Distance:	3m
Test item:	Harmonic	Power:	AC 120V/60Hz
Frequency:	5190MHz	Temp.(°C)/Hum.(%RH):	26(°C)/60%RH
Mode:	Mode 4		
Ant.Polar.:	Horizontal		

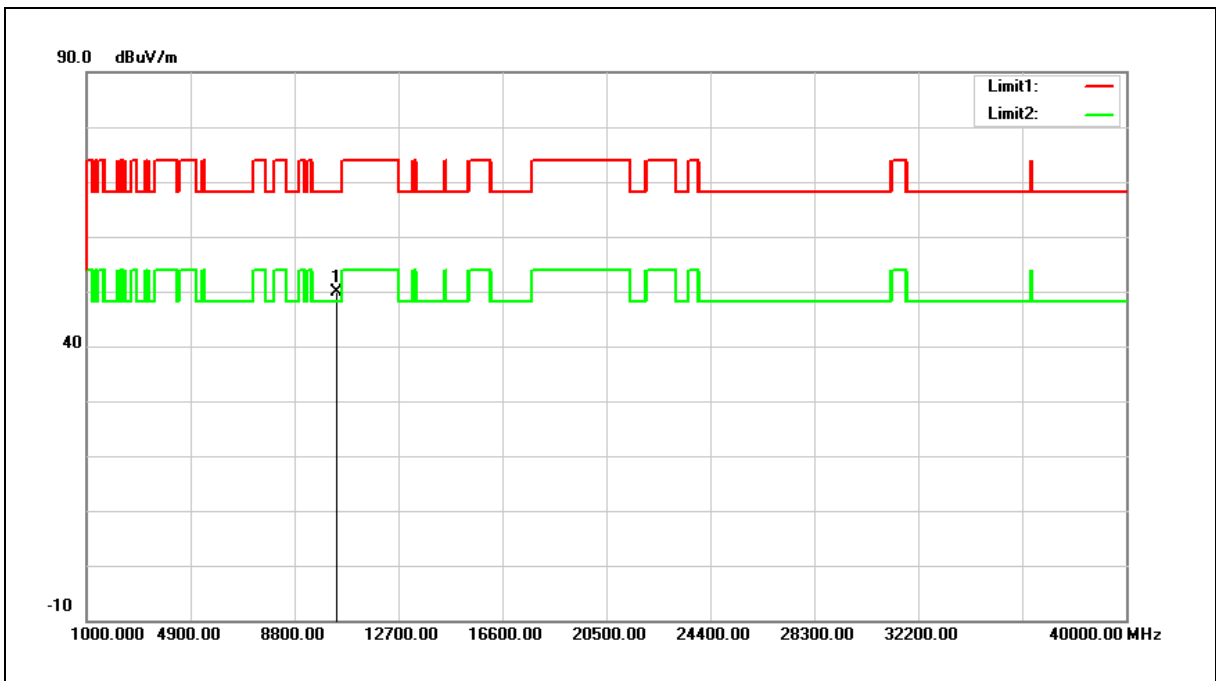

No.	Frequency (MHz)	Reading (dBuV)	Correct Factor (dB/m)	Result (dBuV/m)	Limit (dBuV/m)	Margin (dB)	Remark
1	10380.000	33.79	16.05	49.84	68.20	-18.36	peak

Note:1.Result (dBuV/m) = Correct Factor (dB/m) + Reading(dBuV).

2.Correction factor (dB/m) = Antenna Factor (dB/m) + Cable loss (dB) – Pre-Amplifier gain (dB).

3.When the peak results are less than average limit, so not need to evaluate the average.



Standard:	FCC Part 15.407	Test Distance:	3m
Test item:	Harmonic	Power:	AC 120V/60Hz
Frequency:	5190MHz	Temp.(°C)/Hum.(%RH):	26(°C)/60%RH
Mode:	Mode 4		
Ant.Polar.:	Vertical		

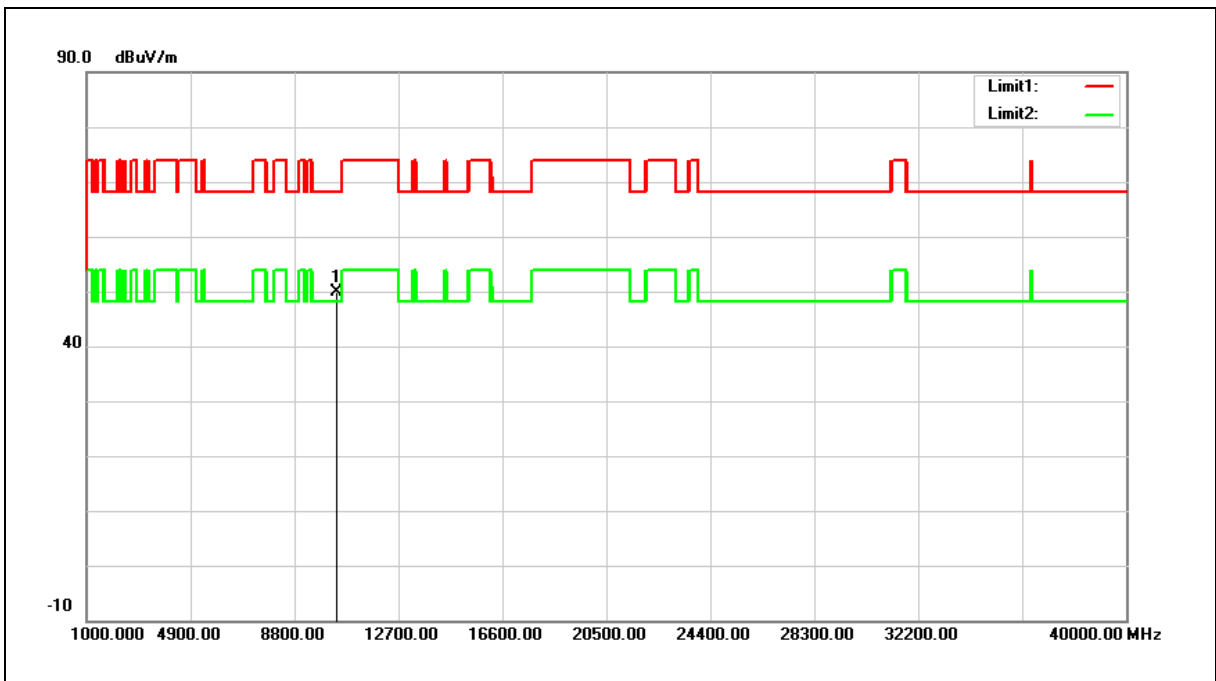

No.	Frequency (MHz)	Reading (dBuV)	Correct Factor (dB/m)	Result (dBuV/m)	Limit (dBuV/m)	Margin (dB)	Remark
1	10380.000	33.94	16.05	49.99	68.20	-18.21	peak

Note:1.Result (dBuV/m) = Correct Factor (dB/m) + Reading(dBuV).

2.Correction factor (dB/m) = Antenna Factor (dB/m) + Cable loss (dB) – Pre-Amplifier gain (dB).

3.When the peak results are less than average limit, so not need to evaluate the average.



Standard:	FCC Part 15.407	Test Distance:	3m
Test item:	Harmonic	Power:	AC 120V/60Hz
Frequency:	5230MHz	Temp.(°C)/Hum.(%RH):	26(°C)/60%RH
Mode:	Mode 4		
Ant.Polar.:	Horizontal		

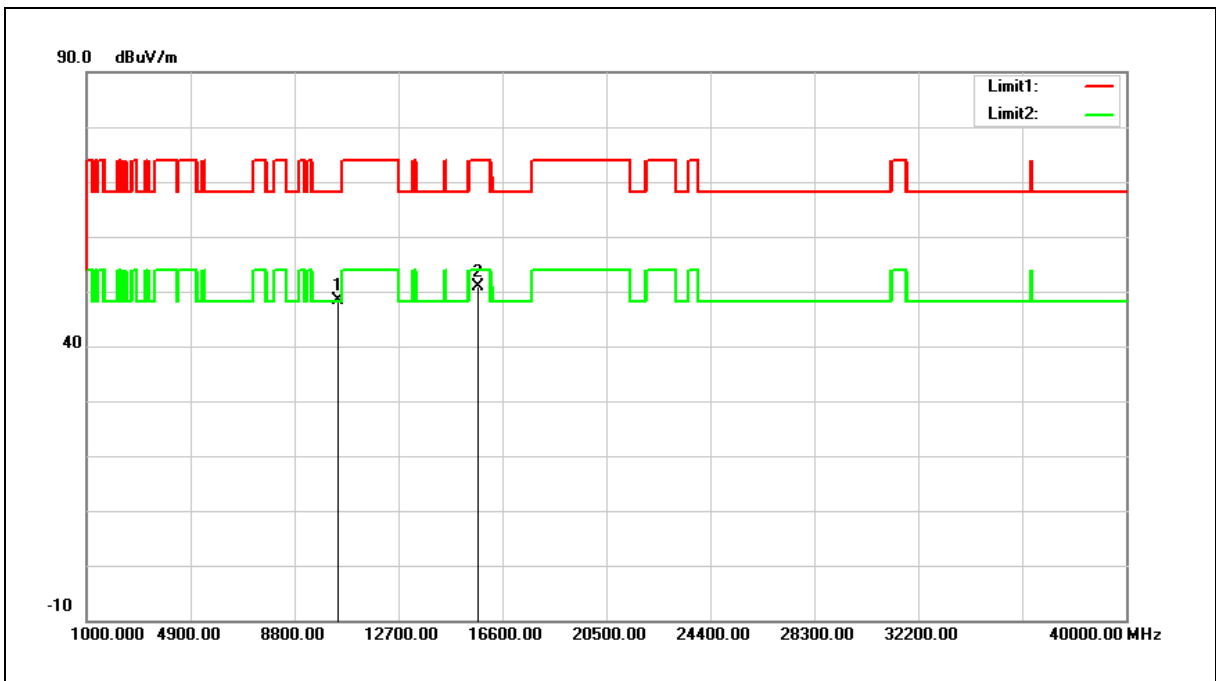

No.	Frequency (MHz)	Reading (dBuV)	Correct Factor (dB/m)	Result (dBuV/m)	Limit (dBuV/m)	Margin (dB)	Remark
1	10460.000	32.00	16.41	48.41	68.20	-19.79	peak
2	15690.000	32.88	17.96	50.84	74.00	-23.16	peak

Note: 1.Result (dBuV/m) = Correct Factor (dB/m) + Reading(dBuV).

2.Correction factor (dB/m) = Antenna Factor (dB/m) + Cable loss (dB) – Pre-Amplifier gain (dB).

3.When the peak results are less than average limit, so not need to evaluate the average.



Standard:	FCC Part 15.407	Test Distance:	3m
Test item:	Harmonic	Power:	AC 120V/60Hz
Frequency:	5230MHz	Temp.(°C)/Hum.(%RH):	26(°C)/60%RH
Mode:	Mode 4		
Ant.Polar.:	Vertical		

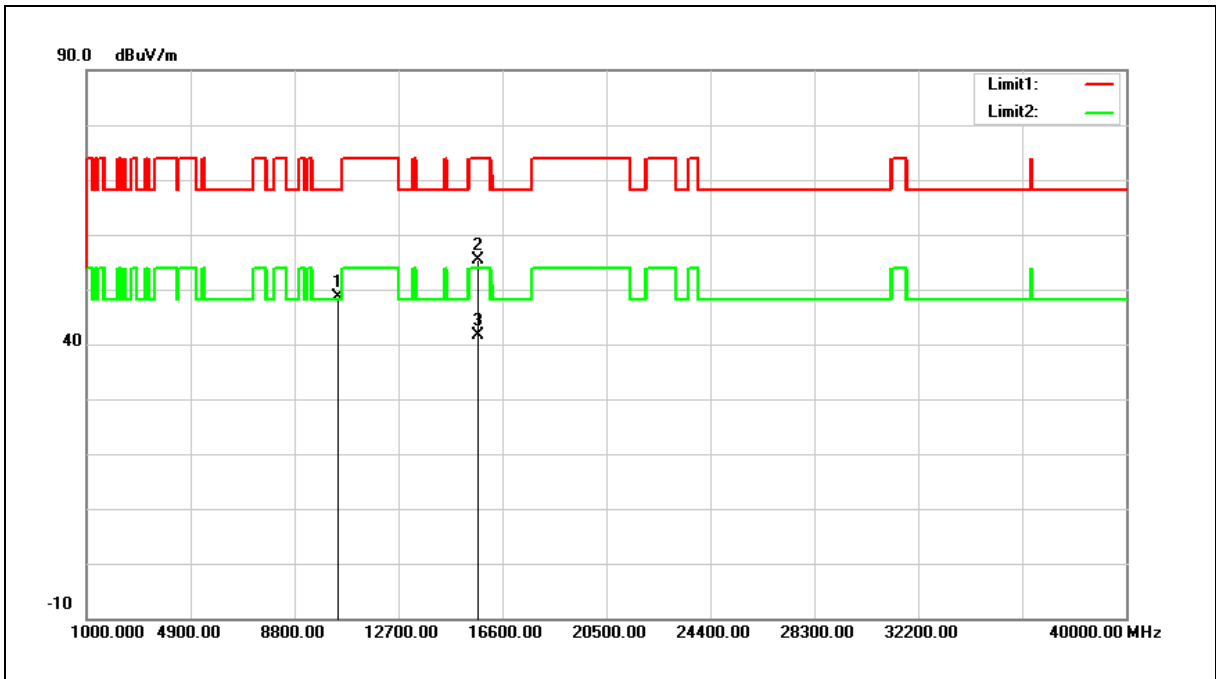

No.	Frequency (MHz)	Reading (dBuV)	Correct Factor (dB/m)	Result (dBuV/m)	Limit (dBuV/m)	Margin (dB)	Remark
1	10460.000	32.24	16.41	48.65	68.20	-19.55	peak
2	15690.000	37.39	17.96	55.35	74.00	-18.65	peak
3	15690.000	23.56	17.96	41.52	54.00	-12.48	AVG

Note:1.Result (dBuV/m) = Correct Factor (dB/m) + Reading(dBuV).

2.Correction factor (dB/m) = Antenna Factor (dB/m) + Cable loss (dB) – Pre-Amplifier gain (dB).

3.When the peak results are less than average limit, so not need to evaluate the average.



Standard:	FCC Part 15.407	Test Distance:	3m
Test item:	Harmonic	Power:	AC 120V/60Hz
Frequency:	5755MHz	Temp.(°C)/Hum.(%RH):	26(°C)/60%RH
Mode:	Mode 4		
Ant.Polar.:	Horizontal		

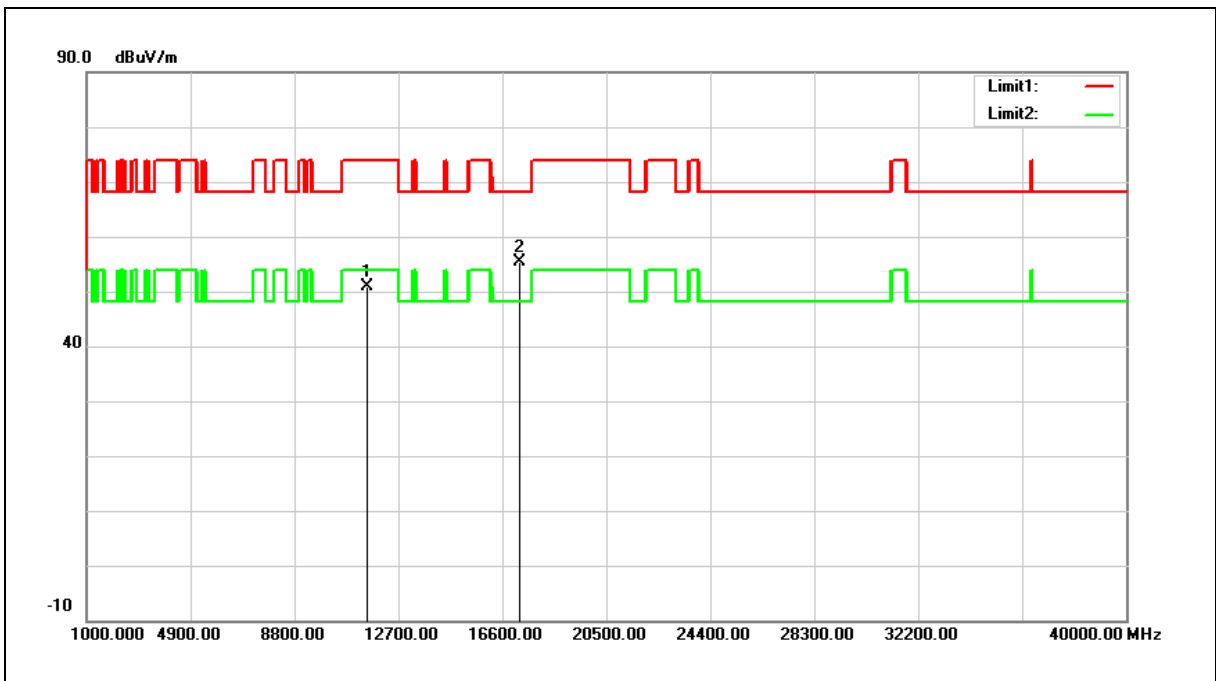

No.	Frequency (MHz)	Reading (dBuV)	Correct Factor (dB/m)	Result (dBuV/m)	Limit (dBuV/m)	Margin (dB)	Remark
1	11510.000	32.74	18.11	50.85	74.00	-23.15	peak
2	17265.000	32.37	23.00	55.37	68.20	-12.83	peak

- Note: 1.Result (dBuV/m) = Correct Factor (dB/m) + Reading(dBuV).
 2.Correction factor (dB/m) = Antenna Factor (dB/m) + Cable loss (dB) – Pre-Amplifier gain (dB).
 3.When the peak results are less than average limit, so not need to evaluate the average.



Standard:	FCC Part 15.407	Test Distance:	3m
Test item:	Harmonic	Power:	AC 120V/60Hz
Frequency:	5755MHz	Temp.(°C)/Hum.(%RH):	26(°C)/60%RH
Mode:	Mode 4		
Ant.Polar.:	Vertical		

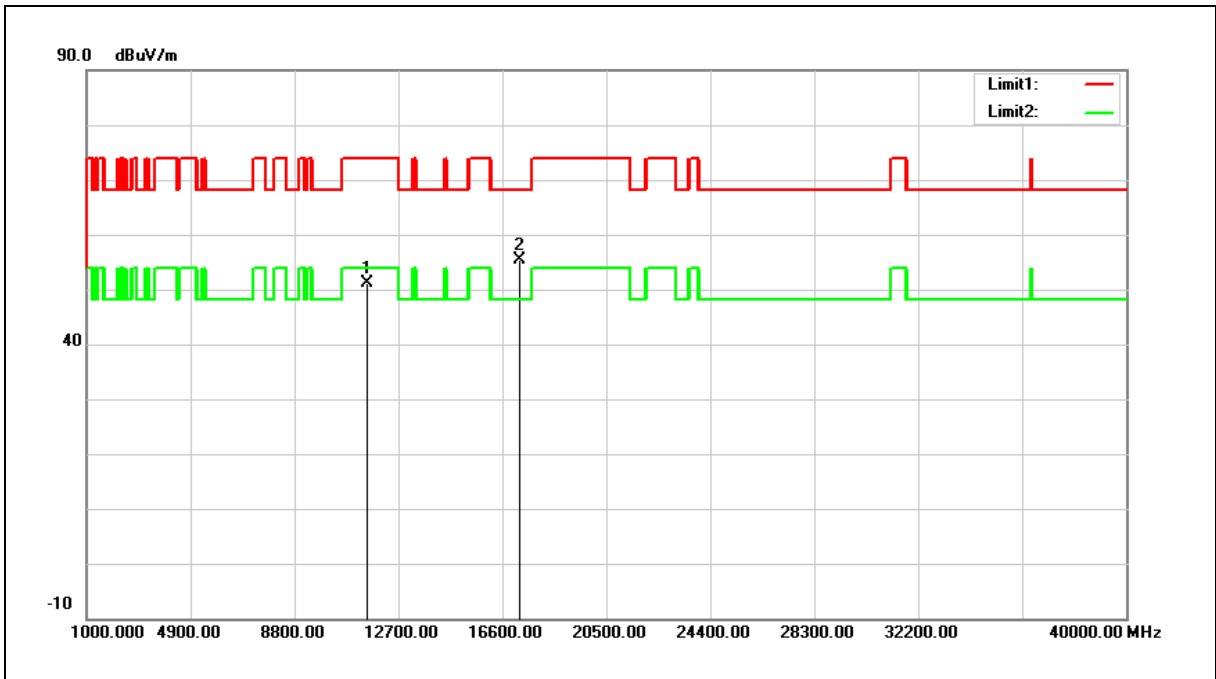

No.	Frequency (MHz)	Reading (dBuV)	Correct Factor (dB/m)	Result (dBuV/m)	Limit (dBuV/m)	Margin (dB)	Remark
1	11510.000	32.93	18.11	51.04	74.00	-22.96	peak
2	17265.000	32.41	23.00	55.41	68.20	-12.79	peak

- Note: 1.Result (dBuV/m) = Correct Factor (dB/m) + Reading(dBuV).
 2.Correction factor (dB/m) = Antenna Factor (dB/m) + Cable loss (dB) – Pre-Amplifier gain (dB).
 3.When the peak results are less than average limit, so not need to evaluate the average.



Standard:	FCC Part 15.407	Test Distance:	3m
Test item:	Harmonic	Power:	AC 120V/60Hz
Frequency:	5795MHz	Temp.(°C)/Hum.(%RH):	26(°C)/60%RH
Mode:	Mode 4		
Ant.Polar.:	Horizontal		

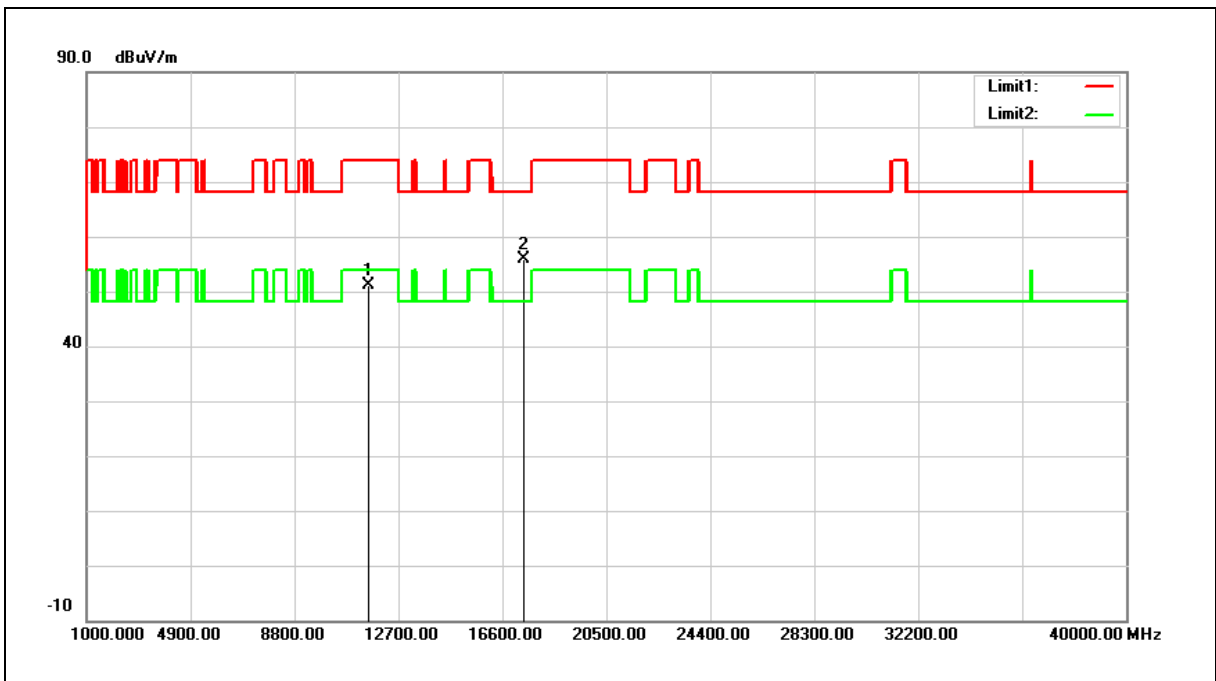

No.	Frequency (MHz)	Reading (dBuV)	Correct Factor (dB/m)	Result (dBuV/m)	Limit (dBuV/m)	Margin (dB)	Remark
1	11590.000	33.21	18.00	51.21	74.00	-22.79	peak
2	17385.000	32.25	23.60	55.85	68.20	-12.35	peak

- Note: 1.Result (dBuV/m) = Correct Factor (dB/m) + Reading(dBuV).
 2.Correction factor (dB/m) = Antenna Factor (dB/m) + Cable loss (dB) – Pre-Amplifier gain (dB).
 3.When the peak results are less than average limit, so not need to evaluate the average.



Standard:	FCC Part 15.407	Test Distance:	3m
Test item:	Harmonic	Power:	AC 120V/60Hz
Frequency:	5795MHz	Temp.(°C)/Hum.(%RH):	26(°C)/60%RH
Mode:	Mode 4		
Ant.Polar.:	Vertical		

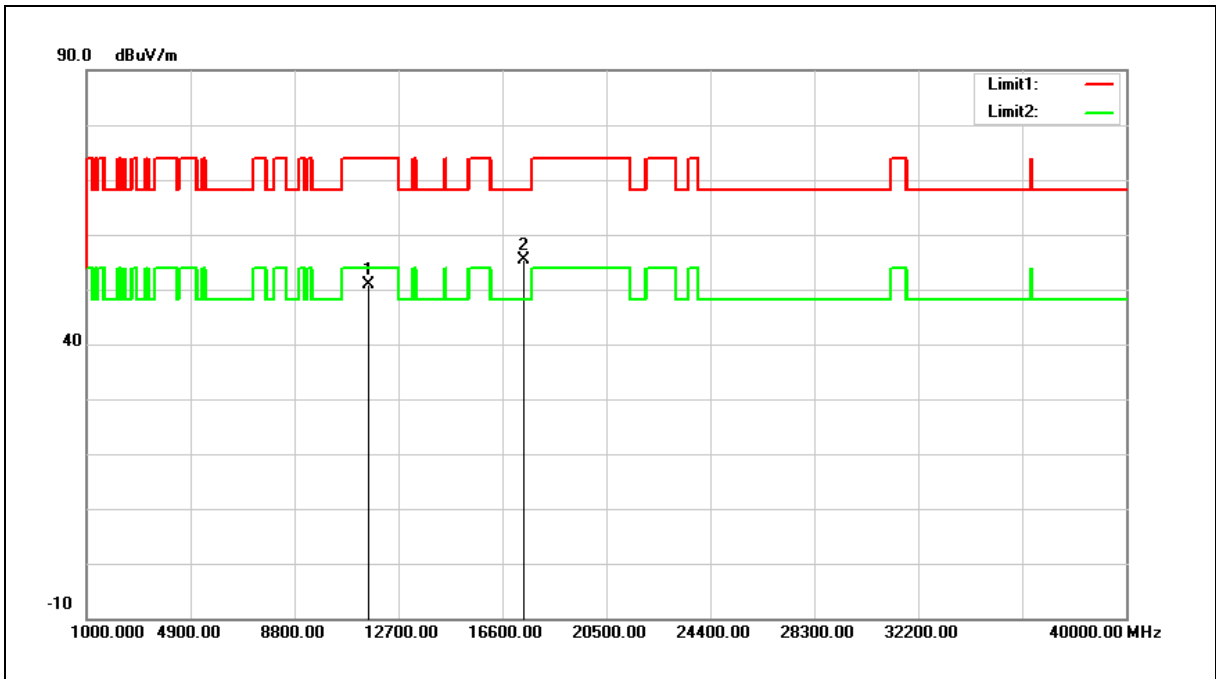

No.	Frequency (MHz)	Reading (dBuV)	Correct Factor (dB/m)	Result (dBuV/m)	Limit (dBuV/m)	Margin (dB)	Remark
1	11590.000	32.87	18.00	50.87	74.00	-23.13	peak
2	17385.000	31.75	23.60	55.35	68.20	-12.85	peak

- Note: 1.Result (dBuV/m) = Correct Factor (dB/m) + Reading(dBuV).
 2.Correction factor (dB/m) = Antenna Factor (dB/m) + Cable loss (dB) – Pre-Amplifier gain (dB).
 3.When the peak results are less than average limit, so not need to evaluate the average.



Standard:	FCC Part 15.407	Test Distance:	3m
Test item:	Harmonic	Power:	AC 120V/60Hz
Frequency:	5210MHz	Temp.(°C)/Hum.(%RH):	26(°C)/60%RH
Mode:	Mode 5		
Ant.Polar.:	Horizontal		

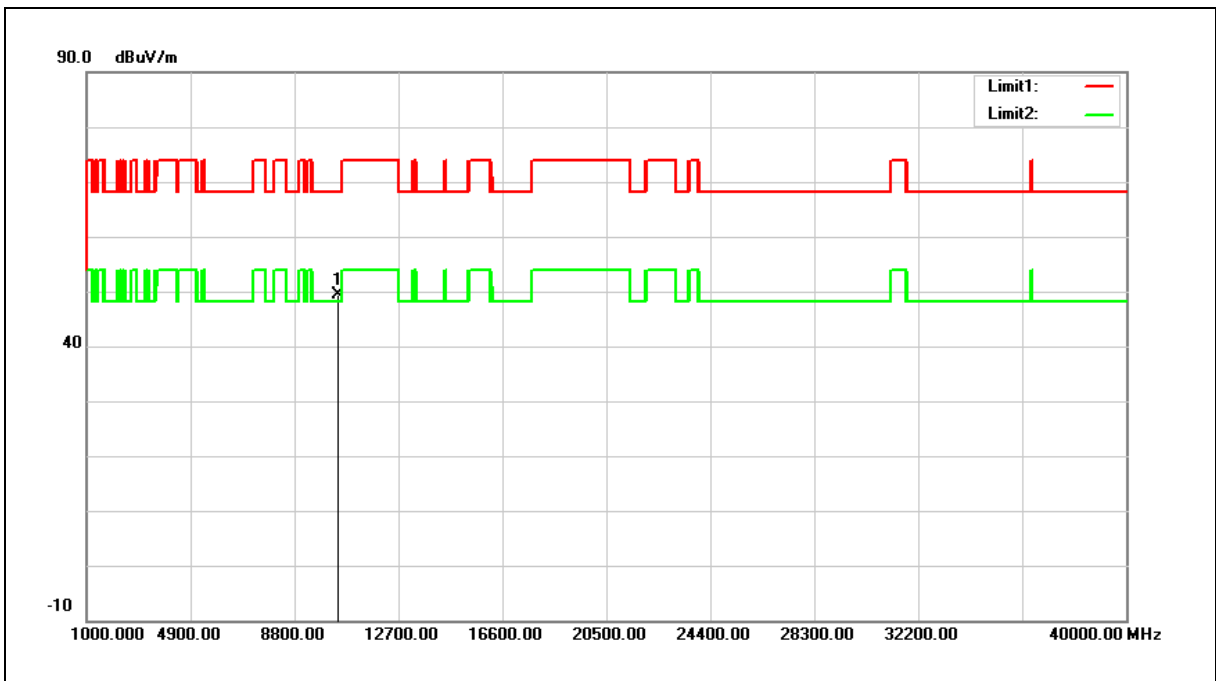

No.	Frequency (MHz)	Reading (dBuV)	Correct Factor (dB/m)	Result (dBuV/m)	Limit (dBuV/m)	Margin (dB)	Remark
1	10420.000	33.09	16.28	49.37	68.20	-18.83	peak

Note:1.Result (dBuV/m) = Correct Factor (dB/m) + Reading(dBuV).

2.Correction factor (dB/m) = Antenna Factor (dB/m) + Cable loss (dB) – Pre-Amplifier gain (dB).

3.When the peak results are less than average limit, so not need to evaluate the average.



Standard:	FCC Part 15.407	Test Distance:	3m
Test item:	Harmonic	Power:	AC 120V/60Hz
Frequency:	5210MHz	Temp.(°C)/Hum.(%RH):	26(°C)/60%RH
Mode:	Mode 5		
Ant.Polar.:	Vertical		

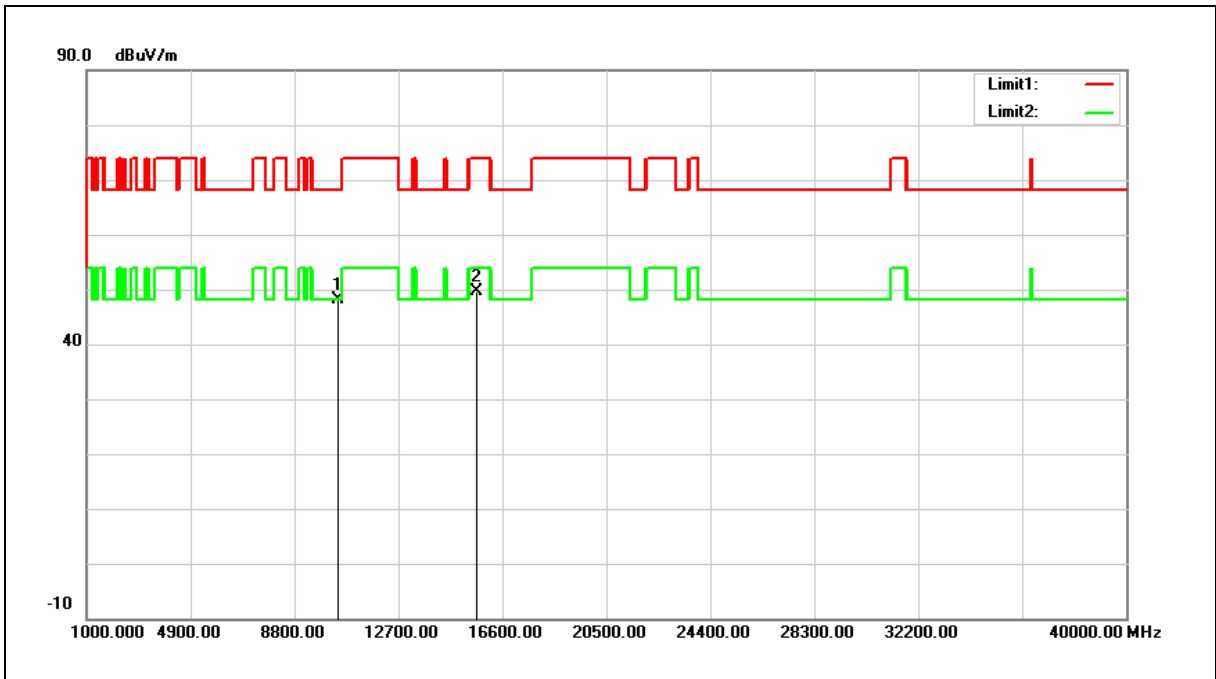

No.	Frequency (MHz)	Reading (dBuV)	Correct Factor (dB/m)	Result (dBuV/m)	Limit (dBuV/m)	Margin (dB)	Remark
1	10420.000	31.78	16.28	48.06	68.20	-20.14	peak
2	15630.000	31.47	18.11	49.58	74.00	-24.42	peak

- Note: 1.Result (dBuV/m) = Correct Factor (dB/m) + Reading(dBuV).
 2.Correction factor (dB/m) = Antenna Factor (dB/m) + Cable loss (dB) – Pre-Amplifier gain (dB).
 3.When the peak results are less than average limit, so not need to evaluate the average.



Standard:	FCC Part 15.407	Test Distance:	3m
Test item:	Harmonic	Power:	AC 120V/60Hz
Frequency:	5775MHz	Temp.(°C)/Hum.(%RH):	26(°C)/60%RH
Mode:	Mode 5		
Ant.Polar.:	Horizontal		

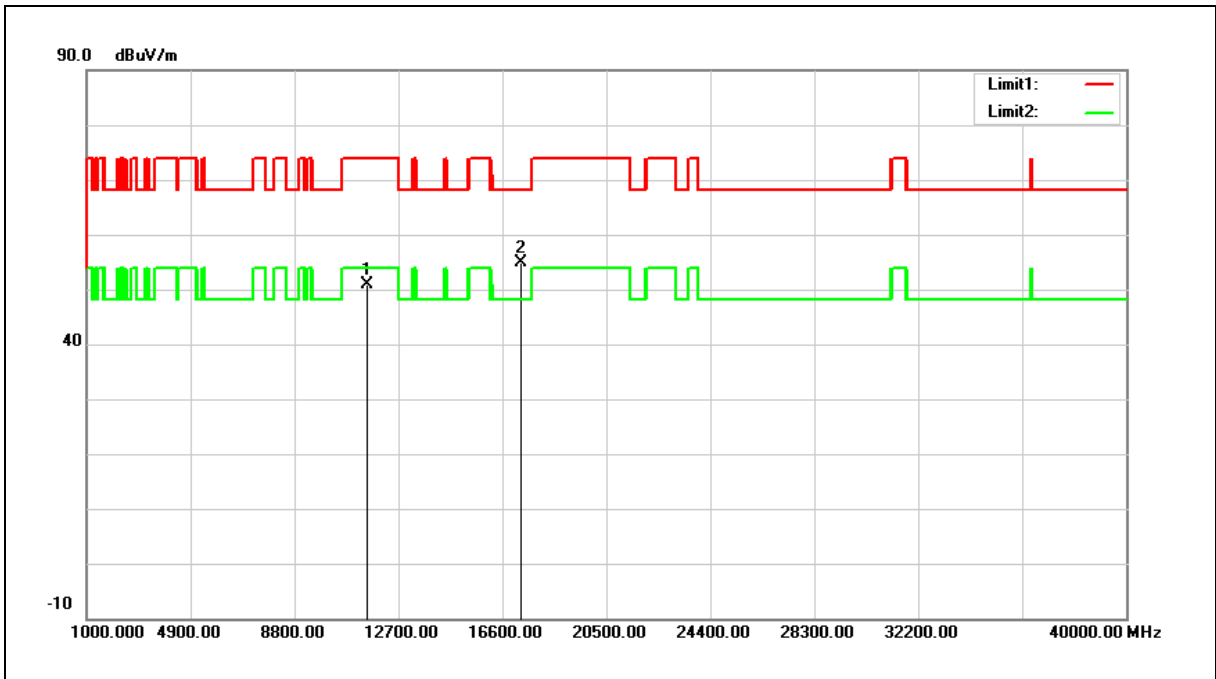

No.	Frequency (MHz)	Reading (dBuV)	Correct Factor (dB/m)	Result (dBuV/m)	Limit (dBuV/m)	Margin (dB)	Remark
1	11550.000	32.77	18.06	50.83	74.00	-23.17	peak
2	17325.000	31.62	23.30	54.92	68.20	-13.28	peak

Note: 1.Result (dBuV/m) = Correct Factor (dB/m) + Reading(dBuV).

2.Correction factor (dB/m) = Antenna Factor (dB/m) + Cable loss (dB) – Pre-Amplifier gain (dB).

3.When the peak results are less than average limit, so not need to evaluate the average.



Standard:	FCC Part 15.407	Test Distance:	3m
Test item:	Harmonic	Power:	AC 120V/60Hz
Frequency:	5775MHz	Temp.(°C)/Hum.(%RH):	26(°C)/60%RH
Mode:	Mode 5		
Ant.Polar.:	Vertical		

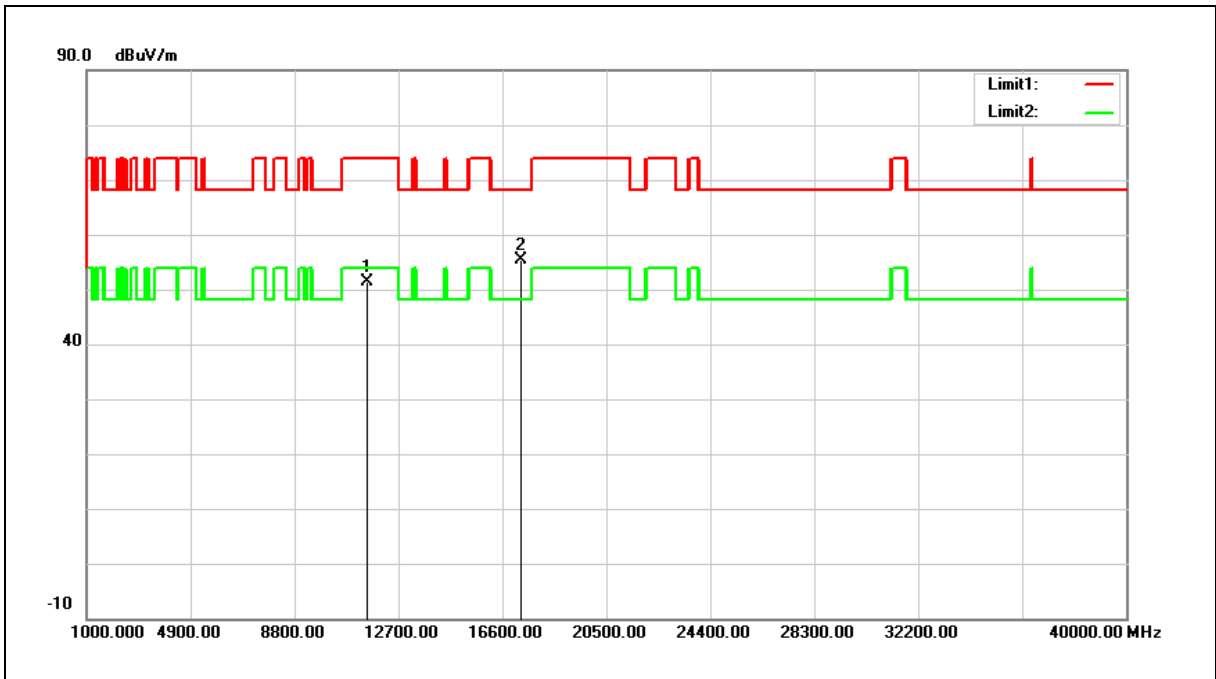

No.	Frequency (MHz)	Reading (dBuV)	Correct Factor (dB/m)	Result (dBuV/m)	Limit (dBuV/m)	Margin (dB)	Remark
1	11550.000	33.26	18.06	51.32	74.00	-22.68	peak
2	17325.000	32.16	23.30	55.46	68.20	-12.74	peak

- Note: 1.Result (dBuV/m) = Correct Factor (dB/m) + Reading(dBuV).
- 2.Correction factor (dB/m) = Antenna Factor (dB/m) + Cable loss (dB) – Pre-Amplifier gain (dB).
- 3.When the peak results are less than average limit, so not need to evaluate the average.



Standard:	FCC Part 15.407	Test Distance:	3m
Test item:	Transmitter Unwanted Emissions	Power:	AC 120V/60Hz
Test Mode:	Simultaneous Transmitting (DTS+NII)	Temp.(°C)/Hum.(%RH):	26(°C)/60%RH
Ant.Polar.:	Horizontal		

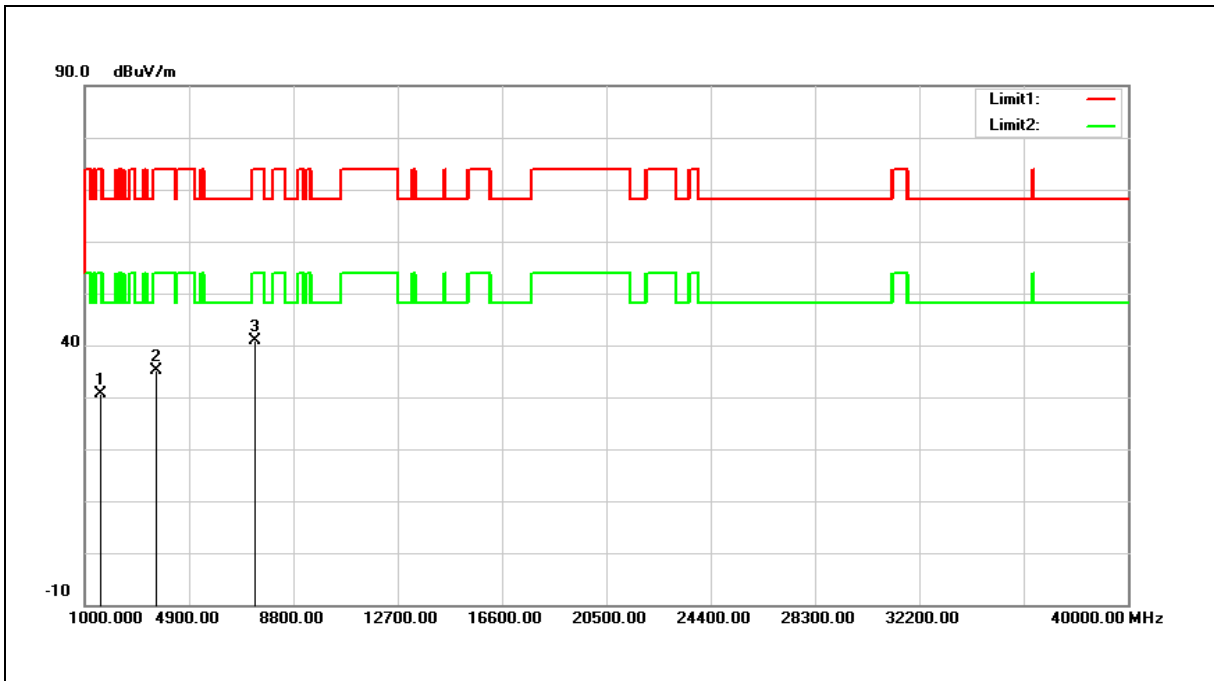

No.	Frequency (MHz)	Reading (dBuV)	Correct Factor (dB/m)	Result (dBuV/m)	Limit (dBuV/m)	Margin (dB)	Remark
1	1561.000	36.07	-5.35	30.72	74.00	-43.28	peak
2	3703.000	33.33	1.70	35.03	74.00	-38.97	peak
3	7341.000	29.23	11.54	40.77	74.00	-33.23	peak

Note:1.Result (dBuV/m) = Correct Factor (dB/m) + Reading(dBuV).

2.Correction factor (dB/m) = Antenna Factor (dB/m) + Cable loss (dB) – Pre-Amplifier gain (dB).

3. When the peak results are less than average limit, so not need to evaluate the average.



Standard:	FCC Part 15.407	Test Distance:	3m
Test item:	Transmitter Unwanted Emissions	Power:	AC 120V/60Hz
Test Mode:	Simultaneous Transmitting (DTS+NII)	Temp.(°C)/Hum.(%RH):	26(°C)/60%RH
Ant.Polar.:	Vertical		

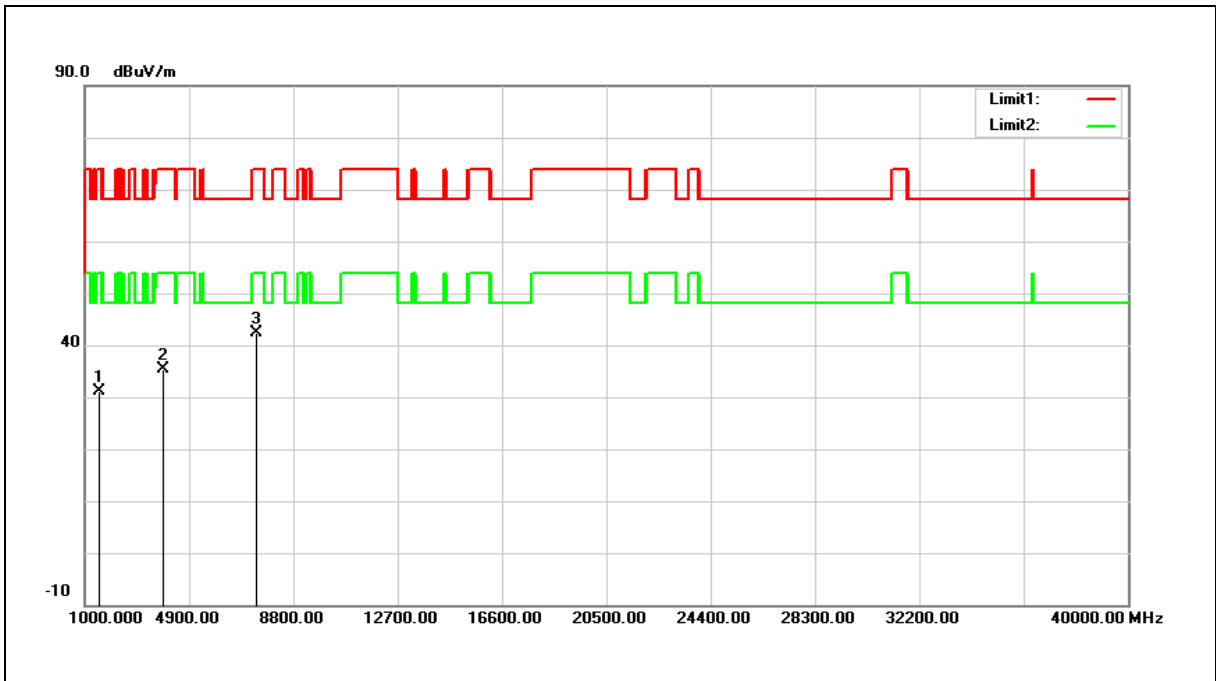

No.	Frequency (MHz)	Reading (dBuV)	Correct Factor (dB/m)	Result (dBuV/m)	Limit (dBuV/m)	Margin (dB)	Remark
1	1527.000	36.74	-5.51	31.23	74.00	-42.77	peak
2	3958.000	32.82	2.47	35.29	74.00	-38.71	peak
3	7409.000	30.68	11.71	42.39	74.00	-31.61	peak

Note:1.Result (dBuV/m) = Correct Factor (dB/m) + Reading(dBuV).

2.Correction factor (dB/m) = Antenna Factor (dB/m) + Cable loss (dB) – Pre-Amplifier gain (dB).

3. When the peak results are less than average limit, so not need to evaluate the average.



Band Edge

Standard:	FCC Part 15.407	Test Distance:	3m
Test item:	Band edge	Power:	AC 120V/60Hz
Frequency:	5180MHz	Temp.(°C)/Hum.(%RH):	26(°C)/60%RH
Mode:	Mode 2		
Ant.Polar.:	Horizontal		

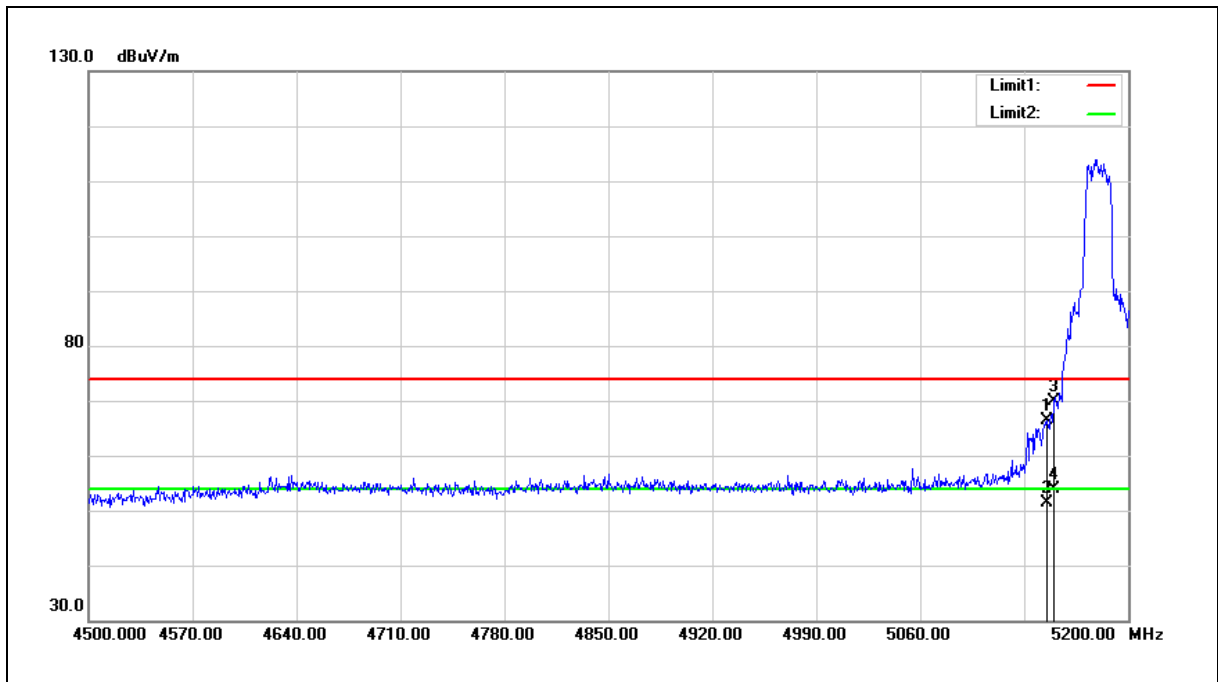

No.	Frequency (MHz)	Reading (dBuV)	Correct Factor (dB/m)	Result (dBuV/m)	Limit (dBuV/m)	Margin (dB)	Remark
1	5145.400	60.61	5.77	66.38	74.00	-7.62	peak
2	5145.400	45.69	5.77	51.46	54.00	-2.54	AVG
3	5150.000	63.99	5.78	69.77	74.00	-4.23	peak
4	5150.000	47.98	5.78	53.76	54.00	-0.24	AVG

Note:1.Result (dBuV/m) = Correct Factor (dB/m) + Reading(dBuV).

2.Correction factor (dB/m) = Antenna Factor (dB/m) + Cable loss (dB) – Pre-Amplifier gain (dB).

3.When the peak results are less than average limit, so not need to evaluate the average.



Standard:	FCC Part 15.407	Test Distance:	3m
Test item:	Band edge	Power:	AC 120V/60Hz
Frequency:	5180MHz	Temp.(°C)/Hum.(%RH):	26(°C)/60%RH
Mode:	Mode 2		
Ant.Polar.:	Vertical		

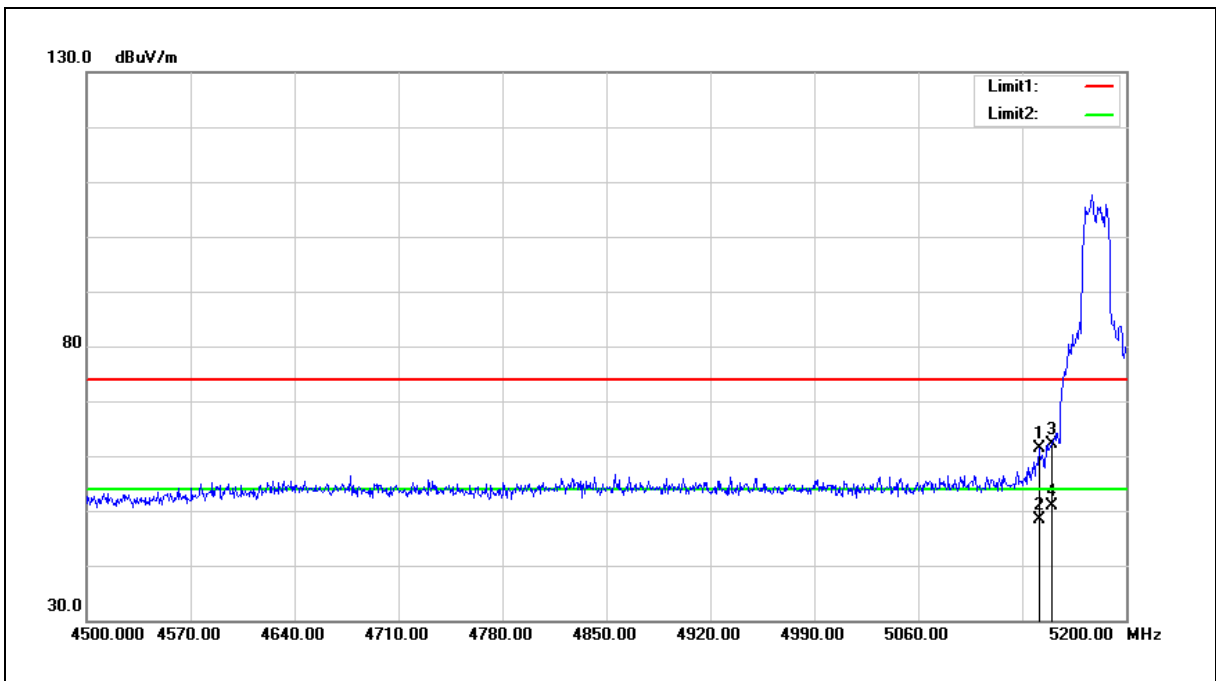

No.	Frequency (MHz)	Reading (dBuV)	Correct Factor (dB/m)	Result (dBuV/m)	Limit (dBuV/m)	Margin (dB)	Remark
1	5141.200	55.52	5.76	61.28	74.00	-12.72	peak
2	5141.200	42.67	5.76	48.43	54.00	-5.57	AVG
3	5150.000	56.29	5.78	62.07	74.00	-11.93	peak
4	5150.000	45.00	5.78	50.78	54.00	-3.22	AVG

Note:1.Result (dBuV/m) = Correct Factor (dB/m) + Reading(dBuV).

2.Correction factor (dB/m) = Antenna Factor (dB/m) + Cable loss (dB) – Pre-Amplifier gain (dB).

3.When the peak results are less than average limit, so not need to evaluate the average.



Standard:	FCC Part 15.407	Test Distance:	3m
Test item:	Band edge	Power:	AC 120V/60Hz
Frequency:	5200MHz	Temp.(°C)/Hum.(%RH):	26(°C)/60%RH
Mode:	Mode 2		
Ant.Polar.:	Horizontal		

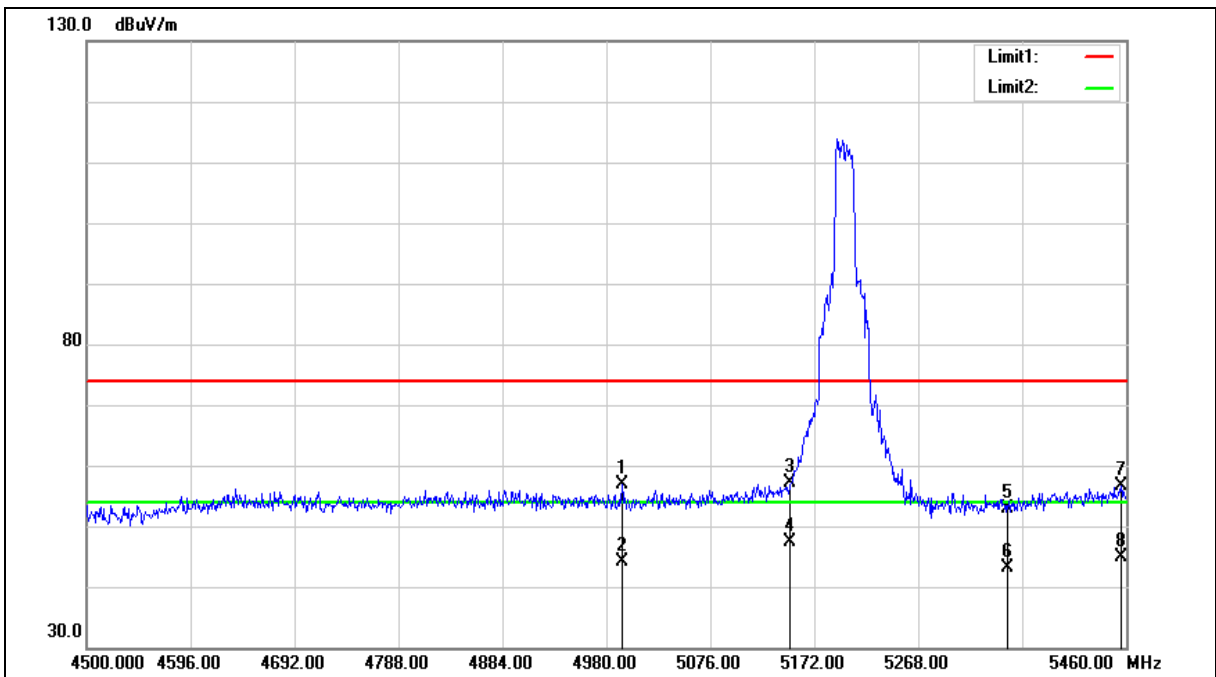



Standard:	FCC Part 15.407	Test Distance:	3m
Test item:	Band edge	Power:	AC 120V/60Hz
Frequency:	5200MHz	Temp.(°C)/Hum.(%RH):	26(°C)/60%RH
Mode:	Mode 2		
Ant.Polar.:	Horizontal		

No.	Frequency (MHz)	Reading (dBuV)	Correct Factor (dB/m)	Result (dBuV/m)	Limit (dBuV/m)	Margin (dB)	Remark
1	4994.400	51.44	5.54	56.98	74.00	-17.02	peak
2	4994.400	38.62	5.54	44.16	54.00	-9.84	AVG
3	5150.000	51.23	5.78	57.01	74.00	-16.99	peak
4	5150.000	41.59	5.78	47.37	54.00	-6.63	AVG
5	5350.000	46.76	6.07	52.83	74.00	-21.17	peak
6	5350.000	37.09	6.07	43.16	54.00	-10.84	AVG
7	5455.200	50.48	6.22	56.70	74.00	-17.30	peak
8	5455.200	38.56	6.22	44.78	54.00	-9.22	AVG

Note:1.Result (dBuV/m) = Correct Factor (dB/m) + Reading(dBuV).

2.Correction factor (dB/m) = Antenna Factor (dB/m) + Cable loss (dB) – Pre-Amplifier gain (dB).

3.When the peak results are less than average limit, so not need to evaluate the average.



Standard:	FCC Part 15.407	Test Distance:	3m
Test item:	Band edge	Power:	AC 120V/60Hz
Frequency:	5200MHz	Temp.(°C)/Hum.(%RH):	26(°C)/60%RH
Mode:	Mode 2		
Ant.Polar.:	Vertical		

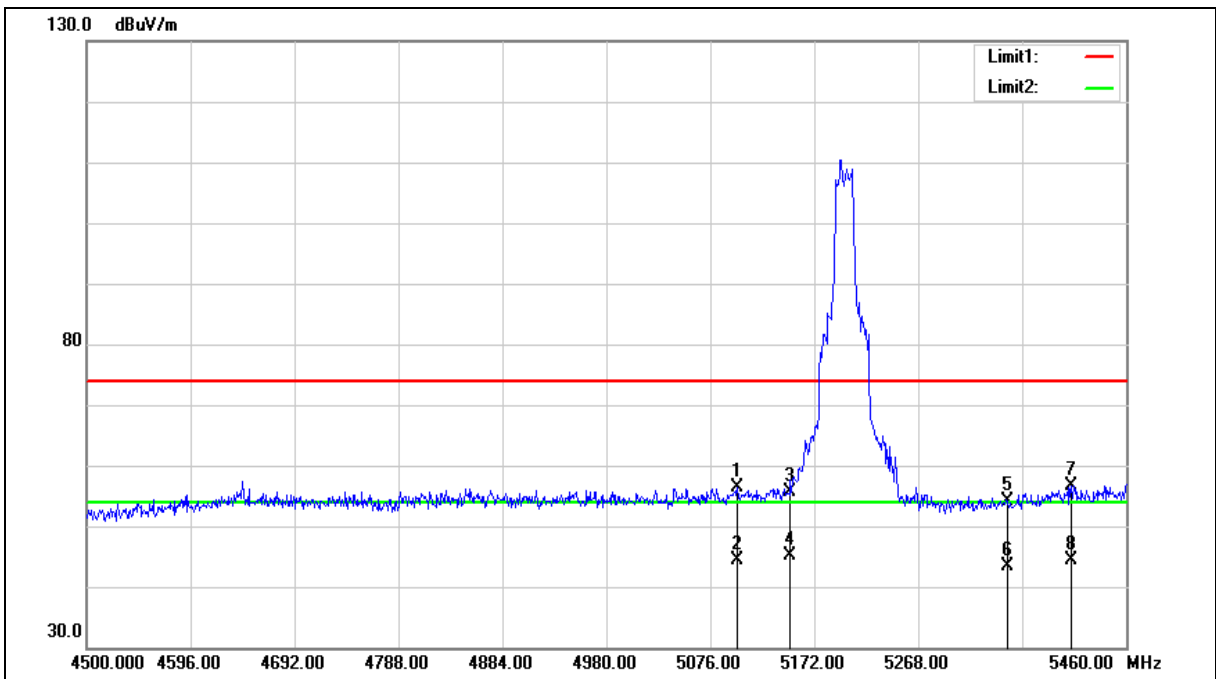



Standard:	FCC Part 15.407	Test Distance:	3m
Test item:	Band edge	Power:	AC 120V/60Hz
Frequency:	5200MHz	Temp.(°C)/Hum.(%RH):	26(°C)/60%RH
Mode:	Mode 2		
Ant.Polar.:	Vertical		

No.	Frequency (MHz)	Reading (dBuV)	Correct Factor (dB/m)	Result (dBuV/m)	Limit (dBuV/m)	Margin (dB)	Remark
1	5100.960	50.65	5.70	56.35	74.00	-17.65	peak
2	5100.960	38.66	5.70	44.36	54.00	-9.64	AVG
3	5150.000	49.85	5.78	55.63	74.00	-18.37	peak
4	5150.000	39.46	5.78	45.24	54.00	-8.76	AVG
5	5350.000	48.16	6.07	54.23	74.00	-19.77	peak
6	5350.000	37.20	6.07	43.27	54.00	-10.73	AVG
7	5409.120	50.52	6.16	56.68	74.00	-17.32	peak
8	5409.120	38.15	6.16	44.31	54.00	-9.69	AVG

Note:1.Result (dBuV/m) = Correct Factor (dB/m) + Reading(dBuV).

2.Correction factor (dB/m) = Antenna Factor (dB/m) + Cable loss (dB) – Pre-Amplifier gain (dB).

3.When the peak results are less than average limit, so not need to evaluate the average.



Standard:	FCC Part 15.407	Test Distance:	3m
Test item:	Band edge	Power:	AC 120V/60Hz
Frequency:	5240MHz	Temp.(°C)/Hum.(%RH):	26(°C)/60%RH
Mode:	Mode 2		
Ant.Polar.:	Horizontal		

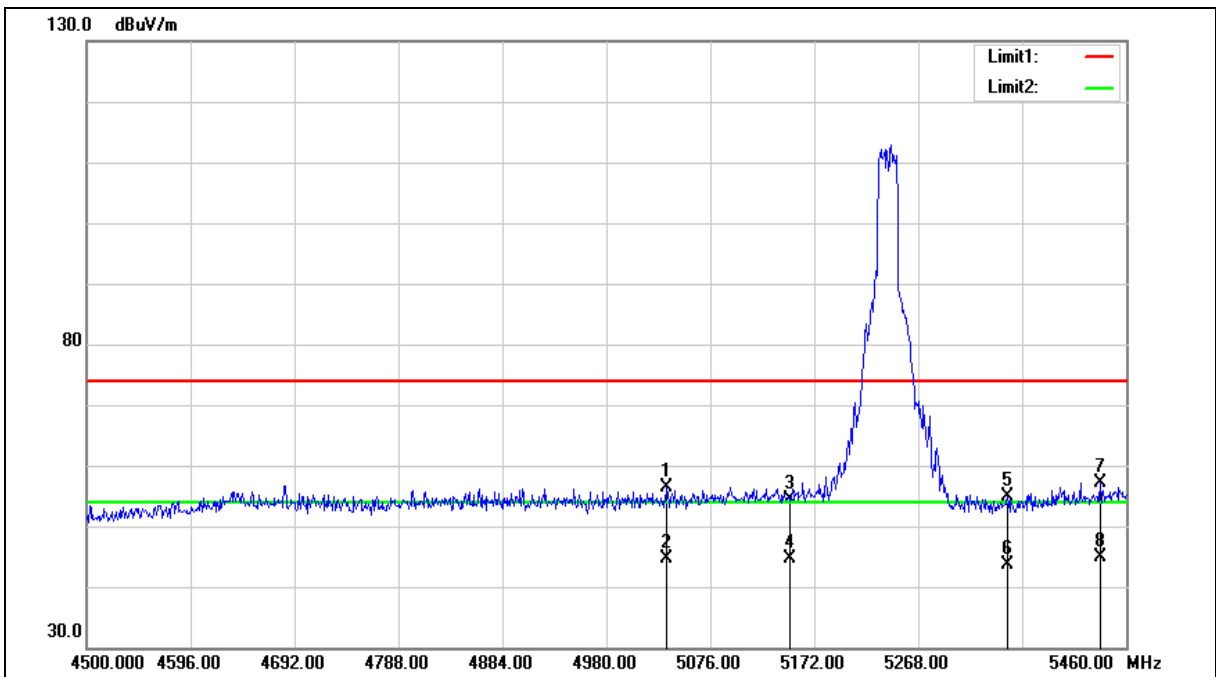



Standard:	FCC Part 15.407	Test Distance:	3m
Test item:	Band edge	Power:	AC 120V/60Hz
Frequency:	5240MHz	Temp.(°C)/Hum.(%RH):	26(°C)/60%RH
Mode:	Mode 2		
Ant.Polar.:	Horizontal		

No.	Frequency (MHz)	Reading (dBuV)	Correct Factor (dB/m)	Result (dBuV/m)	Limit (dBuV/m)	Margin (dB)	Remark
1	5035.680	50.81	5.60	56.41	74.00	-17.59	peak
2	5035.680	38.96	5.60	44.56	54.00	-9.44	AVG
3	5150.000	48.50	5.78	54.28	74.00	-19.72	peak
4	5150.000	38.89	5.78	44.67	54.00	-9.33	AVG
5	5350.000	48.73	6.07	54.80	74.00	-19.20	peak
6	5350.000	37.50	6.07	43.57	54.00	-10.43	AVG
7	5436.000	50.96	6.20	57.16	74.00	-16.84	peak
8	5436.000	38.63	6.20	44.83	54.00	-9.17	AVG

Note:1.Result (dBuV/m) = Correct Factor (dB/m) + Reading(dBuV).

2.Correction factor (dB/m) = Antenna Factor (dB/m) + Cable loss (dB) – Pre-Amplifier gain (dB).

3.When the peak results are less than average limit, so not need to evaluate the average.



Standard:	FCC Part 15.407	Test Distance:	3m
Test item:	Band edge	Power:	AC 120V/60Hz
Frequency:	5240MHz	Temp.(°C)/Hum.(%RH):	26(°C)/60%RH
Mode:	Mode 2		
Ant.Polar.:	Vertical		

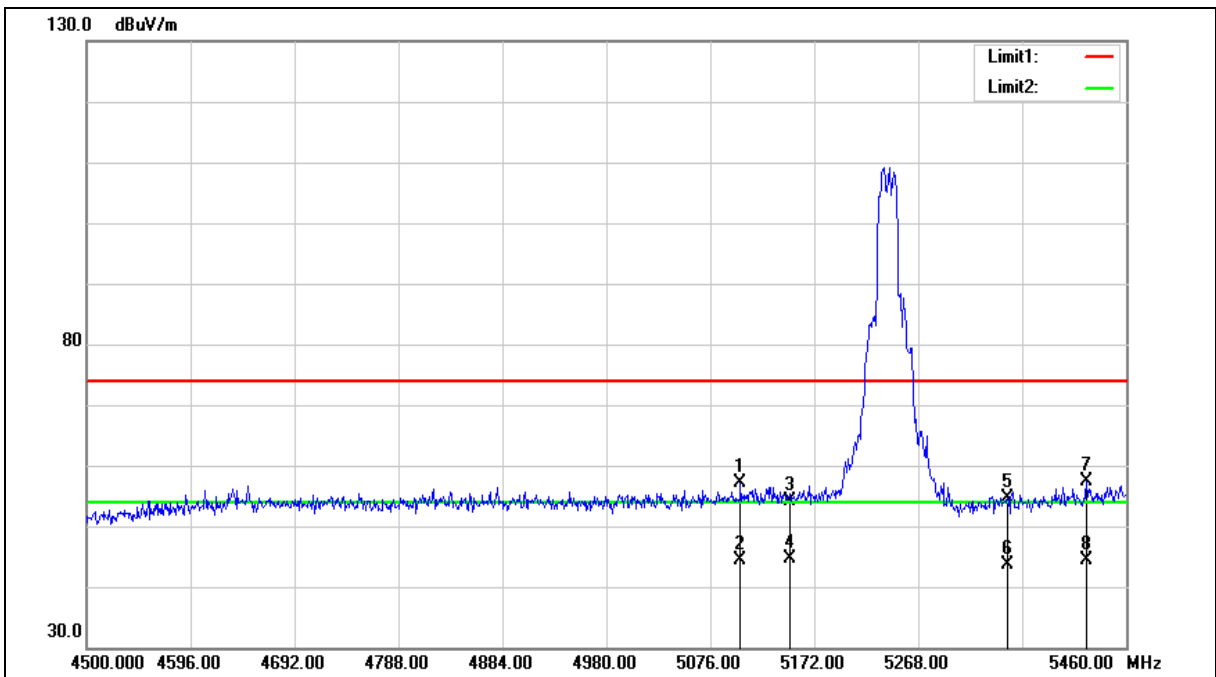



Standard:	FCC Part 15.407	Test Distance:	3m
Test item:	Band edge	Power:	AC 120V/60Hz
Frequency:	5240MHz	Temp.(°C)/Hum.(%RH):	26(°C)/60%RH
Mode:	Mode 2		
Ant.Polar.:	Vertical		

No.	Frequency (MHz)	Reading (dBuV)	Correct Factor (dB/m)	Result (dBuV/m)	Limit (dBuV/m)	Margin (dB)	Remark
1	5103.840	51.45	5.71	57.16	74.00	-16.84	peak
2	5103.840	38.64	5.71	44.35	54.00	-9.65	AVG
3	5150.000	48.44	5.78	54.22	74.00	-19.78	peak
4	5150.000	38.85	5.78	44.63	54.00	-9.37	AVG
5	5350.000	48.67	6.07	54.74	74.00	-19.26	peak
6	5350.000	37.52	6.07	43.59	54.00	-10.41	AVG
7	5423.520	51.08	6.18	57.26	74.00	-16.74	peak
8	5423.520	38.30	6.18	44.48	54.00	-9.52	AVG

Note:1.Result (dBuV/m) = Correct Factor (dB/m) + Reading(dBuV).

2.Correction factor (dB/m) = Antenna Factor (dB/m) + Cable loss (dB) – Pre-Amplifier gain (dB).

3.When the peak results are less than average limit, so not need to evaluate the average.



Standard:	FCC Part 15.407	Test Distance:	3m
Test item:	Band edge	Power:	AC 120V/60Hz
Frequency:	5745MHz	Temp.(°C)/Hum.(%RH):	26(°C)/60%RH
Mode:	Mode 2		
Ant.Polar.:	Horizontal		

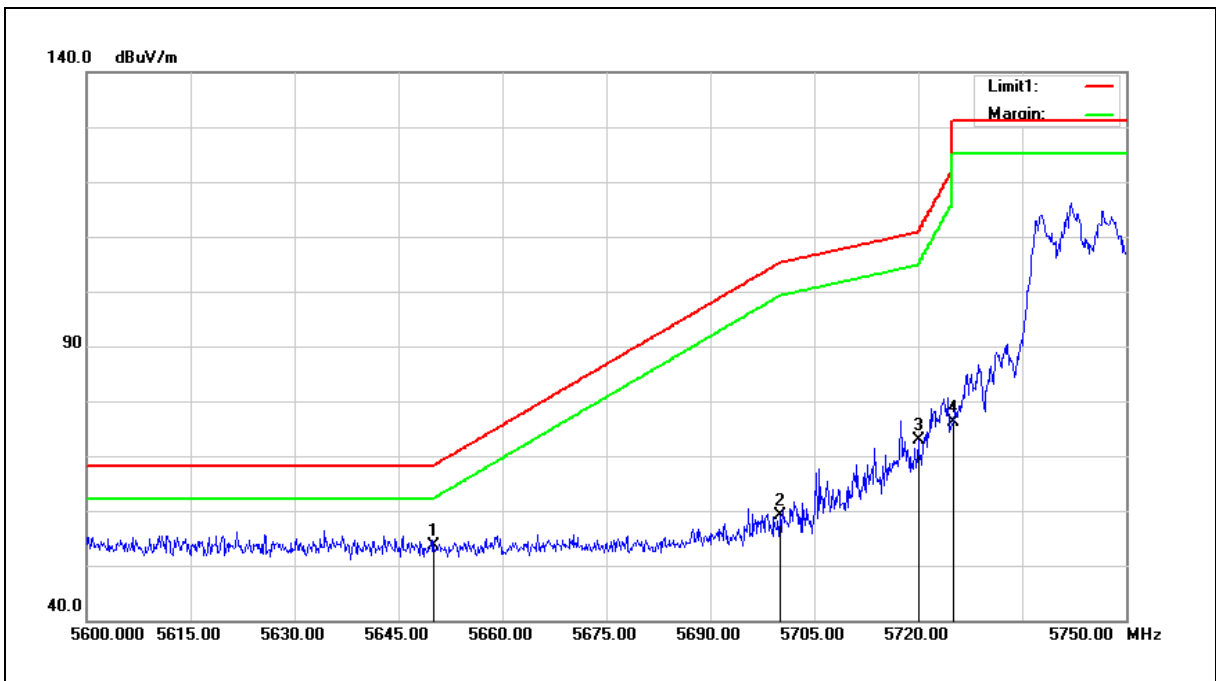

No.	Frequency (MHz)	Reading (dBuV)	Correct Factor (dB/m)	Result (dBuV/m)	Limit (dBuV/m)	Margin (dB)	Remark
1	5650.000	47.01	6.61	53.62	68.20	-14.58	peak
2	5700.000	52.48	6.71	59.19	105.20	-46.01	peak
3	5720.000	66.14	6.77	72.91	110.80	-37.89	peak
4	5725.000	69.31	6.78	76.09	122.20	-46.11	peak

Note:1.Result (dBuV/m) = Correct Factor (dB/m) + Reading(dBuV).

2.Correction factor (dB/m) = Antenna Factor (dB/m) + Cable loss (dB) – Pre-Amplifier gain (dB).

3.When the peak results are less than average limit, so not need to evaluate the average.



Standard:	FCC Part 15.407	Test Distance:	3m
Test item:	Band edge	Power:	AC 120V/60Hz
Frequency:	5745MHz	Temp.(°C)/Hum.(%RH):	26(°C)/60%RH
Mode:	Mode 2		
Ant.Polar.:	Vertical		

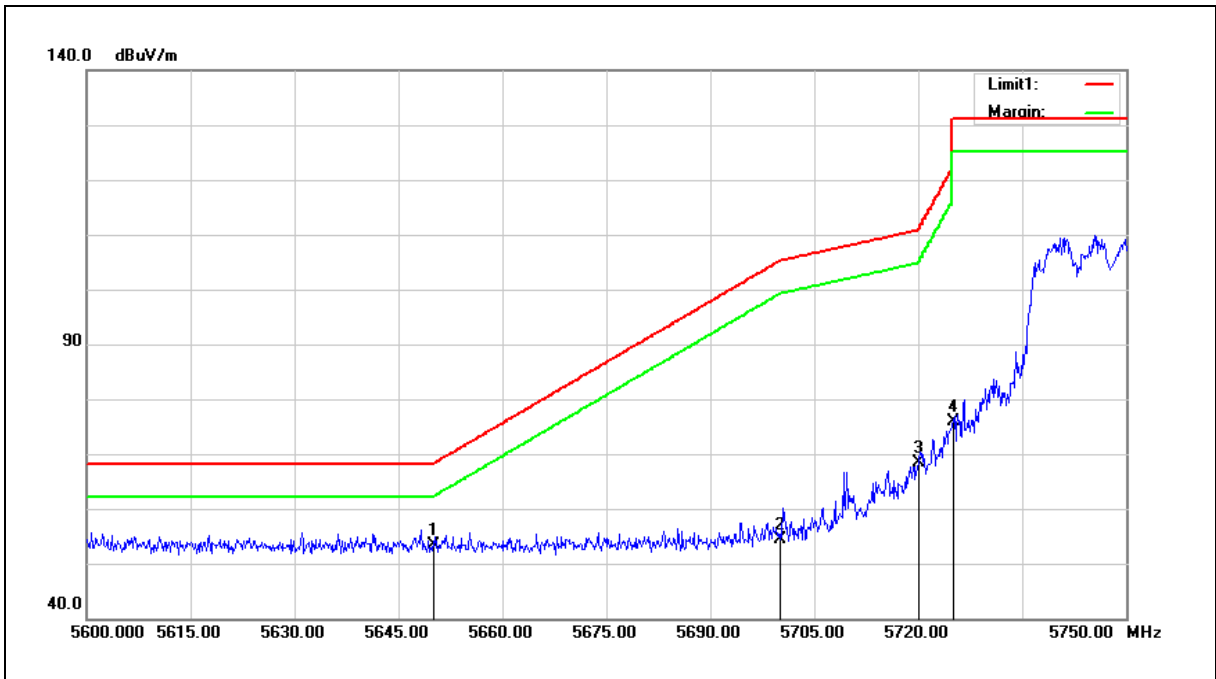

No.	Frequency (MHz)	Reading (dBuV)	Correct Factor (dB/m)	Result (dBuV/m)	Limit (dBuV/m)	Margin (dB)	Remark
1	5650.000	46.83	6.61	53.44	68.20	-14.76	peak
2	5700.000	47.76	6.71	54.47	105.20	-50.73	peak
3	5720.000	61.69	6.77	68.46	110.80	-42.34	peak
4	5725.000	69.01	6.78	75.79	122.20	-46.41	peak

Note:1.Result (dBuV/m) = Correct Factor (dB/m) + Reading(dBuV).

2.Correction factor (dB/m) = Antenna Factor (dB/m) + Cable loss (dB) – Pre-Amplifier gain (dB).

3.When the peak results are less than average limit, so not need to evaluate the average.



Standard:	FCC Part 15.407	Test Distance:	3m
Test item:	Band edge	Power:	AC 120V/60Hz
Frequency:	5785MHz	Temp.(°C)/Hum.(%RH):	26(°C)/60%RH
Mode:	Mode 2		
Ant.Polar.:	Horizontal		

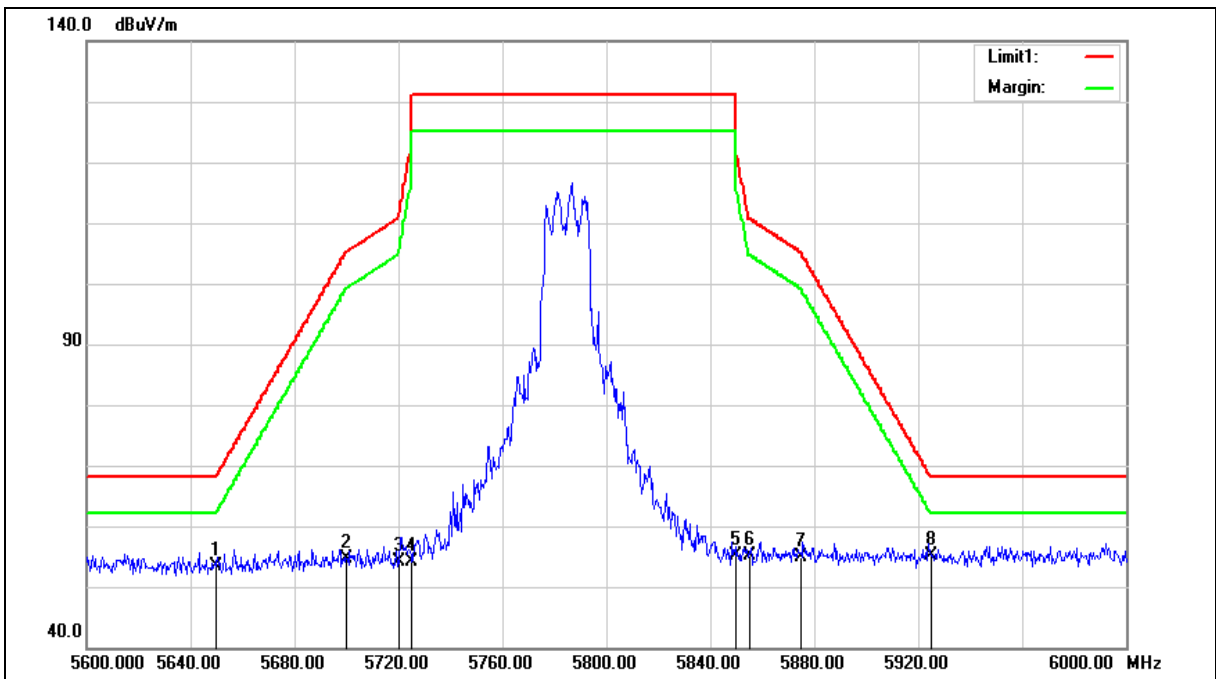



Standard:	FCC Part 15.407	Test Distance:	3m
Test item:	Band edge	Power:	AC 120V/60Hz
Frequency:	5785MHz	Temp.(°C)/Hum.(%RH):	26(°C)/60%RH
Mode:	Mode 2		
Ant.Polar.:	Horizontal		

No.	Frequency (MHz)	Reading (dBuV)	Correct Factor (dB/m)	Result (dBuV/m)	Limit (dBuV/m)	Margin (dB)	Remark
1	5650.000	46.87	6.61	53.48	68.20	-14.72	peak
2	5700.000	47.96	6.71	54.67	105.20	-50.53	peak
3	5720.000	47.31	6.77	54.08	110.80	-56.72	peak
4	5725.000	47.45	6.78	54.23	122.20	-67.97	peak
5	5850.000	48.17	7.03	55.20	122.20	-67.00	peak
6	5855.000	48.21	7.04	55.25	110.80	-55.55	peak
7	5875.000	47.84	7.09	54.93	105.20	-50.27	peak
8	5925.000	47.97	7.20	55.17	68.20	-13.03	peak

Note:1.Result (dBuV/m) = Correct Factor (dB/m) + Reading(dBuV).

2.Correction factor (dB/m) = Antenna Factor (dB/m) + Cable loss (dB) – Pre-Amplifier gain (dB).

3.When the peak results are less than average limit, so not need to evaluate the average.



Standard:	FCC Part 15.407	Test Distance:	3m
Test item:	Band edge	Power:	AC 120V/60Hz
Frequency:	5785MHz	Temp.(°C)/Hum.(%RH):	26(°C)/60%RH
Mode:	Mode 2		
Ant.Polar.:	Vertical		

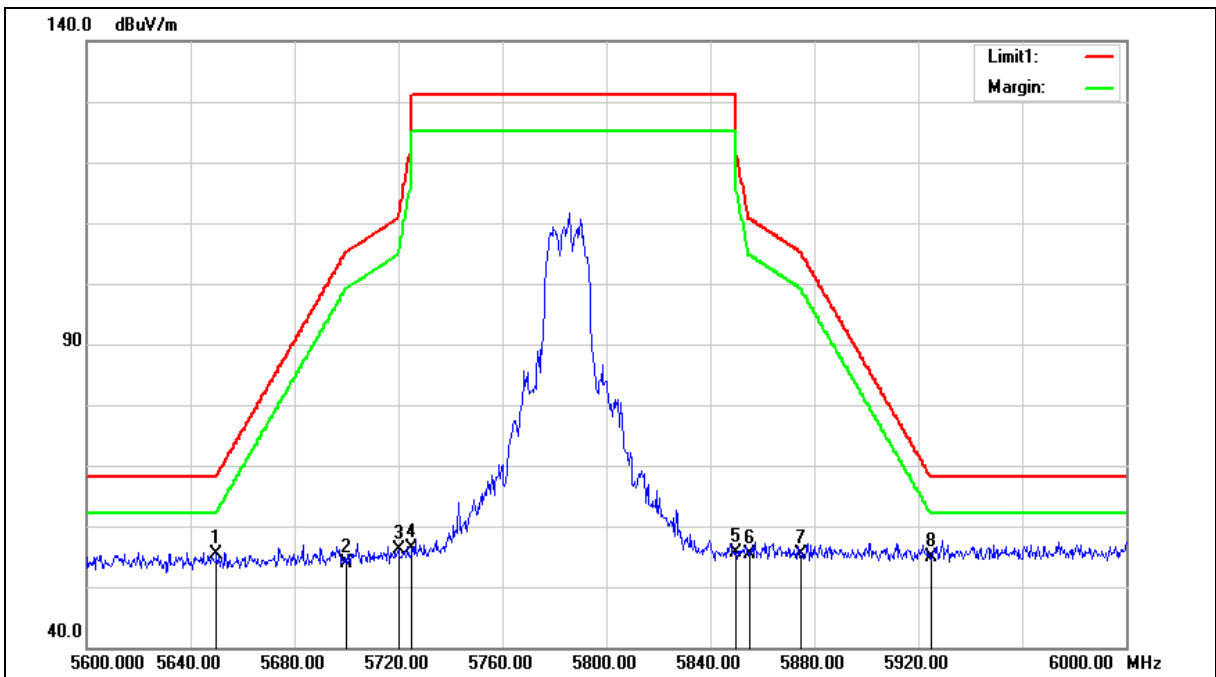



Standard:	FCC Part 15.407	Test Distance:	3m
Test item:	Band edge	Power:	AC 120V/60Hz
Frequency:	5785MHz	Temp.(°C)/Hum.(%RH):	26(°C)/60%RH
Mode:	Mode 2		
Ant.Polar.:	Vertical		

No.	Frequency (MHz)	Reading (dBuV)	Correct Factor (dB/m)	Result (dBuV/m)	Limit (dBuV/m)	Margin (dB)	Remark
1	5650.000	48.75	6.61	55.36	68.20	-12.84	peak
2	5700.000	47.18	6.71	53.89	105.20	-51.31	peak
3	5720.000	49.30	6.77	56.07	110.80	-54.73	peak
4	5725.000	49.71	6.78	56.49	122.20	-65.71	peak
5	5850.000	48.52	7.03	55.55	122.20	-66.65	peak
6	5855.000	48.23	7.04	55.27	110.80	-55.53	peak
7	5875.000	48.39	7.09	55.48	105.20	-49.72	peak
8	5925.000	47.71	7.20	54.91	68.20	-13.29	peak

Note:1.Result (dBuV/m) = Correct Factor (dB/m) + Reading(dBuV).

2.Correction factor (dB/m) = Antenna Factor (dB/m) + Cable loss (dB) – Pre-Amplifier gain (dB).

3.When the peak results are less than average limit, so not need to evaluate the average.



Standard:	FCC Part 15.407	Test Distance:	3m
Test item:	Band edge	Power:	AC 120V/60Hz
Frequency:	5825MHz	Temp.(°C)/Hum.(%RH):	26(°C)/60%RH
Mode:	Mode 2		
Ant.Polar.:	Horizontal		

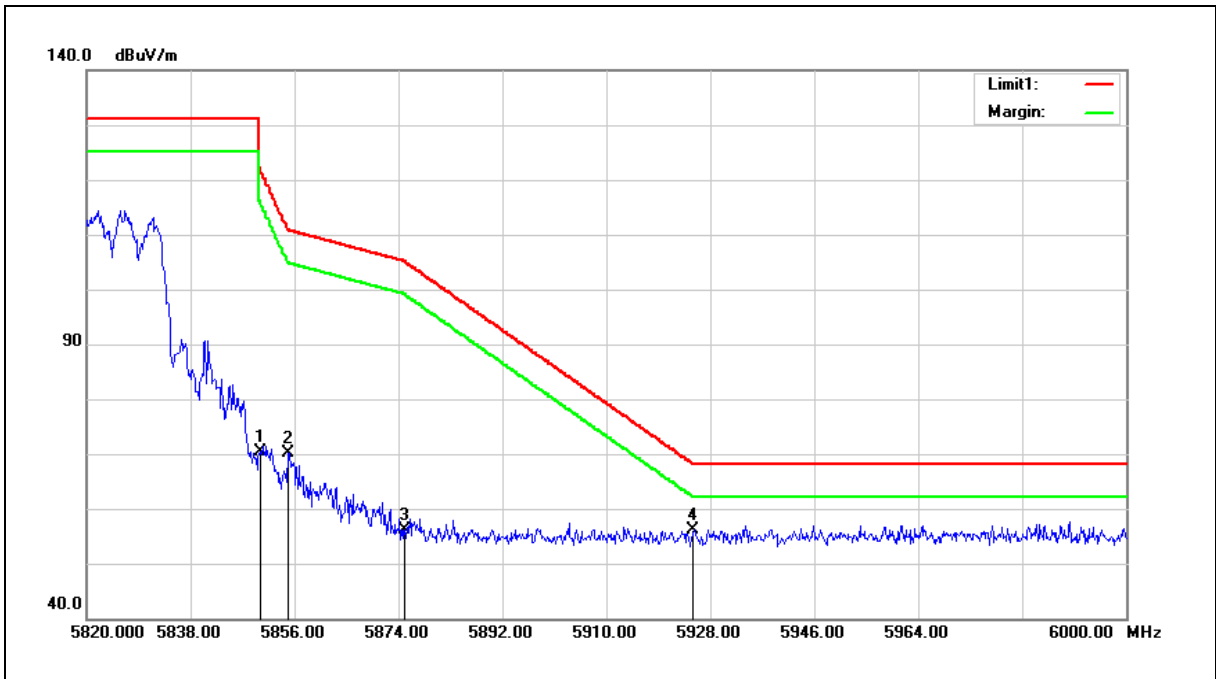

No.	Frequency (MHz)	Reading (dBuV)	Correct Factor (dB/m)	Result (dBuV/m)	Limit (dBuV/m)	Margin (dB)	Remark
1	5850.000	63.25	7.03	70.28	122.20	-51.92	peak
2	5855.000	63.13	7.04	70.17	110.80	-40.63	peak
3	5875.000	49.14	7.09	56.23	105.20	-48.97	peak
4	5925.000	48.94	7.20	56.14	68.20	-12.06	peak

Note:1.Result (dBuV/m) = Correct Factor (dB/m) + Reading(dBuV).

2.Correction factor (dB/m) = Antenna Factor (dB/m) + Cable loss (dB) – Pre-Amplifier gain (dB).

3.When the peak results are less than average limit, so not need to evaluate the average.



Standard:	FCC Part 15.407	Test Distance:	3m
Test item:	Band edge	Power:	AC 120V/60Hz
Frequency:	5825MHz	Temp.(°C)/Hum.(%RH):	26(°C)/60%RH
Mode:	Mode 2		
Ant.Polar.:	Vertical		

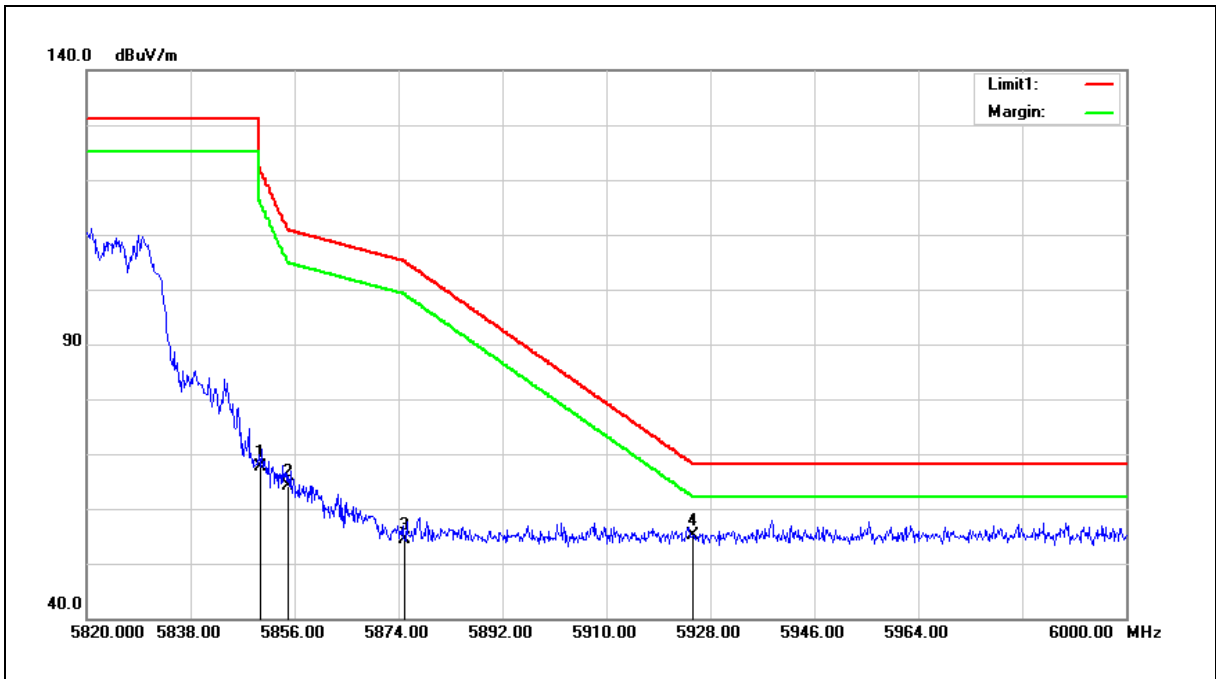

No.	Frequency (MHz)	Reading (dBuV)	Correct Factor (dB/m)	Result (dBuV/m)	Limit (dBuV/m)	Margin (dB)	Remark
1	5850.000	60.50	7.03	67.53	122.20	-54.67	peak
2	5855.000	57.14	7.04	64.18	110.80	-46.62	peak
3	5875.000	47.30	7.09	54.39	105.20	-50.81	peak
4	5925.000	47.84	7.20	55.04	68.20	-13.16	peak

Note:1.Result (dBuV/m) = Correct Factor (dB/m) + Reading(dBuV).

2.Correction factor (dB/m) = Antenna Factor (dB/m) + Cable loss (dB) – Pre-Amplifier gain (dB).

3.When the peak results are less than average limit, so not need to evaluate the average.



Standard:	FCC Part 15.407	Test Distance:	3m
Test item:	Band edge	Power:	AC 120V/60Hz
Frequency:	5180MHz	Temp.(°C)/Hum.(%RH):	26(°C)/60%RH
Mode:	Mode 3		
Ant.Polar.:	Horizontal		

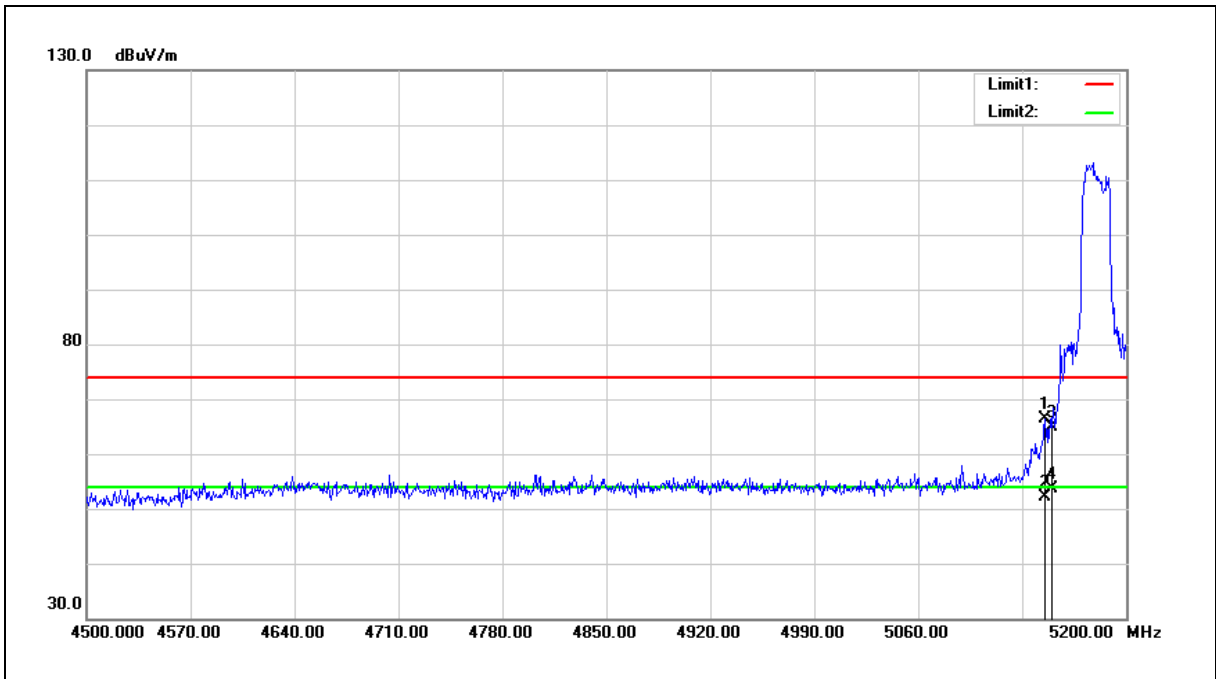

No.	Frequency (MHz)	Reading (dBuV)	Correct Factor (dB/m)	Result (dBuV/m)	Limit (dBuV/m)	Margin (dB)	Remark
1	5145.400	60.51	5.77	66.28	74.00	-7.72	peak
2	5145.400	46.45	5.77	52.22	54.00	-1.78	AVG
3	5150.000	59.11	5.78	64.89	74.00	-9.11	peak
4	5150.000	47.87	5.78	53.65	54.00	-0.35	AVG

Note:1.Result (dBuV/m) = Correct Factor (dB/m) + Reading(dBuV).

2.Correction factor (dB/m) = Antenna Factor (dB/m) + Cable loss (dB) – Pre-Amplifier gain (dB).

3.When the peak results are less than average limit, so not need to evaluate the average.



Standard:	FCC Part 15.407	Test Distance:	3m
Test item:	Band edge	Power:	AC 120V/60Hz
Frequency:	5180MHz	Temp.(°C)/Hum.(%RH):	26(°C)/60%RH
Mode:	Mode 3		
Ant.Polar.:	Vertical		

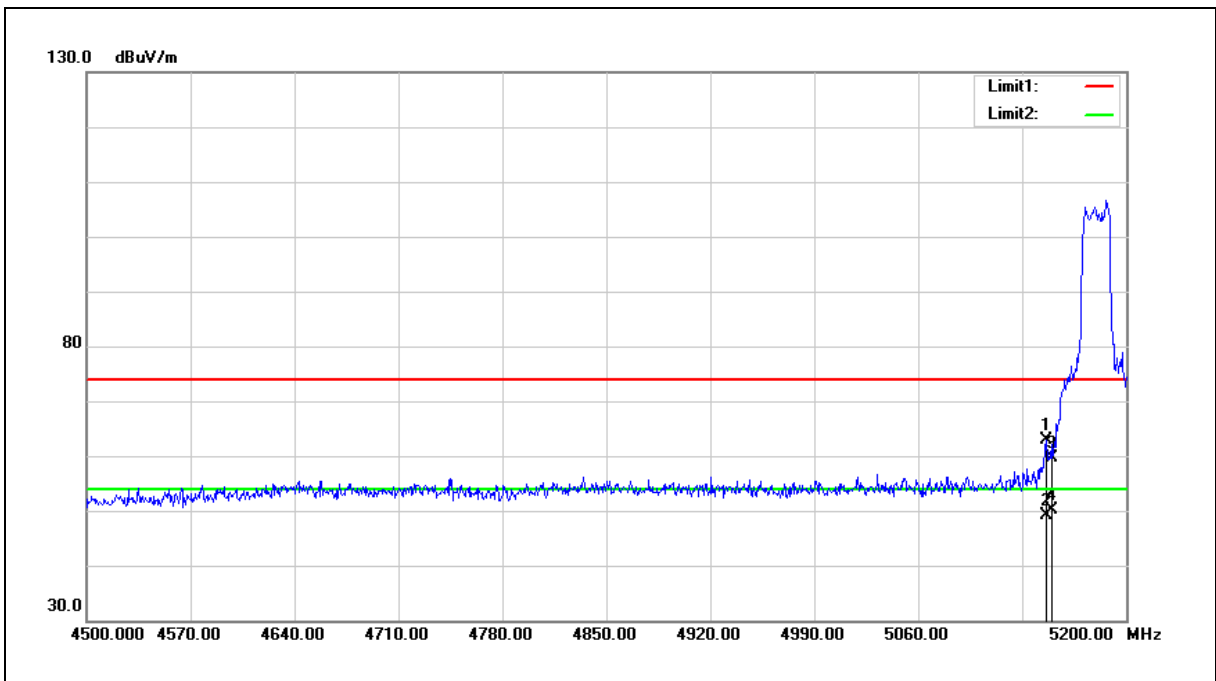

No.	Frequency (MHz)	Reading (dBuV)	Correct Factor (dB/m)	Result (dBuV/m)	Limit (dBuV/m)	Margin (dB)	Remark
1	5146.100	56.99	5.77	62.76	74.00	-11.24	peak
2	5146.100	43.34	5.77	49.11	54.00	-4.89	AVG
3	5150.000	53.93	5.78	59.71	74.00	-14.29	peak
4	5150.000	44.41	5.78	50.19	54.00	-3.81	AVG

Note:1.Result (dBuV/m) = Correct Factor (dB/m) + Reading(dBuV).

2.Correction factor (dB/m) = Antenna Factor (dB/m) + Cable loss (dB) – Pre-Amplifier gain (dB).

3.When the peak results are less than average limit, so not need to evaluate the average.



Standard:	FCC Part 15.407	Test Distance:	3m
Test item:	Band edge	Power:	AC 120V/60Hz
Frequency:	5200MHz	Temp.(°C)/Hum.(%RH):	26(°C)/60%RH
Mode:	Mode 3		
Ant.Polar.:	Horizontal		

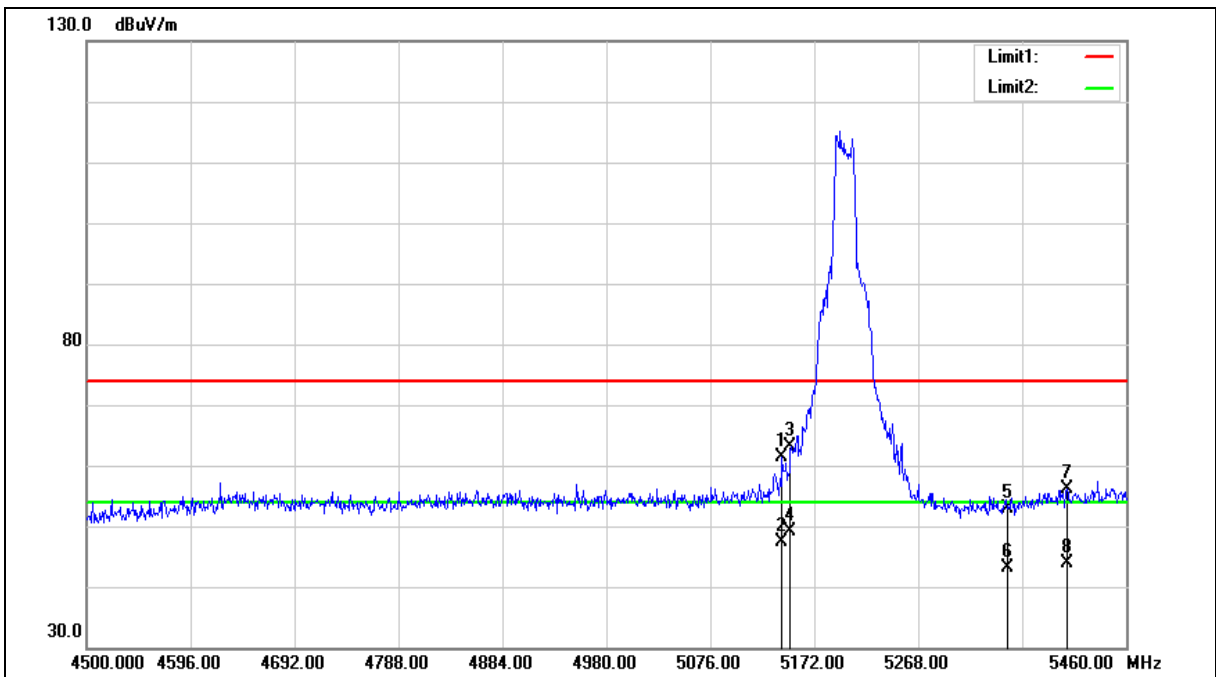



Standard:	FCC Part 15.407	Test Distance:	3m
Test item:	Band edge	Power:	AC 120V/60Hz
Frequency:	5200MHz	Temp.(°C)/Hum.(%RH):	26(°C)/60%RH
Mode:	Mode 3		
Ant.Polar.:	Horizontal		

No.	Frequency (MHz)	Reading (dBuV)	Correct Factor (dB/m)	Result (dBuV/m)	Limit (dBuV/m)	Margin (dB)	Remark
1	5142.240	55.66	5.77	61.43	74.00	-12.57	peak
2	5142.240	41.66	5.77	47.43	54.00	-6.57	AVG
3	5150.000	57.32	5.78	63.10	74.00	-10.90	peak
4	5150.000	43.32	5.78	49.10	54.00	-4.90	AVG
5	5350.000	46.91	6.07	52.98	74.00	-21.02	peak
6	5350.000	37.00	6.07	43.07	54.00	-10.93	AVG
7	5405.280	49.90	6.15	56.05	74.00	-17.95	peak
8	5405.280	37.78	6.15	43.93	54.00	-10.07	AVG

Note:1.Result (dBuV/m) = Correct Factor (dB/m) + Reading(dBuV).

2.Correction factor (dB/m) = Antenna Factor (dB/m) + Cable loss (dB) – Pre-Amplifier gain (dB).

3.When the peak results are less than average limit, so not need to evaluate the average.



Standard:	FCC Part 15.407	Test Distance:	3m
Test item:	Band edge	Power:	AC 120V/60Hz
Frequency:	5200MHz	Temp.(°C)/Hum.(%RH):	26(°C)/60%RH
Mode:	Mode 3		
Ant.Polar.:	Vertical		

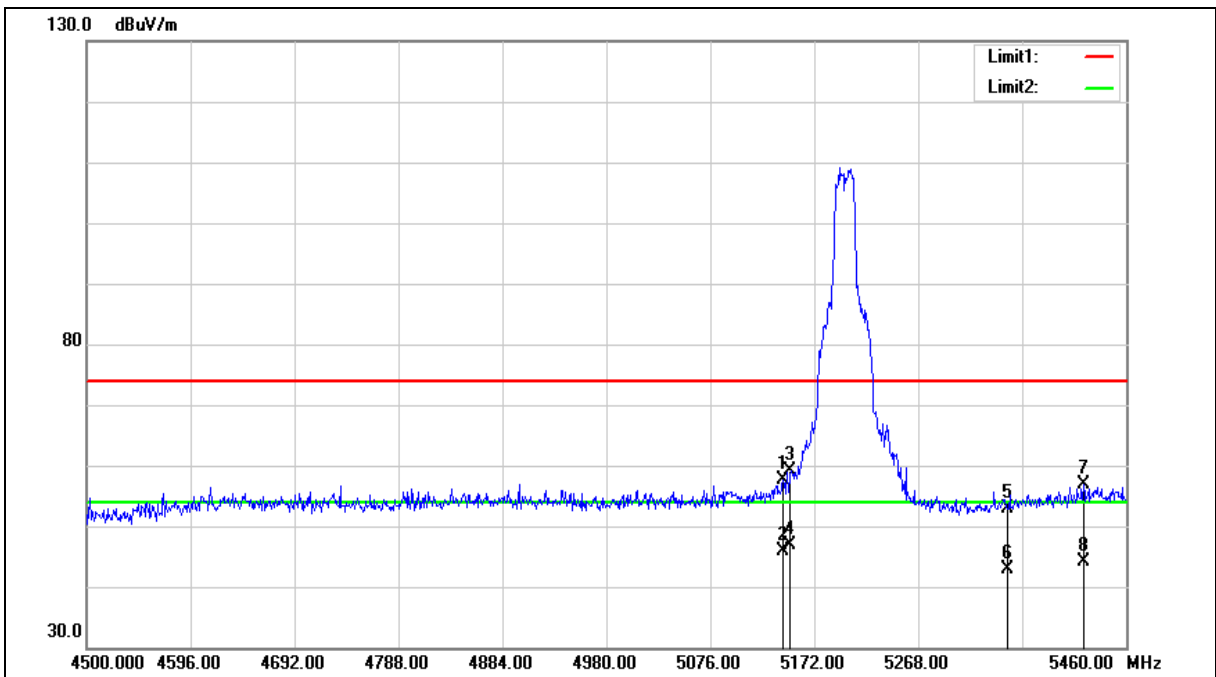



Standard:	FCC Part 15.407	Test Distance:	3m
Test item:	Band edge	Power:	AC 120V/60Hz
Frequency:	5200MHz	Temp.(°C)/Hum.(%RH):	26(°C)/60%RH
Mode:	Mode 3		
Ant.Polar.:	Vertical		

No.	Frequency (MHz)	Reading (dBuV)	Correct Factor (dB/m)	Result (dBuV/m)	Limit (dBuV/m)	Margin (dB)	Remark
1	5143.200	51.74	5.77	57.51	74.00	-16.49	peak
2	5143.200	40.00	5.77	45.77	54.00	-8.23	AVG
3	5150.000	53.31	5.78	59.09	74.00	-14.91	peak
4	5150.000	41.14	5.78	46.92	54.00	-7.08	AVG
5	5350.000	46.83	6.07	52.90	74.00	-21.10	peak
6	5350.000	36.91	6.07	42.98	54.00	-11.02	AVG
7	5420.640	50.60	6.17	56.77	74.00	-17.23	peak
8	5420.640	38.03	6.17	44.20	54.00	-9.80	AVG

Note:1.Result (dBuV/m) = Correct Factor (dB/m) + Reading(dBuV).

2.Correction factor (dB/m) = Antenna Factor (dB/m) + Cable loss (dB) – Pre-Amplifier gain (dB).

3.When the peak results are less than average limit, so not need to evaluate the average.



Standard:	FCC Part 15.407	Test Distance:	3m
Test item:	Band edge	Power:	AC 120V/60Hz
Frequency:	5240MHz	Temp.(°C)/Hum.(%RH):	26(°C)/60%RH
Mode:	Mode 3		
Ant.Polar.:	Horizontal		

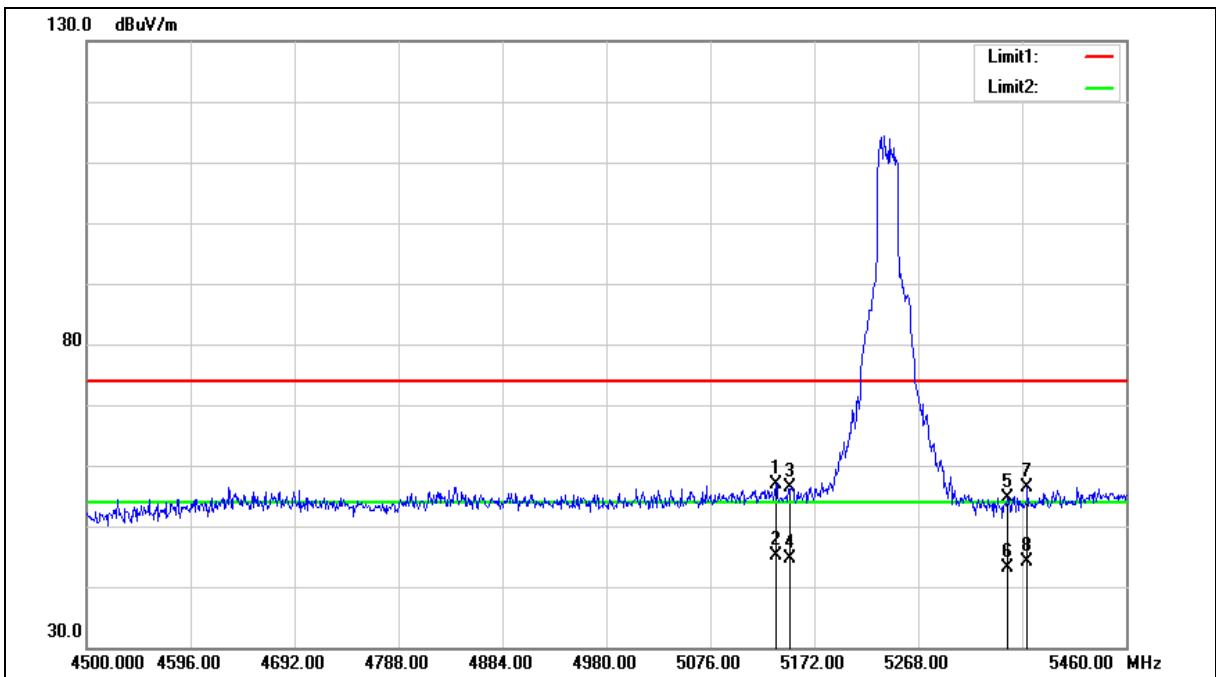



Standard:	FCC Part 15.407	Test Distance:	3m
Test item:	Band edge	Power:	AC 120V/60Hz
Frequency:	5240MHz	Temp.(°C)/Hum.(%RH):	26(°C)/60%RH
Mode:	Mode 3		
Ant.Polar.:	Horizontal		

No.	Frequency (MHz)	Reading (dBuV)	Correct Factor (dB/m)	Result (dBuV/m)	Limit (dBuV/m)	Margin (dB)	Remark
1	5136.480	51.21	5.75	56.96	74.00	-17.04	peak
2	5136.480	39.26	5.75	45.01	54.00	-8.99	AVG
3	5150.000	50.69	5.78	56.47	74.00	-17.53	peak
4	5150.000	38.92	5.78	44.70	54.00	-9.30	AVG
5	5350.000	48.54	6.07	54.61	74.00	-19.39	peak
6	5350.000	37.17	6.07	43.24	54.00	-10.76	AVG
7	5368.800	50.34	6.10	56.44	74.00	-17.56	peak
8	5368.800	38.02	6.10	44.12	54.00	-9.88	AVG

Note:1.Result (dBuV/m) = Correct Factor (dB/m) + Reading(dBuV).

2.Correction factor (dB/m) = Antenna Factor (dB/m) + Cable loss (dB) – Pre-Amplifier gain (dB).

3.When the peak results are less than average limit, so not need to evaluate the average.



Standard:	FCC Part 15.407	Test Distance:	3m
Test item:	Band edge	Power:	AC 120V/60Hz
Frequency:	5240MHz	Temp.(°C)/Hum.(%RH):	26(°C)/60%RH
Mode:	Mode 3		
Ant.Polar.:	Vertical		

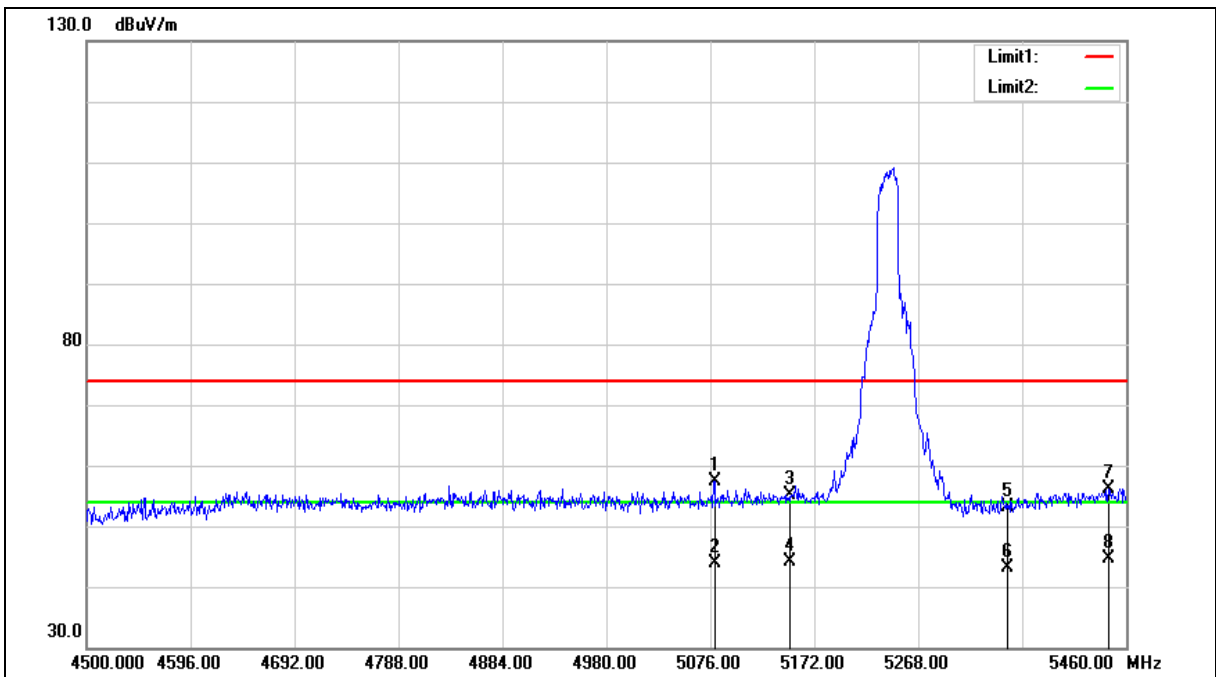



Standard:	FCC Part 15.407	Test Distance:	3m
Test item:	Band edge	Power:	AC 120V/60Hz
Frequency:	5240MHz	Temp.(°C)/Hum.(%RH):	26(°C)/60%RH
Mode:	Mode 3		
Ant.Polar.:	Vertical		

No.	Frequency (MHz)	Reading (dBuV)	Correct Factor (dB/m)	Result (dBuV/m)	Limit (dBuV/m)	Margin (dB)	Remark
1	5079.840	51.72	5.67	57.39	74.00	-16.61	peak
2	5079.840	38.32	5.67	43.99	54.00	-10.01	AVG
3	5150.000	49.27	5.78	55.05	74.00	-18.95	peak
4	5150.000	38.45	5.78	44.23	54.00	-9.77	AVG
5	5350.000	46.97	6.07	53.04	74.00	-20.96	peak
6	5350.000	36.95	6.07	43.02	54.00	-10.98	AVG
7	5443.680	50.03	6.21	56.24	74.00	-17.76	peak
8	5443.680	38.44	6.21	44.65	54.00	-9.35	AVG

Note:1.Result (dBuV/m) = Correct Factor (dB/m) + Reading(dBuV).

2.Correction factor (dB/m) = Antenna Factor (dB/m) + Cable loss (dB) – Pre-Amplifier gain (dB).

3.When the peak results are less than average limit, so not need to evaluate the average.



Standard:	FCC Part 15.407	Test Distance:	3m
Test item:	Band edge	Power:	AC 120V/60Hz
Frequency:	5745MHz	Temp.(°C)/Hum.(%RH):	26(°C)/60%RH
Mode:	Mode 3		
Ant.Polar.:	Horizontal		

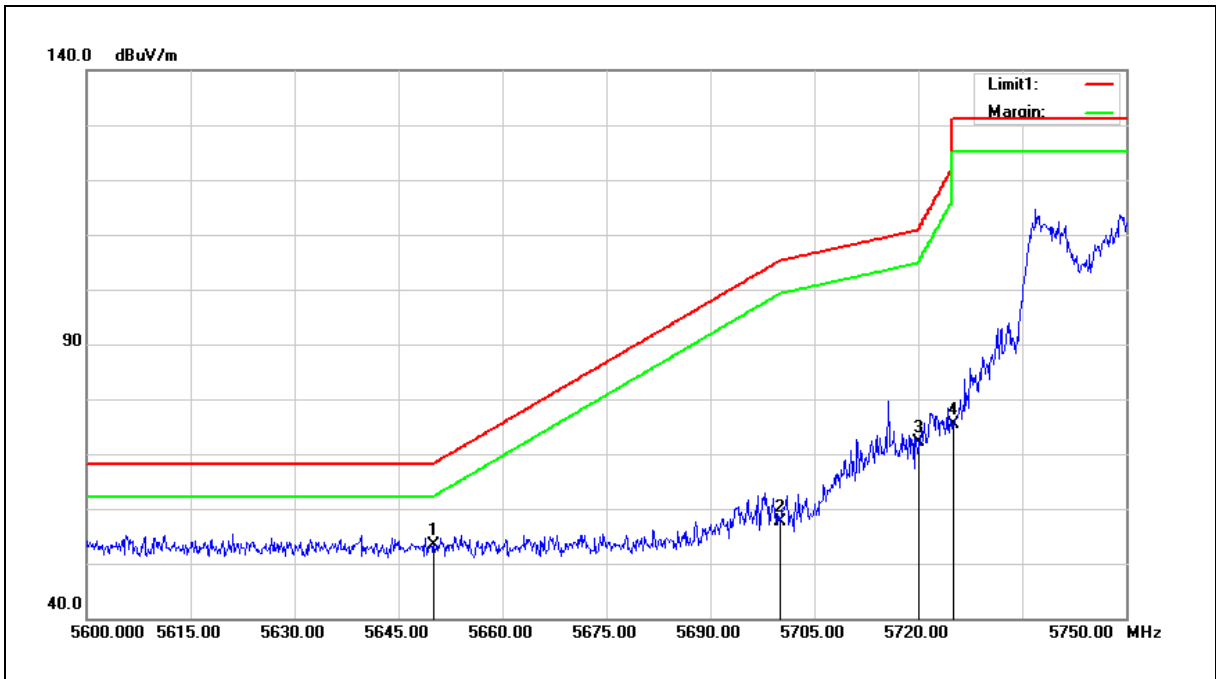

No.	Frequency (MHz)	Reading (dBuV)	Correct Factor (dB/m)	Result (dBuV/m)	Limit (dBuV/m)	Margin (dB)	Remark
1	5650.000	46.66	6.61	53.27	68.20	-14.93	peak
2	5700.000	50.92	6.71	57.63	105.20	-47.57	peak
3	5720.000	65.45	6.77	72.22	110.80	-38.58	peak
4	5725.000	68.67	6.78	75.45	122.20	-46.75	peak

Note:1.Result (dBuV/m) = Correct Factor (dB/m) + Reading(dBuV).

2.Correction factor (dB/m) = Antenna Factor (dB/m) + Cable loss (dB) – Pre-Amplifier gain (dB).

3.When the peak results are less than average limit, so not need to evaluate the average.



Standard:	FCC Part 15.407	Test Distance:	3m
Test item:	Band edge	Power:	AC 120V/60Hz
Frequency:	5745MHz	Temp.(°C)/Hum.(%RH):	26(°C)/60%RH
Mode:	Mode 3		
Ant.Polar.:	Vertical		

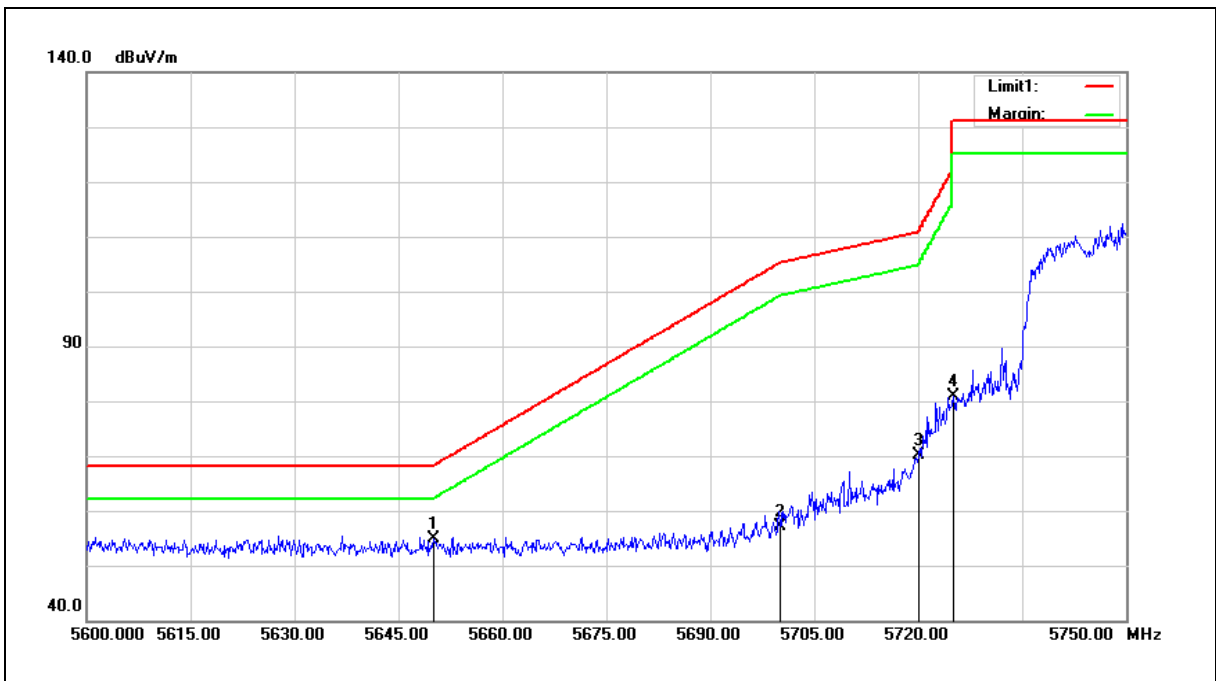

No.	Frequency (MHz)	Reading (dBuV)	Correct Factor (dB/m)	Result (dBuV/m)	Limit (dBuV/m)	Margin (dB)	Remark
1	5650.000	48.25	6.61	54.86	68.20	-13.34	peak
2	5700.000	50.38	6.71	57.09	105.20	-48.11	peak
3	5720.000	63.27	6.77	70.04	110.80	-40.76	peak
4	5725.000	74.11	6.78	80.89	122.20	-41.31	peak

Note:1.Result (dBuV/m) = Correct Factor (dB/m) + Reading(dBuV).

2.Correction factor (dB/m) = Antenna Factor (dB/m) + Cable loss (dB) – Pre-Amplifier gain (dB).

3.When the peak results are less than average limit, so not need to evaluate the average.



Standard:	FCC Part 15.407	Test Distance:	3m
Test item:	Band edge	Power:	AC 120V/60Hz
Frequency:	5785MHz	Temp.(°C)/Hum.(%RH):	26(°C)/60%RH
Mode:	Mode 3		
Ant.Polar.:	Horizontal		

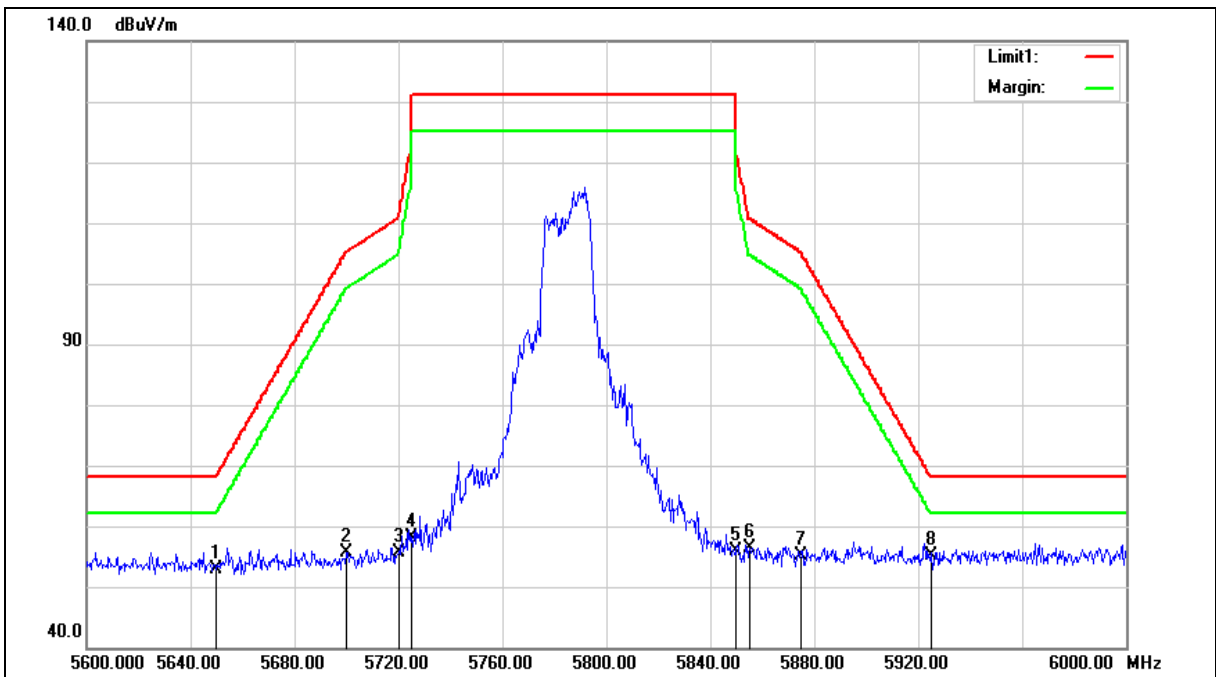



Standard:	FCC Part 15.407	Test Distance:	3m
Test item:	Band edge	Power:	AC 120V/60Hz
Frequency:	5785MHz	Temp.(°C)/Hum.(%RH):	26(°C)/60%RH
Mode:	Mode 3		
Ant.Polar.:	Horizontal		

No.	Frequency (MHz)	Reading (dBuV)	Correct Factor (dB/m)	Result (dBuV/m)	Limit (dBuV/m)	Margin (dB)	Remark
1	5650.000	46.25	6.61	52.86	68.20	-15.34	peak
2	5700.000	48.94	6.71	55.65	105.20	-49.55	peak
3	5720.000	48.79	6.77	55.56	110.80	-55.24	peak
4	5725.000	51.42	6.78	58.20	122.20	-64.00	peak
5	5850.000	48.94	7.03	55.97	122.20	-66.23	peak
6	5855.000	49.23	7.04	56.27	110.80	-54.53	peak
7	5875.000	47.95	7.09	55.04	105.20	-50.16	peak
8	5925.000	47.87	7.20	55.07	68.20	-13.13	peak

Note:1.Result (dBuV/m) = Correct Factor (dB/m) + Reading(dBuV).

2.Correction factor (dB/m) = Antenna Factor (dB/m) + Cable loss (dB) – Pre-Amplifier gain (dB).

3.When the peak results are less than average limit, so not need to evaluate the average.



Standard:	FCC Part 15.407	Test Distance:	3m
Test item:	Band edge	Power:	AC 120V/60Hz
Frequency:	5785MHz	Temp.(°C)/Hum. (%RH):	26(°C)/60%RH
Mode:	Mode 3		
Ant.Polar.:	Vertical		

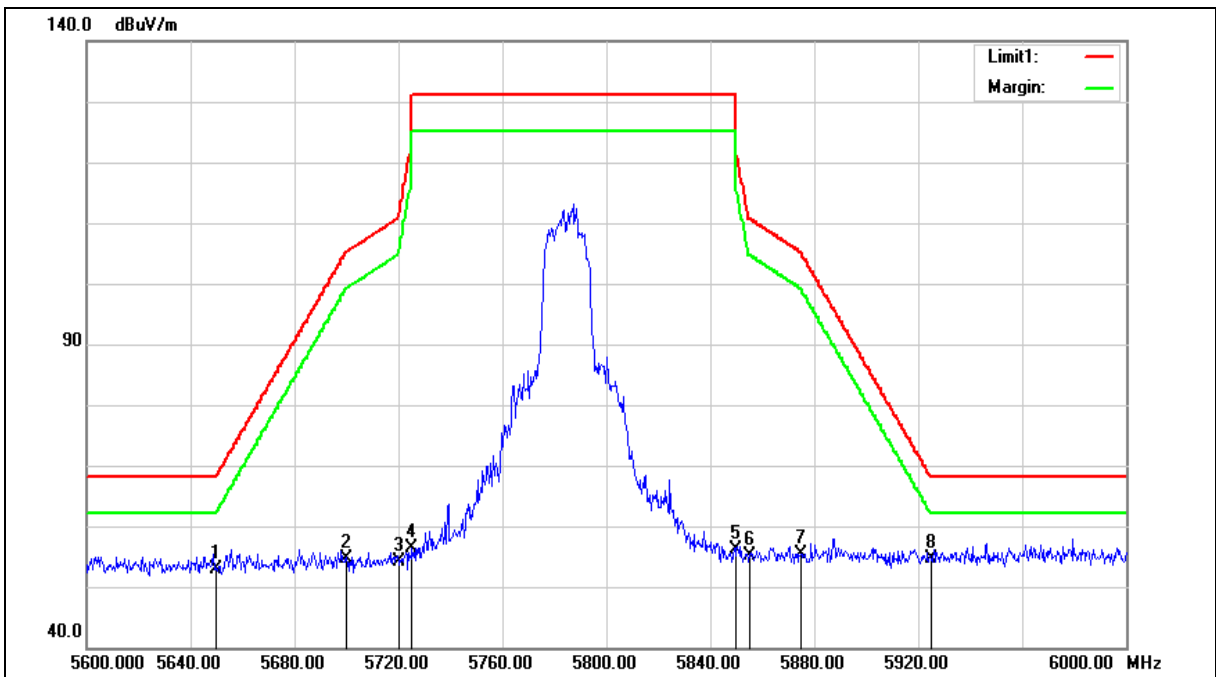



Standard:	FCC Part 15.407	Test Distance:	3m
Test item:	Band edge	Power:	AC 120V/60Hz
Frequency:	5785MHz	Temp.(°C)/Hum.(%RH):	26(°C)/60%RH
Mode:	Mode 3		
Ant.Polar.:	Vertical		

No.	Frequency (MHz)	Reading (dBuV)	Correct Factor (dB/m)	Result (dBuV/m)	Limit (dBuV/m)	Margin (dB)	Remark
1	5650.000	46.25	6.61	52.86	68.20	-15.34	peak
2	5700.000	48.04	6.71	54.75	105.20	-50.45	peak
3	5720.000	47.33	6.77	54.10	110.80	-56.70	peak
4	5725.000	49.52	6.78	56.30	122.20	-65.90	peak
5	5850.000	49.03	7.03	56.06	122.20	-66.14	peak
6	5855.000	47.97	7.04	55.01	110.80	-55.79	peak
7	5875.000	48.35	7.09	55.44	105.20	-49.76	peak
8	5925.000	47.47	7.20	54.67	68.20	-13.53	peak

Note:1.Result (dBuV/m) = Correct Factor (dB/m) + Reading(dBuV).

2.Correction factor (dB/m) = Antenna Factor (dB/m) + Cable loss (dB) – Pre-Amplifier gain (dB).

3.When the peak results are less than average limit, so not need to evaluate the average.



Standard:	FCC Part 15.407	Test Distance:	3m
Test item:	Band edge	Power:	AC 120V/60Hz
Frequency:	5825MHz	Temp.(°C)/Hum.(%RH):	26(°C)/60%RH
Mode:	Mode 3		
Ant.Polar.:	Horizontal		

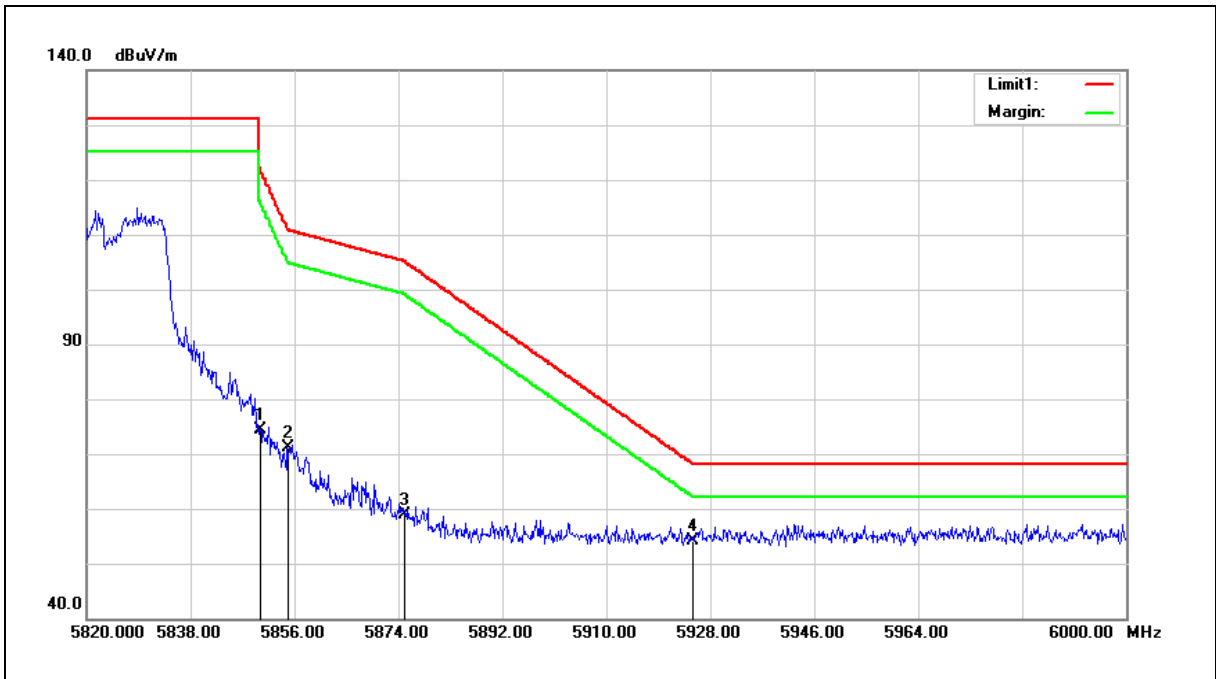

No.	Frequency (MHz)	Reading (dBuV)	Correct Factor (dB/m)	Result (dBuV/m)	Limit (dBuV/m)	Margin (dB)	Remark
1	5850.000	67.32	7.03	74.35	122.20	-47.85	peak
2	5855.000	64.01	7.04	71.05	110.80	-39.75	peak
3	5875.000	51.67	7.09	58.76	105.20	-46.44	peak
4	5925.000	46.82	7.20	54.02	68.20	-14.18	peak

Note:1.Result (dBuV/m) = Correct Factor (dB/m) + Reading(dBuV).

2.Correction factor (dB/m) = Antenna Factor (dB/m) + Cable loss (dB) – Pre-Amplifier gain (dB).

3.When the peak results are less than average limit, so not need to evaluate the average.



Standard:	FCC Part 15.407	Test Distance:	3m
Test item:	Band edge	Power:	AC 120V/60Hz
Frequency:	5825MHz	Temp.(°C)/Hum.(%RH):	26(°C)/60%RH
Mode:	Mode 3		
Ant.Polar.:	Vertical		

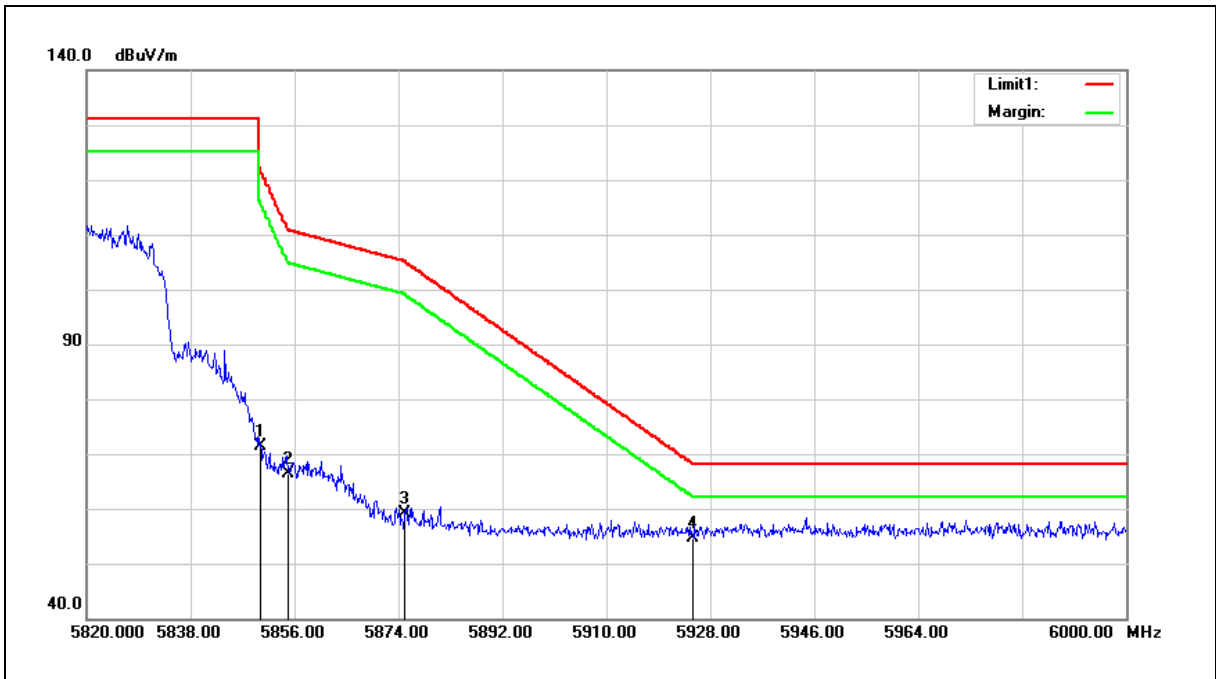

No.	Frequency (MHz)	Reading (dBuV)	Correct Factor (dB/m)	Result (dBuV/m)	Limit (dBuV/m)	Margin (dB)	Remark
1	5850.000	64.37	7.03	71.40	122.20	-50.80	peak
2	5855.000	59.36	7.04	66.40	110.80	-44.40	peak
3	5875.000	51.96	7.09	59.05	105.20	-46.15	peak
4	5925.000	47.49	7.20	54.69	68.20	-13.51	peak

Note:1.Result (dBuV/m) = Correct Factor (dB/m) + Reading(dBuV).

2.Correction factor (dB/m) = Antenna Factor (dB/m) + Cable loss (dB) – Pre-Amplifier gain (dB).

3.When the peak results are less than average limit, so not need to evaluate the average.



Standard:	FCC Part 15.407	Test Distance:	3m
Test item:	Band edge	Power:	AC 120V/60Hz
Frequency:	5190MHz	Temp.(°C)/Hum.(%RH):	26(°C)/60%RH
Mode:	Mode 4		
Ant.Polar.:	Horizontal		

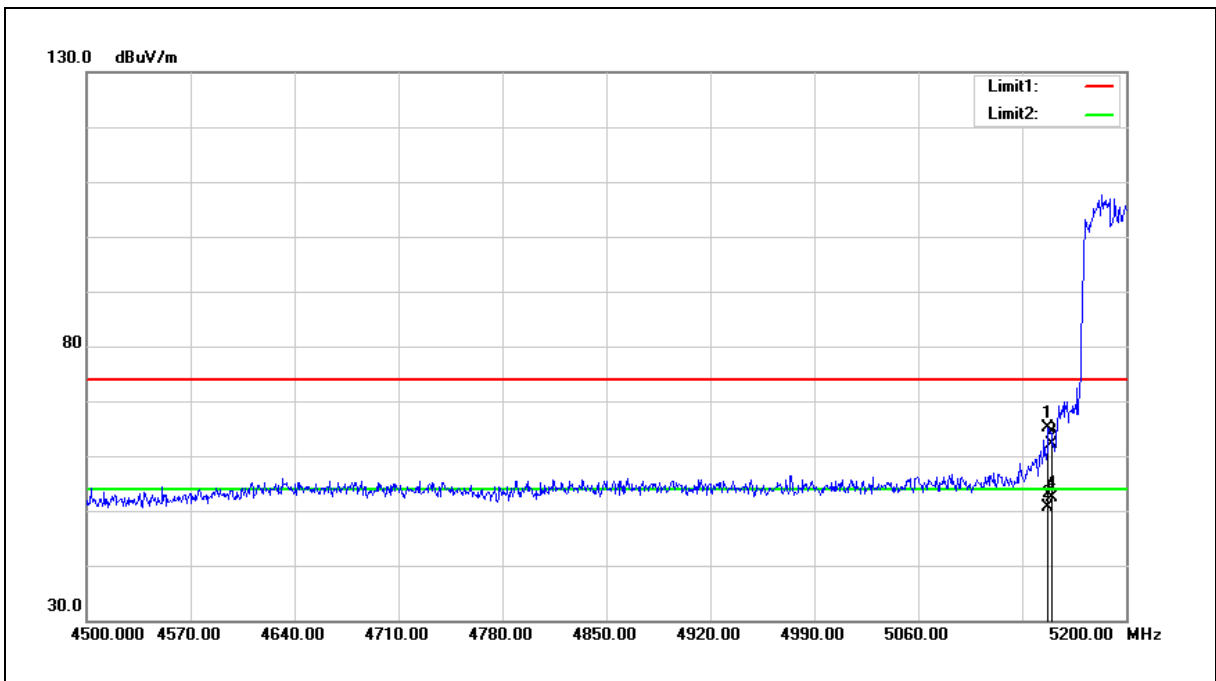

No.	Frequency (MHz)	Reading (dBuV)	Correct Factor (dB/m)	Result (dBuV/m)	Limit (dBuV/m)	Margin (dB)	Remark
1	5147.500	59.38	5.77	65.15	74.00	-8.85	peak
2	5147.500	44.89	5.77	50.66	54.00	-3.34	AVG
3	5150.000	56.41	5.78	62.19	74.00	-11.81	peak
4	5150.000	46.60	5.78	52.38	54.00	-1.62	AVG

Note:1.Result (dBuV/m) = Correct Factor (dB/m) + Reading(dBuV).

2.Correction factor (dB/m) = Antenna Factor (dB/m) + Cable loss (dB) – Pre-Amplifier gain (dB).

3.When the peak results are less than average limit, so not need to evaluate the average.



Standard:	FCC Part 15.407	Test Distance:	3m
Test item:	Band edge	Power:	AC 120V/60Hz
Frequency:	5190MHz	Temp.(°C)/Hum.(%RH):	26(°C)/60%RH
Mode:	Mode 4		
Ant.Polar.:	Vertical		

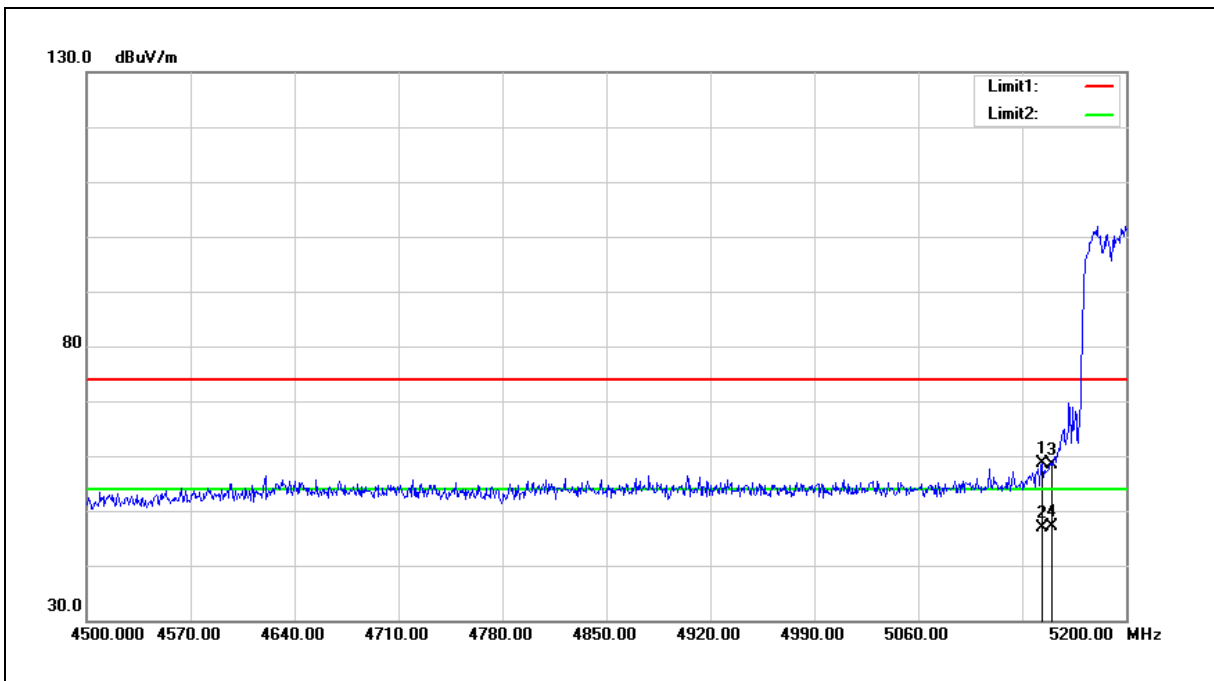

No.	Frequency (MHz)	Reading (dBuV)	Correct Factor (dB/m)	Result (dBuV/m)	Limit (dBuV/m)	Margin (dB)	Remark
1	5143.300	52.90	5.77	58.67	74.00	-15.33	peak
2	5143.300	41.07	5.77	46.84	54.00	-7.16	AVG
3	5150.000	52.68	5.78	58.46	74.00	-15.54	peak
4	5150.000	41.45	5.78	47.23	54.00	-6.77	AVG

Note:1.Result (dBuV/m) = Correct Factor (dB/m) + Reading(dBuV).

2.Correction factor (dB/m) = Antenna Factor (dB/m) + Cable loss (dB) – Pre-Amplifier gain (dB).

3.When the peak results are less than average limit, so not need to evaluate the average.



Standard:	FCC Part 15.407	Test Distance:	3m
Test item:	Band edge	Power:	AC 120V/60Hz
Frequency:	5230MHz	Temp.(°C)/Hum.(%RH):	26(°C)/60%RH
Mode:	Mode 4		
Ant.Polar.:	Horizontal		

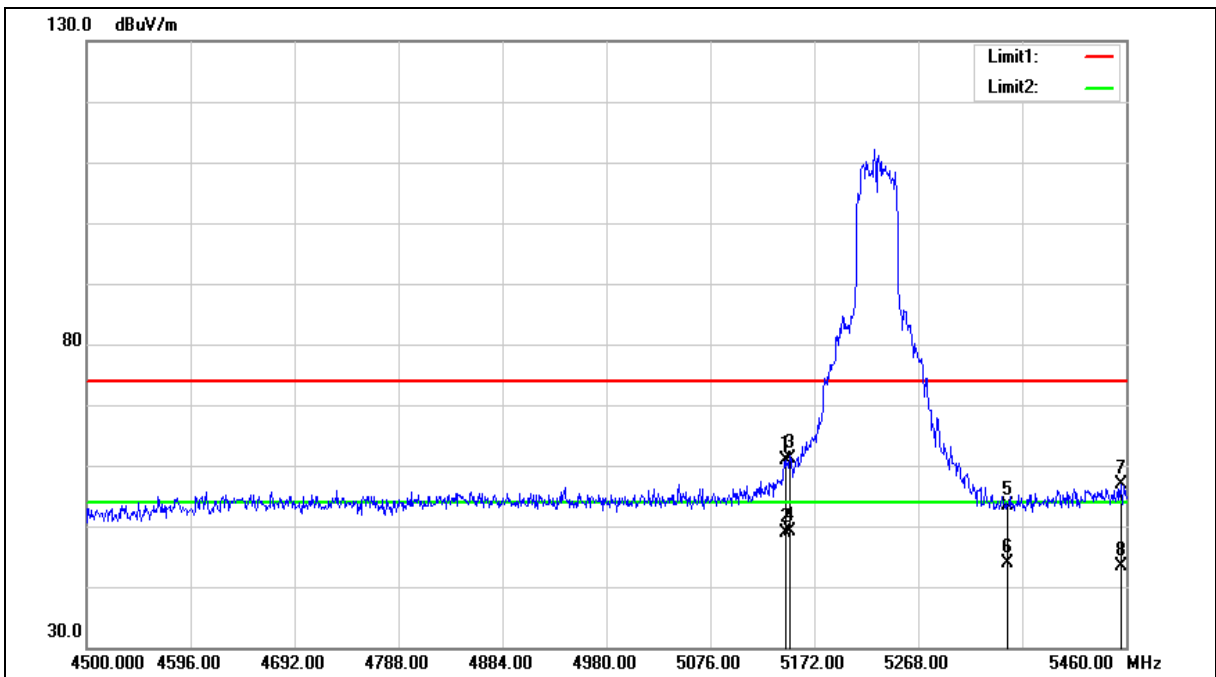



Standard:	FCC Part 15.407	Test Distance:	3m
Test item:	Band edge	Power:	AC 120V/60Hz
Frequency:	5230MHz	Temp.(°C)/Hum.(%RH):	26(°C)/60%RH
Mode:	Mode 4		
Ant.Polar.:	Horizontal		

No.	Frequency (MHz)	Reading (dBuV)	Correct Factor (dB/m)	Result (dBuV/m)	Limit (dBuV/m)	Margin (dB)	Remark
1	5145.120	55.18	5.77	60.95	74.00	-13.05	peak
2	5145.120	43.03	5.77	48.80	54.00	-5.20	AVG
3	5150.000	55.44	5.78	61.22	74.00	-12.78	peak
4	5150.000	43.46	5.78	49.24	54.00	-4.76	AVG
5	5350.000	47.33	6.07	53.40	74.00	-20.60	peak
6	5350.000	37.89	6.07	43.96	54.00	-10.04	AVG
7	5455.200	50.69	6.22	56.91	74.00	-17.09	peak
8	5455.200	37.19	6.22	43.41	54.00	-10.59	AVG

Note:1.Result (dBuV/m) = Correct Factor (dB/m) + Reading(dBuV).

2.Correction factor (dB/m) = Antenna Factor (dB/m) + Cable loss (dB) – Pre-Amplifier gain (dB).

3.When the peak results are less than average limit, so not need to evaluate the average.



Standard:	FCC Part 15.407	Test Distance:	3m
Test item:	Band edge	Power:	AC 120V/60Hz
Frequency:	5230MHz	Temp.(°C)/Hum.(%RH):	26(°C)/60%RH
Mode:	Mode 4		
Ant.Polar.:	Vertical		

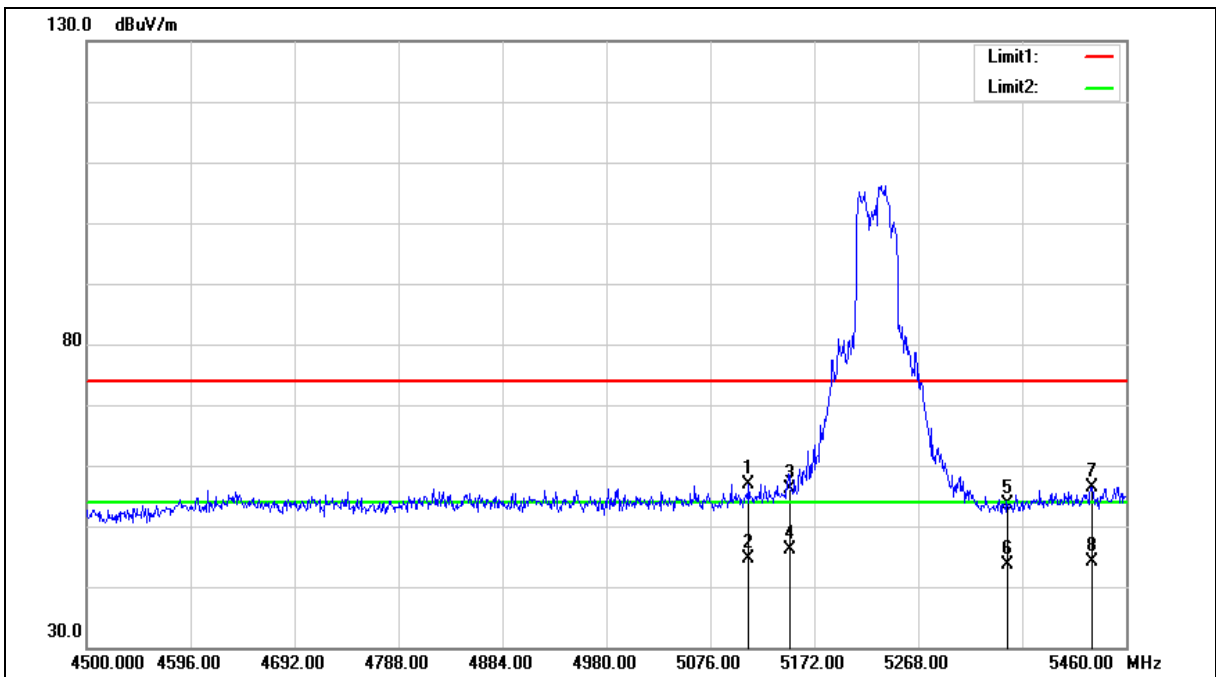



Standard:	FCC Part 15.407	Test Distance:	3m
Test item:	Band edge	Power:	AC 120V/60Hz
Frequency:	5230MHz	Temp.(°C)/Hum.(%RH):	26(°C)/60%RH
Mode:	Mode 4		
Ant.Polar.:	Vertical		

No.	Frequency (MHz)	Reading (dBuV)	Correct Factor (dB/m)	Result (dBuV/m)	Limit (dBuV/m)	Margin (dB)	Remark
1	5111.520	51.26	5.72	56.98	74.00	-17.02	peak
2	5111.520	38.96	5.72	44.68	54.00	-9.32	AVG
3	5150.000	50.34	5.78	56.12	74.00	-17.88	peak
4	5150.000	40.28	5.78	46.06	54.00	-7.94	AVG
5	5350.000	47.50	6.07	53.57	74.00	-20.43	peak
6	5350.000	37.52	6.07	43.59	54.00	-10.41	AVG
7	5428.320	50.26	6.19	56.45	74.00	-17.55	peak
8	5428.320	37.89	6.19	44.08	54.00	-9.92	AVG

Note:1.Result (dBuV/m) = Correct Factor (dB/m) + Reading(dBuV).

2.Correction factor (dB/m) = Antenna Factor (dB/m) + Cable loss (dB) – Pre-Amplifier gain (dB).

3.When the peak results are less than average limit, so not need to evaluate the average.



Standard:	FCC Part 15.407	Test Distance:	3m
Test item:	Band edge	Power:	AC 120V/60Hz
Frequency:	5755MHz	Temp.(°C)/Hum.(%RH):	26(°C)/60%RH
Mode:	Mode 4		
Ant.Polar.:	Horizontal		

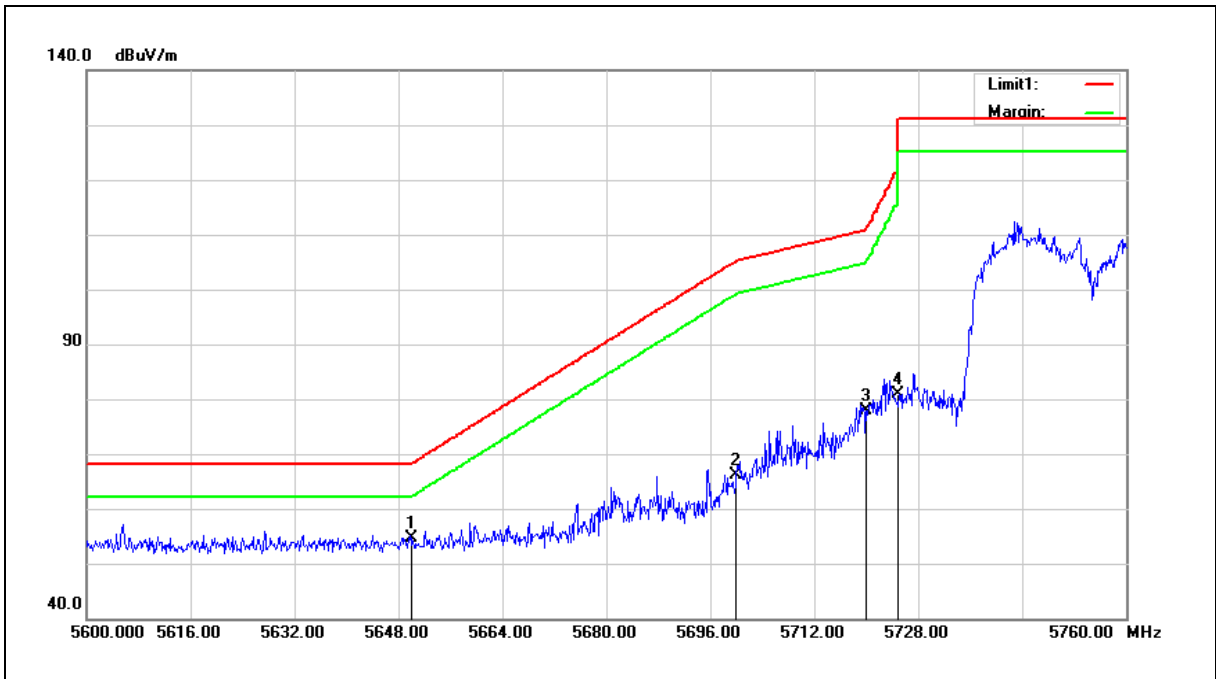

No.	Frequency (MHz)	Reading (dBuV)	Correct Factor (dB/m)	Result (dBuV/m)	Limit (dBuV/m)	Margin (dB)	Remark
1	5650.000	48.13	6.61	54.74	68.20	-13.46	peak
2	5700.000	59.46	6.71	66.17	105.20	-39.03	peak
3	5720.000	71.22	6.77	77.99	110.80	-32.81	peak
4	5725.000	74.01	6.78	80.79	122.20	-41.41	peak

Note:1.Result (dBuV/m) = Correct Factor (dB/m) + Reading(dBuV).

2.Correction factor (dB/m) = Antenna Factor (dB/m) + Cable loss (dB) – Pre-Amplifier gain (dB).

3.When the peak results are less than average limit, so not need to evaluate the average.



Standard:	FCC Part 15.407	Test Distance:	3m
Test item:	Band edge	Power:	AC 120V/60Hz
Frequency:	5755MHz	Temp.(°C)/Hum.(%RH):	26(°C)/60%RH
Mode:	Mode 4		
Ant.Polar.:	Vertical		

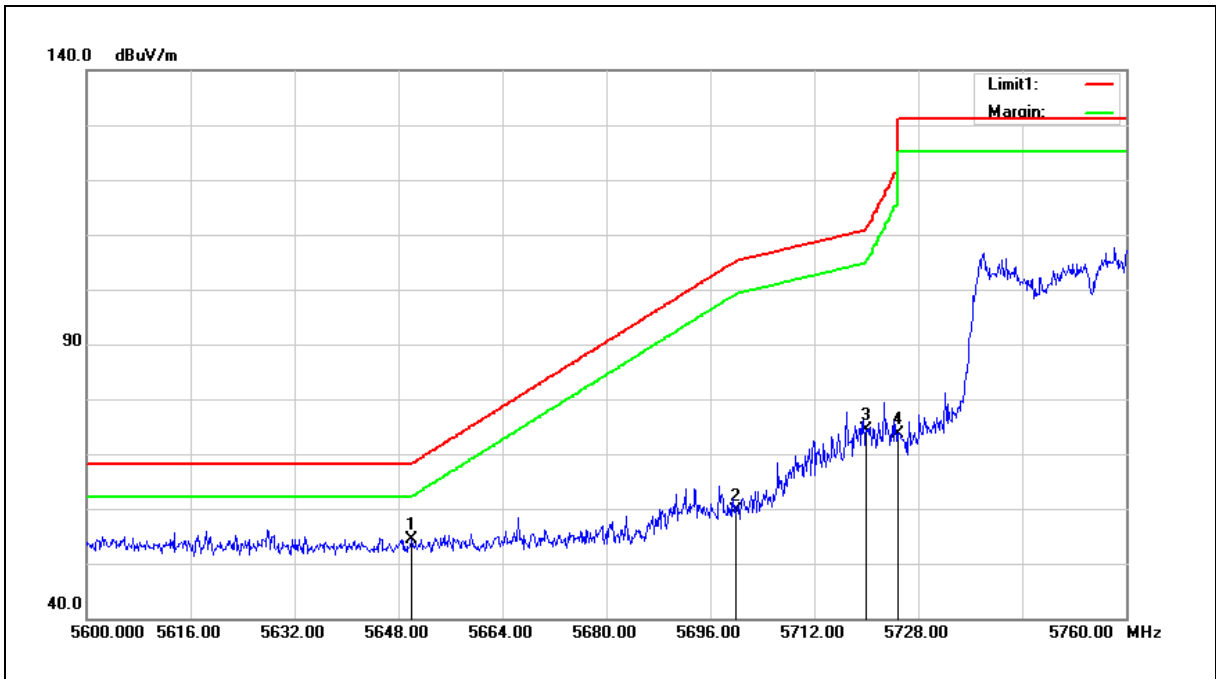

No.	Frequency (MHz)	Reading (dBuV)	Correct Factor (dB/m)	Result (dBuV/m)	Limit (dBuV/m)	Margin (dB)	Remark
1	5650.000	47.67	6.61	54.28	68.20	-13.92	peak
2	5700.000	52.87	6.71	59.58	105.20	-45.62	peak
3	5720.000	67.60	6.77	74.37	110.80	-36.43	peak
4	5725.000	66.97	6.78	73.75	122.20	-48.45	peak

Note:1.Result (dBuV/m) = Correct Factor (dB/m) + Reading(dBuV).

2.Correction factor (dB/m) = Antenna Factor (dB/m) + Cable loss (dB) – Pre-Amplifier gain (dB).

3.When the peak results are less than average limit, so not need to evaluate the average.



Standard:	FCC Part 15.407	Test Distance:	3m
Test item:	Band edge	Power:	AC 120V/60Hz
Frequency:	5795MHz	Temp.(°C)/Hum.(%RH):	26(°C)/60%RH
Mode:	Mode 4		
Ant.Polar.:	Horizontal		

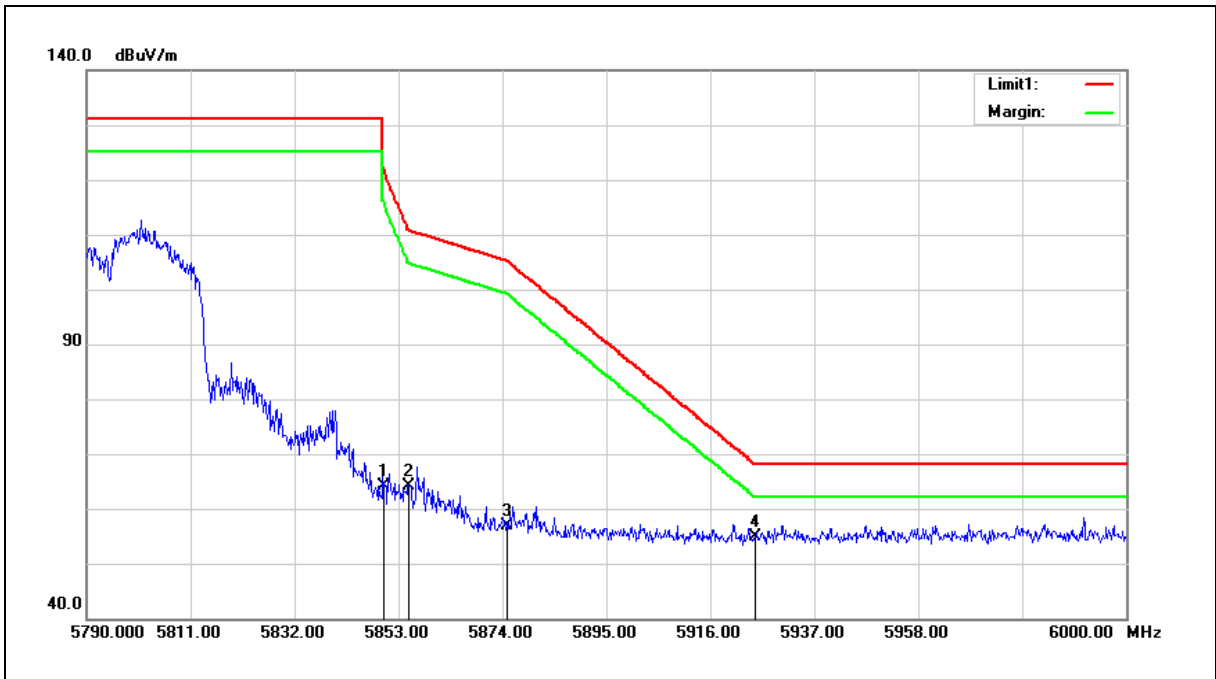

No.	Frequency (MHz)	Reading (dBuV)	Correct Factor (dB/m)	Result (dBuV/m)	Limit (dBuV/m)	Margin (dB)	Remark
1	5850.000	57.11	7.03	64.14	122.20	-58.06	peak
2	5855.000	56.98	7.04	64.02	110.80	-46.78	peak
3	5875.000	49.68	7.09	56.77	105.20	-48.43	peak
4	5925.000	47.71	7.20	54.91	68.20	-13.29	peak

Note:1.Result (dBuV/m) = Correct Factor (dB/m) + Reading(dBuV).

2.Correction factor (dB/m) = Antenna Factor (dB/m) + Cable loss (dB) – Pre-Amplifier gain (dB).

3.When the peak results are less than average limit, so not need to evaluate the average.



Standard:	FCC Part 15.407	Test Distance:	3m
Test item:	Band edge	Power:	AC 120V/60Hz
Frequency:	5795MHz	Temp.(°C)/Hum.(%RH):	26(°C)/60%RH
Mode:	Mode 4		
Ant.Polar.:	Vertical		

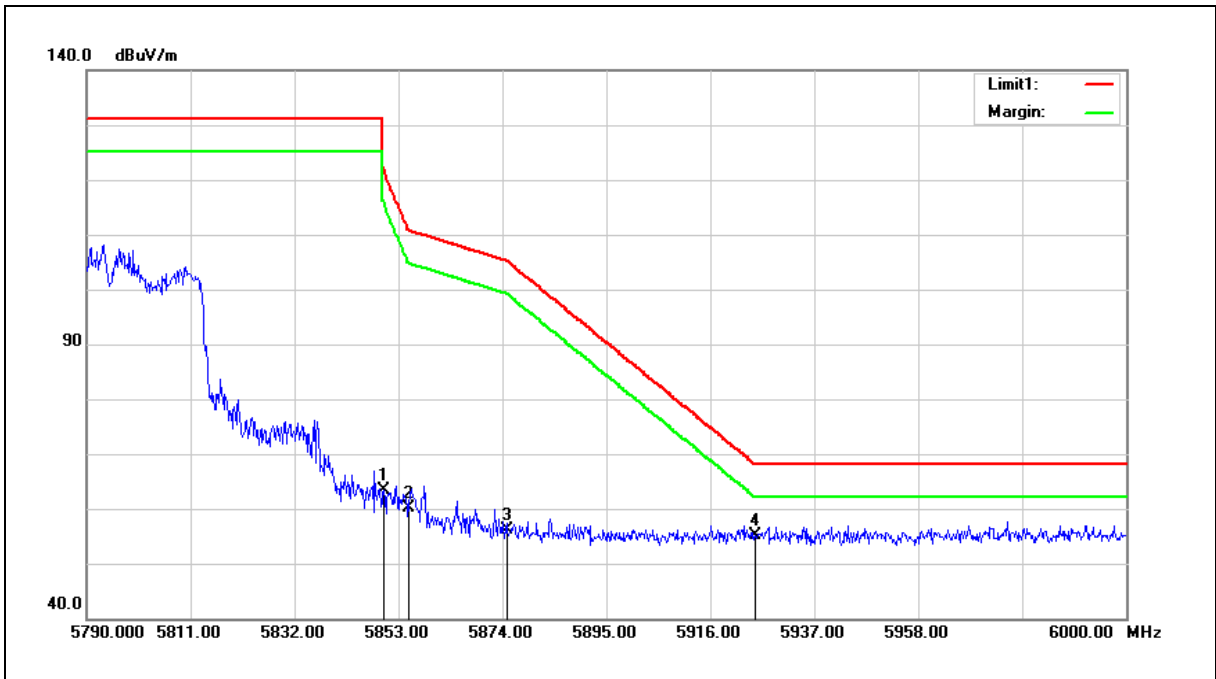

No.	Frequency (MHz)	Reading (dBuV)	Correct Factor (dB/m)	Result (dBuV/m)	Limit (dBuV/m)	Margin (dB)	Remark
1	5850.000	56.40	7.03	63.43	122.20	-58.77	peak
2	5855.000	53.21	7.04	60.25	110.80	-50.55	peak
3	5875.000	49.09	7.09	56.18	105.20	-49.02	peak
4	5925.000	47.84	7.20	55.04	68.20	-13.16	peak

Note:1.Result (dBuV/m) = Correct Factor (dB/m) + Reading(dBuV).

2.Correction factor (dB/m) = Antenna Factor (dB/m) + Cable loss (dB) – Pre-Amplifier gain (dB).

3.When the peak results are less than average limit, so not need to evaluate the average.



Standard:	FCC Part 15.407	Test Distance:	3m
Test item:	Band edge	Power:	AC 120V/60Hz
Frequency:	5210MHz	Temp.(°C)/Hum.(%RH):	26(°C)/60%RH
Mode:	Mode 5		
Ant.Polar.:	Horizontal		

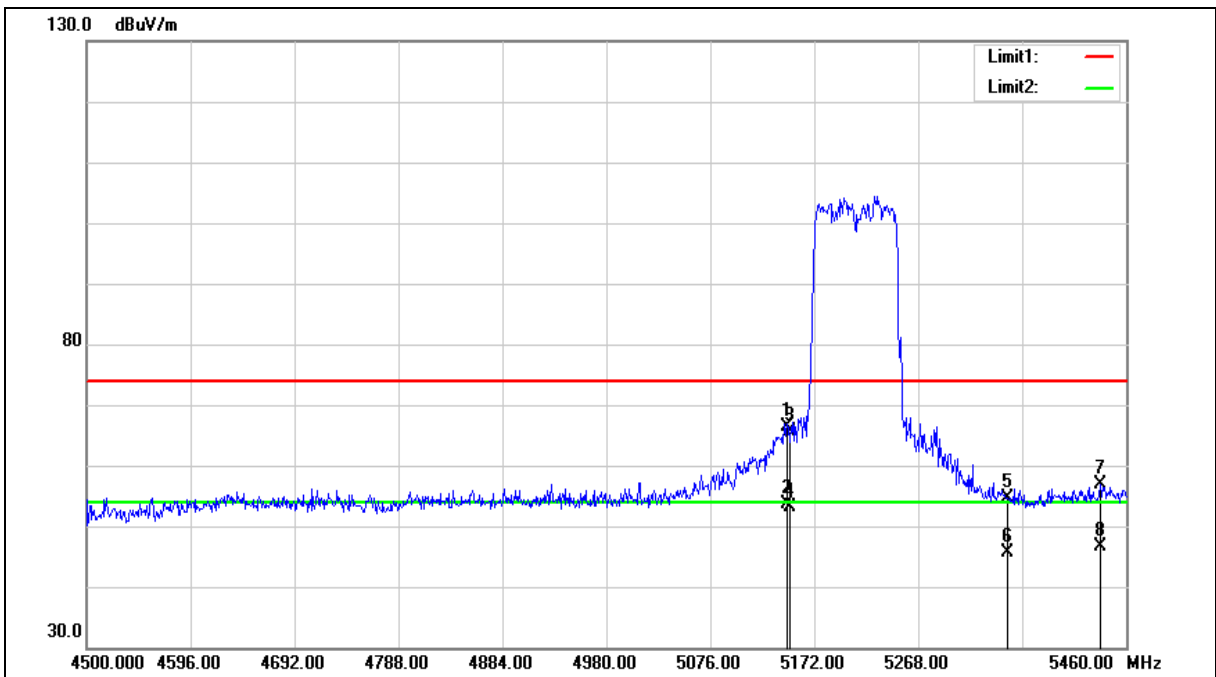



Standard:	FCC Part 15.407	Test Distance:	3m
Test item:	Band edge	Power:	AC 120V/60Hz
Frequency:	5210MHz	Temp.(°C)/Hum.(%RH):	26(°C)/60%RH
Mode:	Mode 5		
Ant.Polar.:	Horizontal		

No.	Frequency (MHz)	Reading (dBuV)	Correct Factor (dB/m)	Result (dBuV/m)	Limit (dBuV/m)	Margin (dB)	Remark
1	5147.590	60.59	5.77	66.36	74.00	-7.64	peak
2	5147.590	47.88	5.77	53.65	54.00	-0.35	AVG
3	5150.000	59.85	5.78	65.63	74.00	-8.37	peak
4	5150.000	47.46	5.78	53.24	54.00	-0.76	AVG
5	5350.000	48.55	6.07	54.62	74.00	-19.38	peak
6	5350.000	39.46	6.07	45.53	54.00	-8.47	AVG
7	5436.000	50.78	6.20	56.98	74.00	-17.02	peak
8	5436.000	40.41	6.20	46.61	54.00	-7.39	AVG

Note:1.Result (dBuV/m) = Correct Factor (dB/m) + Reading(dBuV).

2.Correction factor (dB/m) = Antenna Factor (dB/m) + Cable loss (dB) – Pre-Amplifier gain (dB).

3.When the peak results are less than average limit, so not need to evaluate the average.



Standard:	FCC Part 15.407	Test Distance:	3m
Test item:	Band edge	Power:	AC 120V/60Hz
Frequency:	5210MHz	Temp.(°C)/Hum.(%RH):	26(°C)/60%RH
Mode:	Mode 5		
Ant.Polar.:	Vertical		

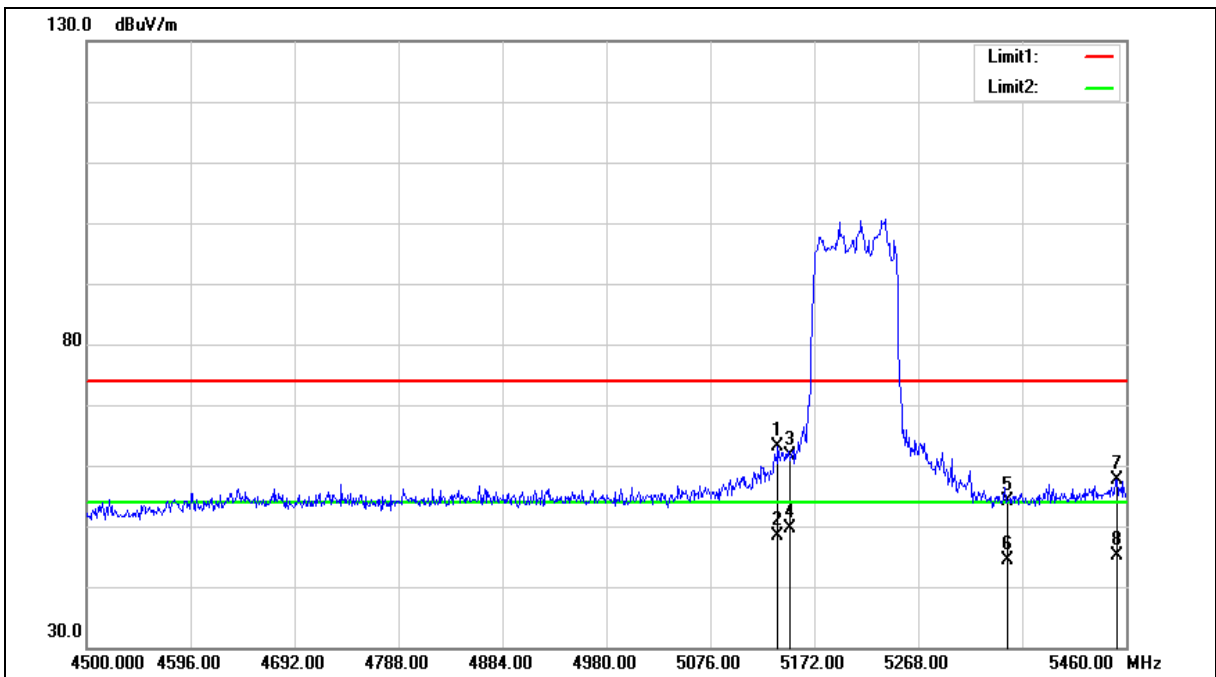



Standard:	FCC Part 15.407	Test Distance:	3m
Test item:	Band edge	Power:	AC 120V/60Hz
Frequency:	5210MHz	Temp.(°C)/Hum.(%RH):	26(°C)/60%RH
Mode:	Mode 5		
Ant.Polar.:	Vertical		

No.	Frequency (MHz)	Reading (dBuV)	Correct Factor (dB/m)	Result (dBuV/m)	Limit (dBuV/m)	Margin (dB)	Remark
1	5138.400	57.44	5.76	63.20	74.00	-10.80	peak
2	5138.400	42.73	5.76	48.49	54.00	-5.51	AVG
3	5150.000	55.75	5.78	61.53	74.00	-12.47	peak
4	5150.000	43.94	5.78	49.72	54.00	-4.28	AVG
5	5350.000	47.95	6.07	54.02	74.00	-19.98	peak
6	5350.000	38.37	6.07	44.44	54.00	-9.56	AVG
7	5451.360	51.47	6.22	57.69	74.00	-16.31	peak
8	5451.360	39.01	6.22	45.23	54.00	-8.77	AVG

Note:1.Result (dBuV/m) = Correct Factor (dB/m) + Reading(dBuV).

2.Correction factor (dB/m) = Antenna Factor (dB/m) + Cable loss (dB) – Pre-Amplifier gain (dB).

3.When the peak results are less than average limit, so not need to evaluate the average.



Standard:	FCC Part 15.407	Test Distance:	3m
Test item:	Band edge	Power:	AC 120V/60Hz
Frequency:	5775MHz	Temp.(°C)/Hum.(%RH):	26(°C)/60%RH
Mode:	Mode 5		
Ant.Polar.:	Horizontal		

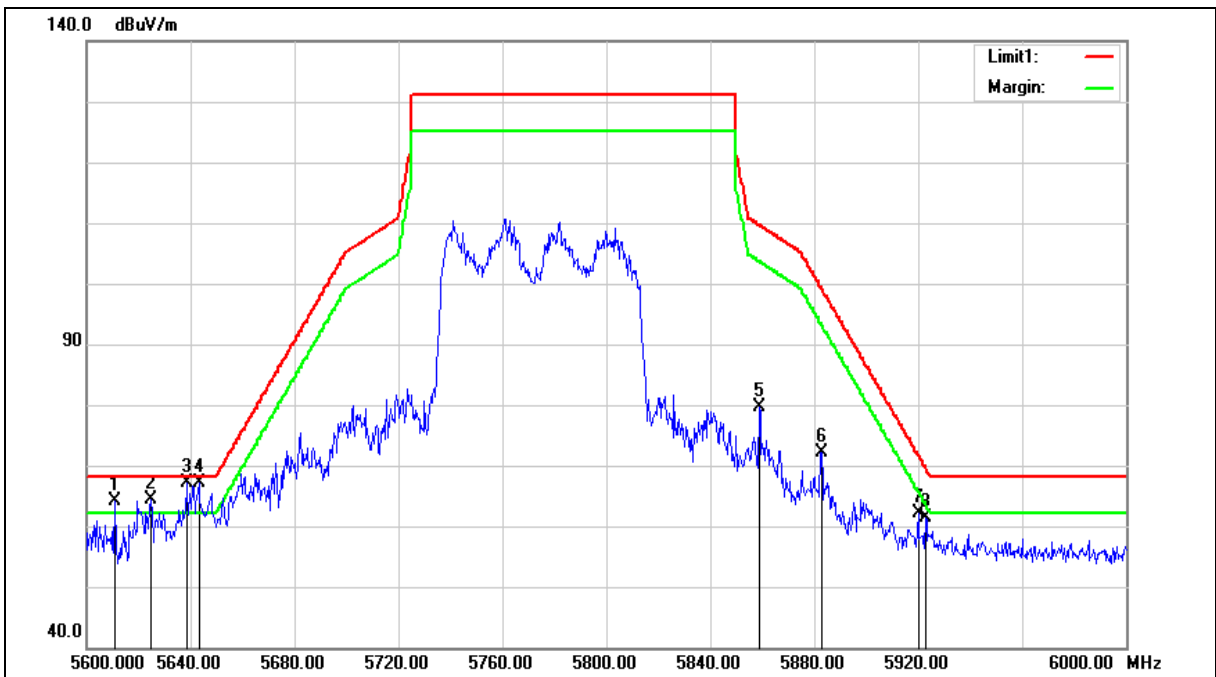



Standard:	FCC Part 15.407	Test Distance:	3m
Test item:	Band edge	Power:	AC 120V/60Hz
Frequency:	5775MHz	Temp.(°C)/Hum.(%RH):	26(°C)/60%RH
Mode:	Mode 5		
Ant.Polar.:	Horizontal		

No.	Frequency (MHz)	Reading (dBuV)	Correct Factor (dB/m)	Result (dBuV/m)	Limit (dBuV/m)	Margin (dB)	Remark
1	5610.800	57.58	6.53	64.11	68.20	-4.09	peak
2	5624.800	57.73	6.55	64.28	68.20	-3.92	peak
3	5638.400	60.49	6.58	67.07	68.20	-1.13	peak
4	5643.200	60.64	6.59	67.23	68.20	-0.97	peak
5	5858.800	72.56	7.05	79.61	109.74	-30.13	peak
6	5882.800	64.97	7.10	72.07	99.43	-27.36	peak
7	5920.000	54.96	7.19	62.15	71.90	-9.75	peak
8	5922.800	54.12	7.19	61.31	69.83	-8.52	peak

Note:1.Result (dBuV/m) = Correct Factor (dB/m) + Reading(dBuV).

2.Correction factor (dB/m) = Antenna Factor (dB/m) + Cable loss (dB) – Pre-Amplifier gain (dB).

3.When the peak results are less than average limit, so not need to evaluate the average.



Standard:	FCC Part 15.407	Test Distance:	3m
Test item:	Band edge	Power:	AC 120V/60Hz
Frequency:	5775MHz	Temp.(°C)/Hum.(%RH):	26(°C)/60%RH
Mode:	Mode 5		
Ant.Polar.:	Vertical		

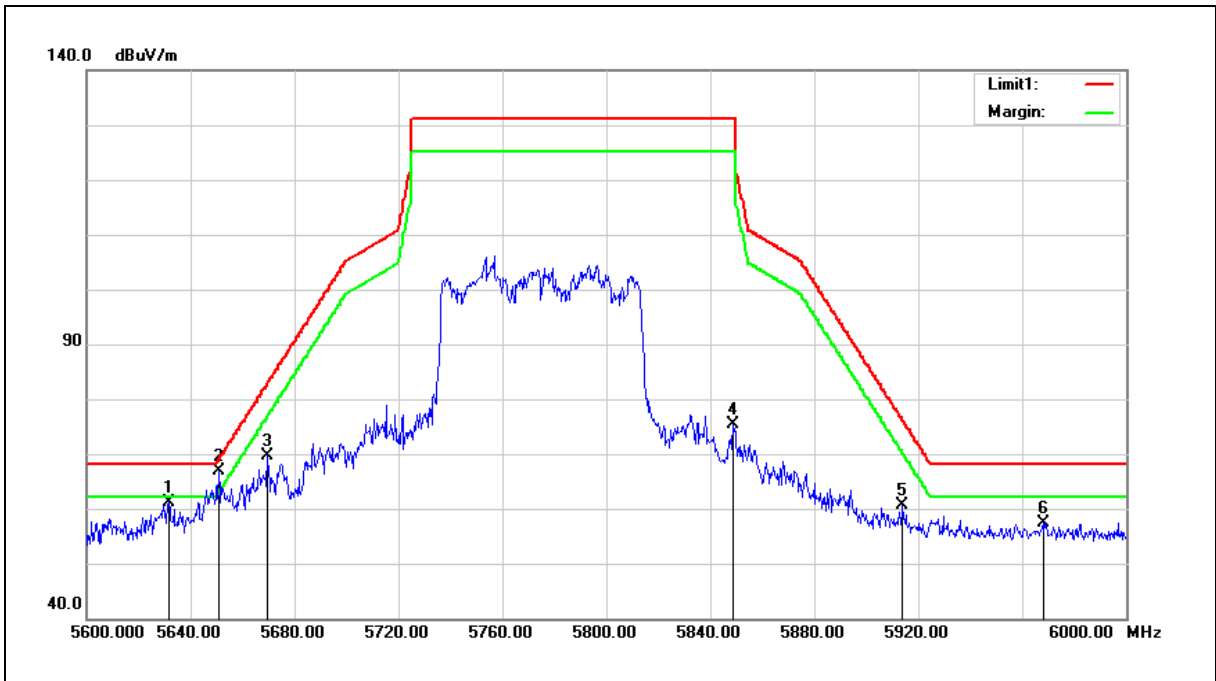

No.	Frequency (MHz)	Reading (dBuV)	Correct Factor (dB/m)	Result (dBuV/m)	Limit (dBuV/m)	Margin (dB)	Remark
1	5631.600	54.54	6.57	61.11	68.20	-7.09	peak
2	5650.800	60.18	6.61	66.79	68.79	-2.00	peak
3	5669.600	62.91	6.65	69.56	82.70	-13.14	peak
4	5848.800	68.42	7.03	75.45	131.20	-55.75	peak
5	5914.000	53.35	7.17	60.52	76.34	-15.82	peak
6	5968.000	50.07	7.29	57.36	68.20	-10.84	peak

Note:1.Result (dBuV/m) = Correct Factor (dB/m) + Reading(dBuV).

2.Correction factor (dB/m) = Antenna Factor (dB/m) + Cable loss (dB) – Pre-Amplifier gain (dB).

3.When the peak results are less than average limit, so not need to evaluate the average.



Beamforming on

Below 1GHz

Standard:	FCC Part 15.407	Test Distance:	3m				
Test item:	Harmonic	Power:	AC 120V/60Hz				
Test Mode:	Mode 1	Temp.(°C)/Hum.(%RH):	26(°C)/60%RH				
Description:	Adapter Model Number: PA1015-120HUB125						
Frequency (MHz)	Reading (dBuV)	Correct Factor (dB/m)	Result (dBuV/m)	Limit (dBuV/m)	Margin (dB)	Remark	Ant.Polar. H / V
134.7600	38.26	-6.37	31.89	43.50	-11.61	QP	H
219.1500	37.53	-6.69	30.84	46.00	-15.16	QP	H
499.4800	33.79	0.66	34.45	46.00	-11.55	QP	H
643.0400	30.27	3.48	33.75	46.00	-12.25	QP	H
799.2100	30.26	6.50	36.76	46.00	-9.24	QP	H
974.7800	28.21	9.76	37.97	54.00	-16.03	QP	H
142.5200	37.56	-5.66	31.90	43.50	-11.60	QP	V
236.6100	33.33	-5.76	27.57	46.00	-18.43	QP	V
406.3600	30.74	-1.01	29.73	46.00	-16.27	QP	V
499.4800	30.95	0.66	31.61	46.00	-14.39	QP	V
738.1000	28.46	5.56	34.02	46.00	-11.98	QP	V
953.4400	28.38	9.52	37.90	46.00	-8.10	QP	V

- Note: 1. No emission found between lowest internal used/generated frequency to 30MHz (9kHz~30MHz).
 2. Result = Correction factor + Reading
 3. Correction factor = Antenna Factor + Cable loss – Pre-Amplifier gain.



Above 1GHz

Standard:	FCC Part 15.407	Test Distance:	3m
Test item:	Harmonic	Power:	AC 120V/60Hz
Frequency:	5180MHz	Temp.(°C)/Hum.(%RH):	26(°C)/60%RH
Mode:	Mode 3		
Ant.Polar.:	Horizontal		

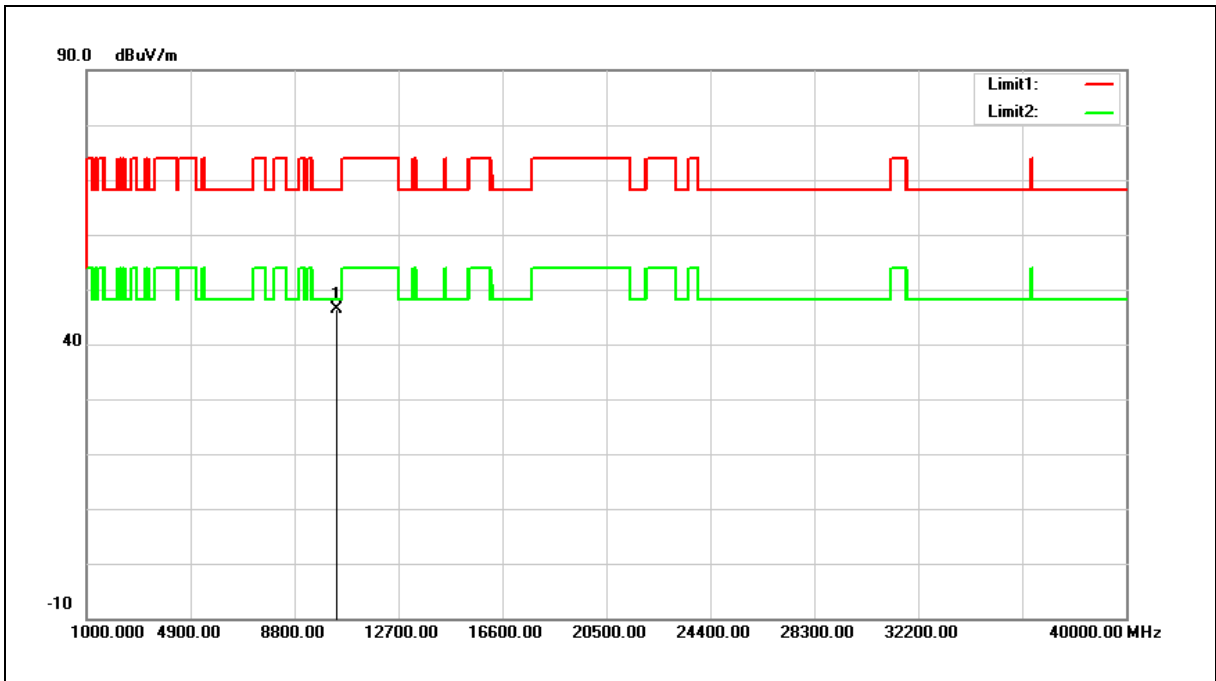

No.	Frequency (MHz)	Reading (dBuV)	Correct Factor (dB/m)	Result (dBuV/m)	Limit (dBuV/m)	Margin (dB)	Remark
1	10360.000	30.18	16.09	46.27	68.20	-21.93	peak

Note:1.Result (dBuV/m) = Correct Factor (dB/m) + Reading(dBuV).

2.Correction factor (dB/m) = Antenna Factor (dB/m) + Cable loss (dB) – Pre-Amplifier gain (dB).

3.When the peak results are less than average limit, so not need to evaluate the average.



Standard:	FCC Part 15.407	Test Distance:	3m
Test item:	Harmonic	Power:	AC 120V/60Hz
Frequency:	5180MHz	Temp.(°C)/Hum.(%RH):	26(°C)/60%RH
Mode:	Mode 3		
Ant.Polar.:	Vertical		

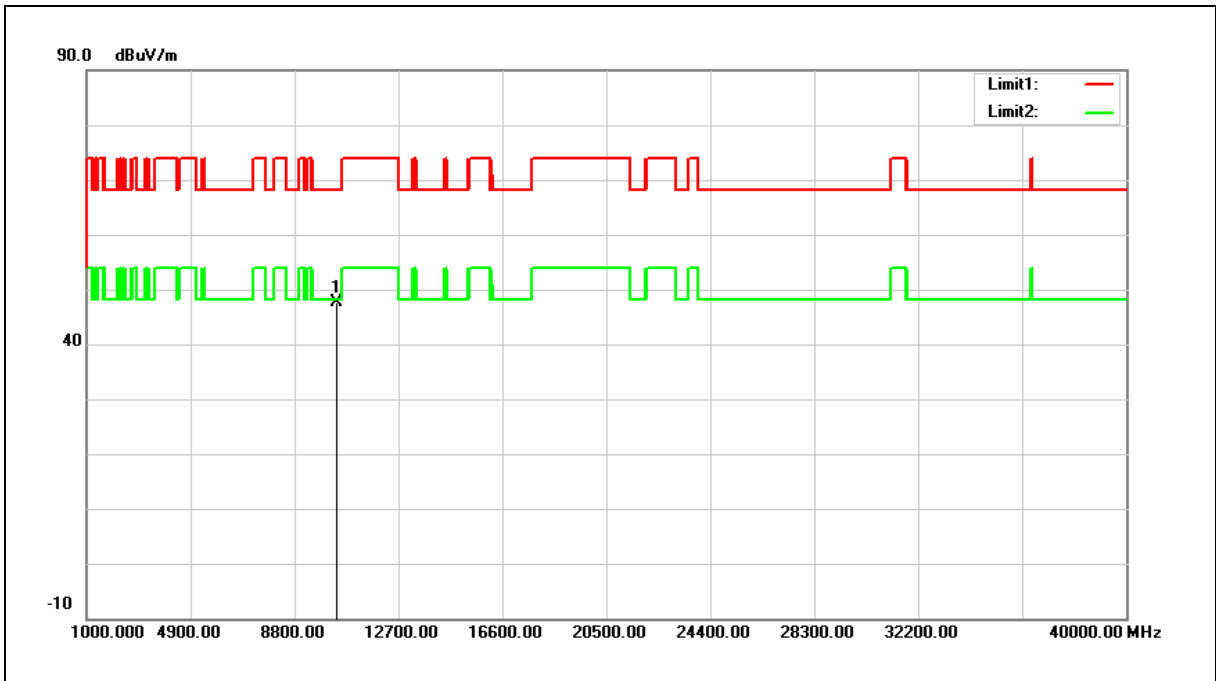

No.	Frequency (MHz)	Reading (dBuV)	Correct Factor (dB/m)	Result (dBuV/m)	Limit (dBuV/m)	Margin (dB)	Remark
1	10360.000	31.42	16.09	47.51	68.20	-20.69	peak

Note:1.Result (dBuV/m) = Correct Factor (dB/m) + Reading(dBuV).

2.Correction factor (dB/m) = Antenna Factor (dB/m) + Cable loss (dB) – Pre-Amplifier gain (dB).

3.When the peak results are less than average limit, so not need to evaluate the average.



Standard:	FCC Part 15.407	Test Distance:	3m
Test item:	Harmonic	Power:	AC 120V/60Hz
Frequency:	5200MHz	Temp.(°C)/Hum.(%RH):	26(°C)/60%RH
Mode:	Mode 3		
Ant.Polar.:	Horizontal		

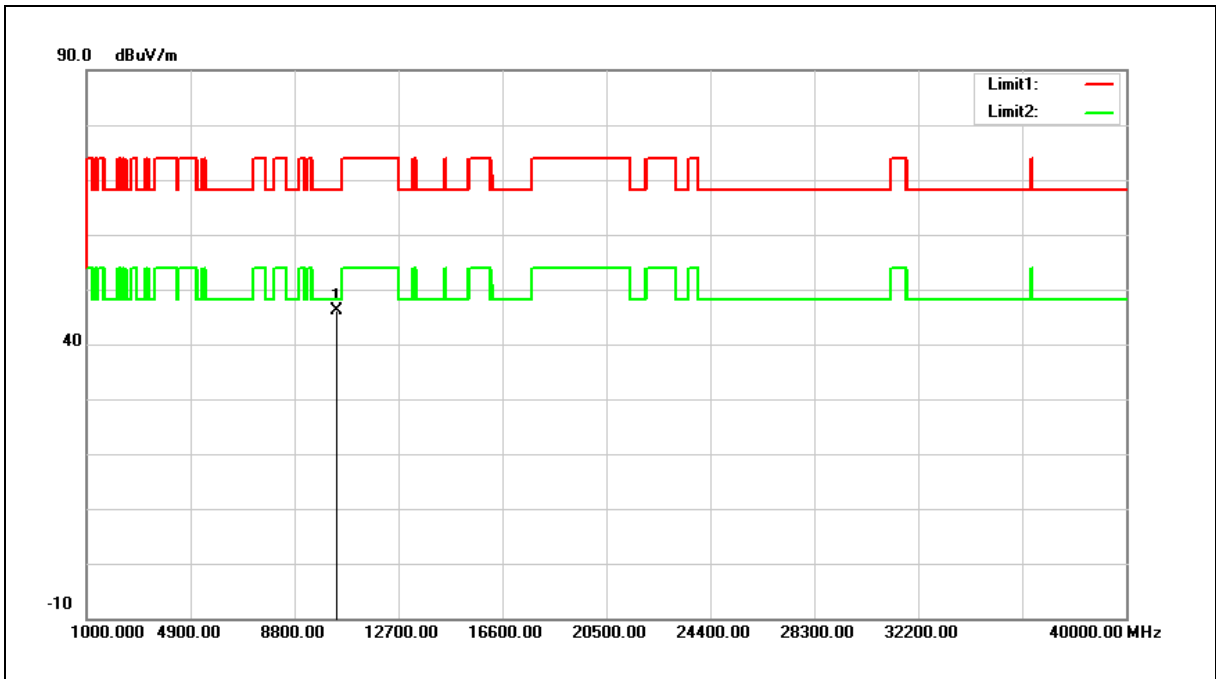

No.	Frequency (MHz)	Reading (dBuV)	Correct Factor (dB/m)	Result (dBuV/m)	Limit (dBuV/m)	Margin (dB)	Remark
1	10400.000	29.97	16.22	46.19	68.20	-22.01	peak

Note:1.Result (dBuV/m) = Correct Factor (dB/m) + Reading(dBuV).

2.Correction factor (dB/m) = Antenna Factor (dB/m) + Cable loss (dB) – Pre-Amplifier gain (dB).

3.When the peak results are less than average limit, so not need to evaluate the average.



Standard:	FCC Part 15.407	Test Distance:	3m
Test item:	Harmonic	Power:	AC 120V/60Hz
Frequency:	5200MHz	Temp.(°C)/Hum.(%RH):	26(°C)/60%RH
Mode:	Mode 3		
Ant.Polar.:	Vertical		

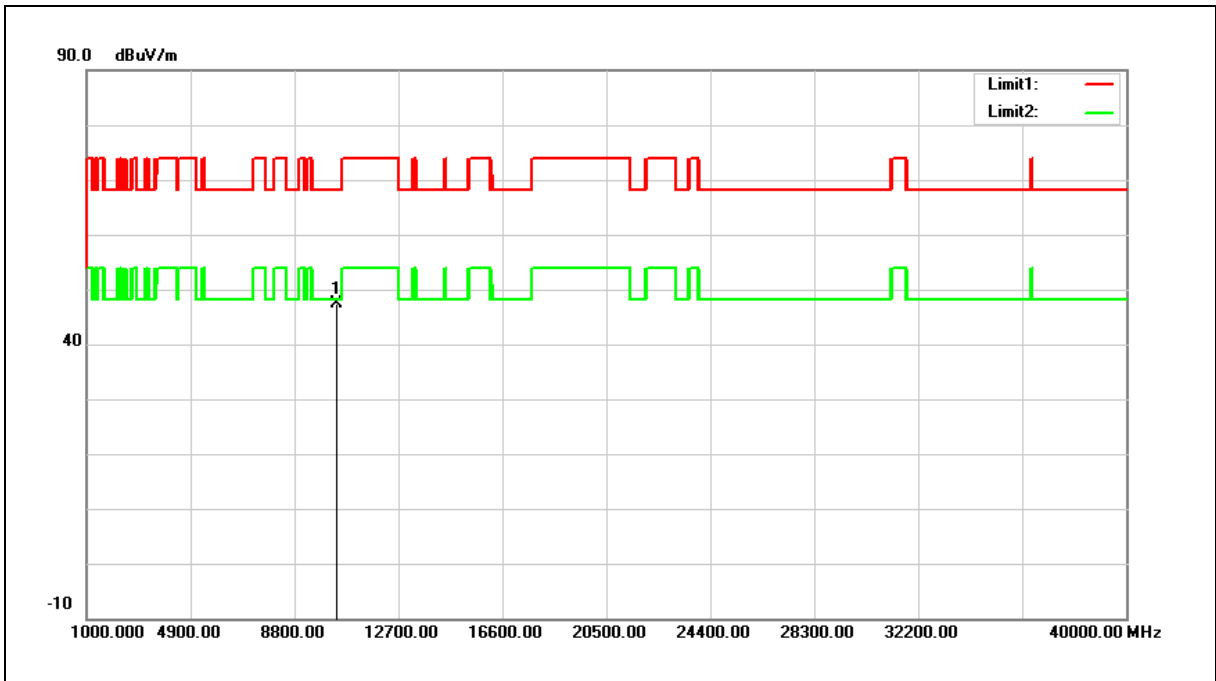

No.	Frequency (MHz)	Reading (dBuV)	Correct Factor (dB/m)	Result (dBuV/m)	Limit (dBuV/m)	Margin (dB)	Remark
1	10400.000	31.04	16.22	47.26	68.20	-20.94	peak

Note:1.Result (dBuV/m) = Correct Factor (dB/m) + Reading(dBuV).

2.Correction factor (dB/m) = Antenna Factor (dB/m) + Cable loss (dB) – Pre-Amplifier gain (dB).

3.When the peak results are less than average limit, so not need to evaluate the average.



Standard:	FCC Part 15.407	Test Distance:	3m
Test item:	Harmonic	Power:	AC 120V/60Hz
Frequency:	5240MHz	Temp.(°C)/Hum.(%RH):	26(°C)/60%RH
Mode:	Mode 3		
Ant.Polar.:	Horizontal		

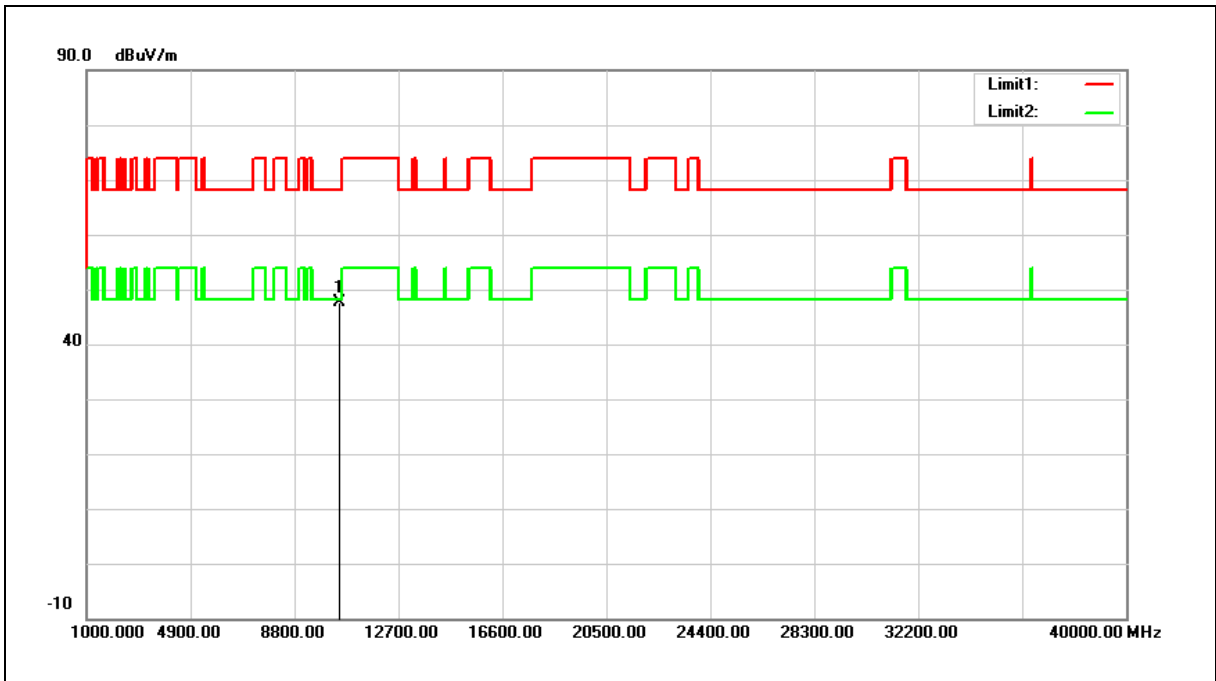

No.	Frequency (MHz)	Reading (dBuV)	Correct Factor (dB/m)	Result (dBuV/m)	Limit (dBuV/m)	Margin (dB)	Remark
1	10480.000	31.11	16.47	47.58	68.20	-20.62	peak

Note:1.Result (dBuV/m) = Correct Factor (dB/m) + Reading(dBuV).

2.Correction factor (dB/m) = Antenna Factor (dB/m) + Cable loss (dB) – Pre-Amplifier gain (dB).

3.When the peak results are less than average limit, so not need to evaluate the average.



Standard:	FCC Part 15.407	Test Distance:	3m
Test item:	Harmonic	Power:	AC 120V/60Hz
Frequency:	5240MHz	Temp.(°C)/Hum.(%RH):	26(°C)/60%RH
Mode:	Mode 3		
Ant.Polar.:	Vertical		

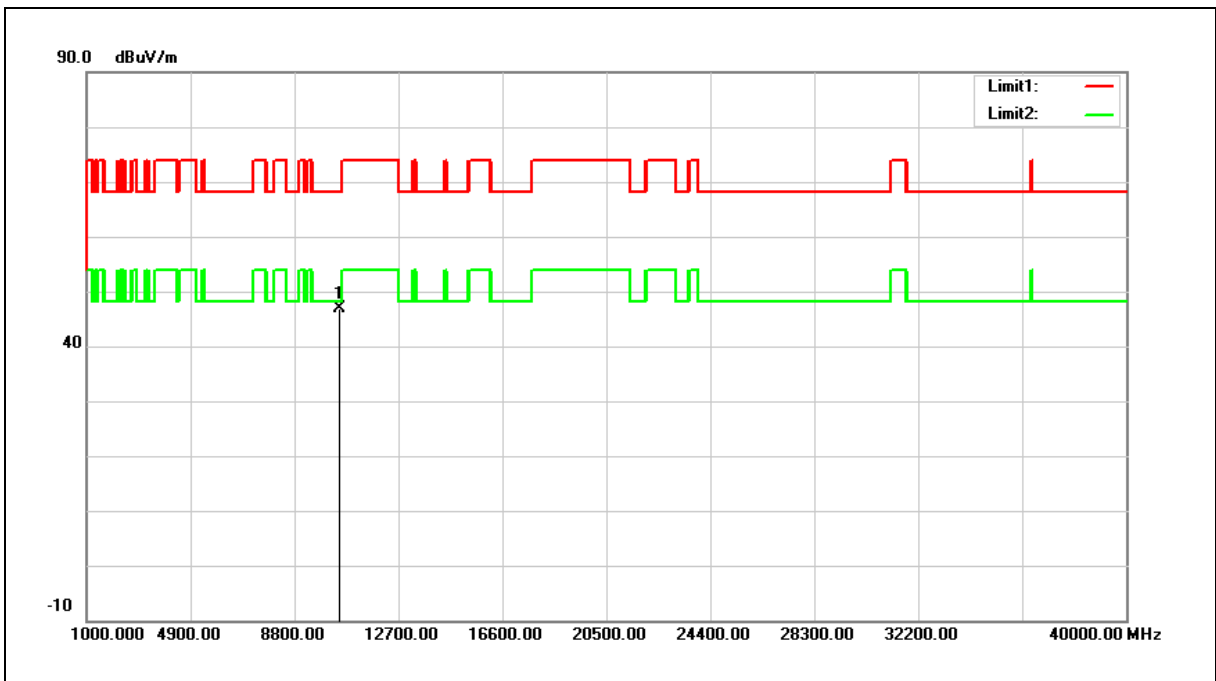

No.	Frequency (MHz)	Reading (dBuV)	Correct Factor (dB/m)	Result (dBuV/m)	Limit (dBuV/m)	Margin (dB)	Remark
1	10480.000	30.41	16.47	46.88	68.20	-21.32	peak

- Note:1.Result (dBuV/m) = Correct Factor (dB/m) + Reading(dBuV).
 2.Correction factor (dB/m) = Antenna Factor (dB/m) + Cable loss (dB) – Pre-Amplifier gain (dB).
 3.When the peak results are less than average limit, so not need to evaluate the average.



Standard:	FCC Part 15.407	Test Distance:	3m
Test item:	Harmonic	Power:	AC 120V/60Hz
Frequency:	5745MHz	Temp.(°C)/Hum.(%RH):	26(°C)/60%RH
Mode:	Mode 3		
Ant.Polar.:	Horizontal		

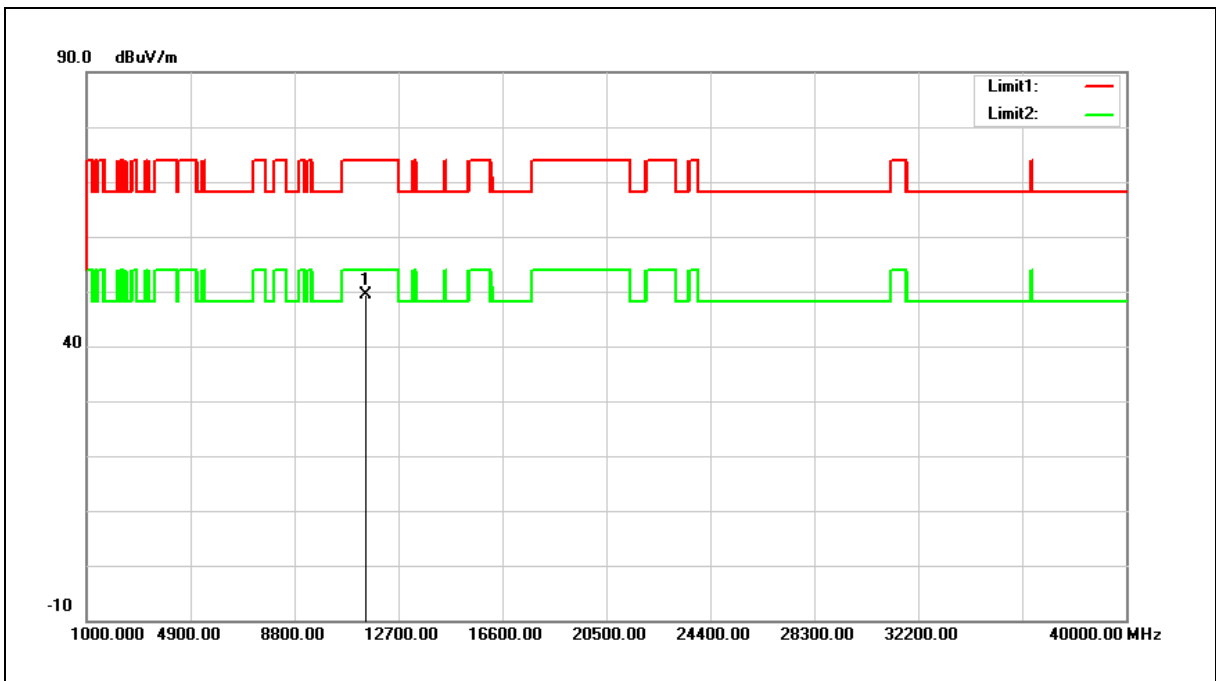

No.	Frequency (MHz)	Reading (dBuV)	Correct Factor (dB/m)	Result (dBuV/m)	Limit (dBuV/m)	Margin (dB)	Remark
1	11490.000	31.24	18.11	49.35	74.00	-24.65	peak

Note:1.Result (dBuV/m) = Correct Factor (dB/m) + Reading(dBuV).

2.Correction factor (dB/m) = Antenna Factor (dB/m) + Cable loss (dB) – Pre-Amplifier gain (dB).

3.When the peak results are less than average limit, so not need to evaluate the average.



Standard:	FCC Part 15.407	Test Distance:	3m
Test item:	Harmonic	Power:	AC 120V/60Hz
Frequency:	5745MHz	Temp.(°C)/Hum.(%RH):	26(°C)/60%RH
Mode:	Mode 3		
Ant.Polar.:	Vertical		

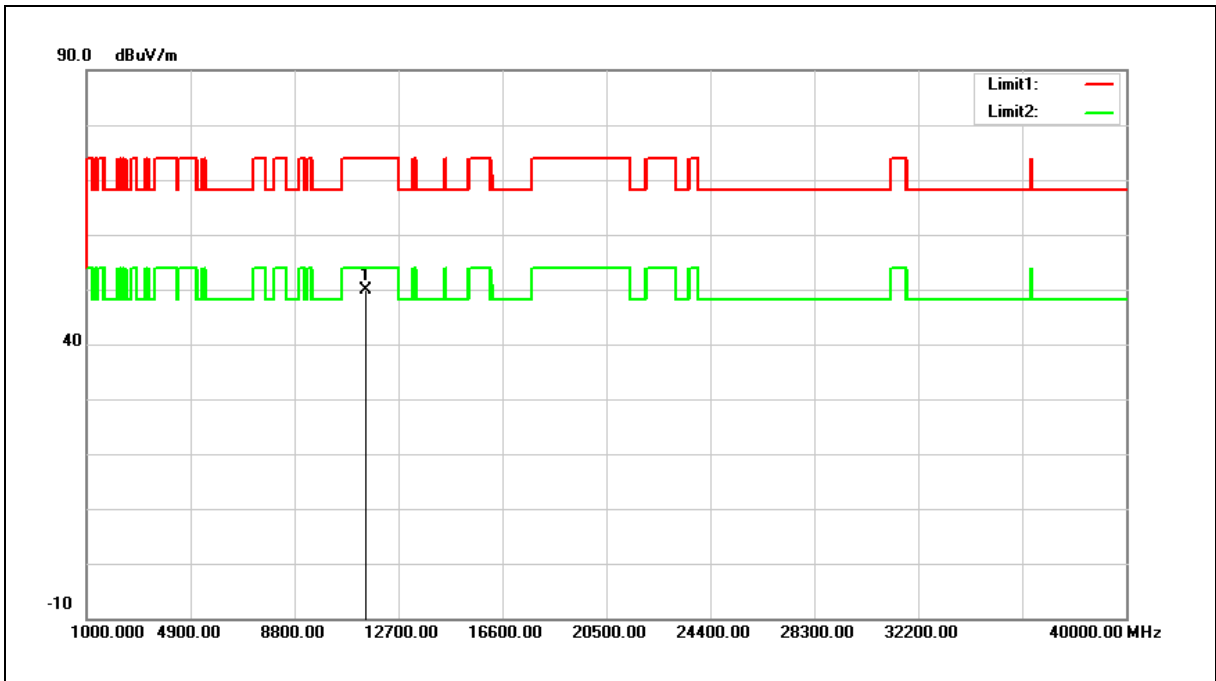

No.	Frequency (MHz)	Reading (dBuV)	Correct Factor (dB/m)	Result (dBuV/m)	Limit (dBuV/m)	Margin (dB)	Remark
1	11490.000	31.83	18.11	49.94	74.00	-24.06	peak

Note:1.Result (dBuV/m) = Correct Factor (dB/m) + Reading(dBuV).

2.Correction factor (dB/m) = Antenna Factor (dB/m) + Cable loss (dB) – Pre-Amplifier gain (dB).

3.When the peak results are less than average limit, so not need to evaluate the average.



Standard:	FCC Part 15.407	Test Distance:	3m
Test item:	Harmonic	Power:	AC 120V/60Hz
Frequency:	5785MHz	Temp.(°C)/Hum.(%RH):	26(°C)/60%RH
Mode:	Mode 3		
Ant.Polar.:	Horizontal		

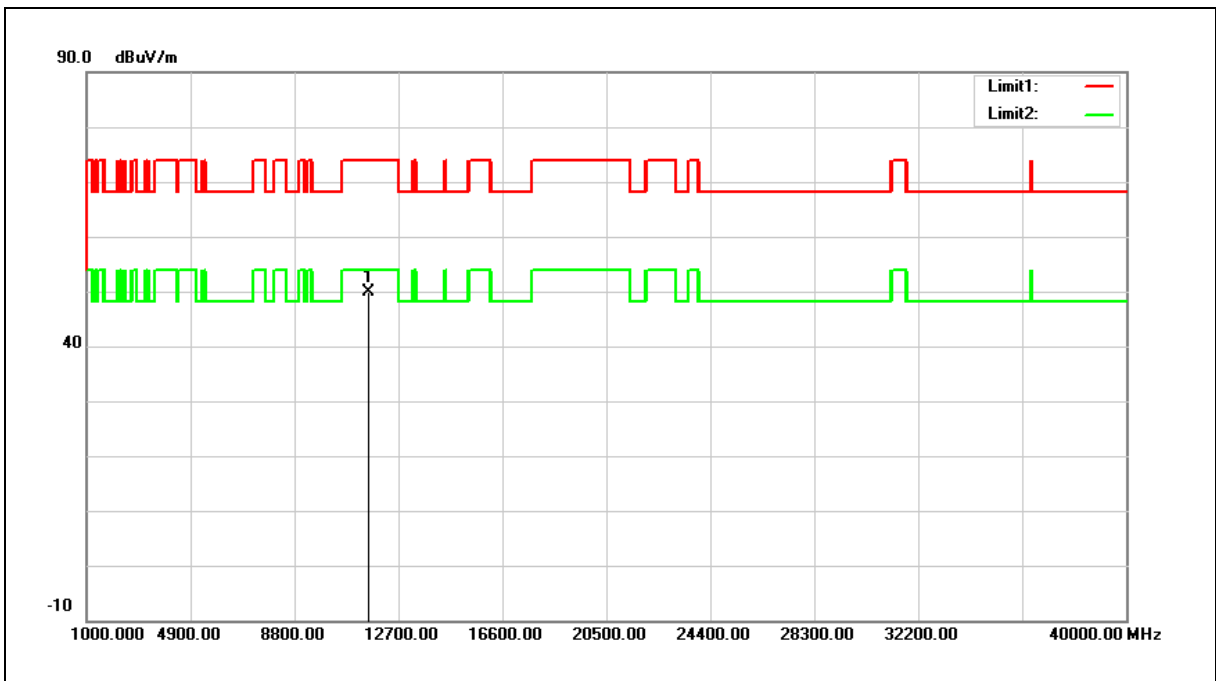

No.	Frequency (MHz)	Reading (dBuV)	Correct Factor (dB/m)	Result (dBuV/m)	Limit (dBuV/m)	Margin (dB)	Remark
1	11570.000	31.75	18.03	49.78	74.00	-24.22	peak

Note:1.Result (dBuV/m) = Correct Factor (dB/m) + Reading(dBuV).

2.Correction factor (dB/m) = Antenna Factor (dB/m) + Cable loss (dB) – Pre-Amplifier gain (dB).

3.When the peak results are less than average limit, so not need to evaluate the average.



Standard:	FCC Part 15.407	Test Distance:	3m
Test item:	Harmonic	Power:	AC 120V/60Hz
Frequency:	5785MHz	Temp.(°C)/Hum.(%RH):	26(°C)/60%RH
Mode:	Mode 3		
Ant.Polar.:	Vertical		

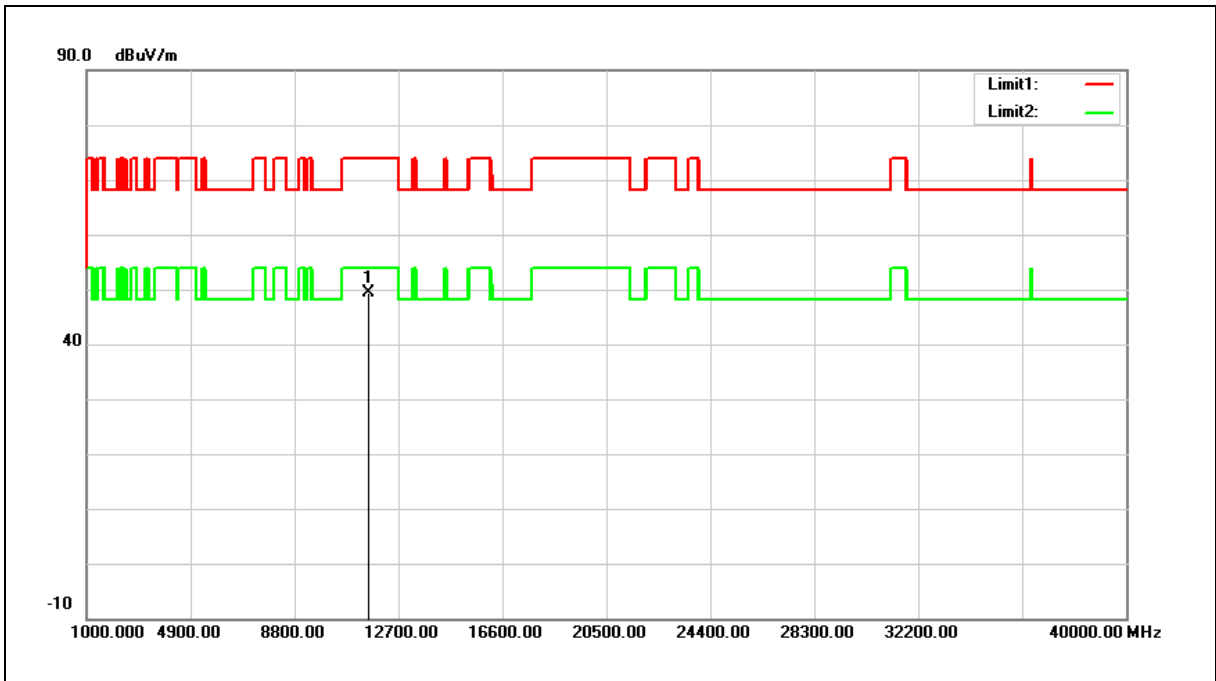

No.	Frequency (MHz)	Reading (dBuV)	Correct Factor (dB/m)	Result (dBuV/m)	Limit (dBuV/m)	Margin (dB)	Remark
1	11570.000	31.46	18.03	49.49	74.00	-24.51	peak

Note:1.Result (dBuV/m) = Correct Factor (dB/m) + Reading(dBuV).

2.Correction factor (dB/m) = Antenna Factor (dB/m) + Cable loss (dB) – Pre-Amplifier gain (dB).

3.When the peak results are less than average limit, so not need to evaluate the average.



Standard:	FCC Part 15.407	Test Distance:	3m
Test item:	Harmonic	Power:	AC 120V/60Hz
Frequency:	5825MHz	Temp.(°C)/Hum.(%RH):	26(°C)/60%RH
Mode:	Mode 3		
Ant.Polar.:	Horizontal		

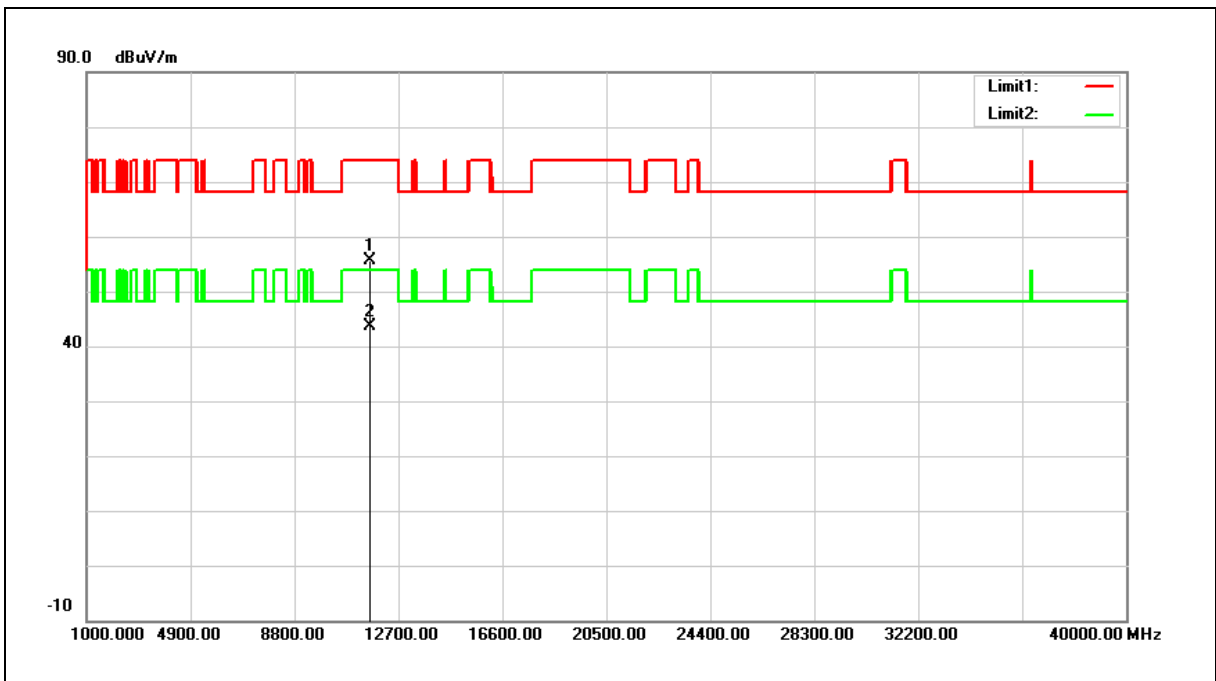

No.	Frequency (MHz)	Reading (dBuV)	Correct Factor (dB/m)	Result (dBuV/m)	Limit (dBuV/m)	Margin (dB)	Remark
1	11650.000	37.61	17.93	55.54	74.00	-18.46	peak
2	11650.000	25.65	17.93	43.58	54.00	-10.42	AVG

- Note: 1.Result (dBuV/m) = Correct Factor (dB/m) + Reading(dBuV).
 2.Correction factor (dB/m) = Antenna Factor (dB/m) + Cable loss (dB) – Pre-Amplifier gain (dB).
 3.When the peak results are less than average limit, so not need to evaluate the average.



Standard:	FCC Part 15.407	Test Distance:	3m
Test item:	Harmonic	Power:	AC 120V/60Hz
Frequency:	5825MHz	Temp.(°C)/Hum.(%RH):	26(°C)/60%RH
Mode:	Mode 3		
Ant.Polar.:	Vertical		

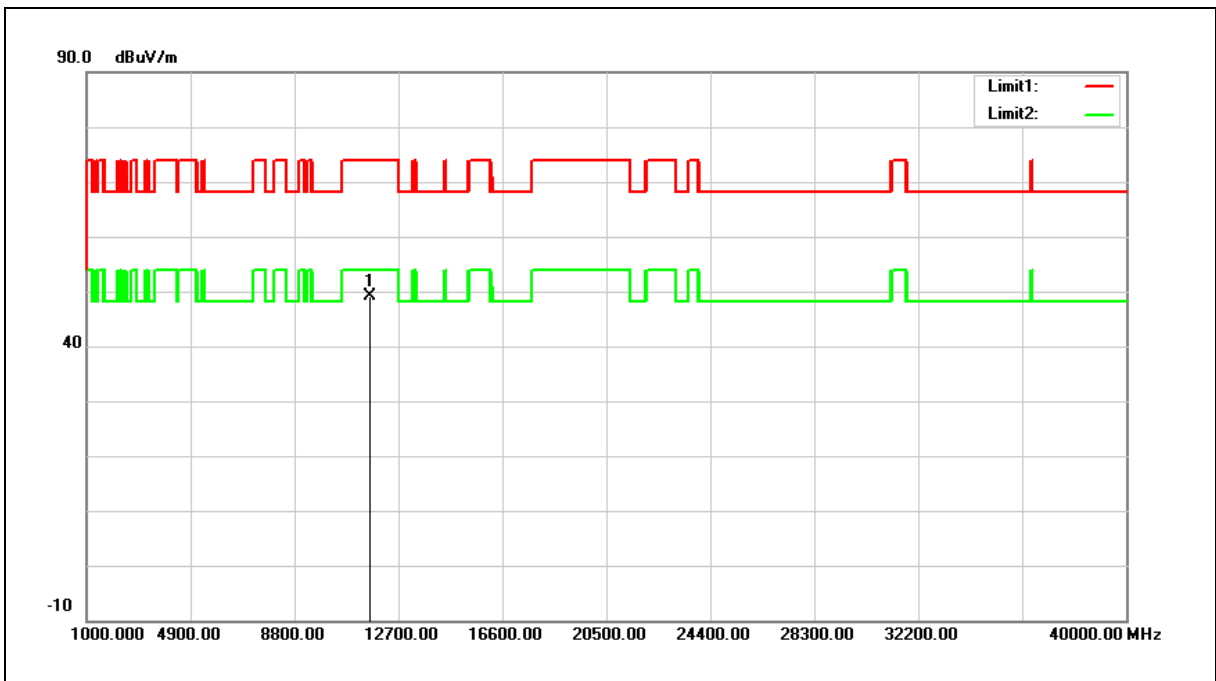

No.	Frequency (MHz)	Reading (dBuV)	Correct Factor (dB/m)	Result (dBuV/m)	Limit (dBuV/m)	Margin (dB)	Remark
1	11650.000	31.21	17.93	49.14	74.00	-24.86	peak

- Note:1.Result (dBuV/m) = Correct Factor (dB/m) + Reading(dBuV).
 2.Correction factor (dB/m) = Antenna Factor (dB/m) + Cable loss (dB) – Pre-Amplifier gain (dB).
 3.When the peak results are less than average limit, so not need to evaluate the average.



Standard:	FCC Part 15.407	Test Distance:	3m
Test item:	Harmonic	Power:	AC 120V/60Hz
Frequency:	5190MHz	Temp.(°C)/Hum.(%RH):	26(°C)/60%RH
Mode:	Mode 4		
Ant.Polar.:	Horizontal		

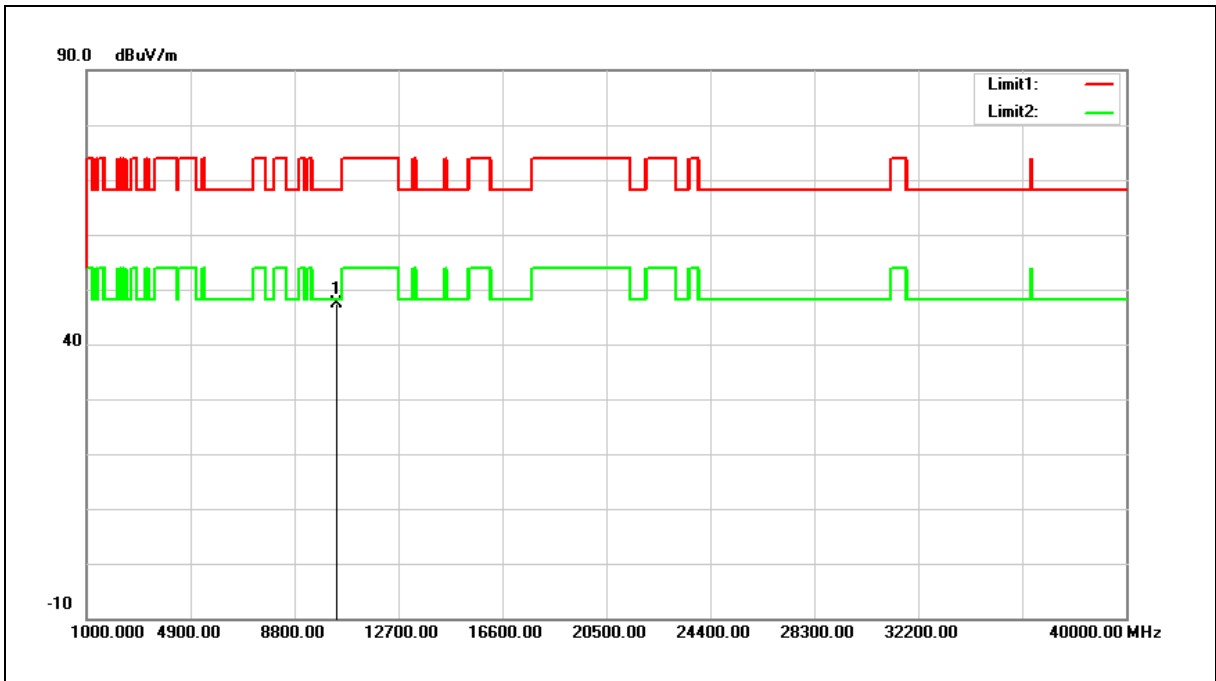

No.	Frequency (MHz)	Reading (dBuV)	Correct Factor (dB/m)	Result (dBuV/m)	Limit (dBuV/m)	Margin (dB)	Remark
1	10380.000	31.34	16.15	47.49	68.20	-20.71	peak

Note:1.Result (dBuV/m) = Correct Factor (dB/m) + Reading(dBuV).

2.Correction factor (dB/m) = Antenna Factor (dB/m) + Cable loss (dB) – Pre-Amplifier gain (dB).

3.When the peak results are less than average limit, so not need to evaluate the average.



Standard:	FCC Part 15.407	Test Distance:	3m
Test item:	Harmonic	Power:	AC 120V/60Hz
Frequency:	5190MHz	Temp.(°C)/Hum.(%RH):	26(°C)/60%RH
Mode:	Mode 4		
Ant.Polar.:	Vertical		

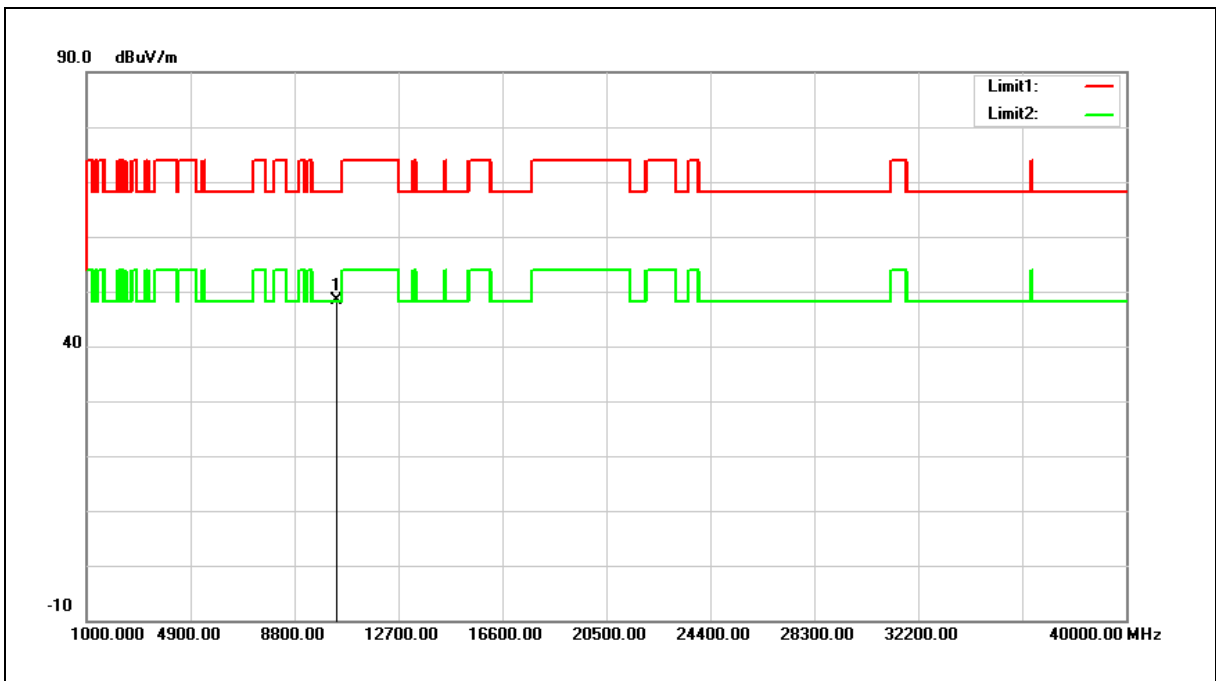

No.	Frequency (MHz)	Reading (dBuV)	Correct Factor (dB/m)	Result (dBuV/m)	Limit (dBuV/m)	Margin (dB)	Remark
1	10380.000	32.18	16.15	48.33	68.20	-19.87	peak

Note:1.Result (dBuV/m) = Correct Factor (dB/m) + Reading(dBuV).

2.Correction factor (dB/m) = Antenna Factor (dB/m) + Cable loss (dB) – Pre-Amplifier gain (dB).

3.When the peak results are less than average limit, so not need to evaluate the average.



Standard:	FCC Part 15.407	Test Distance:	3m
Test item:	Harmonic	Power:	AC 120V/60Hz
Frequency:	5230MHz	Temp.(°C)/Hum.(%RH):	26(°C)/60%RH
Mode:	Mode 4		
Ant.Polar.:	Horizontal		

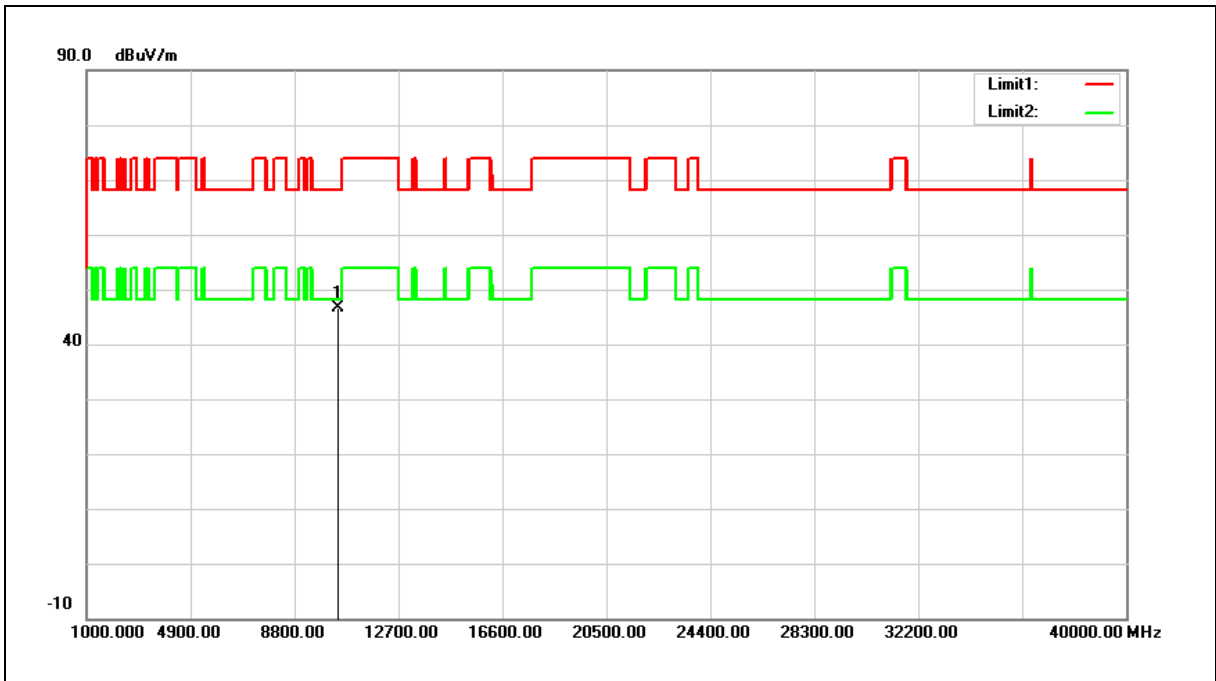

No.	Frequency (MHz)	Reading (dBuV)	Correct Factor (dB/m)	Result (dBuV/m)	Limit (dBuV/m)	Margin (dB)	Remark
1	10460.000	30.22	16.41	46.63	68.20	-21.57	peak

Note:1.Result (dBuV/m) = Correct Factor (dB/m) + Reading(dBuV).

2.Correction factor (dB/m) = Antenna Factor (dB/m) + Cable loss (dB) – Pre-Amplifier gain (dB).

3.When the peak results are less than average limit, so not need to evaluate the average.



Standard:	FCC Part 15.407	Test Distance:	3m
Test item:	Harmonic	Power:	AC 120V/60Hz
Frequency:	5230MHz	Temp.(°C)/Hum.(%RH):	26(°C)/60%RH
Mode:	Mode 4		
Ant.Polar.:	Vertical		

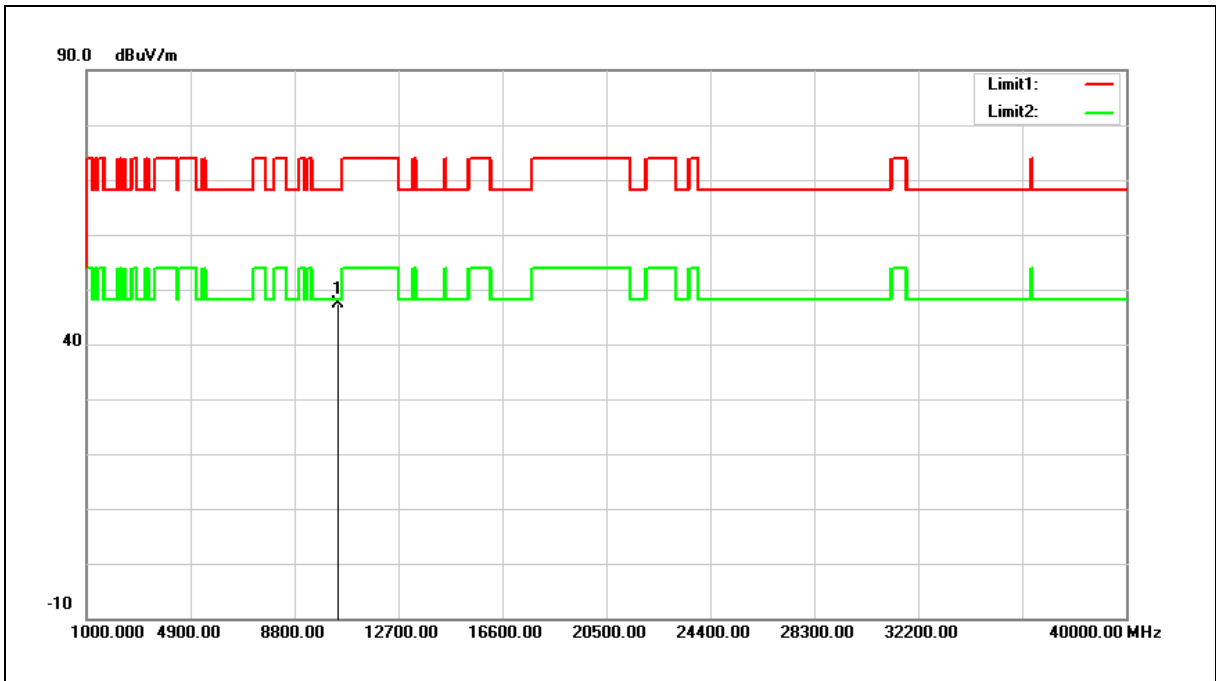

No.	Frequency (MHz)	Reading (dBuV)	Correct Factor (dB/m)	Result (dBuV/m)	Limit (dBuV/m)	Margin (dB)	Remark
1	10460.000	31.07	16.41	47.48	68.20	-20.72	peak

Note:1.Result (dBuV/m) = Correct Factor (dB/m) + Reading(dBuV).

2.Correction factor (dB/m) = Antenna Factor (dB/m) + Cable loss (dB) – Pre-Amplifier gain (dB).

3.When the peak results are less than average limit, so not need to evaluate the average.



Standard:	FCC Part 15.407	Test Distance:	3m
Test item:	Harmonic	Power:	AC 120V/60Hz
Frequency:	5755MHz	Temp.(°C)/Hum.(%RH):	26(°C)/60%RH
Mode:	Mode 4		
Ant.Polar.:	Horizontal		

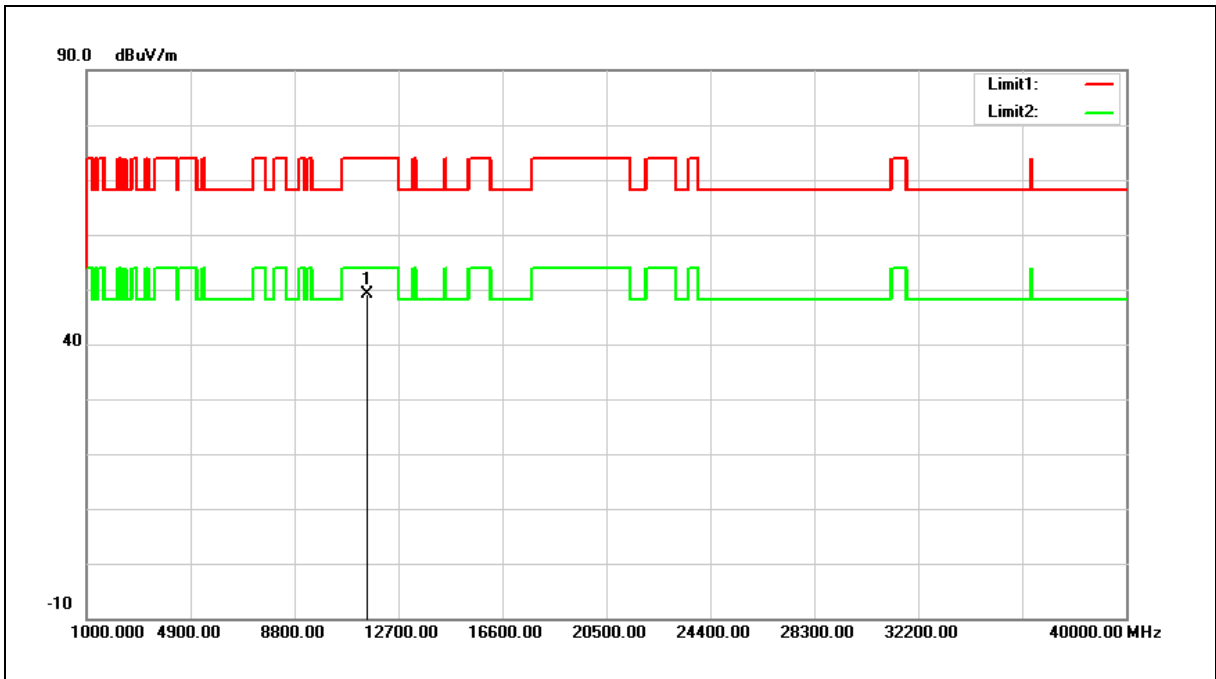

No.	Frequency (MHz)	Reading (dBuV)	Correct Factor (dB/m)	Result (dBuV/m)	Limit (dBuV/m)	Margin (dB)	Remark
1	11510.000	30.95	18.11	49.06	74.00	-24.94	peak

Note:1.Result (dBuV/m) = Correct Factor (dB/m) + Reading(dBuV).

2.Correction factor (dB/m) = Antenna Factor (dB/m) + Cable loss (dB) – Pre-Amplifier gain (dB).

3.When the peak results are less than average limit, so not need to evaluate the average.



Standard:	FCC Part 15.407	Test Distance:	3m
Test item:	Harmonic	Power:	AC 120V/60Hz
Frequency:	5755MHz	Temp.(°C)/Hum.(%RH):	26(°C)/60%RH
Mode:	Mode 4		
Ant.Polar.:	Vertical		

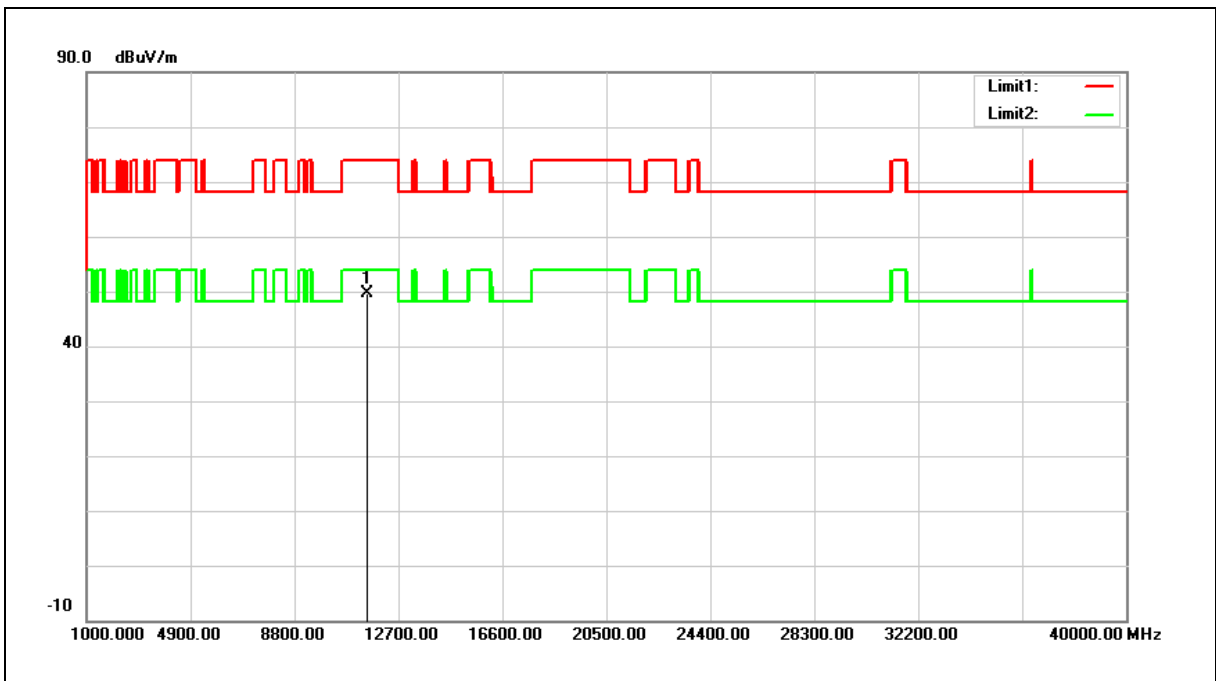

No.	Frequency (MHz)	Reading (dBuV)	Correct Factor (dB/m)	Result (dBuV/m)	Limit (dBuV/m)	Margin (dB)	Remark
1	11510.000	31.55	18.11	49.66	74.00	-24.34	peak

Note:1.Result (dBuV/m) = Correct Factor (dB/m) + Reading(dBuV).

2.Correction factor (dB/m) = Antenna Factor (dB/m) + Cable loss (dB) – Pre-Amplifier gain (dB).

3.When the peak results are less than average limit, so not need to evaluate the average.



Standard:	FCC Part 15.407	Test Distance:	3m
Test item:	Harmonic	Power:	AC 120V/60Hz
Frequency:	5795MHz	Temp.(°C)/Hum.(%RH):	26(°C)/60%RH
Mode:	Mode 4		
Ant.Polar.:	Horizontal		

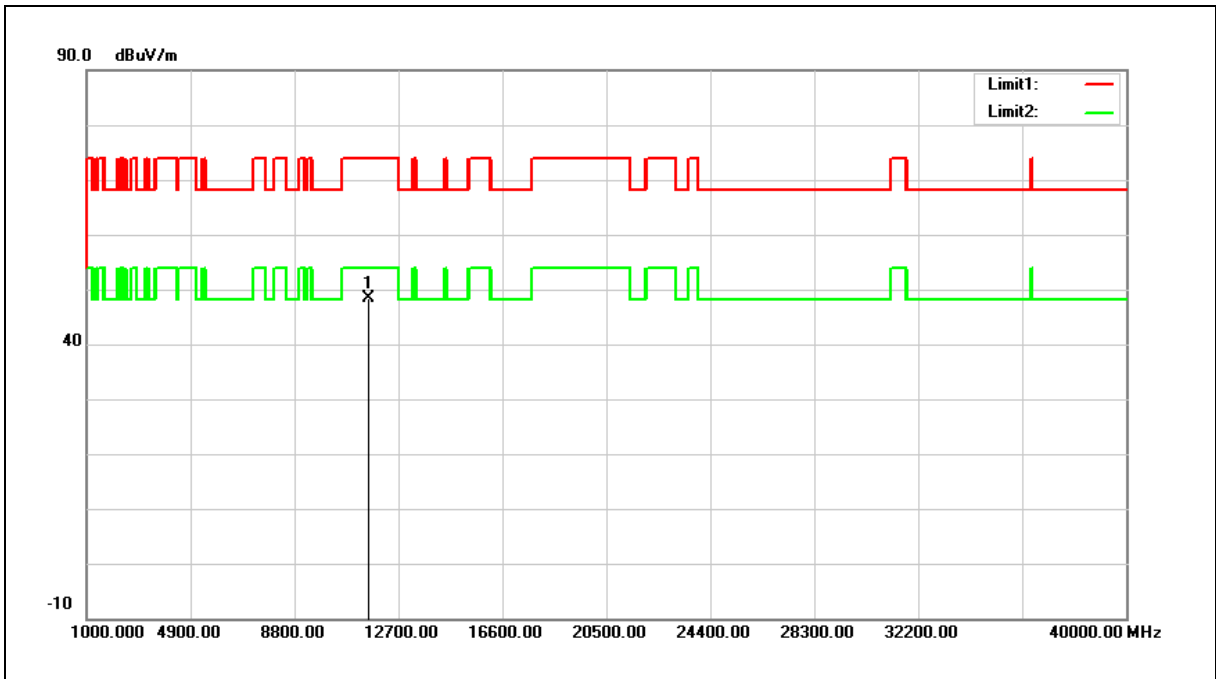

No.	Frequency (MHz)	Reading (dBuV)	Correct Factor (dB/m)	Result (dBuV/m)	Limit (dBuV/m)	Margin (dB)	Remark
1	11590.000	30.35	18.00	48.35	74.00	-25.65	peak

Note:1.Result (dBuV/m) = Correct Factor (dB/m) + Reading(dBuV).

2.Correction factor (dB/m) = Antenna Factor (dB/m) + Cable loss (dB) – Pre-Amplifier gain (dB).

3.When the peak results are less than average limit, so not need to evaluate the average.



Standard:	FCC Part 15.407	Test Distance:	3m
Test item:	Harmonic	Power:	AC 120V/60Hz
Frequency:	5795MHz	Temp.(°C)/Hum.(%RH):	26(°C)/60%RH
Mode:	Mode 4		
Ant.Polar.:	Vertical		

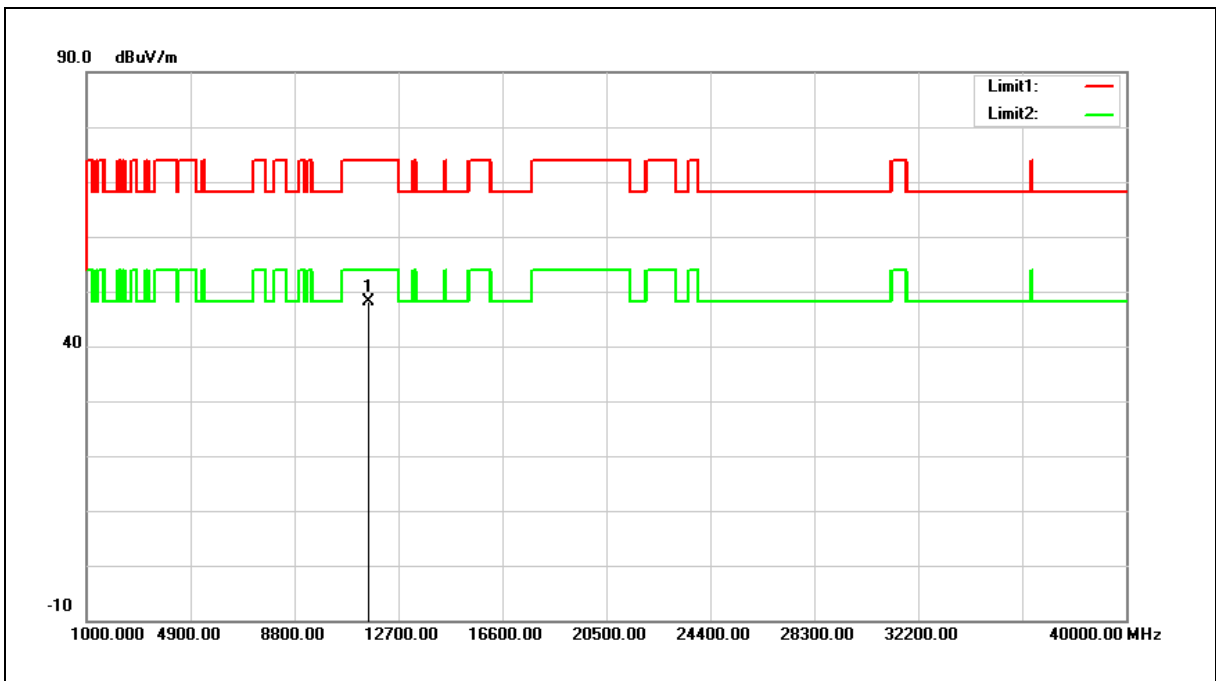

No.	Frequency (MHz)	Reading (dBuV)	Correct Factor (dB/m)	Result (dBuV/m)	Limit (dBuV/m)	Margin (dB)	Remark
1	11590.000	30.07	18.00	48.07	74.00	-25.93	peak

- Note:1.Result (dBuV/m) = Correct Factor (dB/m) + Reading(dBuV).
 2.Correction factor (dB/m) = Antenna Factor (dB/m) + Cable loss (dB) – Pre-Amplifier gain (dB).
 3.When the peak results are less than average limit, so not need to evaluate the average.



Standard:	FCC Part 15.407	Test Distance:	3m
Test item:	Harmonic	Power:	AC 120V/60Hz
Frequency:	5210MHz	Temp.(°C)/Hum.(%RH):	26(°C)/60%RH
Mode:	Mode 5		
Ant.Polar.:	Horizontal		

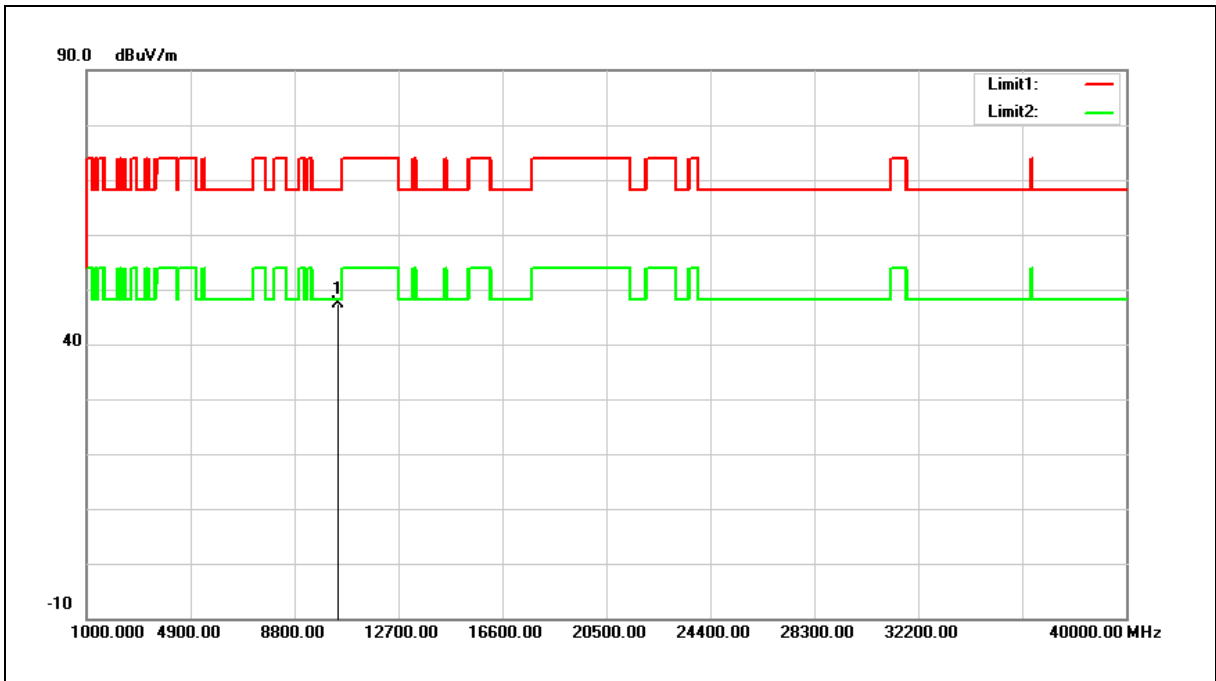

No.	Frequency (MHz)	Reading (dBuV)	Correct Factor (dB/m)	Result (dBuV/m)	Limit (dBuV/m)	Margin (dB)	Remark
1	10420.000	31.10	16.28	47.38	68.20	-20.82	peak

Note:1.Result (dBuV/m) = Correct Factor (dB/m) + Reading(dBuV).

2.Correction factor (dB/m) = Antenna Factor (dB/m) + Cable loss (dB) – Pre-Amplifier gain (dB).

3.When the peak results are less than average limit, so not need to evaluate the average.



Standard:	FCC Part 15.407	Test Distance:	3m
Test item:	Harmonic	Power:	AC 120V/60Hz
Frequency:	5210MHz	Temp.(°C)/Hum.(%RH):	26(°C)/60%RH
Mode:	Mode 5		
Ant.Polar.:	Vertical		

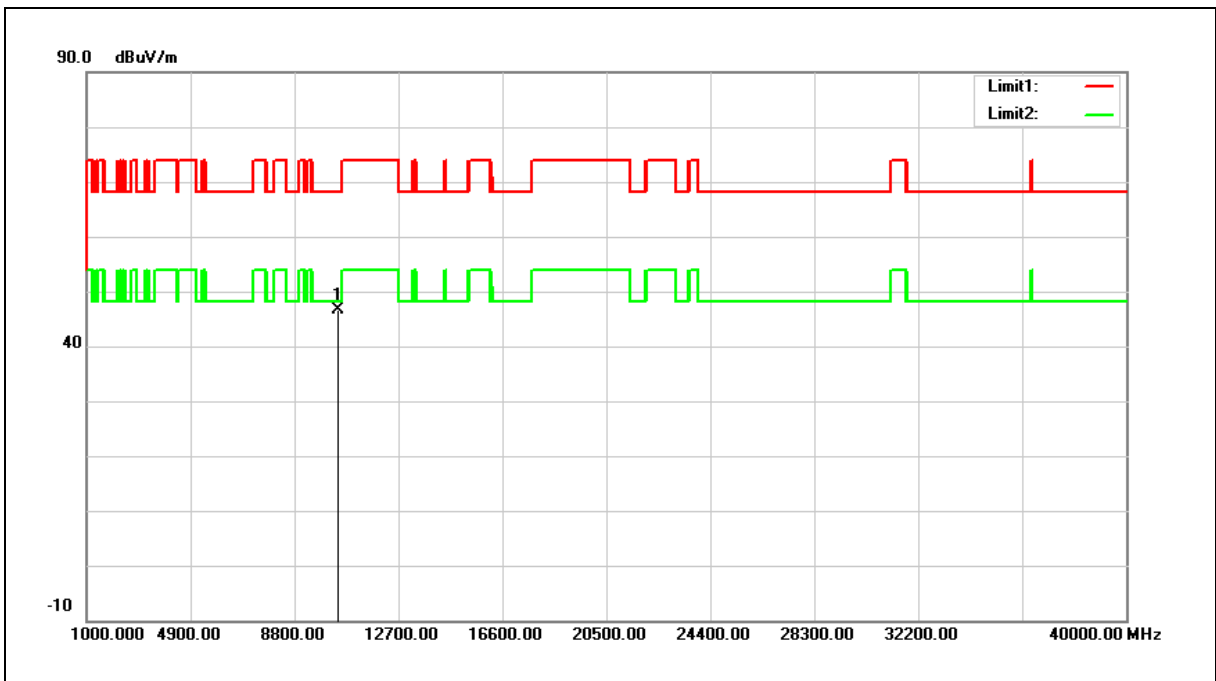

No.	Frequency (MHz)	Reading (dBuV)	Correct Factor (dB/m)	Result (dBuV/m)	Limit (dBuV/m)	Margin (dB)	Remark
1	10420.000	30.25	16.28	46.53	68.20	-21.67	peak

Note:1.Result (dBuV/m) = Correct Factor (dB/m) + Reading(dBuV).

2.Correction factor (dB/m) = Antenna Factor (dB/m) + Cable loss (dB) – Pre-Amplifier gain (dB).

3.When the peak results are less than average limit, so not need to evaluate the average.



Standard:	FCC Part 15.407	Test Distance:	3m
Test item:	Harmonic	Power:	AC 120V/60Hz
Frequency:	5775MHz	Temp.(°C)/Hum.(%RH):	26(°C)/60%RH
Mode:	Mode 5		
Ant.Polar.:	Horizontal		

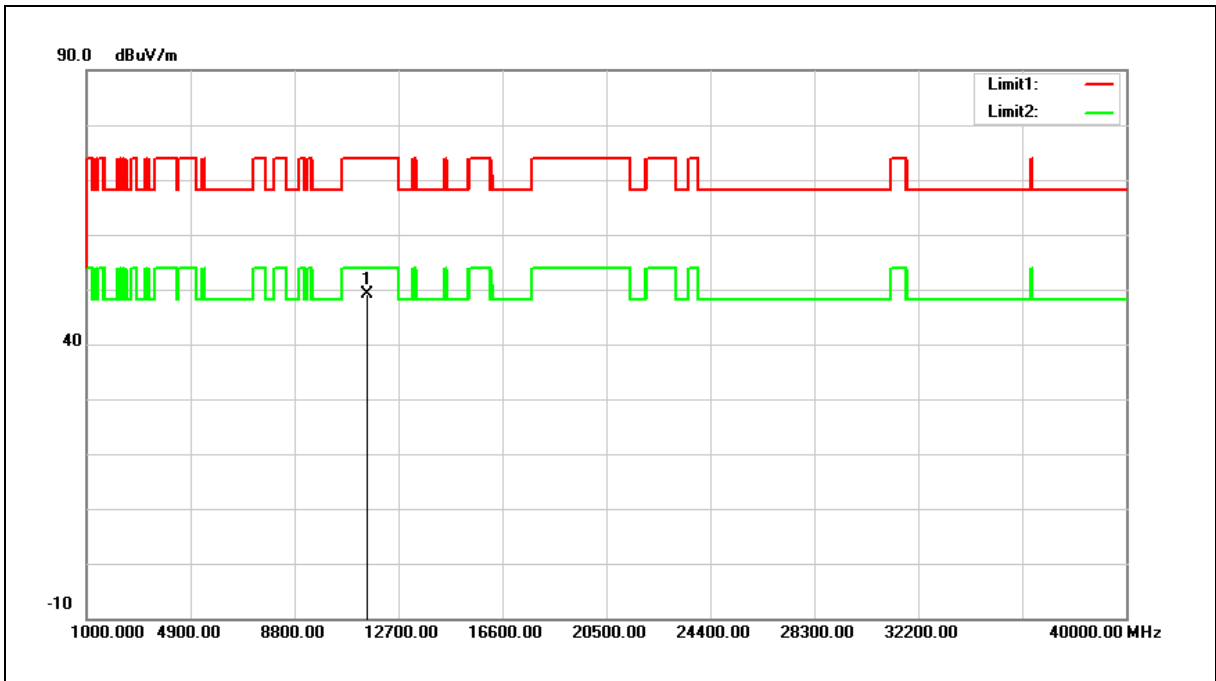

No.	Frequency (MHz)	Reading (dBuV)	Correct Factor (dB/m)	Result (dBuV/m)	Limit (dBuV/m)	Margin (dB)	Remark
1	11550.000	31.10	18.06	49.16	74.00	-24.84	peak

Note:1.Result (dBuV/m) = Correct Factor (dB/m) + Reading(dBuV).

2.Correction factor (dB/m) = Antenna Factor (dB/m) + Cable loss (dB) – Pre-Amplifier gain (dB).

3.When the peak results are less than average limit, so not need to evaluate the average.



Standard:	FCC Part 15.407	Test Distance:	3m
Test item:	Harmonic	Power:	AC 120V/60Hz
Frequency:	5775MHz	Temp.(°C)/Hum.(%RH):	26(°C)/60%RH
Mode:	Mode 5		
Ant.Polar.:	Vertical		

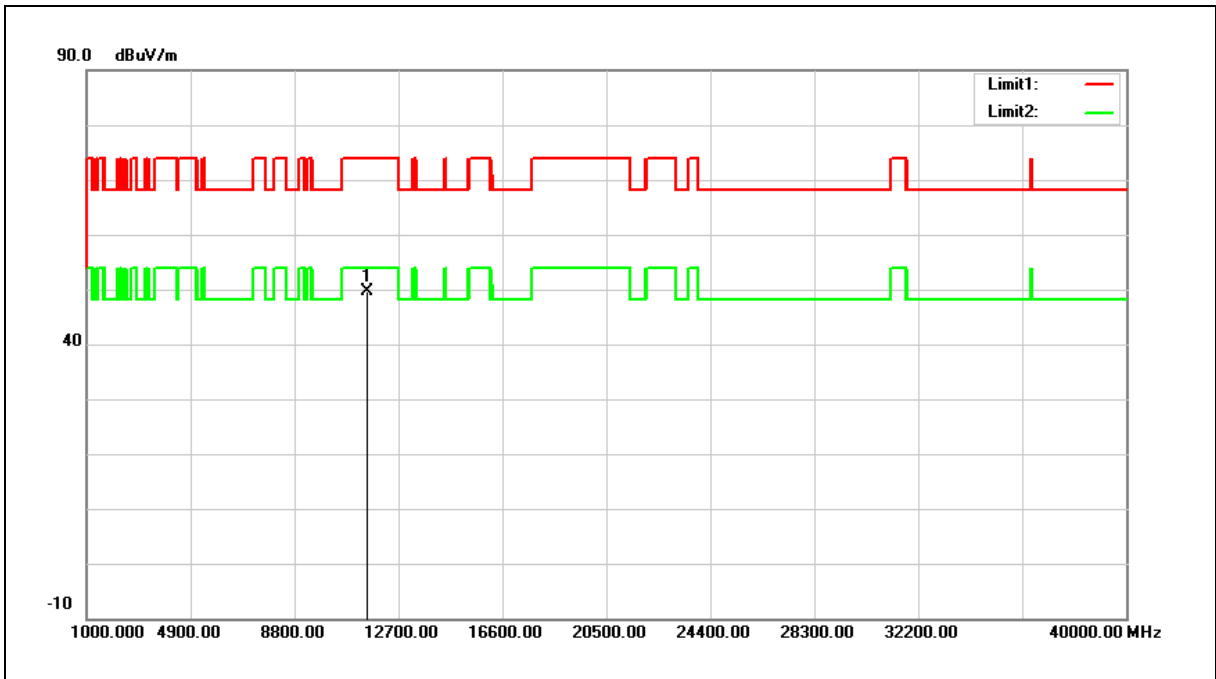

No.	Frequency (MHz)	Reading (dBuV)	Correct Factor (dB/m)	Result (dBuV/m)	Limit (dBuV/m)	Margin (dB)	Remark
1	11550.000	31.45	18.06	49.51	74.00	-24.49	peak

Note:1.Result (dBuV/m) = Correct Factor (dB/m) + Reading(dBuV).

2.Correction factor (dB/m) = Antenna Factor (dB/m) + Cable loss (dB) – Pre-Amplifier gain (dB).

3.When the peak results are less than average limit, so not need to evaluate the average.



Standard:	FCC Part 15.407	Test Distance:	3m
Test item:	Transmitter Unwanted Emissions	Power:	AC 120V/60Hz
Test Mode:	Simultaneous Transmitting (DTS+NII)	Temp.(°C)/Hum.(%RH):	26(°C)/60%RH
Ant.Polar.:	Horizontal		

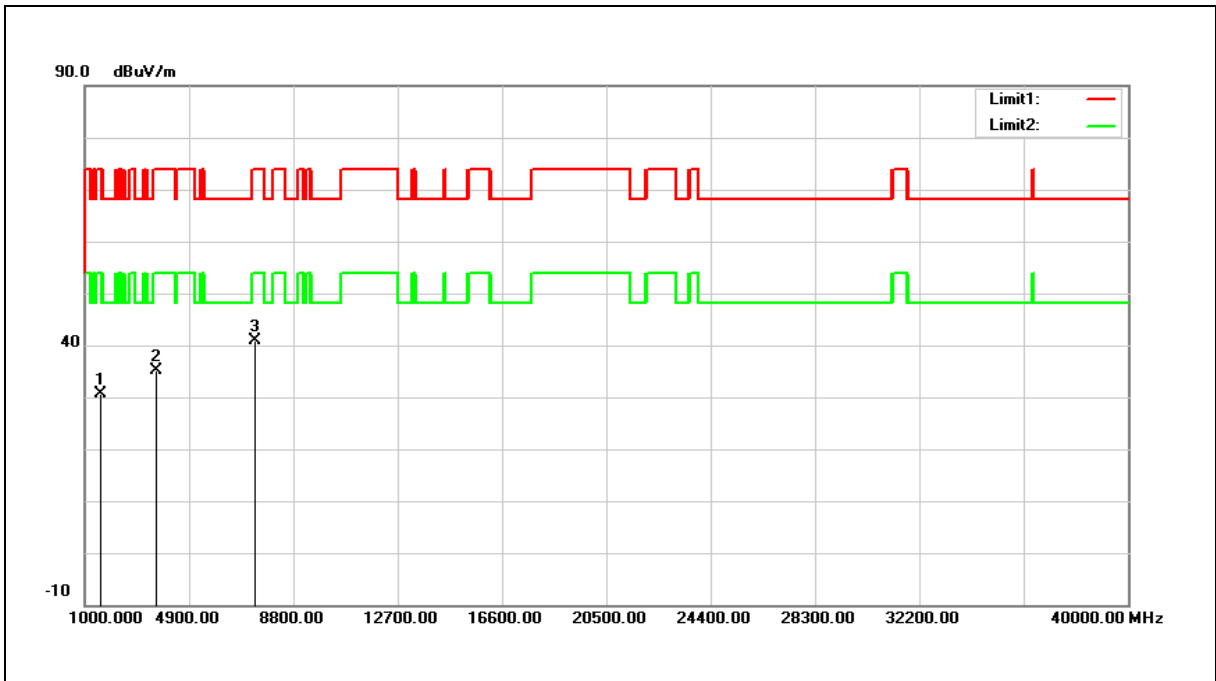

No.	Frequency (MHz)	Reading (dBuV)	Correct Factor (dB/m)	Result (dBuV/m)	Limit (dBuV/m)	Margin (dB)	Remark
1	1561.000	36.07	-5.35	30.72	74.00	-43.28	peak
2	3703.000	33.33	1.70	35.03	74.00	-38.97	peak
3	7341.000	29.23	11.54	40.77	74.00	-33.23	peak

Note:1.Result (dBuV/m) = Correct Factor (dB/m) + Reading(dBuV).

2.Correction factor (dB/m) = Antenna Factor (dB/m) + Cable loss (dB) – Pre-Amplifier gain (dB).

3. When the peak results are less than average limit, so not need to evaluate the average.



Standard:	FCC Part 15.407	Test Distance:	3m
Test item:	Transmitter Unwanted Emissions	Power:	AC 120V/60Hz
Test Mode:	Simultaneous Transmitting (DTS+NII)	Temp.(°C)/Hum.(%RH):	26(°C)/60%RH
Ant.Polar.:	Vertical		

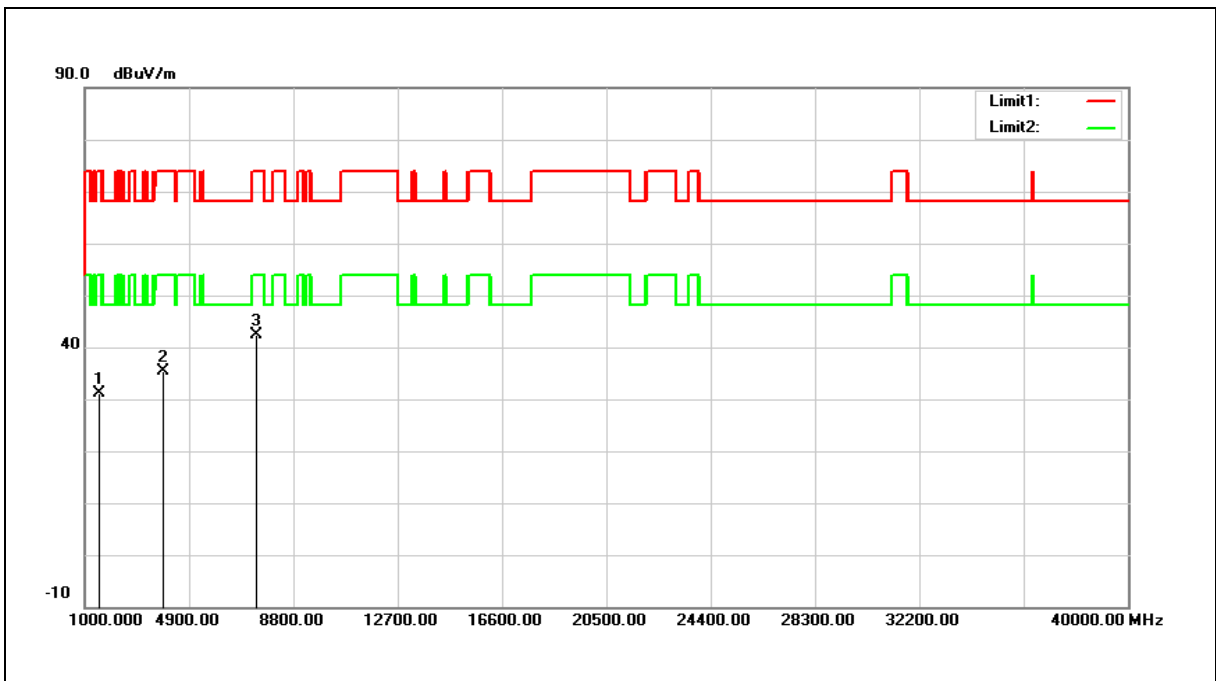

No.	Frequency (MHz)	Reading (dBuV)	Correct Factor (dB/m)	Result (dBuV/m)	Limit (dBuV/m)	Margin (dB)	Remark
1	1527.000	36.74	-5.51	31.23	74.00	-42.77	peak
2	3958.000	32.82	2.47	35.29	74.00	-38.71	peak
3	7409.000	30.68	11.71	42.39	74.00	-31.61	peak

Note:1.Result (dBuV/m) = Correct Factor (dB/m) + Reading(dBuV).

2.Correction factor (dB/m) = Antenna Factor (dB/m) + Cable loss (dB) – Pre-Amplifier gain (dB).

3. When the peak results are less than average limit, so not need to evaluate the average.



Band Edge

Standard:	FCC Part 15.407	Test Distance:	3m
Test item:	Band edge	Power:	AC 120V/60Hz
Frequency:	5180MHz	Temp.(°C)/Hum.(%RH):	26(°C)/60%RH
Mode:	Mode 3		
Ant.Polar.:	Horizontal		

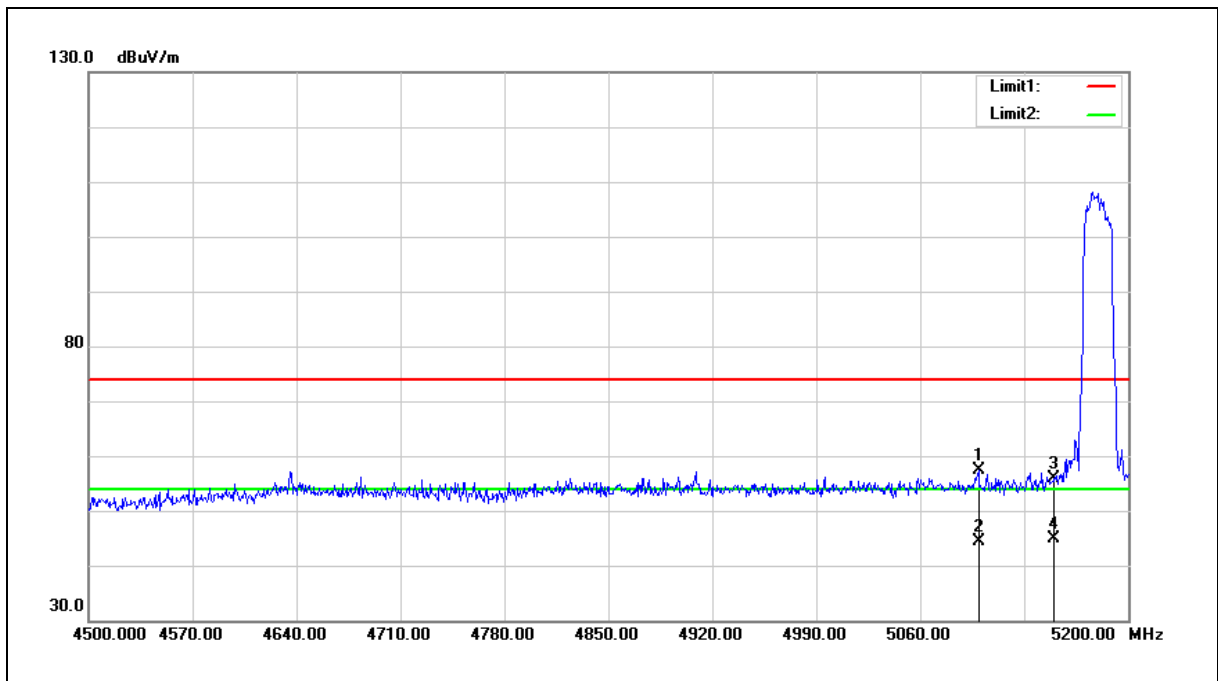

No.	Frequency (MHz)	Reading (dBuV)	Correct Factor (dB/m)	Result (dBuV/m)	Limit (dBuV/m)	Margin (dB)	Remark
1	5099.200	51.72	5.69	57.41	74.00	-16.59	peak
2	5099.200	38.58	5.69	44.27	54.00	-9.73	AVG
3	5150.000	50.16	5.78	55.94	74.00	-18.06	peak
4	5150.000	39.20	5.78	44.98	54.00	-9.02	AVG

Note:1.Result (dBuV/m) = Correct Factor (dB/m) + Reading(dBuV).

2.Correction factor (dB/m) = Antenna Factor (dB/m) + Cable loss (dB) – Pre-Amplifier gain (dB).

3.When the peak results are less than average limit, so not need to evaluate the average.



Standard:	FCC Part 15.407	Test Distance:	3m
Test item:	Band edge	Power:	AC 120V/60Hz
Frequency:	5180MHz	Temp.(°C)/Hum.(%RH):	26(°C)/60%RH
Mode:	Mode 3		
Ant.Polar.:	Vertical		

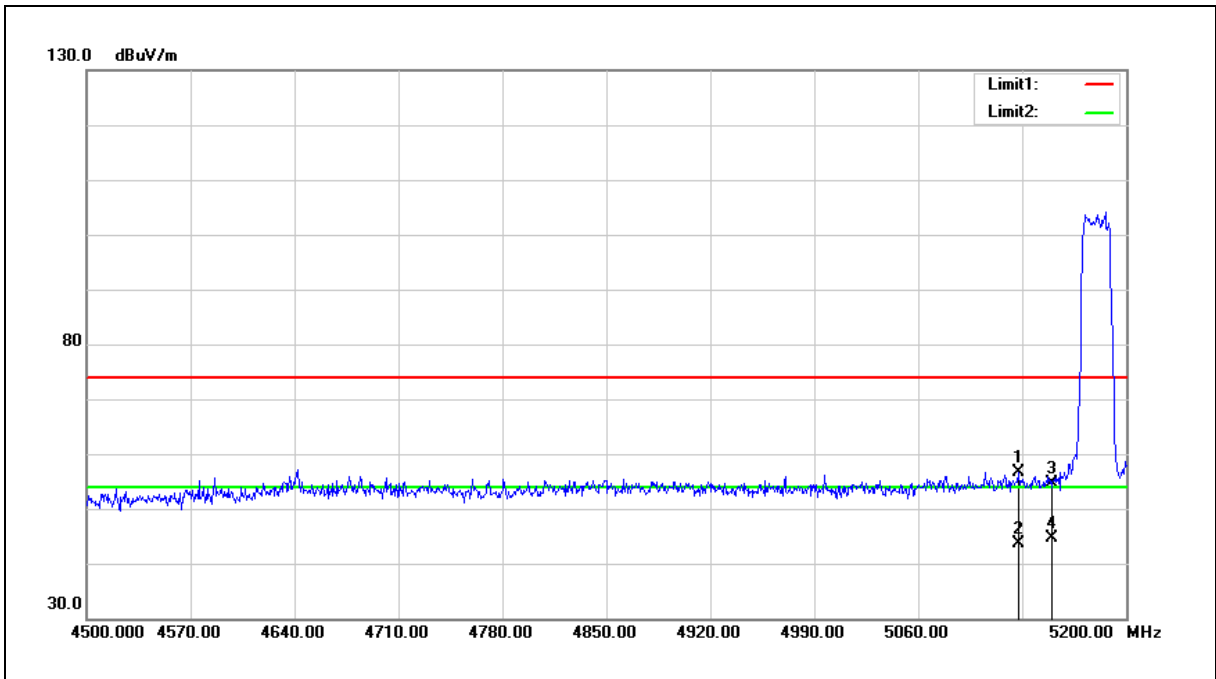

No.	Frequency (MHz)	Reading (dBuV)	Correct Factor (dB/m)	Result (dBuV/m)	Limit (dBuV/m)	Margin (dB)	Remark
1	5127.200	50.98	5.75	56.73	74.00	-17.27	peak
2	5127.200	37.98	5.75	43.73	54.00	-10.27	AVG
3	5150.000	48.83	5.78	54.61	74.00	-19.39	peak
4	5150.000	38.96	5.78	44.74	54.00	-9.26	AVG

Note:1.Result (dBuV/m) = Correct Factor (dB/m) + Reading(dBuV).

2.Correction factor (dB/m) = Antenna Factor (dB/m) + Cable loss (dB) – Pre-Amplifier gain (dB).

3.When the peak results are less than average limit, so not need to evaluate the average.



Standard:	FCC Part 15.407	Test Distance:	3m
Test item:	Band edge	Power:	AC 120V/60Hz
Frequency:	5200MHz	Temp.(°C)/Hum.(%RH):	26(°C)/60%RH
Mode:	Mode 3		
Ant.Polar.:	Horizontal		

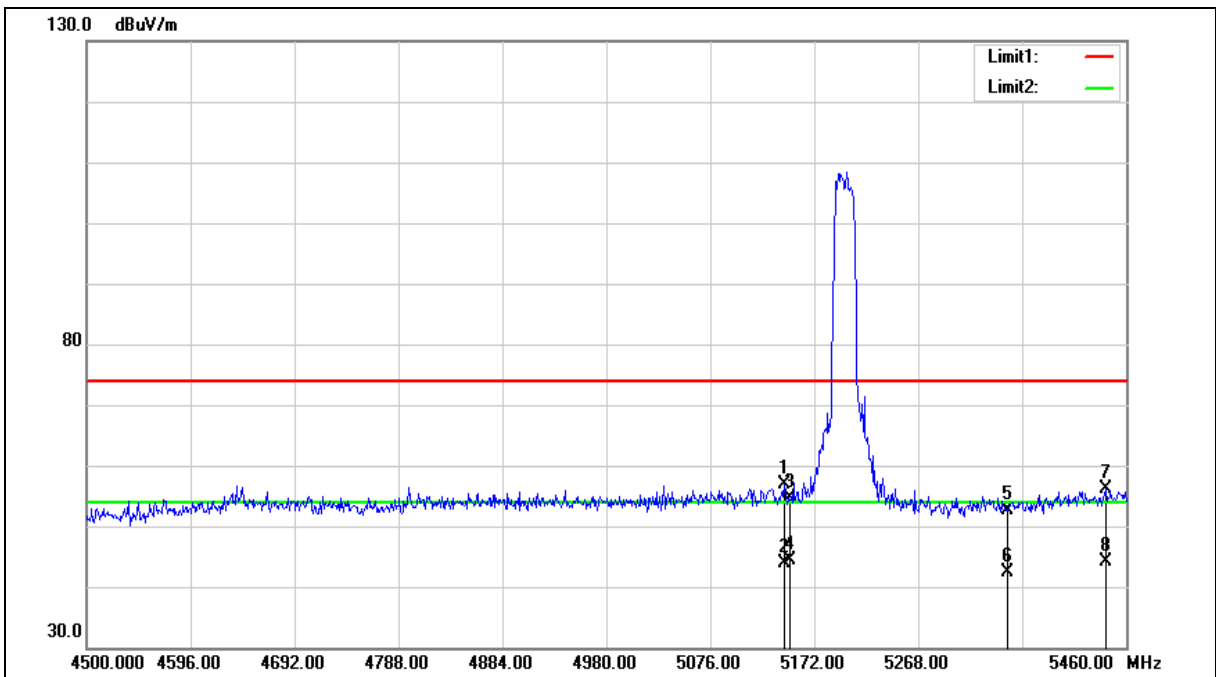



Standard:	FCC Part 15.407	Test Distance:	3m
Test item:	Band edge	Power:	AC 120V/60Hz
Frequency:	5200MHz	Temp.(°C)/Hum.(%RH):	26(°C)/60%RH
Mode:	Mode 3		
Ant.Polar.:	Horizontal		

No.	Frequency (MHz)	Reading (dBuV)	Correct Factor (dB/m)	Result (dBuV/m)	Limit (dBuV/m)	Margin (dB)	Remark
1	5144.160	51.23	5.77	57.00	74.00	-17.00	peak
2	5144.160	38.13	5.77	43.90	54.00	-10.10	AVG
3	5150.000	48.76	5.78	54.54	74.00	-19.46	peak
4	5150.000	38.52	5.78	44.30	54.00	-9.70	AVG
5	5350.000	46.55	6.07	52.62	74.00	-21.38	peak
6	5350.000	36.38	6.07	42.45	54.00	-11.55	AVG
7	5441.760	49.88	6.21	56.09	74.00	-17.91	peak
8	5441.760	37.91	6.21	44.12	54.00	-9.88	AVG

Note:1.Result (dBuV/m) = Correct Factor (dB/m) + Reading(dBuV).

2.Correction factor (dB/m) = Antenna Factor (dB/m) + Cable loss (dB) – Pre-Amplifier gain (dB).

3.When the peak results are less than average limit, so not need to evaluate the average.



Standard:	FCC Part 15.407	Test Distance:	3m
Test item:	Band edge	Power:	AC 120V/60Hz
Frequency:	5200MHz	Temp.(°C)/Hum.(%RH):	26(°C)/60%RH
Mode:	Mode 3		
Ant.Polar.:	Vertical		

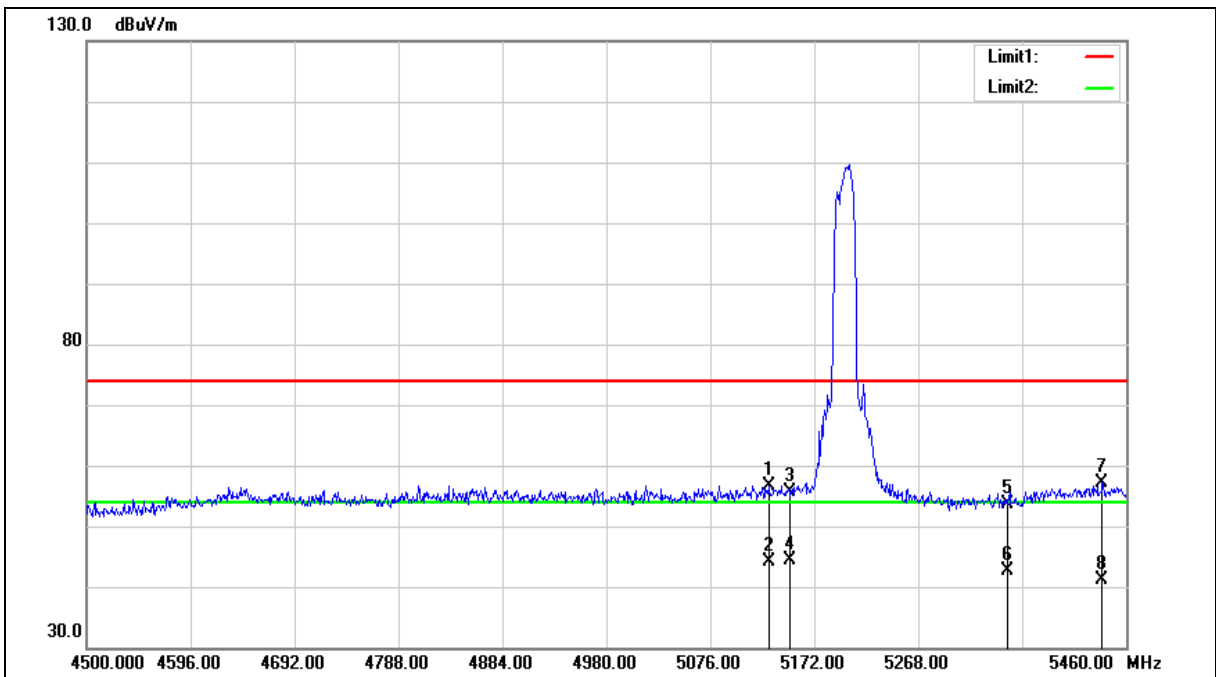



Standard:	FCC Part 15.407	Test Distance:	3m
Test item:	Band edge	Power:	AC 120V/60Hz
Frequency:	5200MHz	Temp.(°C)/Hum.(%RH):	26(°C)/60%RH
Mode:	Mode 3		
Ant.Polar.:	Vertical		

No.	Frequency (MHz)	Reading (dBuV)	Correct Factor (dB/m)	Result (dBuV/m)	Limit (dBuV/m)	Margin (dB)	Remark
1	5129.760	50.93	5.75	56.68	74.00	-17.32	peak
2	5129.760	38.28	5.75	44.03	54.00	-9.97	AVG
3	5150.000	49.83	5.78	55.61	74.00	-18.39	peak
4	5150.000	38.64	5.78	44.42	54.00	-9.58	AVG
5	5350.000	47.62	6.07	53.69	74.00	-20.31	peak
6	5350.000	36.56	6.07	42.63	54.00	-11.37	AVG
7	5437.920	50.91	6.20	57.11	74.00	-16.89	peak
8	5437.920	34.84	6.20	41.04	54.00	-12.96	AVG

Note:1.Result (dBuV/m) = Correct Factor (dB/m) + Reading(dBuV).

2.Correction factor (dB/m) = Antenna Factor (dB/m) + Cable loss (dB) – Pre-Amplifier gain (dB).

3.When the peak results are less than average limit, so not need to evaluate the average.



Standard:	FCC Part 15.407	Test Distance:	3m
Test item:	Band edge	Power:	AC 120V/60Hz
Frequency:	5240MHz	Temp.(°C)/Hum.(%RH):	26(°C)/60%RH
Mode:	Mode 3		
Ant.Polar.:	Horizontal		

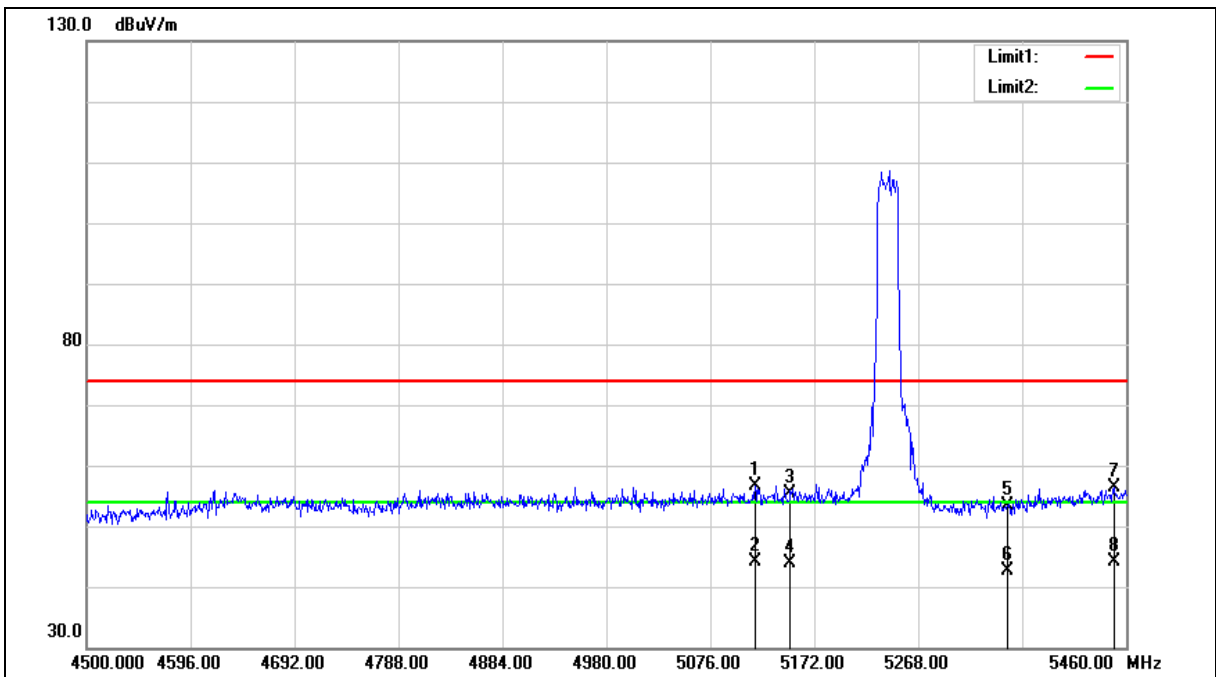



Standard:	FCC Part 15.407	Test Distance:	3m
Test item:	Band edge	Power:	AC 120V/60Hz
Frequency:	5240MHz	Temp.(°C)/Hum.(%RH):	26(°C)/60%RH
Mode:	Mode 3		
Ant.Polar.:	Horizontal		

No.	Frequency (MHz)	Reading (dBuV)	Correct Factor (dB/m)	Result (dBuV/m)	Limit (dBuV/m)	Margin (dB)	Remark
1	5117.280	51.01	5.73	56.74	74.00	-17.26	peak
2	5117.280	38.43	5.73	44.16	54.00	-9.84	AVG
3	5150.000	49.52	5.78	55.30	74.00	-18.70	peak
4	5150.000	37.98	5.78	43.76	54.00	-10.24	AVG
5	5350.000	47.24	6.07	53.31	74.00	-20.69	peak
6	5350.000	36.54	6.07	42.61	54.00	-11.39	AVG
7	5448.480	50.11	6.22	56.33	74.00	-17.67	peak
8	5448.480	37.82	6.22	44.04	54.00	-9.96	AVG

Note:1.Result (dBuV/m) = Correct Factor (dB/m) + Reading(dBuV).

2.Correction factor (dB/m) = Antenna Factor (dB/m) + Cable loss (dB) – Pre-Amplifier gain (dB).

3.When the peak results are less than average limit, so not need to evaluate the average.



Standard:	FCC Part 15.407	Test Distance:	3m
Test item:	Band edge	Power:	AC 120V/60Hz
Frequency:	5240MHz	Temp.(°C)/Hum.(%RH):	26(°C)/60%RH
Mode:	Mode 3		
Ant.Polar.:	Vertical		

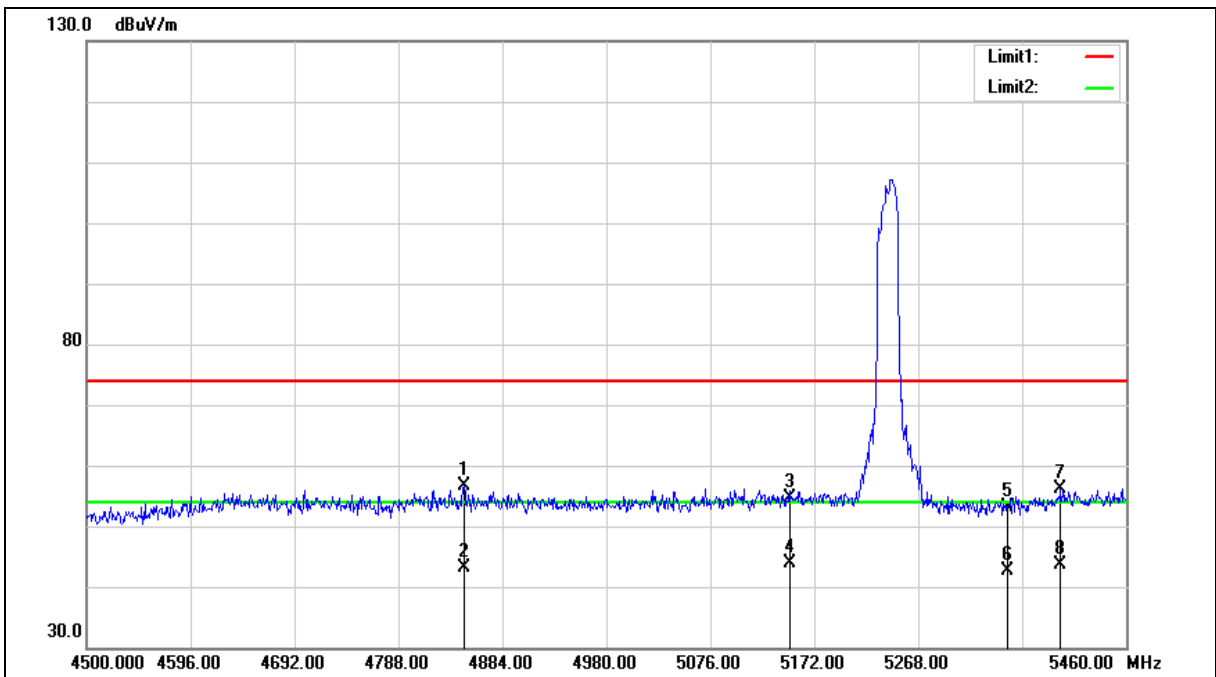



Standard:	FCC Part 15.407	Test Distance:	3m
Test item:	Band edge	Power:	AC 120V/60Hz
Frequency:	5240MHz	Temp.(°C)/Hum.(%RH):	26(°C)/60%RH
Mode:	Mode 3		
Ant.Polar.:	Vertical		

No.	Frequency (MHz)	Reading (dBuV)	Correct Factor (dB/m)	Result (dBuV/m)	Limit (dBuV/m)	Margin (dB)	Remark
1	4848.480	51.60	5.07	56.67	74.00	-17.33	peak
2	4848.480	38.12	5.07	43.19	54.00	-10.81	AVG
3	5150.000	48.93	5.78	54.71	74.00	-19.29	peak
4	5150.000	38.00	5.78	43.78	54.00	-10.22	AVG
5	5350.000	47.02	6.07	53.09	74.00	-20.91	peak
6	5350.000	36.68	6.07	42.75	54.00	-11.25	AVG
7	5399.520	49.90	6.15	56.05	74.00	-17.95	peak
8	5399.520	37.37	6.15	43.52	54.00	-10.48	AVG

Note:1.Result (dBuV/m) = Correct Factor (dB/m) + Reading(dBuV).

2.Correction factor (dB/m) = Antenna Factor (dB/m) + Cable loss (dB) – Pre-Amplifier gain (dB).

3.When the peak results are less than average limit, so not need to evaluate the average.



Standard:	FCC Part 15.407	Test Distance:	3m
Test item:	Band edge	Power:	AC 120V/60Hz
Frequency:	5745MHz	Temp.(°C)/Hum.(%RH):	26(°C)/60%RH
Mode:	Mode 3		
Ant.Polar.:	Horizontal		

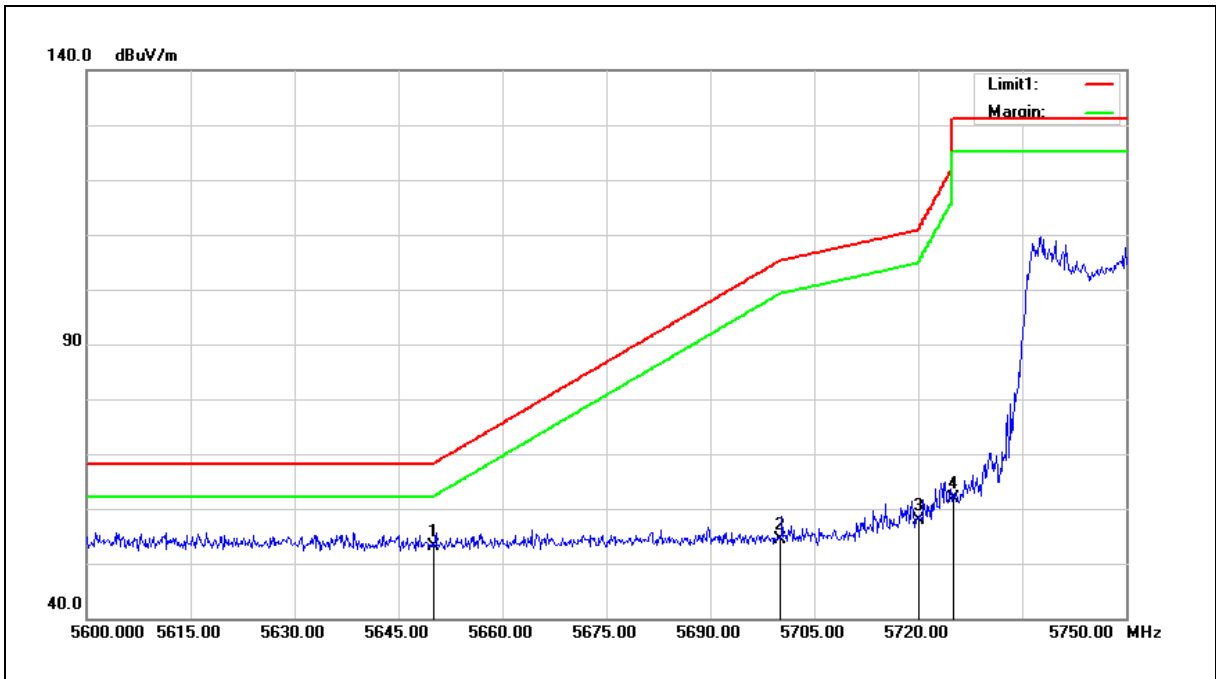

No.	Frequency (MHz)	Reading (dBuV)	Correct Factor (dB/m)	Result (dBuV/m)	Limit (dBuV/m)	Margin (dB)	Remark
1	5650.000	46.51	6.61	53.12	68.20	-15.08	peak
2	5700.000	47.69	6.71	54.40	105.20	-50.80	peak
3	5720.000	51.22	6.77	57.99	110.80	-52.81	peak
4	5725.000	55.19	6.78	61.97	122.20	-60.23	peak

Note:1.Result (dBuV/m) = Correct Factor (dB/m) + Reading(dBuV).

2.Correction factor (dB/m) = Antenna Factor (dB/m) + Cable loss (dB) – Pre-Amplifier gain (dB).

3.When the peak results are less than average limit, so not need to evaluate the average.



Standard:	FCC Part 15.407	Test Distance:	3m
Test item:	Band edge	Power:	AC 120V/60Hz
Frequency:	5745MHz	Temp.(°C)/Hum.(%RH):	26(°C)/60%RH
Mode:	Mode 3		
Ant.Polar.:	Vertical		

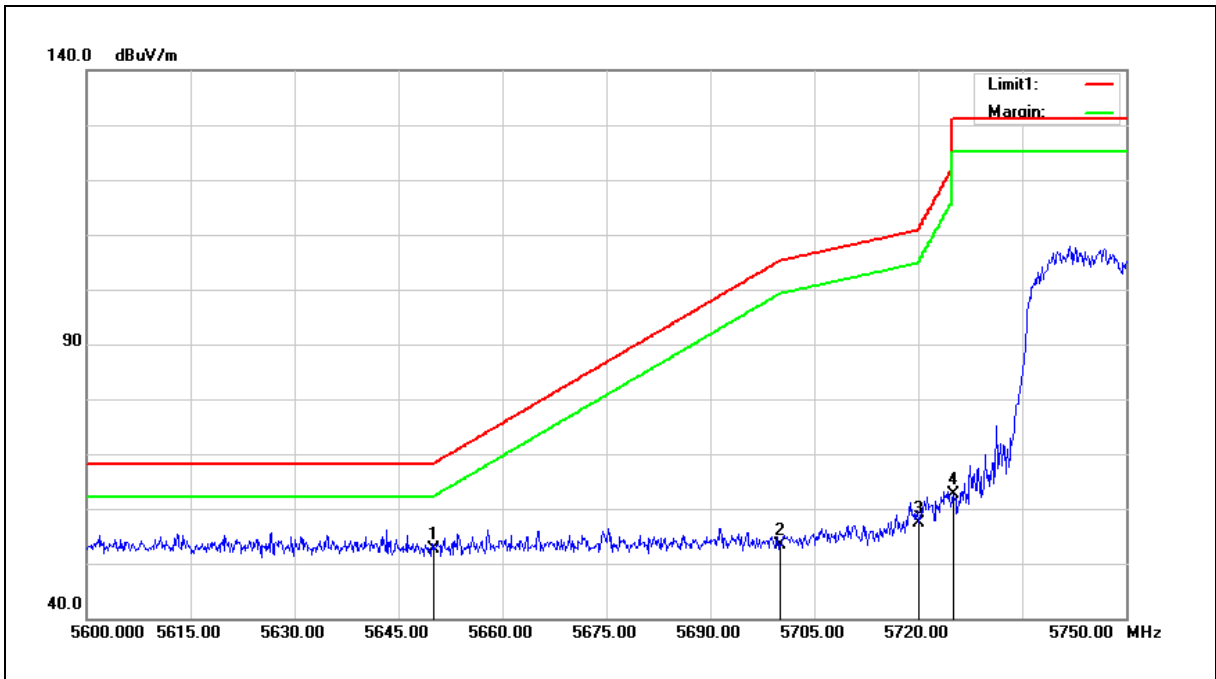

No.	Frequency (MHz)	Reading (dBuV)	Correct Factor (dB/m)	Result (dBuV/m)	Limit (dBuV/m)	Margin (dB)	Remark
1	5650.000	46.11	6.61	52.72	68.20	-15.48	peak
2	5700.000	46.56	6.71	53.27	105.20	-51.93	peak
3	5720.000	50.72	6.77	57.49	110.80	-53.31	peak
4	5725.000	55.84	6.78	62.62	122.20	-59.58	peak

Note:1.Result (dBuV/m) = Correct Factor (dB/m) + Reading(dBuV).

2.Correction factor (dB/m) = Antenna Factor (dB/m) + Cable loss (dB) – Pre-Amplifier gain (dB).

3.When the peak results are less than average limit, so not need to evaluate the average.



Standard:	FCC Part 15.407	Test Distance:	3m
Test item:	Band edge	Power:	AC 120V/60Hz
Frequency:	5785MHz	Temp.(°C)/Hum.(%RH):	26(°C)/60%RH
Mode:	Mode 3		
Ant.Polar.:	Horizontal		

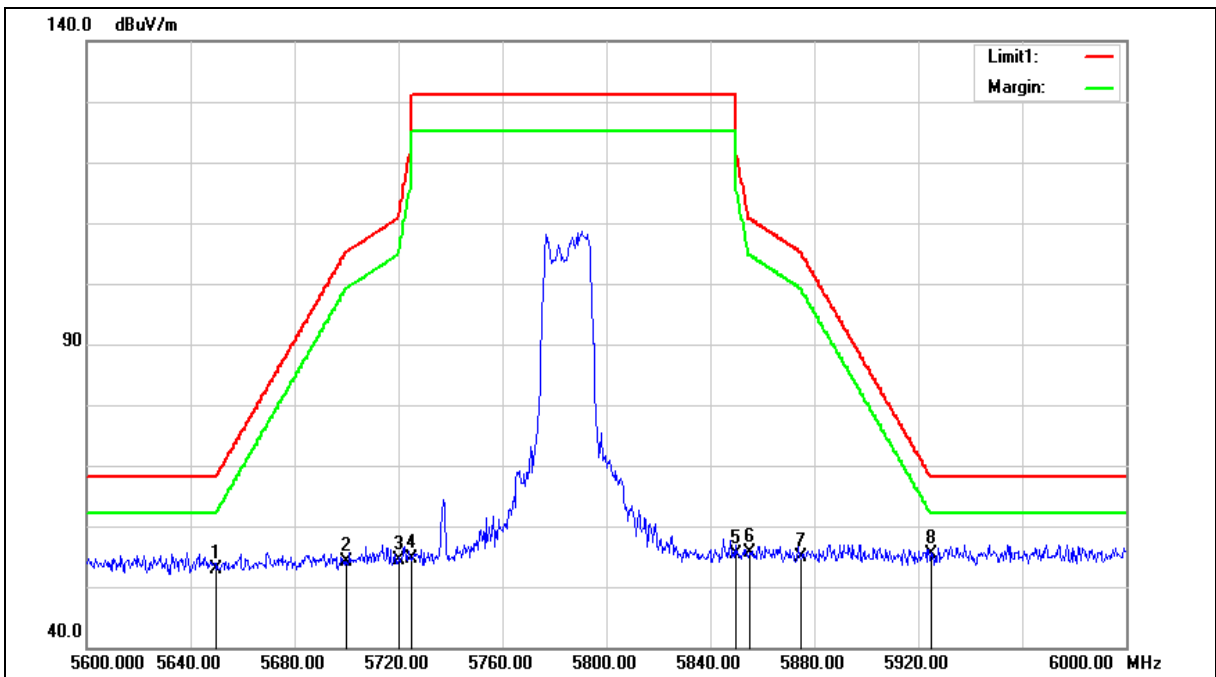



Standard:	FCC Part 15.407	Test Distance:	3m
Test item:	Band edge	Power:	AC 120V/60Hz
Frequency:	5785MHz	Temp.(°C)/Hum.(%RH):	26(°C)/60%RH
Mode:	Mode 3		
Ant.Polar.:	Horizontal		

No.	Frequency (MHz)	Reading (dBuV)	Correct Factor (dB/m)	Result (dBuV/m)	Limit (dBuV/m)	Margin (dB)	Remark
1	5650.000	46.28	6.61	52.89	68.20	-15.31	peak
2	5700.000	47.50	6.71	54.21	105.20	-50.99	peak
3	5720.000	47.52	6.77	54.29	110.80	-56.51	peak
4	5725.000	47.86	6.78	54.64	122.20	-67.56	peak
5	5850.000	48.25	7.03	55.28	122.20	-66.92	peak
6	5855.000	48.49	7.04	55.53	110.80	-55.27	peak
7	5875.000	47.82	7.09	54.91	105.20	-50.29	peak
8	5925.000	48.28	7.20	55.48	68.20	-12.72	peak

Note:1.Result (dBuV/m) = Correct Factor (dB/m) + Reading(dBuV).

2.Correction factor (dB/m) = Antenna Factor (dB/m) + Cable loss (dB) – Pre-Amplifier gain (dB).

3.When the peak results are less than average limit, so not need to evaluate the average.



Standard:	FCC Part 15.407	Test Distance:	3m
Test item:	Band edge	Power:	AC 120V/60Hz
Frequency:	5785MHz	Temp.(°C)/Hum.(%RH):	26(°C)/60%RH
Mode:	Mode 3		
Ant.Polar.:	Vertical		

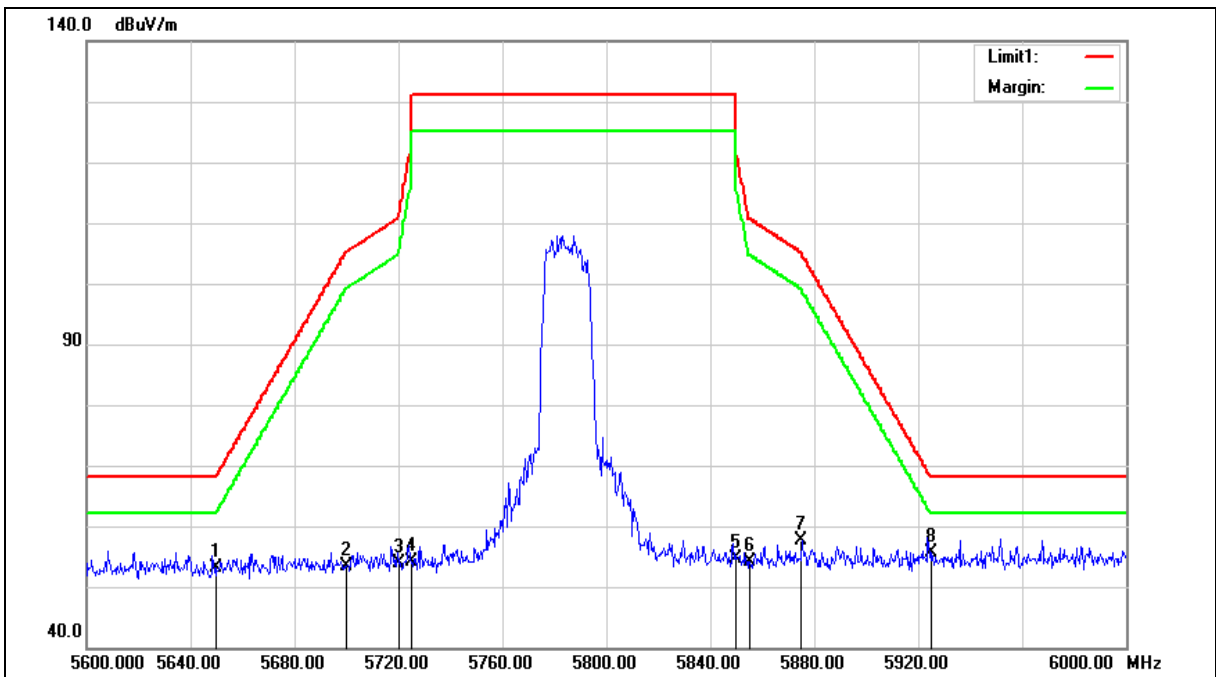



Standard:	FCC Part 15.407	Test Distance:	3m
Test item:	Band edge	Power:	AC 120V/60Hz
Frequency:	5785MHz	Temp.(°C)/Hum.(%RH):	26(°C)/60%RH
Mode:	Mode 3		
Ant.Polar.:	Vertical		

No.	Frequency (MHz)	Reading (dBuV)	Correct Factor (dB/m)	Result (dBuV/m)	Limit (dBuV/m)	Margin (dB)	Remark
1	5650.000	46.52	6.61	53.13	68.20	-15.07	peak
2	5700.000	46.78	6.71	53.49	105.20	-51.71	peak
3	5720.000	47.20	6.77	53.97	110.80	-56.83	peak
4	5725.000	47.27	6.78	54.05	122.20	-68.15	peak
5	5850.000	47.62	7.03	54.65	122.20	-67.55	peak
6	5855.000	47.16	7.04	54.20	110.80	-56.60	peak
7	5875.000	50.66	7.09	57.75	105.20	-47.45	peak
8	5925.000	48.49	7.20	55.69	68.20	-12.51	peak

Note:1.Result (dBuV/m) = Correct Factor (dB/m) + Reading(dBuV).

2.Correction factor (dB/m) = Antenna Factor (dB/m) + Cable loss (dB) – Pre-Amplifier gain (dB).

3.When the peak results are less than average limit, so not need to evaluate the average.



Standard:	FCC Part 15.407	Test Distance:	3m
Test item:	Band edge	Power:	AC 120V/60Hz
Frequency:	5825MHz	Temp.(°C)/Hum.(%RH):	26(°C)/60%RH
Mode:	Mode 3		
Ant.Polar.:	Horizontal		

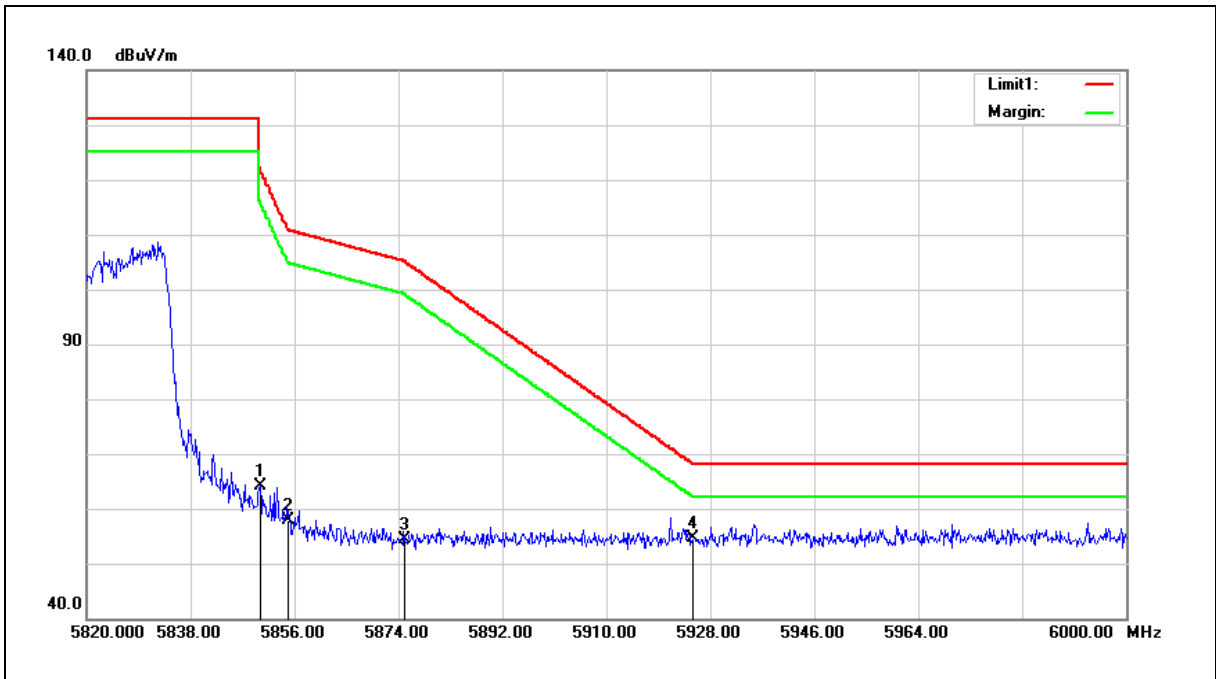

No.	Frequency (MHz)	Reading (dBuV)	Correct Factor (dB/m)	Result (dBuV/m)	Limit (dBuV/m)	Margin (dB)	Remark
1	5850.000	57.03	7.03	64.06	122.20	-58.14	peak
2	5855.000	50.86	7.04	57.90	110.80	-52.90	peak
3	5875.000	47.37	7.09	54.46	105.20	-50.74	peak
4	5925.000	47.35	7.20	54.55	68.20	-13.65	peak

Note:1.Result (dBuV/m) = Correct Factor (dB/m) + Reading(dBuV).

2.Correction factor (dB/m) = Antenna Factor (dB/m) + Cable loss (dB) – Pre-Amplifier gain (dB).

3.When the peak results are less than average limit, so not need to evaluate the average.



Standard:	FCC Part 15.407	Test Distance:	3m
Test item:	Band edge	Power:	AC 120V/60Hz
Frequency:	5825MHz	Temp.(°C)/Hum.(%RH):	26(°C)/60%RH
Mode:	Mode 3		
Ant.Polar.:	Vertical		

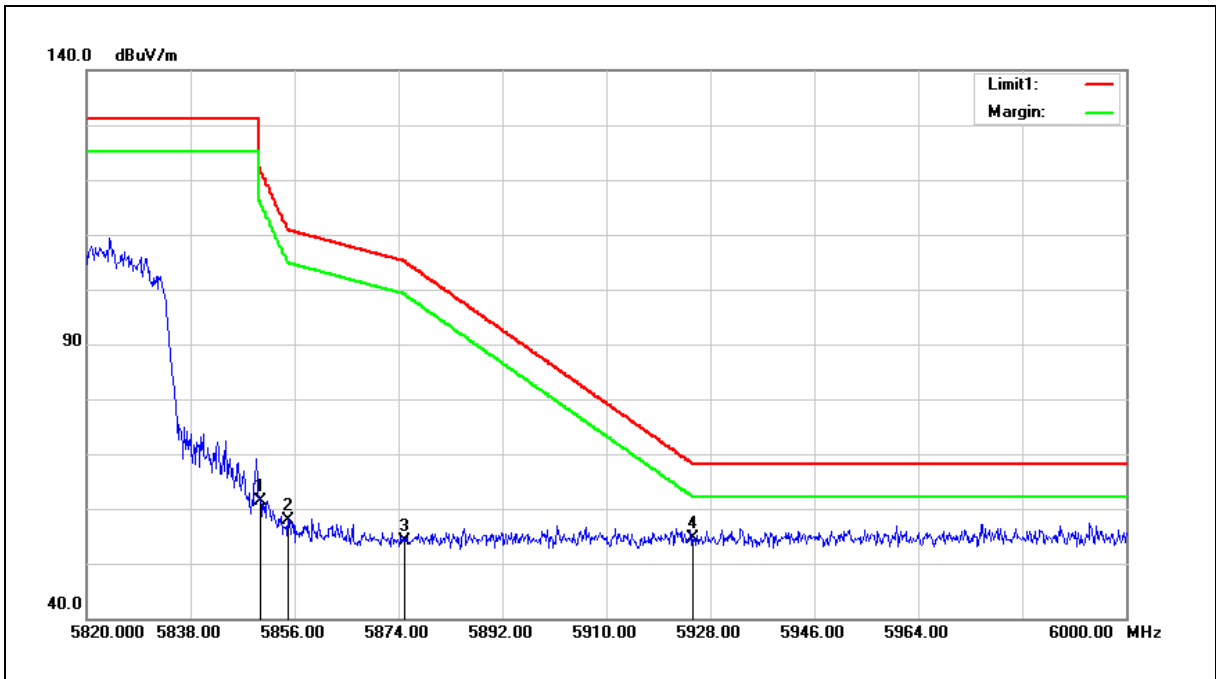

No.	Frequency (MHz)	Reading (dBuV)	Correct Factor (dB/m)	Result (dBuV/m)	Limit (dBuV/m)	Margin (dB)	Remark
1	5850.000	54.25	7.03	61.28	122.20	-60.92	peak
2	5855.000	50.88	7.04	57.92	110.80	-52.88	peak
3	5875.000	47.16	7.09	54.25	105.20	-50.95	peak
4	5925.000	47.52	7.20	54.72	68.20	-13.48	peak

Note:1.Result (dBuV/m) = Correct Factor (dB/m) + Reading(dBuV).

2.Correction factor (dB/m) = Antenna Factor (dB/m) + Cable loss (dB) – Pre-Amplifier gain (dB).

3.When the peak results are less than average limit, so not need to evaluate the average.



Standard:	FCC Part 15.407	Test Distance:	3m
Test item:	Band edge	Power:	AC 120V/60Hz
Frequency:	5190MHz	Temp.(°C)/Hum.(%RH):	26(°C)/60%RH
Mode:	Mode 4		
Ant.Polar.:	Horizontal		

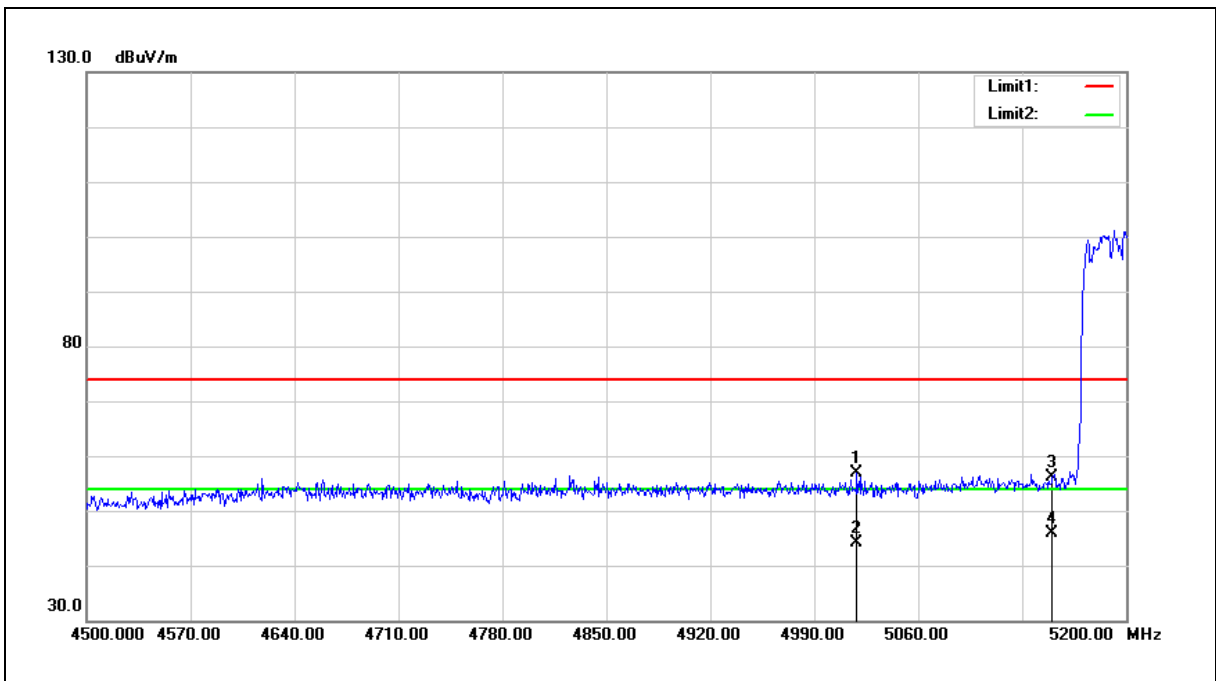

No.	Frequency (MHz)	Reading (dBuV)	Correct Factor (dB/m)	Result (dBuV/m)	Limit (dBuV/m)	Margin (dB)	Remark
1	5018.700	51.21	5.58	56.79	74.00	-17.21	peak
2	5018.700	38.53	5.58	44.11	54.00	-9.89	AVG
3	5150.000	50.46	5.78	56.24	74.00	-17.76	peak
4	5150.000	40.02	5.78	45.80	54.00	-8.20	AVG

Note:1.Result (dBuV/m) = Correct Factor (dB/m) + Reading(dBuV).

2.Correction factor (dB/m) = Antenna Factor (dB/m) + Cable loss (dB) – Pre-Amplifier gain (dB).

3.When the peak results are less than average limit, so not need to evaluate the average.