



# FCC RADIO TEST REPORT

## FCC ID:2AL6W-AC1200

**Product :** AC1200 Wifi Dual Band USB 3.0 Adapter

**Trade Mark :** N/A

**Model Name :** AC1200

**Serial Model :** N/A

**Report No. :** NTEK-2017NT03282292F2

### Prepared for

Patriot Memory LLC

11F, No. 700, Jhong Jheng Road., Jhong He District, New Taipei City  
23552, Taiwan

### Prepared by

Shenzhen NTEK Testing Technology Co., Ltd.

1/F, Building E, Fenda Science Park, Sanwei Community,  
Xixiang Street Bao'an District, Shenzhen 518126 P.R. China

Tel.: +86-755-6115 9388

Fax.: +86-755-6115 6599

Website:<http://www.ntek.org.cn>

## TEST RESULT CERTIFICATION

**Applicant's name** ..... : Patriot Memory LLC  
**Address** ..... : 11F, No. 700, Jhong Jheng Road., Jhong He District, New Taipei City , 23552, Taiwan  
**Manufacturer's Name**..... : SHENZHEN MTN ELECTRONICS CO.,LTD  
**Address** ..... : MTN Industrial Park, No.5, 9, FuTai Road, Pingxi community, Pingdi Street, Longgang District, Shenzhen

### Product description

**Product name**..... : AC1200 Wifi Dual Band USB 3.0 Adapter  
**Model and/or type reference** : AC1200  
**Serial Model** ..... : N/A

**Standards** ..... : FCC Part15.407: 01 Oct. 2015

**Test procedure** ..... ANSI C63.10-2013 and KDB 789033 D02 General UNII Test Procedures New Rules v01r01  
FCC KDB 662911 D01 Multiple Transmitter Output v02r01  
FCC KDB 662911 D02 MIMO With Cross Polarized Antenna V01

This device described above has been tested by NTEK, and the test results show that the equipment under test (EUT) is in compliance with the FCC requirements/ the Industry Canada requirements.. And it is applicable only to the tested sample identified in the report.

This report shall not be reproduced except in full, without the written approval of NTEK, this document may be altered or revised by NTEK, personnel only, and shall be noted in the revision of the document.

**Date of Test** .....

**Date (s) of performance of tests** ..... 28 Mar. 2017 ~ 23 May. 2017

**Date of Issue**..... 23 Mar. 2017

**Test Result**..... **Pass**

Testing Engineer : \_\_\_\_\_



(Allen Liu)

Technical Manager : \_\_\_\_\_

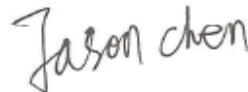

(Jason Chen)

Authorized Signatory : \_\_\_\_\_

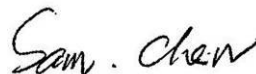

(Sam Chen)

**Table of Contents**

	<b>Page</b>
<b>1 . SUMMARY OF TEST RESULTS</b>	<b>5</b>
1.1 TEST FACILITY	6
1.2 MEASUREMENT UNCERTAINTY	6
<b>2 . GENERAL INFORMATION</b>	<b>7</b>
2.1 GENERAL DESCRIPTION OF EUT	7
2.2 DESCRIPTION OF TEST MODES	10
2.3 BLOCK DIGRAM SHOWING THE CONFIGURATION OF SYSTEM TESTED	11
2.4 DESCRIPTION OF SUPPORT UNITS(CONDUCTED MODE)	12
2.5 EQUIPMENTS LIST FOR ALL TEST ITEMS	13
<b>3 . EMC EMISSION TEST</b>	<b>15</b>
3.1 CONDUCTED EMISSION MEASUREMENT	15
3.1.1 POWER LINE CONDUCTED EMISSION LIMITS	15
3.1.2 TEST PROCEDURE	16
3.1.3 DEVIATION FROM TEST STANDARD	16
3.1.4 TEST SETUP	16
3.1.5 EUT OPERATING CONDITIONS	16
3.1.6 TEST RESULTS	17
3.2 RADIATED EMISSION MEASUREMENT	25
3.2.1 APPLICABLE STANDARD	25
3.2.2 CONFORMANCE LIMIT	25
3.2.3 MEASURING INSTRUMENTS	25
3.2.4 TEST CONFIGURATION	25
3.2.5 TEST PROCEDURE	27
3.2.6 TEST RESULTS (BETWEEN 9KHZ – 30 MHZ)	28
3.2.7 TEST RESULTS (BETWEEN 30MHZ – 1GHZ)	29
3.2.8 TEST RESULTS (1GHZ-18GHZ)	33
<b>4 . POWER SPECTRAL DENSITY TEST</b>	<b>42</b>
4.1 APPLIED PROCEDURES / LIMIT	42
4.2 TEST PROCEDURE	43
4.3 DEVIATION FROM STANDARD	43
4.4 TEST SETUP	43
4.5 EUT OPERATION CONDITIONS	43
4.6 TEST RESULTS	44
<b>5 . 26 DB &amp; 99% EMISSION BANDWIDTH</b>	<b>52</b>
5.1 APPLIED PROCEDURES / LIMIT	52
5.2 TEST PROCEDURE	52
5.3 EUT OPERATION CONDITIONS	53

**Table of Contents**

	<b>Page</b>
5.4 TEST RESULTS	54
<b>6 . MINIMUM 6 DB BANDWIDTH</b>	<b>62</b>
6.1 APPLIED PROCEDURES / LIMIT	62
6.2 TEST PROCEDURE	62
6.3 DEVIATION FROM STANDARD	62
6.4 TEST SETUP	62
6.5 EUT OPERATION CONDITIONS	62
6.6 TEST RESULTS	63
<b>7 . MAXIMUM CONDUCTED OUTPUT POWER</b>	<b>71</b>
7.1 PPLIED PROCEDURES / LIMIT	71
7.2 TEST PROCEDURE	71
7.3 DEVIATION FROM STANDARD	73
7.4 TEST SETUP	73
7.5 EUT OPERATION CONDITIONS	73
7.6 TEST RESULTS	74
<b>8 . OUT OF BAND EMISSIONS</b>	<b>76</b>
8.1 APPLICABLE STANDARD	76
8.2 TEST PROCEDURE	76
8.3 DEVIATION FROM STANDARD	76
8.4 TEST SETUP	76
8.5 EUT OPERATION CONDITIONS	76
8.6 TEST RESULTS	77
<b>9.SPURIOUS RF CONDUCTED EMISSIONS</b>	<b>83</b>
9.1CONFORMANCE LIMIT	83
9.2MEASURING INSTRUMENTS	83
9.3TEST SETUP	83
9.4TEST PROCEDURE	83
9.5TEST RESULTS	83
<b>10. FREQUENCY STABILITY MEASUREMENT</b>	<b>98</b>
10.1 LIMIT	98
10.2 TEST PROCEDURES	98
10.3 TEST SETUP LAYOUT	98
10.4 EUT OPERATION DURING TEST	98
10.5 TEST RESULTS	99
<b>11. ANTENNA REQUIREMENT</b>	<b>105</b>
11.1 STANDARD REQUIREMENT	105
11.2 EUT ANTENNA	105
<b>APPENDIX-PHOTOGRAPHS OF EUT CONSTRUCTIONAL DETAILS</b>	

### 1. SUMMARY OF TEST RESULTS

Test procedures according to the technical standards:

FCC Part15 (15.407) , Subpart E			
Standard Section	Test Item	Judgment	Remark
15.207	AC Power Line Conducted Emissions	PASS	
15.209(a), 15.407 (b)(1) 15.407 (b)(4) 15.407 (b)(6)	Spurious Radiated Emissions	PASS	
15.407 (a)(1) 15.407 (a)(3) 15.1049	26 dB and 99% Emission Bandwidth	PASS	
15.407(e)	Minimum 6 dB bandwidth	PASS	
15.407 (a)(1) 15.407 (a)(3)	Maximum Conducted Output Power	PASS	
2.1051, 15.407(b)(1) 15.407(b)(4)	Band Edges	PASS	
15.407 (a)(1) 15.407 (a)(3)	Power Spectral Density	PASS	
2.1051, 15.407(b)	Spurious Emissions at Antenna Terminals	PASS	
15.203	Antenna Requirement	PASS	

**NOTE:**

(1) "N/A" denotes test is not applicable in this Test Report

**1.1 TEST FACILITY**

Shenzhen NTEK Testing Technology Co., Ltd  
 Add.: 1/F, Building E, Fenda Science Park, Sanwei Community, Xixiang Street Bao'an District, Shenzhen 518126 P.R. China  
 FCC Registration No.:238937; IC Registration No.:9270A-1  
 CNAS Registration No.:L5516

**1.2 MEASUREMENT UNCERTAINTY**

The reported uncertainty of measurement  $y \pm U$ , where expanded uncertainty  $U$  is based on a standard uncertainty multiplied by a coverage factor of  $k=2$ , providing a level of confidence of approximately **95 %**.

No.	Item	Uncertainty
1	Conducted Emission Test	$\pm 1.38\text{dB}$
2	RF power,conducted	$\pm 0.16\text{dB}$
3	Spurious emissions,conducted	$\pm 0.21\text{dB}$
4	All emissions,radiated(<1G)	$\pm 4.68\text{dB}$
5	All emissions,radiated(>1G)	$\pm 4.89\text{dB}$
6	Temperature	$\pm 0.5^\circ\text{C}$
7	Humidity	$\pm 2\%$

## 2. GENERAL INFORMATION

### 2.1 GENERAL DESCRIPTION OF EUT

Equipment	AC1200 Wifi Dual Band USB 3.0 Adapter		
Trade Mark	N/A		
Model Name	AC1200		
Product Description	IEEE 802.11 WLAN Mode Supported	<input checked="" type="checkbox"/> 802.11a(20MHz channel bandwidth) <input checked="" type="checkbox"/> 802.11n/AC(20MHz channel bandwidth) <input checked="" type="checkbox"/> 802.11n/AC(40MHz channel bandwidth) <input checked="" type="checkbox"/> 802.11AC(80MHz channel bandwidth)	
	Data Rate	802.11 a: 6,9,12,18,24,36,48,54Mbps; 802.11n(HT20):MCS0-MCS15; 802.11n(HT40):MCS0-MCS15; 802.11AC: NSS1,MCS0-MCS9,NSS2,MCS0-MCS9;	
	Modulation	OFDM with BPSK/QPSK/16QAM/64QAM/256QAM for 802.11a/n/ac;	
	Operating Frequency Range	<input checked="" type="checkbox"/> 5180-5240MHz for 802.11a/n(HT20)/AC20; 5190-5230MHz for 802.11n(HT40)/AC40; 5210MHz for 802.11 AC80; <input checked="" type="checkbox"/> 5745-5825 MHz for 802.11a/n(HT20)/AC20; 5755-5795 MHz for 802.11a/n(HT40)/AC40; 5775MHz for 802.11 AC80;	
	Number of Channels	<input checked="" type="checkbox"/> 4 channels for 802.11a/N20/AC20 in the 5180-5240MHz band ; 2 channels for 802.11 N40/AC40 in the 5190-5230MHz band ; 1 channels for 802.11 AC80 in the 5210MHz band ; <input checked="" type="checkbox"/> 5 channels for 802.11a/N20/AC20 in the 5745-5825MHz band ; 2 channels for 802.11 N40/AC40 in the 5755-5795MHz band ; 1 channels for 802.11 AC80 in the 5775MHz band ;	
	Antenna Type	PCB Antenna	
	Smart system	<input checked="" type="checkbox"/> MIMO for 802.11a <input checked="" type="checkbox"/> MIMO for 802.11n/ac	
	Antenna Gain	See Table for Filed Antenna	
	Based on the application, features, or specification exhibited in User's Manual, More details of EUT technical specification, please refer to the User's Manual.		
	Ratings	<input checked="" type="checkbox"/> DC supply: DC 5V	
Adapter	<input type="checkbox"/> Adapter supply: N/A		
Battery	N/A		
Connecting I/O Port(s)	Please refer to the User's Manual		

Note:

1. For a more detailed features description, please refer to the manufacturer's specifications or the User's Manual.
2. Frequency and Channel list for 802.11 a/n/ac (20MHz) (5180-5240MHz):

802.11a/n/ac( 20MHz) Carrier Frequency Channel							
Channel	Frequen cy (MHz)	Channel	Frequen cy (MHz)	Channel	Frequen cy (MHz)	Channel	Frequen cy (MHz)
36	5180	44	5220	-	-	-	-
40	5200	48	5240	-	-	-	-

Frequency and Channel list for 802.11 n /ac (40MHz) (5190-5230MHz):

802.11n /ac(40MHz) Carrier Frequency Channel							
Channel	Frequen cy (MHz)	Channel	Frequen cy (MHz)	Channel	Frequen cy (MHz)	Channel	Frequen cy (MHz)
38	5190	-	-	-	-	-	-
46	5230	-	-	-	-	-	-

802.11ac (80MHz) Carrier Frequency Channel	
Channel	Frequency (MHz)
42	5210

Frequency and Channel list for 802.11 a/n/ac (20 MHz) (5745-5825MHz):

802.11a/n/ac( 20 MHz) Carrier Frequency Channel							
Channel	Frequen cy (MHz)	Channel	Frequen cy (MHz)	Channel	Frequen cy (MHz)	Channel	Frequen cy (MHz)
149	5745	153	5765	157	5785	161	5805
165	5825	-	-	-	-	-	-

Frequency and Channel list for 802.11n/ac (40MHz) (5755-5795MHz):

802.11n/ac 40MHz Carrier Frequency Channel					
Channel	Frequency (MHz)	Channel	Frequency (MHz)	Channel	Frequency (MHz)
151	5755	159	5795	-	-

802.11ac 80MHz Carrier Frequency Channel	
Channel	Frequency (MHz)
155	5775



The EUT has two types of antenna.

Tx Antenna

Antenna	Antenna Type	Antenna Gain(dBi)
		5.0G
A(main)	PCB	1
B(aux)	PCB	1

## 2.2 DESCRIPTION OF TEST MODES

To investigate the maximum EMI emission characteristics generates from EUT, the test system was pre-scanning tested base on the consideration of following EUT operation mode or test configuration mode which possible have effect on EMI emission level. Each of these EUT operation mode(s) or test configuration mode(s) mentioned above was evaluated respectively.

Pretest Mode	Description
Mode 1	Link Mode
Mode 2	802.11a / n/ ac 20 CH36/ CH40/ CH 48 802.11a /n/ ac 20 CH149/ CH157/ CH 165
Mode 3	802.11n/ ac40 CH38/ CH 46 802.11n/ ac40 CH 151 / CH 159
Mode 4	802.11 ac80 CH42/CH 155

For Radiated Emission	
Final Test Mode	Description
Mode 1	Link Mode
Mode 2	802.11a / n/ ac 20 CH36/ CH40/ CH 48 802.11a /n/ ac 20 CH149/ CH157/ CH 165
Mode 3	802.11n/ ac40 CH38/ CH 46 802.11n/ ac40 CH 151 / CH 159
Mode 4	802.11 ac80 CH42/CH 155

Note:

- (1) The measurements are performed at the highest, middle, lowest available channels.
- (2) The measurements are performed at all Bit Rate of Transmitter, the worst data was reported

### 2.3 BLOCK DIGRAM SHOWING THE CONFIGURATION OF SYSTEM TESTED

For AC Conducted Emission Mode

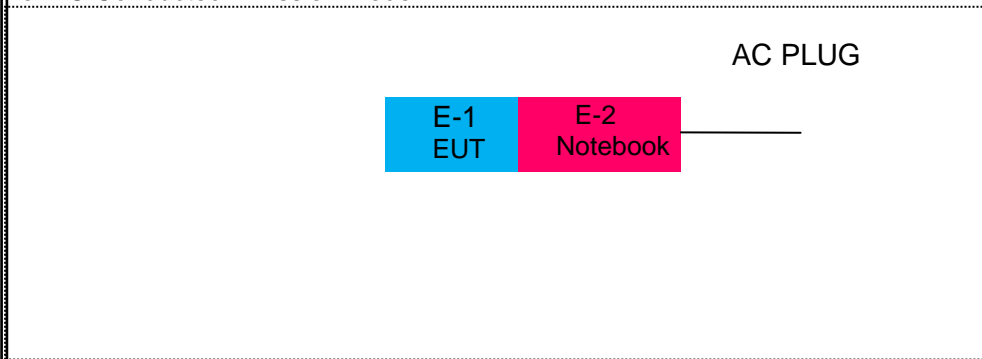

For Radiated Test Cases

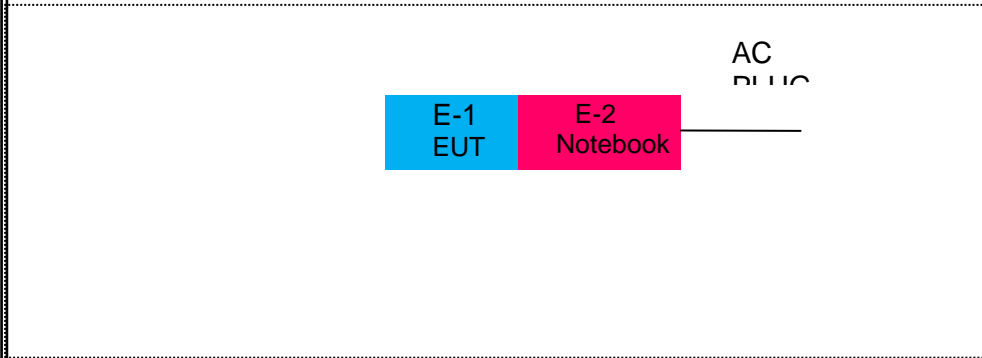

For Conducted Test Cases

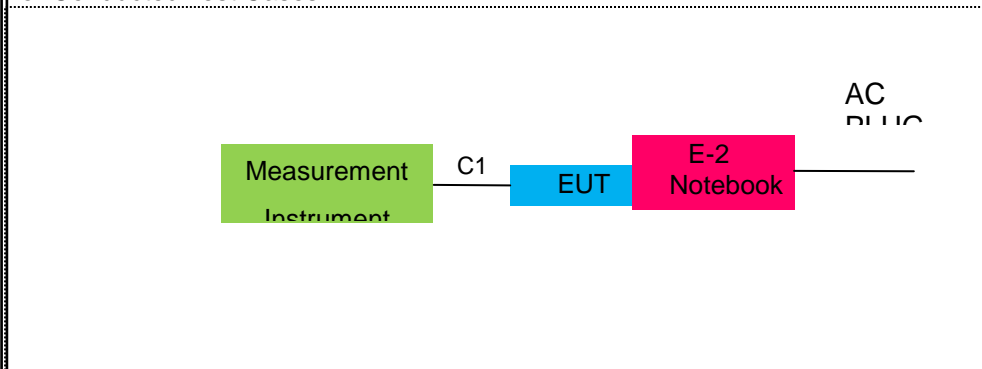

Note: The temporary antenna connector is soldered on the PCB board in order to perform conducted tests and this temporary antenna connector is listed in the equipment list.

**2.4 DESCRIPTION OF SUPPORT UNITS(CONDUCTED MODE)**

The EUT has been tested as an independent unit together with other necessary accessories or support units. The following support units or accessories were used to form a representative test configuration during the tests.

Item	Equipment	Brand	Model/Type No.	Series No.	Note
E-1.	AC1200 Wifi Dual Band USB 3.0 Adapter	N/A	AC1200	2AL6W-AC1200	EUT
E-2	Notebook	Lenove	Thinkpad Edge E430	N/A	

Item	Cable Type	Shielded Type	Ferrite Core	Length	Note

Note:

- (1) The support equipment was authorized by Declaration of Confirmation.
- (2) For detachable type I/O cable should be specified the length in cm in 『Length』 column.

## 2.5 EQUIPMENTS LIST FOR ALL TEST ITEMS

### Radiation Test equipment

Item	Kind of Equipment	Manufacturer	Type No.	Serial No.	Last calibration	Calibrated until	Calibration period
1	Spectrum Analyzer	Agilent	E4407B	MY45108040	2016.07.06	2017.07.05	1 year
2	Spectrum Analyzer	Agilent	N9020A	MY49100060	2016.07.06	2017.07.05	1 year
3	EMI Test Receiver	Agilent	N9038A	MY53227146	2016.07.06	2017.07.05	1 year
4	Test Receiver	R&S	ESPI	101318	2016.07.06	2017.07.05	1 year
5	Bilog Antenna	TESEQ	CBL6111D	31216	2016.07.06	2017.07.05	1 year
6	50Ω Coaxial Switch	Anritsu	MP59B	6200264416	2016.07.06	2017.07.05	1 year
7	Spectrum Analyzer	ADVANTEST	R3132	150900201	2016.07.06	2017.07.05	1 year
8	Horn Antenna	EM	EM-AH-10180	2011071402	2016.07.06	2017.07.05	1 year
9	Horn Ant	Schwarzbeck	BBHA 9170	9170-181	2016.07.06	2017.07.05	1 year
10	Amplifier	EM	EM-30180	060538	2016.12.22	2017.12.21	1 year
11	Amplifier	MITEQ	TTA1840-35-HG	177156	2016.07.06	2017.07.05	1 year
12	Loop Antenna	ARA	PLA-1030/B	1029	2016.07.06	2017.07.05	1 year
13	Power Meter	R&S	NRVS	100696	2016.07.06	2017.07.05	1 year
14	Power Sensor	R&S	URV5-Z4	0395.1619.05	2016.07.06	2017.07.05	1 year
15	Test Cable	N/A	R-01	N/A	2016.07.06	2017.07.05	1 year
16	Test Cable	N/A	R-02	N/A	2016.07.06	2017.07.05	1 year
17	High Test Cable(1G-40 GHz)	N/A	R-03	N/A	2016.07.06	2017.07.05	1 year
18	High Test Cable(1G-40 GHz)	N/A	R-04	N/A	2016.07.06	2017.07.05	1 year

Conduction Test equipment

Item	Kind of Equipment	Manufacturer	Type No.	Serial No.	Last calibration	Calibrated until	Calibration period
1	Test Receiver	R&S	ESCI	101160	2016.07.06	2017.07.05	1 year
2	LISN	R&S	ENV216	101313	2016.08.24	2017.08.23	1 year
3	LISN	EMCO	3816/2	00042990	2016.07.06	2017.07.05	1 year
4	50Ω Coaxial Switch	Anritsu	MP59B	6200264417	2016.07.06	2017.07.05	1 year
5	Passive Voltage Probe	R&S	ESH2-Z3	100196	2016.07.06	2017.07.05	1 year
6	Absorbing clamp	R&S	MOS-21	100423	2016.07.06	2017.07.05	1 year
7	Test Cable	N/A	C01	N/A	2016.06.08	2017.06.07	1 year
8	Test Cable	N/A	C02	N/A	2016.06.08	2017.06.07	1 year
9	Test Cable	N/A	C03	N/A	2016.06.08	2017.06.07	1 year

1	Attenuation	MCE	24-10-34	BN9258	2016.07.06	2017.07.05	1 year
---	-------------	-----	----------	--------	------------	------------	--------

### 3. EMC EMISSION TEST

#### 3.1 CONDUCTED EMISSION MEASUREMENT

##### 3.1.1 POWER LINE CONDUCTED EMISSION Limits (Frequency Range 150KHz-30MHz)

FREQUENCY (MHz)	Class A (dBuV)		Class B (dBuV)		Standard
	Quasi-peak	Average	Quasi-peak	Average	
0.15 -0.5	79.00	66.00	66 - 56 *	56 - 46 *	CISPR
0.50 -5.0	73.00	60.00	56.00	46.00	CISPR
5.0 -30.0	73.00	60.00	60.00	50.00	CISPR

0.15 -0.5	79.00	66.00	66 - 56 *	56 - 46 *	FCC/ RSS-247
0.50 -5.0	73.00	60.00	56.00	46.00	FCC/ RSS-247
5.0 -30.0	73.00	60.00	60.00	50.00	FCC/ RSS-247

Note:

- (1) The tighter limit applies at the band edges.
- (2) The limit of " \* " marked band means the limitation decreases linearly with the logarithm of the frequency in the range.

The following table is the setting of the receiver

Receiver Parameters	Setting
Attenuation	10 dB
Start Frequency	0.15 MHz
Stop Frequency	30 MHz
IF Bandwidth	9 kHz

**3.1.2 TEST PROCEDURE**

- a. The EUT was placed 0.8 meters from the horizontal ground plane with EUT being connected to the power mains through a line impedance stabilization network (LISN). All other support equipments powered from additional LISN(s). The LISN provide 50 Ohm/ 50uH of coupling impedance for the measuring instrument.
- b. Interconnecting cables that hang closer than 40 cm to the ground plane shall be folded back and forth in the center forming a bundle 30 to 40 cm long.
- c. I/O cables that are not connected to a peripheral shall be bundled in the center. The end of the cable may be terminated, if required, using the correct terminating impedance. The overall length shall not exceed 1 m.
- d. LISN at least 80 cm from nearest part of EUT chassis.
- e. For the actual test configuration, please refer to the related Item –EUT Test Photos.

**3.1.3 DEVIATION FROM TEST STANDARD**

No deviation

**3.1.4 TEST SETUP**

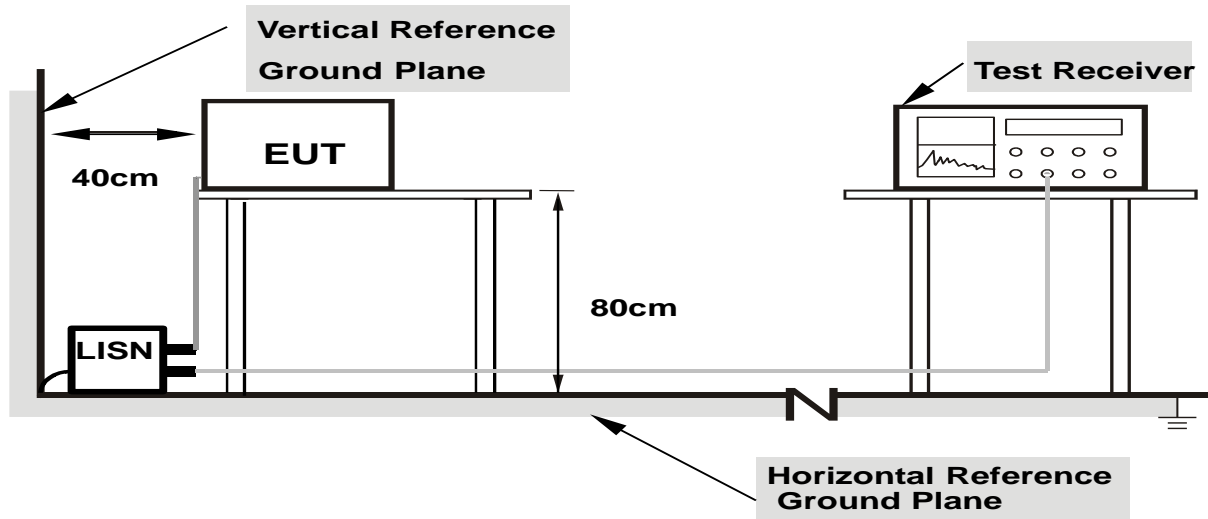

- Note:**
- 1.Support units were connected to second LISN.
  - 2.Both of LISNs (AMN) are 80 cm from EUT and at least 80 from other units and other metal planes

**3.1.5 EUT OPERATING CONDITIONS**

The EUT was configured for testing in a typical fashion (as a customer would normally use it). The EUT has been programmed to continuously transmit during test. This operating condition was tested and used to collect the included data.



### 3.1.6 TEST RESULTS

EUT :	AC1200 Wifi Dual Band USB 3.0 Adapter	Model Name. :	AC1200
Temperature :	26 °C	Relative Humidity :	56%
Pressure :	1010hPa	Phase :	L
Test Voltage :	DC 5V from Notebook AC120V/60Hz	Test Mode :	Mode 1-5.2G

Frequency (MHz)	Meter Reading (dBμV)	Factor (dB)	Emission Level (dBμV)	Limits (dBμV)	Margin (dB)	Detector Type
0.202	31.43	10.06	41.49	63.52	-22.03	QP
0.202	13.3	10.06	23.36	53.52	-30.16	AVG
0.3019	26.79	9.88	36.67	60.19	-23.52	QP
0.3019	14.87	9.88	24.75	50.19	-25.44	AVG
0.8059	20.88	9.63	30.51	56	-25.49	QP
0.8059	10.49	9.63	20.12	46	-25.88	AVG
5.4458	26.28	9.39	35.67	60	-24.33	QP
5.4458	13.3	9.39	22.69	50	-27.31	AVG
15.6859	32.51	9.43	41.94	60	-18.06	QP
15.6859	14.16	9.43	23.59	50	-26.41	AVG
24.5259	26.53	9.94	36.47	60	-23.53	QP
24.5259	14.87	9.94	24.81	50	-25.19	AVG

**Remark:**

1. All readings are Quasi-Peak and Average values.
2. Factor = Insertion Loss + Cable Loss.

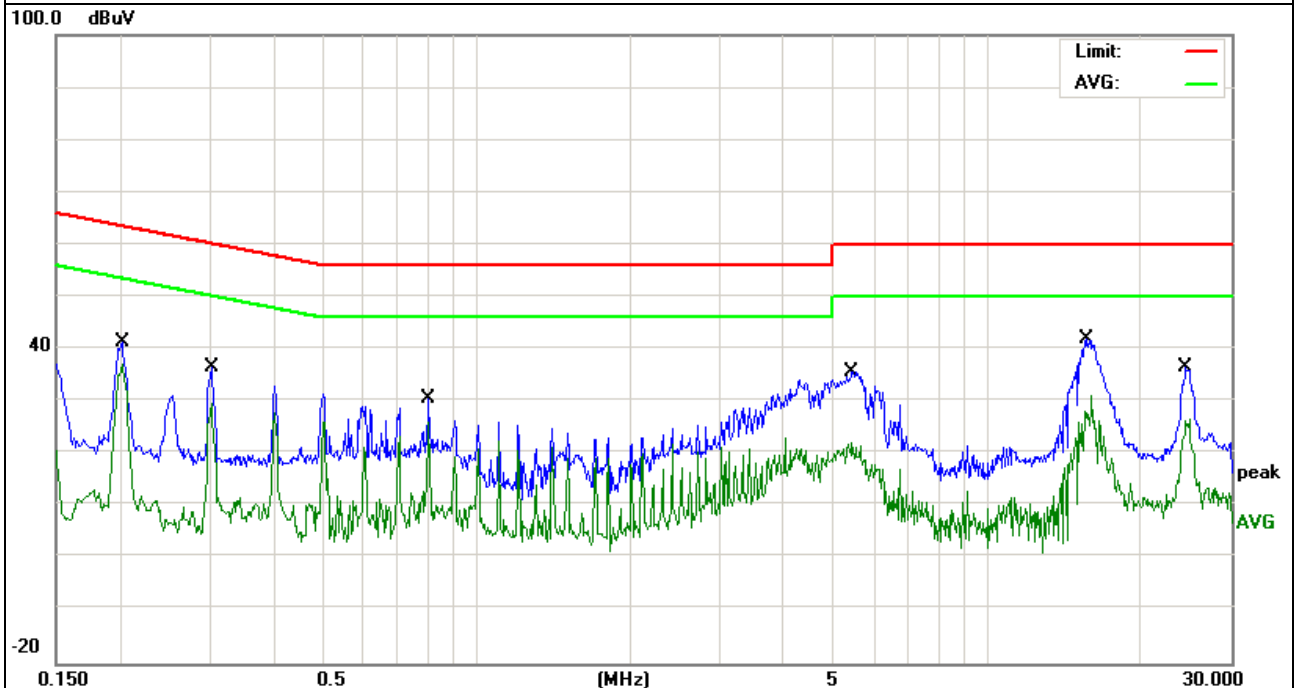

EUT :	AC1200 Wifi Dual Band USB 3.0 Adapter	Model Name. :	AC1200
Temperature :	26 °C	Relative Humidity :	56%
Pressure :	1010hPa	Phase :	N
Test Voltage :	DC 5V from Notebook AC120V/60Hz	Test Mode :	Mode 1-5.2G

Frequency (MHz)	Meter Reading (dBμV)	Factor (dB)	Emission Level (dBμV)	Limits (dBμV)	Margin (dB)	Detector Type
0.202	31.22	10.06	41.28	63.52	-22.24	QP
0.202	11.42	10.06	21.48	53.52	-32.04	AVG
0.3019	28.21	9.88	38.09	60.19	-22.1	QP
0.3019	14.97	9.88	24.85	50.19	-25.34	AVG
0.8059	22.52	9.63	32.15	56	-23.85	QP
0.8059	13.98	9.63	23.61	46	-22.39	AVG
3.0219	27.46	9.44	36.9	56	-19.1	QP
3.0219	13.3	9.44	22.74	46	-23.26	AVG
3.822	29.54	9.43	38.97	56	-17.03	QP
3.822	15.59	9.43	25.02	46	-20.98	AVG
15.8978	35.64	9.43	45.07	60	-14.93	QP
15.8978	14.86	9.43	24.29	50	-25.71	AVG

Remark:

1. All readings are Quasi-Peak and Average values.
2. Factor = Insertion Loss + Cable Loss.

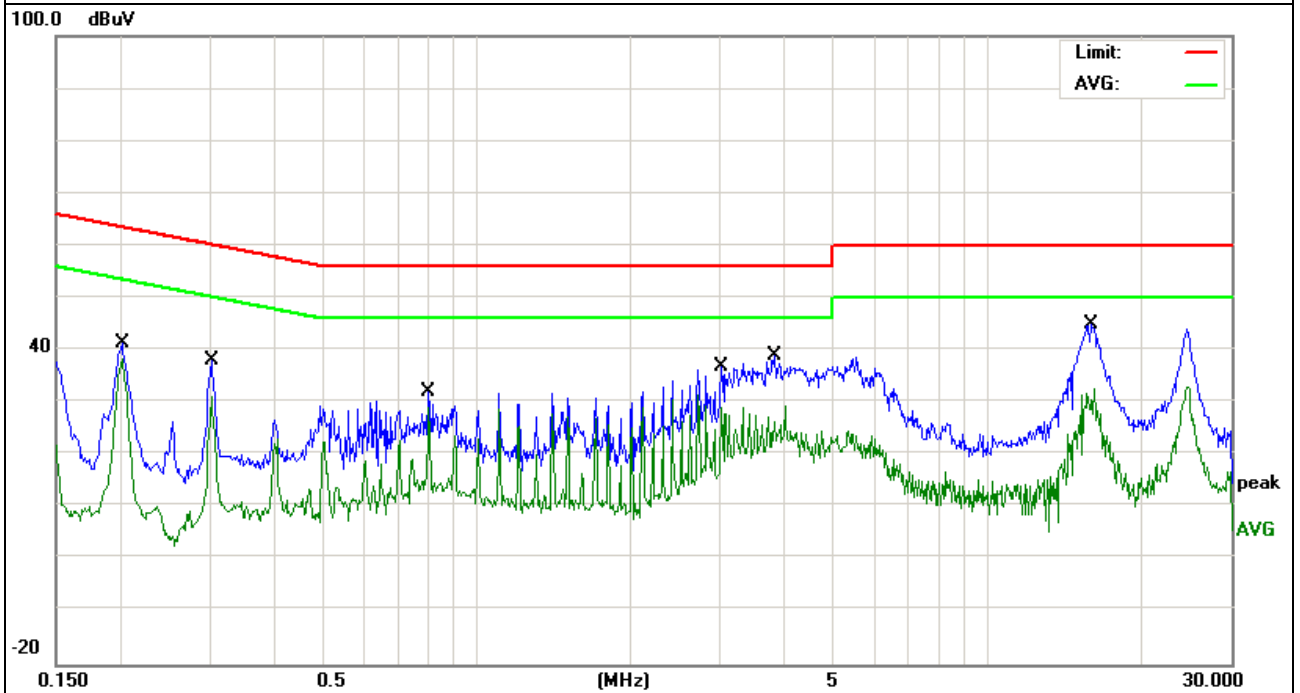

EUT :	AC1200 Wifi Dual Band USB 3.0 Adapter	Model Name. :	AC1200
Temperature :	26 °C	Relative Humidity :	56%
Pressure :	1010hPa	Phase :	L
Test Voltage :	DC 5V from Notebook AC240V/60Hz	Test Mode :	Mode 1-5.2G

Frequency (MHz)	Meter Reading (dBμV)	Factor (dB)	Emission Level (dBμV)	Limits (dBμV)	Margin (dB)	Detector Type
0.202	30.42	10.06	40.48	63.52	-23.04	QP
0.202	15.27	10.06	25.33	53.52	-28.19	AVG
0.3019	24.92	9.88	34.8	60.19	-25.39	QP
0.3019	16.57	9.88	26.45	50.19	-23.74	AVG
0.402	22.82	9.83	32.65	57.81	-25.16	QP
0.402	10.19	9.83	20.02	47.81	-27.79	AVG
0.502	25	9.77	34.77	56	-21.23	QP
0.502	12.57	9.77	22.34	46	-23.66	AVG
5.4019	27.8	9.4	37.2	60	-22.8	QP
5.4019	12.25	9.4	21.65	50	-28.35	AVG
16.1815	32.51	9.43	41.94	60	-18.06	QP
16.1815	14.93	9.43	24.36	50	-25.64	AVG

**Remark:**

1. All readings are Quasi-Peak and Average values.
2. Factor = Insertion Loss + Cable Loss.

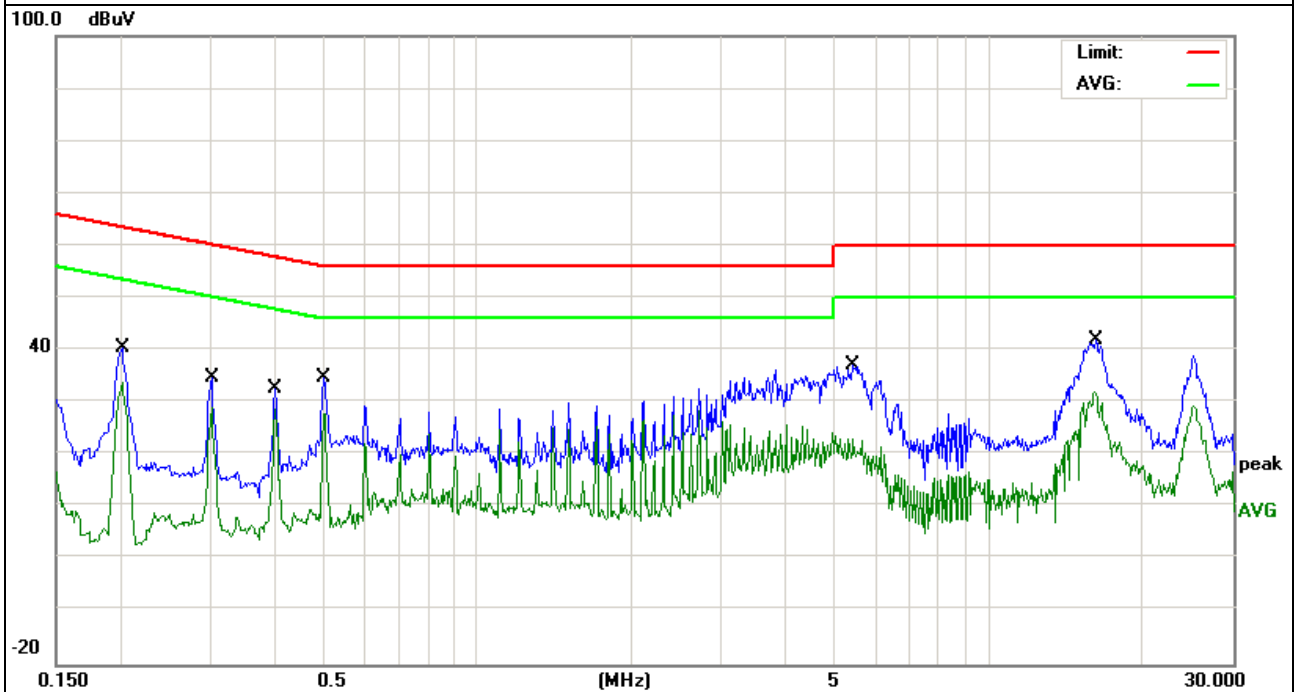

EUT :	AC1200 Wifi Dual Band USB 3.0 Adapter	Model Name. :	AC1200
Temperature :	26 °C	Relative Humidity :	56%
Pressure :	1010hPa	Phase :	N
Test Voltage :	DC 5V from Notebook AC240V/60Hz	Test Mode :	Mode 1-5.2G

Frequency (MHz)	Meter Reading (dBμV)	Factor (dB)	Emission Level (dBμV)	Limits (dBμV)	Margin (dB)	Detector Type
0.202	36.38	10.06	46.44	63.52	-17.08	QP
0.202	13.27	10.06	23.33	53.52	-30.19	AVG
0.3019	24.63	9.88	34.51	60.19	-25.68	QP
0.3019	14.17	9.88	24.05	50.19	-26.14	AVG
0.502	19.18	9.77	28.95	56	-27.05	QP
0.502	8.78	9.77	18.55	46	-27.45	AVG
3.1139	28.49	9.44	37.93	56	-18.07	QP
3.1139	11.58	9.44	21.02	46	-24.98	AVG
15.7619	33.28	9.43	42.71	60	-17.29	QP
15.7619	13.05	9.43	22.48	50	-27.52	AVG
24.998	31.84	9.99	41.83	60	-18.17	QP
24.998	15.37	9.99	25.36	50	-24.64	AVG

Remark:

1. All readings are Quasi-Peak and Average values.
2. Factor = Insertion Loss + Cable Loss.

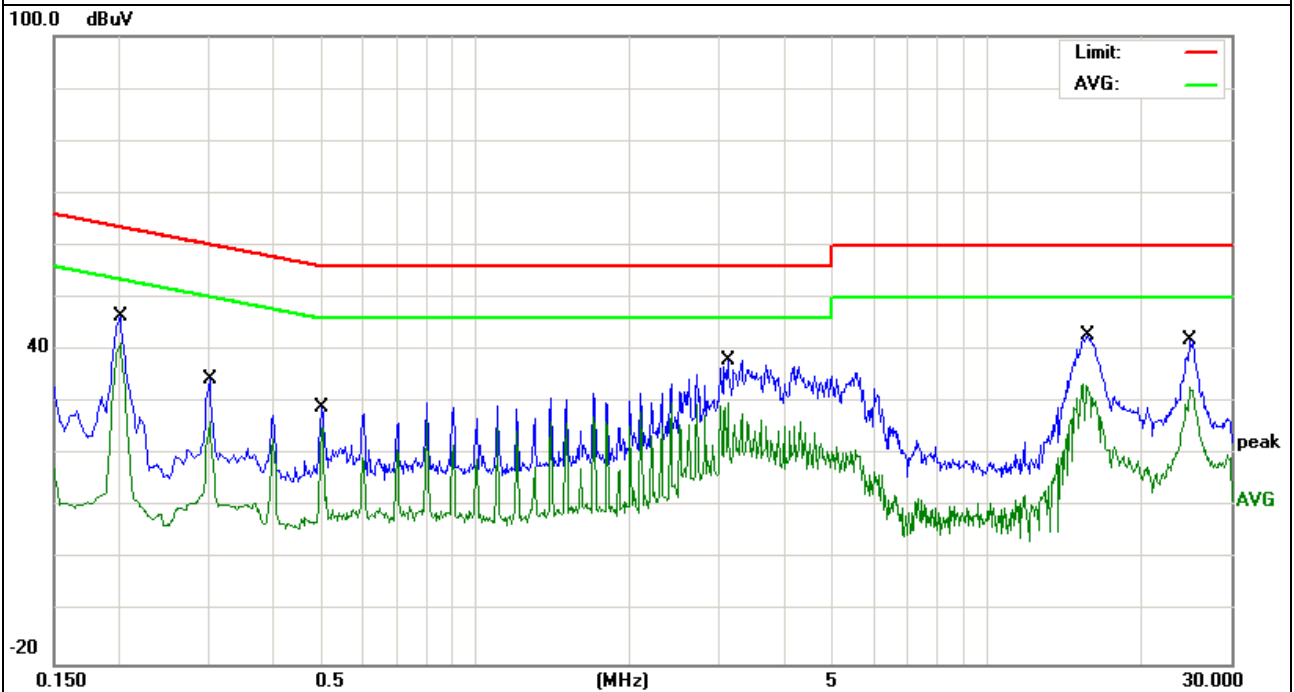

EUT :	AC1200 Wifi Dual Band USB 3.0 Adapter	Model Name. :	AC1200
Temperature :	26 °C	Relative Humidity :	56%
Pressure :	1010hPa	Phase :	L
Test Voltage :	DC 5V from Notebook AC120V/60Hz	Test Mode :	Mode 1-5.8G

Frequency (MHz)	Meter Reading (dBμV)	Factor (dB)	Emission Level (dBμV)	Limits (dBμV)	Margin (dB)	Detector Type
0.202	30.93	10.06	40.99	63.52	-22.53	QP
0.202	15.29	10.06	25.35	53.52	-28.17	AVG
0.3019	30.29	9.88	40.17	60.19	-20.02	QP
0.3019	15.01	9.88	24.89	50.19	-25.3	AVG
0.502	22.28	9.77	32.05	56	-23.95	QP
0.502	12.88	9.77	22.65	46	-23.35	AVG
3.886	26.61	9.43	36.04	56	-19.96	QP
3.886	12.06	9.43	21.49	46	-24.51	AVG
15.8818	33.19	9.43	42.62	60	-17.38	QP
15.8818	14.28	9.43	23.71	50	-26.29	AVG
24.5259	29.53	9.94	39.47	60	-20.53	QP
24.5259	14.08	9.94	24.02	50	-25.98	AVG

Remark:

1. All readings are Quasi-Peak and Average values.
2. Factor = Insertion Loss + Cable Loss.

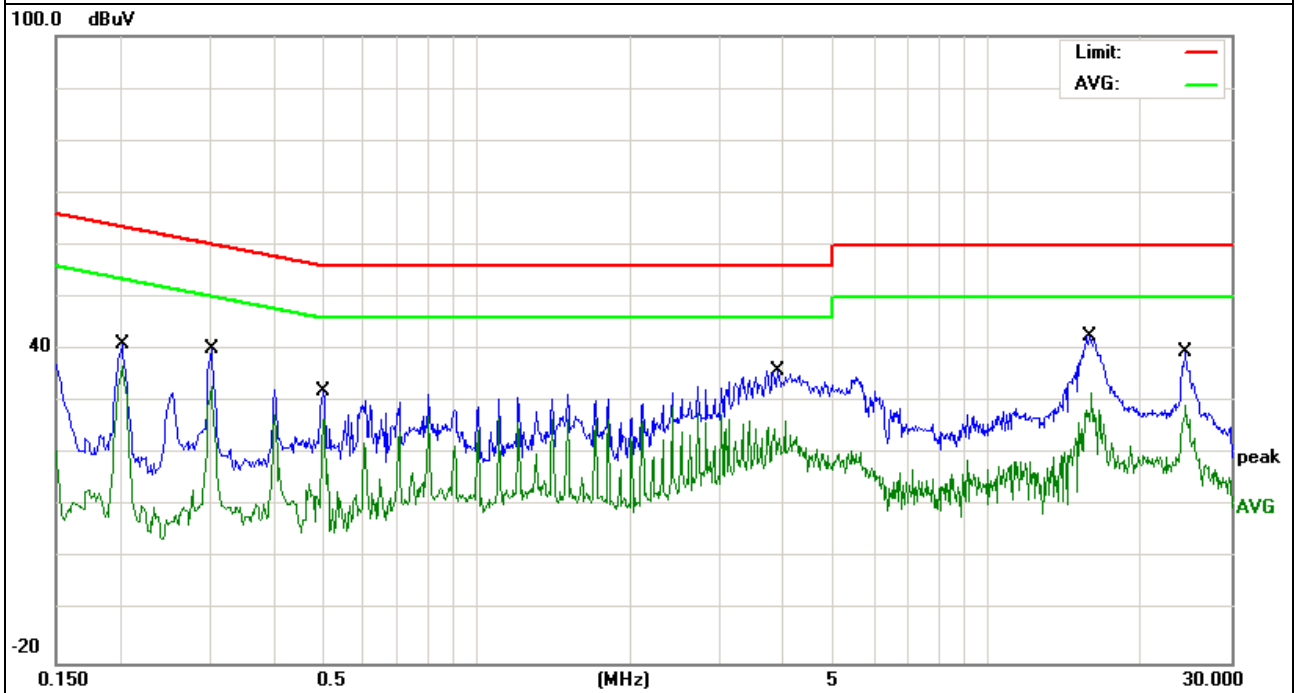

EUT :	AC1200 Wifi Dual Band USB 3.0 Adapter	Model Name. :	AC1200
Temperature :	26 °C	Relative Humidity :	56%
Pressure :	1010hPa	Phase :	N
Test Voltage :	DC 5V from Notebook AC120V/60Hz	Test Mode :	Mode 1-5.8G

Frequency (MHz)	Meter Reading (dBμV)	Factor (dB)	Emission Level (dBμV)	Limits (dBμV)	Margin (dB)	Detector Type
0.202	33.22	10.06	43.28	63.52	-20.24	QP
0.202	14.09	10.06	24.15	53.52	-29.37	AVG
0.3019	33.21	9.88	43.09	60.19	-17.1	QP
0.3019	16.48	9.88	26.36	50.19	-23.83	AVG
1.4097	21.58	9.54	31.12	56	-24.88	QP
1.4097	11.71	9.54	21.25	46	-24.75	AVG
3.822	30.54	9.43	39.97	56	-16.03	QP
3.822	11.15	9.43	20.58	46	-25.42	AVG
15.8978	35.64	9.43	45.07	60	-14.93	QP
15.8978	15.59	9.43	25.02	50	-24.98	AVG
24.5537	33.5	9.95	43.45	60	-16.55	QP
24.5537	14.18	9.95	24.13	50	-25.87	AVG

Remark:

1. All readings are Quasi-Peak and Average values.
2. Factor = Insertion Loss + Cable Loss.

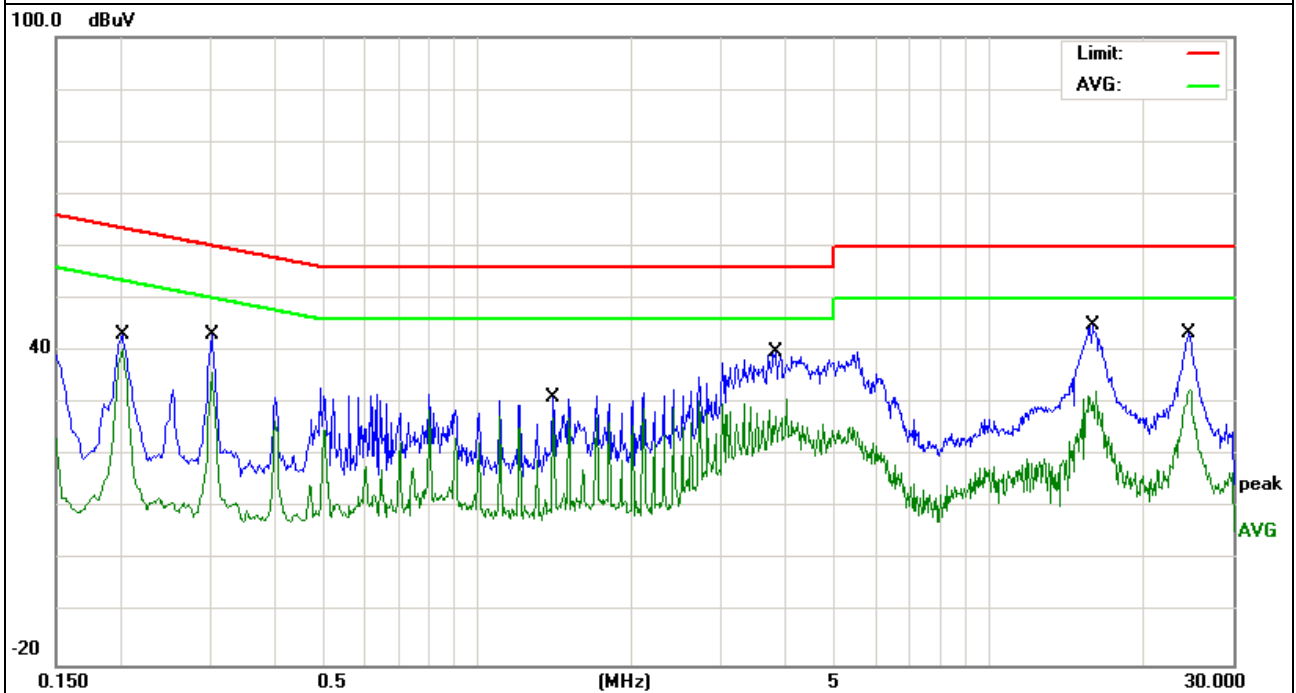

EUT :	AC1200 Wifi Dual Band USB 3.0 Adapter	Model Name. :	AC1200
Temperature :	26 °C	Relative Humidity :	56%
Pressure :	1010hPa	Phase :	L
Test Voltage :	DC 5V from Notebook AC240V/60Hz	Test Mode :	Mode 1-5.8G

Frequency (MHz)	Meter Reading (dBμV)	Factor (dB)	Emission Level (dBμV)	Limits (dBμV)	Margin (dB)	Detector Type
0.202	28.42	10.06	38.48	63.52	-25.04	QP
0.202	15.27	10.06	25.33	53.52	-28.19	AVG
0.3019	25.42	9.88	35.3	60.19	-24.89	QP
0.3019	14.1	9.88	23.98	50.19	-26.21	AVG
0.502	25.5	9.77	35.27	56	-20.73	QP
0.502	14.37	9.77	24.14	46	-21.86	AVG
3.822	25.92	9.43	35.35	56	-20.65	QP
3.822	13.2	9.43	22.63	46	-23.37	AVG
16.1814	35.01	9.43	44.44	60	-15.56	QP
16.1814	15.68	9.43	25.11	50	-24.89	AVG
25.1259	32.61	9.98	42.59	60	-17.41	QP
25.1259	14.08	9.98	24.06	50	-25.94	AVG

Remark:

1. All readings are Quasi-Peak and Average values.
2. Factor = Insertion Loss + Cable Loss.

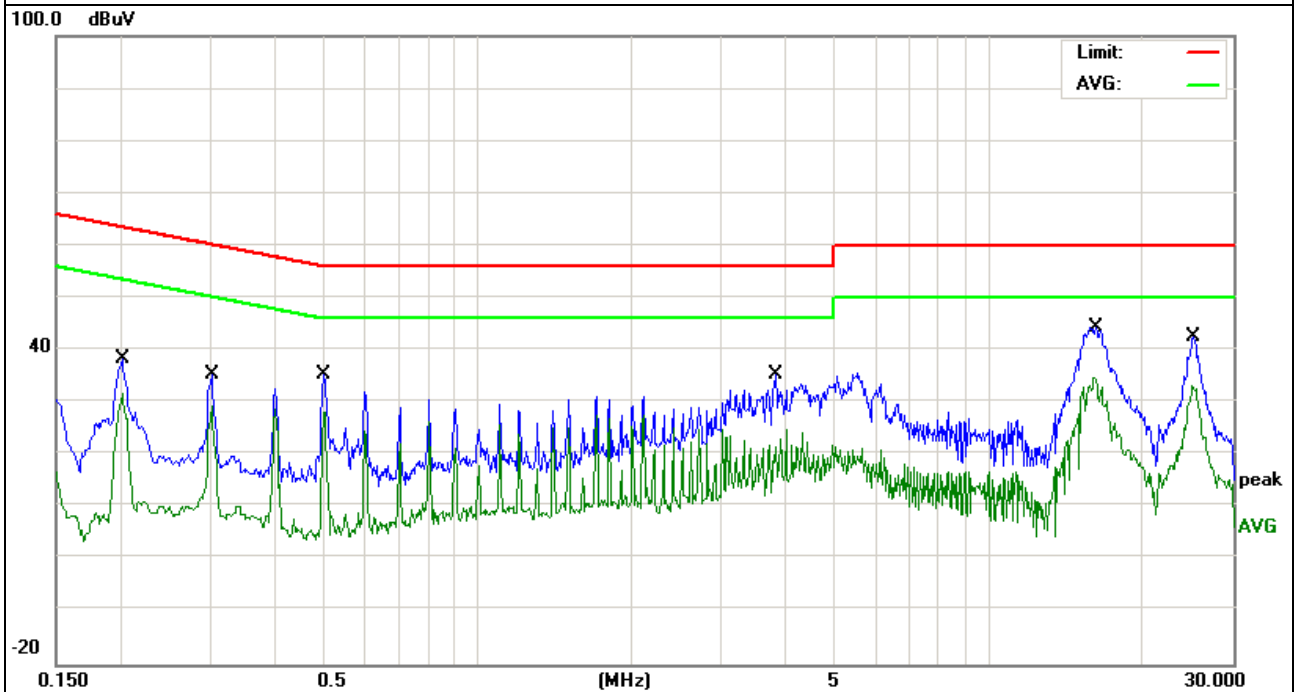

EUT :	AC1200 Wifi Dual Band USB 3.0 Adapter	Model Name. :	AC1200
Temperature :	26 °C	Relative Humidity :	56%
Pressure :	1010hPa	Phase :	N
Test Voltage :	DC 5V from Notebook AC240V/60Hz	Test Mode :	Mode 1-5.8G

Frequency (MHz)	Meter Reading (dBμV)	Factor (dB)	Emission Level (dBμV)	Limits (dBμV)	Margin (dB)	Detector Type
0.202	32.38	10.06	42.44	63.52	-21.08	QP
0.202	12.79	10.06	22.85	53.52	-30.67	AVG
0.3019	21.63	9.88	31.51	60.19	-28.68	QP
0.3019	13.85	9.88	23.73	50.19	-26.46	AVG
0.8059	21.36	9.63	30.99	56	-25.01	QP
0.8059	9.7	9.63	19.33	46	-26.67	AVG
3.7179	28.71	9.43	38.14	56	-17.86	QP
3.7179	12.02	9.43	21.45	46	-24.55	AVG
5.5259	27.39	9.39	36.78	60	-23.22	QP
5.5259	16.8	9.39	26.19	50	-23.81	AVG
15.7619	34.78	9.43	44.21	60	-15.79	QP
15.7619	14.44	9.43	23.87	50	-26.13	AVG

Remark:

1. All readings are Quasi-Peak and Average values.
2. Factor = Insertion Loss + Cable Loss.

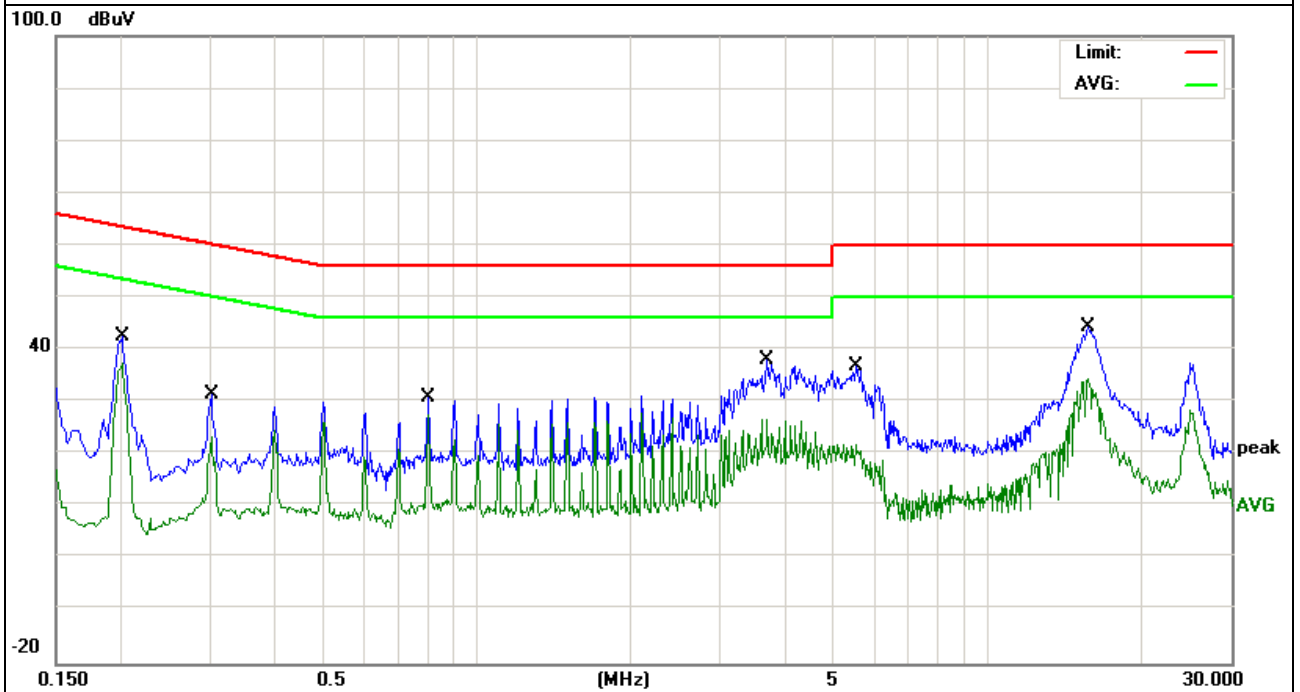



### 3.2 RADIATED EMISSION MEASUREMENT

#### 3.2.1 APPLICABLE STANDARD

According to FCC Part 15.407(d) and 15.209

#### 3.2.2 CONFORMANCE LIMIT

According to FCC Part 15.407(b)(7): radiated emissions which fall in the restricted bands, as defined in §15.205(a), must also comply with the radiated emission limits specified in §15.209(a) (see §15.205(c)).  
According to FCC Part 15.205, Restricted bands

MHz	MHz	MHz	GHz
0.090-0.110	16.42-16.423	399.9-410	4.5-5.15
10.495-0.505	16.69475-16.69525	608-614	5.35-5.46
2.1735-2.1905	16.80425-16.80475	960-1240	7.25-7.75
4.125-4.128	25.5-25.67	1300-1427	8.025-8.5
4.17725-4.17775	37.5-38.25	1435-1626.5	9.0-9.2
4.20725-4.20775	73-74.6	1645.5-1646.5	9.3-9.5
6.215-6.218	74.8-75.2	1660-1710	10.6-12.7
6.26775-6.26825	123-138	2200-2300	14.47-14.5
8.291-8.294	149.9-150.05	2310-2390	15.35-16.2
8.362-8.366	156.52475-156.52525	2483.5-2500	17.7-21.4
8.37625-8.38675	156.7-156.9	2690-2900	22.01-23.12
8.41425-8.41475	162.0125-167.17	3260-3267	23.6-24.0
12.29-12.293	167.72-173.2	3332-3339	31.2-31.8
12.51975-12.52025	240-285	3345.8-3358	36.43-36.5
12.57675-12.57725	322-335.4	3600-4400	(2)
13.36-13.41			

20dBc in any 100 kHz bandwidth outside the operating frequency band. In case the emission fall within the restricted band specified on 15.205(a), then the 15.209(a) limit in the table below has to be followed.

Restricted Frequency(MHz)	Field Strength (µV/m)	Field Strength (dBµV/m)	Measurement Distance
0.009~0.490	2400/F(KHz)	20 log (uV/m)	300
0.490~1.705	2400/F(KHz)	20 log (uV/m)	30
1.705~30.0	30	29.5	30
30-88	100	40	3
88-216	150	43.5	3
216-960	200	46	3
Above 960	500	54	3

#### Limits of Radiated Emission Measurement(Above 1000MHz)

Frequency(MHz)	Class B (dBuV/m) (at 3M)	
	PEAK	AVERAGE
Above 1000	74	54

- Remark :1. Emission level in dBuV/m=20 log (uV/m)  
 2. Measurement was performed at an antenna to the closed point of EUT distance of meters.  
 3. Distance extrapolation factor =40log(Specific distance/ test distance)( dB);  
 Limit line=Specific limits(dBuV) + distance extrapolation factor.

#### 3.2.3 MEASURING INSTRUMENTS

The Measuring equipment is listed in the section 6.3 of this test report.

#### 3.2.4 TEST CONFIGURATION

(a) For radiated emissions below 30MHz

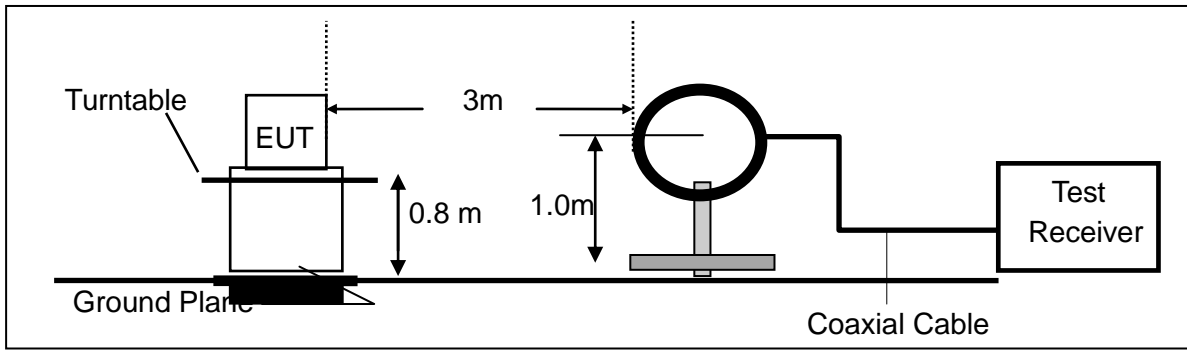

(b) For radiated emissions from 30MHz to 1000MHz

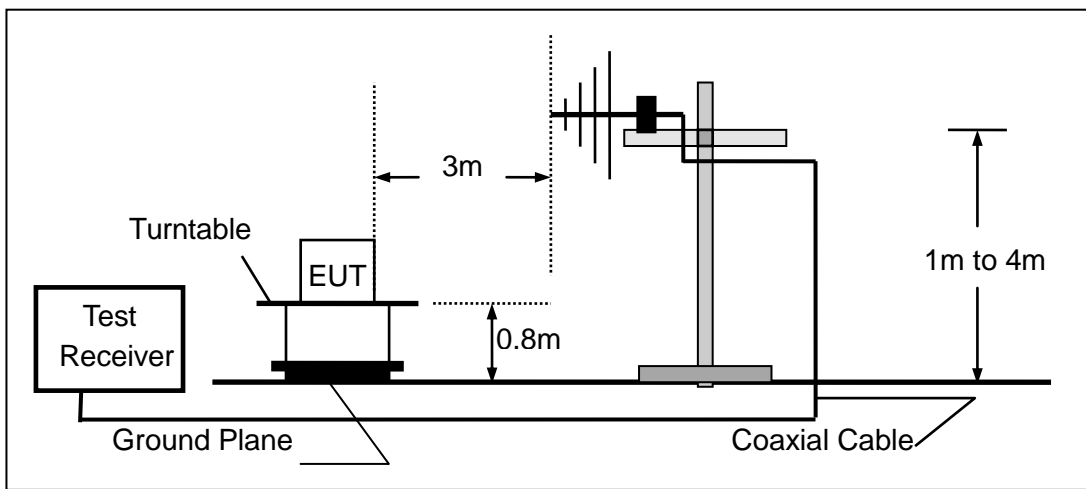

(c) For radiated emissions above 1000MHz

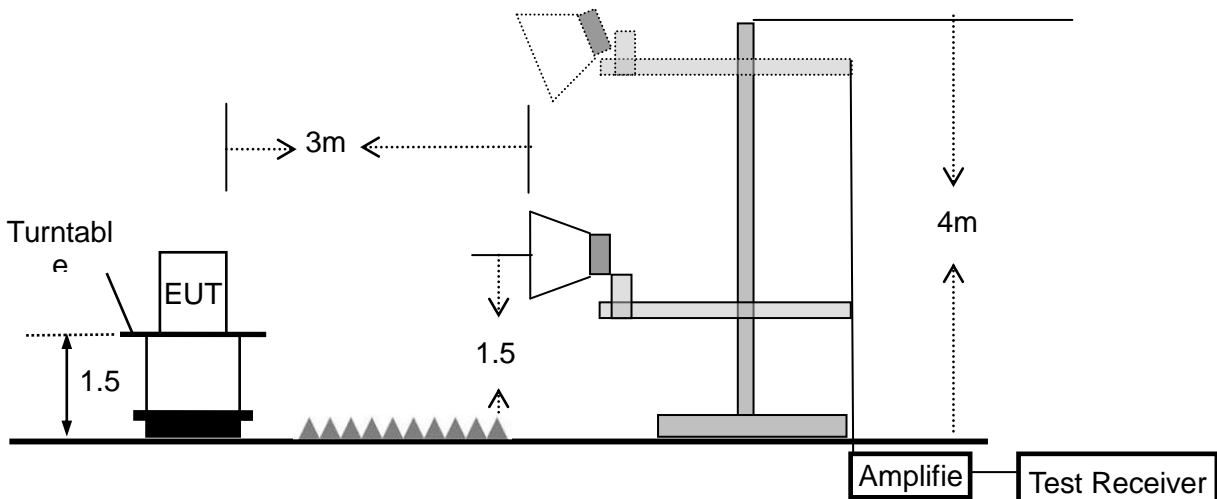

### 3.2.5 TEST PROCEDURE

The test site semi-anechoic chamber has met the requirement of NSA tolerance 4 dB according to the standards: ANSI C63.10-2013. The test distance is 3m. The setup is according to the requirements in Section 13.1.4.1 of ANSI C63.10-2013 and CAN/CSA-CEI/IEC CISPR 22.

This test is required for any spurious emission that falls in a Restricted Band, as defined in Section 15.205. It must be performed with the highest gain of each type of antenna proposed for use with the EUT.

Use the following spectrum analyzer settings:

Spectrum Parameter	Setting
Attenuation	Auto
Start Frequency	1000 MHz
Stop Frequency	10th carrier harmonic
RB / VB (emission in restricted band)	1 MHz / 1 MHz for Peak, 1 MHz / 10Hz for Average

Receiver Parameter	Setting
Attenuation	Auto
Start ~ Stop Frequency	9kHz~150kHz / RB 200Hz for QP
Start ~ Stop Frequency	150kHz~30MHz / RB 9kHz for QP
Start ~ Stop Frequency	30MHz~1000MHz / RB 120kHz for QP

- a. The measuring distance of at 3 m shall be used for measurements at frequency up to 1GHz. For frequencies above 1GHz, any suitable measuring distance may be used.
- b. The EUT was placed on the top of a rotating table 0.8 m for below 1GHz and 1.5m for above 1GHz the ground at a 3 meter. The table was rotated 360 degrees to determine the position of the highest radiation.
- c. The height of the equipment or of the substitution antenna shall be 0.8 m for below 1GHz and 1.5m for above 1GHz; the height of the test antenna shall vary between 1 m to 4 m. Both horizontal and vertical polarizations of the antenna are set to make the measurement.
- d. The initial step in collecting conducted emission data is a spectrum analyzer peak detector mode pre-scanning the measurement frequency range. Significant peaks are then marked and then Quasi Peak detector mode re-measured.
- e. If the Peak Mode measured value compliance with and lower than Quasi Peak Mode Limit, the EUT shall be deemed to meet QP Limits and then no additional QP Mode measurement performed.
- f. For the actual test configuration, please refer to the related Item –EUT Test Photos.

Note:

Both horizontal and vertical antenna polarities were tested and performed pretest to three orthogonal axis. The worst case emissions were reported

During the radiated emission test, the Spectrum Analyzer was set with the following configurations:

Frequency Band (MHz)	Function	Resolution bandwidth	Video Bandwidth
30 to 1000	QP	120 kHz	300 kHz
Above 1000	Peak	1 MHz	1 MHz
	Average	1 MHz	10 Hz

Note: for the frequency ranges below 30 MHz, a narrower RBW is used for these ranges but the measured value should add a RBW correction factor (RBWCF) where  $RBWCF [dB] = 10 \cdot \lg(100 [kHz] / \text{narrower RBW [kHz]})$ . , the narrower RBW is 1 kHz and RBWCF is 20 dB for the frequency 9 kHz to 150 kHz, and the narrower RBW is 10 kHz and RBWCF is 10 dB for the frequency 150 kHz to 30 MHz.

**3.2.6 TEST RESULTS (BETWEEN 9KHZ – 30 MHZ)**

EUT:	AC1200 Wifi Dual Band USB 3.0 Adapter	Model Name. :	AC1200
Temperature:	20 °C	Relative Humidity:	48%
Pressure:	1010 hPa	Test Voltage :	DC 5V from Notebook
Test Mode :	TX	Polarization :	--

Freq.	Reading	Limit	Margin	State
(MHz)	(dBuV/m)	(dBuV/m)	(dB)	P/F
--	--	--	--	N/A
--	--	--	--	N/A

**NOTE:**

The amplitude of spurious emissions which are attenuated by more than 20dB below the permissible value has no need to be reported.

Distance extrapolation factor =  $40 \log(\text{specific distance}/\text{test distance})$ (dB);

Limit line = specific limits(dBuv) + distance extrapolation factor.

### 3.2.7 TEST RESULTS (BETWEEN 30MHZ – 1GHZ)

EUT :	AC1200 Wifi Dual Band USB 3.0 Adapter	Model Name :	AC1200
Temperature :	20 °C	Relative Humidity :	48%
Pressure :	1010 hPa	Test Voltage :	DC 5V from Notebook
Test Mode :	TX(5.2G)- 802.11a (High CH)		

Polar (H/V)	Frequency	Meter Reading	Factor	Emission Level	Limits	Margin	Remark
	(MHz)	(dBuV)	(dB)	(dBuV/m)	(dBuV/m)	(dB)	
V	43.0504	16.83	12.66	29.49	40	-10.51	QP
V	62.6507	22.16	6.36	28.52	40	-11.48	QP
V	84.9993	18.6	9.44	28.04	40	-11.96	QP
V	148.441	12.93	13.04	25.97	43.5	-17.53	QP
V	312.1792	13.55	16.65	30.2	46	-15.8	QP
V	468.8761	14.03	21.07	35.1	46	-10.9	QP

**Remark:**

Absolute Level= ReadingLevel+ Factor, Margin= Absolute Level - Limit

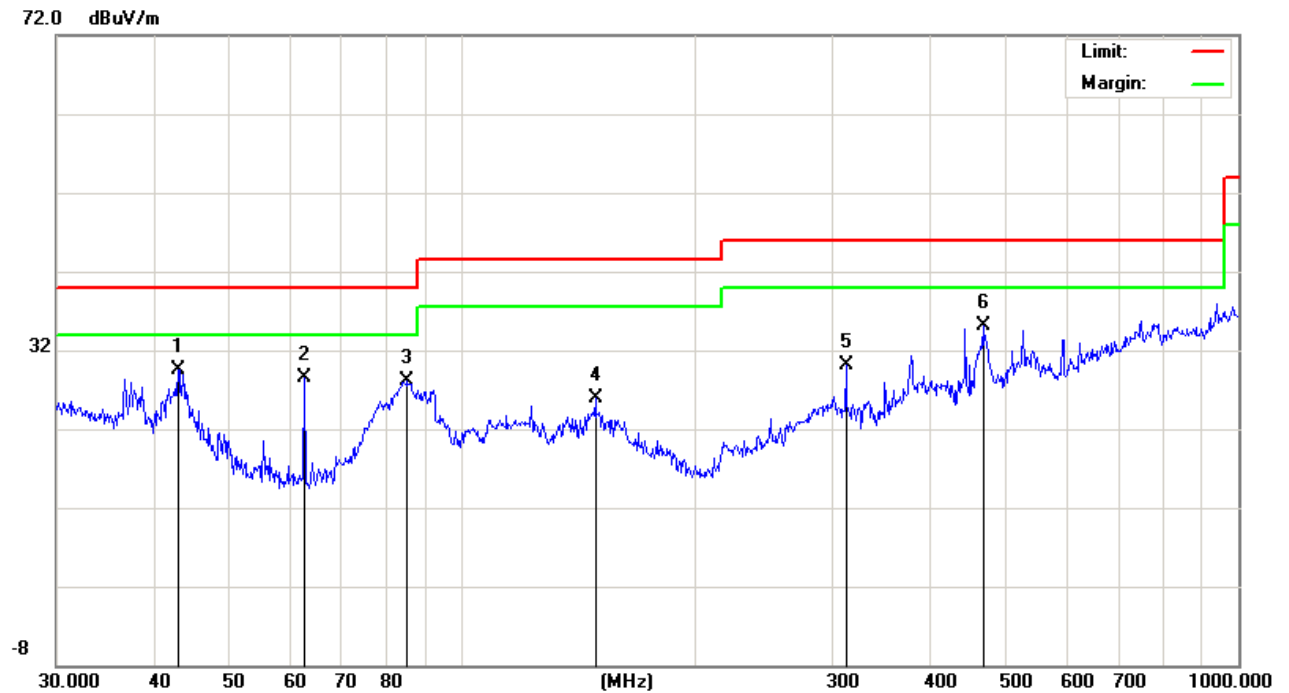

Polar (H/V)	Frequency	Meter Reading	Factor	Emission Level	Limits	Margin	Remark
	(MHz)	(dBuV)	(dB)	(dBuV/m)	(dBuV/m)	(dB)	
H	36.0007	8.64	16.79	25.43	40	-14.57	QP
H	112.1303	17.7	12.87	30.57	43.5	-12.93	QP
H	171.3925	16.08	11.56	27.64	43.5	-15.86	QP
H	297.2241	13.43	16.21	29.64	46	-16.36	QP
H	444.8514	20.92	20.83	41.75	46	-4.25	QP
H	798.9796	12.05	28.03	40.08	46	-5.92	QP

**Remark:**

Absolute Level= ReadingLevel+ Factor, Margin= Absolute Level - Limit

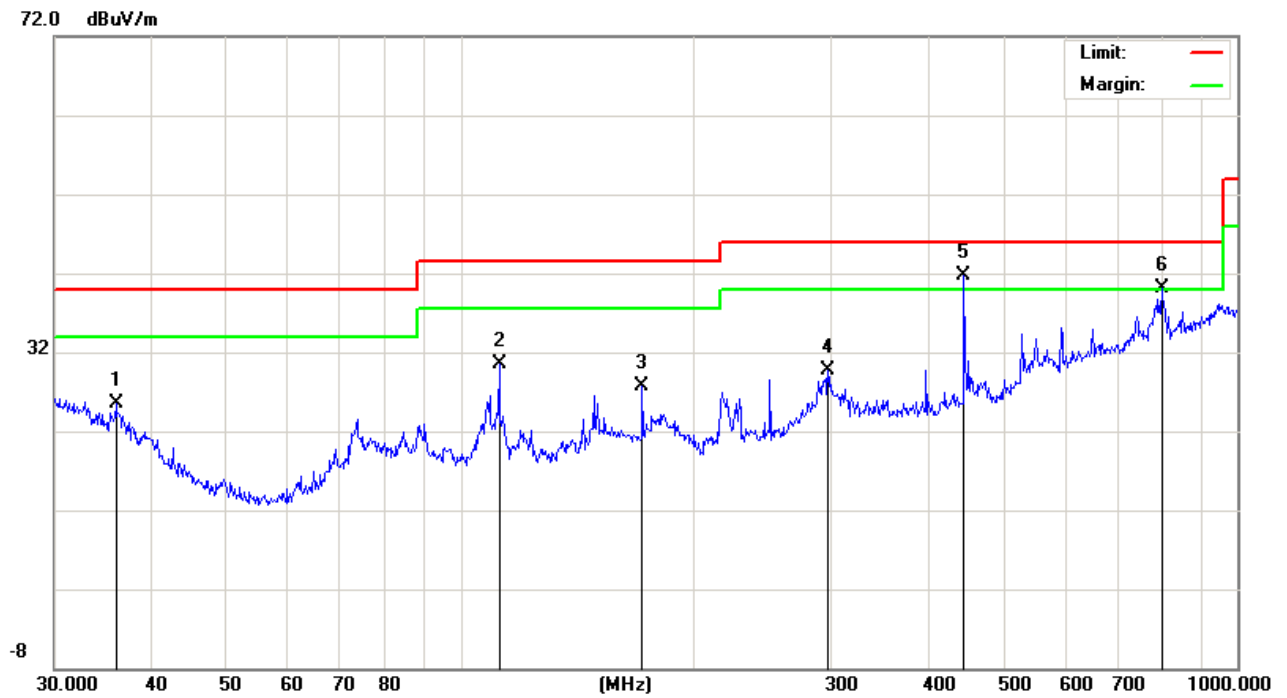

EUT :	AC1200 Wifi Dual Band USB 3.0 Adapter	Model Name :	AC1200
Temperature :	20 °C	Relative Humidity :	48%
Pressure :	1010 hPa	Test Voltage :	DC 5V from Notebook
Test Mode :	TX(5.8G) - 802.11a (High CH)		

Polar (H/V)	Frequency	Meter Reading	Factor	Emission Level	Limits	Margin	Remark
	(MHz)	(dBuV)	(dB)	(dBuV/m)	(dBuV/m)	(dB)	
V	36.7661	11.37	16.45	27.82	40	-12.18	QP
V	41.8596	15.43	13.59	29.02	40	-10.98	QP
V	62.6507	22.16	6.36	28.52	40	-11.48	QP
V	84.9993	19.1	9.44	28.54	40	-11.46	QP
V	148.441	13.43	13.04	26.47	43.5	-17.03	QP
V	468.8761	16.03	21.07	37.1	46	-8.9	QP

**Remark:**

Absolute Level= ReadingLevel+ Factor, Margin= Absolute Level - Limit

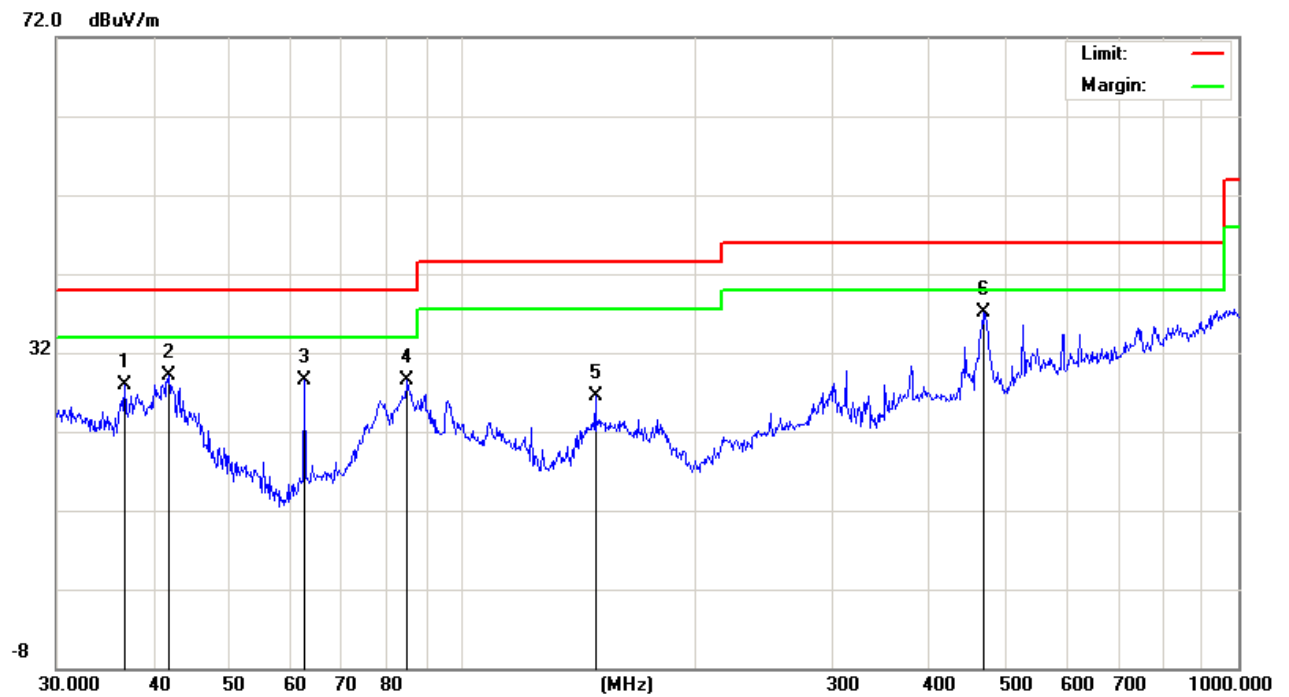

Polar (H/V)	Frequency	Meter Reading	Factor	Emission Level	Limits	Margin	Remark
	(MHz)	(dBuV)	(dB)	(dBuV/m)	(dBuV/m)	(dB)	
H	33.2111	8.12	18.18	26.3	40	-13.7	QP
H	84.4054	13.49	9.36	22.85	40	-17.15	QP
H	112.1303	18.7	12.87	31.57	43.5	-11.93	QP
H	171.3925	14.08	11.56	25.64	43.5	-17.86	QP
H	297.2241	13.93	16.21	30.14	46	-15.86	QP
H	444.8514	17.92	20.83	38.75	46	-7.25	QP
H	33.2111	8.12	18.18	26.3	40	-13.7	QP

**Remark:**

Absolute Level= ReadingLevel+ Factor, Margin= Absolute Level - Limit

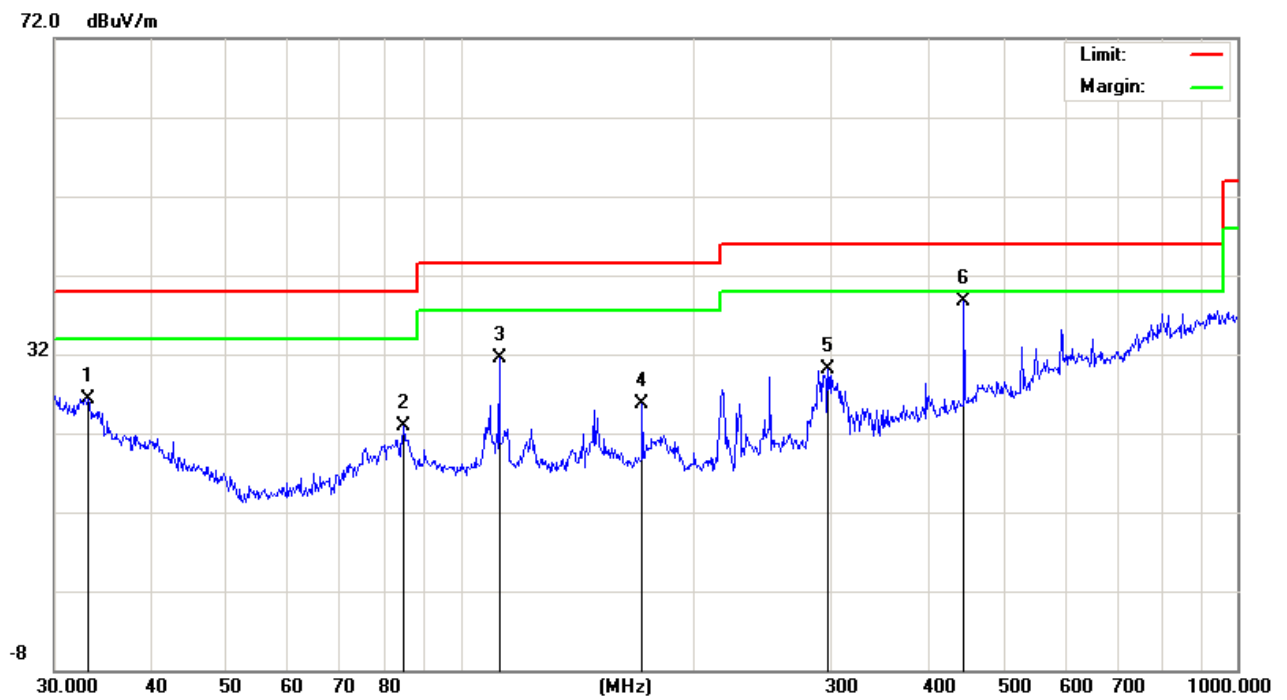



### 3.2.8 TEST RESULTS (1GHz-18GHz)

EUT :	AC1200 Wifi Dual Band USB 3.0 Adapter	Model Name :	AC1200
Temperature :	20 °C	Relative Humidity :	48%
Pressure :	1010 hPa	Test Voltage :	DC 5V from Notebook
Test Mode :	TX (5.2G)-802.11a 5180MHz~5240MHz		

Polar	Frequency	Meter Reading	Cable loss	Antenna Factor	Preamp Factor	Emission Level	Limits	Margin	Detector Type
(H/V)	(MHz)	(dBuV)	(dB)	dB/m	(dB)	(dBuV/m)	(dBuV/m)	(dB)	
Low Channel (5180 MHz)-Above 1G									
Vertical	4434.177	52.02	5.94	35.4	44	49.36	74	-24.64	Pk
Vertical	4434.177	44.35	5.94	35.4	44	41.69	54	-12.31	AV
Vertical	10370.38	60.25	8.46	39.75	44.5	63.96	74	-10.04	Pk
Vertical	10370.38	40.15	8.46	39.75	44.5	43.86	54	-10.14	AV
Vertical	15540.22	61.52	10.12	38.8	44.1	66.34	74	-7.66	Pk
Vertical	15540.22	37.6	10.12	38.8	42.7	43.82	54	-10.18	AV
Horizontal	4434.541	59.35	5.94	35.18	44	56.47	74	-17.53	Pk
Horizontal	4434.541	44.23	5.94	35.18	44	41.35	54	-12.65	AV
Horizontal	10370.64	60.12	8.46	38.71	44.5	62.79	74	-11.21	Pk
Horizontal	10370.64	43.06	8.46	38.71	44.5	45.73	54	-8.27	AV
Horizontal	10540.89	57	10.12	38.38	44.1	61.4	74	-12.6	Pk
Horizontal	10540.89	38.92	10.12	38.38	44.1	43.32	54	-10.68	AV
middle Channel (5200 MHz)-Above 1G									
Vertical	4592.113	60.25	6.48	36.35	44.05	59.03	74	-14.97	Pk
Vertical	4592.113	45.35	6.48	36.35	44.05	44.13	54	-9.87	AV
Vertical	10401.44	54.25	8.47	37.88	44.51	56.09	74	-17.91	Pk
Vertical	10401.44	41.35	8.47	37.88	44.51	43.19	54	-10.81	AV
Vertical	15600.24	56.56	10.12	38.8	44.1	61.38	74	-12.62	Pk
Vertical	15600.24	36.68	10.12	38.8	42.7	42.9	54	-11.1	AV
Horizontal	4592.711	64.25	6.48	36.37	44.05	63.05	74	-10.95	Pk
Horizontal	4592.711	45.69	6.48	36.37	44.05	44.49	54	-9.51	AV
Horizontal	10400.13	57.25	8.47	38.64	44.5	59.86	74	-14.14	Pk
Horizontal	10400.13	44.32	8.47	38.64	44.5	46.93	54	-7.07	AV
Horizontal	15600.21	59.9	10.12	38.38	44.1	64.3	74	-9.7	Pk
Horizontal	15600.21	38.82	10.12	38.38	44.1	43.22	54	-10.78	AV
High Channel (5240 MHz)-Above 1G									
Vertical	4739.266	59.02	7.1	37.24	43.5	59.86	74	-14.14	Pk
Vertical	4739.266	44.25	7.1	37.24	43.5	45.09	54	-8.91	AV
Vertical	10480.39	54.12	8.46	37.68	44.5	55.76	74	-18.24	Pk
Vertical	10480.39	41.36	8.46	37.68	44.5	43	54	-11	AV
Vertical	15720.38	61.78	10.12	38.8	44.1	66.6	74	-7.4	Pk
Vertical	15720.38	39.72	10.12	38.8	42.7	45.94	54	-8.06	AV
Horizontal	4739.372	64.25	7.1	37.24	43.5	65.09	74	-8.91	Pk
Horizontal	4739.372	41.32	7.1	37.24	43.5	42.16	54	-11.84	AV
Horizontal	10481.13	54.26	8.46	38.57	44.5	56.79	74	-17.21	Pk
Horizontal	10481.13	42.47	8.46	38.57	44.5	45	54	-9	AV
Horizontal	15720.38	60.78	10.12	38.38	44.1	65.18	74	-8.82	Pk
Horizontal	15720.38	42.3	10.12	38.38	44.1	46.7	54	-7.3	AV

Note:"802.11a (5G)" mode is the worst mode. PK value is lower than the Average value limit, So average didn't record.

The amplitude of spurious emissions that are attenuated by more than 20dB below the permissible value has no need to be reported.

Emission level (dBuV/m) = 20 log Emission level (uV/m).

Corrected Reading: Antenna Factor + Cable Loss + Read Level - Preamp Factor = Level.

EUT :	AC1200 Wifi Dual Band USB 3.0 Adapter	Model Name :	AC1200
Temperature :	20 °C	Relative Humidity :	48%
Pressure :	1010 hPa	Test Voltage :	DC 5V from Notebook
Test Mode :	TX (5.8G) -a 5745MHz~5825MHz		

Polar	Frequency	Meter Reading	Cable loss	Antenna Factor	Preamp Factor	Emission Level	Limits	Margin	Detector Type
(H/V)	(MHz)	(dBuV)	(dB)	dB/m	(dB)	(dBuV/m)	(dBuV/m)	(dB)	
Low Channel (5745 MHz)-Above 1G									
Vertical	4679.225	52.15	5.94	35.4	44	49.49	74	-24.51	Pk
Vertical	4679.225	41.32	5.94	35.4	44	38.66	54	-15.34	AV
Vertical	11490.582	51.63	8.46	39.75	44.5	55.34	74	-18.66	Pk
Vertical	11490.582	38.22	8.46	39.75	44.5	41.93	54	-12.07	AV
Vertical	17235.746	56.46	10.12	38.8	44.1	61.28	74	-12.72	Pk
Vertical	17235.746	40.28	10.12	38.8	42.7	46.5	54	-7.5	AV
Horizontal	4679.184	59.25	5.94	35.18	44	56.37	74	-17.63	Pk
Horizontal	4679.184	43.02	5.94	35.18	44	40.14	54	-13.86	AV
Horizontal	11490.179	50.44	8.46	38.71	44.5	53.11	74	-20.89	Pk
Horizontal	11490.179	41.58	8.46	38.71	44.5	44.25	54	-9.75	AV
Horizontal	17235.546	58.27	10.12	38.38	44.1	62.67	74	-11.33	Pk
Horizontal	17235.546	42.5	10.12	38.38	44.1	46.9	54	-7.1	AV
middle Channel (5785 MHz)-Above 1G									
Vertical	4592.177	59.35	6.48	36.35	44.05	58.13	74	-15.87	Pk
Vertical	4592.177	42.02	6.48	36.35	44.05	40.8	54	-13.2	AV
Vertical	11570.204	54.35	8.47	37.88	44.51	56.19	74	-17.81	Pk
Vertical	11570.204	39.25	8.47	37.88	44.51	41.09	54	-12.91	AV
Vertical	17355.26	57.27	10.12	38.8	44.1	62.09	74	-11.91	Pk
Vertical	17355.26	40.3	10.12	38.8	42.7	46.52	54	-7.48	AV
Horizontal	4592.505	58.45	6.48	36.37	44.05	57.25	74	-16.75	Pk
Horizontal	4592.505	41.06	6.48	36.37	44.05	39.86	54	-14.14	AV
Horizontal	11570.284	54.69	8.47	38.64	44.5	57.3	74	-16.7	Pk
Horizontal	11570.284	40.22	8.47	38.64	44.5	42.83	54	-11.17	AV
Horizontal	17355.784	59.73	10.12	38.38	44.1	64.13	74	-9.87	Pk
Horizontal	17355.784	44.39	10.12	38.38	44.1	48.79	54	-5.21	AV
High Channel (5825 MHz)-Above 1G									
Vertical	5039.144	57.35	7.1	37.24	43.5	58.19	74	-15.81	Pk
Vertical	5039.144	41.02	7.1	37.24	43.5	41.86	54	-12.14	AV
Vertical	11650.284	52.33	8.46	37.68	44.5	53.97	74	-20.03	Pk
Vertical	11650.284	40.25	8.46	37.68	44.5	41.89	54	-12.11	AV
Vertical	17475.427	59.51	10.12	38.8	44.1	64.33	74	-9.67	Pk
Vertical	17475.427	39.96	10.12	38.8	42.7	46.18	54	-7.82	AV
Horizontal	5039.28	60.25	7.1	37.24	43.5	61.09	74	-12.91	Pk
Horizontal	5039.28	42.15	7.1	37.24	43.5	42.99	54	-11.01	AV
Horizontal	11650.174	55.98	8.46	38.57	44.5	58.51	74	-15.49	Pk
Horizontal	11650.174	41.36	8.46	38.57	44.5	43.89	54	-10.11	AV
Horizontal	17475.309	59.88	10.12	38.38	44.1	64.28	74	-9.72	Pk
Horizontal	17475.309	44.36	10.12	38.38	44.1	48.76	54	-5.24	AV

Note:"802.11a (5G)" mode is the worst mode. PK value is lower than the Average value limit, So average didn't record.

The amplitude of spurious emissions that are attenuated by more than 20dB below the permissible value has no need to be reported.

Emission level (dBuV/m) = 20 log Emission level (uV/m).

Corrected Reading: Antenna Factor + Cable Loss + Read Level - Preamp Factor = Level.

TEST RESULTS (18GHz-40GHz)

EUT :	AC1200 Wifi Dual Band USB 3.0 Adapter	Model Name :	AC1200
Temperature :	20 °C	Relative Humidity :	48%
Pressure :	1010 hPa	Test Voltage :	DC 5V from Notebook
Test Mode :	TX (5.2G)-802.11a 5180MHz~5240MHz , TX (5.8G) -802.11a 5745MHz~5825MHz		

All the modulation modes have been tested, and the worst result was report as below:  
 Channel (5180 MHz) 18-26.5G

Horizontal

FCC Electric Field Strength 18-26.5GHz

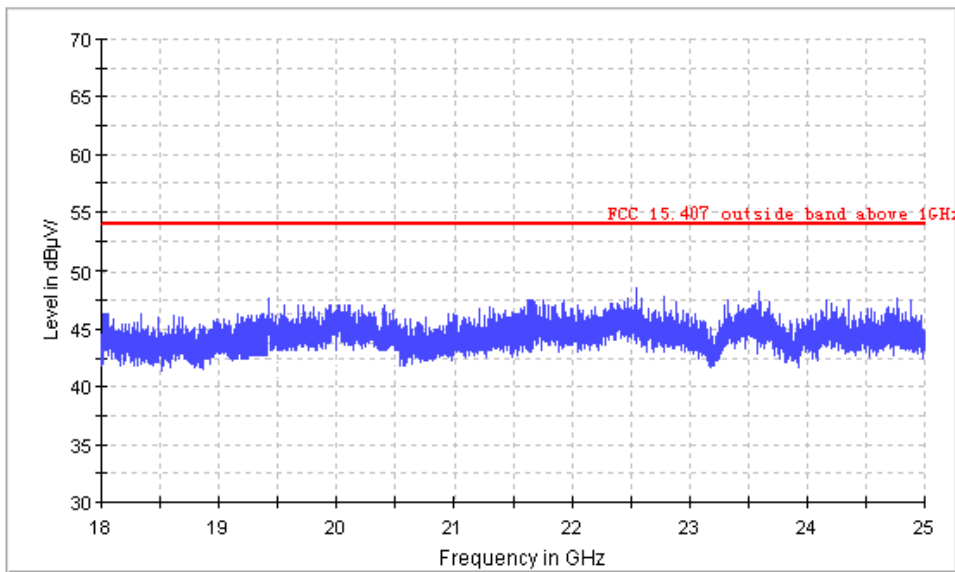

Vertical

FCC Electric Field Strength 18-26.5GHz

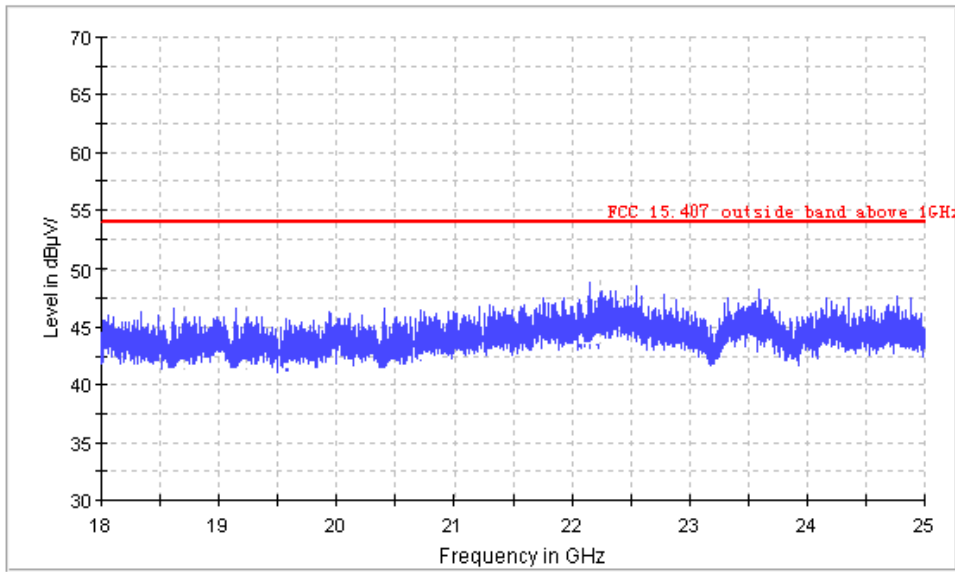

Channel (5180 MHz) 26.5-40G

Horizontal

FCC Electric Field Strength 26.5-40GHz

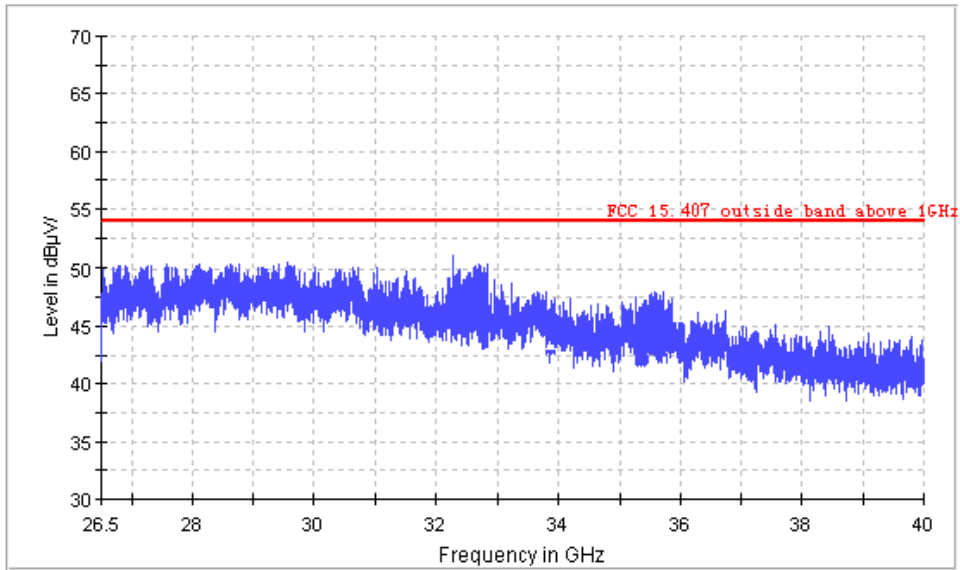

Vertical

FCC Electric Field Strength 26.5-40GHz

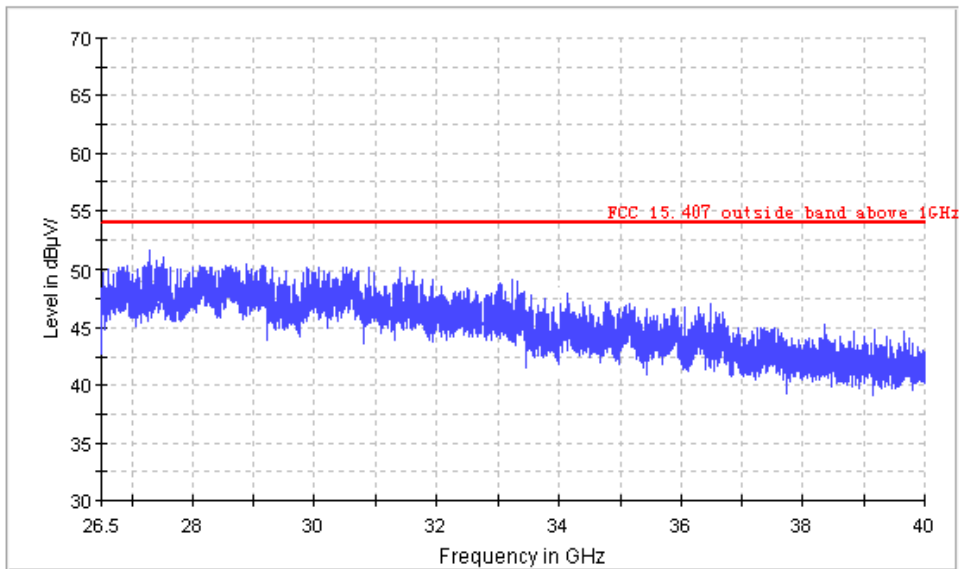

### Channel (5745 MHz) 18-26.5G

Horizontal

FCC Electric Field Strength 18-26.5GHz

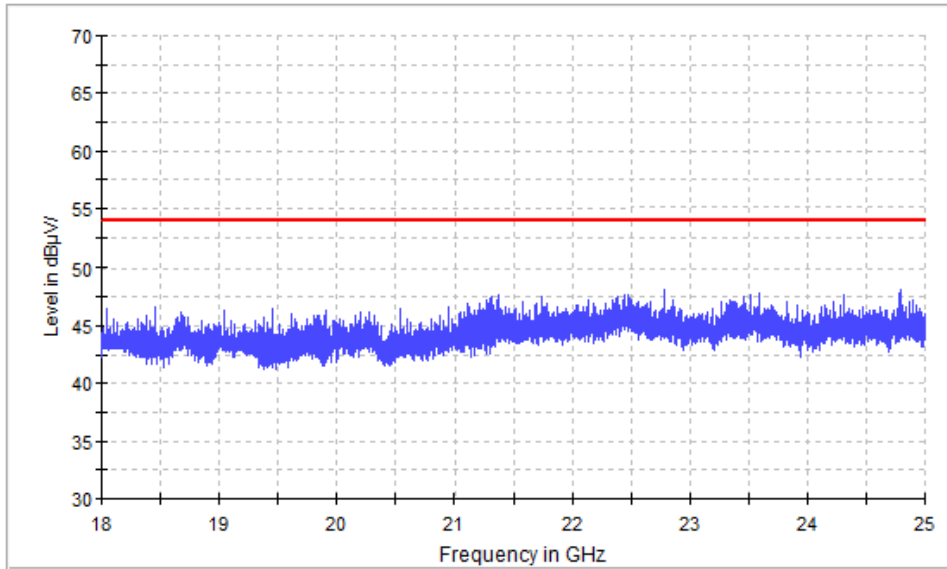

Vertical

FCC Electric Field Strength 18-26.5GHz

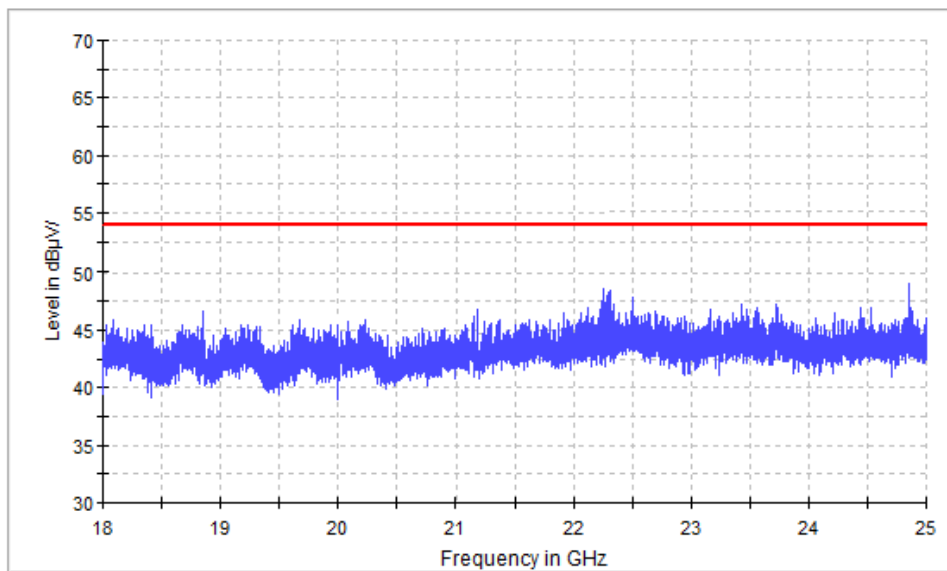



### Channel (5745 MHz) 26.5-40G

Horizontal

FCC Electric Field Strength 26.5-40GHz

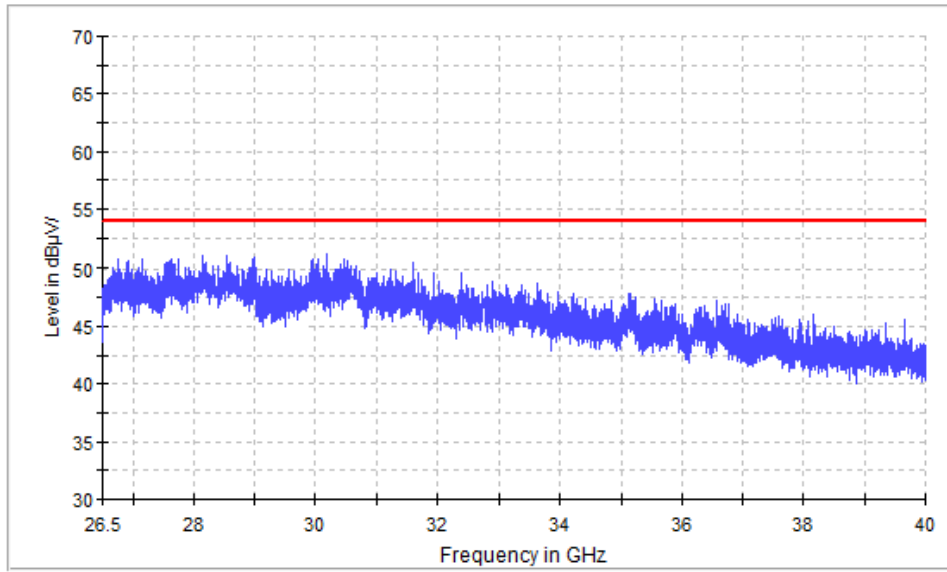

Vertical

FCC Electric Field Strength 26.5-40GHz

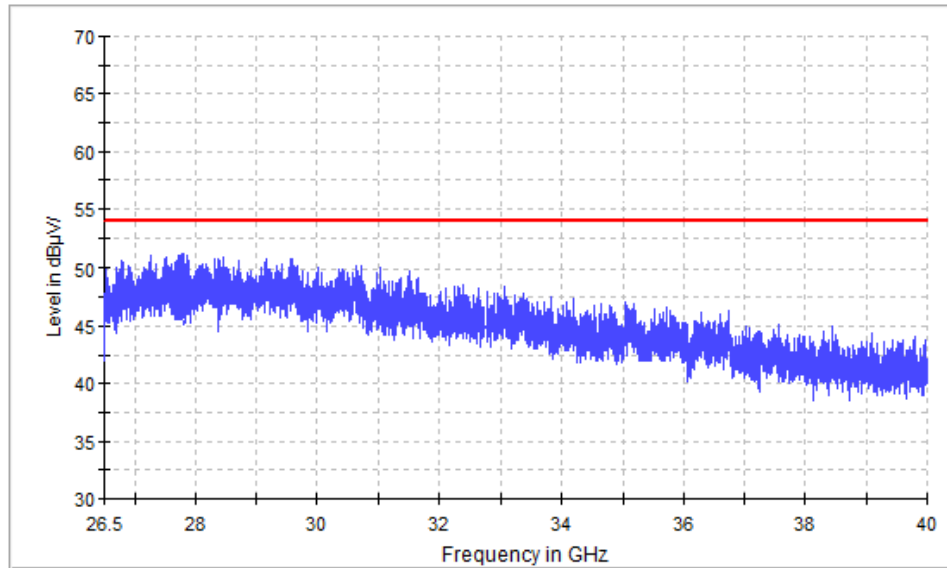

## 4. POWER SPECTRAL DENSITY TEST

### 4.1 APPLIED PROCEDURES / LIMIT

#### According to FCC §15.407(a)(3)

For the band 5.15-5.25 GHz,

(i) For an outdoor access point operating in the band 5.15-5.25 GHz, the maximum power spectral density shall not exceed 17 dBm in any 1 megahertz band. If transmitting antennas of directional gain greater than 6 dBi are used, both the maximum conducted output power and the maximum power spectral density shall be reduced by the amount in dB that the directional gain of the antenna exceeds 6 dBi. The maximum e.i.r.p. at any elevation angle above 30 degrees as measured from the horizon must not exceed 125 mW (21 dBm).

(ii) For an indoor access point operating in the band 5.15-5.25 GHz, the maximum power spectral density shall not exceed 17 dBm in any 1 megahertz band. If transmitting antennas of directional gain greater than 6 dBi are used, both the maximum conducted output power and the maximum power spectral density shall be reduced by the amount in dB that the directional gain of the antenna exceeds 6 dBi.

(iii) For fixed point-to-point access points operating in the band 5.15-5.25 GHz, the maximum power spectral density shall not exceed 17 dBm in any 1 megahertz band. Fixed point-to-point U-NII devices may employ antennas with directional gain up to 23 dBi without any corresponding reduction in the maximum conducted output power or maximum power spectral density. For fixed point-to-point transmitters that employ a directional antenna gain greater than 23 dBi, a 1 dB reduction in maximum conducted output power and maximum power spectral density is required for each 1 dB of antenna gain in excess of 23 dBi. Fixed, point-to-point operations exclude the use of point-to-multipoint systems, omnidirectional applications, and multiple collocated transmitters transmitting the same information. The operator of the U-NII device, or if the equipment is professionally installed, the installer, is responsible for ensuring that systems employing high gain directional antennas are used exclusively for fixed, point-to-point operations.

(iv) For mobile and portable client devices in the 5.15-5.25 GHz band, the maximum power spectral density shall not exceed 11 dBm in any 1 megahertz band. If transmitting antennas of directional gain greater than 6 dBi are used, both the maximum conducted output power and the maximum power spectral density shall be reduced by the amount in dB that the directional gain of the antenna exceeds 6 dBi.

For the band 5.725-5.85 GHz

(3) For the band 5.725-5.85 GHz, the maximum power spectral density shall not exceed 30 dBm in any 500-kHz band. If transmitting antennas of directional gain greater than 6 dBi are used, both the maximum conducted output power and the maximum power spectral density shall be reduced by the amount in dB that the directional gain of the antenna exceeds 6 dBi.

## 4.2 TEST PROCEDURE

For devices operating in the bands 5.15-5.25 GHz, 5.25-5.35 GHz, and 5.47-5.725 GHz, the above procedures make use of 1 MHz RBW to satisfy directly the 1 MHz reference bandwidth specified in § 15.407(a)(5). For devices operating in the band 5.725-5.85 GHz, the rules specify a measurement bandwidth of 500 kHz. Many spectrum analyzers do not have 500 kHz RBW, thus a narrower RBW may need to be used. The rules permit the use of a RBWs less than 1 MHz, or 500 kHz, “provided that the measured power is integrated over the full reference bandwidth” to show the total power over the specified measurement bandwidth (i.e., 1 MHz, or 500 kHz). If measurements are performed using a reduced resolution bandwidth (< 1 MHz, or < 500 kHz) and integrated over 1 MHz, or 500 KHz bandwidth, the following adjustments to the procedures apply:

- a) Set  $RBW \geq 1/T$ , where T is defined in section II.B.I.a).
- b) Set  $VBW \geq 3 RBW$ .
- c) If measurement bandwidth of Maximum PSD is specified in 500 kHz, add  $10\log(500\text{kHz}/RBW)$  to the measured result, whereas  $RBW (< 500 \text{ KHz})$  is the reduced resolution bandwidth of the spectrum analyzer set during measurement.
- d) If measurement bandwidth of Maximum PSD is specified in 1 MHz, add  $10\log(1\text{MHz}/RBW)$  to the measured result, whereas  $RBW (< 1 \text{ MHz})$  is the reduced resolution bandwidth of spectrum analyzer set during measurement.
- e) Care must be taken to ensure that the measurements are performed during a period of continuous transmission or are corrected upward for duty cycle.

Note: As a practical matter, it is recommended to use reduced RBW of 100 KHz for the sections 5.c) and 5.d) above, since  $RBW=100 \text{ KHZ}$  is available on nearly all spectrum analyzers.

## 4.3 DEVIATION FROM STANDARD

No deviation.

## 4.4 TEST SETUP

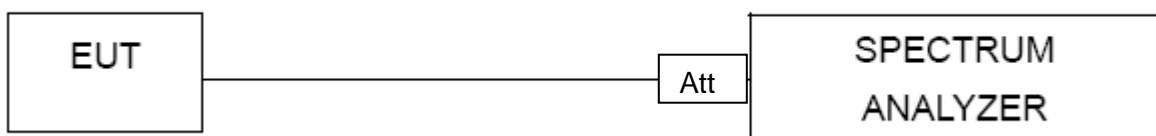

## 4.5 EUT OPERATION CONDITIONS

The EUT tested system was configured as the statements of 2.1 Unless otherwise a special operating condition is specified in the follows during the testing.

**4.6 TEST RESULTS**

EUT :	AC1200 Wifi Dual Band USB 3.0 Adapter	Model Name :	AC1200
Temperature :	25 °C	Relative Humidity :	56%
Pressure :	1015 hPa	Test Voltage :	DC 5V from Notebook
Test Mode :	TX Frequency (5150-5250MHz)		

Note: A(B) Represent the value of antenna A and B, The worst data is Antenna B ,only shown Antenna B Plot.

Mode	Frequency	Measured Power Density (dBm)	Measured Power Density(dBm)	Total Power Density (dBm)		Limit (dBm)	Result
		Antenna A	Antenna B	Antenna A	Antenna B		
802.11 a	5185 MHz	3.56	4.20	-	-	11	PASS
	5200 MHz	1.20	3.95	-	-	11	PASS
	5240 MHz	1.22	5.07	-	-	11	PASS
802.11 n20	5185 MHz	1.45	3.97	5.901		11	PASS
	5200 MHz	1.72	4.67	6.451		11	PASS
	5240 MHz	1.12	5.35	6.741		11	PASS
802.11 n40	5190 MHz	-1.44	0.77	2.814		11	PASS
	5230 MHz	-1.68	1.15	2.972		11	PASS
802.11 ac20	5185 MHz	1.60	4.56	6.338		11	PASS
	5200 MHz	1.41	4.48	6.221		11	PASS
	5240 MHz	1.46	4.53	6.271		11	PASS
802.11 ac40	5190 MHz	1.03	1.47	4.040		11	PASS
	5230 MHz	-1.39	1.65	1.620		11	PASS
802.11 ac80	5210 MHz	-3.99	-0.16	1.344		11	PASS

Note: 1.Calculate power density= Measured Power Density+10log(1MHz/RBW)

RBW=1MHz

Note: For 802.11n HT20/40 Directional gain=GANT +10log(N)dBi =1.26dBi

1.26dBi<6.0 dBi so Power Density limit= 11

(802.11a) PSD plot on channel 36

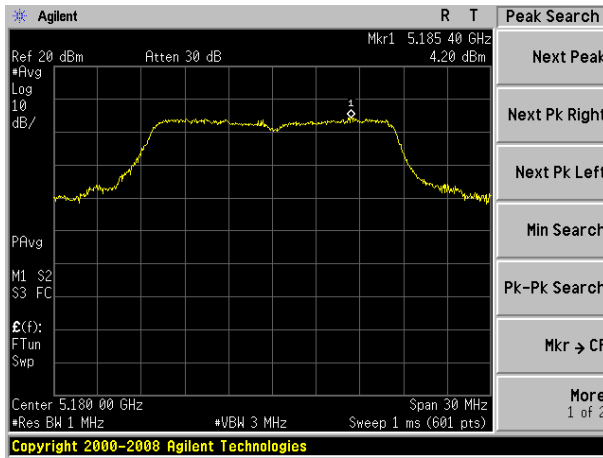

(802.11n20) PSD plot on channel 36

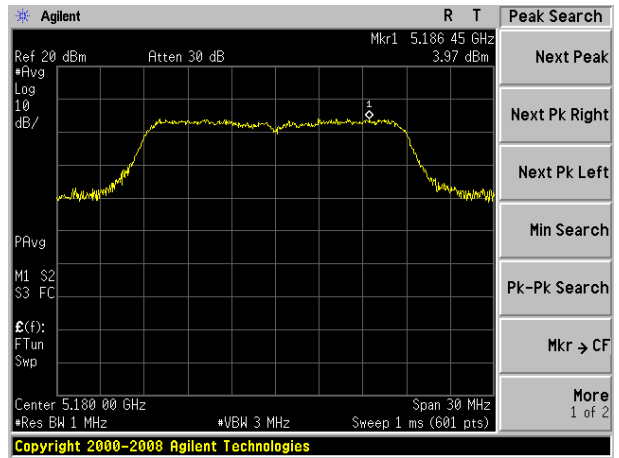

(802.11a) PSD plot on channel 40

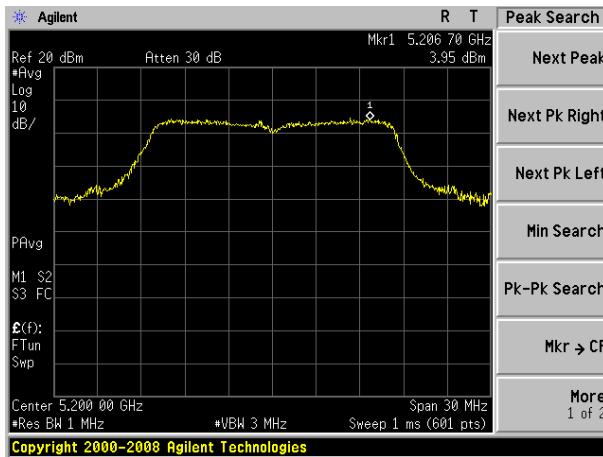

(802.11n20) PSD plot on channel 40

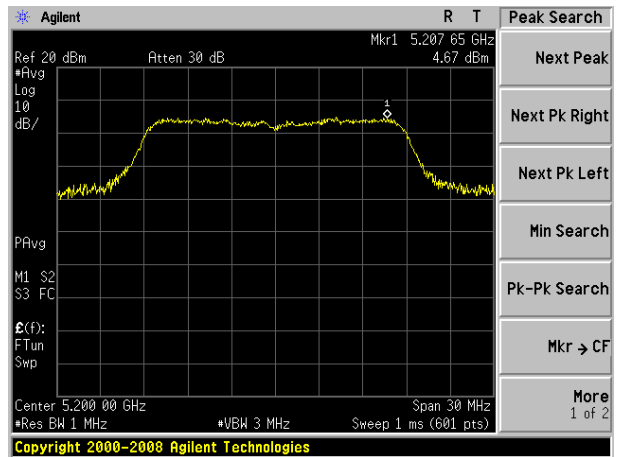

(802.11a) PSD plot on channel 48

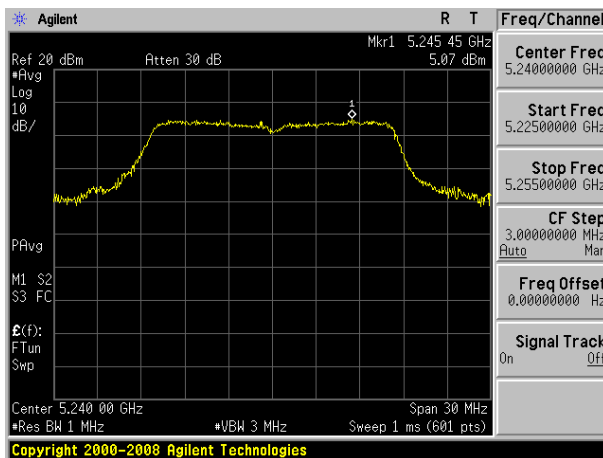

(802.11n20) PSD plot on channel 48

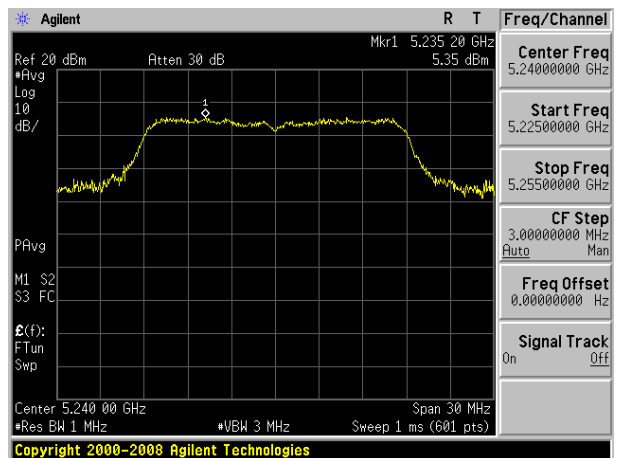

(802.11n40) PSD plot on channel 38

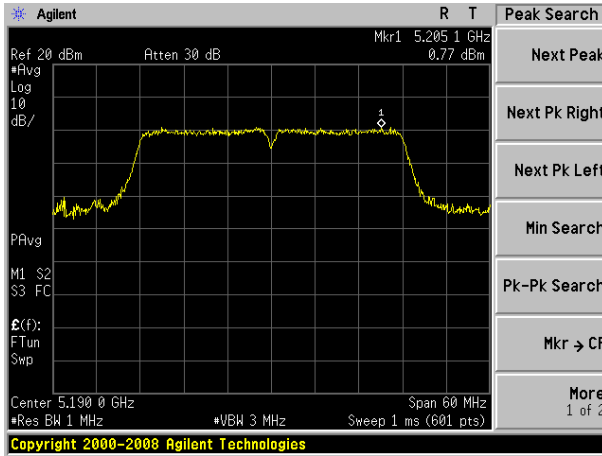

(802.11ac20) PSD plot on channel 36

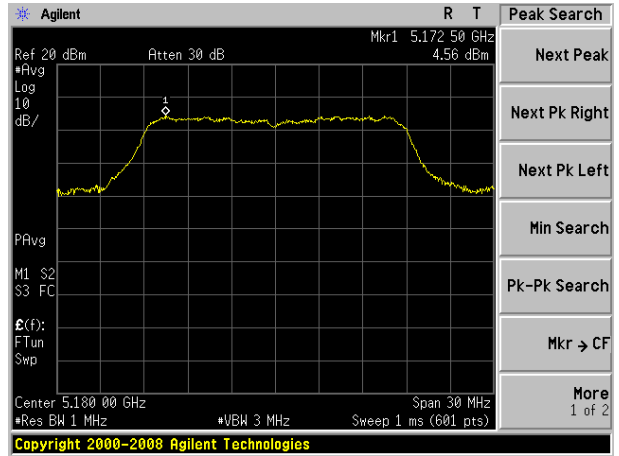

(802.11n40) PSD plot on channel 46

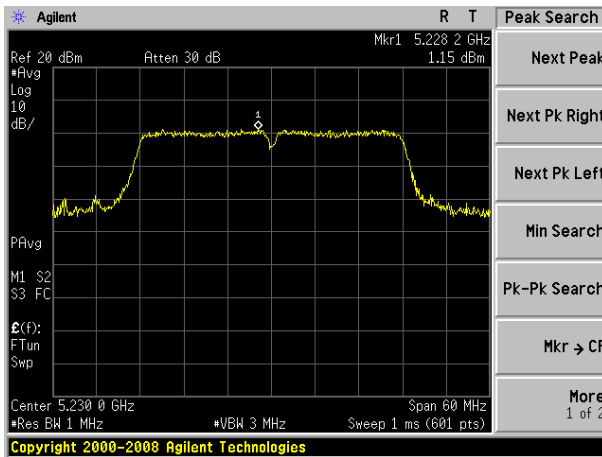

(802.11ac20) PSD plot on channel 40

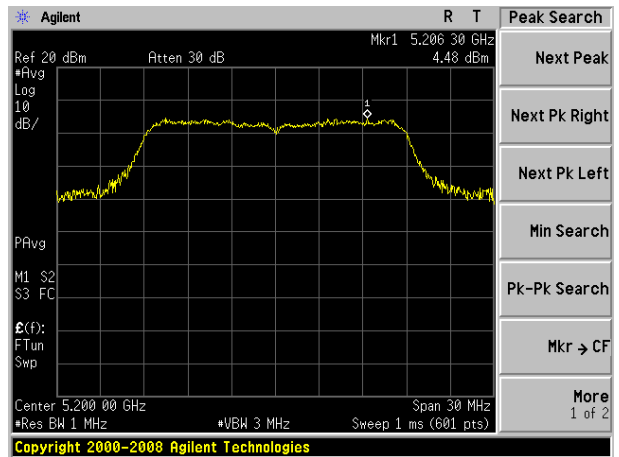

(802.11ac20) PSD plot on channel 48

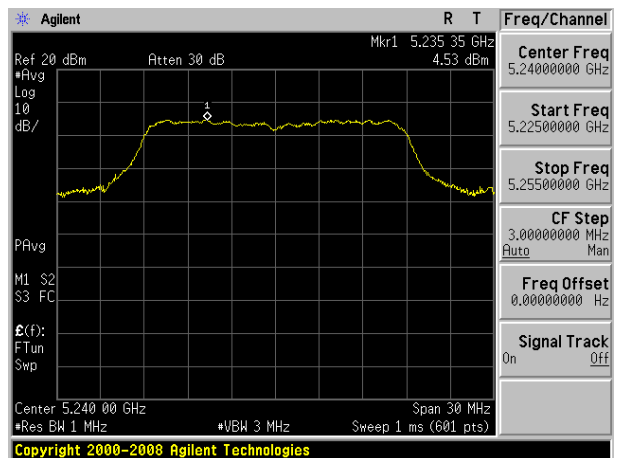

(802.11ac40) PSD plot on channel 38

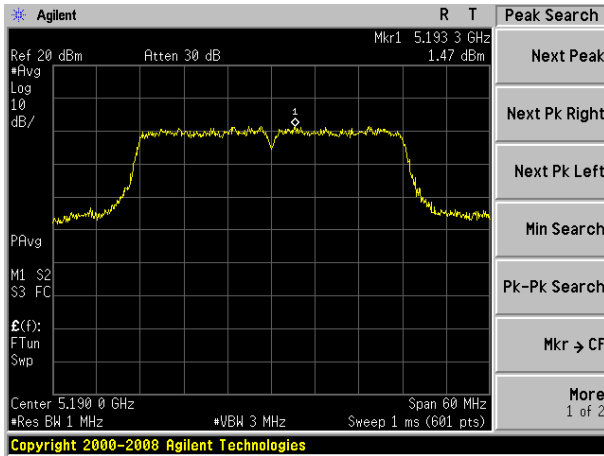

(802.11ac80) PSD plot on channel 42

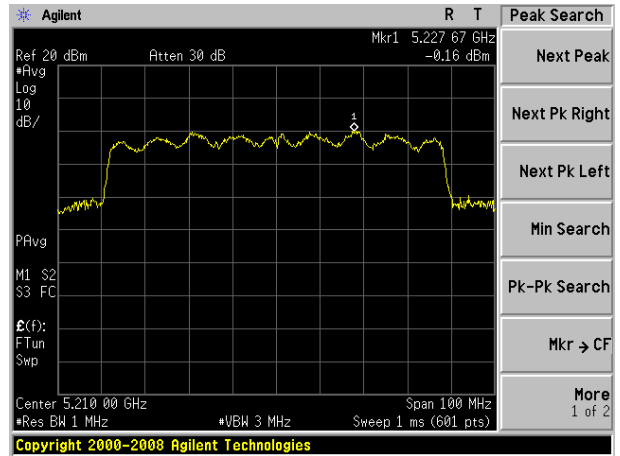

(802.11ac40) PSD plot on channel 46

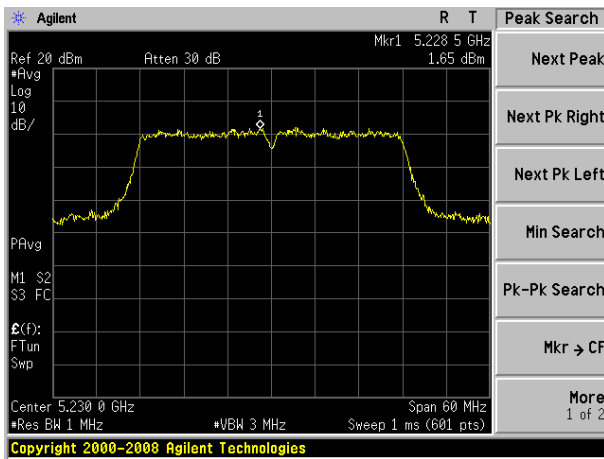

EUT :	AC1200 Wifi Dual Band USB 3.0 Adapter	Model Name :	AC1200
Temperature :	25 °C	Relative Humidity :	56%
Pressure :	1015 hPa	Test Voltage :	DC 5V from Notebook
Test Mode :	TX Frequency (5725-5825MHz)		

Note: A(B) Represent the value of antenna A and B, The worst data is Antenna B ,only shown Antenna B Plot.

Mode	Frequency	Measured Power Density (dBm)	Measured Power Density (dBm)	Factor (dBm)	Total Power Density (dBm)		Limit (dBm)	Result
		Antenna A	Antenna B		Antenna A	Antenna B		
802.11 a	5745 MHz	0.74	3.38	2.924	-	-	30	PASS
	5785 MHz	0.54	4.09	2.924	-	-	30	PASS
	5825 MHz	0.60	3.87	2.924	-	-	30	PASS
802.11 n20	5745 MHz	0.85	-0.18	2.924	3.376		30	PASS
	5785 MHz	0.48	0.45	2.924	3.475		30	PASS
	5825 MHz	0.56	0.86	2.924	3.723		30	PASS
802.11 n40	5755 MHz	-2.29	-0.78	2.924	1.541		30	PASS
	5795 MHz	-2.79	-1.55	2.924	0.884		30	PASS
802.11 ac20	5745 MHz	1.52	0.72	2.924	4.149		30	PASS
	5785 MHz	1.16	0.71	2.924	3.951		30	PASS
	5825 MHz	0.92	1.11	2.924	4.026		30	PASS
802.11 ac40	5745 MHz	-2.26	-1.55	2.924	1.120		30	PASS
	5785 MHz	-2.64	-0.18	2.924	1.772		30	PASS
802.11 ac80	5775 MHz	-6.41	-0.22	2.924	0.716		30	PASS

Note: 1. Calculate power density= Measured Power Density+10log(1MHz/RBW)

RBW=0.51MHz

Note: For 802.11n HT20/40 Directional gain=GANT +10log(N)dBi =1.26dBi

1.26dBi<6.0 dBi so Power Density limit= 30



(802.11a) PSD plot on channel 149

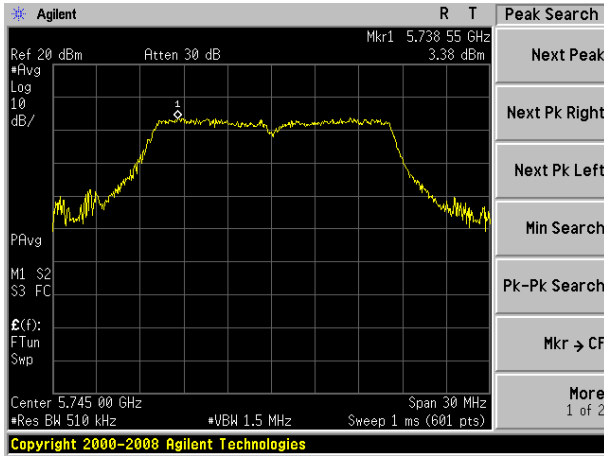

(802.11n20) PSD plot on channel 149

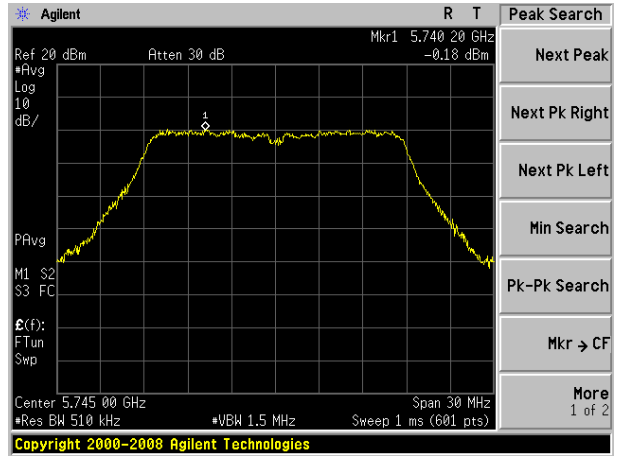

(802.11a) PSD plot on channel 157

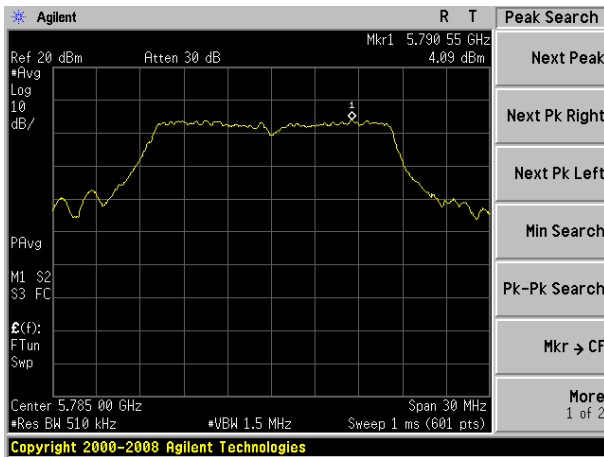

(802.11n20) PSD plot on channel 157

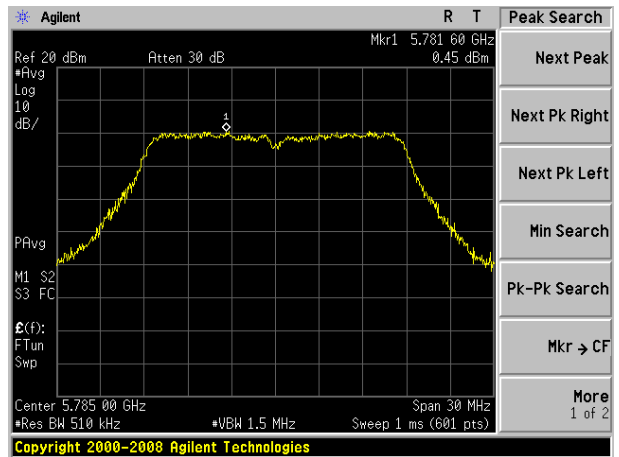

(802.11a) PSD plot on channel 165

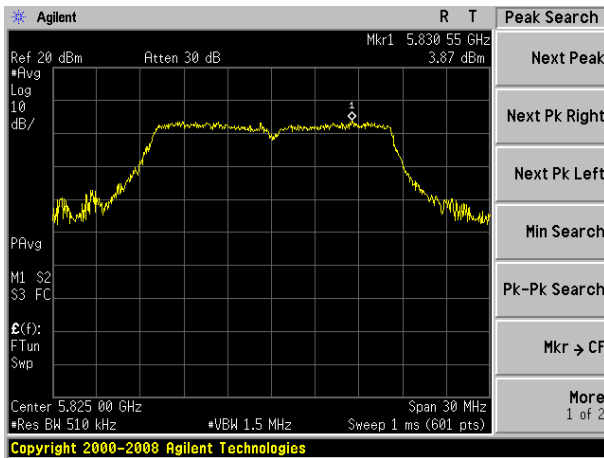

(802.11n20) PSD plot on channel 165

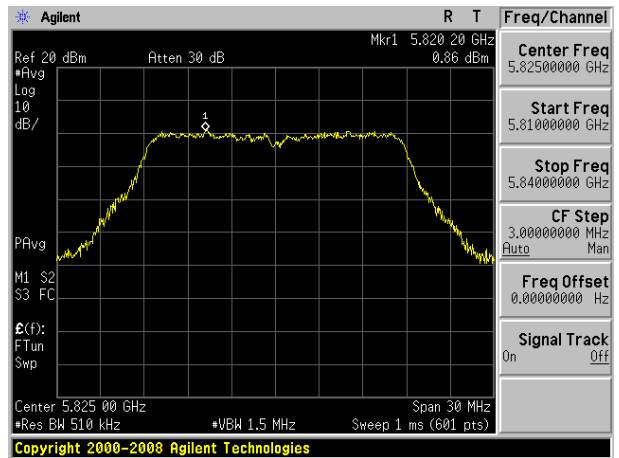

(802.11n40) PSD plot on channel 151

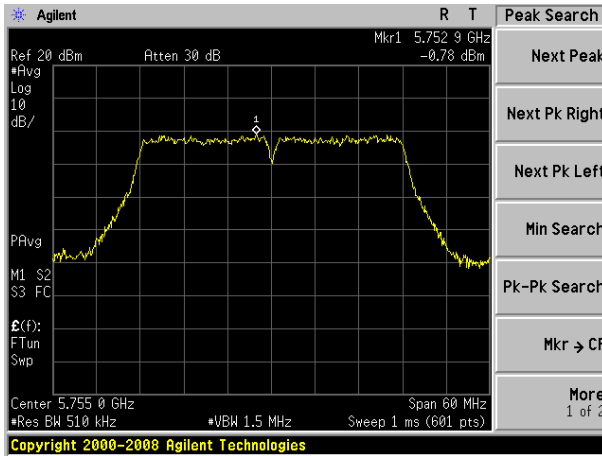

(802.11ac20) PSD plot on channel 36

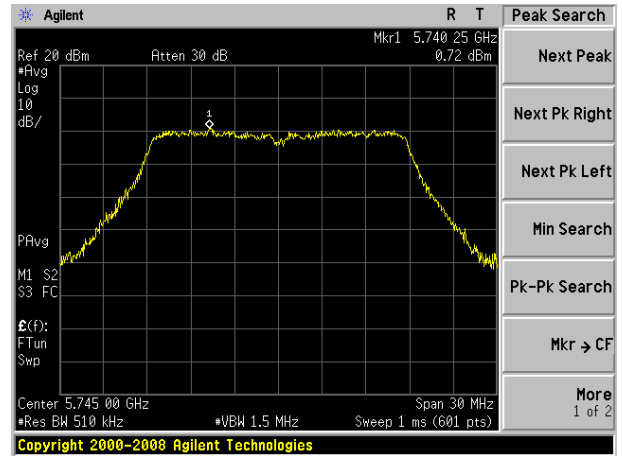

(802.11n40) PSD plot on channel 159

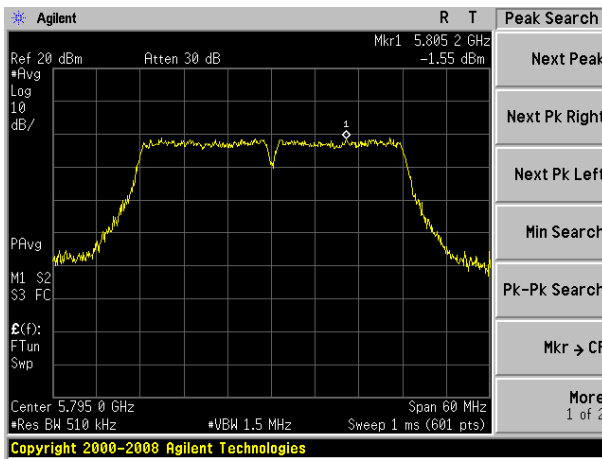

(802.11ac20) PSD plot on channel 40

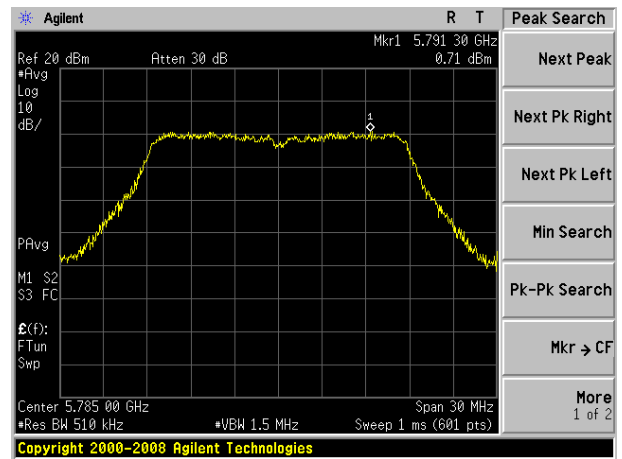

(802.11ac20) PSD plot on channel 48

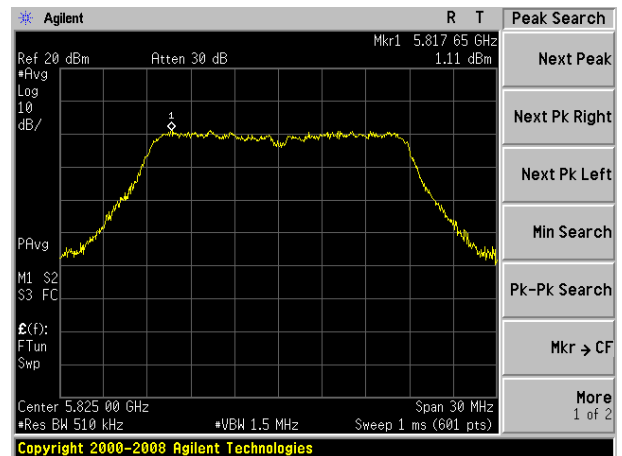

(802.11ac40) PSD plot on channel 38

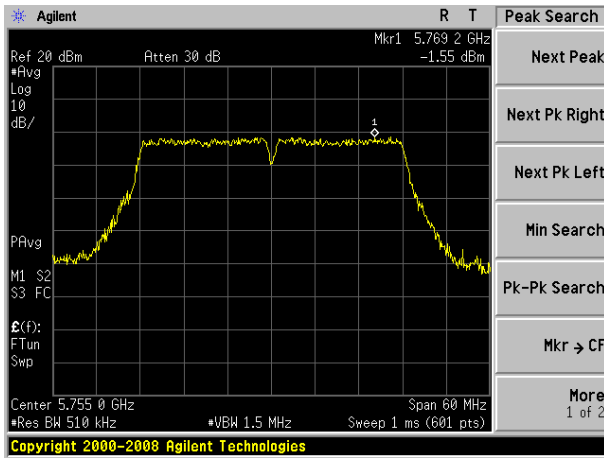

(802.11ac80) PSD plot on channel 42

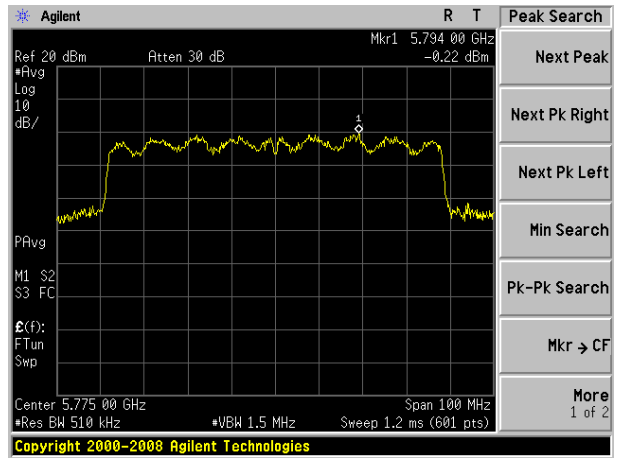

(802.11ac40) PSD plot on channel 46

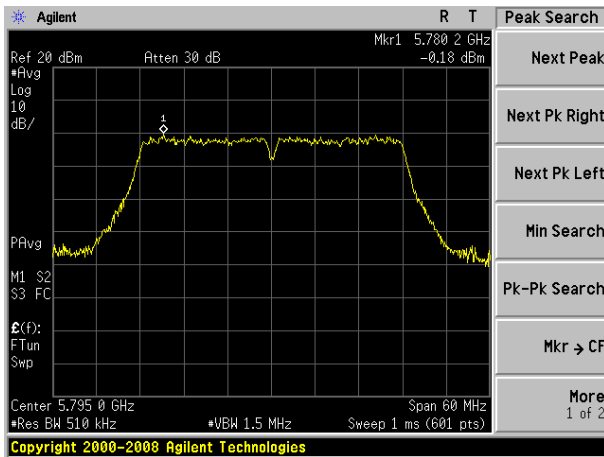

## **5. 26 DB & 99% EMISSION BANDWIDTH**

### **5.1 APPLIED PROCEDURES / LIMIT**

The maximum power spectral density is measured as a conducted emission by direct connection of a calibrated test instrument to the equipment under test. If the device cannot be connected directly, alternative techniques acceptable to the Commission may be used. Measurements in the 5.725-5.85 GHz band are made over a reference bandwidth of 500 kHz or the 26 dB emission bandwidth of the device, whichever is less. Measurements in the 5.15-5.25 GHz, 5.25-5.35 GHz, and the 5.47-5.725 GHz bands are made over a bandwidth of 1 MHz or the 26 dB emission bandwidth of the device, whichever is less. A narrower resolution bandwidth can be used, provided that the measured power is integrated over the full reference bandwidth.

### **5.2 TEST PROCEDURE**

- a) Set RBW = approximately 1% of the emission bandwidth.
- b) Set the VBW > RBW.
- c) Detector = Peak.
- d) Trace mode = max hold.
- e) Measure the maximum width of the emission that is 26 dB down from the maximum of the emission. Compare this with the RBW setting of the analyzer. Readjust RBW and repeat measurement as needed until the RBW/EBW ratio is approximately 1%.

The following procedure shall be used for measuring (99 %) power bandwidth:

1. Set center frequency to the nominal EUT channel center frequency.
2. Set span = 1.5 times to 5.0 times the OBW.
3. Set RBW = 1 % to 5 % of the OBW
4. Set VBW  $\geq 3 \cdot$  RBW
5. Video averaging is not permitted. Where practical, a sample detection and single sweep mode shall be used. Otherwise, peak detection and max hold mode (until the trace stabilizes) shall be used.
6. Use the 99 % power bandwidth function of the instrument (if available).
7. If the instrument does not have a 99 % power bandwidth function, the trace data points are recovered and directly summed in power units. The recovered amplitude data points, beginning at the lowest frequency, are placed in a running sum until 0.5 % of the total is reached; that frequency is recorded as the lower frequency. The process is repeated until 99.5 % of the total is reached; that frequency is recorded as the upper frequency. The 99% occupied bandwidth is the difference between these two frequencies.

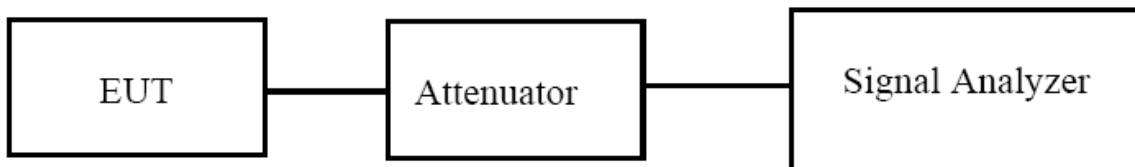

**5.3 EUT OPERATION CONDITIONS**

The EUT tested system was configured as the statements of 2.4 Unless otherwise a special operating condition is specified in the follows during the testing.

### 5.4 TEST RESULTS

EUT :	AC1200 Wifi Dual Band USB 3.0 Adapter	Model Name :	AC1200
Temperature :	25 °C	Relative Humidity :	56%
Pressure :	1012 hPa	Test Voltage :	DC 5V from Notebook
Test Mode :	TX Frequency (5150-5250MHz)		

Note: A(B) Represent the value of antenna A and B, The worst data is Antenna B, only shown Antenna B Plot.

Mode	Channel	Frequency (MHz)	99% bandwidth (MHz)	99% bandwidth (MHz)	26dB bandwidth (MHz)	26dB bandwidth (MHz)	Result
			Antenna A	Antenna B	Antenna A	Antenna B	
802.11a	CH36	5180	17.7412	18.8029	30.000	30.000	Pass
	CH40	5200	18.1121	18.7623	30.000	30.000	Pass
	CH48	5240	19.1173	18.8507	30.000	30.000	Pass
802.11 n20	CH36	5180	17.9661	18.2548	28.817	30.000	Pass
	CH40	5200	17.9886	18.3336	28.906	30.000	Pass
	CH48	5240	18.1084	18.3234	29.917	29.999	Pass
802.11 n40	CH 38	5190	36.2592	36.4446	50.684	60.000	Pass
	CH 46	5230	36.3205	36.3774	58.203	59.816	Pass
802.11 ac20	CH36	5180	17.9441	18.3082	23.008	29.995	Pass
	CH40	5200	17.9837	18.3189	28.362	29.973	Pass
	CH48	5240	18.3031	18.3774	30.000	30.000	Pass
802.11 ac40	CH 38	5190	36.2727	36.3780	42.961	58.128	Pass
	CH 46	5230	36.2943	36.3838	52.255	59.597	Pass
802.11 ac80	CH52	5210	75.1418	75.3678	88.062	96.152	Pass

(802.11a) -26dB&99% Bandwidth plot on channel 36

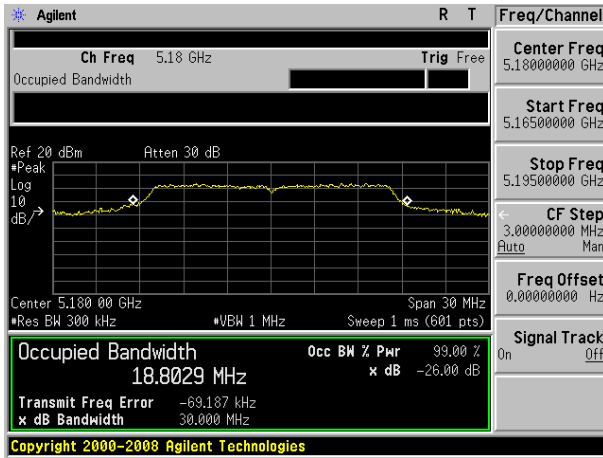

(802.11n20) -26dB&99% Bandwidth plot on channel 36

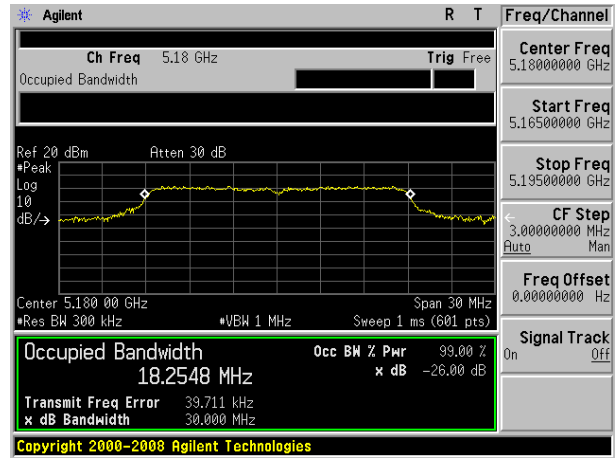

(802.11a) -26dB&99% Bandwidth plot on channel 40

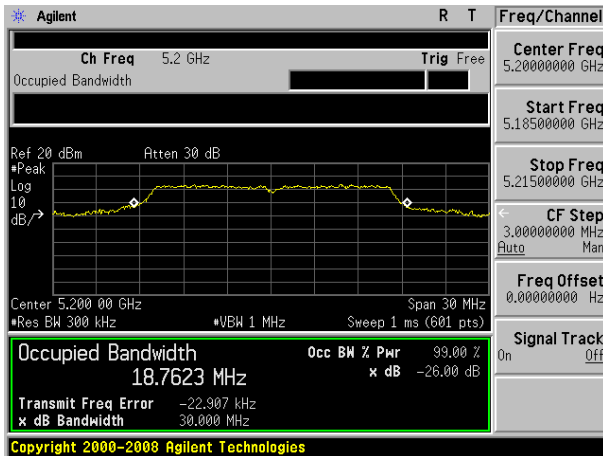

(802.11n20) -26dB&99% Bandwidth plot on channel 40

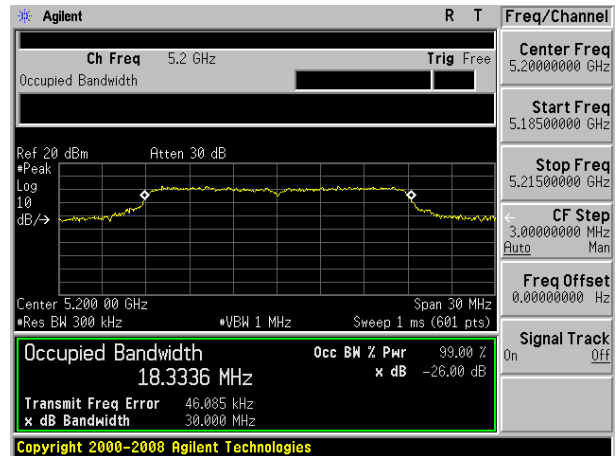

(802.11a) -26dB&99% Bandwidth plot on channel 48

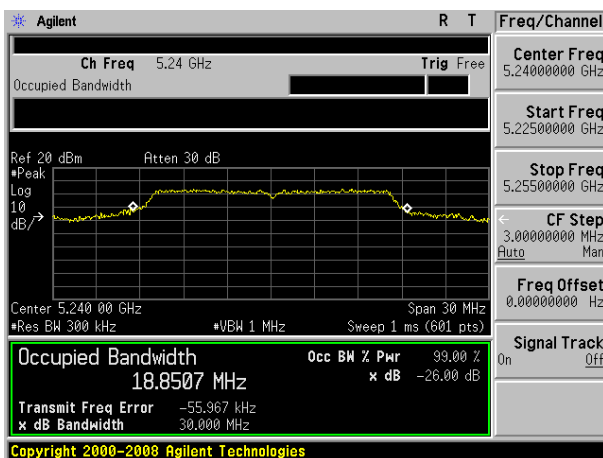

(802.11n20) -26dB&99% Bandwidth plot on channel 48

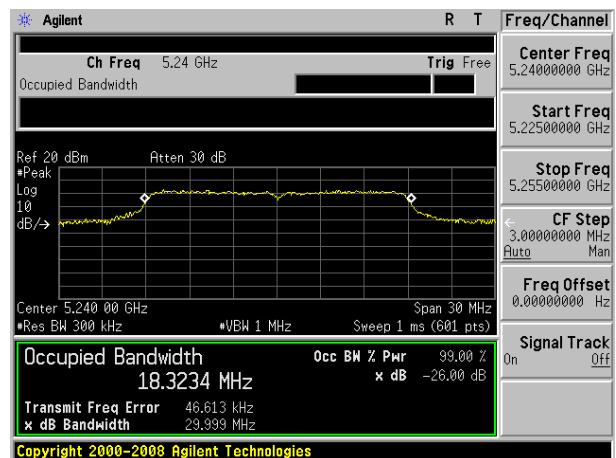

(802.11n40) -26dB&99% Bandwidth plot on channel 38

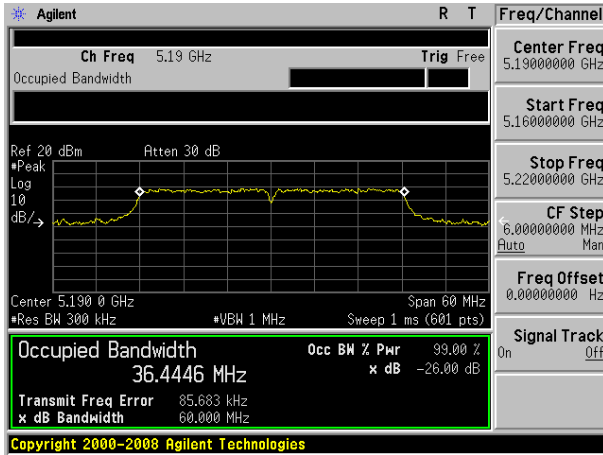

(802.11ac20) -26dB&99% Bandwidth plot on channel 36

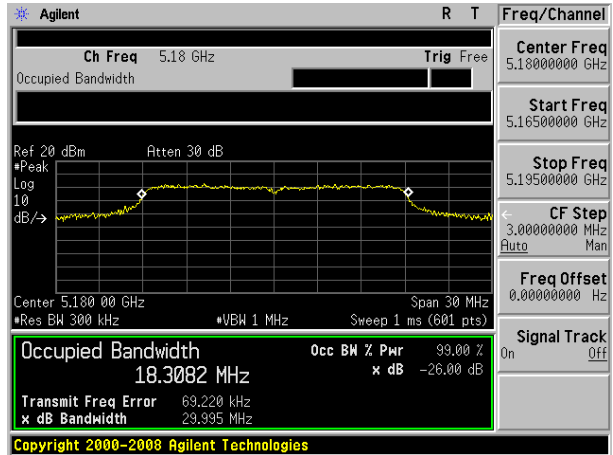

(802.11n40) -26dB&99% Bandwidth plot on channel 46

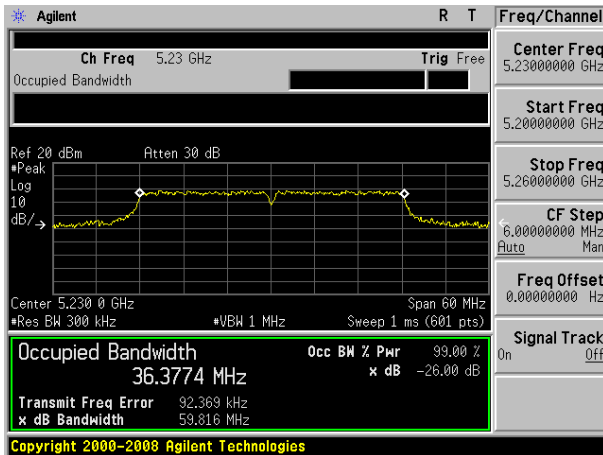

(802.11ac20) -26dB&99% Bandwidth plot on channel 40

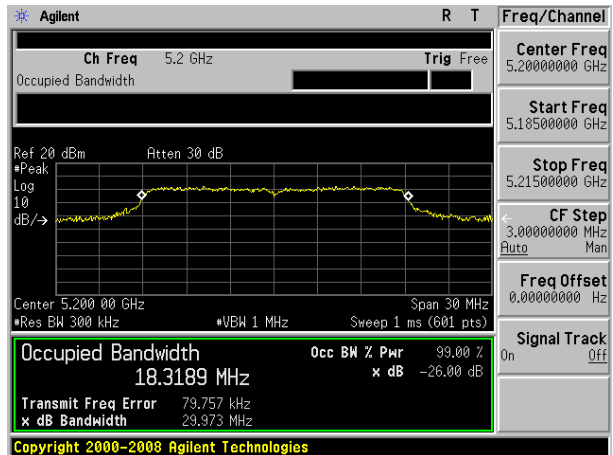

(802.11ac20) -26dB&99% Bandwidth plot on channel 48

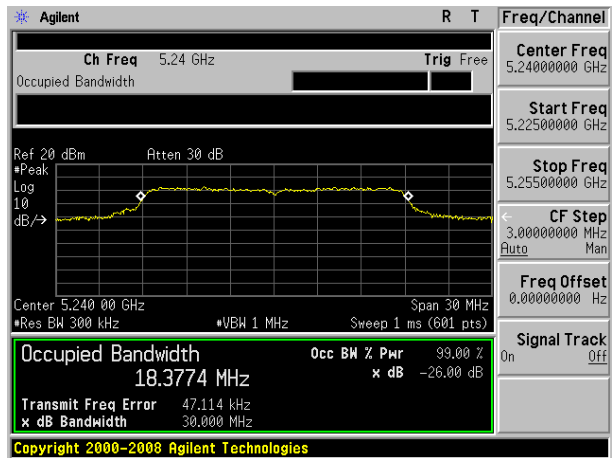



(802.11ac40) -26dB&99% Bandwidth plot on channel 38

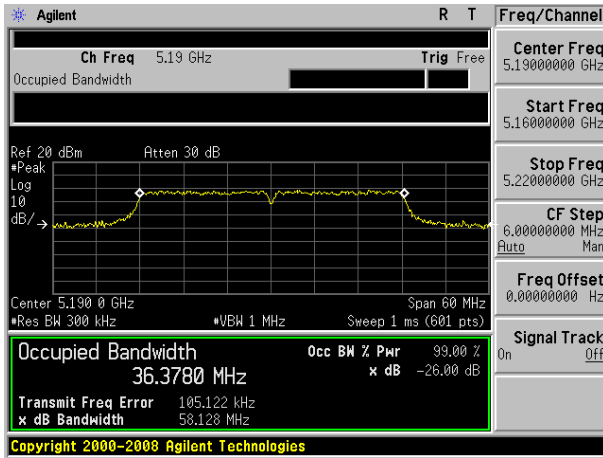

(802.11ac80) -26dB&99% Bandwidth plot on channel 42

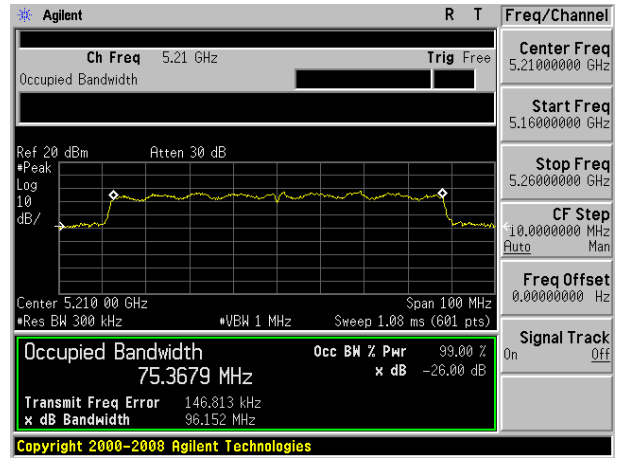

(802.11ac40) -26dB&99% Bandwidth plot on channel 46

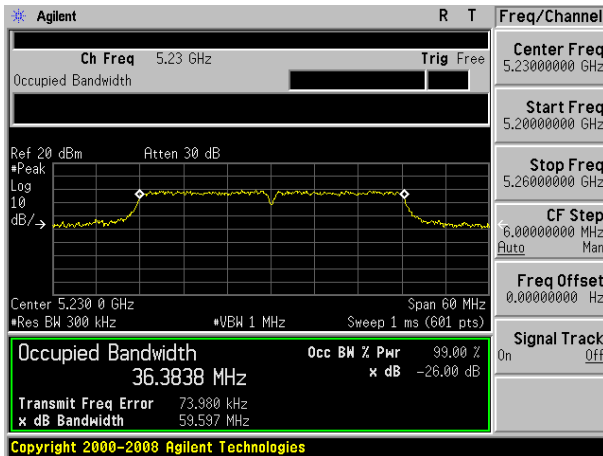

EUT :	AC1200 Wifi Dual Band USB 3.0 Adapter	Model Name :	AC1200
Temperature :	25 °C	Relative Humidity :	56%
Pressure :	1012 hPa	Test Voltage :	DC 5V from Notebook
Test Mode :	TX Frequency (5745-5850MHz)		

Note: A(B) Represent the value of antenna A and B, The worst data is Antenna A ,only shown Antenna A Plot.

Mode	Channel	Frequency (MHz)	99% bandwidth (MHz)	99% bandwidth (MHz)	26dB bandwidth (MHz)	26dB bandwidth (MHz)	Result
			Antenna A	Antenna B	Antenna A	Antenna B	
802.11a	CH149	5745	17.7887	16.9749	30.000	26.977	Pass
	CH157	5785	17.7216	16.9161	30.000	25.662	Pass
	CH165	5825	17.9505	16.9819	30.000	27.853	Pass
802.11 n20	CH149	5745	18.3167	17.9583	30.000	22.547	Pass
	CH157	5785	18.3056	18.0015	30.000	22.793	Pass
	CH165	5825	18.5130	17.9659	30.000	22.583	Pass
802.11 n40	CH151	5755	37.9512	36.2392	60.000	42.202	Pass
	CH159	5795	37.5696	36.2660	60.000	42.234	Pass
802.11 ac20	CH149	5745	18.4428	17.9974	30.000	22.472	Pass
	CH157	5785	18.4288	17.9802	30.000	22.191	Pass
	CH165	5825	18.6376	18.0036	30.000	22.773	Pass
802.11 ac40	CH151	5755	37.7166	36.1998	60.000	42.949	Pass
	CH159	5795	37.7029	36.2405	60.000	42.207	Pass
802.11 ac80	CH155	5775	75.5333	75.1800	100.000	80.097	Pass

(802.11a) -26dB&99% Bandwidth plot on channel 149

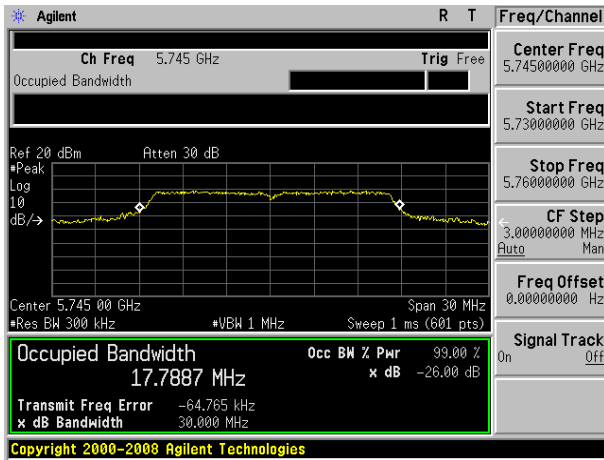

(802.11n20) -26dB&99% Bandwidth plot on channel 149

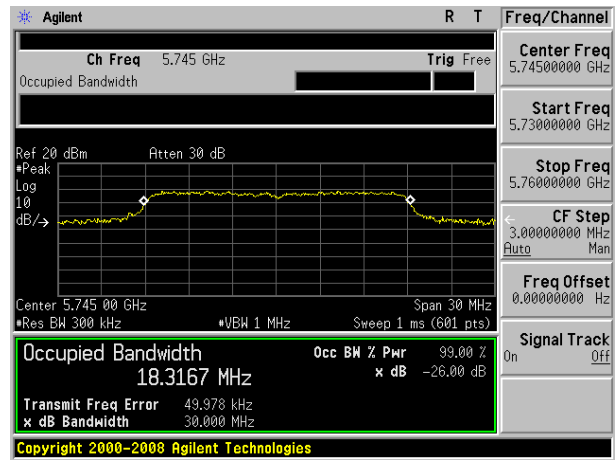

(802.11a) -26dB&99% Bandwidth plot on channel 157

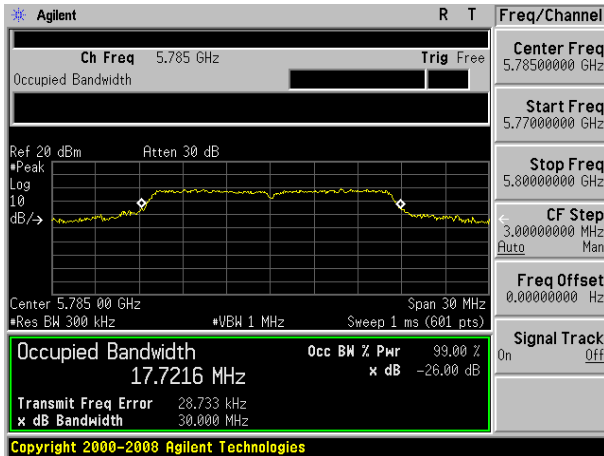

(802.11n20) -26dB&99% Bandwidth plot on channel 157

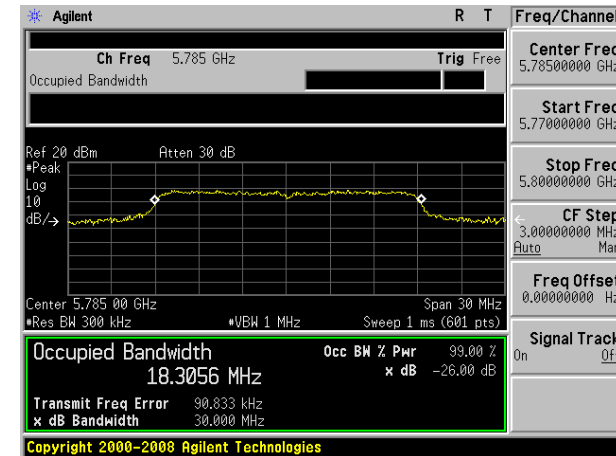

(802.11a) -26dB&99% Bandwidth plot on channel 165

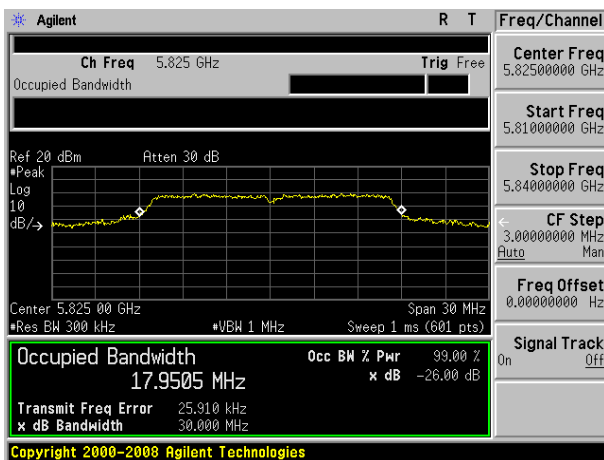

(802.11n20) -26dB&99% Bandwidth plot on channel 165

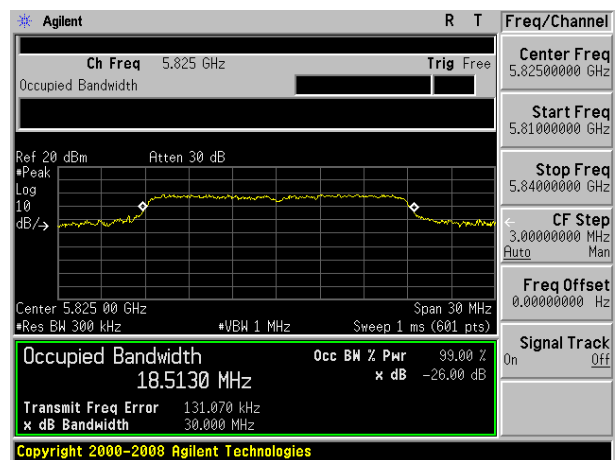

(802.11n40) -26dB&99% Bandwidth plot on channel 151

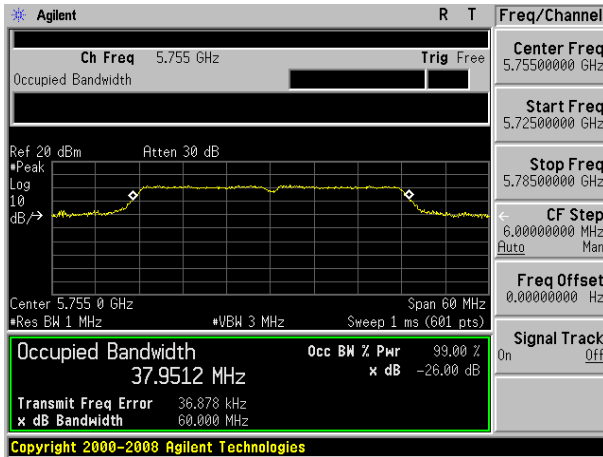

(802.11ac20) -26dB&99% Bandwidth plot on channel 149

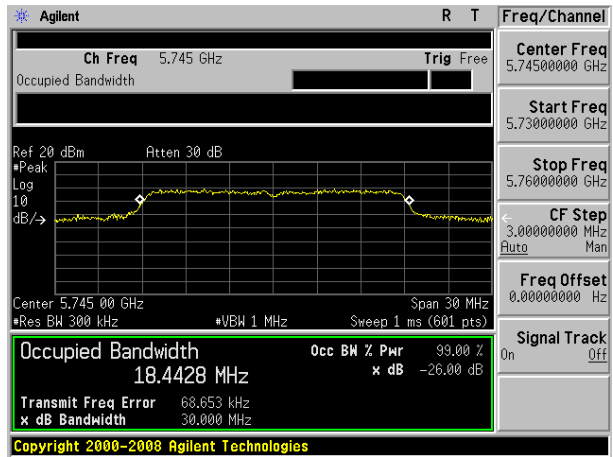

(802.11n40) -26dB&99% Bandwidth plot on channel 159

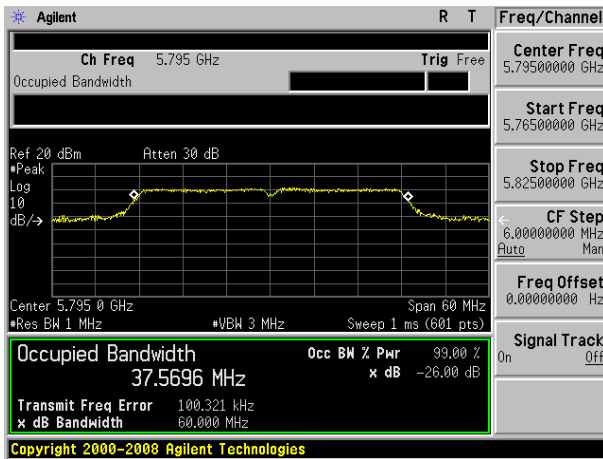

(802.11ac20) -26dB&99% Bandwidth plot on channel 157

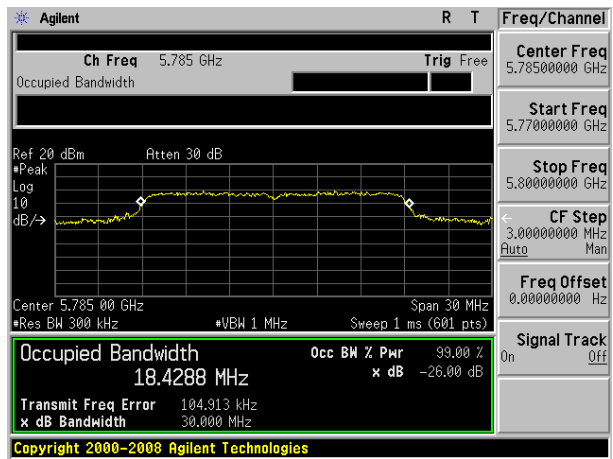

(802.11ac20) -26dB&99% Bandwidth plot on channel 165

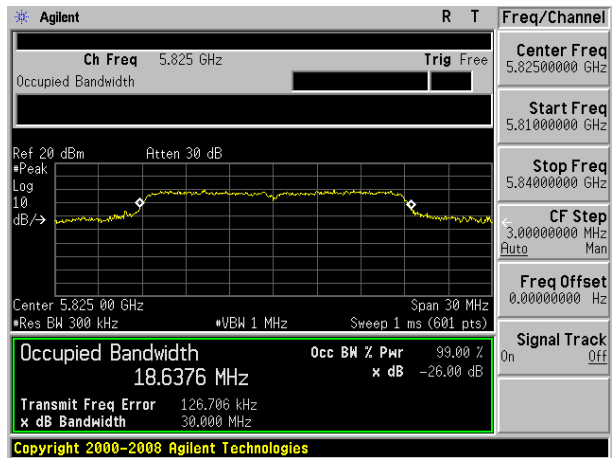

(802.11ac40) -26dB&99% Bandwidth plot on channel 151

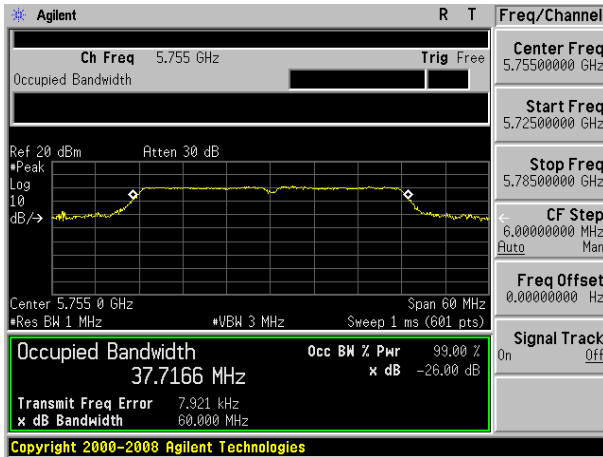

(802.11ac80) -26dB&99% Bandwidth plot on channel 155

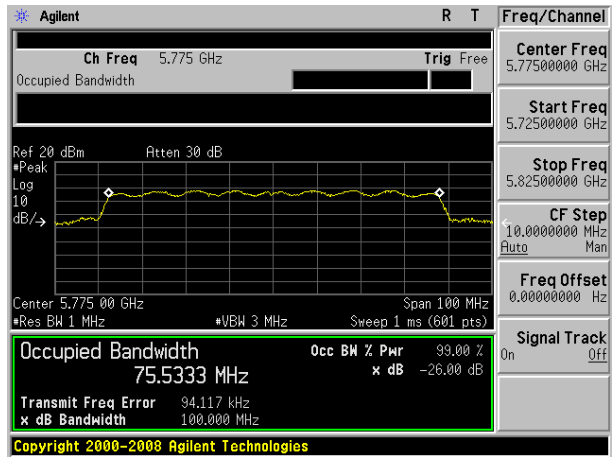

(802.11ac40) -26dB&99% Bandwidth plot on channel 159

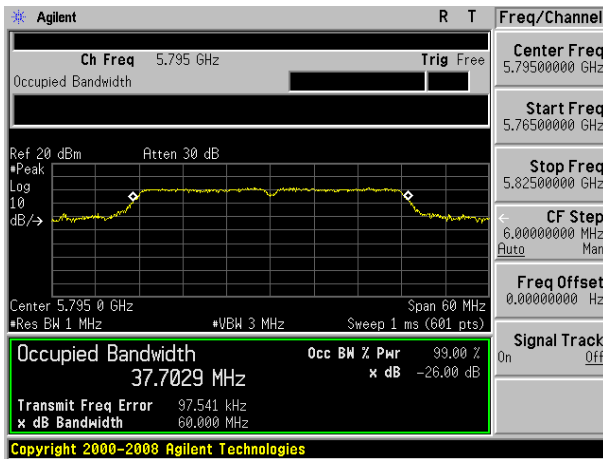

**6. MINIMUM 6 DB BANDWIDTH**

**6.1 APPLIED PROCEDURES / LIMIT**

**According to FCC §15.407(e)**

(e) Within the 5.725-5.85 GHz band, the minimum 6 dB bandwidth of U-NII devices shall be at least 500 kHz.

**6.2 TEST PROCEDURE**

Section 15.407(e) specifies the minimum 6 dB emission bandwidth of at least 500 KHz for the band 5.715-5.85 GHz. The following procedure shall be used for measuring this bandwidth:

- a) Set RBW = 100 kHz.
- b) Set the video bandwidth (VBW)  $\geq 3 \times$  RBW.
- c) Detector = Peak.
- d) Trace mode = max hold.
- e) Sweep = auto couple.
- f) Allow the trace to stabilize.
- g) Measure the maximum width of the emission that is constrained by the frequencies associated with the two outermost amplitude points (upper and lower frequencies) that are attenuated by 6 dB relative to the maximum level measured in the fundamental emission.

**6.3 DEVIATION FROM STANDARD**

No deviation.

**6.4 TEST SETUP**

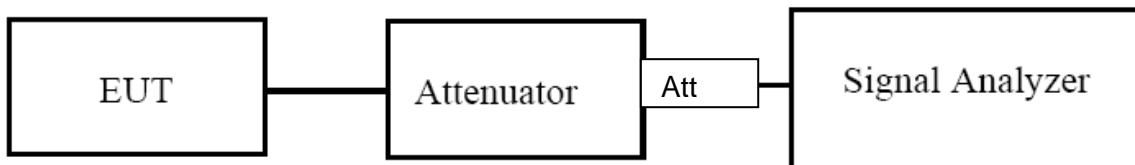

**6.5 EUT OPERATION CONDITIONS**

The EUT tested system was configured as the statements of 2.4 Unless otherwise a special operating condition is specified in the follows during the testing.

### 6.6 TEST RESULTS

EUT :	AC1200 Wifi Dual Band USB 3.0 Adapter	Model Name :	AC1200
Temperature :	25 °C	Relative Humidity :	56%
Pressure :	1012 hPa	Test Voltage :	DC 5V from Notebook
Test Mode :	TX Frequency (5150-5250MHz)		

Note: A(B) Represent the value of antenna A and B, The worst data is Antenna A ,only shown Antenna A Plot.

Mode	Channel	Frequency (MHz)	-6dB bandwidth (MHz)	-6dB bandwidth (MHz)	Result
			Antenna A	Antenna B	
802.11a	CH36	5180	16.573	16.573	Pass
	CH40	5200	16.590	16.605	Pass
	CH48	5240	16.568	16.575	Pass
802.11 n20	CH36	5180	17.747	17.817	Pass
	CH40	5200	17.831	17.860	Pass
	CH48	5240	17.761	17.867	Pass
802.11 n40	CH 38	5190	36.547	36.560	Pass
	CH 46	5230	36.539	36.584	Pass
802.11 ac20	CH36	5180	17.752	17.825	Pass
	CH40	5200	17.831	17.796	Pass
	CH48	5240	17.774	17.826	Pass
802.11 ac40	CH 38	5190	36.574	36.561	Pass
	CH 46	5230	36.570	36.545	Pass
802.11 ac80	CH 42	5210	75.894	75.981	Pass

(802.11a) -6dB Bandwidth plot on channel 36

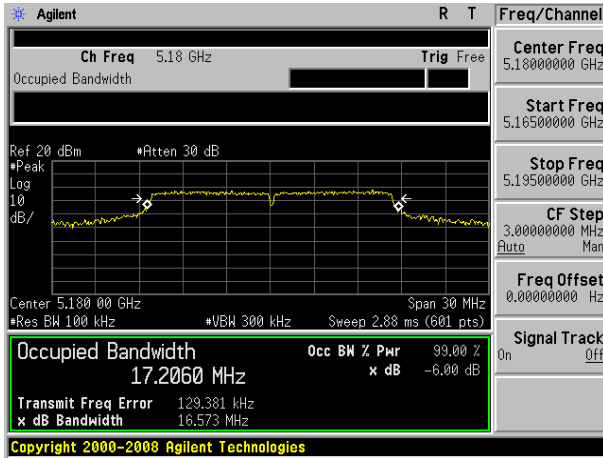

(802.11n20) -6dB Bandwidth plot on channel 36

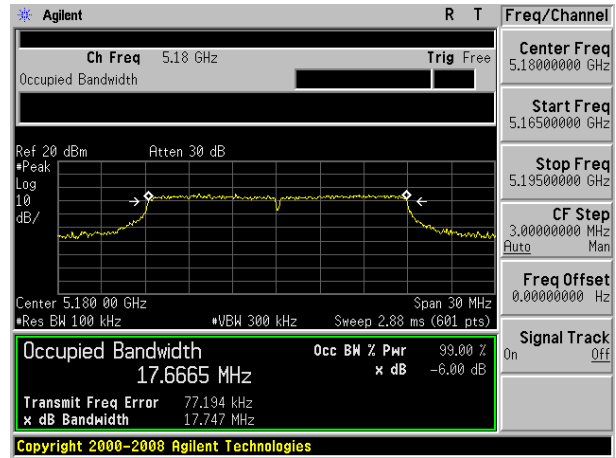

(802.11a) -6dB Bandwidth plot on channel 40

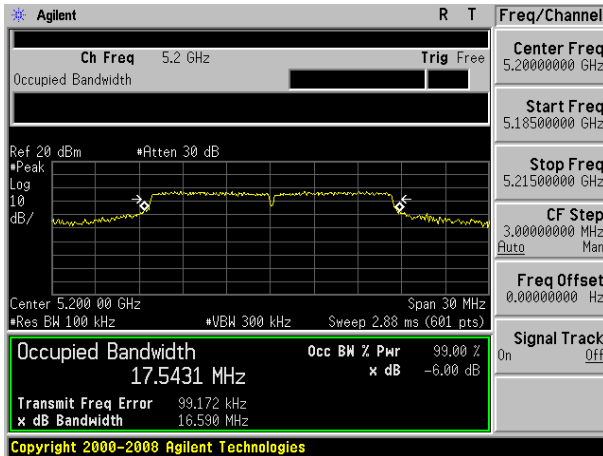

(802.11n20) -6dB Bandwidth plot on channel 40

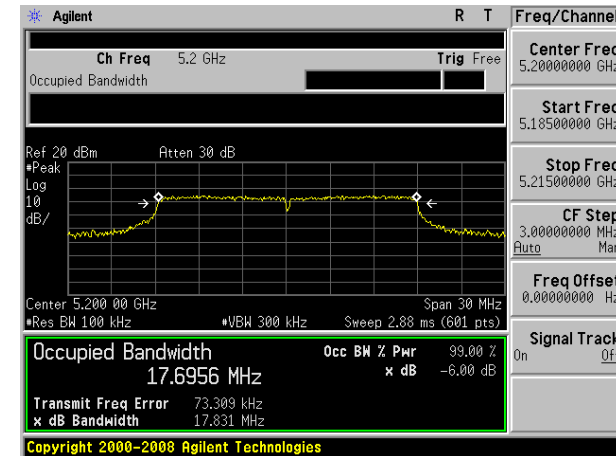

(802.11a) -6dB Bandwidth plot on channel 48

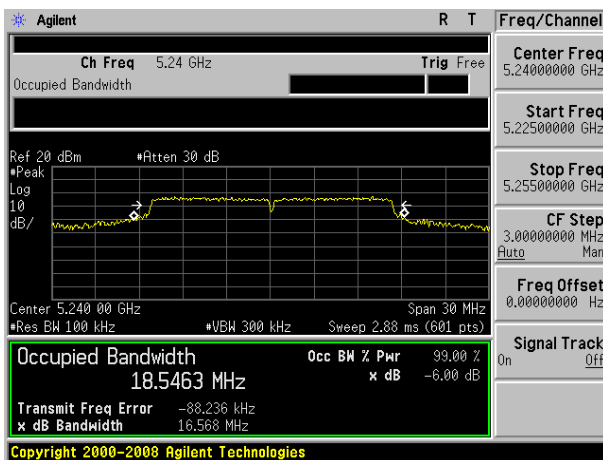

(802.11n20) -6dB Bandwidth plot on channel 48

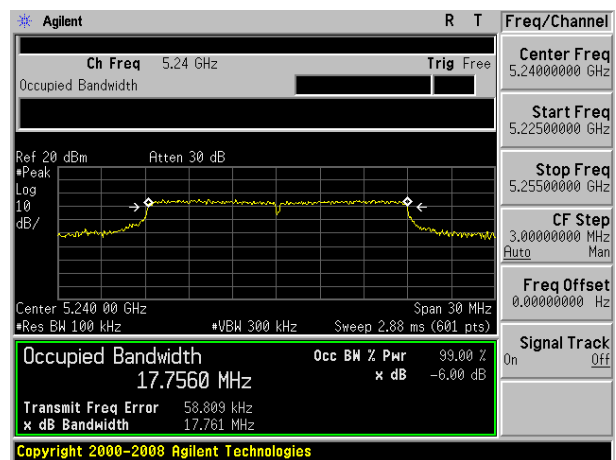



(802.11n40) -6dB Bandwidth plot on channel 38

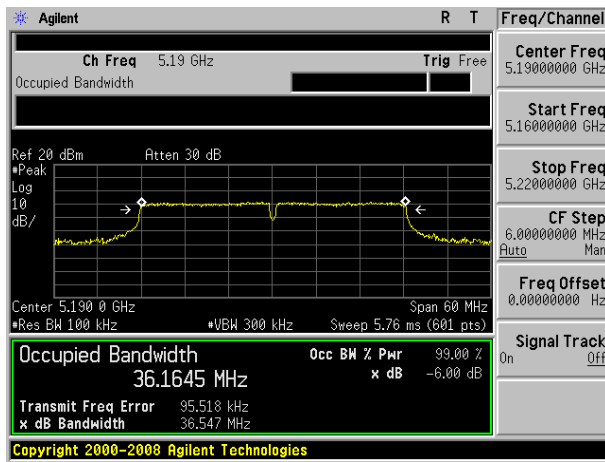

(802.11ac20) -6dB Bandwidth plot on channel 36

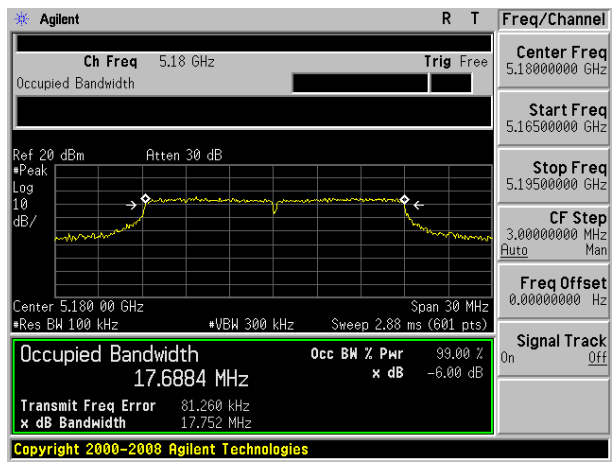

(802.11n40) -6dB Bandwidth plot on channel 46

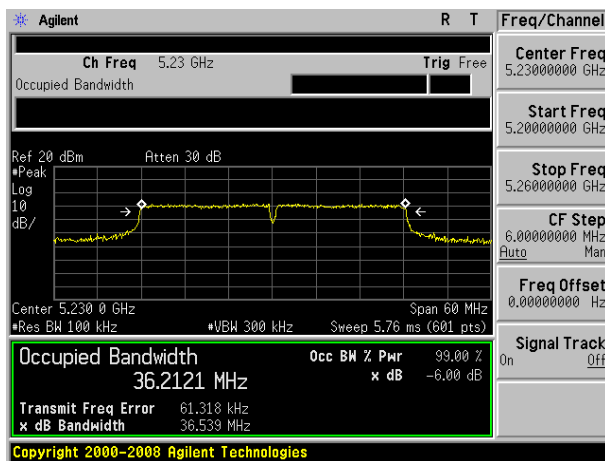

(802.11ac20) -6dB Bandwidth plot on channel 40

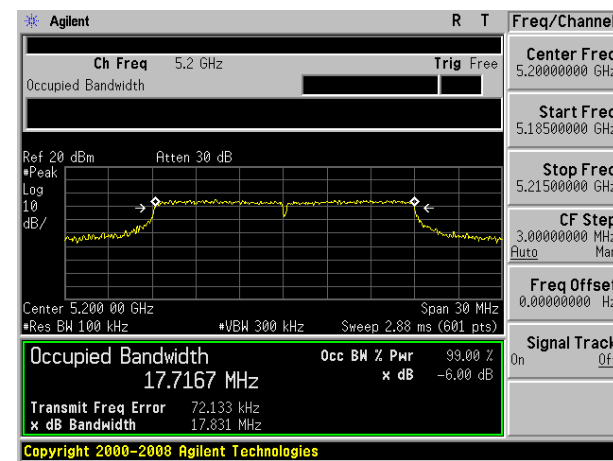

(802.11ac20) -6dB Bandwidth plot on channel 48

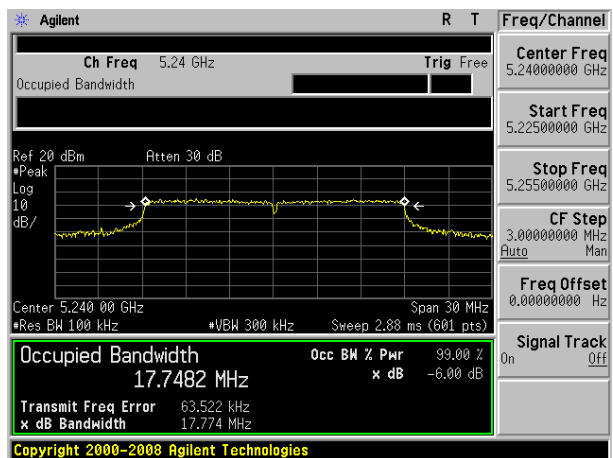

(802.11ac40) -6dB Bandwidth plot on channel 38

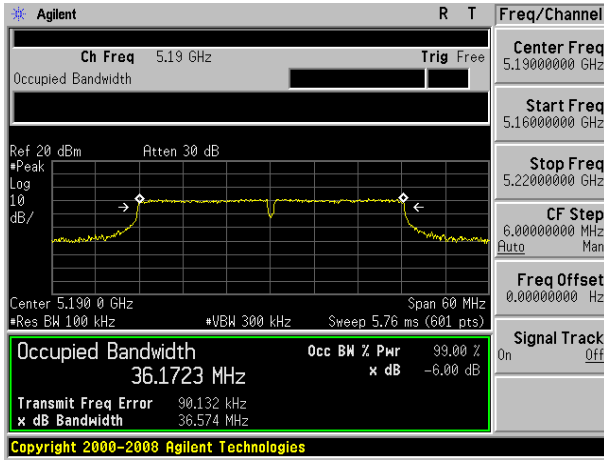

(802.11ac80) -6dB Bandwidth plot on channel 42

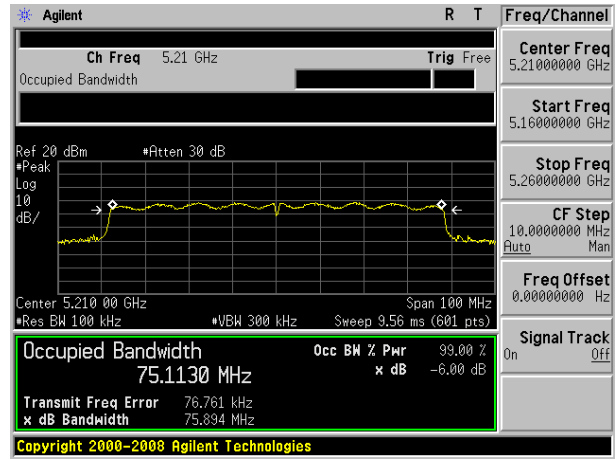

(802.11ac40) -6dB Bandwidth plot on channel 46

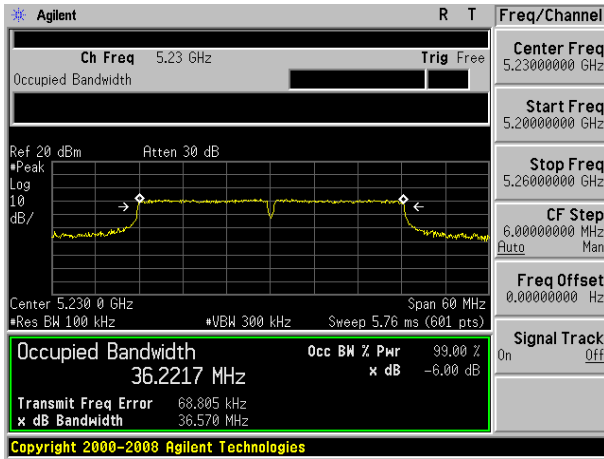

EUT :	AC1200 Wifi Dual Band USB 3.0 Adapter	Model Name :	AC1200
Temperature :	25 °C	Relative Humidity :	60%
Pressure :	1012 hPa	Test Voltage :	DC 5V from Notebook
Test Mode :	TX (5G) Mode Frequency (5725-5825MHz)		

Note: A(B) Represent the value of antenna A and B, The worst data is Antenna B ,only shown Antenna B Plot.

Mode	Channel	Frequency (MHz)	-6dB bandwidth (MHz)		Limit (KHz)	Result
			Antenna A	Antenna B		
802.11a	149	5745	16.544	16.590	500	Pass
	157	5785	16.501	16.595	500	Pass
	165	5825	16.540	16.593	500	Pass
802.11 n20	149	5745	17.784	17.826	500	Pass
	157	5785	17.839	17.817	500	Pass
	165	5825	17.802	17.854	500	Pass
802.11 n40	151	5755	36.588	36.580	500	Pass
	159	5795	36.571	36.579	500	Pass
802.11 ac20	149	5745	17.753	17.832	500	Pass
	157	5785	17.774	17.838	500	Pass
	165	5825	17.819	17.832	500	Pass
802.11 ac40	151	5755	36.578	36.567	500	Pass
	159	5795	36.567	36.571	500	Pass
802.11 ac80	155	5775	76.108	76.114	500	Pass

(802.11a) -6dB Bandwidth plot on channel 149

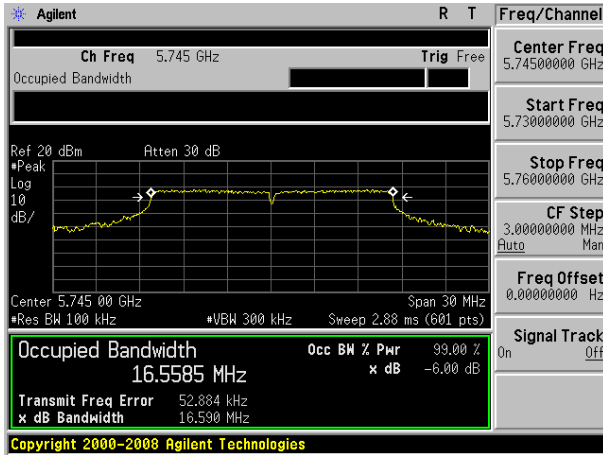

(802.11n20) -6dB Bandwidth plot on channel 149

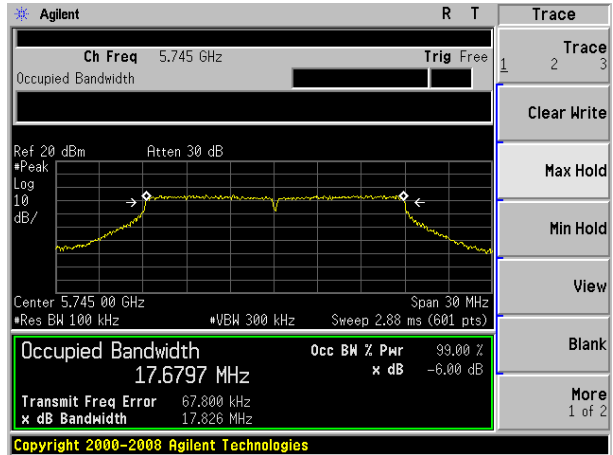

(802.11a) -6dB Bandwidth plot on channel 157

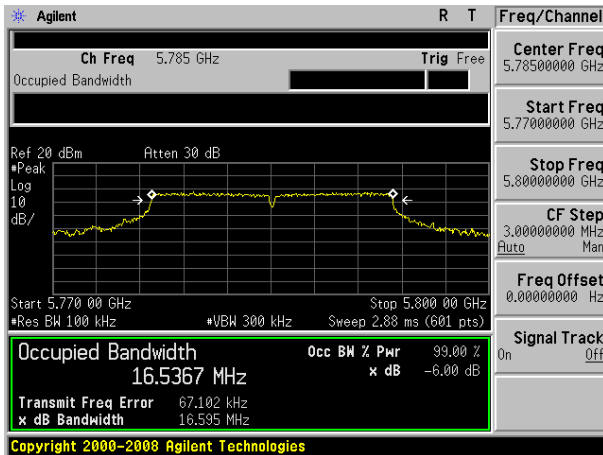

(802.11n20) -6dB Bandwidth plot on channel 157

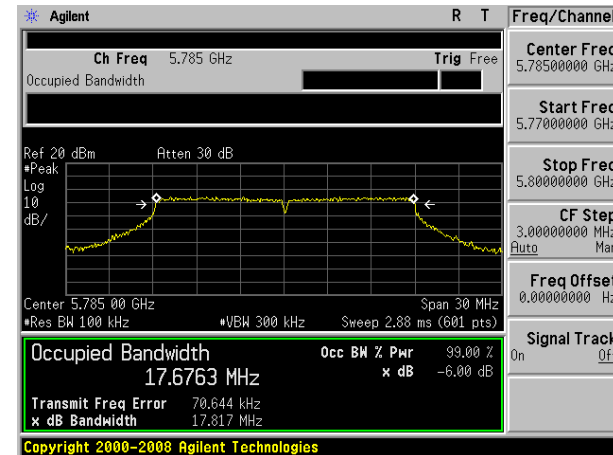

(802.11a) -6dB Bandwidth plot on channel 165

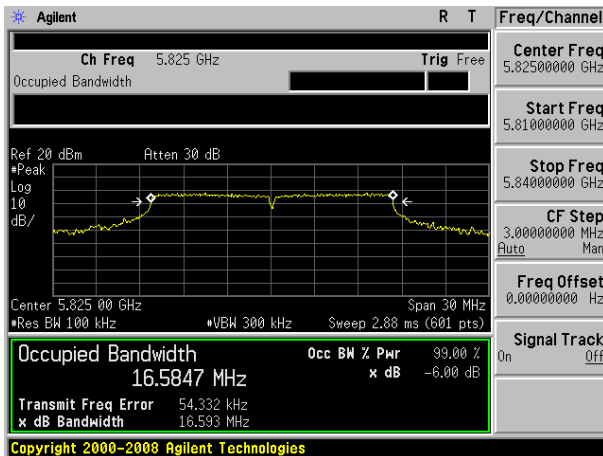

(802.11n20) -6dB Bandwidth plot on channel 165

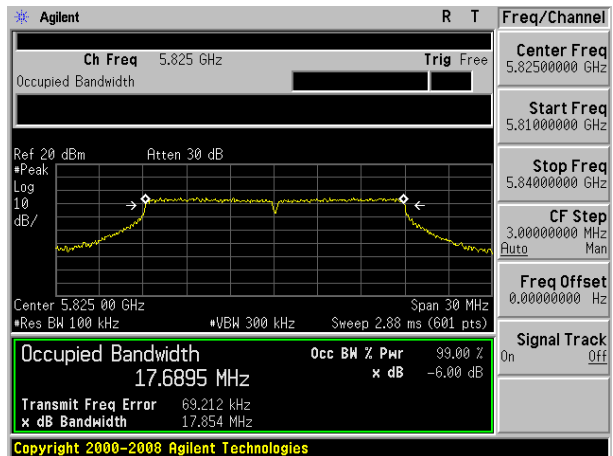

(802.11n40) -6dB Bandwidth plot on channel 151

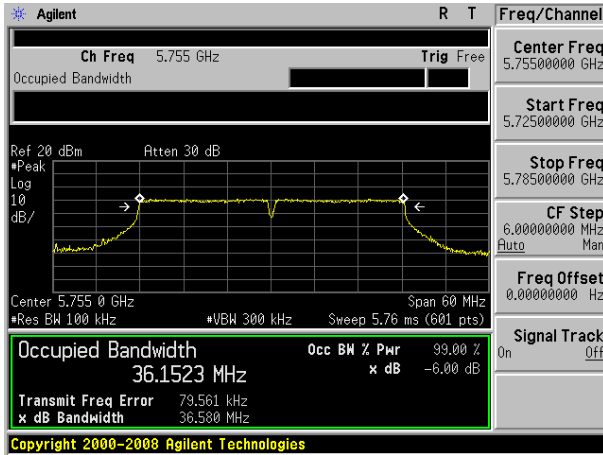

(802.11ac20) -6dB Bandwidth plot on channel 149

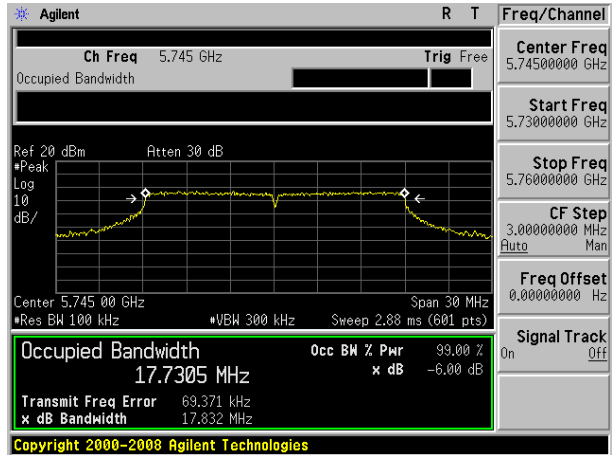

(802.11n40) -6dB Bandwidth plot on channel 159

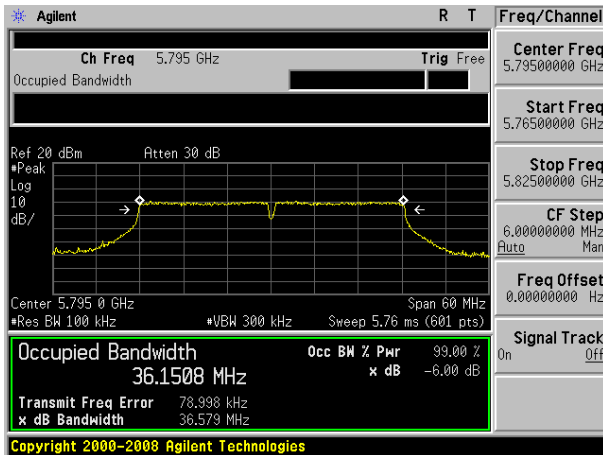

(802.11ac20) -6dB Bandwidth plot on channel 157

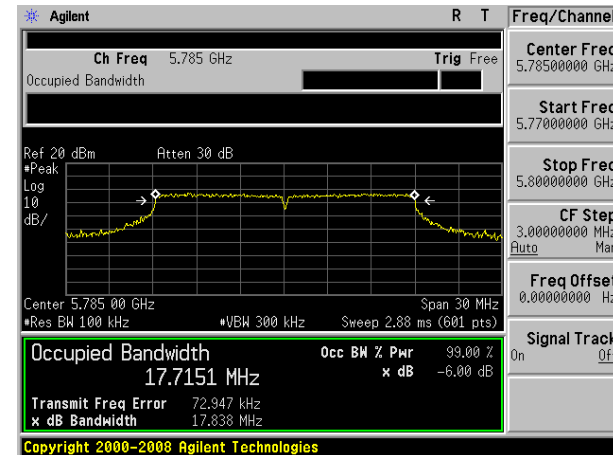

(802.11ac20) -6dB Bandwidth plot on channel 165

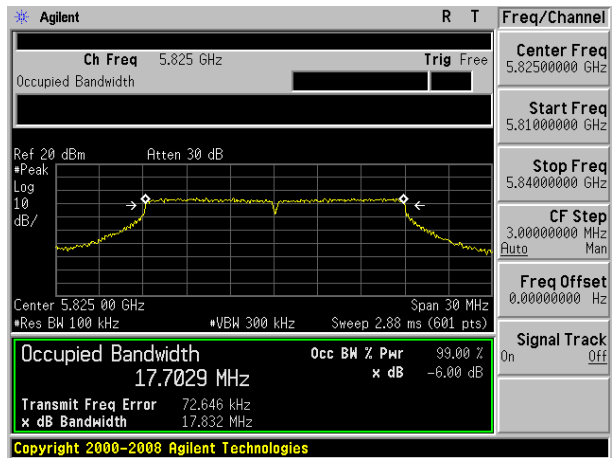

(802.11ac40) -6dB Bandwidth plot on channel 151

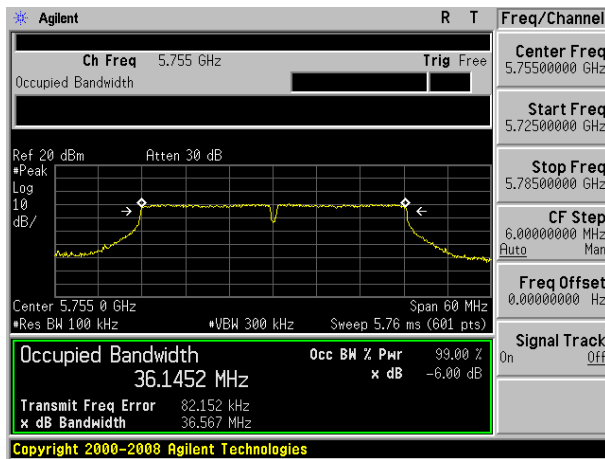

(802.11ac80) -6dB Bandwidth plot on channel 155

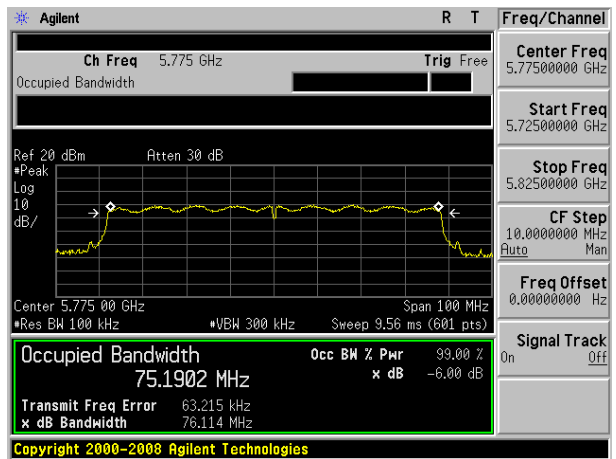

(802.11ac40) -6dB Bandwidth plot on channel 159

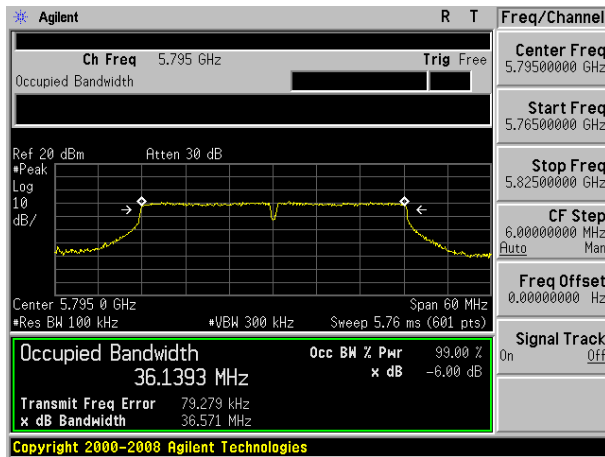

## 7. MAXIMUM CONDUCTED OUTPUT POWER

### 7.1 APPLIED PROCEDURES / LIMIT

#### According to FCC §15.407

The maximum conducted output power should not exceed:

Frequency Band(MHz)	Limit
5150~5250	250mW
5725~5850	1W

The maximum e.i.r.p should not exceed:

Frequency Band(MHz)	Limit
5150~5250	200mW or 10dBm +10logB whichever is less
5725~5850	N/A

Note: Where “B” is the 99% emission bandwidth in MHz

### 7.2 TEST PROCEDURE

· Maximum conducted output power may be measured using a spectrum analyzer/EMI receiver or an RF power meter.

#### 1. Device Configuration

If possible, configure or modify the operation of the EUT so that it transmits continuously at its maximum power control level (see section II.B.).

a) The intent is to test at 100 percent duty cycle; however a small reduction in duty cycle (to no lower than 98 percent) is permitted if required by the EUT for amplitude control purposes. Manufacturers are expected to provide software to the test lab to permit such continuous operation.

b) If continuous transmission (or at least 98 percent duty cycle) cannot be achieved due to hardware limitations (e.g., overheating), the EUT shall be operated at its maximum power control level with the transmit duration as long as possible and the duty cycle as high as possible.

#### 2. Measurement using a Spectrum Analyzer or EMI Receiver (SA)

Measurement of maximum conducted output power using a spectrum analyzer requires integrating the spectrum across a frequency span that encompasses, at a minimum, either the EBW or the 99-percent occupied bandwidth of the signal.<sup>1</sup> However, the EBW must be used to determine bandwidth dependent limits on maximum conducted output power in accordance with § 15.407(a).

a) The test method shall be selected as follows: (i) Method SA-1 or SA-1 Alternative (averaging with the EUT transmitting at full power throughout each sweep) shall be applied if either of the following conditions can be satisfied:

- The EUT transmits continuously (or with a duty cycle  $\geq 98$  percent).
- Sweep triggering or gating can be implemented in a way that the device transmits at the maximum power control level throughout the duration of each of the instrument sweeps to be averaged. This condition can generally be achieved by triggering the instrument's sweep if the duration of the sweep (with the analyzer configured as in Method SA-1, below) is equal to or shorter than the duration T of each transmission from the EUT and if those transmissions exhibit full power throughout their durations.

(ii) Method SA-2 or SA-2 Alternative (averaging across on and off times of the EUT transmissions, followed by duty cycle correction) shall be applied if the conditions of (i) cannot be achieved and the transmissions exhibit a constant duty cycle during the measurement duration. Duty cycle will be considered to be constant if variations are less than  $\pm 2$  percent.

(iii) Method SA-3 (RMS detection with max hold) or SA-3 Alternative (reduced VBW with max hold) shall be applied if the conditions of (i) and (ii) cannot be achieved.

b) Method SA-1 (trace averaging with the EUT transmitting at full power throughout each sweep): (i) Set span to encompass the entire emission bandwidth (EBW) (or, alternatively, the entire 99% occupied bandwidth) of the signal.

(ii) Set RBW = 1 MHz.

(iii) Set VBW  $\geq 3$  MHz.

(iv) Number of points in sweep  $\geq 2$  Span / RBW. (This ensures that bin-to-bin spacing is  $\leq$  RBW/2, so that narrowband signals are not lost between frequency bins.)

(v) Sweep time = auto.

(vi) Detector = RMS (i.e., power averaging), if available. Otherwise, use sample detector mode.

(vii) If transmit duty cycle  $< 98$  percent, use a video trigger with the trigger level set to enable triggering only on full power pulses. Transmitter must operate at maximum power control level for the entire duration of every sweep. If the EUT transmits continuously (i.e., with no off intervals) or at duty cycle  $\geq 98$  percent, and if each transmission is entirely at the maximum power control level, then the trigger shall be set to "free run".

(viii) Trace average at least 100 traces in power averaging (i.e., RMS) mode.

(ix) Compute power by integrating the spectrum across the EBW (or, alternatively, the entire 99% occupied bandwidth) of the signal using the instrument's band power measurement function with band limits set equal to the EBW (or occupied bandwidth) band edges. If the instrument does not have a band power function, sum the spectrum



**7.3 DEVIATION FROM STANDARD**

No deviation.

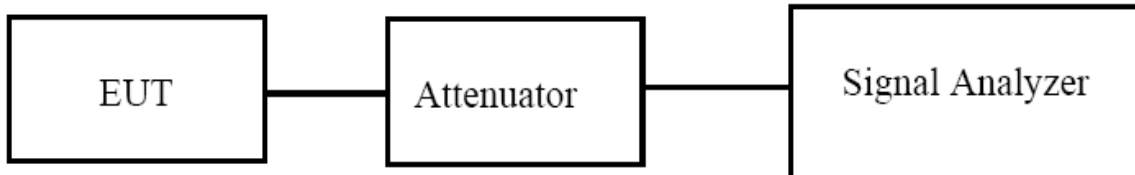
**7.4 TEST SETUP****7.5 EUT OPERATION CONDITIONS**

The EUT tested system was configured as the statements of 2.4 Unless otherwise a special operating condition is specified in the follows during the testing.

### 7.6 TEST RESULTS

EUT :	AC1200 Wifi Dual Band USB 3.0 Adapter	Model Name :	AC1200
Temperature :	25 °C	Relative Humidity :	60%
Pressure :	1012 hPa	Test Voltage :	DC 5V from Notebook
Test Mode :	TX (5G) Mode Frequency (5150-5250MHz)		

Note: EUT has two antennas, and different modes support different transmit mode what describe as Following form:

Mode	Tx/Rx
11a	1Tx, 1Rx
11n20,11n40, 11ac20,11ac40, 11ac80	2Tx, 2Rx

Test Channel	Frequency	Maximum output power. Antenna port(dBm)	Maximum output power. Antenna port(dBm)	Total output power. Antenna port (dBm)		LIMIT	Result
		(AV)	(AV)	AV			
	(MHz)	Antenna A	Antenna B	Antenna A	Antenna B	dBm	
<b>TX 802.11a Mode</b>							
CH36	5180	13.6	13.5	-	-	23.98	Pass
CH40	5200	13.8	13.3	-	-	23.98	Pass
CH48	5240	13.7	13.7	-	-	23.98	Pass
<b>TX 802.11 n20M Mode</b>							
CH36	5180	10.8	10.6	13.711		21.42	Pass
CH40	5200	10.6	10.3	13.463		21.42	Pass
CH48	5240	10.5	10.5	13.510		21.42	Pass
<b>TX 802.11 n40M Mode</b>							
CH38	5190	9.7	9.7	12.710		21.42	Pass
CH46	5230	9.5	9.5	12.510		21.42	Pass
<b>TX 802.11 ac20M Mode</b>							
CH36	5180	10.7	10.5	13.611		21.42	Pass
CH40	5200	10.8	10.3	13.567		21.42	Pass
CH48	5240	10.4	10.2	13.311		21.42	Pass
<b>TX 802.11 ac40M Mode</b>							
CH38	5190	9.6	9.4	12.511		21.42	Pass
CH46	5230	9.7	9.6	12.661		21.42	Pass
<b>TX 802.11 ac80M Mode</b>							
CH155	5210	9.3	9.1	12.211		21.42	Pass

Note: For 802.11n 20M/40M Directional gain=GANT +10log(N)dBi =1.26dBi

1.26dBi<6.0 dBi so power limit= 21.42

EUT :	AC1200 Wifi Dual Band USB 3.0 Adapter	Model Name :	AC1200
Temperature :	25 °C	Relative Humidity :	60%
Pressure :	1012 hPa	Test Voltage :	DC 5V from Notebook
Test Mode :	TX (5G) Mode Frequency (5725-5825MHz)		

Note: EUT has two antennas, and different modes support different transmit mode what describe as Following form:

Mode	Tx/Rx
11a	1Tx, 1Rx
11n20,11n40, 11ac20,11ac40, 11ac80	2Tx, 2Rx

Test Channel	Frequency	Maximum output power. Antenna port(dBm)	Maximum output power. Antenna port(dBm)	Total output power. Antenna port (dBm)		LIMIT	Result
		(AV)	(AV)	AV			
	(MHz)	Antenna A	Antenna B	Antenna A	Antenna B	dBm	
<b>TX 802.11a Mode</b>							
CH149	5745	11.2	11.6	-	-	30	Pass
CH157	5785	11.5	11.3	-	-	30	Pass
CH165	5825	11.3	11.5	-	-	30	Pass
<b>TX 802.11 n20M Mode</b>							
CH149	5745	9.6	9.4	12.511		27.44	Pass
CH157	5785	9.5	9.6	12.561		27.44	Pass
CH165	5825	9.2	9.3	12.261		27.44	Pass
<b>TX 802.11 n40M Mode</b>							
CH151	5755	9.5	9.6	12.561		27.44	Pass
CH159	5795	9.6	9.3	12.463		27.44	Pass
<b>TX 802.11 ac20 Mode</b>							
CH149	5745	9.3	9.6	12.463		27.44	Pass
CH157	5785	9.3	9.3	12.310		27.44	Pass
CH165	5825	9.2	9.4	12.311		27.44	Pass
<b>TX 802.11 ac40 Mode</b>							
CH151	5755	9.7	9.5	12.611		27.44	Pass
CH159	5795	9.3	9.6	12.463		27.44	Pass
CH155	5795	9.3	9.4	12.361		27.44	Pass

Note: For 802.11n 20M/40M Directional gain=GANT +10log(N)dBi =1.26dBi

1.26dBi<6.0 dBi so power limit= 27.44

## 8. OUT OF BAND EMISSIONS

### 8.1 APPLICABLE STANDARD

#### According to FCC §15.407(b)

Undesirable emission limits. Except as shown in paragraph (b)(7) of this section, the maximum emissions outside of the frequency bands of operation shall be attenuated in accordance with the following limits:

(1) For transmitters operating in the 5.15-5.25 GHz band: All emissions outside of the 5.15-5.35 GHz band shall not exceed an e.i.r.p. of  $-27$  dBm/MHz.

(2) For transmitters operating in the 5.725-5.85 GHz band: All emissions shall be limited to a level of  $-27$  dBm/MHz at 75 MHz or more above or below the band edge increasing linearly to 10 dBm/MHz at 25 MHz above or below the band edge, and from 25 MHz above or below the band edge increasing linearly to a level of 15.6 dBm/MHz at 5 MHz above or below the band edge, and from 5 MHz above or below the band edge increasing linearly to a level of 27 dBm/MHz at the band edge.

### 8.2 TEST PROCEDURE

1. Check the calibration of the measuring instrument using either an internal calibrator or a known signal from an external generator.
2. Position the EUT without connection to measurement instrument. Turn on the EUT and connect its antenna terminal to measurement instrument via a low loss cable. Then set it to any one measured frequency within its operating range, and make sure the instrument is operated in its linear range.
3. Set RBW of spectrum analyzer to 1 MHz with a convenient frequency span.
4. Measure the highest amplitude appearing on spectral display and set it as a reference level. Plot the graph with marking the highest point and edge frequency.
5. Repeat above procedures until all measured frequencies were complete.

### 8.3 DEVIATION FROM STANDARD

No deviation.

### 8.4 TEST SETUP



### 8.5 EUT OPERATION CONDITIONS

The EUT tested system was configured as the statements of 2.4 Unless otherwise a special operating condition is specified in the follows during the testing.

### 8.6 TEST RESULTS

EUT :	AC1200 Wifi Dual Band USB 3.0 Adapter	Model Name :	AC1200
Temperature :	25 °C	Relative Humidity :	56%
Pressure :	1012 hPa	Test Voltage :	DC 5V from Notebook

Note: A(B) Represent the value of antenna A and B, The worst data is Antenna A ,only shown Antenna A Plot.

#### 5.2G

#### 5.15~5.25 GHz

(802.11a) Band Edge, Left Side

(802.11n20) Band Edge, Left Side

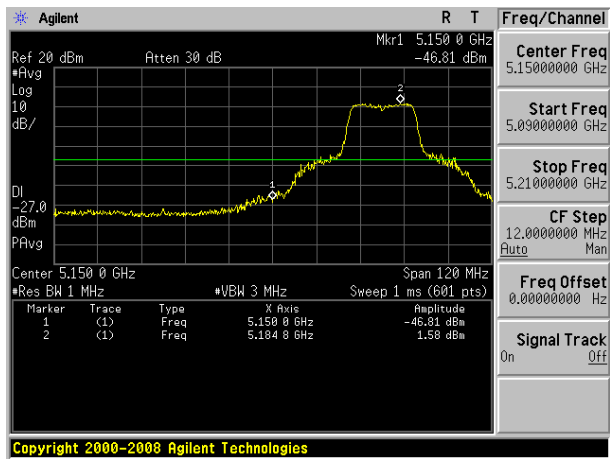
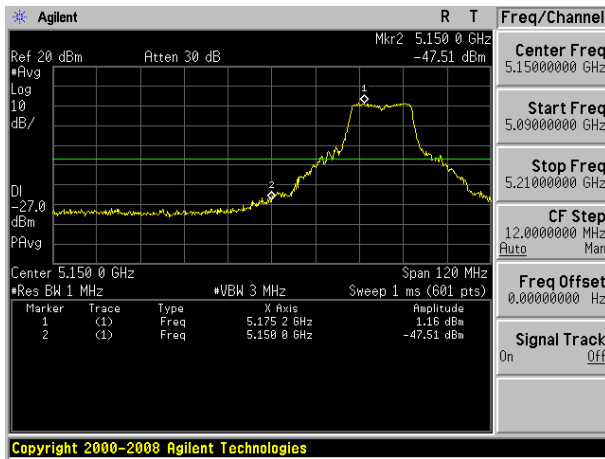

(802.11a) Band Edge, Right Side

(802.11n20) Band Edge, Right Side

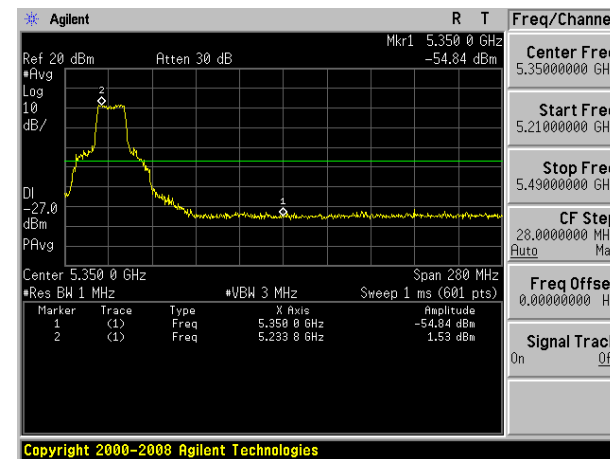
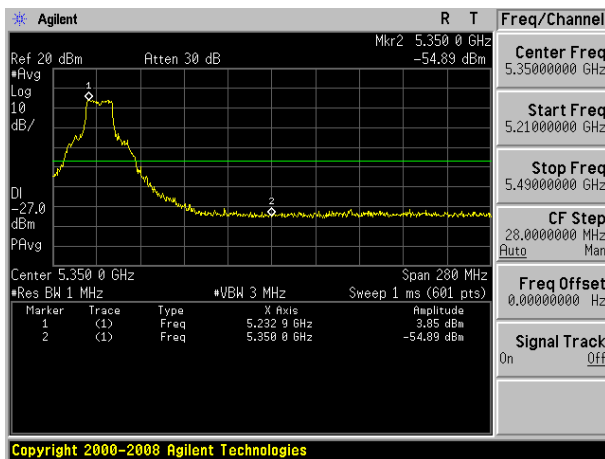

### 5.15~5.25 GHz

(802.11n40) Band Edge, Left Side

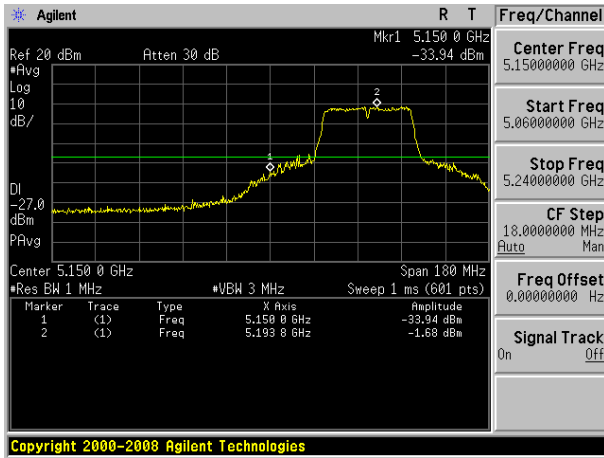

(802.11ac20) Band Edge, Left Side

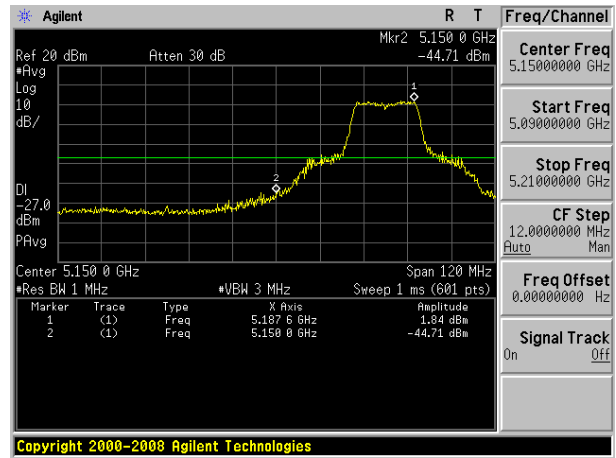

(802.11n40) Band Edge, Right Side

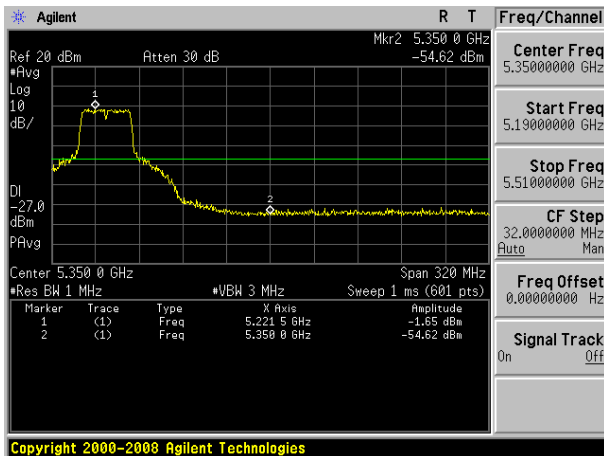

(802.11ac20) Band Edge, Right Side

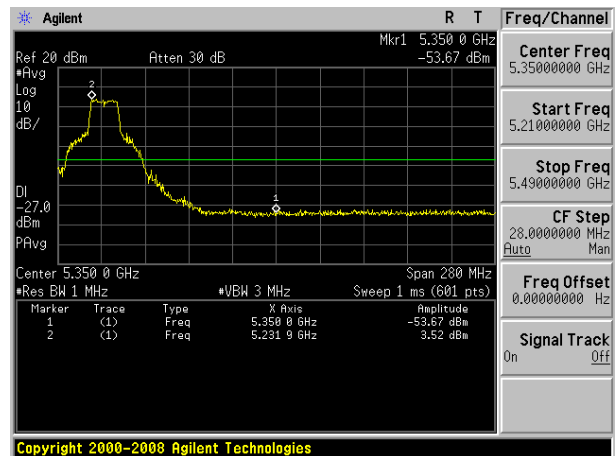

### 5.15~5.25 GHz

(802.11ac40) Band Edge, Left Side

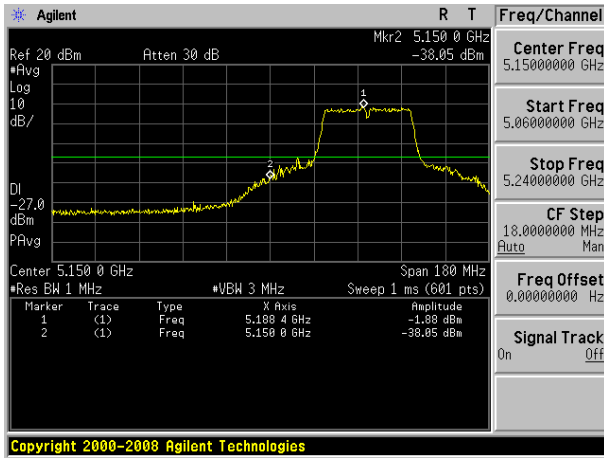

(802.11ac80) Band Edge, Left Side

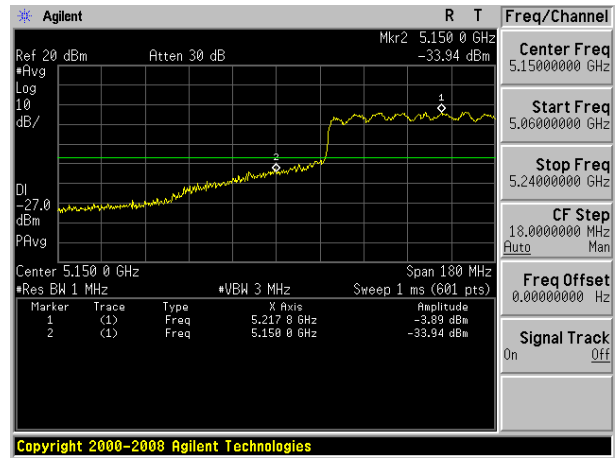

(802.11ac40) Band Edge, Right Side

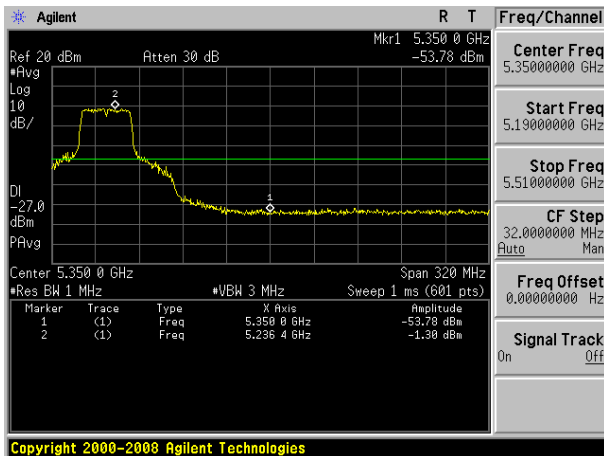

(802.11ac80) Band Edge, Right Side

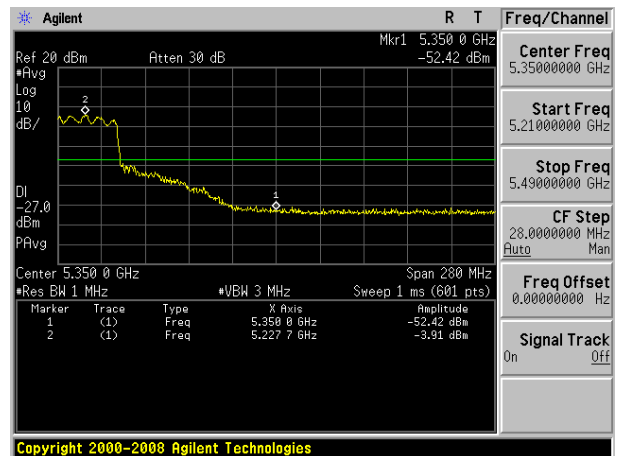

5.8G

5.725-5.85 GHz

(802.11a) Band Edge, Left Side

(802.11n20) Band Edge, Left Side

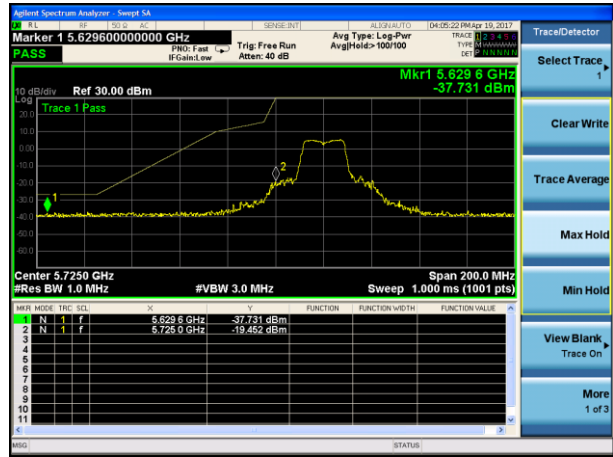
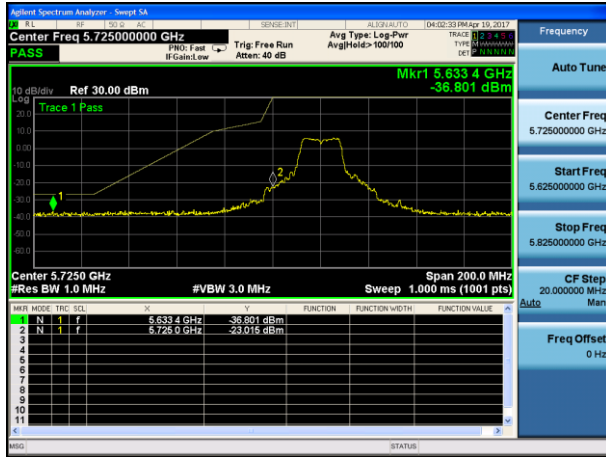

(802.11a) Band Edge, Right Side

(802.11n20) Band Edge, Right Side

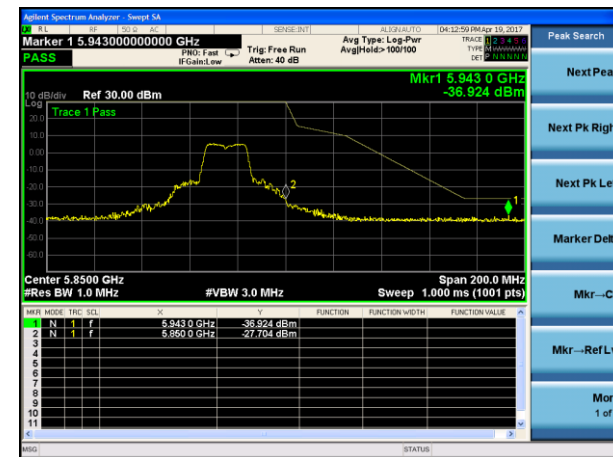
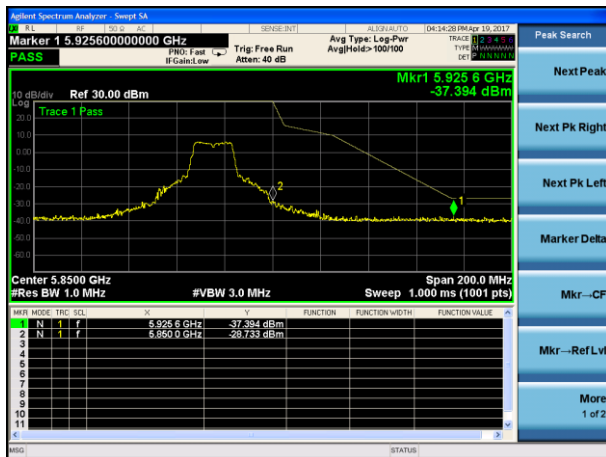



### 5.725-5.85 GHz

(802.11n40) Band Edge, Left Side

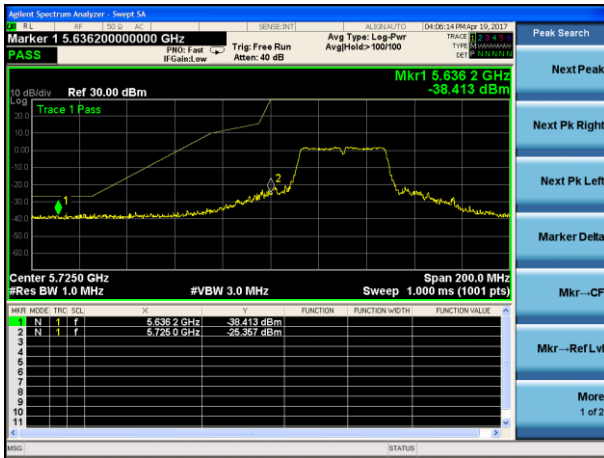

(802.11ac20) Band Edge, Left Side

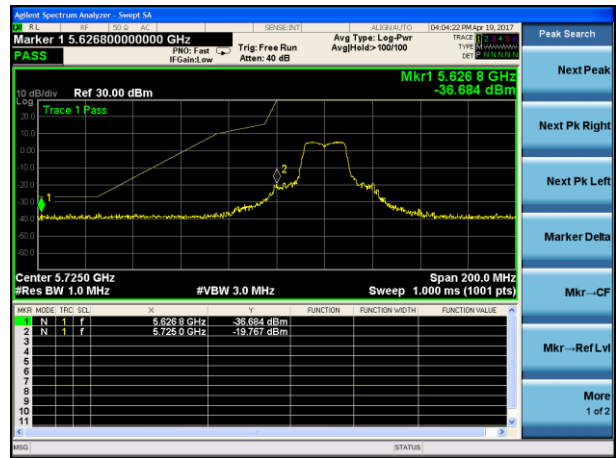

(802.11n40) Band Edge, Right Side

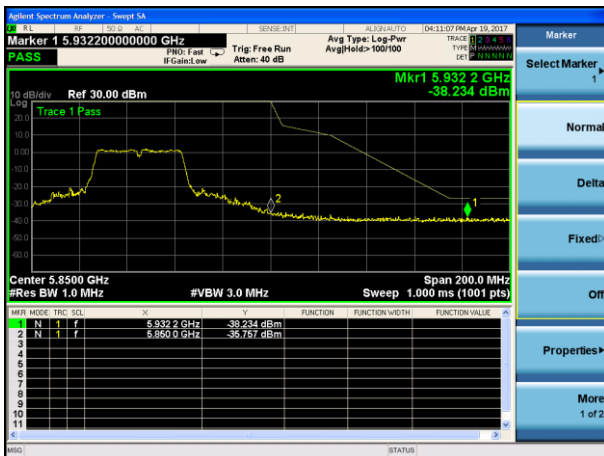

(802.11ac20) Band Edge, Right Side

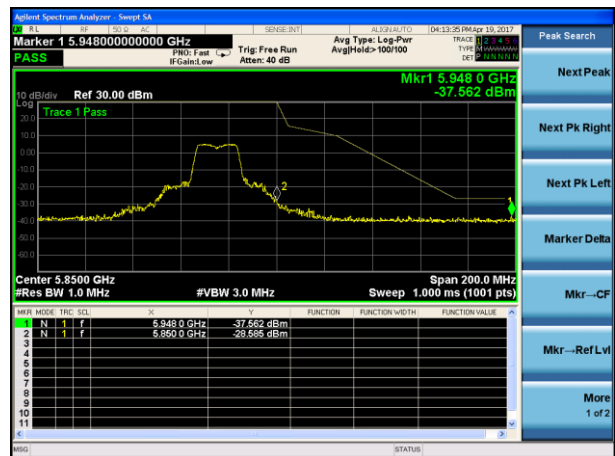

### 5.725-5.85 GHz

(802.11ac40) Band Edge, Left Side

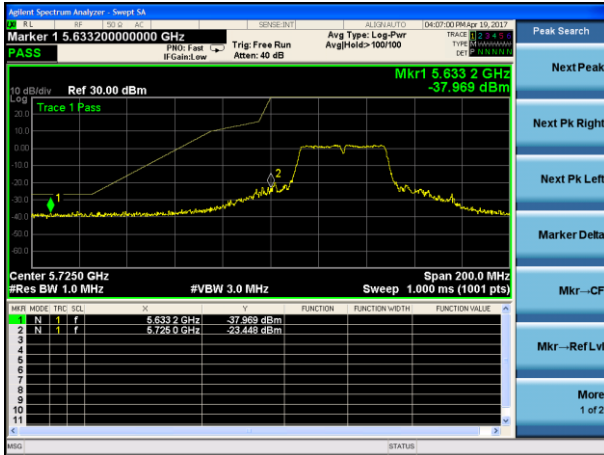

(802.11ac80) Band Edge, Left Side

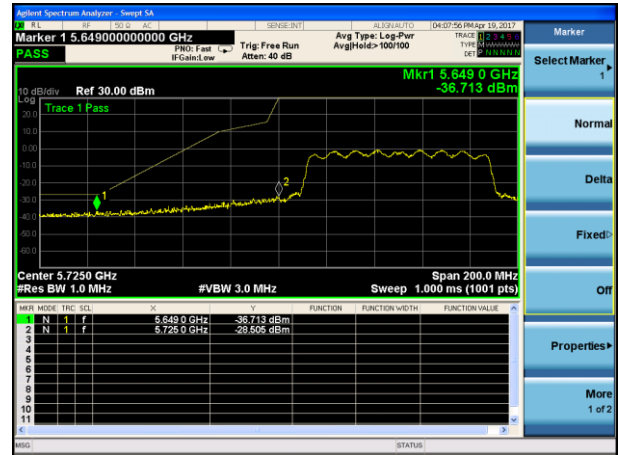

(802.11ac40) Band Edge, Right Side



(802.11ac80) Band Edge, Right Side

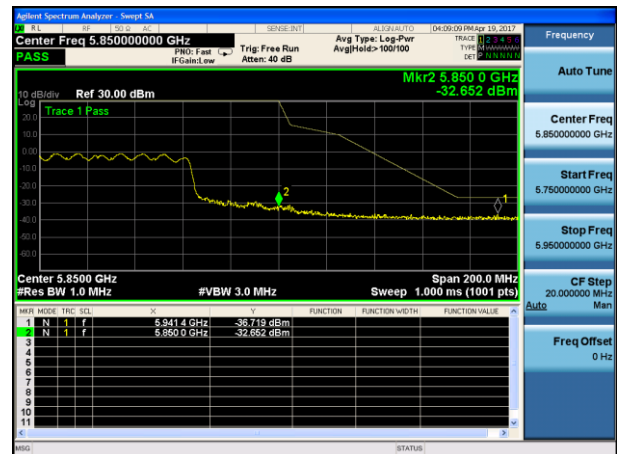

## **9.SPURIOUS RF CONDUCTED EMISSIONS**

### **9.1 CONFORMANCE LIMIT**

1. Below -20dB of the highest emission level in operating band.
2. Fall in the restricted bands listed in section 15.205. The maximum permitted average field strength is listed in section 15.209.

### **9.2 MEASURING INSTRUMENTS**

The Measuring equipment is listed in the section 6.3 of this test report.

### **9.3 TEST SETUP**

Please refer to Section 6.1 of this test report.

### **9.4 TEST PROCEDURE**

The Spurious RF conducted emissions compliance of RF radiated emission should be measured by following the guidance in ANSI C63.10-2013 with respect to maximizing the emission by rotating the EUT, measuring the emission while the EUT is situated in three orthogonal planes (if appropriate), adjusting the measurement antenna height and polarization etc. Set RBW=100kHz and VBW= 300KHz to measure the peak field strength , and measure frequency range from 9KHz to 26.5GHz.

### **9.5 TEST RESULTS**

Remark: The measurement frequency range is from 9KHz to the 10th harmonic of the fundamental frequency. The lowest, middle and highest channels are tested to verify the spurious emissions and band edge measurement data.

Note: A(B) Represent the value of antenna A and B, The worst data is Antenna A ,only shown Antenna A Plot.

### 5.2G Test Plot

802.11a on channel 36

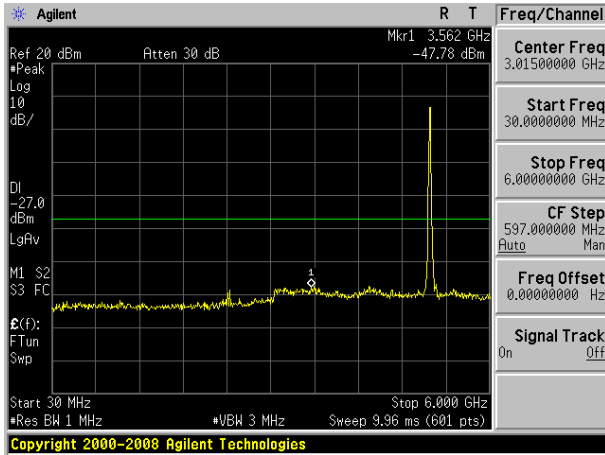

802.11a on channel 40

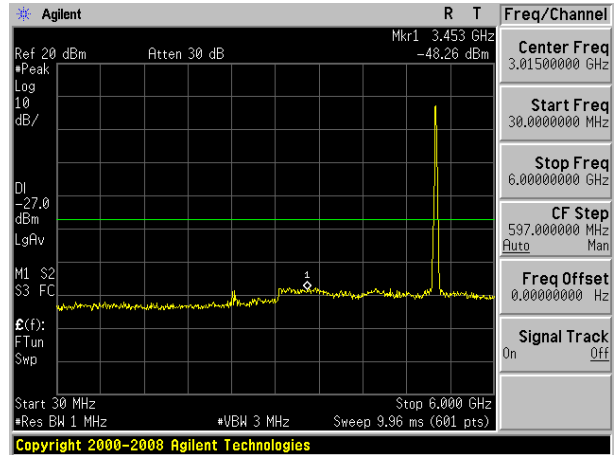

802.11a on channel 36

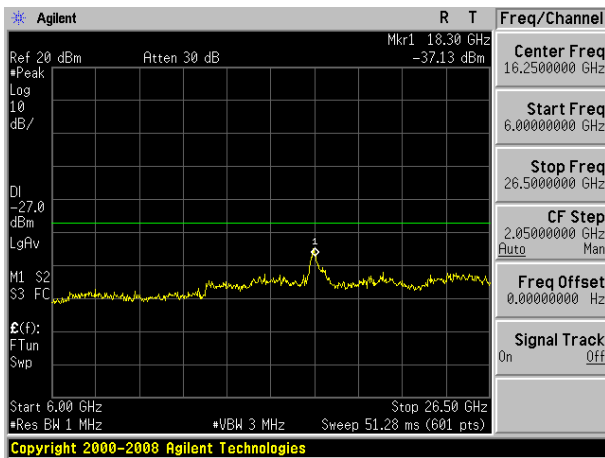

802.11a on channel 40

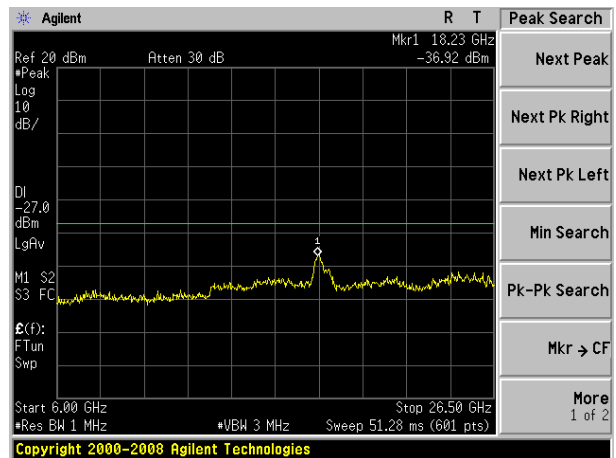

### Test Plot

802.11a on channel 48

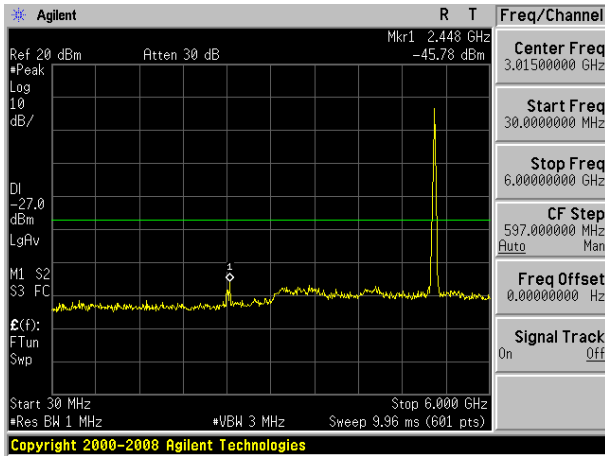

802.11n20 on channel 36

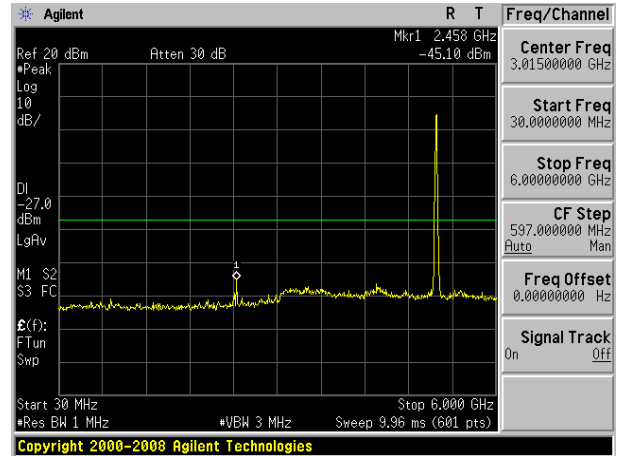

802.11a on channel 48

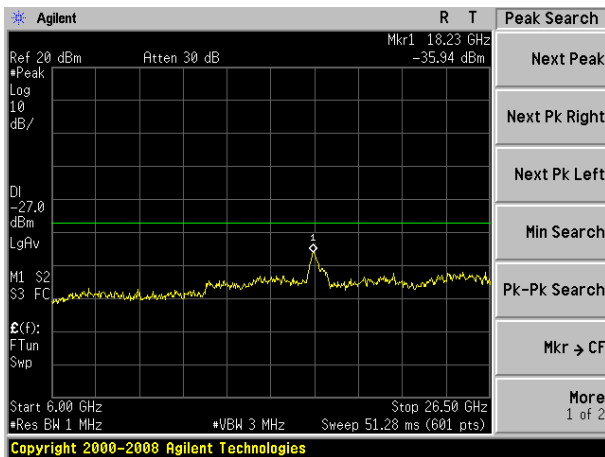

802.11n20 on channel 36

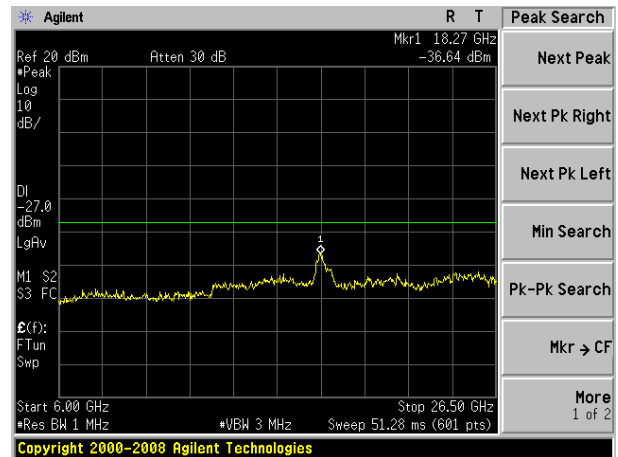

### Test Plot

802.11n20 on channel 40

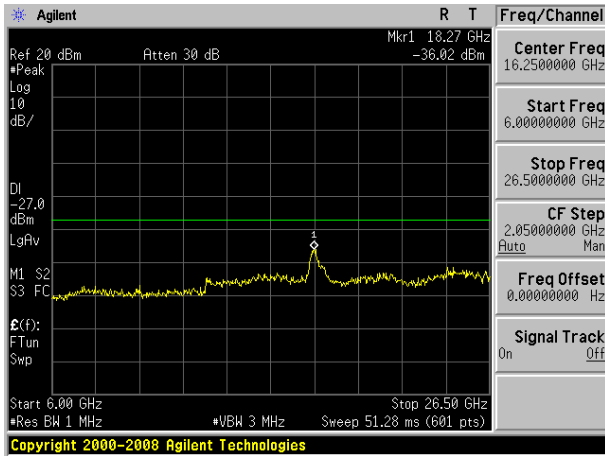

802.11n20 on channel 48

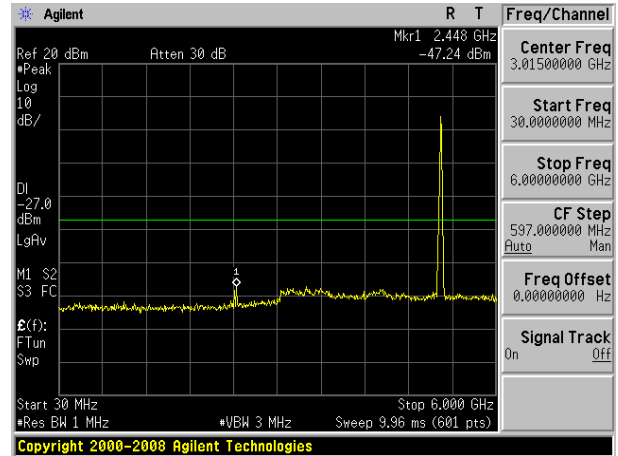

802.11n20 on channel 40

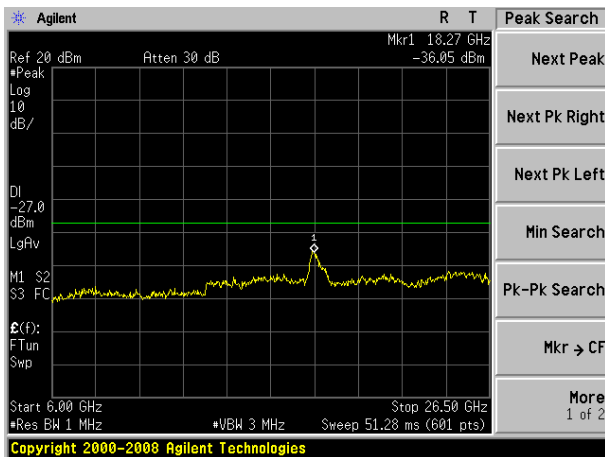

802.11n20 on channel 48

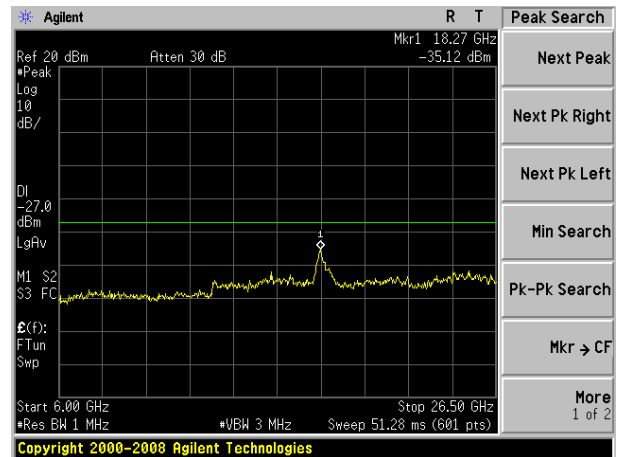

### Test Plot

802.11n40 on channel 38

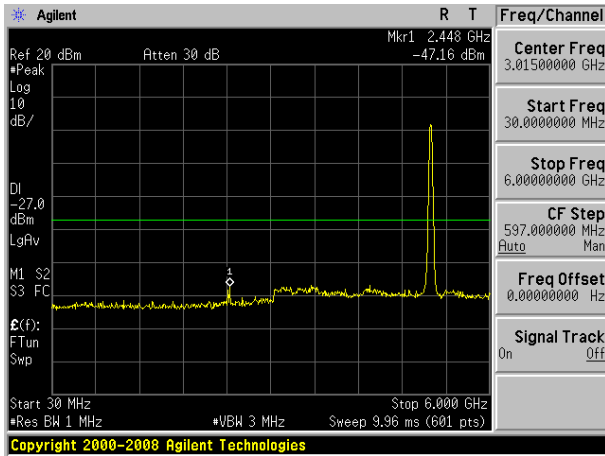

802.11n40 on channel 46

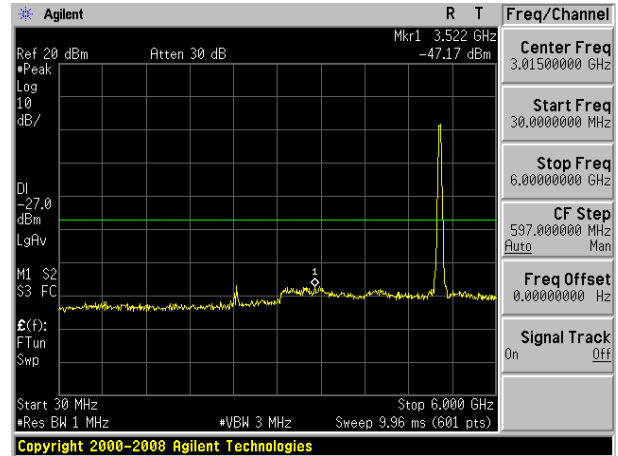

802.11n40 on channel 38

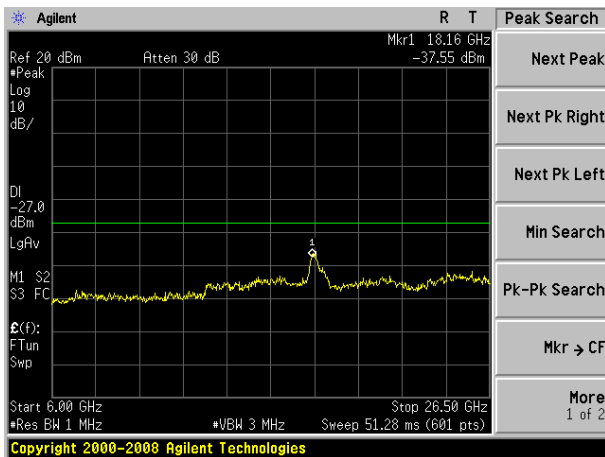

802.11n40 on channel 46

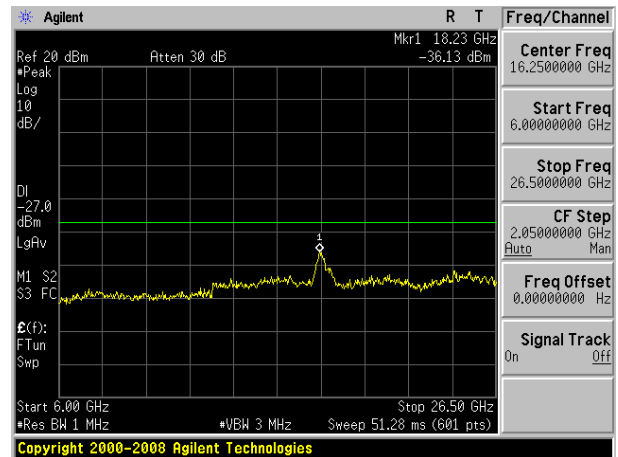

### Test Plot

802.11ac20 on channel 36

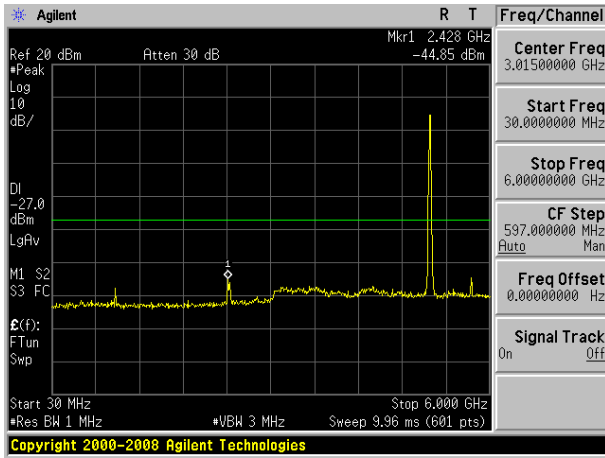

802.11ac20 on channel 40

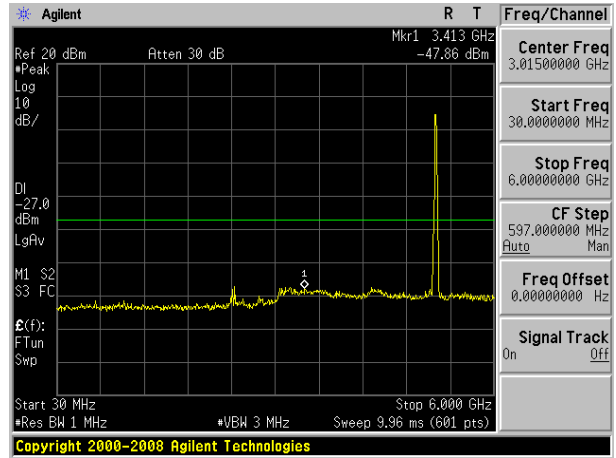

802.11ac20 on channel 36

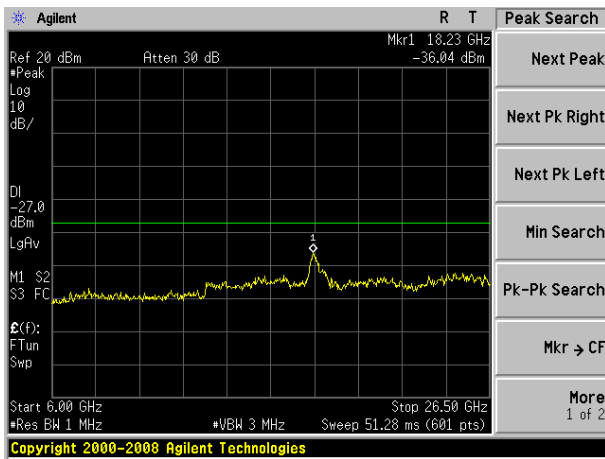

802.11ac20 on channel 40

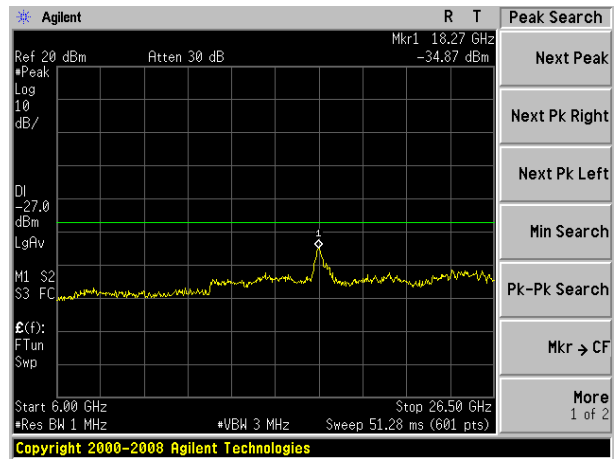



### Test Plot

802.11ac20 on channel 48

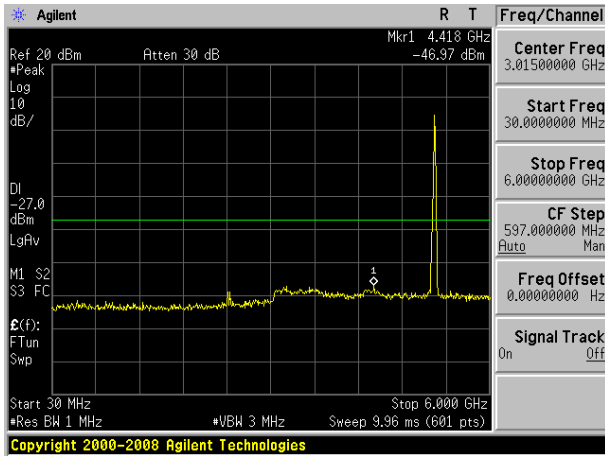

802.11ac40 on channel 38

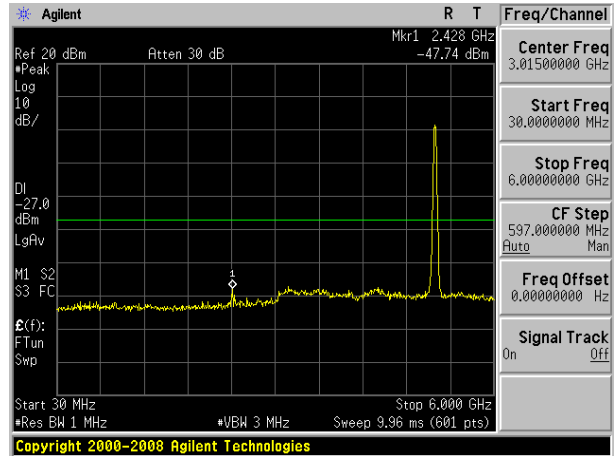

802.11ac20 on channel 48

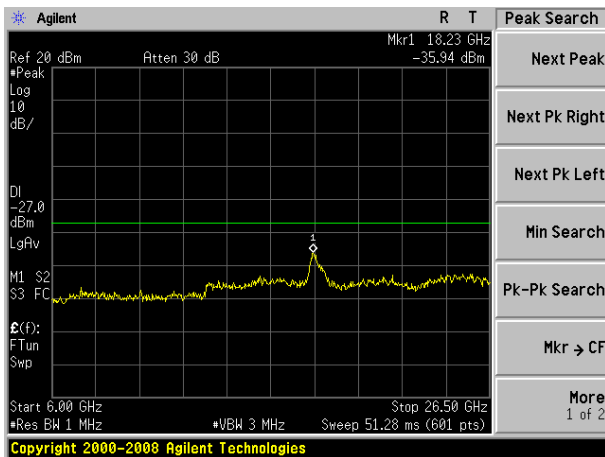

802.11ac40 on channel 38

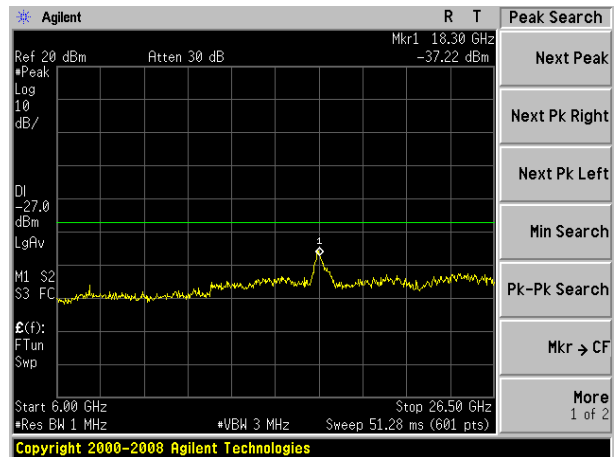

### Test Plot

802.11ac40 on channel 46

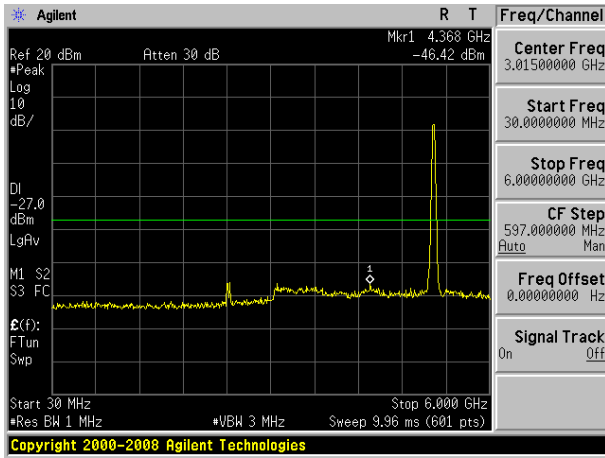

802.11ac80 on channel 42

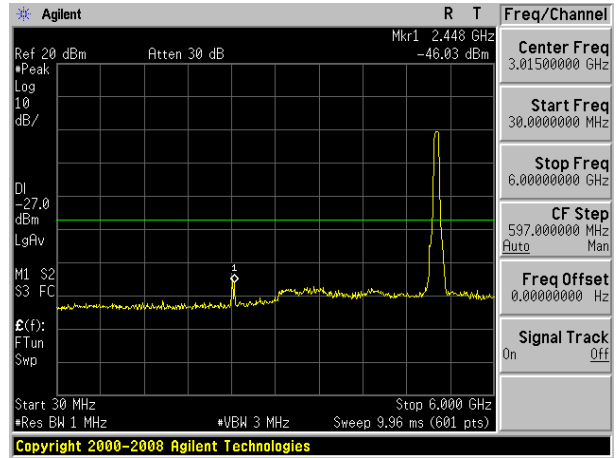

802.11 ac40 on channel 46

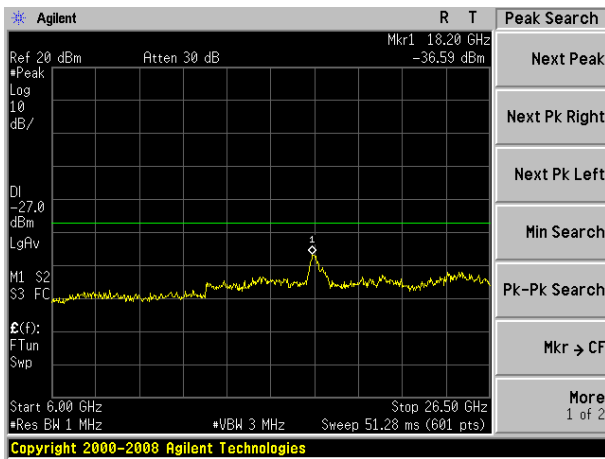

802.11 ac80 on channel 42

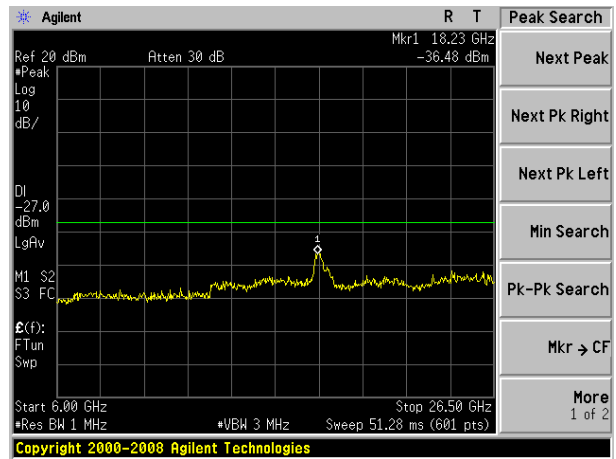

Note: A(B) Represent the value of antenna A and B, The worst data is A Antenna a , only shown Antenna A Plot.

### 5.8G Test Plot

802.11a on channel 149

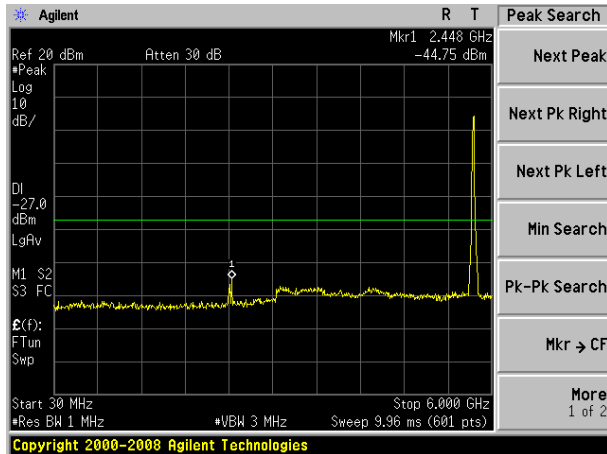

802.11a on channel 157

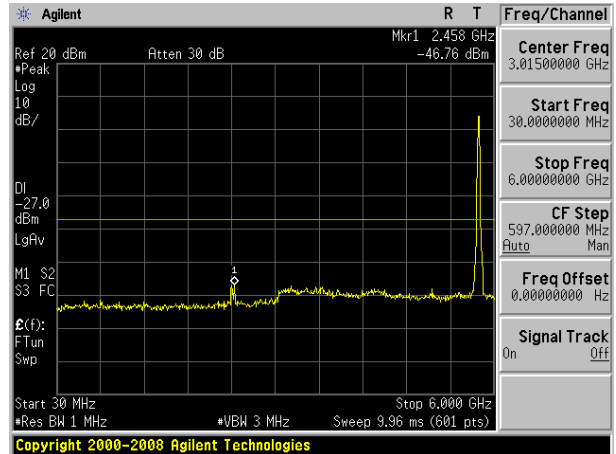

802.11a on channel 149

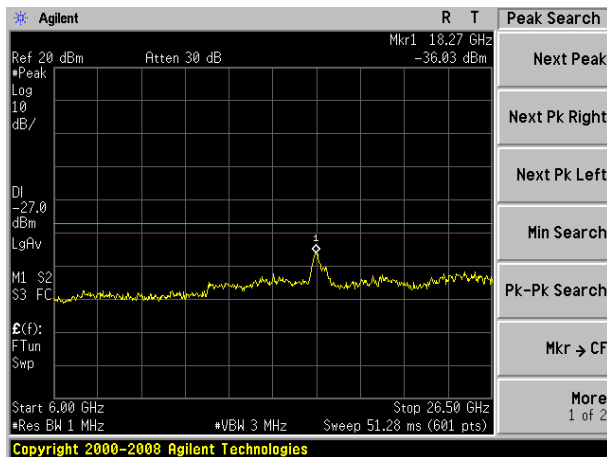

802.11a on channel 157

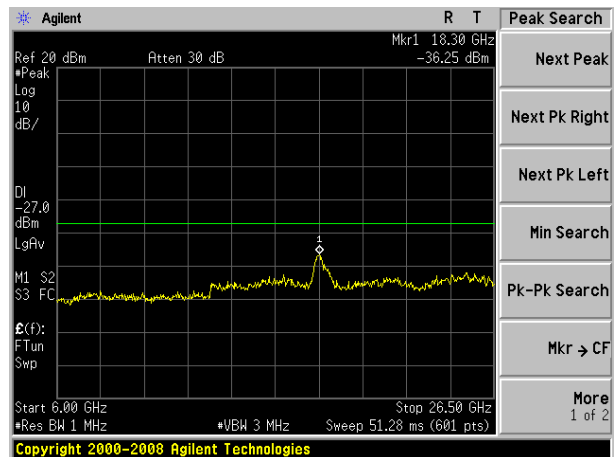

### Test Plot

802.11a on channel 165

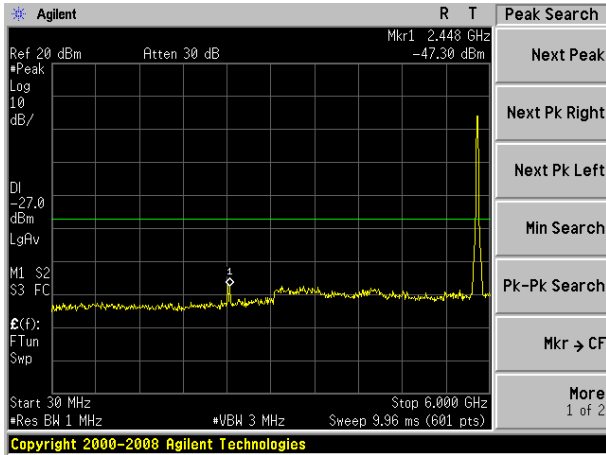

802.11n20 on channel 149

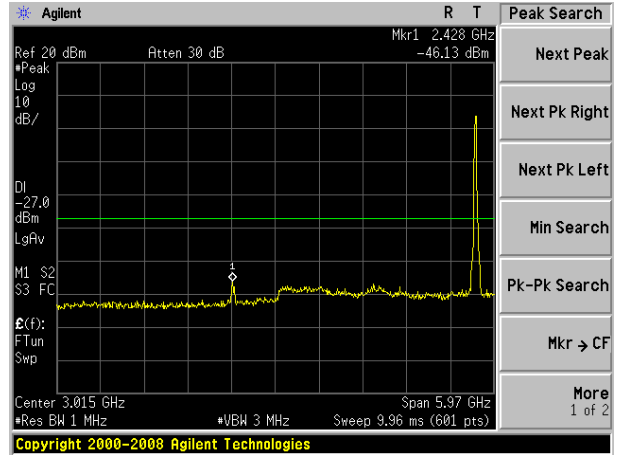

802.11a on channel 165

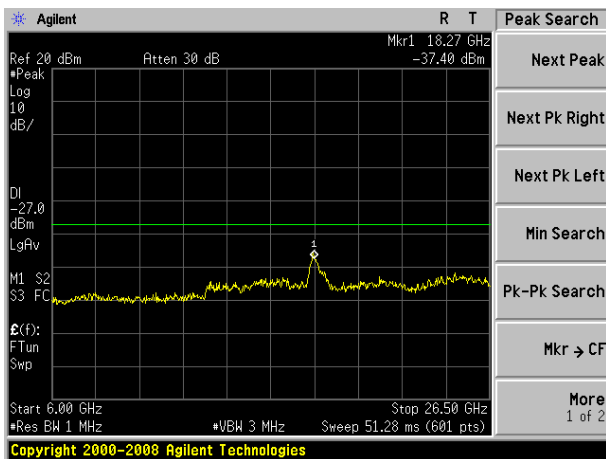

802.11n20 on channel 149

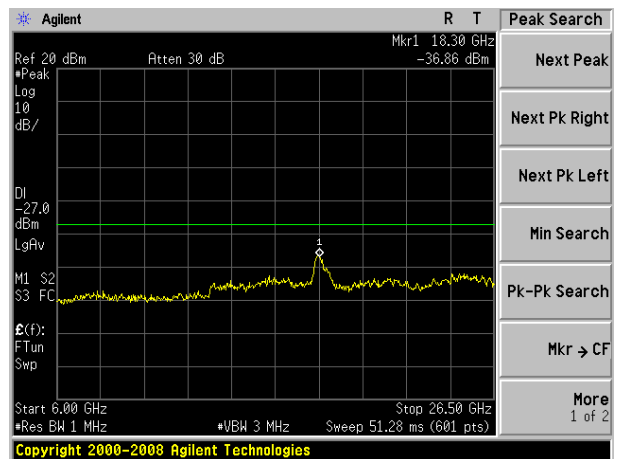

### Test Plot

802.11n20 on channel 157

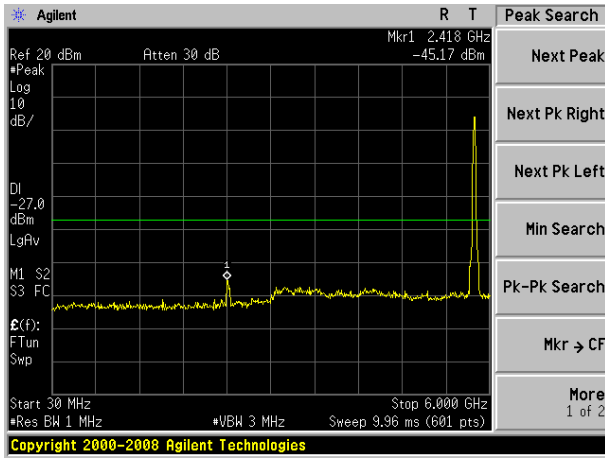

802.11n20 on channel 165

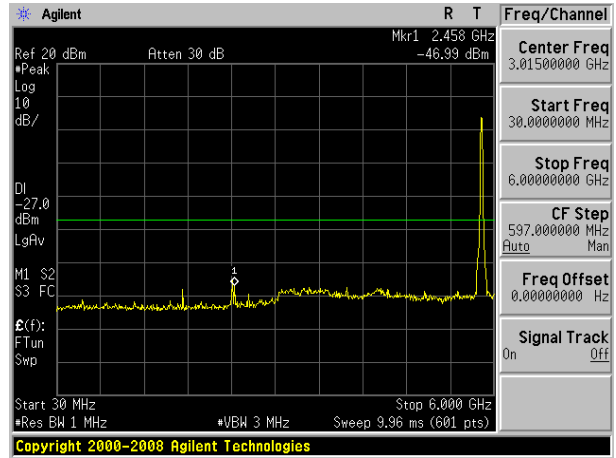

802.11n20 on channel 157

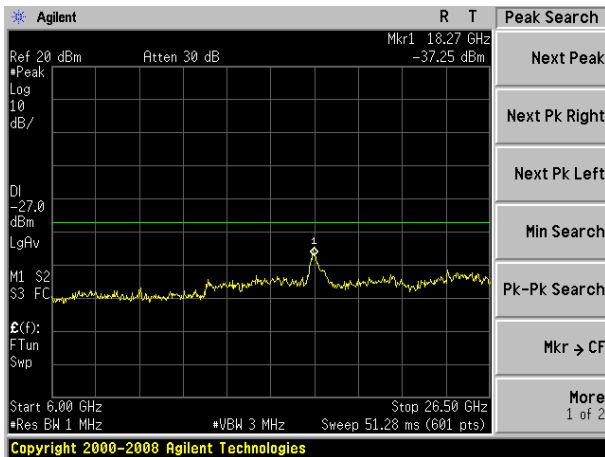

802.11n20 on channel 165

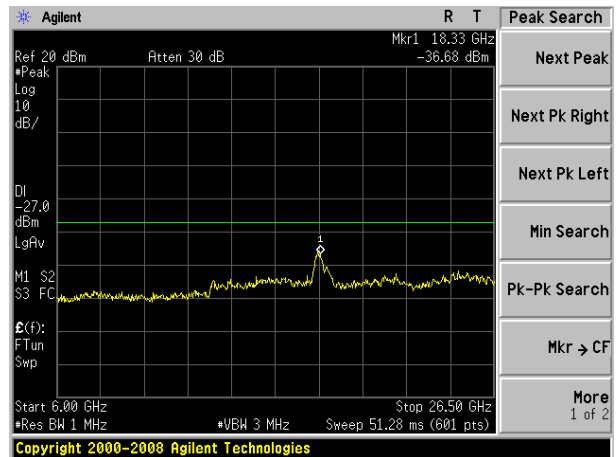

### Test Plot

802.11n40 on channel 151

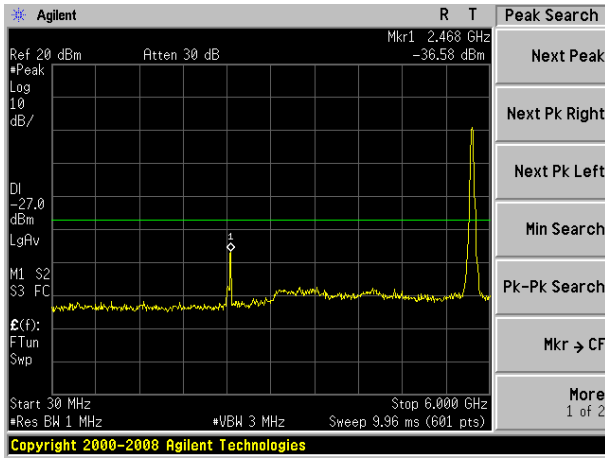

802.11n40 on channel 159

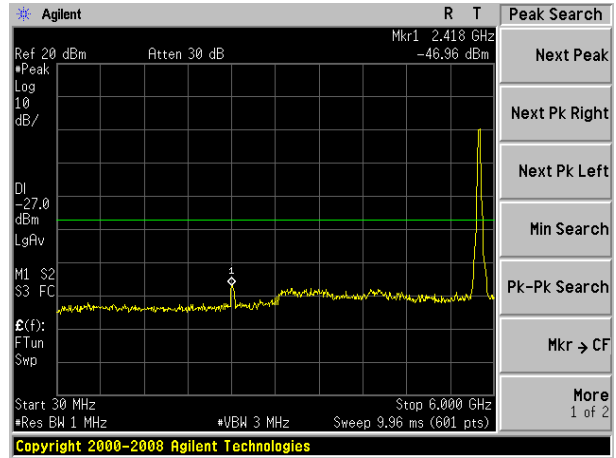

802.11n40 on channel 151

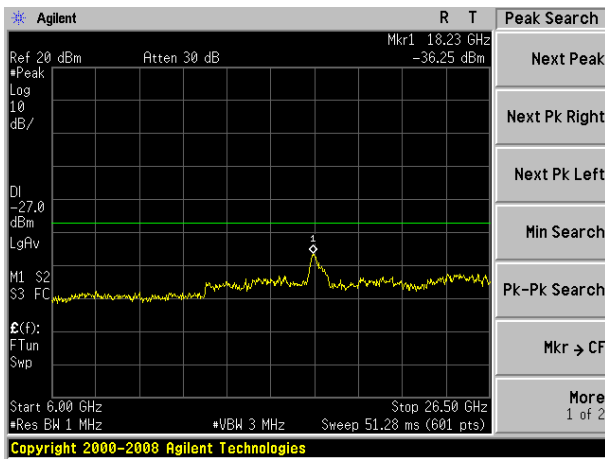

802.11n40 on channel 159

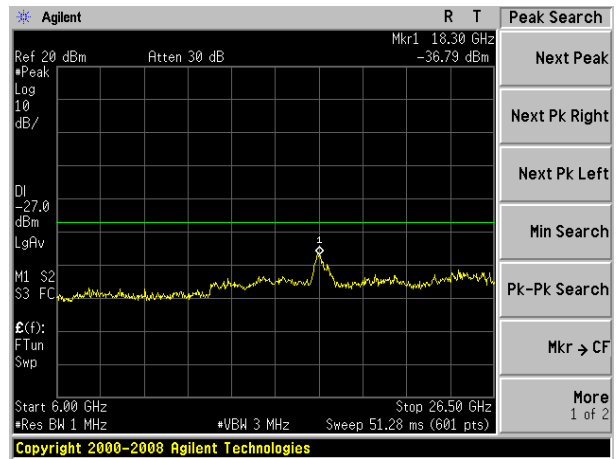

### Test Plot

802.11ac20 on channel 149

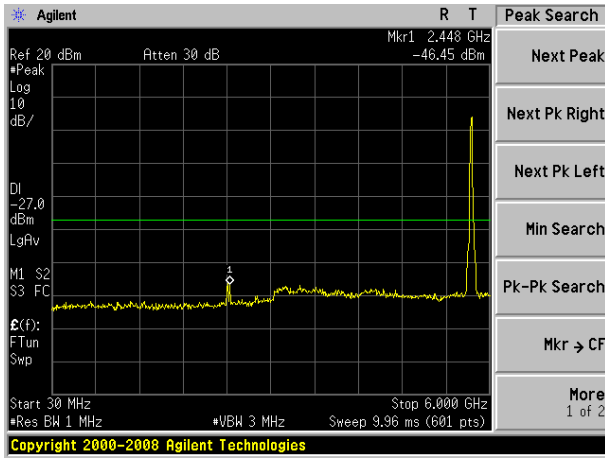

802.11ac20 on channel 157

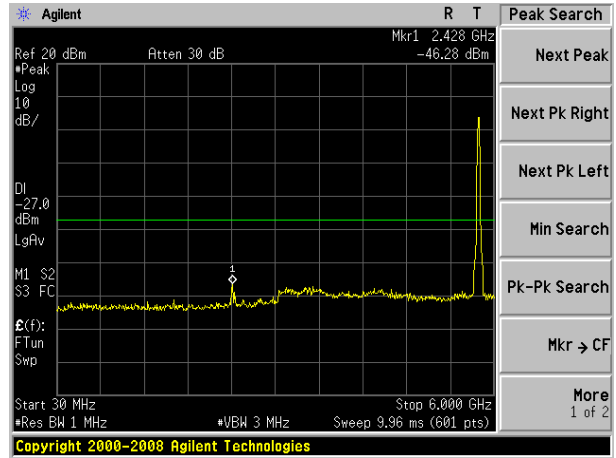

802.11ac20 on channel 149

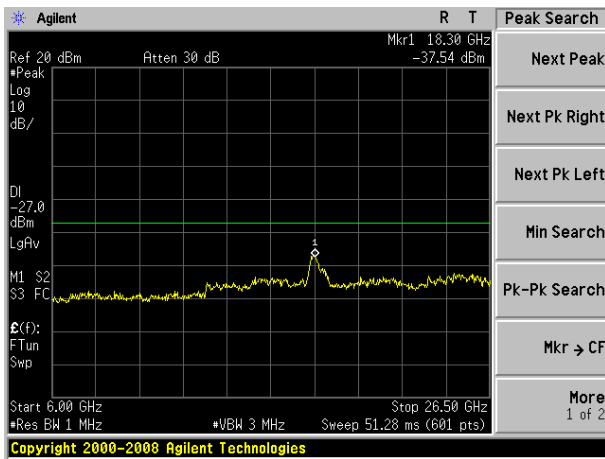

802.11ac20 on channel 157

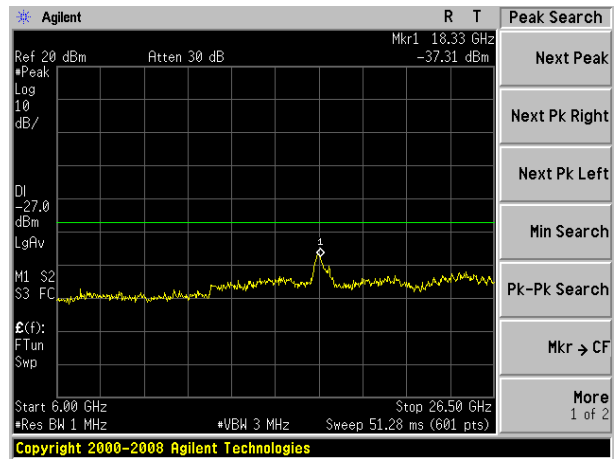

### Test Plot

802.11ac20 on channel 165

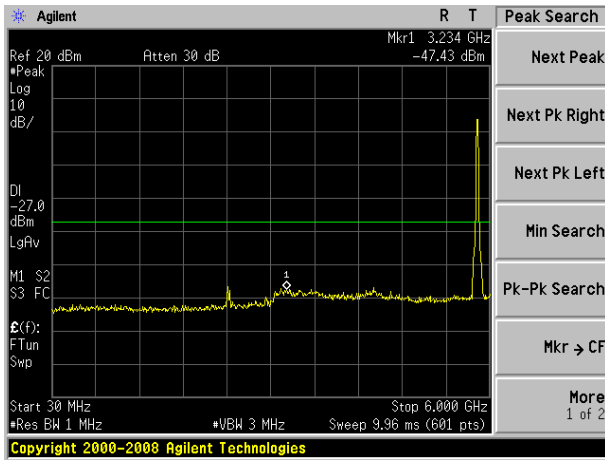

802.11ac40 on channel 151

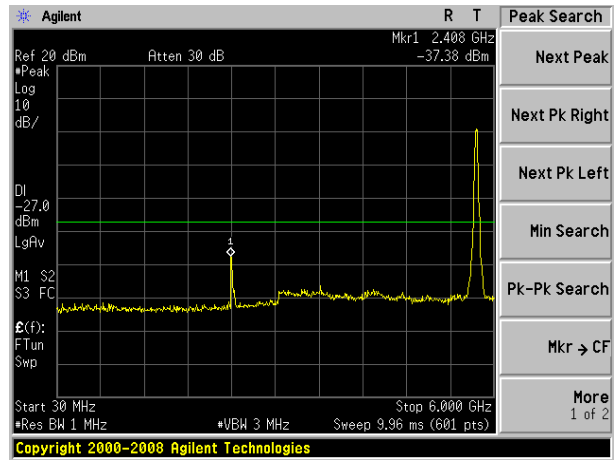

802.11ac20 on channel 165

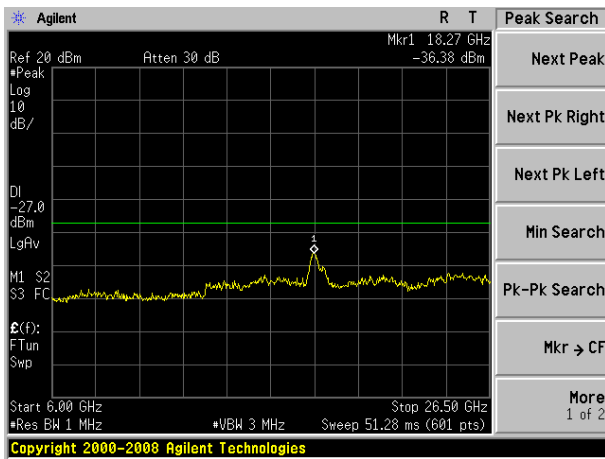

802.11ac40 on channel 151

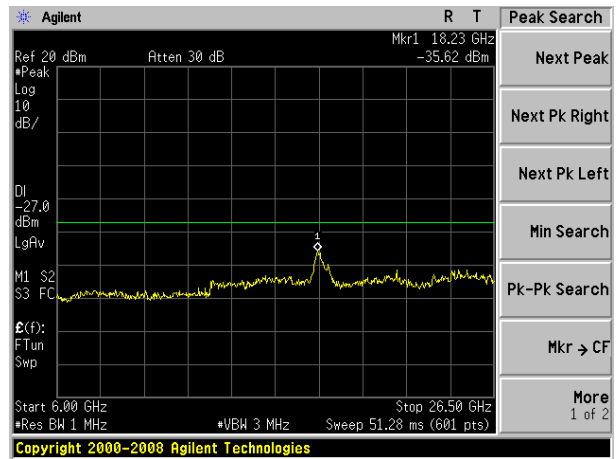



### Test Plot

802.11ac40 on channel 159

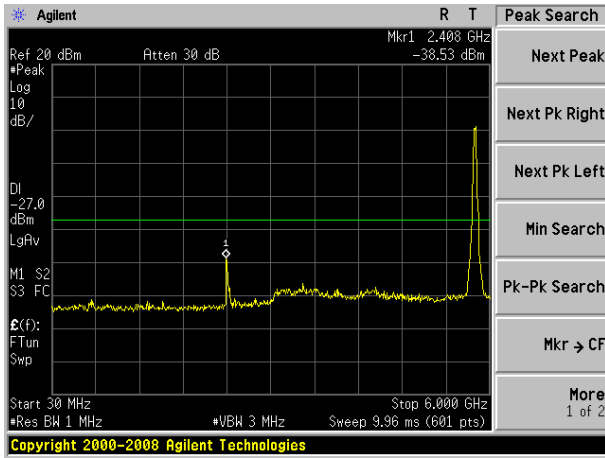

802.11ac80 on channel 155

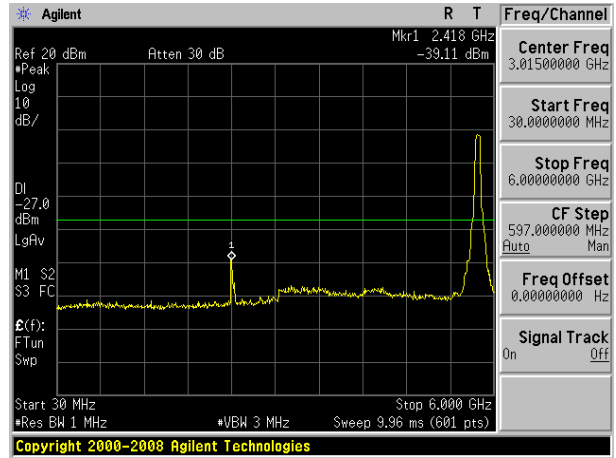

802.11 ac40 on channel 159

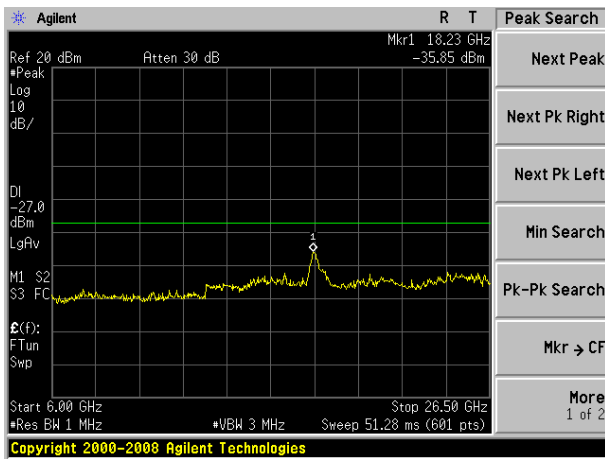

802.11 ac80 on channel 155

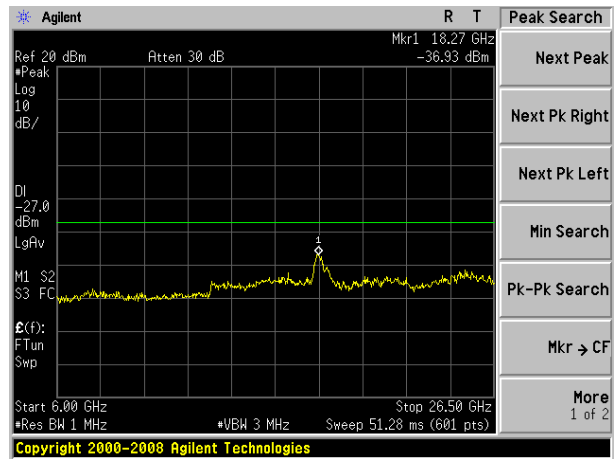

## 10. Frequency Stability Measurement

### 10.1 LIMIT

Manufacturers of U-NII devices are responsible for ensuring frequency stability such that an emission is maintained within the band of operation under all conditions of normal operation as specified in the user's manual.

The transmitter center frequency tolerance shall be  $\pm 20$  ppm maximum for the 5 GHz band (IEEE802.11n specification).

### 10.2 TEST PROCEDURES

1. The transmitter output (antenna port) was connected to the spectrum analyzer.
2. EUT have transmitted absence of modulation signal and fixed channelize.
3. Set the spectrum analyzer span to view the entire absence of modulation emissions bandwidth.
4. Set RBW = 10 kHz, VBW = 10 kHz with peak detector and maxhold settings.
5.  $f_c$  is declaring of channel frequency. Then the frequency error formula is  $(f_c - f) / f_c \times 10^6$  ppm and the limit is less than  $\pm 20$  ppm (IEEE 802.11n specification).
6. The test extreme voltage is to change the primary supply voltage from 85 to 115 percent of the nominal value
7. Extreme temperature is  $-20^\circ\text{C} \sim 70^\circ\text{C}$ .

### 10.3 TEST SETUP LAYOUT

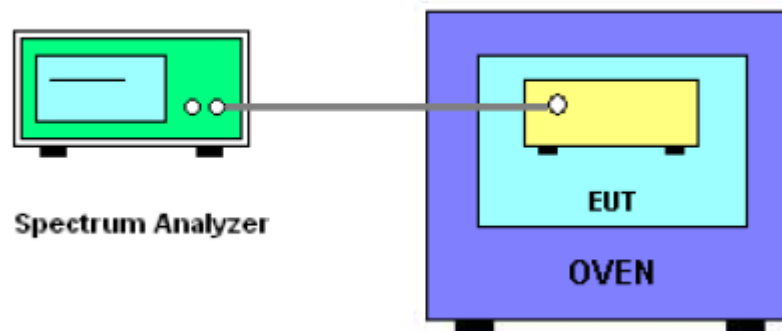

### 10.4 EUT OPERATION DURING TEST

The EUT was programmed to be in continuously un-modulation transmitting mode.

10.5 TEST RESULTS

EUT :	AC1200 Wifi Dual Band USB 3.0 Adapter	Model Name :	AC1200
Temperature :	25 °C	Relative Humidity :	60%
Pressure :	1015 hPa	Test Voltage :	DC 5V from Notebook
Test Mode :	TX Frequency(5150-5250MHz)		

Voltage vs. Frequency Stability

TEST CONDITIONS				Reference Frequency: 5180MHz			
				f	fc	Max. Deviation (MHz)	Max. Deviation (ppm)
T nom (°C)	20	V nom (V)	5.00	5180.00548	5180	0.00548	-1.0579
		V max (V)	5.75	5180.01092	5180	0.01092	-2.1072
		V min (V)	4.25	5180.00460	5180	0.00460	-0.8882
Limits				± 20 ppm			
Result				Complies			

Temperature vs. Frequency Stability

TEST CONDITIONS				Reference Frequency: 5180MHz			
				f	fc	Max. Deviation (MHz)	Max. Deviation (ppm)
V nom (V)	5	T (°C)	-20	5180.00909	5180	0.00909	-1.7552
		T (°C)	-10	5180.00822	5180	0.00822	-1.5860
		T (°C)	0	5180.00891	5180	0.00891	-1.7206
		T (°C)	10	5180.00975	5180	0.00975	-1.8829
		T (°C)	20	5180.00941	5180	0.00941	-1.8174
		T (°C)	30	5180.00449	5180	0.00449	-0.8660
		T (°C)	40	5180.00784	5180	0.00784	-1.5137
		T (°C)	50	5180.00824	5180	0.00824	-1.5915
		T (°C)	60	5180.00111	5180	0.00111	-0.2151
		T (°C)	70	5180.00204	5180	0.00204	-0.3947
Limits				± 20 ppm			
Result				Complies			

TEST CONDITIONS				Reference Frequency: 5200MHz			
				f	fc	Max. Deviation (MHz)	Max. Deviation (ppm)
T nom (°C)	20	V nom (V)	5.00	5200.00912	5200	0.00912	-1.7546
		V max (V)	5.75	5200.01221	5200	0.01221	-2.3478
		V min (V)	4.25	5200.00689	5200	0.00689	-1.3257
Limits				± 20 ppm			
Result				Complies			

Voltage vs. Frequency Stability

Temperature vs. Frequency Stability

TEST CONDITIONS				Reference Frequency: 5200MHz			
				f	fc	Max. Deviation (MHz)	Max. Deviation (ppm)
V nom (V)	5	T (°C)	-20	5200.00069	5200	0.00069	-0.1318
		T (°C)	-10	5200.00603	5200	0.00603	-1.1599
		T (°C)	0	5200.00135	5200	0.00135	-0.2587
		T (°C)	10	5200.01189	5200	0.01189	-2.2862
		T (°C)	20	5200.00915	5200	0.00915	-1.7604
		T (°C)	30	5200.00979	5200	0.00979	-1.8824
		T (°C)	40	5200.00188	5200	0.00188	-0.3616
		T (°C)	50	5200.00308	5200	0.00308	-0.5915
		T (°C)	60	5200.00157	5200	0.00157	-0.3019
		T (°C)	70	5200.00678	5200	0.00678	-1.3039
Limits				± 20 ppm			

Voltage vs. Frequency Stability							
TEST CONDITIONS				Reference Frequency: 5240MHz			
				f	fc	Max. Deviation (MHz)	Max. Deviation (ppm)
T nom (°C)	20	V nom (V)	5.00	5240.00059	5240	0.00059	-0.1119
		V max (V)	5.75	5240.01206	5240	0.01206	-2.3011
		V min (V)	4.25	5240.00446	5240	0.00446	-0.8514
Limits				± 20 ppm			
Result				Complies			

Temperature vs. Frequency Stability							
TEST CONDITIONS				Reference Frequency: 5240MHz			
				f	fc	Max. Deviation (MHz)	Max. Deviation (ppm)
V nom (V)	5	T (°C)	-20	5240.01068	5240	0.01068	-2.0376
		T (°C)	-10	5240.00609	5240	0.00609	-1.1621
		T (°C)	0	5240.01105	5240	0.01105	-2.1085
		T (°C)	10	5240.01099	5240	0.01099	-2.0976
		T (°C)	20	5240.01080	5240	0.01080	-2.0608
		T (°C)	30	5240.01319	5240	0.01319	-2.5164
		T (°C)	40	5240.00138	5240	0.00138	-0.2624
		T (°C)	50	5240.01235	5240	0.01235	-2.3569
		T (°C)	60	5240.01035	5240	0.01035	-1.9754
		T (°C)	70	5240.01201	5240	0.01201	-2.2916
Limits				± 20 ppm			

EUT :	AC1200 Wifi Dual Band USB 3.0 Adapter	Model Name :	AC1200
Temperature :	25 °C	Relative Humidity :	60%
Pressure :	1015 hPa	Test Voltage :	DC 5V from Notebook
Test Mode :	TX Frequency(5745-5850MHz)		

TEST CONDITIONS				Reference Frequency: 5745MHz			
				f	fc	Max. Deviation (MHz)	Max. Deviation (ppm)
T nom (°C)	20	V nom (V)	5.00	5745.00321	5745	0.00321	-0.5588
		V max (V)	5.75	5745.00330	5745	0.00330	-0.5735
		V min (V)	4.25	5745.00938	5745	0.00938	-1.6329
Limits				± 20 ppm			
Result				Complies			

Voltage vs. Frequency Stability

Temperature vs. Frequency Stability

TEST CONDITIONS				Reference Frequency: 5745MHz			
				f	fc	Max. Deviation (MHz)	Max. Deviation (ppm)
V nom (V)	5	T (°C)	-20	5745.00942	5745	0.00942	-1.6402
		T (°C)	-10	5745.00512	5745	0.00512	-0.8908
		T (°C)	0	5745.00442	5745	0.00442	-0.7694
		T (°C)	10	5745.01206	5745	0.01206	-2.1001
		T (°C)	20	5745.01009	5745	0.01009	-1.7568
		T (°C)	30	5745.01027	5745	0.01027	-1.7883
		T (°C)	40	5745.00302	5745	0.00302	-0.5259
		T (°C)	50	5745.00279	5745	0.00279	-0.4864
		T (°C)	60	5745.01077	5745	0.01077	-1.8750
		T (°C)	70	5745.00217	5745	0.00217	-0.3780
Limits				± 20 ppm			
Result				Complies			

Voltage vs. Frequency Stability

TEST CONDITIONS				Reference Frequency: 5785MHz			
				f	fc	Max. Deviation (MHz)	Max. Deviation (ppm)
T nom (°C)	20	V nom (V)	5.00	5785.01184	5785	0.01184	-2.0471
		V max (V)	5.75	5785.00136	5785	0.00136	-0.2344
		V min (V)	4.25	5785.00976	5785	0.00976	-1.6868
Limits				± 20 ppm			
Result				Complies			

Temperature vs. Frequency Stability

TEST CONDITIONS				Reference Frequency: 5785MHz			
				f	fc	Max. Deviation (MHz)	Max. Deviation (ppm)
V nom (V)	5	T (°C)	-20	5785.00189	5785	0.00189	-0.3263
		T (°C)	-10	5785.01335	5785	0.01335	-2.3072
		T (°C)	0	5785.00897	5785	0.00897	-1.5504
		T (°C)	10	5785.00476	5785	0.00476	-0.8235
		T (°C)	20	5785.00132	5785	0.00132	-0.2280
		T (°C)	30	5785.01340	5785	0.01340	-2.3170
		T (°C)	40	5785.01103	5785	0.01103	-1.9058
		T (°C)	50	5785.00959	5785	0.00959	-1.6576
		T (°C)	60	5785.00211	5785	0.00211	-0.3641
		T (°C)	70	5785.00785	5785	0.00785	-1.3570
Limits				± 20 ppm			
Result				Complies			

Voltage vs. Frequency Stability							
TEST CONDITIONS				Reference Frequency: 5825MHz			
				f	fc	Max. Deviation (MHz)	Max. Deviation (ppm)
T nom (°C)	20	V nom (V)	5.00	5825.01301	5825	0.01301	-2.2332
		V max (V)	5.75	5825.00006	5825	0.00006	-0.0096
		V min (V)	4.25	5825.00509	5825	0.00509	-0.8733
Limits				± 20 ppm			
Result				Complies			

Temperature vs. Frequency Stability							
TEST CONDITIONS				Reference Frequency: 5825MHz			
				f	fc	Max. Deviation (MHz)	Max. Deviation (ppm)
V nom (V)	5	T (°C)	-20	5825.00014	5825	0.00014	-0.0237
		T (°C)	-10	5825.00536	5825	0.00536	-0.9195
		T (°C)	0	5825.01335	5825	0.01335	-2.2923
		T (°C)	10	5825.00151	5825	0.00151	-0.2584
		T (°C)	20	5825.00601	5825	0.00601	-1.0320
		T (°C)	30	5825.00728	5825	0.00728	-1.2503
		T (°C)	40	5825.00076	5825	0.00076	-0.1298
		T (°C)	50	5825.00016	5825	0.00016	-0.0271
		T (°C)	60	5825.00781	5825	0.00781	-1.3412
		T (°C)	70	5825.01279	5825	0.01279	-2.1958
Limits				± 20 ppm			
Result				Complies			



## 11. ANTENNA REQUIREMENT

### 11.1 STANDARD REQUIREMENT

15.203 requirement: For intentional device, according to 15.203: an intentional radiator shall be designed to ensure that no antenna other than that furnished by the responsible party shall be used with the device.

### 11.2 EUT ANTENNA

The EUT antenna is permanent attached PCB antenna (antenna gainA:1dBi, antenna gainB:1dBi ).It comply with the standard requirement.

END OF REPORT