



Shenzhen Global Test Service Co.,Ltd.

No.7-101 and 8A-104, Building 7 and 8, DCC Cultural and Creative Garden, No.98, Pingxin North Road, Shangmugu Community, Pinghu Street, Longgang District, Shenzhen, Guangdong

FCC PART 15 SUBPART C TEST REPORT

FCC PART 15.247

Report Reference No.....: GTSR18080103-WLAN01

FCC ID..... : 2AL6K-R8812AF1

Compiled by

(position+printed name+signature)..: File administrators Jimmy Wang

Supervised by

(position+printed name+signature)..: Test Engineer Aaron Tan



Approved by

(position+printed name+signature)..: Manager Jason Hu

Date of issue.....: Sep.15, 2018

Representative Laboratory Name .: Shenzhen Global Test Service Co.,Ltd.

Address.....: No.7-101 and 8A-104, Building 7 and 8, DCC Cultural and Creative Garden, No.98, Pingxin North Road, Shangmugu Community, Pinghu Street, Longgang District, Shenzhen, Guangdong

Applicant's name.....: Shenzhen Bilian Electronic Co.,Ltd.

Address: Building B1,Zhongxing Industrial Zone,Juling,Jutang Community, Guanlan street,Longhua New District, Shenzhen, Guangdong, P.R.China

Test specification

Standard

FCC Part 15.247

TRF Originator.....: Shenzhen Global Test Service Co.,Ltd.

Master TRF.....: Dated 2014-12

Shenzhen Global Test Service Co.,Ltd. All rights reserved.

This publication may be reproduced in whole or in part for non-commercial purposes as long as the Shenzhen Global Test Service Co.,Ltd. is acknowledged as copyright owner and source of the material. Shenzhen Global Test Service Co.,Ltd. takes no responsibility for and will not assume liability for damages resulting from the reader's interpretation of the reproduced material due to its placement and context.

Test item description

IEEE 802.11a/ b/g/n/ac 2T2R USB2.0 WiFi Module

Trade Mark

LB-LINK

Manufacturer

Shenzhen Bilian Electronic Co.,Ltd.

Model/Type reference.....

BL-R8812AF1

Listed Models

/

Modulation Type

IEEE 802.11a /802.11ac /802.11b/802.11g/802.11n

Operation Frequency.....: From 2412 - 2462MHz & 5745-5825 MHz

Hardware Version

V1

Software Version

V62.10

Rating

DC 5V from PC input AC 120V/60Hz

Result.....: **PASS**

TEST REPORT

Test Report No. :	GTSR18080103-WLAN01	Sep.15, 2018
		Date of issue

Equipment under Test : **IEEE 802.11a/ b/g/n/ac 2T2R USB2.0 WiFi Module**

Model /Type : **BL-R8812AF1**

Listed Models : **/**

Applicant : **Shenzhen Bilian Electronic Co.,Ltd.**

Address : Building B1,Zhongxing Industrial Zone,Juling,Jutang Community,
Guanlan street,Longhua New District, Shenzhen, Guangdong,
P.R.China

Manufacturer : **Shenzhen Bilian Electronic Co.,Ltd.**

Address : Building B1,Zhongxing Industrial Zone,Juling,Jutang Community,
Guanlan street,Longhua New District, Shenzhen, Guangdong,
P.R.China

Test Result:	PASS
---------------------	-------------

The test report merely corresponds to the test sample.
It is not permitted to copy extracts of these test result without the written permission of the test laboratory.

Contents

<u>1.</u>	<u>TEST STANDARDS</u>	<u>4</u>
<u>2.</u>	<u>SUMMARY</u>	<u>5</u>
2.1.	General Remarks	5
2.2.	Product Description	5
2.3.	Equipment Under Test	5
2.4.	Short description of the Equipment under Test (EUT)	5
2.5.	EUT operation mode	5
2.6.	Block Diagram of Test Setup	6
2.7.	Related Submittal(s) / Grant (s)	6
2.8.	Modifications	6
<u>3.</u>	<u>TEST ENVIRONMENT</u>	<u>7</u>
3.1.	Address of the test laboratory	7
3.2.	Test Facility	7
3.3.	Environmental conditions	7
3.4.	Test Description	8
3.5.	Statement of the measurement uncertainty	9
3.6.	Equipments Used during the Test	10
<u>4.</u>	<u>TEST CONDITIONS AND RESULTS</u>	<u>11</u>
4.1.	AC Power Conducted Emission	11
4.2.	Radiated Emission.....	13
4.3.	Maximum Peak Output Power.....	21
4.4.	Power Spectral Density	24
4.5.	6dB Bandwidth	29
4.6.	Band Edge Compliance of RF Emission	35
4.7.	Spurious RF Conducted Emission	49
4.8.	Antenna Requirement.....	62
<u>5.</u>	<u>TEST SETUP PHOTOS OF THE EUT</u>	<u>63</u>
<u>6.</u>	<u>EXTERNAL AND INTERNAL PHOTOS OF THE EUT</u>	<u>65</u>

1. TEST STANDARDS

The tests were performed according to following standards:

[FCC Rules Part 15.247](#): Frequency Hopping, Direct Spread Spectrum and Hybrid Systems that are in operation within the bands of 902-928 MHz, 2400-2483.5 MHz, and 5725-5850 MHz.

[ANSI C63.10-2013](#): American National Standard for Testing Unlicensed Wireless Devices

[KDB558074 D01 V05](#): Guidance for Performing Compliance Measurements on Digital Transmission Systems (DTS) Operating Under §15.247

[KDB 662911 D01 Multiple Transmitter Output v02r01](#): Emissions Testing of Transmitters with Multiple Outputs in the Same Band

2. SUMMARY

2.1. General Remarks

Date of receipt of test sample	:	Aug.15, 2018
Testing commenced on	:	Aug.15, 2018
Testing concluded on	:	Sep.12, 2018

2.2. Product Description

Name of EUT	IEEE 802.11a/ b/g/n/ac 2T2R USB2.0 WiFi Module
Trade Mark:	LB-LINK
Model Number	BL-R8812AF1
Listed Models	DC 5V from USB
Power Supply	IEEE 802.11a/ b/g/n/ac 2T2R USB2.0 WiFi Module
WLAN	Supported 802.11a/ 802.11ac/802.11b/802.11g/802.11n
Modulation Type	IEEE 802.11ac: OFDM(64QAM, 16QAM, QPSK, BPSK) IEEE 802.11b: DSSS(CCK,DQPSK,DBPSK) IEEE 802.11g: OFDM(64QAM, 16QAM, QPSK, BPSK) IEEE 802.11n HT20: OFDM (64QAM, 16QAM, QPSK,BPSK) IEEE 802.11n HT40: OFDM (64QAM, 16QAM, QPSK,BPSK)
Operation frequency	IEEE 802.11a/ac VHT20: 5745MHz-5825MHz IEEE 802.11ac VHT 80: 5775MHz IEEE 802.11b/g:2412-2462MHz IEEE 802.11n HT20:2412-2462MHz/5745MHz-5825MHz IEEE 802.11n HT40 /ac CHT 40:2422-2452MHz/5755-5795 MHz
Directional gain	@2.4G GANT +10log(N)dbi =1.92+10log2=4.93dbi <6 dbi @5G GANT +10log(N)dbi =4+10log2=7.01dbi >6 dbi
Antenna Type	external antenna
Antenna gain	1.92dBi @2.4G for ANT1 and ANT2 4.0dBi @5G for ANT1 and ANT2

2.3. Equipment Under Test

Power supply system utilised

Power supply voltage	:	<input type="radio"/> 230V / 50 Hz	<input type="radio"/> 120V / 60Hz
		<input type="radio"/> 12 V DC	<input type="radio"/> 24 V DC
		<input checked="" type="radio"/> Other (specified in blank below)	

DC 5V from PC input AC 120V/60Hz

2.4. Short description of the Equipment under Test (EUT)

This is a WiFi Module.

For more details, refer to the user's manual of the EUT.

2.5. EUT operation mode

The application provider specific test software to control sample in continuous TX and RX (Duty Cycle >98%) for testing meet KDB558074 test requirement.

IEEE 802.11b/g/n: Thirteen channels are provided to the EUT.

Channel	Frequency(MHz)	Channel	Frequency(MHz)
1	2412	8	2447
2	2417	9	2452
3	2422	10	2457
4	2427	11	2462
5	2432		
6	2437		
7	2442		

2.6. Block Diagram of Test Setup

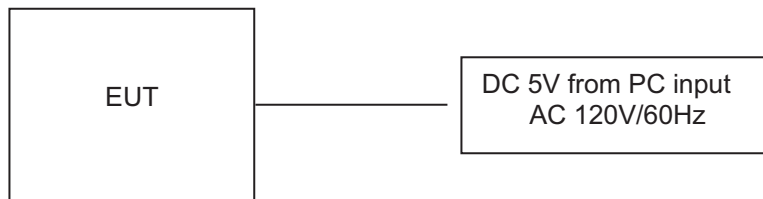

2.7. Special Accessories

Manufacturer	Description	Model	Serial Number	Certificate
TOSHIBA	Tablet PC	Satellite S40Dt-A	D26T	DOC

2.8. Related Submittal(s) / Grant (s)

This submittal(s) (test report) is intended for **FCC ID: 2AL6K-R8812AF1** filing to comply with Section 15.247 of the FCC Part 15, Subpart C Rules.

2.9. Modifications

No modifications were implemented to meet testing criteria.

3. TEST ENVIRONMENT

3.1. Address of the test laboratory

Shenzhen Global Test Service Co.,Ltd.

No.7-101 and 8A-104, Building 7 and 8, DCC Cultural and Creative Garden, No.98, Pingxin North Road, Shangmugu Community, Pinghu Street, Longgang District, Shenzhen, Guangdong

3.2. Test Facility

The test facility is recognized, certified, or accredited by the following organizations:

FCC-Registration No.: 165725

Shenzhen Global Test Service Co.,Ltd EMC Laboratory has been registered and fully described in a report filed with the (FCC) Federal Communications Commission. The acceptance letter from the FCC is maintained in our files.

A2LA-Lab Cert. No.: 4758.01

Shenzhen Global Test Service Co.,Ltd. EMC Laboratory has been accredited by A2LA for technical competence in the field of electrical testing, and proved to be in compliance with ISO/IEC 17025: 2005 General Requirements for the Competence of Testing and Calibration Laboratories and any additional program requirements in the identified field of testing.

CNAS-Lab Code: L8169

Shenzhen Global Test Service Co.,Ltd. has been assessed and proved to be in compliance with CNAS-CL01 Accreditation Criteria for Testing and Calibration Laboratories (identical to ISO/IEC 17025: 2005 General Requirements) for the Competence of Testing and Calibration Laboratories. Date of Registration: Dec. 11, 2015. Valid time is until Dec. 10, 2018.

3.3. Environmental conditions

During the measurement the environmental conditions were within the listed ranges:

Temperature:	15-35 ° C
Humidity:	30-60 %
Atmospheric pressure:	950-1050mbar

3.4. Test Description

Test Specification clause	Test case	Test Mode	Test Channel	Recorded In Report		Pass	Fail	NA	NP	Remark
§15.247(b)(4)	Antenna gain	802.11b	<input checked="" type="checkbox"/> Lowest <input checked="" type="checkbox"/> Middle <input checked="" type="checkbox"/> Highest	802.11b	<input checked="" type="checkbox"/> Lowest <input checked="" type="checkbox"/> Middle <input checked="" type="checkbox"/> Highest	<input checked="" type="checkbox"/>	<input type="checkbox"/>	<input type="checkbox"/>	<input type="checkbox"/>	complies
§15.247(e)	Power spectral density	802.11b 802.11g 802.11n HT20 802.11n HT40	<input checked="" type="checkbox"/> Lowest <input checked="" type="checkbox"/> Middle <input checked="" type="checkbox"/> Highest	802.11b 802.11g 802.11n HT20 802.11n HT40	<input checked="" type="checkbox"/> Lowest <input checked="" type="checkbox"/> Middle <input checked="" type="checkbox"/> Highest	<input checked="" type="checkbox"/>	<input type="checkbox"/>	<input type="checkbox"/>	<input type="checkbox"/>	complies
§15.247(a)(2)	Spectrum bandwidth – 6 dB bandwidth	802.11b 802.11g 802.11n HT20 802.11n HT40	<input checked="" type="checkbox"/> Lowest <input checked="" type="checkbox"/> Middle <input checked="" type="checkbox"/> Highest	802.11b 802.11g 802.11n HT20 802.11n HT40	<input checked="" type="checkbox"/> Lowest <input checked="" type="checkbox"/> Middle <input checked="" type="checkbox"/> Highest	<input checked="" type="checkbox"/> <input checked="" type="checkbox"/>	<input type="checkbox"/>	<input type="checkbox"/>	<input type="checkbox"/>	complies
§15.247(b)(1)	Maximum output power	802.11b 802.11g 802.11n HT20 802.11n HT40	<input checked="" type="checkbox"/> Lowest <input checked="" type="checkbox"/> Middle <input checked="" type="checkbox"/> Highest	802.11b 802.11g 802.11n HT20 802.11n HT40	<input checked="" type="checkbox"/> Lowest <input checked="" type="checkbox"/> Middle <input checked="" type="checkbox"/> Highest	<input checked="" type="checkbox"/> <input checked="" type="checkbox"/> <input checked="" type="checkbox"/>	<input type="checkbox"/>	<input type="checkbox"/>	<input type="checkbox"/>	complies
§15.247(d)	Band edge compliance conducted	802.11b 802.11g 802.11n HT20 802.11n HT40	<input checked="" type="checkbox"/> Lowest <input checked="" type="checkbox"/> Highest	802.11b 802.11g 802.11n HT20 802.11n HT40	<input checked="" type="checkbox"/> Lowest <input checked="" type="checkbox"/> Highest	<input checked="" type="checkbox"/> <input checked="" type="checkbox"/>	<input type="checkbox"/>	<input type="checkbox"/>	<input type="checkbox"/>	complies
§15.205	Band edge compliance radiated	802.11b 802.11g 802.11n HT20 802.11n HT40	<input checked="" type="checkbox"/> Lowest <input checked="" type="checkbox"/> Highest	802.11b 802.11g 802.11n HT20 802.11n HT40	<input checked="" type="checkbox"/> Lowest <input checked="" type="checkbox"/> Highest	<input checked="" type="checkbox"/>	<input type="checkbox"/>	<input type="checkbox"/>	<input type="checkbox"/>	complies
§15.247(d)	TX spurious emissions conducted	802.11b 802.11g 802.11n HT20 802.11n HT40	<input checked="" type="checkbox"/> Lowest <input checked="" type="checkbox"/> Middle <input checked="" type="checkbox"/> Highest	802.11b 802.11g 802.11n HT20 802.11n HT40	<input checked="" type="checkbox"/> Lowest <input checked="" type="checkbox"/> Middle <input checked="" type="checkbox"/> Highest	<input checked="" type="checkbox"/> <input checked="" type="checkbox"/>	<input type="checkbox"/>	<input type="checkbox"/>	<input type="checkbox"/>	complies
§15.247(d)	TX spurious emissions radiated	802.11b 802.11g 802.11n HT20 802.11n HT40	<input checked="" type="checkbox"/> Lowest <input checked="" type="checkbox"/> Middle <input checked="" type="checkbox"/> Highest	802.11b 802.11g 802.11n HT20 802.11n HT40	<input checked="" type="checkbox"/> Lowest <input checked="" type="checkbox"/> Middle <input checked="" type="checkbox"/> Highest	<input checked="" type="checkbox"/>	<input type="checkbox"/>	<input type="checkbox"/>	<input type="checkbox"/>	complies
§15.109	RX spurious emissions radiated	-/-	-/-	-/-	-/-	<input type="checkbox"/>	<input type="checkbox"/>	<input checked="" type="checkbox"/>	<input type="checkbox"/>	complies
§15.209(a)	TX spurious Emissions radiated < 30 MHz	802.11b	-/-	802.11b	-/-	<input checked="" type="checkbox"/>	<input type="checkbox"/>	<input type="checkbox"/>	<input type="checkbox"/>	complies
§15.107(a) §15.207	Conducted Emissions < 30 MHz	802.11b	-/-	802.11b	-/-	<input checked="" type="checkbox"/>	<input type="checkbox"/>	<input type="checkbox"/>	<input type="checkbox"/>	complies

Remark:

1. The measurement uncertainty is not included in the test result.

2. NA = Not Applicable; NP = Not Performed

Preliminary tests were performed in different data rate to find the worst radiated emission. The data rate shown in the table below is the worst-case rate with respect to the specific test item. Investigation has been done on all the possible configurations for searching the worst cases. The following table is a list of the test modes shown in this test report.

Test Items	Mode	Data Rate	Channel
Maximum Peak Conducted Output Power Power Spectral Density 6dB Bandwidth Spurious RF conducted emission Radiated Emission 9KHz~1GHz& Radiated Emission 1GHz~10 th Harmonic	11b/DSSS	1 Mbps	1/6/11
	11g/OFDM	6 Mbps	1/6/11
	11n(20MHz)/OFDM	6.5Mbps	1/6/11
	11n(40MHz)/OFDM	13.5Mbps	3/6/9
Band Edge	11b/DSSS	1 Mbps	1/11
	11g/OFDM	6 Mbps	1/11
	11n(20MHz)/OFDM	6.5Mbps	1/11
	11n(40MHz)/OFDM	13.5Mbps	3/9

3.5. Statement of the measurement uncertainty

The data and results referenced in this document are true and accurate. The reader is cautioned that there may be errors within the calibration limits of the equipment and facilities. The measurement uncertainty was calculated for all measurements listed in this test report acc. to CISPR 16 - 4 „Specification for radio disturbance and immunity measuring apparatus and methods – Part 4: Uncertainty in EMC Measurements“ and is documented in the Shenzhen Global Test Service Co.,Ltd quality system acc. to DIN EN ISO/IEC 17025. Furthermore, component and process variability of devices similar to that tested may result in additional deviation. The manufacturer has the sole responsibility of continued compliance of the device.

Hereafter the best measurement capability for Shenzhen GTS laboratory is reported:

Test	Range	Measurement Uncertainty	Notes
Radiated Emission	30~1000MHz	4.10 dB	(1)
Radiated Emission	1~18GHz	4.32 dB	(1)
Radiated Emission	18-40GHz	5.54 dB	(1)
Conducted Disturbance	0.15~30MHz	3.12 dB	(1)

(1) This uncertainty represents an expanded uncertainty expressed at approximately the 95% confidence level using a coverage factor of k=2.

3.6. Equipments Used during the Test

Test Equipment	Manufacturer	Model No.	Serial No.	Calibration Date	Calibration Due Date
LISN	R&S	ENV216	3560.6550.08	2017/09/20	2018/09/19
LISN	R&S	ESH2-Z5	893606/008	2017/09/20	2018/09/19
Bilog Antenna	Schwarzbeck	VULB9163	976	2016/09/20	2019/09/19
EMI Test Receiver	R&S	ESCI7	101102	2017/09/20	2018/09/19
Spectrum Analyzer	Agilent	N9020A	MY48010425	2017/09/20	2018/09/19
Spectrum Analyzer	R&S	FSP40	100019	2018/06/05	2019/06/04
Controller	EM Electronics	Controller EM 1000	N/A	N/A	N/A
Horn Antenna	Schwarzbeck	BBHA 9120D	01622	2016/09/20	2019/09/19
Active Loop Antenna	SCHWARZBEC K	FMZB1519	1519-037	2016/09/20	2019/09/19
Broadband Horn Antenna	SCHWARZBEC K	BBHA 9170	971	2016/09/20	2019/09/19
Amplifier	Schwarzbeck	BBV 9743	#202	2017/09/20	2018/09/19
Amplifier	EMCI	EMC051845B	980355	2017/09/20	2018/09/19
Temperature/Humidity Meter	Gangxing	CTH-608	02	2017/09/20	2018/09/19
High-Pass Filter	K&L	9SH10-2700/X12750-O/O	KL142031	2017/09/20	2018/09/19
High-Pass Filter	K&L	41H10-1375/U12750-O/O	KL142032	2017/09/20	2018/09/19
RF Cable(below 1GHz)	HUBER+SUHNER	RG214	RE01	2017/09/20	2018/09/19
RF Cable(above 1GHz)	HUBER+SUHNER	RG214	RE02	2017/09/20	2018/09/19
Data acquisition card	Agilent	U2531A	TW53323507	2017/09/20	2018/09/19
Power Sensor	Agilent	U2021XA	MY5365004	2017/09/20	2018/09/19
EMI Test Software	R&S	ES-K1	V1.7.1	2017/09/20	2018/09/19
EMI Test Software	JS Tonscend	JS32-RE	2.0.1.5	2017/09/20	2018/09/19

Note: The Cal.Interval was one year.

4. TEST CONDITIONS AND RESULTS

4.1. AC Power Conducted Emission

TEST CONFIGURATION

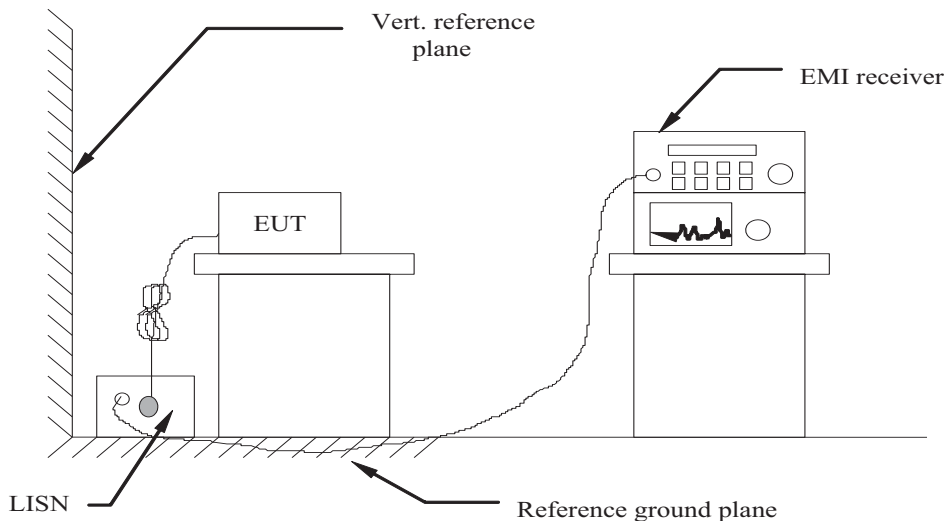

TEST PROCEDURE

- 1 The equipment was set up as per the test configuration to simulate typical actual usage per the user's manual. The EUT is a tabletop system, a wooden table with a height of 0.8 meters is used and is placed on the ground plane as per ANSI C63.10-2013.
- 2 Support equipment, if needed, was placed as per ANSI C63.10-2013
- 3 All I/O cables were positioned to simulate typical actual usage as per ANSI C63.10-2013
- 4 The EUT received DC 5V power from adapter, the adapter received AC120V/60Hz and AC 240V/60Hz power through a Line Impedance Stabilization Network (LISN) which supplied power source and was grounded to the ground plane.
- 5 All support equipments received AC power from a second LISN, if any.
- 6 The EUT test program was started. Emissions were measured on each current carrying line of the EUT using a spectrum Analyzer / Receiver connected to the LISN powering the EUT. The LISN has two monitoring points: Line 1 (Hot Side) and Line 2 (Neutral Side). Two scans were taken: one with Line 1 connected to Analyzer / Receiver and Line 2 connected to a 50 ohm load; the second scan had Line 1 connected to a 50 ohm load and Line 2 connected to the Analyzer / Receiver.
- 7 Analyzer / Receiver scanned from 150 KHz to 30MHz for emissions in each of the test modes.
- 8 During the above scans, the emissions were maximized by cable manipulation.

AC Power Conducted Emission Limit

For intentional device, according to § 15.207(a) AC Power Conducted Emission Limits is as following :

Frequency range (MHz)	Limit (dBuV)	
	Quasi-peak	Average
0.15-0.5	66 to 56*	56 to 46*
0.5-5	56	46
5-30	60	50

* Decreases with the logarithm of the frequency.

TEST RESULTS

Remark: We measured Conducted Emission at 802.11b/802.11g/802.11n HT20/802.11n HT40 mode in DC 5V from PC input AC 120V/60Hz and AC 240V/50Hz, the worst case was recorded for ANT 1(@AC 120V/60Hz).

Power supply:

DC 5V from PC

Polarization

L

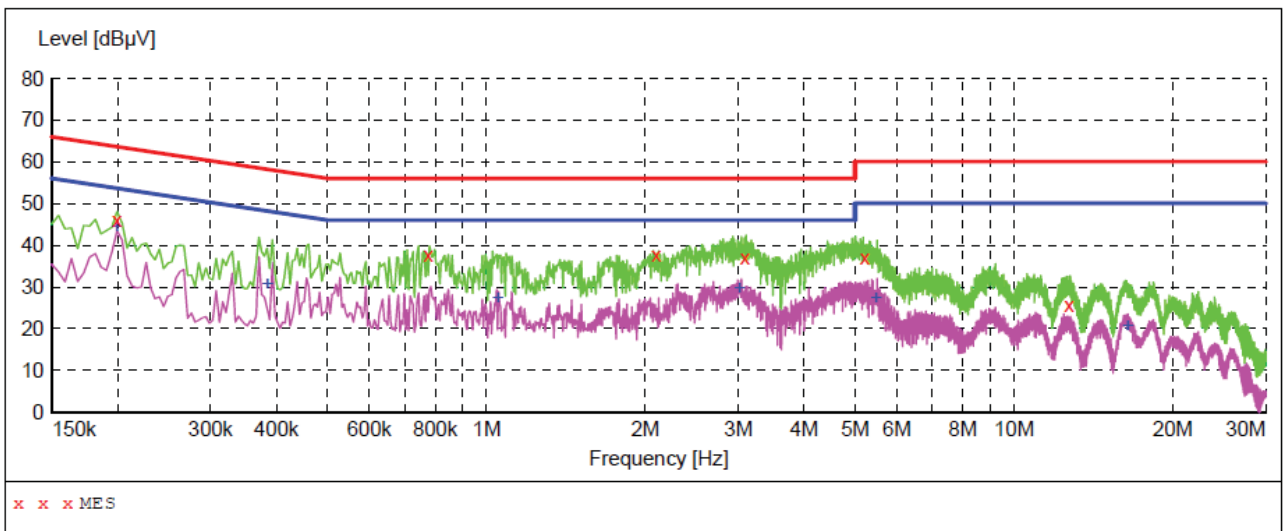

MEASUREMENT RESULT:

Frequency MHz	Level dBµV	Transd dB	Limit dBµV	Margin dB	Detector	Line	PE
0.199500	46.20	10.0	64	17.4	QP	N	GND
0.775500	37.80	9.7	56	18.2	QP	N	GND
2.098500	37.60	9.5	56	18.4	QP	N	GND
3.093000	37.20	9.4	56	18.8	QP	N	GND
5.208000	37.00	9.3	60	23.0	QP	N	GND
12.727500	25.80	8.5	60	34.2	QP	N	GND

MEASUREMENT RESULT:

Frequency MHz	Level dBµV	Transd dB	Limit dBµV	Margin dB	Detector	Line	PE
0.199500	44.50	10.0	54	9.1	AV	N	GND
0.384000	30.60	9.8	48	17.6	AV	N	GND
1.050000	27.50	9.6	46	18.5	AV	N	GND
3.012000	29.50	9.5	46	16.5	AV	N	GND
5.464500	27.40	9.3	50	22.6	AV	N	GND
16.417500	20.50	8.4	50	29.5	AV	N	GND

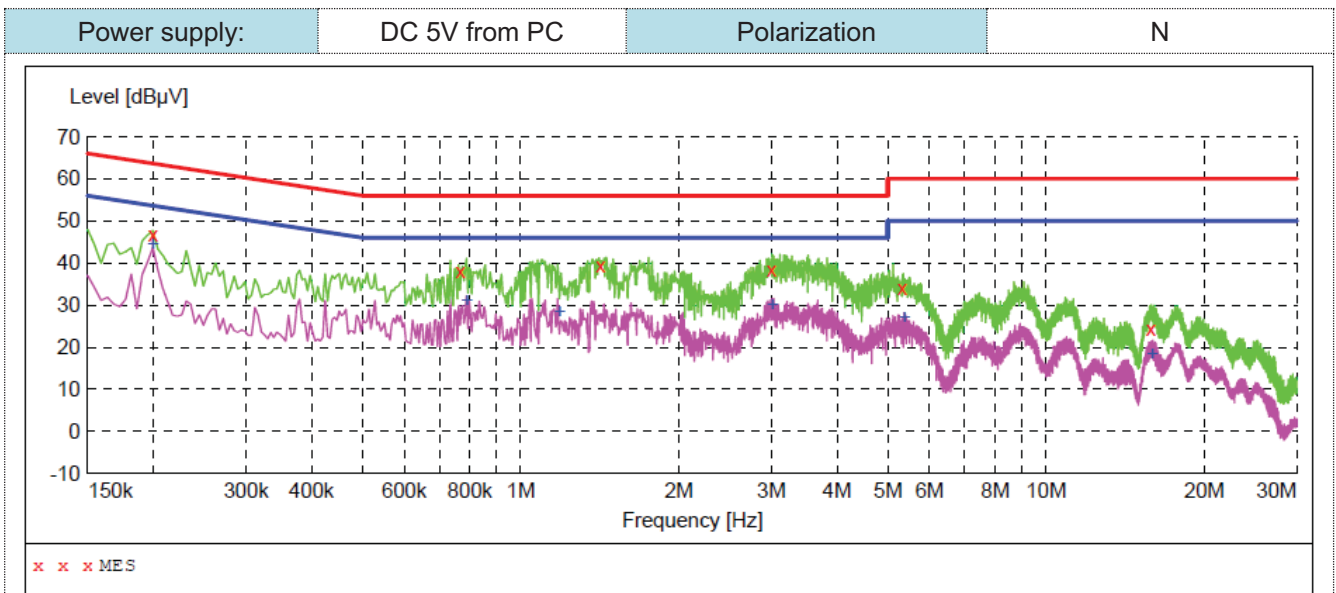

MEASUREMENT RESULT:

Frequency MHz	Level dBµV	Transd dB	Limit dBµV	Margin dB	Detector	Line	PE
0.199500	46.70	10.0	64	16.9	QP	L1	GND
0.766500	38.00	9.7	56	18.0	QP	L1	GND
1.419000	39.50	9.6	56	16.5	QP	L1	GND
2.998500	38.40	9.5	56	17.6	QP	L1	GND
5.320500	33.90	9.3	60	26.1	QP	L1	GND
15.837000	24.50	8.3	60	35.5	QP	L1	GND

MEASUREMENT RESULT:

Frequency MHz	Level dBµV	Transd dB	Limit dBµV	Margin dB	Detector	Line	PE
0.199500	44.30	10.0	54	9.3	AV	L1	GND
0.789000	31.00	9.7	46	15.0	AV	L1	GND
1.185000	28.50	9.6	46	17.5	AV	L1	GND
3.012000	30.00	9.5	46	16.0	AV	L1	GND
5.370000	26.90	9.3	50	23.1	AV	L1	GND
15.940500	18.30	8.4	50	31.7	AV	L1	GND

4.2. Radiated Emission

TEST CONFIGURATION

Frequency range 9 KHz – 30MHz

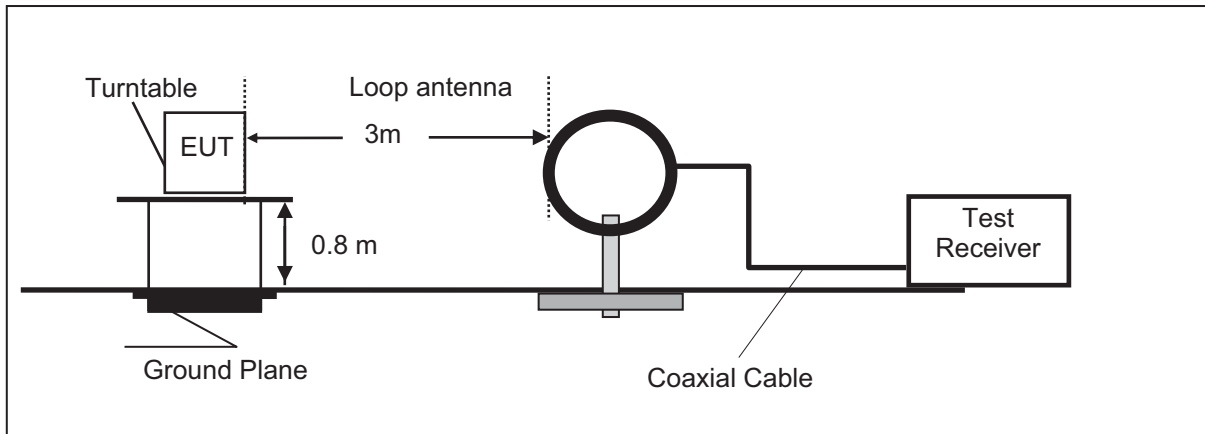

Frequency range 30MHz – 1000MHz

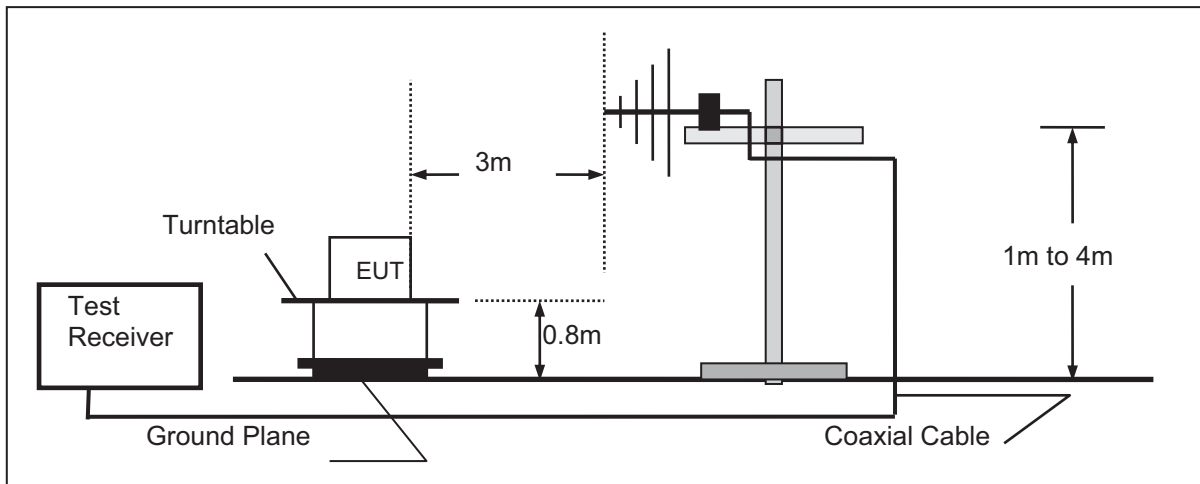

Frequency range above 1GHz-25GHz

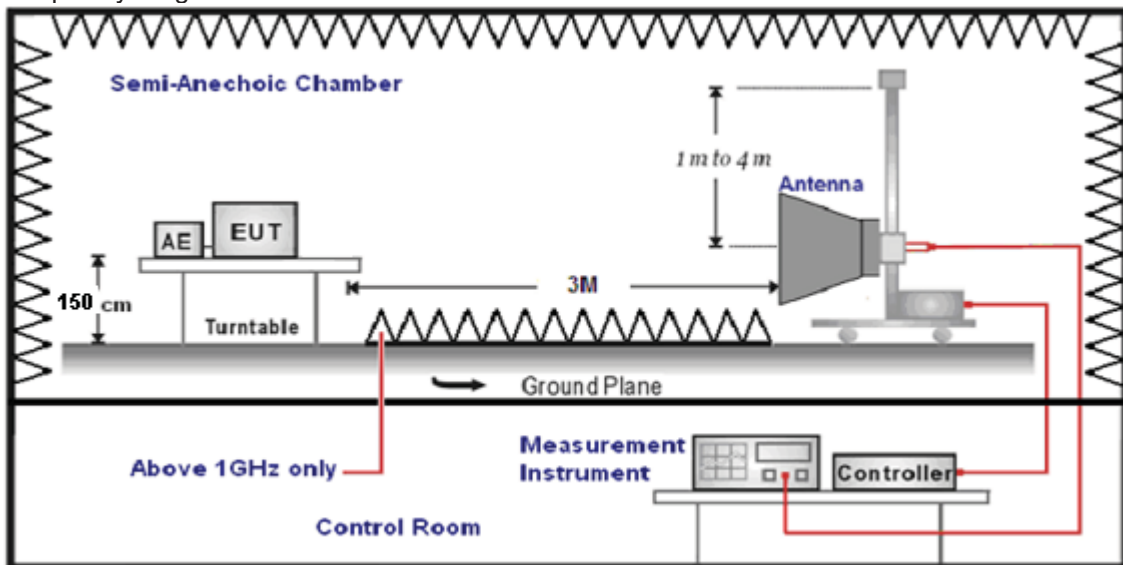

TEST PROCEDURE

1. The EUT was placed on a turn table which is 0.8m above ground plane when testing frequency range 9 KHz –1GHz;the EUT was placed on a turn table which is 1.5m above ground plane when testing frequency range 1GHz – 25GHz.
2. Maximum procedure was performed by raising the receiving antenna from 1m to 4m and rotating the turn table from 0° to 360° to acquire the highest emissions from EUT.
3. And also, each emission was to be maximized by changing the polarization of receiving antenna both horizontal and vertical.
4. Repeat above procedures until all frequency measurements have been completed.
5. Radiated emission test frequency band from 9KHz to 25GHz.
6. The distance between test antenna and EUT as following table states:

Test Frequency range	Test Antenna Type	Test Distance
9KHz-30MHz	Active Loop Antenna	3
30MHz-1GHz	Ultra-Broadband Antenna	3
1GHz-18GHz	Double Ridged Horn Antenna	3
18GHz-25GHz	Horn Antenna	1

7. Setting test receiver/spectrum as following table states:

Test Frequency range	Test Receiver/Spectrum Setting	Detector
9KHz-150KHz	RBW=200Hz/VBW=3KHz,Sweep time=Auto	QP
150KHz-30MHz	RBW=9KHz/VBW=100KHz,Sweep time=Auto	QP
30MHz-1GHz	RBW=120KHz/VBW=1000KHz,Sweep time=Auto	QP
1GHz-40GHz	Peak Value: RBW=1MHz/VBW=3MHz, Sweep time=Auto Average Value: RBW=1MHz/VBW=10Hz, Sweep time=Auto	Peak

Field Strength Calculation

The field strength is calculated by adding the Antenna Factor and Cable Factor and subtracting the Amplifier Gain and Duty Cycle Correction Factor(if any) from the measured reading. The basic equation with a sample calculation is as follows:

$$FS = RA + AF + CL - AG$$

Where FS = Field Strength	CL = Cable Attenuation Factor (Cable Loss)
RA = Reading Amplitude	AG = Amplifier Gain
AF = Antenna Factor	

$$Transd=AF +CL-AG$$

RADIATION LIMIT

For intentional device, according to § 15.209(a), the general requirement of field strength of radiated emission from intentional radiators at a distance of 3 meters shall not exceed the following table. According to § 15.247(d), in any 100kHz bandwidth outside the frequency band in which the EUT is operating, the radio frequency power that is produced by the intentional radiator shall be at least 20dB below that in the100kHz bandwidth within the band that contains the highest level of desired power.

The pre-test have done for the EUT in three axes and found the worst emission at position shown in test setup photos.

Frequency (MHz)	Distance (Meters)	Radiated (dBµV/m)	Radiated (µV/m)
0.009-0.49	3	20log(2400/F(KHz))+40log(300/3)	2400/F(KHz)
0.49-1.705	3	20log(24000/F(KHz))+ 40log(30/3)	24000/F(KHz)
1.705-30	3	20log(30)+ 40log(30/3)	30
30-88	3	40.0	100
88-216	3	43.5	150
216-960	3	46.0	200
Above 960	3	54.0	500

TEST RESULTS

Remark: We tested at 802.11b/802.11g/802.11n HT20/802.11n HT40 mode at the antenna single transmitting mode and 802.11n HT20/802.11n HT40 at the Mimo mode in DC 5V from PC input AC 120V/60Hz, and recored the worst data at the antenna single transmitting mode for ANT 1..

For 9 KHz-30MHz

Freq.	Reading	Limit	Margin	State
(MHz)	(dBuV/m)	(dBuV/m)	(dB)	P/F
--	--	--	--	P
--	--	--	--	P

For 30MHz-1GHz

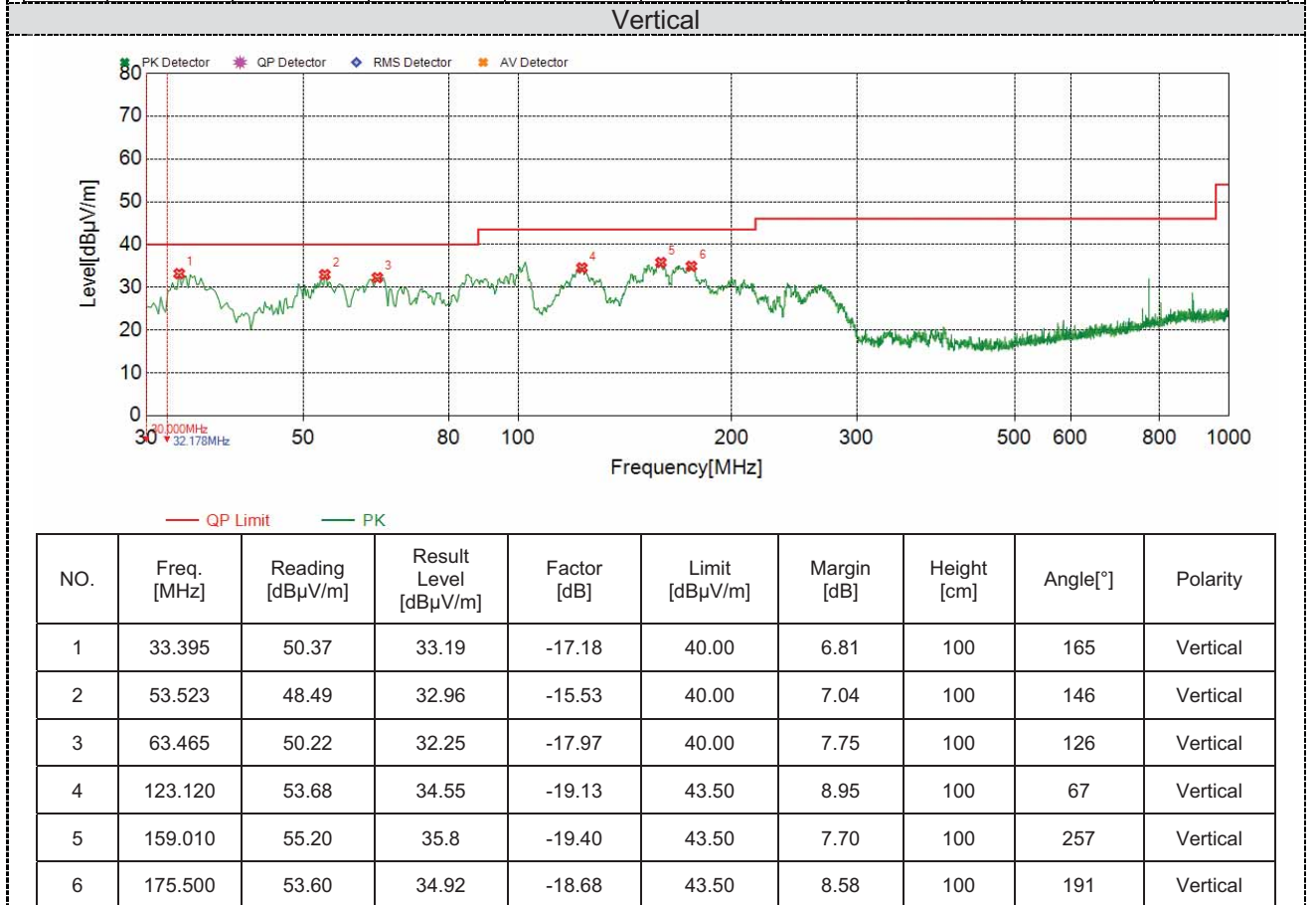
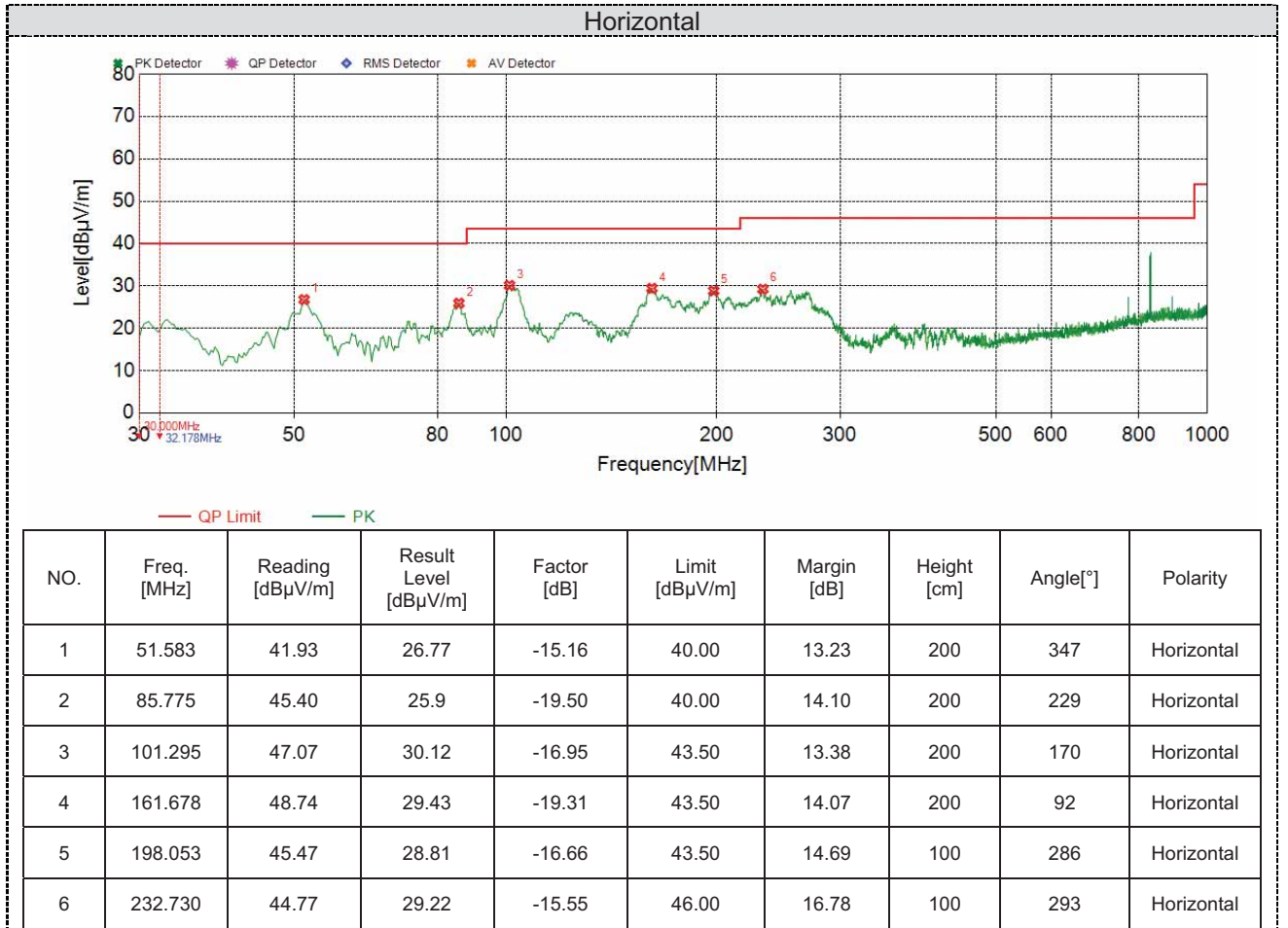

Note:

1. Pre-scan all modes and recorded the worst case results in this report (IEEE 802.11n HT40 mode (Middle Channel, Combined Antenna Chain1 and Antenna Chain2)).
2. Emission level (dBuV/m) = Meter Reading+ antenna Factor+ cable loss- preamp factor
3. Margin value = Emission level-Limits

For 1GHz to 25GHz

802.11b(Worst Case at Antenna Chain 1)

Polar (H/V)	Frequency	Meter Reading	Antenna Factor	Cable loss	Preamp factor	Emission Level	Limits	Margin	Detector Type
	(MHz)	(dBuV)	(dB)	(dB)	(dB)	(dBuV/m)	(dBuV/m)	(dB)	
802.11b-2412MHz									
V	4824	35.56	30.28	7.01	26.63	46.22	74	-27.78	Pk
H	4824	34.36	30.28	7.01	26.63	45.02	74	-28.98	PK
V	7236	27.13	36.59	8.91	24.98	47.65	74	-26.35	Pk
H	7236	26.45	36.59	8.91	24.98	46.97	74	-27.03	PK
802.11b-2437MHz									
V	4874	35.12	30.36	7.62	26.63	46.47	74	-27.53	Pk
H	4874	34.28	30.36	7.62	26.63	45.63	74	-28.37	PK
V	7311	27.38	36.61	8.84	24.98	47.85	74	-26.15	Pk
H	7311	27.86	36.61	8.84	24.98	48.33	74	-25.67	PK
802.11b-2462MHz									
V	4924	36.24	30.43	7.94	26.63	47.98	74	-26.02	Pk
H	4924	35.26	30.43	7.94	26.63	47.00	74	-27.00	PK
V	7386	27.96	36.78	8.45	24.98	48.21	74	-25.79	Pk
H	7386	26.58	36.78	8.45	24.98	46.83	74	-27.17	PK

802.11g(Worst Case at Antenna Chain 1)

Polar (H/V)	Frequency	Meter Reading	Antenna Factor	Cable loss	Preamp factor	Emission Level	Limits	Margin	Detector Type
	(MHz)	(dBuV)	(dB)	(dB)	(dB)	(dBuV/m)	(dBuV/m)	(dB)	
802.11g-2412MHz									
V	4824	33.54	30.28	7.01	26.63	44.20	74	-29.80	Pk
H	4824	32.69	30.28	7.01	26.63	43.35	74	-30.65	PK
V	7236	28.04	36.59	8.91	24.98	48.56	74	-25.44	Pk
H	7236	25.48	36.59	8.91	24.98	46.00	74	-28.00	PK
802.11g-2437MHz									
V	4874	34.12	30.36	7.62	26.63	45.47	74	-28.53	Pk
H	4874	33.21	30.36	7.62	26.63	44.56	74	-29.44	PK
V	7311	26.59	36.61	8.84	24.98	47.06	74	-26.94	Pk
H	7311	26.41	36.61	8.84	24.98	46.88	74	-27.12	PK
802.11g-2462MHz									
V	4924	35.47	30.43	7.94	26.63	47.21	74	-26.79	Pk
H	4924	33.18	30.43	7.94	26.63	44.92	74	-29.08	PK
V	7386	25.42	36.78	8.45	24.98	45.67	74	-28.33	Pk
H	7386	25.18	36.78	8.45	24.98	45.43	74	-28.57	PK

802.11n HT20(Worst case at Combine with Antenna Chain 0 and Antenna Chain 1)

Polar (H/V)	Frequency	Meter Reading	Antenna Factor	Cable loss	Preamp factor	Emission Level	Limits	Margin	Detector Type
	(MHz)	(dBuV)	(dB)	(dB)	(dB)	(dBuV/m)	(dBuV/m)	(dB)	
802.11n20-2412MHz									
V	4824	31.96	30.28	7.01	26.63	42.62	74	-31.38	Pk
H	4824	32.48	30.28	7.01	26.63	43.14	74	-30.86	PK
V	7236	27.59	36.59	8.91	24.98	48.11	74	-25.89	Pk
H	7236	26.32	36.59	8.91	24.98	46.84	74	-27.16	PK
802.11n20-2437MHz									
V	4874	35.48	30.36	7.62	26.63	46.83	74	-27.17	Pk
H	4874	33.32	30.36	7.62	26.63	44.67	74	-29.33	PK
V	7311	26.94	36.61	8.84	24.98	47.41	74	-26.59	Pk
H	7311	25.86	36.61	8.84	24.98	46.33	74	-27.67	PK
802.11n20-2462MHz									
V	4924	34.18	30.43	7.94	26.63	45.92	74	-28.08	Pk
H	4924	33.27	30.43	7.94	26.63	45.01	74	-28.99	PK
V	7386	25.85	36.78	8.45	24.98	46.10	74	-27.90	Pk
H	7386	26.18	36.78	8.45	24.98	46.43	74	-27.57	PK

802.11n HT40(Worst case at Combine with Antenna Chain 0 and Antenna Chain 1)

Polar (H/V)	Frequency	Meter Reading	Antenna Factor	Cable loss	Preamp factor	Emission Level	Limits	Margin	Detector Type
	(MHz)	(dBuV)	(dB)	(dB)	(dB)	(dBuV/m)	(dBuV/m)	(dB)	
802.11n40-2422MHz									
V	4844	29.62	30.18	7.06	26.63	40.23	74	-33.77	Pk
H	4844	30.01	30.18	7.06	26.63	40.62	74	-33.38	PK
V	7266	24.18	36.61	9.02	24.98	44.83	74	-29.17	Pk
H	7266	25.24	36.61	9.02	24.98	45.89	74	-28.11	PK
802.11n40-2437MHz									
V	4874	30.15	30.36	7.62	26.63	41.50	74	-32.50	Pk
H	4874	29.68	30.36	7.62	26.63	41.03	74	-32.97	PK
V	7311	22.58	36.61	8.84	24.98	43.05	74	-30.95	Pk
H	7311	23.35	36.61	8.84	24.98	43.82	74	-30.18	PK
802.11n40-2452MHz									
V	4904	31.26	30.31	8.06	26.63	43.00	74	-31.00	Pk
H	4904	29.29	30.31	8.06	26.63	41.03	74	-32.97	PK
V	7356	21.86	36.56	8.45	24.98	41.89	74	-32.11	Pk
H	7356	23.28	36.56	8.45	24.98	43.31	74	-30.69	PK

Note:

- 1). Measuring frequencies from 9 KHz - 10th harmonic or 26.5GHz (which is less), No emission found between lowest internal used/generated frequency to 30MHz.
- 2). Radiated emissions measured in frequency range from 9k~10th harmonic or 26.5GHz (which is less) were made with an instrument using Peak detector mode.
- 3). Data of measurement within this frequency range shown "---" in the table above means the reading of emissions are attenuated more than 20dB below the permissible limits or the field strength is too small to be measured.
- 4). Worst case data at 1Mbps at IEEE 802.11b; 6Mbps at IEEE 802.11g; 6.5Mbps at IEEE 802.11n HT20; 13.5Mbps at IEEE 802.11n HT40.

4.3. Maximum Peak Output Power

TEST CONFIGURATION

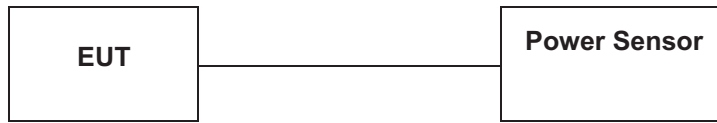

TEST PROCEDURE

According to KDB558074 D01 DTS Measurement Guidance Section 9.1 Maximum peak conducted output power, 9.1.2. and Average conducted output power, 9.2.3.1.

The maximum peak conducted output power may be measured using a broadband peak RF power meter. The power meter shall have a video bandwidth that is greater than or equal to the DTS bandwidth and shall utilize a fast-responding diode detector.

The maximum Average conducted output power may be measured using a wideband RF power meter with a thermocouple detector or equivalent. The power meter shall have a video bandwidth that is greater than or equal to the DTS bandwidth and shall utilize a fast-responding diode detector.

LIMIT

The Maximum Peak Output Power Measurement is 30dBm.

TEST RESULTS

Antenna 1

Type	Channel	Output power PK (dBm)	Output power PK (dBm)	Output power Total (dBm)	Limit (dBm)	Result
		ANT 1	ANT 2			
802.11b	01	17.12	17.13	/	30.00	Pass
	06	17.08	17.26	/		
	11	17.23	17.18	/		
802.11g	01	15.42	15.35	/	30.00	Pass
	06	15.56	15.18	/		
	11	15.31	15.36	/		
802.11n(HT20)	01	14.68	14.72	17.71	30.00	Pass
	06	14.75	14.59	17.68		
	11	14.89	14.66	17.78		
802.11n(HT40)	03	14.02	14.13	17.09	30.00	Pass
	06	14.11	14.22	17.18		
	09	14.21	14.32	17.28		

Note:

- 1) Measured output power at difference data rate for each mode and recorded worst case for each mode.
- 2) Test results including cable loss;
- 3) Worst case data at 1Mbps at IEEE 802.11b; 6Mbps at IEEE 802.11g; 6.5Mbps at IEEE 802.11n HT20; 13.5Mbps at IEEE 802.11n HT40;
- 4) The EUT used two monopole antenna for WIFI TX/RX, the directional gain=1.92+10log2=4.93dbi < 6 dbi

Duty cycle used in all test items: 100%

802.11b

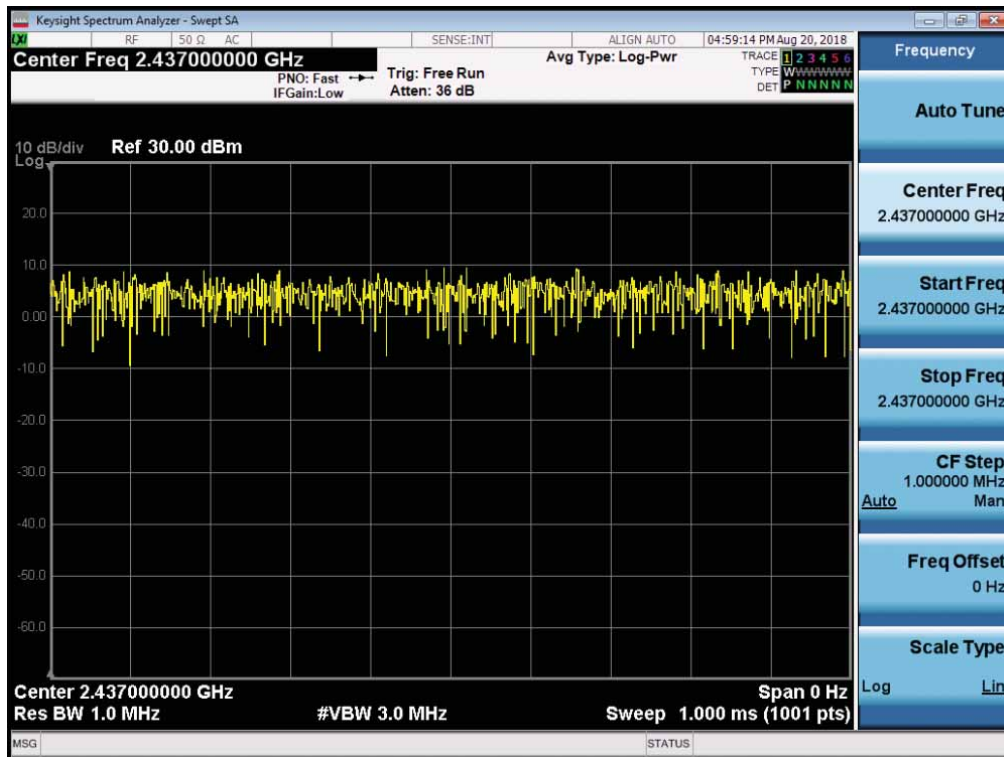

802.11g

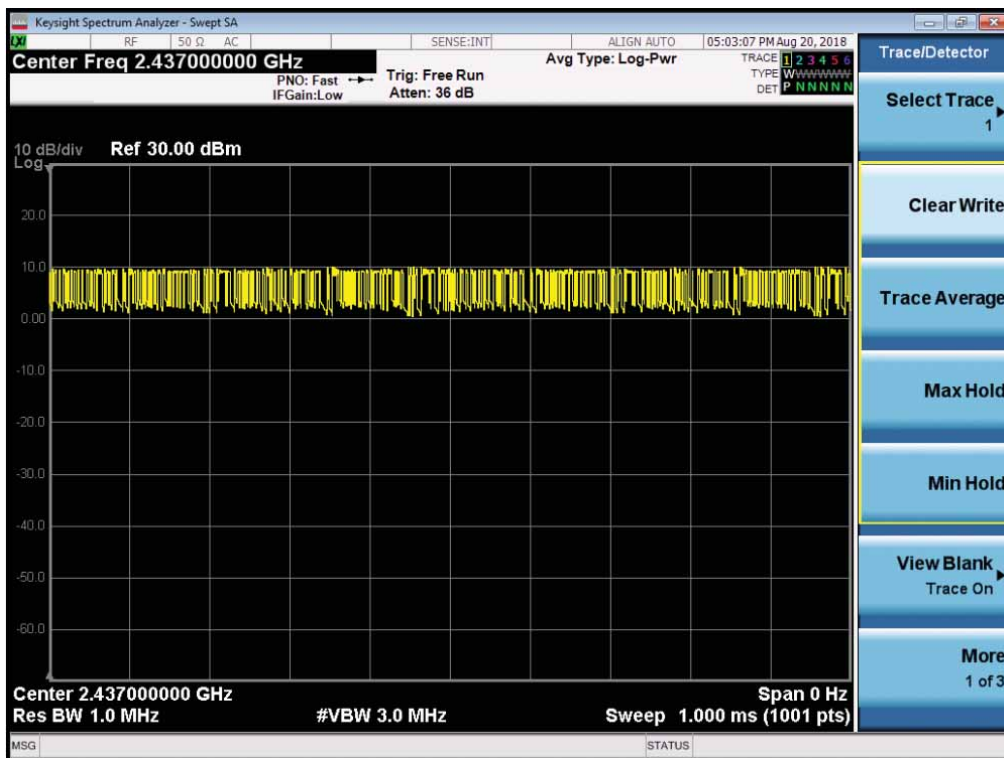

802.11n20

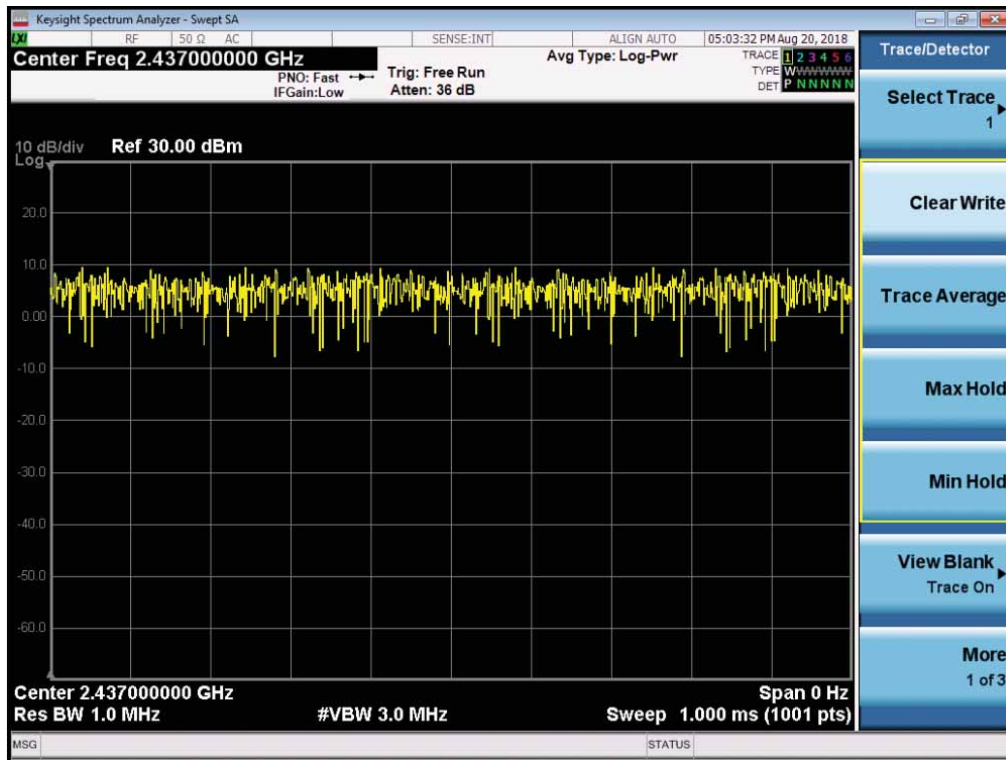

802.11n40

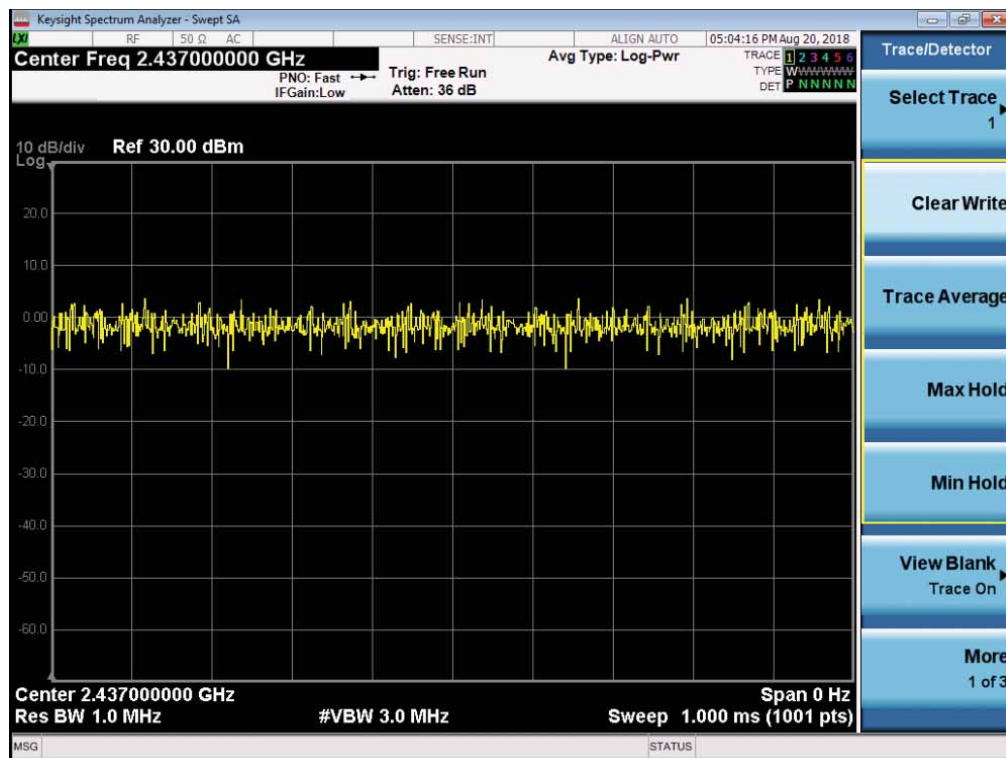

4.4. Power Spectral Density

TEST CONFIGURATION

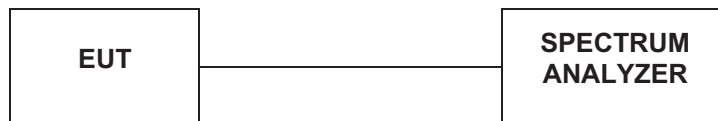

TEST PROCEDURE

According to KDB 558074 D01 Method PKPSD (peak PSD) This procedure shall be used if maximum peak conducted output power was used to demonstrate compliance, and is optional if the maximum conducted (average) output power was used to demonstrate compliance.

1. Set analyzer center frequency to DTS channel center frequency.
2. Set the span to 1.5 times the DTS bandwidth.
3. Set the RBW to: $3 \text{ kHz} \leq \text{RBW} \leq 100 \text{ kHz}$.
4. Set the VBW $\geq 3 \text{ RBW}$.
5. Detector = peak.
6. Sweep time = auto couple.
7. Trace mode = max hold.
8. Allow trace to fully stabilize.
9. Use the peak marker function to determine the maximum amplitude level within the RBW.
10. If measured value exceeds limit, reduce RBW (no less than 3 kHz) and repeat.

LIMIT

For digitally modulated systems, the power spectral density conducted from the intentional radiator to the antenna shall not be greater than 8 dBm in any 3 kHz band during any time interval of continuous transmission.

TEST RESULTS

Type	Channel	Power Spectral Density (dBm/3KHz)	Power Spectral Density (dBm/3KHz)	Power Spectral Density Total(dBm/3KHz)	Limit (dBm/3KHz)	Result
802.11b	01	-15.618	-15.66	/	8.00	Pass
	06	-15.023	-13.818	/		
	11	-13.104	-15.158	/		
802.11g	01	-13.269	-14.568	/	8.00	Pass
	06	-12.806	-15.295	/		
	11	-12.816	-14.072	/		
802.11n(HT20)	01	-13.167	-15.331	-11.105	8.00	Pass
	06	-12.841	-14.127	-10.426		
	11	-12.865	-14.628	-10.647		
802.11n(HT40)	03	-16.79	-17.248	-14.003	8.00	Pass
	06	-16.195	-17.277	-13.692		
	09	-17.579	-18.282	-11.105		

Note:

- 1). Measured peak power spectrum density at difference data rate for each mode and recorded worst case for each mode.
- 2). Test results including cable loss;
- 3). Worst case data at 1Mbps at IEEE 802.11b; 6Mbps at IEEE 802.11g; 6.5Mbps at IEEE 802.11n HT20; 13.5Mbps at IEEE 802.11n HT40;
- 4.) Please refer to following plots;
- 5). The EUT used two monopole antenna for WIFI TX/RX, the directional gain= $1.92+10\log 2=4.93\text{dbi} < 6 \text{ dBi}$
- 6). For MIMO with CCD technology device, The Directional Gain= Gain of individual transmit antennas (dBi) + Array gain;
 $\text{Array gain} = 10 \log (N_{ant})$, where N_{ant} is the number of transmit antennas.

Antenna 1

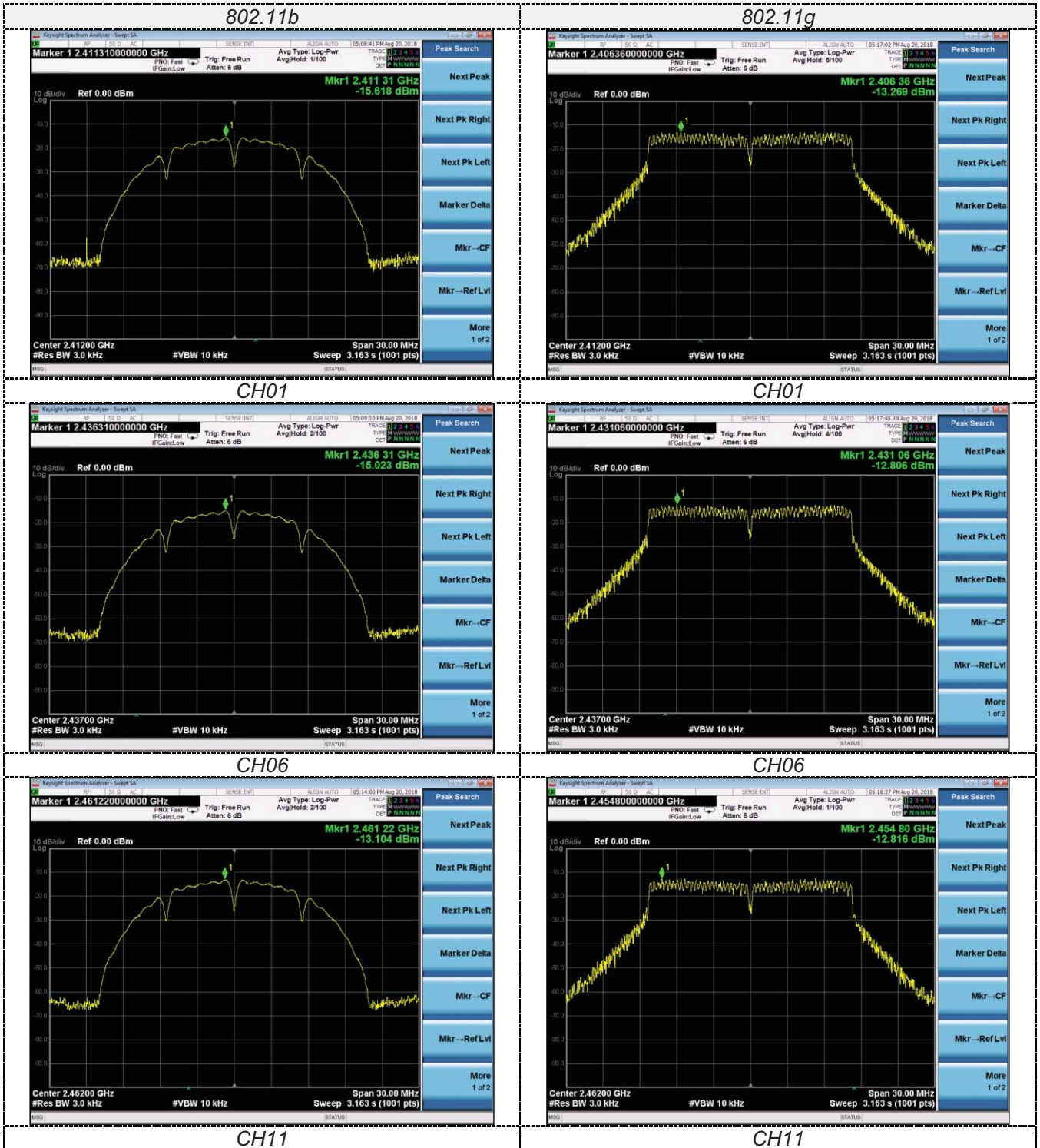

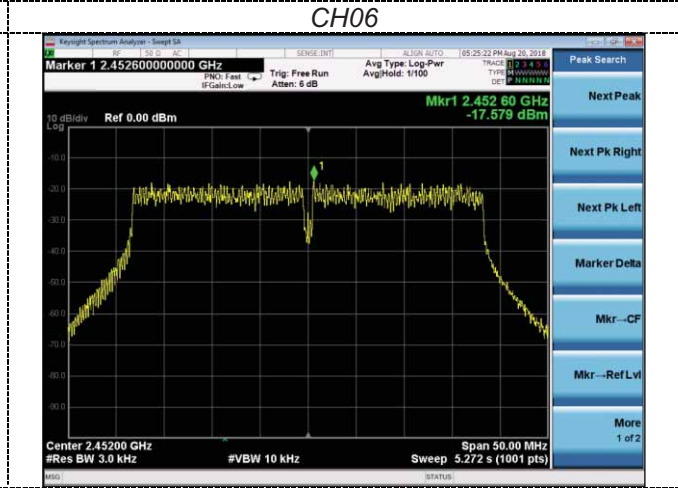
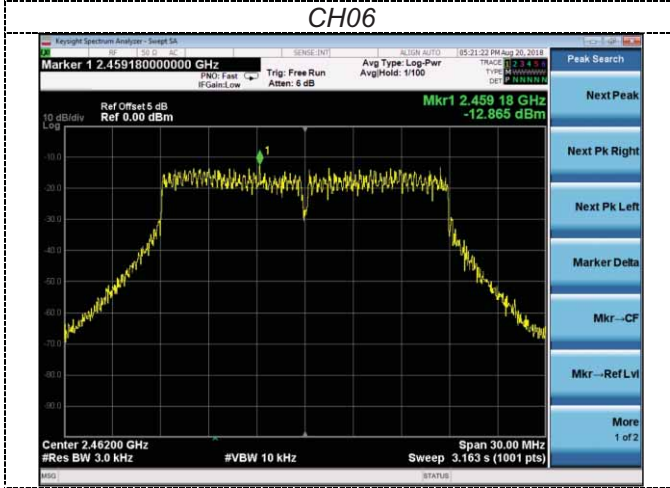
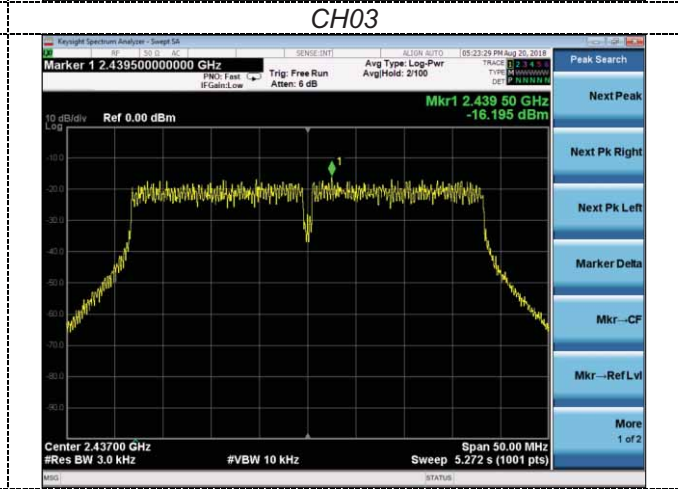
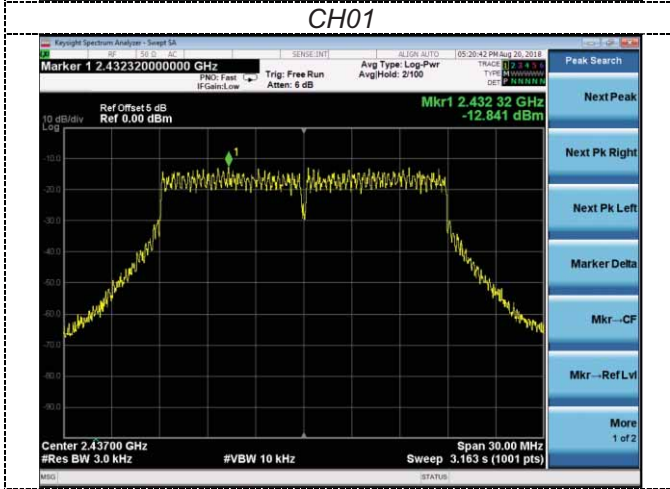
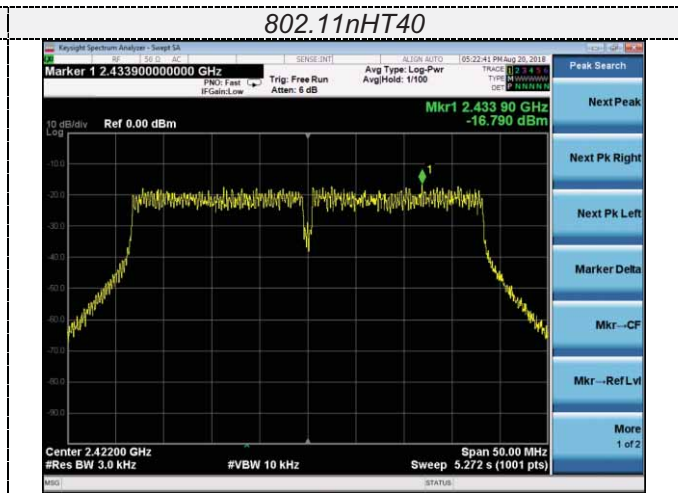
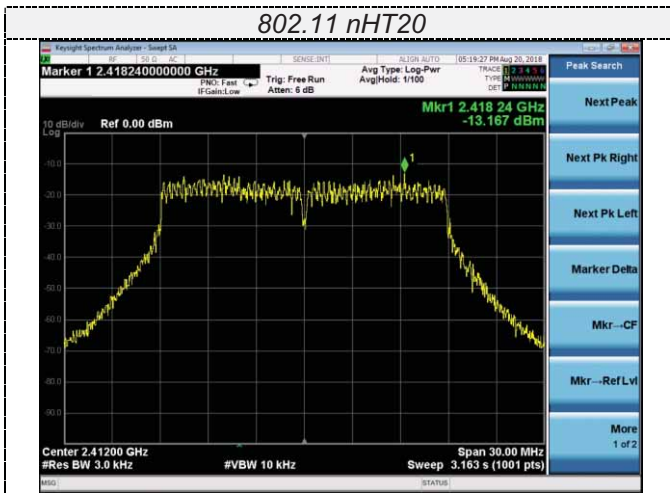

CH11

CH09

Antenna 2

802.11b



802.11g

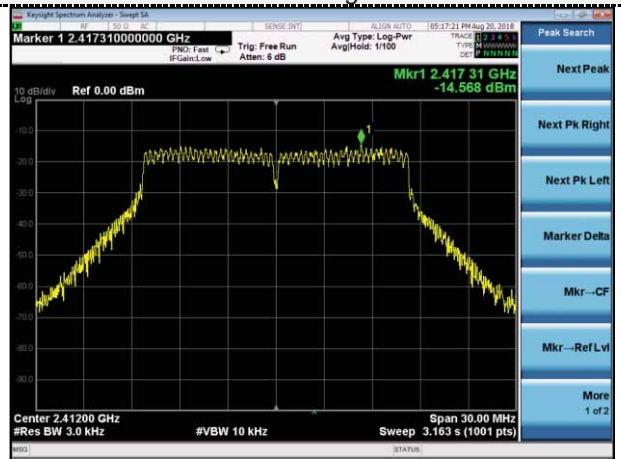

CH01



CH01

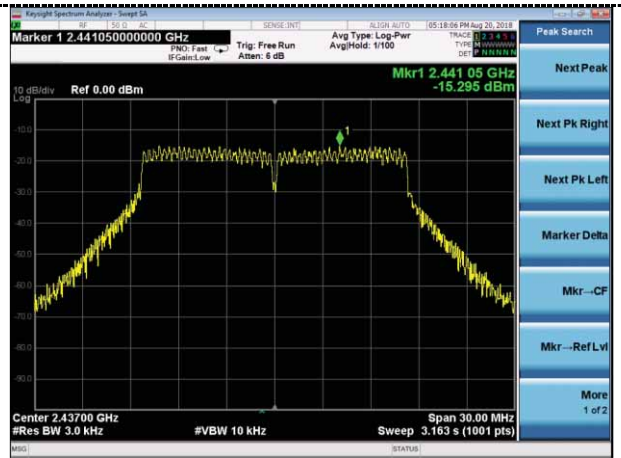

CH06



CH06

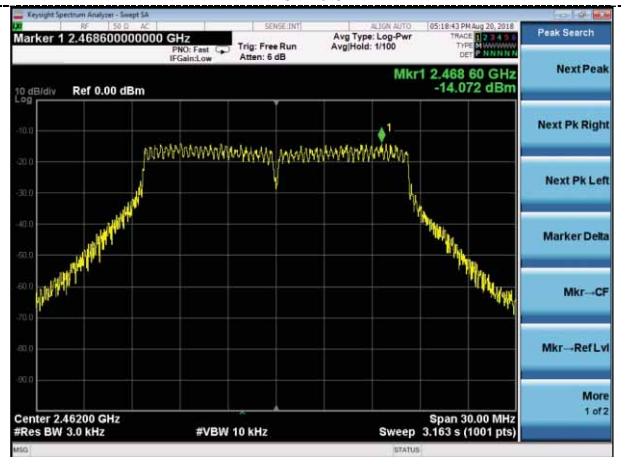

CH11

CH11

802.11 nHT20

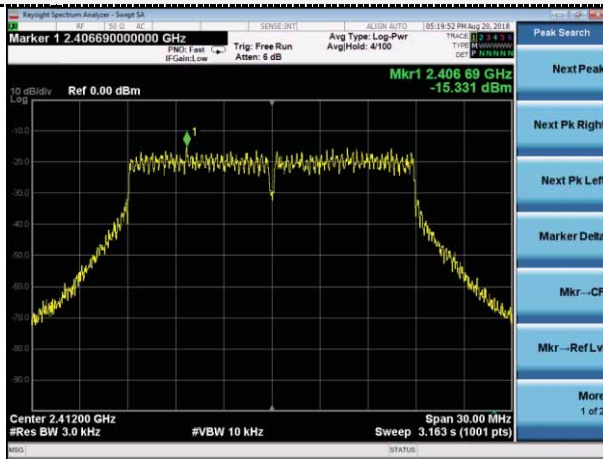

802.11nHT40

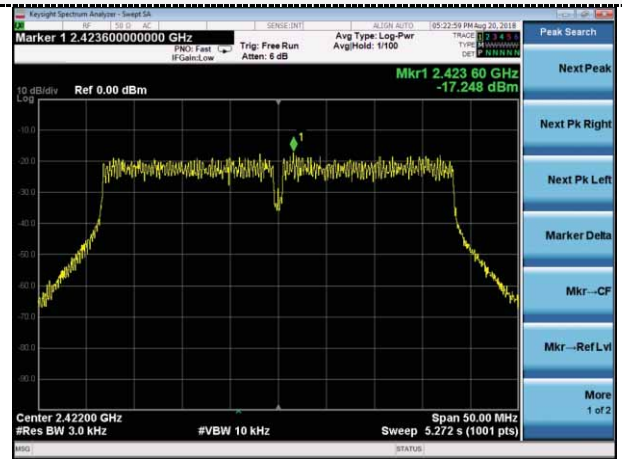

CH01

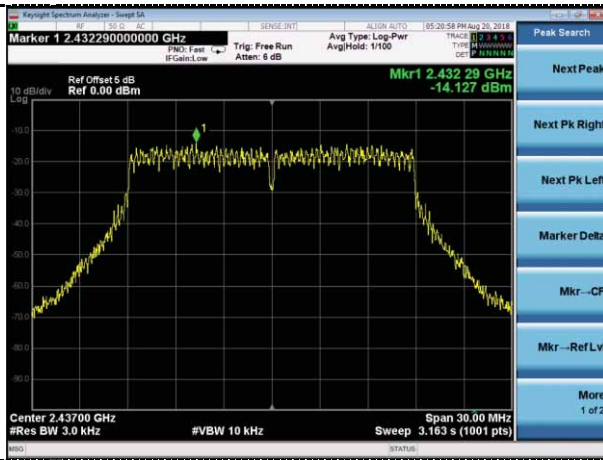

CH03

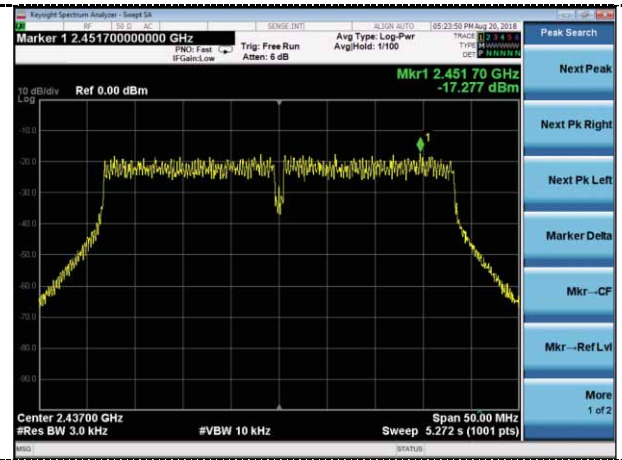

CH06

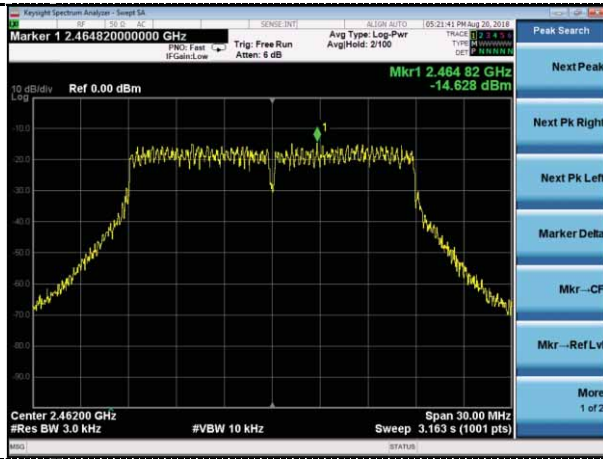

CH06

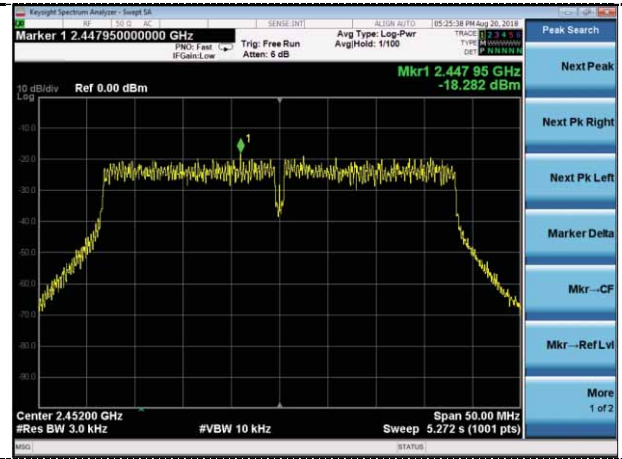

CH11

CH09

4.5. 6dB Bandwidth

TEST CONFIGURATION

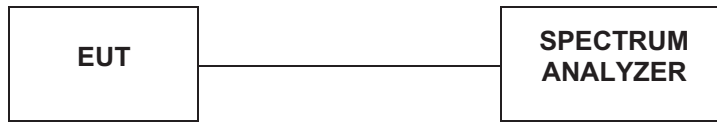

TEST PROCEDURE

The transmitter output was connected to the spectrum analyzer through an attenuator. The bandwidth of the fundamental frequency was measured by spectrum analyzer with RBW=100 KHz and VBW=300KHz. The 6dB bandwidth is defined as the total spectrum the power of which is higher than peak power minus 6dB. According to KDB558074 D01 for one of the following procedures may be used to determine the modulated DTS device signal bandwidth.

1. Set RBW = 100 kHz.
2. Set the video bandwidth (VBW) ≥ 3 RBW.
3. Detector = Peak.
4. Trace mode = max hold.
5. Sweep = auto couple.
6. Allow the trace to stabilize.
7. Measure the maximum width of the emission that is constrained by the frequencies associated with the two outermost amplitude points (upper and lower frequencies) that are attenuated by 6 dB relative to the maximum level measured in the fundamental emission.

LIMIT

For digital modulation systems, the minimum 6 dB bandwidth shall be at least 500 kHz

TEST RESULTS

Antenna 1

Type	Channel	6dB Bandwidth (MHz)	Limit (KHz)	Result
802.11b	01	10.12	≥ 500	Pass
	06	10.12		
	11	10.12		
802.11g	01	16.56	≥ 500	Pass
	06	16.56		
	11	16.57		
802.11nHT20	01	17.83	≥ 500	Pass
	06	17.80		
	11	17.81		
802.11nHT40	03	36.51	≥ 500	Pass
	06	36.47		
	09	36.48		

Antenna 2

Type	Channel	6dB Bandwidth (MHz)	Limit (KHz)	Result
802.11b	01	10.11	≥500	Pass
	06	10.11		
	11	10.12		
802.11g	01	16.57	≥500	Pass
	06	16.57		
	11	16.57		
802.11nHT20	01	17.83	≥500	Pass
	06	17.81		
	11	17.79		
802.11nHT40	03	36.52	≥500	Pass
	06	36.51		
	09	36.54		

Note:

- 1). Measured 6dB Bandwidth at difference data rate for each mode and recorded worst case for each mode.
- 2). Test results including cable loss;
- 3). Worst case data at 1Mbps at IEEE 802.11b; 6Mbps at IEEE 802.11g; 6.5Mbps at IEEE 802.11n HT20; 13.5Mbps at IEEE 802.11n HT40;

Antenna 1

802.11b

802.11g



CH01



CH01



CH06



CH06

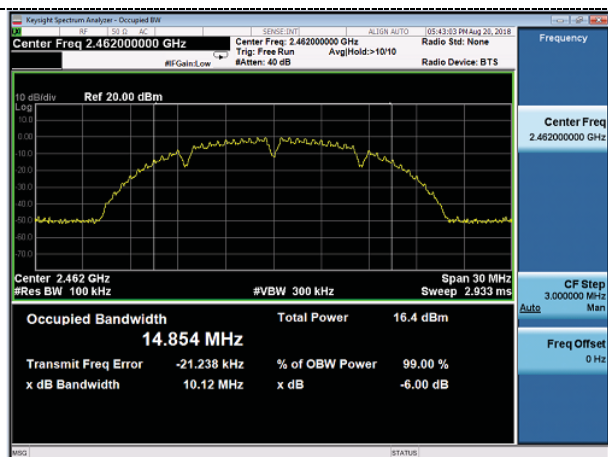

CH11



CH11

802.11n HT20



802.11n HT40

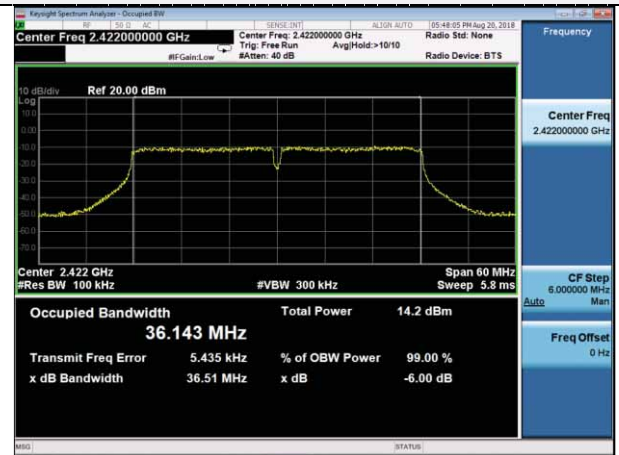

CH01



CH03

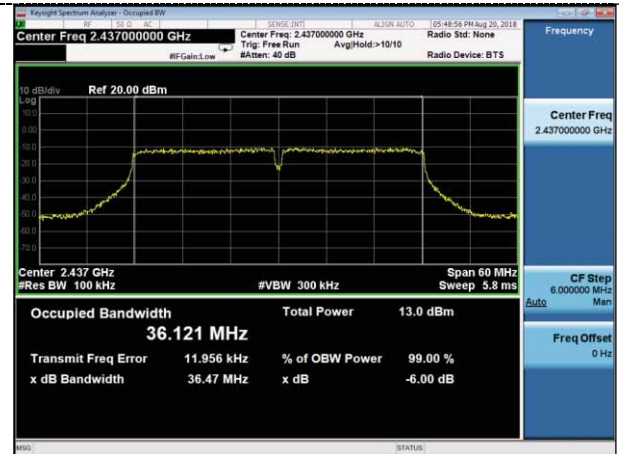

CH06



CH06



CH11

CH09

Antenna 2

802.11b

802.11g



CH01

CH01



CH06

CH06



CH11

CH11

802.11n HT20



802.11n HT40



CH01



CH03



CH06

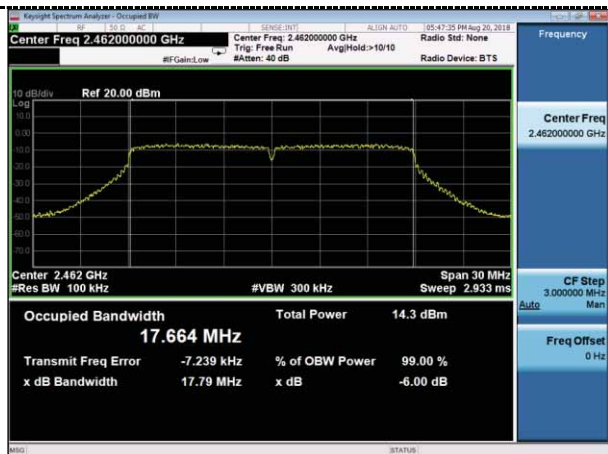

CH06



CH11

CH09

4.6. Band Edge Compliance of RF Emission

TEST REQUIREMENT

In any 100 kHz bandwidth outside the frequency band in which the spread spectrum or digitally modulated intentional radiator is operating, the radio frequency power that is produced by the intentional radiator shall be at least 20 dB below that in the 100 kHz bandwidth within the band that contains the highest level of the desired power, based on either an RF conducted or a radiated measurement, provided the transmitter demonstrates compliance with the peak conducted power limits. If the transmitter complies with the conducted power limits based on the use of RMS averaging over a time interval, as permitted under paragraph (b)(3) of this section, the attenuation required under this paragraph shall be 30 dB instead of 20 dB. Attenuation below the general limits specified in §15.209(a) is not required. In addition, radiated emissions which fall in the restricted bands, as defined in §15.205(a), must also comply with the radiated emission limits specified in §15.209(a) (see §15.205(c)).

TEST PROCEDURE

According to KDB 558074 D01 for Antenna-port conducted measurement. Antenna-port conducted measurements may also be used as an alternative to radiated measurements for demonstrating compliance in the restricted frequency bands. If conducted measurements are performed, then proper impedance matching must be ensured and an additional radiated test for cabinet/case spurious emissions is required.

1. Check the calibration of the measuring instrument using either an internal calibrator or a known signal from an external generator.
2. Remove the antenna from the EUT and then connect to a low loss RF cable from the antenna port to a EMI test receiver, then turn on the EUT and make it operate in transmitting mode. Then set it to Low Channel and High Channel within its operating range, and make sure the instrument is operated in its linear range.
3. Set both RBW and VBW of spectrum analyzer to 100 kHz with a convenient frequency span including 100kHz bandwidth from band edge, for Radiated emissions restricted band RBW=1MHz, VBW=3MHz for peak detector and RBW=1MHz, VBW=10Hz for average detector.
4. Measure the highest amplitude appearing on spectral display and set it as a reference level. Plot the graph with marking the highest point and edge frequency.
5. Repeat above procedures until all measured frequencies were complete.
6. Measure the conducted output power (in dBm) using the detector specified by the appropriate regulatory agency (see 12.2.2, 12.2.3, and 12.2.4 for guidance regarding measurement procedures for determining quasi-peak, peak, and average conducted output power, respectively).
7. Add the maximum transmit antenna gain (in dBi) to the measured output power level to determine the EIRP level (see 12.2.5 for guidance on determining the applicable antenna gain)
8. Add the appropriate maximum ground reflection factor to the EIRP level (6 dB for frequencies \leq 30 MHz, 4.7 dB for frequencies between 30 MHz and 1000 MHz, inclusive and 0 dB for frequencies $>$ 1000 MHz).
9. For devices with multiple antenna-ports, measure the power of each individual chain and sum the EIRP of all chains in linear terms (e.g., Watts, mW).
10. Convert the resultant EIRP level to an equivalent electric field strength using the following relationship:

$$E = \text{EIRP} - 20\log D + 104.8$$

where:

E = electric field strength in dB μ V/m,

EIRP = equivalent isotropic radiated power in dBm

D = specified measurement distance in meters.

11. Since the out-of-band characteristics of the EUT transmit antenna will often be unknown, the use of a conservative antenna gain value is necessary. Thus, when determining the EIRP based on the measured conducted power, the upper bound on antenna gain for a device with a single RF output shall be selected as the maximum in-band gain of the antenna across all operating bands, or 2 dBi, whichever is greater. However, for devices that operate in multiple frequency bands while using the same transmit antenna, the highest gain of the antenna within the operating band nearest in frequency to the restricted band emission being measured may be used in lieu of the overall highest gain when the emission is at a frequency that is within 20 percent of the nearest band edge frequency, but in no case shall a value less than 2 dBi be used.
12. Compare the resultant electric field strength level to the applicable regulatory limit.
13. Perform radiated spurious emission test duress until all measured frequencies were complete.

LIMIT

Below -20dB of the highest emission level in operating band.

Radiated emissions which fall in the restricted bands, as defined in § 15.205(a), must also comply with the radiated emission limits specified in § 15.209(a).

TEST RESULTS

Remark: We tested at 802.11b/802.11g/802.11n HT20/802.11n HT40 mode at the antenna single transmitting mode and 802.11n HT20/802.11n HT40 at the Mimo mode, and recored the worst data at the antenna single transmitting mode.

4.6.1 For Radiated Bandedge Measurement**For Antenna 1**

IEEE 802.11b								
Frequency (MHz)	Conducted Power (dBm)	Antenna Gain (dBi)	Ground Reflection Factor (dB)	Covert Radiated E Level At 3m (dBuV/m)	Detector	Limit (dBuV/m)	Over limit dB	Verdict
2310.000	-47.530	1.92	0	49.620	Peak	74	-24.38	PASS
2310.000	-62.215	1.92	0	34.935	AV	54	-19.065	PASS
2390.000	-50.310	1.92	0	46.84	Peak	74	-27.16	PASS
2390.000	-59.852	1.92	0	37.298	AV	54	-16.702	PASS
2483.500	-48.056	1.92	0	49.094	Peak	74	-24.906	PASS
2483.500	-59.599	1.92	0	37.551	AV	54	-16.449	PASS
2500.000	-49.788	1.92	0	47.362	Peak	74	-26.638	PASS
2500.000	-61.157	1.92	0	35.993	AV	54	-18.007	PASS

IEEE 802.11g								
Frequency (MHz)	Conducted Power (dBm)	Antenna Gain (dBi)	Ground Reflection Factor (dB)	Covert Radiated E Level At 3m (dBuV/m)	Detector	Limit (dBuV/m)	Over limit dB	Verdict
2310.000	-51.701	1.92	0	45.449	Peak	74	-28.551	PASS
2310.000	-62.233	1.92	0	34.917	AV	54	-19.083	PASS
2390.000	-46.301	1.92	0	50.849	Peak	74	-23.151	PASS
2390.000	-58.732	1.92	0	38.418	AV	54	-15.582	PASS
2483.500	-48.052	1.92	0	49.098	Peak	74	-24.902	PASS
2483.500	-59.752	1.92	0	37.398	AV	54	-16.602	PASS
2500.000	-50.211	1.92	0	46.939	Peak	74	-27.061	PASS
2500.000	-61.268	1.92	0	35.882	AV	54	-18.118	PASS

IEEE 802.11 n HT20								
Frequency (MHz)	Conducted Power (dBm)	Antenna Gain (dBi)	Ground Reflection Factor (dB)	Covert Radiated E Level At 3m (dBuV/m)	Detector	Limit (dBuV/m)	Over limit dB	Verdict
2310.000	-50.662	1.92	0	46.488	Peak	74	-27.512	PASS
2310.000	-62.207	1.92	0	34.943	AV	54	-19.057	PASS
2390.000	-42.327	1.92	0	54.823	Peak	74	-19.177	PASS
2390.000	-59.072	1.92	0	38.078	AV	54	-15.922	PASS
2483.500	-44.101	1.92	0	53.049	Peak	74	-20.951	PASS
2483.500	-58.152	1.92	0	38.998	AV	54	-15.002	PASS
2500.000	-49.763	1.92	0	47.387	Peak	74	-26.613	PASS
2500.000	-61.127	1.92	0	36.023	AV	54	-17.977	PASS

IEEE 802.11n HT40								
Frequency (MHz)	Conducted Power (dBm)	Antenna Gain (dBi)	Ground Reflection Factor (dB)	Covert Radiated E Level At 3m (dBuV/m)	Detector	Limit (dBuV/m)	Over limit dB	Verdict
2310.000	-51.239	1.92	0	45.911	Peak	74	-28.089	PASS
2310.000	-62.309	1.92	0	34.841	AV	54	-19.159	PASS
2390.000	-48.378	1.92	0	48.772	Peak	74	-25.228	PASS
2390.000	-59.143	1.92	0	38.007	AV	54	-15.993	PASS
2483.500	-47.302	1.92	0	49.848	Peak	74	-24.152	PASS
2483.500	-58.937	1.92	0	38.213	AV	54	-15.787	PASS
2500.000	-49.981	1.92	0	47.169	Peak	74	-26.831	PASS
2500.000	-50.923	1.92	0	46.227	AV	54	-7.773	PASS

For Antenna 2

IEEE 802.11b								
Frequency (MHz)	Conducted Power (dBm)	Antenna Gain (dBi)	Ground Reflection Factor (dB)	Covert Radiated E Level At 3m (dBuV/m)	Detector	Limit (dBuV/m)	Over limit dB	Verdict
2310.000	-49.527	1.92	0	47.623	Peak	74	-26.377	PASS
2310.000	-62.219	1.92	0	34.931	AV	54	-19.069	PASS
2390.000	-47.519	1.92	0	49.631	Peak	74	-24.369	PASS
2390.000	-59.878	1.92	0	37.272	AV	54	-16.728	PASS
2483.500	-47.359	1.92	0	49.791	Peak	74	-24.209	PASS
2483.500	-59.739	1.92	0	37.411	AV	54	-16.589	PASS
2500.000	-49.315	1.92	0	47.835	Peak	74	-26.165	PASS
2500.000	-61.209	1.92	0	35.941	AV	54	-18.059	PASS

IEEE 802.11g								
Frequency (MHz)	Conducted Power (dBm)	Antenna Gain (dBi)	Ground Reflection Factor (dB)	Covert Radiated E Level At 3m (dBuV/m)	Detector	Limit (dBuV/m)	Over limit dB	Verdict
2310.000	-50.714	1.92	0	46.436	Peak	74	-27.564	PASS
2310.000	-62.237	1.92	0	34.913	AV	54	-19.087	PASS
2390.000	-45.741	1.92	0	51.409	Peak	74	-22.591	PASS
2390.000	-59.479	1.92	0	37.671	AV	54	-16.329	PASS
2483.500	-46.881	1.92	0	50.269	Peak	74	-23.731	PASS
2483.500	-58.995	1.92	0	38.155	AV	54	-15.845	PASS
2500.000	-50.677	1.92	0	46.473	Peak	74	-27.527	PASS
2500.000	-61.242	1.92	0	35.908	AV	54	-18.092	PASS

IEEE 802.11 n HT20								
Frequency (MHz)	Conducted Power (dBm)	Antenna Gain (dBi)	Ground Reflection Factor (dB)	Covert Radiated E Level At 3m (dBuV/m)	Detector	Limit (dBuV/m)	Over limit dB	Verdict
2310.000	-50.462	1.92	0	46.688	Peak	74	-27.312	PASS
2310.000	-62.256	1.92	0	34.894	AV	54	-19.106	PASS
2390.000	-43.040	1.92	0	54.11	Peak	74	-19.89	PASS
2390.000	-58.299	1.92	0	38.851	AV	54	-15.149	PASS
2483.500	-47.168	1.92	0	49.982	Peak	74	-24.018	PASS
2483.500	-58.737	1.92	0	38.413	AV	54	-15.587	PASS
2500.000	-50.176	1.92	0	46.974	Peak	74	-27.026	PASS
2500.000	-61.202	1.92	0	35.948	AV	54	-18.052	PASS

IEEE 802.11 n HT40								
Frequency (MHz)	Conducted Power (dBm)	Antenna Gain (dBi)	Ground Reflection Factor (dB)	Covert Radiated E Level At 3m (dBuV/m)	Detector	Limit (dBuV/m)	Over limit dB	Verdict
2310.000	-51.753	1.92	0	45.397	Peak	74	-28.603	PASS
2310.000	-62.318	1.92	0	34.832	AV	54	-19.168	PASS
2390.000	-49.393	1.92	0	47.757	Peak	74	-26.243	PASS
2390.000	-62.2	1.92	0	34.95	AV	54	-19.05	PASS
2483.500	-46.393	1.92	0	50.757	Peak	74	-23.243	PASS
2483.500	-57.357	1.92	0	39.793	AV	54	-14.207	PASS
2500.000	-48.735	1.92	0	48.415	Peak	74	-25.585	PASS
2500.000	-60.518	1.92	0	36.632	AV	54	-17.368	PASS

For Combined Antenna 1, Antenna 2

IEEE 802.11n HT20										
Frequency (MHz)	Conducted Power (dBm)			Directional Gain (dB)	Ground Reflection Factor (dB)	Covert Radiated E Level At 3m (dBuV/m)	Detector	Limit (dBuV/m)	Over limit dB	Verdict
	Antenna 1	Antenna 2	Sum							
2310.000*	-50.662	-50.462	-47.551	4.93	0	52.609	Peak	74	-21.391	PASS
2310.000	-62.207	-62.256	-59.221	4.93	0	40.939	AV	54	-13.061	PASS
2390.000	-42.327	-43.04	-39.659	4.93	0	60.501	Peak	74	-13.499	PASS
2390.000	-59.072	-58.299	-55.658	4.93	0	44.502	AV	54	-9.498	PASS
2483.500*	-44.101	-47.168	-42.359	4.93	0	57.801	Peak	74	-16.199	PASS
2483.500	-58.152	-58.737	-55.424	4.93	0	44.736	AV	54	-9.264	PASS
2500.000	-49.763	-50.176	-46.954	4.93	0	53.206	Peak	74	-20.794	PASS
2500.000	-61.127	-61.202	-58.154	4.93	0	42.006	AV	54	-11.994	PASS

IEEE 802.11n HT40										
Frequency (MHz)	Conducted Power (dBm)			Directional Gain (dB)	Ground Reflection Factor (dB)	Covert Radiated E Level At 3m (dBuV/m)	Detector	Limit (dBuV/m)	Over limit dB	Verdict
	Antenna 1	Antenna 2	Sum							
2310.000*	-51.239	-51.753	-48.478	4.93	0	51.682	Peak	74	-22.318	PASS
2310.000	-62.309	-62.318	-59.303	4.93	0	40.857	AV	54	-13.143	PASS
2390.000	-48.378	-49.393	-45.846	4.93	0	54.314	Peak	74	-19.686	PASS
2390.000	-59.143	-62.2	-57.398	4.93	0	42.762	AV	54	-11.238	PASS
2483.500*	-47.302	-46.393	-43.813	4.93	0	56.347	Peak	74	-17.653	PASS
2483.500	-58.937	-57.357	-55.065	4.93	0	45.095	AV	54	-8.905	PASS
2500.000	-49.981	-48.735	-46.303	4.93	0	53.857	Peak	74	-20.143	PASS
2500.000	-50.923	-60.518	-50.471	4.93	0	49.689	AV	54	-4.311	PASS

Remark:

1. Measured Band-edge measurements for radiated emissions at difference data rate for each mode and recorded worst case for each mode.
2. Test results including cable loss;
3. Worst case data at 1Mbps at IEEE 802.11b; 6Mbps at IEEE 802.11g; 6.5Mbps at IEEE 802.11n HT20; 13.5Mbps at IEEE 802.11n HT40;
4. “---“means that the fundamental frequency not for 15.209 limits requirement.
5. No need measure Average values if Peak values meets Average limits;
6. * means maximum values of frequency band 2310 – 2390 MHz, 2483.5 – 2500 MHz;
7. For MIMO with CCD technology device, The Directional Gain= Gain of individual transmit antennas (dBi) + Array gain;
Array gain = $10 \log(N_{ant})$, where N_{ant} is the number of transmit antennas.
8. $*4.93=1.92+10*\log(2)$.
9. Covert Radiated E Level At 3m = Conducted average power + Directional Gain + $104.77-20*\log(3)$;
10. Please refer to following plots;

Band-edge measurements for radiated emissions

Antenna 1

IEEE 802.11b

IEEE 802.11g

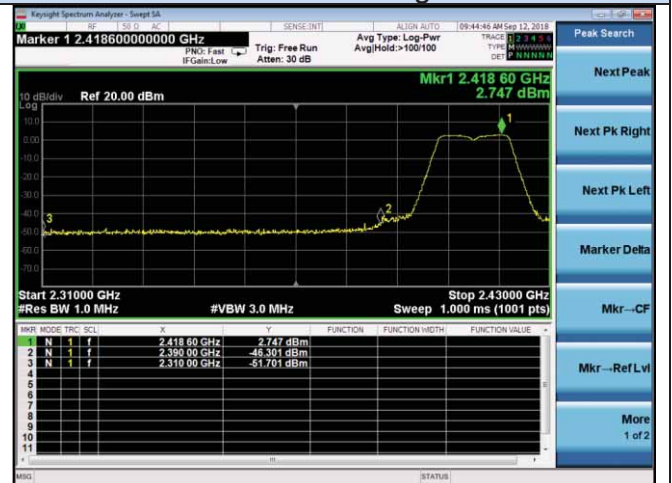
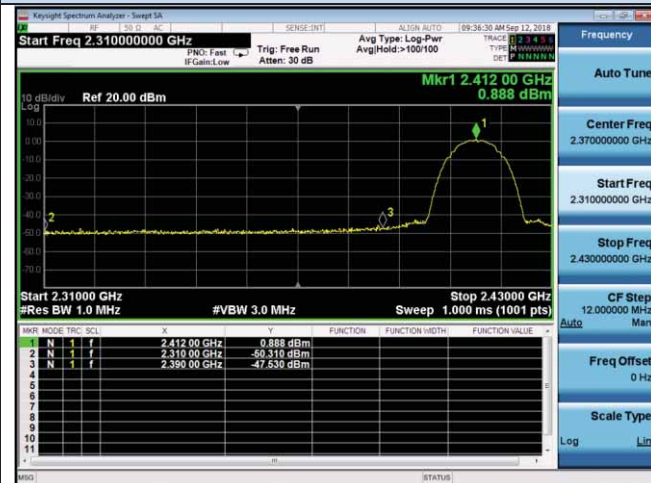

Channel 1 / 2412 MHz – Peak

Channel 1 / 2412 MHz – Peak



Channel 1 / 2412 MHz – Average

Channel 1 / 2412 MHz – Average



Channel 11 / 2462 MHz – Peak

Channel 11 / 2462 MHz – Peak

Band-edge measurements for radiated emissions

Antenna 1

IEEE 802.11b

IEEE 802.11g



Channel 11 / 2462 MHz – Average
IEEE 802.11n HT20

Channel 11 / 2462 MHz – Average
IEEE 802.11n HT40

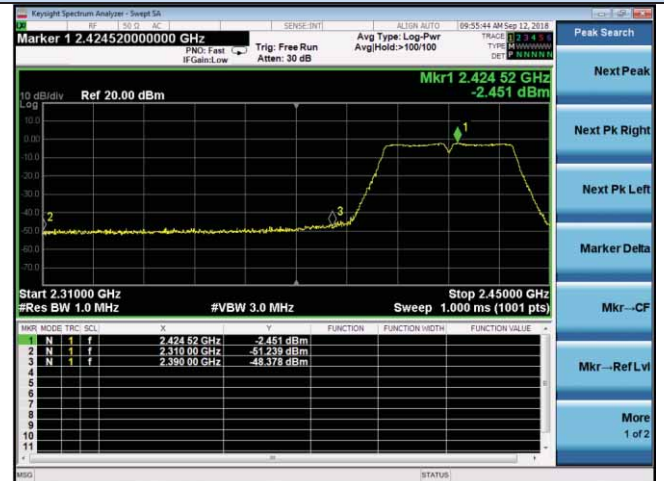
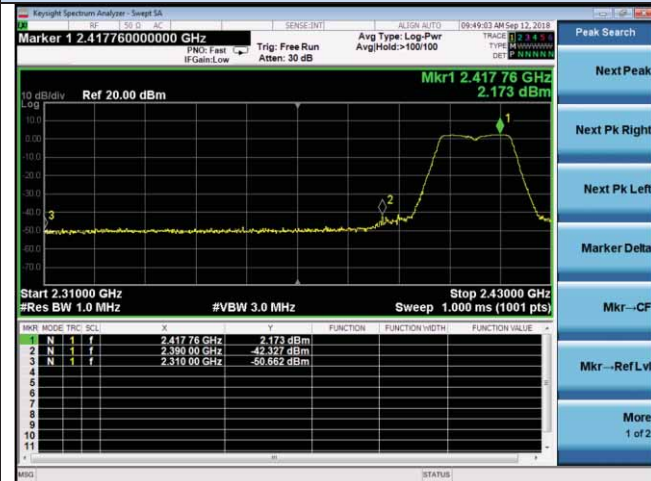

Channel 1 / 2412 MHz – Peak

Channel 3 / 2422 MHz – Peak

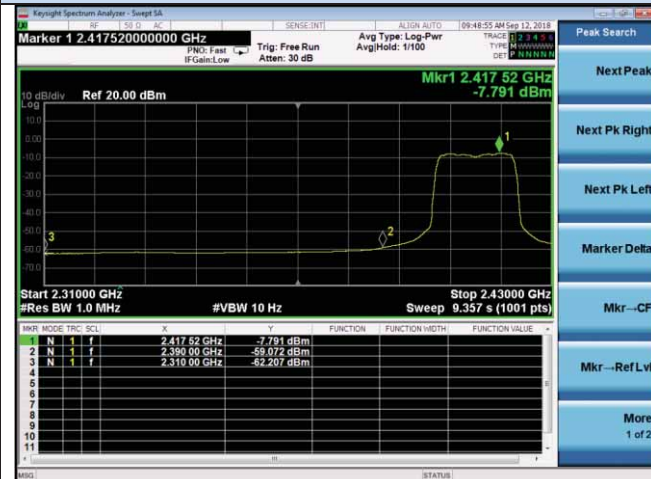

Channel 1 / 2412 MHz – Average

Channel 3 / 2422 MHz – Average

Band-edge measurements for radiated emissions

Antenna 1

IEEE 802.11n HT20

IEEE 802.11n HT40



Channel 11 / 2462 MHz – Peak

Channel 9 / 2452 MHz – Peak

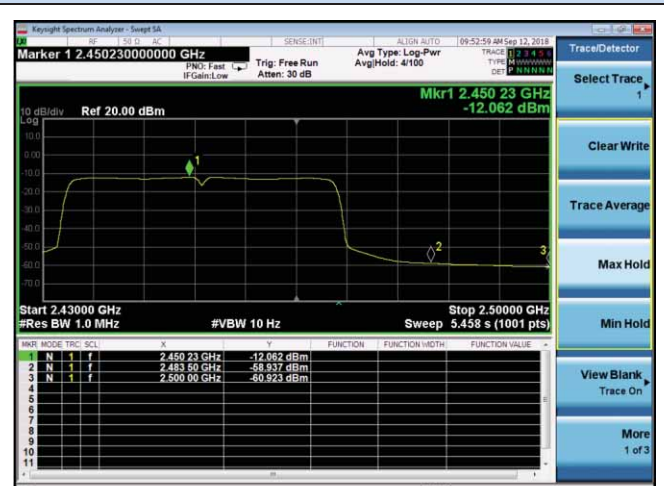
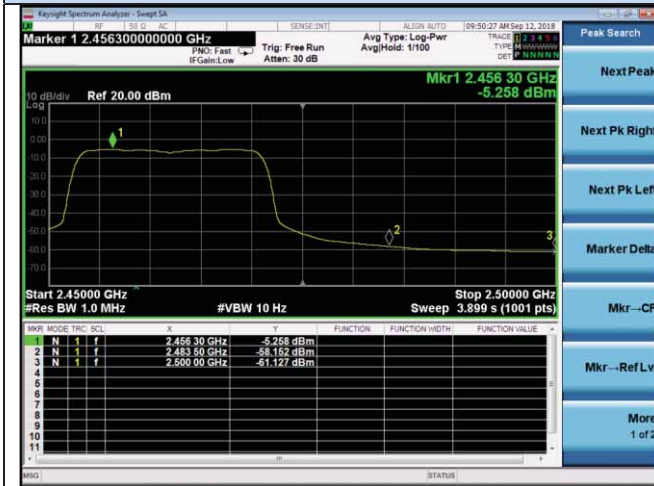

Channel 11 / 2462 MHz – Average

Channel 9 / 2452 MHz – Average

Band-edge measurements for radiated emissions

Antenna 2

IEEE 802.11b

IEEE 802.11g

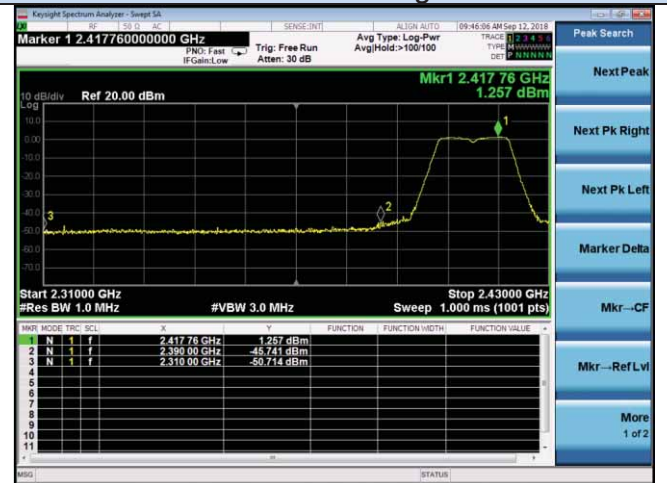
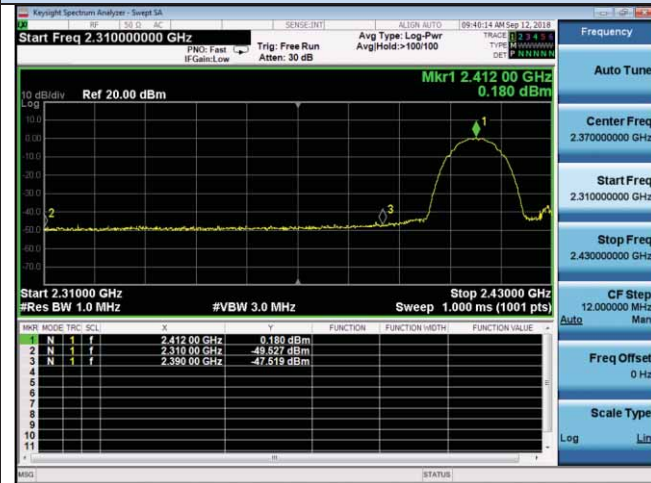

Channel 1 / 2412 MHz – Peak

Channel 1 / 2412 MHz – Peak

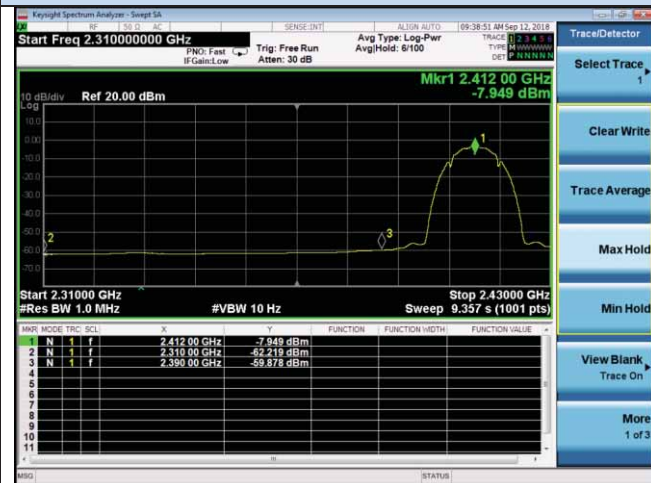

Channel 1 / 2412 MHz – Average

Channel 1 / 2412 MHz – Average



Channel 11 / 2462 MHz – Peak

Channel 11 / 2462 MHz – Peak

Band-edge measurements for radiated emissions

Antenna 2

IEEE 802.11b

IEEE 802.11g

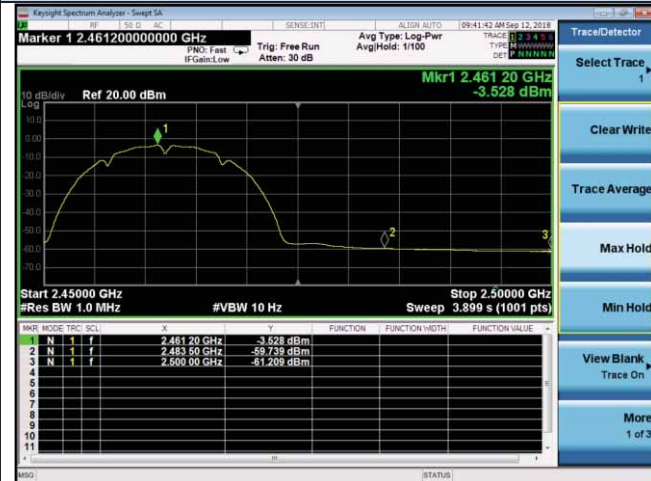

Channel 11 / 2462 MHz – Average
IEEE 802.11n HT20

Channel 11 / 2462 MHz – Average
IEEE 802.11n HT40

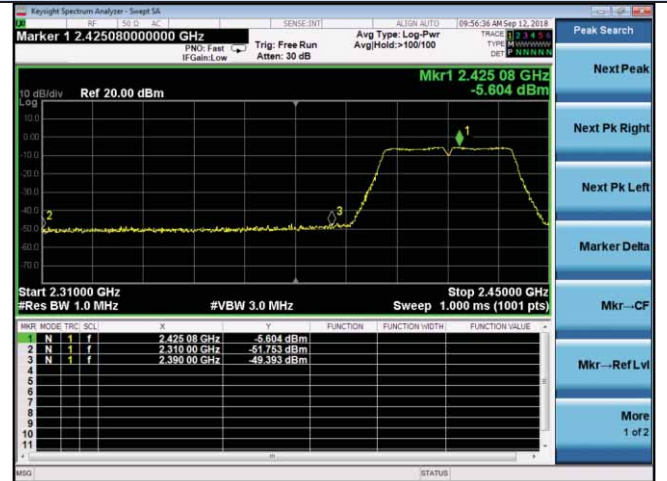
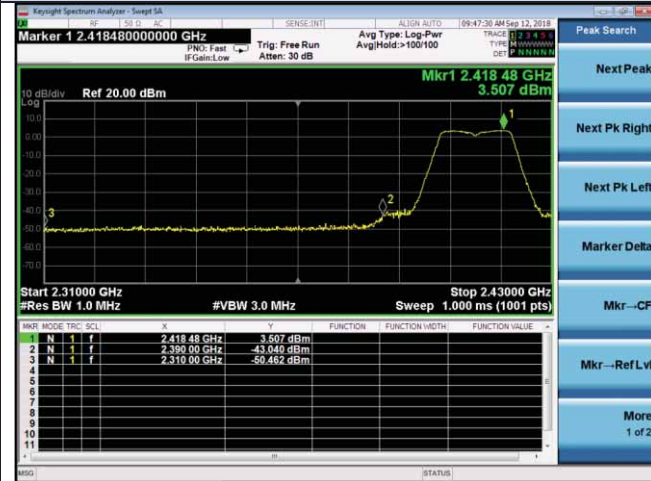

Channel 1 / 2412 MHz – Peak

Channel 3 / 2422 MHz – Peak

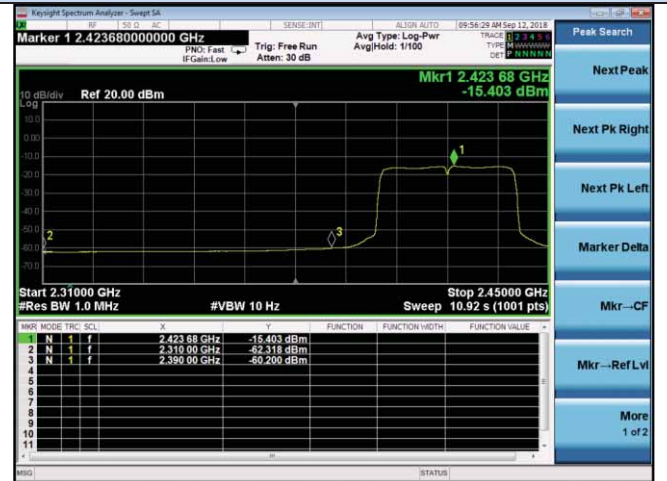
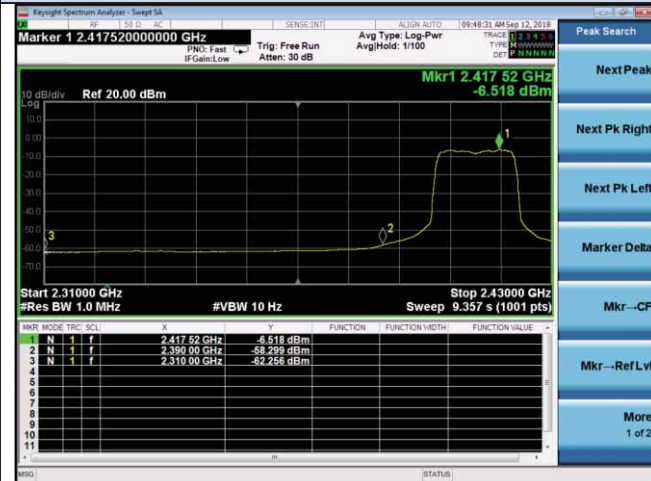

Channel 1 / 2412 MHz – Average

Channel 3 / 2422 MHz – Average

Band-edge measurements for radiated emissions

Antenna 2

IEEE 802.11n HT20

IEEE 802.11n HT40

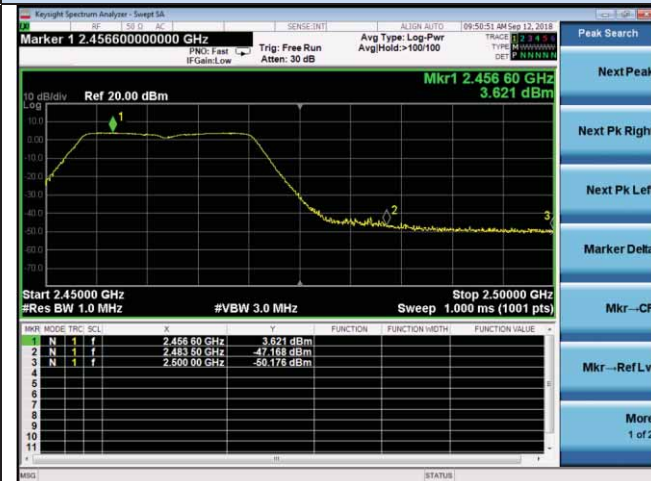

Channel 11 / 2462 MHz – Peak

Channel 9 / 2452 MHz – Peak

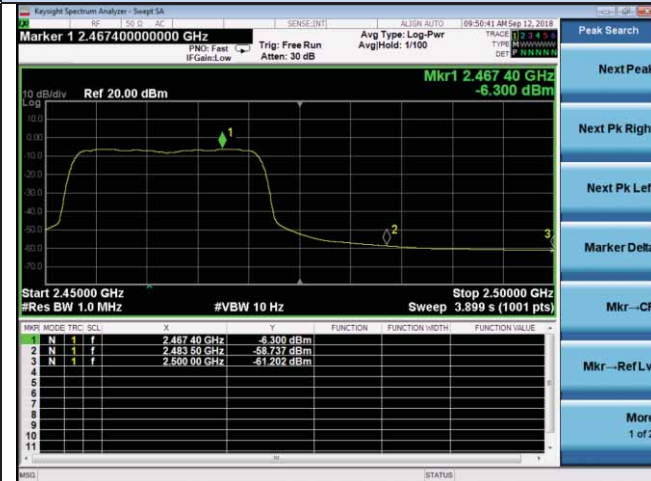



Channel 11 / 2462 MHz – Average

Channel 9 / 2452 MHz – Average

4.6.2 For Conducted Bandedge Measurement

Antenna 1

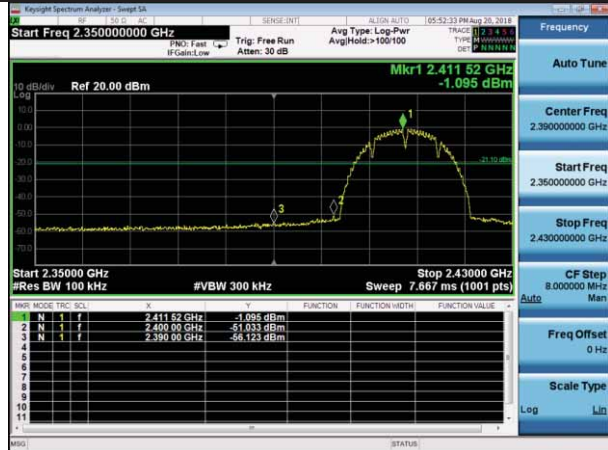
802.11b			
Frequency (MHz)	Delta Peak to Band emission (dBc)	Limit (dBc)	Verdict
2400.00	-49.938	-20	PASS
2483.50	-56.495	-20	PASS

	
2412	2462

802.11g			
Frequency (MHz)	Delta Peak to Band emission (dBc)	Limit (dBc)	Verdict
2400.00	-36.03	-20	PASS
2483.05	-52.138	-20	PASS

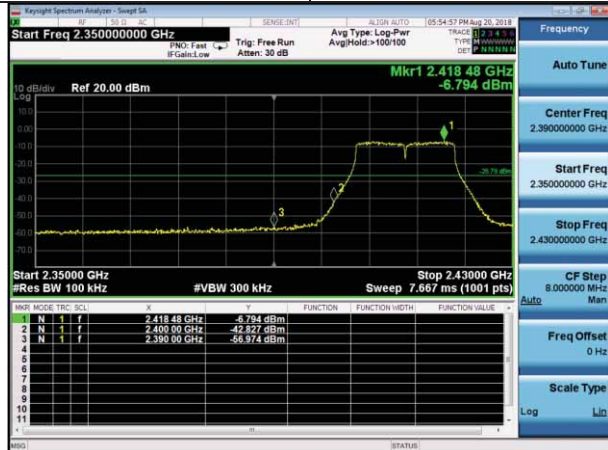
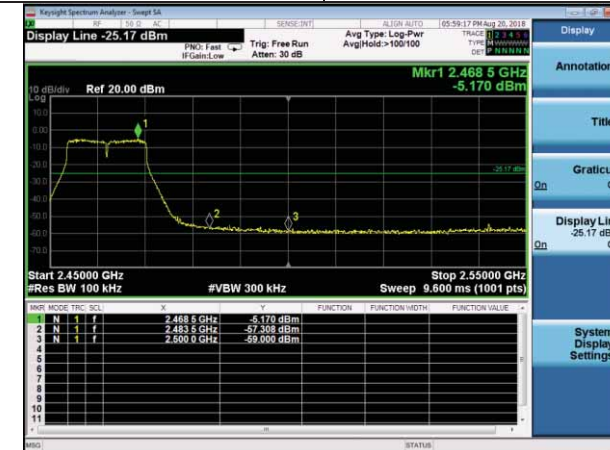
	
2412	2462