



TEST REPORT

Report Reference No...... : **TRE1710014101** **R/C.....: 94076**

FCC ID..... : **2AL6K-LW084-B**

Applicant's name..... : **Shenzhen Bilian Electronic Co.,Ltd.**

Address..... : Building B1,Zhongxing Industrial Zone,Juling,Jutang Community,
Guanlan street,Longhua New District,Shenzhen,Guangdong,
P.R.China

Manufacturer..... : Dingnan Fulong Technologies Co.,Ltd.

Address..... : Yingtang Electronic,Liangfu Industrial Zone,Taihu road branch
westside,Lishi,Dingnan,Ganzhou,jiangxi,P.R.China

Test item description : **IEEE 802.11b/g/n (1T1R) MINI PCI-E Module**

Trade Mark : -

Model/Type reference..... : BL-LW084-B

Listed Model(s) : -

Standard : **FCC CFR Title 47 Part 15 Subpart C Section 15.247**

Date of receipt of test sample..... : Oct.27,2017

Date of testing..... : Oct.28,2017-Nov.20,2017

Date of issue..... : Nov.21,2017

Result..... : **PASS**

Compiled by
(position+printedname+signature)....: File administrators Candy Liu *Candy Liu*

Supervised by
(position+printedname+signature).....: Project Engineer John Qiao *John Qiao*

Approved by
(position+printedname+signature)....: RF Manager Hans Hu *Hans Hu*

Testing Laboratory Name : **Shenzhen Huatongwei International Inspection Co., Ltd.**

Address..... : 1/F, Bldg 3, Hongfa Hi-tech Industrial Park, Genyu Road,
Tianliao, Gongming, Shenzhen, China

Shenzhen Huatongwei International Inspection Co., Ltd. All rights reserved.

This publication may be reproduced in whole or in part for non-commercial purposes as long as the Shenzhen Huatongwei International Inspection Co., Ltd. is acknowledged as copyright owner and source of the material. Shenzhen Huatongwei International Inspection Co., Ltd. takes no responsibility for and will not assume liability for damages resulting from the reader's interpretation of the reproduced material due to its placement and context.

The test report merely correspond to the test sample.

Contents

1.	<u>TEST STANDARDS AND REPORT VERSION</u>	3
1.1.	Test Standards	3
1.2.	Report version	3
2.	<u>TEST DESCRIPTION</u>	4
3.	<u>SUMMARY</u>	5
3.1.	Client Information	5
3.2.	Product Description	5
3.3.	Operation state	6
3.4.	EUT configuration	6
3.5.	Modifications	6
4.	<u>TEST ENVIRONMENT</u>	7
4.1.	Address of the test laboratory	7
4.2.	Test Facility	7
4.3.	Environmental conditions	8
4.4.	Statement of the measurement uncertainty	8
4.5.	Equipments Used during the Test	9
6.	<u>TEST CONDITIONS AND RESULTS</u>	11
6.1.	Antenna requirement	11
6.2.	Conducted Emissions (AC Main)	12
6.3.	Conducted Peak Output Power	17
6.4.	Power Spectral Density	18
6.5.	6dB bandwidth	24
6.6.	Restricted band	30
6.7.	Band edge and Spurious Emissions (conducted)	34
6.8.	Spurious Emissions (radiated)	51
7.	<u>TEST SETUP PHOTOS</u>	58
8.	<u>EXTERANAL AND INTERNAL PHOTOS</u>	60

1. TEST STANDARDS AND REPORT VERSION

1.1. Test Standards

The tests were performed according to following standards:

[FCC Rules Part 15.247](#): Frequency Hopping, Direct Spread Spectrum and Hybrid Systems that are in operation within the bands of 902-928 MHz, 2400-2483.5 MHz, and 5725-5850 MHz.

[ANSI C63.10:2013](#): American National Standard for Testing Unlicensed Wireless Devices

[KDB 558074 D01 DTS Meas Guidance v04](#): Guidance for Performing Compliance Measurements on Digital Transmission Systems (DTS) Operating under §15.247

1.2. Report version

Version No.	Date of issue	Description
00	Nov.21,2017	Original

2. TEST DESCRIPTION

Test Item	FCC Rule	Result	Test Engineer
Antenna requirement	15.203/15.247(c)	Pass	William Wang
Line Conducted Emissions (AC Main)	15.207	Pass	William Wang
Conducted Peak Output Power	15.247(b)(3)	Pass	Baozhu Hu
Power Spectral Density	15.247(e)	Pass	Baozhu Hu
6dB Bandwidth	15.247(a)(2)	Pass	Baozhu Hu
Restricted band	15.247(d)/15.205	Pass	Baozhu Hu
Spurious Emissions	15.247(d)/15.209	Pass	Baozhu Hu

Note: The measurement uncertainty is not included in the test result.

3. SUMMARY

3.1. Client Information

Applicant:	Shenzhen Bilian Electronic Co.,Ltd.
Address:	Building B1,Zhongxing Industrial Zone,Juling,Jutang Community, Guanlan street,Longhua New District,Shenzhen,Guangdong,P.R.China
Manufacturer:	Dingnan Fulong Technologies Co.,Ltd.
Address:	Yingtang Electronic,Liangfu Industrial Zone,Taihu road branch westside, Lishi,Dingnan,Ganzhou,jiangxi,P.R.China

3.2. Product Description

Name of EUT:	IEEE 802.11b/g/n (1T1R) MINI PCI-E Module
Trade Mark:	-
Model No.:	BL-LW084-B
Listed Model(s):	-
Power supply:	DC 3.3V 35mA
Adapter information:	-
Hardware version:	V1.0
Software version:	V1.0
WIFI	
Supported type:	802.11b/802.11g/802.11n(HT20)/802.11n(HT40)
Modulation:	DSSS for 802.11b OFDM for 802.11g/802.11n(HT20)/802.11n(HT40)
Operation frequency:	2412MHz~2462MHz for 802.11b/802.11g/802.11n(HT20) 2422MHz~2452MHz for 802.11n(HT40)
Channel number:	11 for 802.11b/802.11g/802.11n(HT20) 7 for 802.11n(HT40)
Channel separation:	5MHz
Antenna type:	Connect to the external antenna through the IPEX connector
Antenna gain:	1.5 dBi

3.3. Operation state

➤ Test frequency list

According to section 15.31(m), regards to the operating frequency range over 10 MHz, must select three channel which were tested. the Lowest frequency, the middle frequency, and the highest frequency of channel were selected to perform the test, please see the above gray bottom.

802.11b/g/n(HT20)		802.11n(HT40)	
Channel	Frequency (MHz)	Channel	Frequency (MHz)
01	2412	01	-
02	2417	02	-
03	2422	03	2422
04	2427	04	2427
05	2432	05	2432
06	2437	06	2437
07	2442	07	2442
08	2447	08	2447
09	2452	09	2452
10	2457	10	-
11	2462	11	-

➤ Test mode

For RF test items
The engineering test program was provided and enabled to make EUT continuous transmit (duty cycle>98%).
For AC power line conducted emissions:
The EUT was set to connect with the WLAN AP under large package sizes transmission.
For Radiated suprious emissions test item:
The engineering test program was provided and enabled to make EUT continuous transmit(duty cycle>98%). The EUT in each of three orthogonal axis emissions had been tested ,but only the worst case (X axis) data Recorded in the report.

3.4. EUT configuration

The following peripheral devices and interface cables were connected during the measurement:

- - supplied by the manufacturer
- - supplied by the lab

○	Antenna	Manufacturer:	Guangxie electronics co. LTD
		Model No.:	RG 1.13
○	Display unit	Manufacturer:	HP
		Model No.:	22KD
○	Main engine	Manufacturer:	HP
		Model No.:	303B
○	keyboard	Manufacturer:	HP
		Model No.:	PR1101U
○	The mouse	Manufacturer:	HP
		Model No.:	SM-2022

3.5. Modifications

No modifications were implemented to meet testing criteria.

4. TEST ENVIRONMENT

4.1. Address of the test laboratory

Laboratory: Shenzhen Huatongwei International Inspection Co., Ltd.

Address: 1/F, Bldg 3, Hongfa Hi-tech Industrial Park, Genyu Road, Tianliao, Gongming, Shenzhen, China

4.2. Test Facility

CNAS-Lab Code: L1225

Shenzhen Huatongwei International Inspection Co., Ltd. has been assessed and proved to be in compliance with CNAS-CL01 Accreditation Criteria for Testing and Calibration Laboratories (identical to ISO/IEC17025: 2005 General Requirements) for the Competence of Testing and Calibration Laboratories.

A2LA-Lab Cert. No.: 3902.01

Shenzhen Huatongwei International Inspection Co., Ltd. EMC Laboratory has been accredited by A2LA for technical competence in the field of electrical testing, and proved to be in compliance with ISO/IEC 17025: 2005 General Requirements for the Competence of Testing and Calibration Laboratories and any additional program requirements in the identified field of testing.

FCC-Registration No.: 762235

Shenzhen Huatongwei International Inspection Co., Ltd. EMC Laboratory has been registered and fully described in a report filed with the FCC (Federal Communications Commission). The acceptance letter from the FCC is maintained in our files.

IC-Registration No.:5377B-1

Two 3m Alternate Test Site of Shenzhen Huatongwei International Inspection Co., Ltd. has been registered by Certification and Engineering Bureau of Industry Canada for the performance of radiated measurements with Registration No.: 5377B-1.

ACA

Shenzhen Huatongwei International Inspection Co., Ltd. EMC Laboratory can also perform testing for the Australian C-Tick mark as a result of our A2LA accreditation.

4.3. Environmental conditions

During the measurement the environmental conditions were within the listed ranges:

Temperature:	15~35°C
Relative Humidity:	30~60 %
Air Pressure:	950~1050mba

4.4. Statement of the measurement uncertainty

The data and results referenced in this document are true and accurate. The reader is cautioned that there may be errors in calibration limits of the equipment and facilities. The measurement uncertainty was calculated for all measurements listed in this test report according to TR-100028-01 "Electromagnetic compatibility and Radio spectrum Matters (ERM); Uncertainties in the measurement of mobile radio equipment characteristics; Part 1" and TR-100028-02 "Electromagnetic compatibility and Radio spectrum Matters (ERM); Uncertainties in the measurement of mobile radio equipment characteristics; Part 2" and is documented in the Shenzhen Huatongwei International Inspection Co., Ltd. quality system according to ISO/IEC 17025. Furthermore, component and process variability of devices similar to that tested may result in additional deviation. The manufacturer has the sole responsibility of continued compliance of the device.

Here after the best measurement capability for Shenzhen Huatongwei International Inspection Co., Ltd. is reported:

Test Items	Measurement Uncertainty	Notes
Transmitter power conducted	0.57 dB	(1)
Transmitter power Radiated	2.20 dB	(1)
Conducted spurious emissions 9kHz~40GHz	1.60 dB	(1)
Radiated spurious emissions 9kHz~40GHz	2.20 dB	(1)
Conducted Emissions 9kHz~30MHz	3.39 dB	(1)
Radiated Emissions 30~1000MHz	4.24 dB	(1)
Radiated Emissions 1~18GHz	5.16 dB	(1)
Radiated Emissions 18~40GHz	5.54 dB	(1)

(1) This uncertainty represents an expanded uncertainty expressed at approximately the 95% confidence level using a coverage factor of $k=1.96$.

4.5. Equipments Used during the Test

5. Conducted Emissions						
Item	Test Equipment	Manufacturer	Model No.	Serial No.	Last Cal. (mm-dd-yy)	Next Cal. (mm-dd-yy)
1	EMI Test Receiver	R&S	ESCI	101247	11/11/2017	11/10/2018
2	Artificial Mains	SCHWARZBECK	NNLK 8121	573	11/11/2017	11/10/2018
3	Pulse Limiter	R&S	ESH3-Z2	101488	11/11/2017	11/10/2018
4	Test Software	R&S	ES-K1	N/A	N/A	N/A
5	RF Connection Cable	HUBER+SUHNER	EF400	N/A	11/21/2017	11/20/2018
6	Single Balanced Telecom Pair ISN	FCC	FCC-TLISN-T2-02	20371	11/11/2017	11/10/2018
7	Two Balanced Telecom Pairs ISN	FCC	FCC-TLISN-T4-02	20373	11/11/2017	11/10/2018
8	Four Balanced Telecom Pairs ISN	FCC	FCC-TLISN-T8-02	20375	11/11/2017	11/10/2018
9	V-Network	R&S	ESH3-Z6	100211	11/11/2017	11/10/2018
10	V-Network	R&S	ESH3-Z6	100210	11/11/2017	11/10/2018
11	2-Line V-Network	R&S	ESH3-Z5	100049	11/11/2017	11/10/2018

Radiated Emissions						
Item	Test Equipment	Manufacturer	Model No.	Serial No.	Last Cal. (mm-dd-yy)	Next Cal. (mm-dd-yy)
1	EMI Test Receiver	R&S	ESCI	101247	11/11/2017	11/10/2018
2	Loop Antenna	R&S	HFH2-Z2	100020	11/20/2017	11/19/2018
3	Ultra-Broadband Antenna	SCHWARZBECK	VULB9163	538	4/5/2017	4/4/2018
4	Horn Antenna	SCHWARZBECK	9120D	1011	3/27/2017	3/26/2018
5	Horn Antenna	SCHWARZBECK	BBHA9170	25841	3/27/2017	3/26/2018
6	Preamplifier	SCHWARZBECK	BBV 9743	9743-0022	10/18/2017	10/17/2018
7	Broadband Preamplifier	SCHWARZBECK	BBV 9718	9718-248	10/18/2017	10/17/2018
8	High pass filter	Compliance Direction systems	BSU-6	34202	11/11/2017	11/10/2018
9	Turntable	MATURO	TT2.0	/	N/A	N/A
10	Antenna Mast	MATURO	TAM-4.0-P	/	N/A	N/A
11	EMI Test Software	R&S	ESK1	N/A	N/A	N/A
12	EMI Test Software	Audix	E3	N/A	N/A	N/A

13	RF Connection Cable	HUBER+SUHNER	3m 3GHz S	N/A	11/21/2017	11/20/2018
14	RF Connection Cable	HUBER+SUHNER	3m 3GHz RG	N/A	11/21/2017	11/20/2018
15	RF Connection Cable	HUBER+SUHNER	6m 18GHz S	N/A	11/21/2017	11/20/2018

RF Conducted Method						
Item	Test Equipment	Manufacturer	Model No.	Serial No.	Last Cal. (mm-dd-yy)	Next Cal. (mm-dd-yy)
1	Spectrum Analyzer	R&S	FSV40	100048	11/11/2017	11/10/2018
2	OSP	R&S	OSP120	101317	N/A	N/A
3	OSP	R&S	OSP-B157	100890	N/A	N/A
4	Signal generator	R&S	SMB100A	177956	11/11/2017	11/10/2018
5	Vector signal generator	R&S	SMBV100A	260790	7/20/2017	7/19/2018
6	EXA Signal Analyzer	Agilent	N9020A	184247	9/22/2017	9/21/2018
7	Power Meter	Agilent	U2021XA	178231	9/22/2017	9/21/2018
8	DAQ Device	Agilent	U2531A	132812	9/22/2017	9/21/2018

The Cal.Interval was one year.

6. TEST CONDITIONS AND RESULTS

6.1. Antenna requirement

REQUIREMENT:

FCC CFR Title 47 Part 15 Subpart C Section 15.203:

An intentional radiator shall be designed to ensure that no antenna other than that furnished by the responsible party shall be used with the device. The use of a permanently attached antenna or of an antenna that uses a unique coupling to the intentional radiator, the manufacturer may design the unit so that a broken antenna can be replaced by the user, but the use of a standard antenna jack or electrical connector is prohibited.

FCC CFR Title 47 Part 15 Subpart C Section 15.247(c) (1)(i):

(i) Systems operating in the 2400~2483.5 MHz band that is used exclusively for fixed. Point-to-point operations may employ transmitting antennas with directional gain greater than 6 dBi provided the maximum conducted output power of the intentional radiator is reduced by 1 dB for every 3 dB that the directional gain of the antenna exceeds 6 dBi.

TEST RESULTS

Passed Not Applicable

The directional gain of the antenna less than 6 dBi, please refer to the below antenna photo.

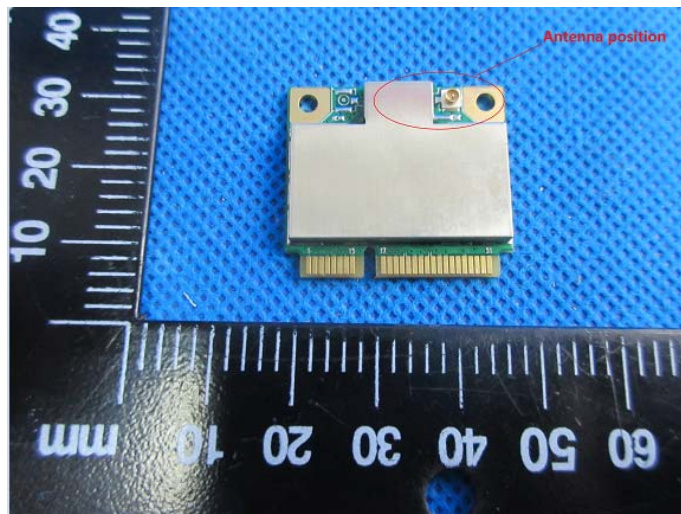

6.2. Conducted Emissions (AC Main)

LIMIT

FCC CFR Title 47 Part 15 Subpart C Section 15.207:

Frequency range (MHz)	Limit (dBuV)	
	Quasi-peak	Average
0.15-0.5	66 to 56*	56 to 46*
0.5-5	56	46
5-30	60	50

* Decreases with the logarithm of the frequency.

TEST CONFIGURATION

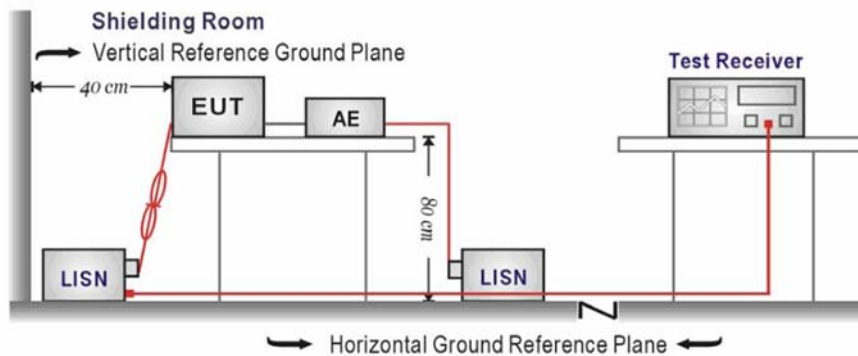

TEST PROCEDURE

1. The EUT was setup according to ANSI C63.10:2013 requirements.
2. The EUT was placed on a platform of nominal size, 1 m by 1.5 m, raised 80 cm above the conducting ground plane. The vertical conducting plane was located 40 cm to the rear of the EUT. All other surfaces of EUT were at least 80 cm from any other grounded conducting surface.
3. The EUT and simulators are connected to the main power through a line impedances stabilization network (LISN). The LISN provides a 50 ohm /50uH coupling impedance for the measuring equipment.
4. The peripheral devices are also connected to the main power through a LISN. (Please refer to the block diagram of the test setup and photographs)
5. Each current-carrying conductor of the EUT power cord, except the ground (safety) conductor, was individually connected through a LISN to the input power source.
6. The excess length of the power cord between the EUT and the LISN receptacle were folded back and forth at the center of the lead to form a bundle not exceeding 40 cm in length.
7. Conducted Emissions were investigated over the frequency range from 0.15MHz to 30MHz using a receiver bandwidth of 9 kHz.
8. During the above scans, the emissions were maximized by cable manipulation.

TEST MODE:

Please refer to the clause 3.3

TEST RESULTS

Passed Not Applicable

Note:

- 1) Transd=Cable lose+ Pulse Limiter Factor + Artificial Mains Factor
- 2) Margin= Limit -Level

Test Voltage@ 120V

Test Line:

L

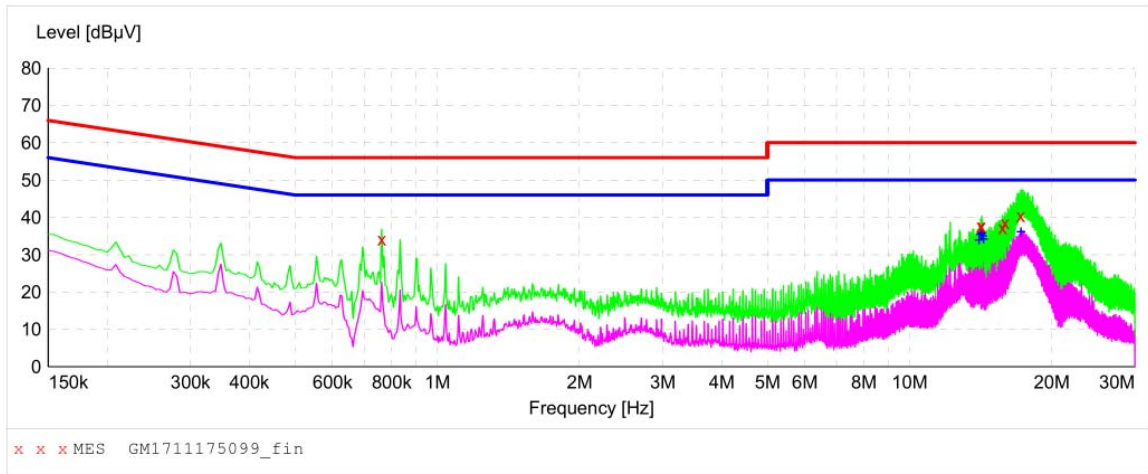

Frequency MHz	Level dBµV	Transd dB	Limit dBµV	Margin dB	Detector	Line	PE
0.762000	34.10	10.2	56	21.9	QP	L1	GND
14.149500	37.70	10.5	60	22.3	QP	L1	GND
14.212500	37.70	10.5	60	22.3	QP	L1	GND
15.733500	37.20	10.5	60	22.8	QP	L1	GND
15.940500	38.60	10.5	60	21.4	QP	L1	GND
17.196000	40.40	10.5	60	19.6	QP	L1	GND
Frequency MHz	Level dBµV	Transd dB	Limit dBµV	Margin dB	Detector	Line	PE
14.028000	33.90	10.5	50	16.1	AV	L1	GND
14.149500	35.40	10.5	50	14.6	AV	L1	GND
14.212500	35.70	10.5	50	14.3	AV	L1	GND
14.271000	35.00	10.5	50	15.0	AV	L1	GND
14.334000	34.10	10.5	50	15.9	AV	L1	GND
17.187000	36.10	10.5	50	13.9	AV	L1	GND

Test Line:

N

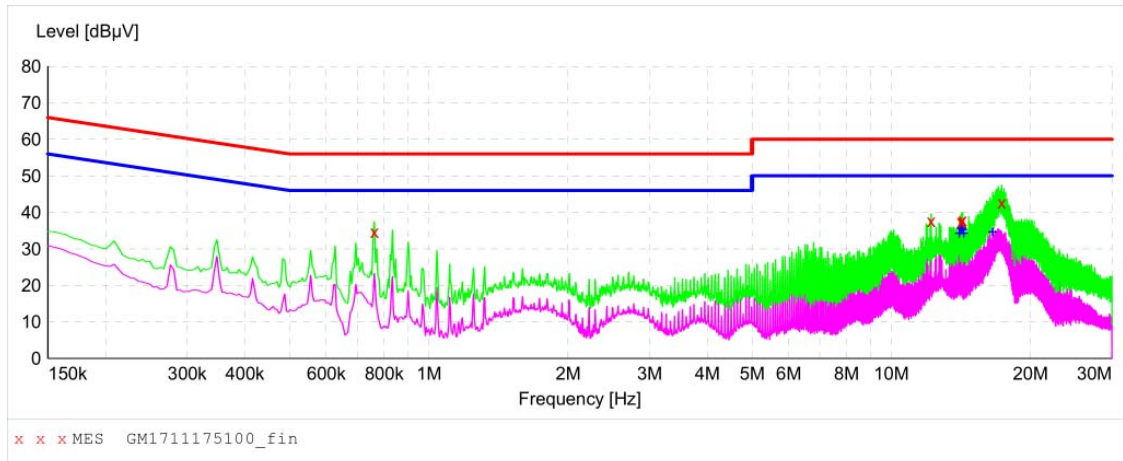

Frequency MHz	Level dBµV	Transd dB	Limit dBµV	Margin dB	Detector	Line	PE
0.762000	34.70	10.2	56	21.3	QP	N	GND
12.196500	37.70	10.5	60	22.3	QP	N	GND
14.149500	37.40	10.5	60	22.6	QP	N	GND
14.212500	37.70	10.5	60	22.3	QP	N	GND
14.271000	38.00	10.5	60	22.0	QP	N	GND
17.326500	42.70	10.5	60	17.3	QP	N	GND

Frequency MHz	Level dBµV	Transd dB	Limit dBµV	Margin dB	Detector	Line	PE
14.028000	34.20	10.5	50	15.8	AV	N	GND
14.149500	35.60	10.5	50	14.4	AV	N	GND
14.212500	35.80	10.5	50	14.2	AV	N	GND
14.271000	35.30	10.5	50	14.7	AV	N	GND
14.334000	34.20	10.5	50	15.8	AV	N	GND
16.561500	34.60	10.5	50	15.4	AV	N	GND

Test Voltage@ 240V

Test Line:

L

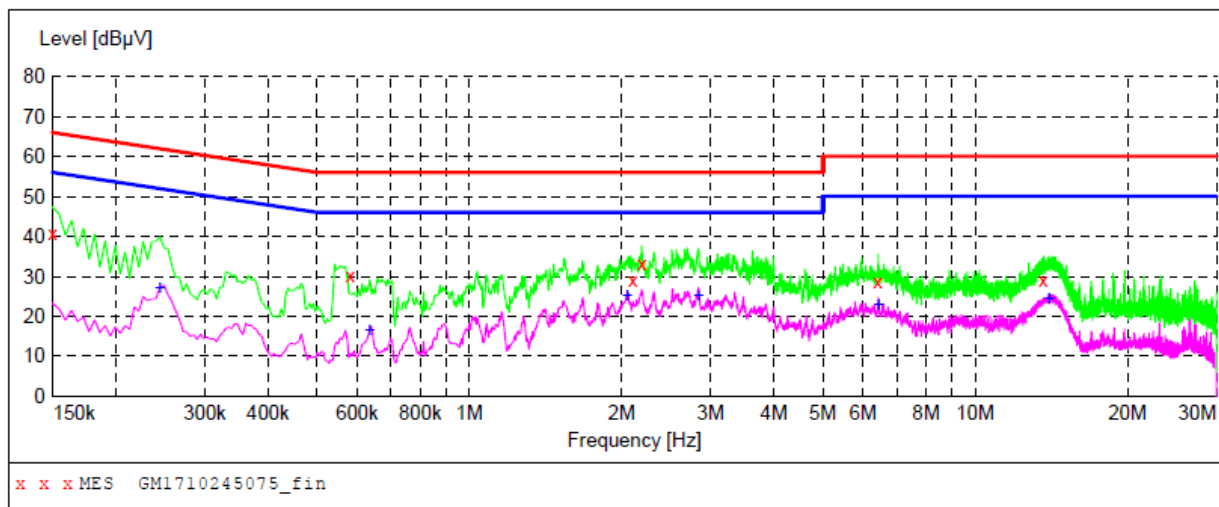

Frequency MHz	Level dBµV	Transd dB	Limit dBµV	Margin dB	Detector	Line	PE
0.150000	40.80	10.4	66	25.2	QP	L1	GND
0.582000	30.30	10.2	56	25.7	QP	L1	GND
2.107500	29.00	10.2	56	27.0	QP	L1	GND
2.193000	33.20	10.2	56	22.8	QP	L1	GND
6.423000	28.60	10.3	60	31.4	QP	L1	GND
13.645500	29.00	10.5	60	31.0	QP	L1	GND

Frequency MHz	Level dBµV	Transd dB	Limit dBµV	Margin dB	Detector	Line	PE
0.244500	27.00	10.3	52	24.9	AV	L1	GND
0.636000	16.60	10.2	46	29.4	AV	L1	GND
2.049000	25.10	10.2	46	20.9	AV	L1	GND
2.836500	25.40	10.2	46	20.6	AV	L1	GND
6.436500	23.10	10.3	50	26.9	AV	L1	GND
13.996500	24.60	10.5	50	25.4	AV	L1	GND

Test Line: N

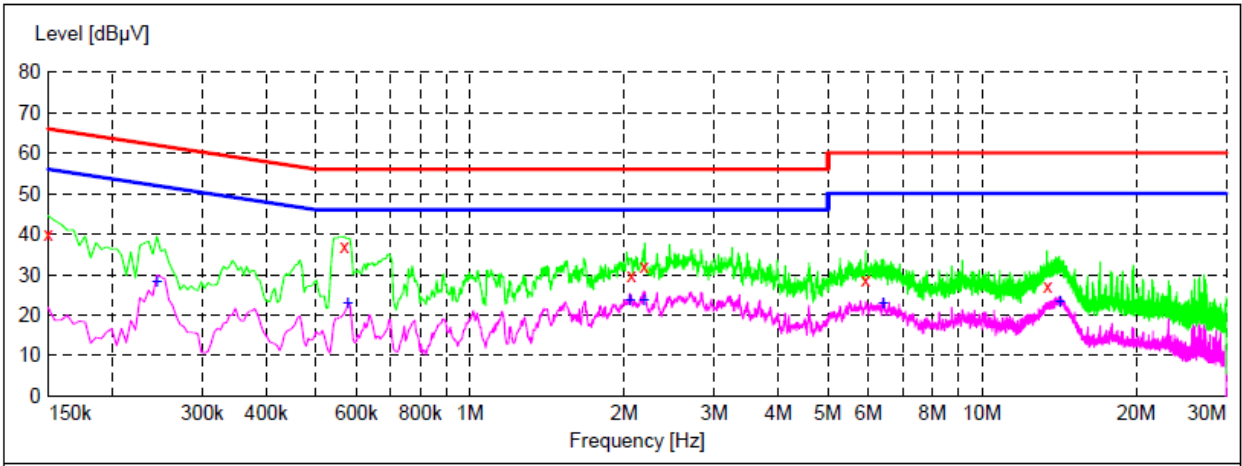

x x x MES GML710245076_fin

Frequency MHz	Level dBµV	Transd dB	Limit dBµV	Margin dB	Detector	Line	PE
0.150000	40.10	10.4	66	25.9	QP	N	GND
0.568500	36.80	10.2	56	19.2	QP	N	GND
2.067000	29.70	10.2	56	26.3	QP	N	GND
2.188500	32.20	10.2	56	23.8	QP	N	GND
5.932500	28.50	10.3	60	31.5	QP	N	GND
13.429500	27.20	10.5	60	32.8	QP	N	GND

Frequency MHz	Level dBµV	Transd dB	Limit dBµV	Margin dB	Detector	Line	PE
0.244500	28.20	10.3	52	23.7	AV	N	GND
0.577500	23.20	10.2	46	22.8	AV	N	GND
2.053500	23.90	10.2	46	22.1	AV	N	GND
2.188500	23.80	10.2	46	22.2	AV	N	GND
6.414000	22.90	10.3	50	27.1	AV	N	GND
14.190000	23.50	10.5	50	26.5	AV	N	GND

**6.3. Conducted Peak Output Power
LIMIT**

FCC CFR Title 47 Part 15 Subpart C Section 15.247 (b)(3): **30dBm**:

TEST CONFIGURATION

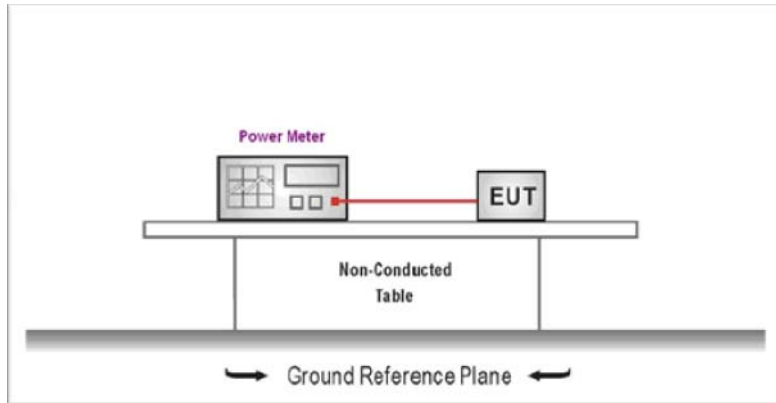

TEST PROCEDURE

1. The EUT was tested according to ANSI C63.10: 2013 and KDB 558074 D01 for compliance to FCC 47 CFR 15.247 requirements.
2. The maximum peak conducted output power may be measured using a broadband peak RF power meter.
3. The power meter shall have a video bandwidth that is greater than or equal to the DTS bandwidth and shall utilize a fast-responding diode detector
4. Record the measurement data.

TEST MODE:

Please refer to the clause 3.3

TEST RESULTS

Passed **Not Applicable**

Type	Channel	Output power (dBm)	Limit (dBm)	Result
802.11b	01	17.69	≤30.00	Pass
	06	17.26		
	11	17.49		
802.11g	01	15.35	≤30.00	Pass
	06	16.57		
	11	15.50		
802.11n(HT20)	01	15.63	≤30.00	Pass
	06	16.16		
	11	15.98		
802.11n(HT40)	03	14.43	≤30.00	Pass
	06	15.04		
	09	13.52		

6.4. Power Spectral Density

LIMIT

FCC CFR Title 47 Part 15 Subpart C Section 15.247 (e):For digitally modulated systems, the power spectral density conducted from the intentional radiator to the antenna shall not be greater than 8 dBm in any 3 kHz band during any time interval of continuous transmission.

TEST CONFIGURATION

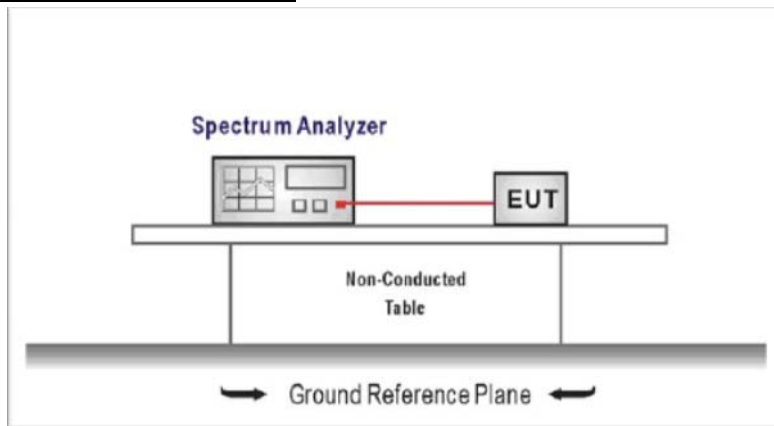

TEST PROCEDURE

1. Connect the antenna port(s) to the spectrum analyzer input,
2. Configure the spectrum analyzer as shown below:
Center frequency=DTS channel center frequency
Span =1.5 times the DTS bandwidth
RBW = 3 kHz ≤ RBW ≤ 100 kHz, VBW ≥ 3 × RBW
Sweep time = auto couple
Detector = peak
Trace mode = max hold
3. Place the radio in continuous transmit mode, allow the trace to stabilize, view the transmitter wave form on the spectrum analyzer.
4. Use the peak marker function to determine the maximum amplitude level within the RBW.
5. If measured value exceeds limit, reduce RBW (no less than 3 kHz) and repeat.

TEST MODE:

Please refer to the clause 3.3



TEST RESULTS



Passed Not Applicable

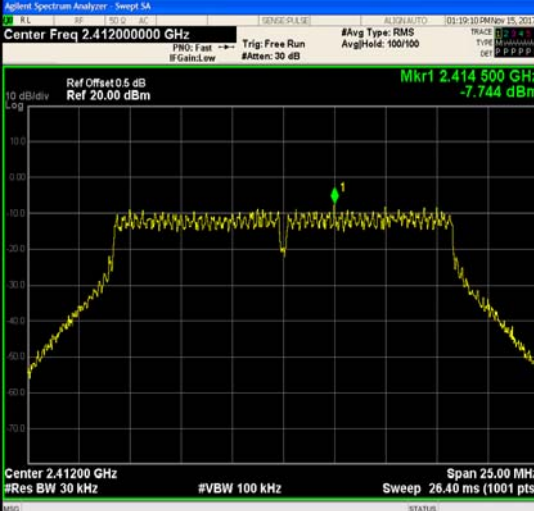

Type	Channel	Power Spectral Density (dBm/RBW)	Limit (dBm/RBW)	Result
802.11b	01	2.69	≤8.00	Pass
	06	2.61		
	11	1.84		
802.11g	01	-7.74	≤8.00	Pass
	06	-6.02		
	11	-7.64		
802.11n(HT20)	01	-8.03	≤8.00	Pass
	06	-6.90		
	11	-7.39		
802.11n(HT40)	03	-12.09	≤8.00	Pass
	06	-11.25		
	09	-12.84		

Test plot as follows:

Type:		802.11 b	
CH01			<p>Agilent Spectrum Analyzer - Sweep SA</p> <p>Center Freq 2.41200000 GHz</p> <p>Ref Offset 0.5 dB Ref 20.00 dBm</p> <p>Mkr1 2.410 992 GHz 2.687 dBm</p> <p>Center Freq 2.41200000 GHz</p> <p>Start Freq 2.404000000 GHz</p> <p>Stop Freq 2.420000000 GHz</p> <p>CF Step 1.600000 MHz</p> <p>Freq Offset 0 Hz</p> <p>Center 2.412000 GHz</p> <p>Span 16.00 MHz</p> <p>Res BW 30 kHz</p> <p>#VBW 100 kHz</p> <p>Sweep 16.93 ms (1001 pts)</p>
CH06			<p>Agilent Spectrum Analyzer - Sweep SA</p> <p>Center Freq 2.43700000 GHz</p> <p>Ref Offset 0.5 dB Ref 20.00 dBm</p> <p>Mkr1 2.437 992 GHz 2.606 dBm</p> <p>Center Freq 2.43700000 GHz</p> <p>Start Freq 2.429000000 GHz</p> <p>Stop Freq 2.445000000 GHz</p> <p>CF Step 1.600000 MHz</p> <p>Freq Offset 0 Hz</p> <p>Center 2.437000 GHz</p> <p>Span 16.00 MHz</p> <p>Res BW 30 kHz</p> <p>#VBW 100 kHz</p> <p>Sweep 16.93 ms (1001 pts)</p>
CH11			<p>Agilent Spectrum Analyzer - Sweep SA</p> <p>Center Freq 2.46200000 GHz</p> <p>Ref Offset 0.5 dB Ref 20.00 dBm</p> <p>Mkr1 2.461 376 GHz 1.838 dBm</p> <p>Center Freq 2.46200000 GHz</p> <p>Start Freq 2.454000000 GHz</p> <p>Stop Freq 2.470000000 GHz</p> <p>CF Step 1.600000 MHz</p> <p>Freq Offset 0 Hz</p> <p>Center 2.462000 GHz</p> <p>Span 16.00 MHz</p> <p>Res BW 30 kHz</p> <p>#VBW 100 kHz</p> <p>Sweep 16.93 ms (1001 pts)</p>

Type:		802.11 g	
CH01			<p>Frequency</p> <p>Auto Tune</p> <p>Center Freq 2.41200000 GHz</p> <p>Start Freq 2.399500000 GHz</p> <p>Stop Freq 2.424500000 GHz</p> <p>CF Step 2.500000 MHz Auto Man</p> <p>Freq Offset 0 Hz</p>
CH06			<p>Frequency</p> <p>Auto Tune</p> <p>Center Freq 2.437000000 GHz</p> <p>Start Freq 2.424500000 GHz</p> <p>Stop Freq 2.449500000 GHz</p> <p>CF Step 2.500000 MHz Auto Man</p> <p>Freq Offset 0 Hz</p>
CH11			<p>Frequency</p> <p>Auto Tune</p> <p>Center Freq 2.462000000 GHz</p> <p>Start Freq 2.449500000 GHz</p> <p>Stop Freq 2.474500000 GHz</p> <p>CF Step 2.500000 MHz Auto Man</p> <p>Freq Offset 0 Hz</p>

Type:		802.11n(HT20)	
CH01		<p>Agilent Spectrum Analyzer - Sweep SA</p> <p>Center Freq 2.412000000 GHz</p> <p>Ref Offset 0.5 dB Ref 20.00 dBm</p> <p>Mkr1 2.419 500 GHz -8.031 dBm</p> <p>Center 2.41200 GHz #Res BW 30 kHz</p> <p>Span 25.00 MHz #VBW 100 kHz Sweep 26.40 ms (1001 pts)</p>	<p>Frequency</p> <p>Auto Tune</p> <p>Center Freq 2.412000000 GHz</p> <p>Start Freq 2.399500000 GHz</p> <p>Stop Freq 2.424500000 GHz</p> <p>CF Step 2.500000 MHz</p> <p>Freq Offset 0 Hz</p>
CH06		<p>Agilent Spectrum Analyzer - Sweep SA</p> <p>Center Freq 2.437000000 GHz</p> <p>Ref Offset 0.5 dB Ref 20.00 dBm</p> <p>Mkr1 2.444 500 GHz -8.901 dBm</p> <p>Center 2.43700 GHz #Res BW 30 kHz</p> <p>Span 25.00 MHz #VBW 100 kHz Sweep 26.40 ms (1001 pts)</p>	<p>Frequency</p> <p>Auto Tune</p> <p>Center Freq 2.437000000 GHz</p> <p>Start Freq 2.424500000 GHz</p> <p>Stop Freq 2.449500000 GHz</p> <p>CF Step 2.500000 MHz</p> <p>Freq Offset 0 Hz</p>
CH11		<p>Agilent Spectrum Analyzer - Sweep SA</p> <p>Center Freq 2.462000000 GHz</p> <p>Ref Offset 0.5 dB Ref 20.00 dBm</p> <p>Mkr1 2.469 500 GHz -7.391 dBm</p> <p>Center 2.46200 GHz #Res BW 30 kHz</p> <p>Span 25.00 MHz #VBW 100 kHz Sweep 26.40 ms (1001 pts)</p>	<p>Frequency</p> <p>Auto Tune</p> <p>Center Freq 2.462000000 GHz</p> <p>Start Freq 2.449500000 GHz</p> <p>Stop Freq 2.474500000 GHz</p> <p>CF Step 2.500000 MHz</p> <p>Freq Offset 0 Hz</p>

Type:		802.11n(HT40)	
CH03	 <p>Agilent Spectrum Analyzer - Swept SA Center Freq 2.422000000 GHz #Avg Type: RMS #Res BW 30 kHz #VBW 100 kHz Span 55.00 MHz Sweep 58.00 ms (1001 pts)</p> <p>Mkr1 2.431020 GHz -12.088 dBm</p>	<p>Frequency</p> <p>Auto Tune</p> <p>Center Freq 2.422000000 GHz</p> <p>Start Freq 2.394500000 GHz</p> <p>Stop Freq 2.449500000 GHz</p> <p>CF Step 5.500000 MHz Auto Man</p> <p>Freq Offset 0 Hz</p>	
CH06	 <p>Agilent Spectrum Analyzer - Swept SA Center Freq 2.437000000 GHz #Avg Type: RMS #Res BW 30 kHz #VBW 100 kHz Span 55.00 MHz Sweep 58.00 ms (1001 pts)</p> <p>Mkr1 2.434470 GHz -11.250 dBm</p>	<p>Frequency</p> <p>Auto Tune</p> <p>Center Freq 2.437000000 GHz</p> <p>Start Freq 2.409500000 GHz</p> <p>Stop Freq 2.464500000 GHz</p> <p>CF Step 5.500000 MHz Auto Man</p> <p>Freq Offset 0 Hz</p>	
CH09	 <p>Agilent Spectrum Analyzer - Swept SA Center Freq 2.452000000 GHz #Avg Type: RMS #Res BW 30 kHz #VBW 100 kHz Span 55.00 MHz Sweep 58.00 ms (1001 pts)</p> <p>Mkr1 2.446995 GHz -12.837 dBm</p>	<p>Frequency</p> <p>Auto Tune</p> <p>Center Freq 2.452000000 GHz</p> <p>Start Freq 2.424500000 GHz</p> <p>Stop Freq 2.479500000 GHz</p> <p>CF Step 5.500000 MHz Auto Man</p> <p>Freq Offset 0 Hz</p>	

6.5. 6dB bandwidth

LIMIT

FCC CFR Title 47 Part 15 Subpart C Section 15.247 (a)(2):For digital modulation systems, the minimum 6 dB bandwidth shall be at least 500 kHz.

TEST CONFIGURATION

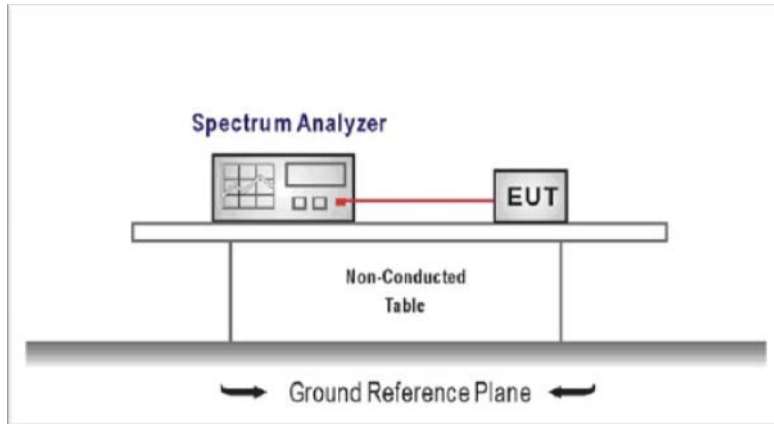

TEST PROCEDURE

1. Connect the antenna port(s) to the spectrum analyzer input.
2. Configure the spectrum analyzer as shown below (enter all losses between the transmitter output and the spectrum analyzer).
Center Frequency = DTS channel center frequency
Span = 2 x DTS bandwidth
RBW = 100 kHz, VBW \geq 3 x RBW
Sweep time = auto couple
Detector = Peak
Trace mode = max hold
3. Place the radio in continuous transmit mode, allow the trace to stabilize, view the transmitter wave form on the spectrum analyzer.
4. Measure the maximum width of the emission that is constrained by the frequencies associated with the two outermost amplitude points (upper and lower frequencies) that are attenuated by 6 dB relative to the maximum level measured in the fundamental emission, and record the pertinent measurements.

TEST MODE:

Please refer to the clause 3.3

TEST RESULTS

Passed Not Applicable

Type	Channel	6dB Bandwidth (MHz)	Limit (kHz)	Result
802.11b	01	10.06	≥500	Pass
	06	10.07		
	11	10.05		
802.11g	01	16.38	≥500	Pass
	06	16.38		
	11	16.43		
802.11n(HT20)	01	17.56	≥500	Pass
	06	17.36		
	11	17.34		
802.11n(HT40)	03	35.41	≥500	Pass
	06	35.41		
	09	35.21		

Test plot as follows:

Type:		802.11 b	
CH01	<p>Agilent Spectrum Analyzer - Occupied BW</p> <p>Center Freq 2.412000000 GHz</p> <p>Ref Offset 0.5 dB Ref 20.50 dBm</p> <p>Mkr1 2.413 GHz 5.7878 dBm</p> <p>Center 2.412 GHz #Res BW 100 kHz</p> <p>Span 25 MHz Sweep 2.4 ms</p> <p>Occupied Bandwidth 14.895 MHz</p> <p>Total Power 21.9 dBm</p> <p>Transmit Freq Error 66.587 kHz</p> <p>OBW Power 99.00 %</p> <p>x dB Bandwidth 10.06 MHz</p> <p>x dB -6.00 dB</p>	<p>Frequency</p> <p>Center Freq 2.412000000 GHz</p> <p>CF Step 2.500000 MHz</p> <p>Freq Offset 0 Hz</p>	
CH06	<p>Agilent Spectrum Analyzer - Occupied BW</p> <p>Center Freq 2.437000000 GHz</p> <p>Ref Offset 0.5 dB Ref 20.50 dBm</p> <p>Mkr1 2.4365 GHz 5.2841 dBm</p> <p>Center 2.437 GHz #Res BW 100 kHz</p> <p>Span 25 MHz Sweep 2.4 ms</p> <p>Occupied Bandwidth 14.914 MHz</p> <p>Total Power 21.5 dBm</p> <p>Transmit Freq Error 78.546 kHz</p> <p>OBW Power 99.00 %</p> <p>x dB Bandwidth 10.07 MHz</p> <p>x dB -6.00 dB</p>	<p>Frequency</p> <p>Center Freq 2.437000000 GHz</p> <p>CF Step 2.500000 MHz</p> <p>Freq Offset 0 Hz</p>	
CH11	<p>Agilent Spectrum Analyzer - Occupied BW</p> <p>Center Freq 2.462000000 GHz</p> <p>Ref Offset 0.5 dB Ref 20.50 dBm</p> <p>Mkr1 2.463 GHz 3.3943 dBm</p> <p>Center 2.462 GHz #Res BW 100 kHz</p> <p>Span 25 MHz Sweep 2.4 ms</p> <p>Occupied Bandwidth 14.872 MHz</p> <p>Total Power 19.4 dBm</p> <p>Transmit Freq Error 52.118 kHz</p> <p>OBW Power 99.00 %</p> <p>x dB Bandwidth 10.05 MHz</p> <p>x dB -6.00 dB</p>	<p>Frequency</p> <p>Center Freq 2.462000000 GHz</p> <p>CF Step 2.500000 MHz</p> <p>Freq Offset 0 Hz</p>	

Type:		802.11 g	
CH01		<p>Agilent Spectrum Analyzer - Occupied BW</p> <p>Center Freq 2.412000000 GHz</p> <p>Ref Offset 0.5 dB Ref 20.50 dBm</p> <p>Mkr1 2.41953 GHz -3.3658 dBm</p> <p>Center 2.412 GHz #Res BW 100 kHz</p> <p>Span 30 MHz Sweep 2.933 ms</p> <p>Occupied Bandwidth 16.478 MHz</p> <p>Total Power 14.6 dBm</p> <p>Transmit Freq Error 22.547 kHz</p> <p>OBW Power 99.00 %</p> <p>x dB Bandwidth 16.38 MHz</p> <p>x dB -6.00 dB</p>	<p>Frequency</p> <p>Center Freq 2.412000000 GHz</p> <p>CF Step 3.000000 MHz</p> <p>Freq Offset 0 Hz</p>
CH06		<p>Agilent Spectrum Analyzer - Occupied BW</p> <p>Center Freq 2.437000000 GHz</p> <p>Ref Offset 0.5 dB Ref 20.50 dBm</p> <p>Mkr1 2.43829 GHz -2.2111 dBm</p> <p>Center 2.437 GHz #Res BW 100 kHz</p> <p>Span 30 MHz Sweep 2.933 ms</p> <p>Occupied Bandwidth 16.474 MHz</p> <p>Total Power 15.9 dBm</p> <p>Transmit Freq Error 28.835 kHz</p> <p>OBW Power 99.00 %</p> <p>x dB Bandwidth 16.38 MHz</p> <p>x dB -6.00 dB</p>	<p>Frequency</p> <p>Center Freq 2.437000000 GHz</p> <p>CF Step 3.000000 MHz</p> <p>Freq Offset 0 Hz</p>
CH11		<p>Agilent Spectrum Analyzer - Occupied BW</p> <p>Center Freq 2.462000000 GHz</p> <p>Ref Offset 0.5 dB Ref 20.50 dBm</p> <p>Mkr1 2.46953 GHz -1.1675 dBm</p> <p>Center 2.462 GHz #Res BW 100 kHz</p> <p>Span 30 MHz Sweep 2.933 ms</p> <p>Occupied Bandwidth 16.477 MHz</p> <p>Total Power 17.0 dBm</p> <p>Transmit Freq Error 23.658 kHz</p> <p>OBW Power 99.00 %</p> <p>x dB Bandwidth 16.43 MHz</p> <p>x dB -6.00 dB</p>	<p>Frequency</p> <p>Center Freq 2.462000000 GHz</p> <p>CF Step 3.000000 MHz</p> <p>Freq Offset 0 Hz</p>

Type:		802.11n(HT20)	
CH01		<p>Agilent Spectrum Analyzer - Occupied BW</p> <p>Center Freq 2.412000000 GHz</p> <p>Ref Offset 0.5 dB Ref 20.50 dBm</p> <p>Mkr1 2.41326 GHz -6.5291 dBm</p> <p>Center 2.412 GHz #Res BW 100 kHz</p> <p>Span 30 MHz Sweep 2.933 ms</p> <p>Occupied Bandwidth 17.611 MHz</p> <p>Total Power 11.5 dBm</p> <p>Transmit Freq Error 21.088 kHz</p> <p>OBW Power 99.00 %</p> <p>x dB Bandwidth 17.56 MHz</p> <p>x dB -6.00 dB</p>	<p>Frequency</p> <p>Center Freq 2.412000000 GHz</p> <p>CF Step 3.000000 MHz</p> <p>Freq Offset 0 Hz</p>
CH06		<p>Agilent Spectrum Analyzer - Occupied BW</p> <p>Center Freq 2.437000000 GHz</p> <p>Ref Offset 0.5 dB Ref 20.50 dBm</p> <p>Mkr1 2.4445 GHz -2.3912 dBm</p> <p>Center 2.437 GHz #Res BW 100 kHz</p> <p>Span 30 MHz Sweep 2.933 ms</p> <p>Occupied Bandwidth 17.620 MHz</p> <p>Total Power 15.6 dBm</p> <p>Transmit Freq Error 27.954 kHz</p> <p>OBW Power 99.00 %</p> <p>x dB Bandwidth 17.36 MHz</p> <p>x dB -6.00 dB</p>	<p>Frequency</p> <p>Center Freq 2.437000000 GHz</p> <p>CF Step 3.000000 MHz</p> <p>Freq Offset 0 Hz</p>
CH11		<p>Agilent Spectrum Analyzer - Occupied BW</p> <p>Center Freq 2.462000000 GHz</p> <p>Ref Offset 0.5 dB Ref 20.50 dBm</p> <p>Mkr1 2.46329 GHz -1.3407 dBm</p> <p>Center 2.462 GHz #Res BW 100 kHz</p> <p>Span 30 MHz Sweep 2.933 ms</p> <p>Occupied Bandwidth 17.614 MHz</p> <p>Total Power 16.7 dBm</p> <p>Transmit Freq Error 26.280 kHz</p> <p>OBW Power 99.00 %</p> <p>x dB Bandwidth 17.34 MHz</p> <p>x dB -6.00 dB</p>	<p>Frequency</p> <p>Center Freq 2.462000000 GHz</p> <p>CF Step 3.000000 MHz</p> <p>Freq Offset 0 Hz</p>

Type:		802.11n(HT40)	
CH03		<p>Agilent Spectrum Analyzer - Occupied BW</p> <p>Center Freq 2.422000000 GHz</p> <p>Center Freq: 2.422000000 GHz</p> <p>Trig: Free Run</p> <p>Avg/Hold: 500/500</p> <p>Radio Std: None</p> <p>Radio Device: BTS</p> <p>Ref Offset 0.5 dB</p> <p>Ref 20.50 dBm</p> <p>Mkr1 2.43327 GHz</p> <p>-6.0035 dBm</p> <p>Center 2.422 GHz</p> <p>#Res BW 100 kHz</p> <p>#VBW 300 kHz</p> <p>Span 70 MHz</p> <p>Sweep 6.733 ms</p> <p>Occupied Bandwidth 35.813 MHz</p> <p>Total Power 15.1 dBm</p> <p>Transmit Freq Error 66.033 kHz</p> <p>OBW Power 99.00 %</p> <p>x dB Bandwidth 35.41 MHz</p> <p>x dB -6.00 dB</p>	<p>Frequency</p> <p>Center Freq 2.422000000 GHz</p> <p>CF Step 7.000000 MHz</p> <p>Auto Man</p> <p>Freq Offset 0 Hz</p>
CH06		<p>Agilent Spectrum Analyzer - Occupied BW</p> <p>Center Freq 2.437000000 GHz</p> <p>Center Freq: 2.437000000 GHz</p> <p>Trig: Free Run</p> <p>Avg/Hold: 500/500</p> <p>Radio Std: None</p> <p>Radio Device: BTS</p> <p>Ref Offset 0.5 dB</p> <p>Ref 20.50 dBm</p> <p>Mkr1 2.44827 GHz</p> <p>-6.1563 dBm</p> <p>Center 2.437 GHz</p> <p>#Res BW 100 kHz</p> <p>#VBW 300 kHz</p> <p>Span 70 MHz</p> <p>Sweep 6.733 ms</p> <p>Occupied Bandwidth 35.838 MHz</p> <p>Total Power 14.9 dBm</p> <p>Transmit Freq Error 66.689 kHz</p> <p>OBW Power 99.00 %</p> <p>x dB Bandwidth 35.41 MHz</p> <p>x dB -6.00 dB</p>	<p>Frequency</p> <p>Center Freq 2.437000000 GHz</p> <p>CF Step 7.000000 MHz</p> <p>Auto Man</p> <p>Freq Offset 0 Hz</p>
CH09		<p>Agilent Spectrum Analyzer - Occupied BW</p> <p>Center Freq 2.452000000 GHz</p> <p>Center Freq: 2.452000000 GHz</p> <p>Trig: Free Run</p> <p>Avg/Hold: 500/500</p> <p>Radio Std: None</p> <p>Radio Device: BTS</p> <p>Ref Offset 0.5 dB</p> <p>Ref 20.50 dBm</p> <p>Mkr1 2.46327 GHz</p> <p>-7.5434 dBm</p> <p>Center 2.452 GHz</p> <p>#Res BW 100 kHz</p> <p>#VBW 300 kHz</p> <p>Span 70 MHz</p> <p>Sweep 6.733 ms</p> <p>Occupied Bandwidth 35.762 MHz</p> <p>Total Power 13.3 dBm</p> <p>Transmit Freq Error 88.065 kHz</p> <p>OBW Power 99.00 %</p> <p>x dB Bandwidth 35.21 MHz</p> <p>x dB -6.00 dB</p>	<p>Frequency</p> <p>Center Freq 2.452000000 GHz</p> <p>CF Step 7.000000 MHz</p> <p>Auto Man</p> <p>Freq Offset 0 Hz</p>

6.6. Restricted band

LIMIT

FCC CFR Title 47 Part 15 Subpart C Section 15.247 (d): In any 100 kHz bandwidth outside the frequency band in which the spread spectrum or digitally modulated intentional radiator is operating, Radiated Emissions which fall in the restricted bands, as defined in §15.205(a), must also comply with the Radiated Emissions limits specified in §15.209(a) (see §15.205(c)).

TEST CONFIGURATION

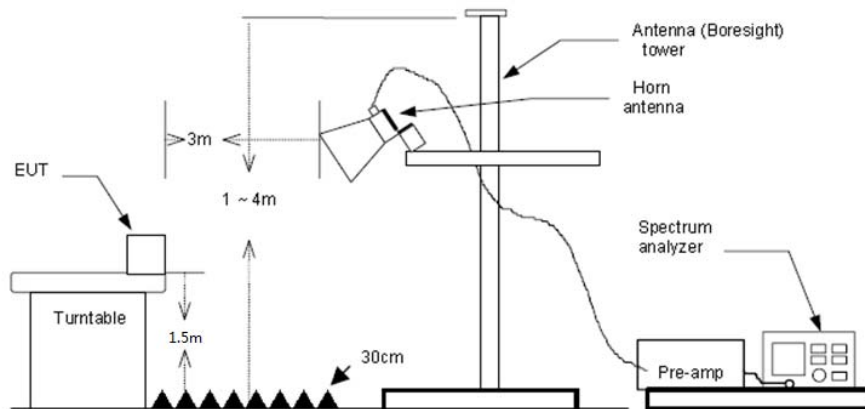

TEST PROCEDURE

- 1) The EUT was setup and tested according to ANSI C63.10:2013 for compliance to FCC 47CFR 15.247 requirements.
- 2) The EUT is placed on a turn table which is 1.5 meter above ground. The turn table is rotated 360 degrees to determine the position of the maximum emission level.
- 3) The EUT was positioned such that the distance from antenna to the EUT was 3 meters.
- 4) The antenna is scanned from 1 meter to 4 meters to find out the maximum emission level. This is repeated for both horizontal and vertical polarization of the antenna. In order to find the maximum emission, all of the interface cables were manipulated according to ANSI C63.10:2013 on radiated measurement.
- 5) The receiver set as follow:
 RBW=1MHz, VBW=3MHz PEAK detector for Peak value.
 RBW=1MHz, VBW=3MHz RMS detector for Average value.

TEST MODE:

Please refer to the clause 3.3

TEST RESULTS

Passed Not Applicable

Note:

- 1) Final level= Read level + Antenna Factor+ Cable Loss- Preamp Factor

802.11b					CH01				
Frequency (MHz)	Read Level (dBuV)	Antenna Factor (dB/m)	Cable Loss (dB)	Preamplifier Factor (dB)	Level (dBuV/m)	Limit Line (dBuV/m)	Over Limit (dB)	Polarization	Test value
2310.00	14.47	28.05	6.62	0.00	49.14	74.00	-24.86	Vertical	Peak
2364.39	26.92	27.78	6.71	0.00	61.41	74.00	-12.59	Vertical	Peak
2390.01	15.80	27.65	6.75	0.00	50.20	74.00	-23.80	Vertical	Peak
2310.00	14.89	28.05	6.62	0.00	49.56	74.00	-24.44	Horizontal	Peak
2390.01	15.47	27.65	6.75	0.00	49.87	74.00	-24.13	Horizontal	Peak
2310.00	11.28	28.05	6.62	0.00	45.95	54.00	-8.05	Vertical	Average
2390.01	11.41	27.65	6.75	0.00	45.81	54.00	-8.19	Vertical	Average
2310.00	11.37	28.05	6.62	0.00	46.04	54.00	-7.96	Horizontal	Average
2390.01	10.94	27.65	6.75	0.00	45.34	54.00	-8.66	Horizontal	Average

802.11b					CH11				
Frequency (MHz)	Read Level (dBuV)	Antenna Factor (dB/m)	Cable Loss (dB)	Preamplifier Factor (dB)	Level (dBuV/m)	Limit Line (dBuV/m)	Over Limit (dB)	Polarization	Test value
2483.49	13.68	27.26	6.83	0.00	47.77	74.00	-26.23	Vertical	Peak
2500.00	13.69	27.20	6.84	0.00	47.73	74.00	-26.27	Vertical	Peak
2483.49	14.01	27.26	6.83	0.00	48.10	74.00	-25.90	Horizontal	Peak
2500.00	13.47	27.20	6.84	0.00	47.51	74.00	-26.49	Horizontal	Peak
2483.49	11.01	27.26	6.83	0.00	45.10	54.00	-8.90	Vertical	Average
2500.00	10.87	27.20	6.84	0.00	44.91	54.00	-9.09	Vertical	Average
2483.49	10.88	27.26	6.83	0.00	44.97	54.00	-9.03	Horizontal	Average
2500.00	10.84	27.20	6.84	0.00	44.88	54.00	-9.12	Horizontal	Average

802.11g					CH01				
Frequency (MHz)	Read Level (dBuV)	Antenna Factor (dB/m)	Cable Loss (dB)	Preamplifier Factor (dB)	Level (dBuV/m)	Limit Line (dBuV/m)	Over Limit (dB)	Polarization	Test value
2310.00	14.76	28.05	6.62	0.00	49.43	74.00	-24.57	Vertical	Peak
2390.01	15.39	27.65	6.75	0.00	49.79	74.00	-24.21	Vertical	Peak
2310.00	13.03	28.05	6.62	0.00	47.70	74.00	-26.30	Horizontal	Peak
2390.01	15.39	27.65	6.75	0.00	49.79	74.00	-24.21	Horizontal	Peak
2310.00	11.23	28.05	6.62	0.00	45.90	54.00	-8.10	Vertical	Average
2390.01	11.34	27.65	6.75	0.00	45.74	54.00	-8.26	Vertical	Average
2310.00	11.34	28.05	6.62	0.00	46.01	54.00	-7.99	Horizontal	Average
2390.01	14.49	27.65	6.75	0.00	48.89	54.00	-5.11	Horizontal	Average

802.11g					CH11				
Frequency (MHz)	Read Level (dBuV)	Antenna Factor (dB/m)	Cable Loss (dB)	Preamp Factor (dB)	Level (dBuV/m)	Limit Line (dBuV/m)	Over Limit (dB)	Polarization	Test value
2483.49	15.17	27.26	6.83	0.00	49.26	74.00	-24.74	Vertical	Peak
2500.00	14.54	27.20	6.84	0.00	48.58	74.00	-25.42	Vertical	Peak
2483.49	15.25	27.26	6.83	0.00	49.34	74.00	-24.66	Horizontal	Peak
2500.00	13.98	27.20	6.84	0.00	48.02	74.00	-25.98	Horizontal	Peak
2483.49	11.93	27.26	6.83	0.00	46.02	54.00	-7.98	Vertical	Average
2500.00	10.91	27.20	6.84	0.00	44.95	54.00	-9.05	Vertical	Average
2483.49	11.33	27.26	6.83	0.00	45.42	54.00	-8.58	Horizontal	Average
2500.00	10.80	27.20	6.84	0.00	44.84	54.00	-9.16	Horizontal	Average

802.11n(HT20)					CH01				
Frequency (MHz)	Read Level (dBuV)	Antenna Factor (dB/m)	Cable Loss (dB)	Preamp Factor (dB)	Level (dBuV/m)	Limit Line (dBuV/m)	Over Limit (dB)	Polarization	Test value
2310.00	14.44	28.05	6.62	0.00	49.11	74.00	-24.89	Vertical	Peak
2327.11	25.00	27.96	6.65	0.00	59.61	74.00	-14.39	Vertical	Peak
2390.01	15.95	27.65	6.75	0.00	50.35	74.00	-23.65	Vertical	Peak
2310.00	14.45	28.05	6.62	0.00	49.12	74.00	-24.88	Horizontal	Peak
2390.01	16.56	27.65	6.75	0.00	50.96	74.00	-23.04	Horizontal	Peak
2310.00	11.26	28.05	6.62	0.00	45.93	54.00	-8.07	Vertical	Average
2390.01	13.78	27.65	6.75	0.00	48.18	54.00	-5.82	Vertical	Average
2310.00	11.27	28.05	6.62	0.00	45.94	54.00	-8.06	Horizontal	Average
2390.01	14.90	27.65	6.75	0.00	49.30	54.00	-4.70	Horizontal	Average

802.11n(HT20)					CH11				
Frequency (MHz)	Read Level (dBuV)	Antenna Factor (dB/m)	Cable Loss (dB)	Preamp Factor (dB)	Level (dBuV/m)	Limit Line (dBuV/m)	Over Limit (dB)	Polarization	Test value
2483.49	13.70	27.26	6.83	0.00	47.79	74.00	-26.21	Vertical	Peak
2500.00	13.41	27.20	6.84	0.00	47.45	74.00	-26.55	Vertical	Peak
2483.49	14.35	27.26	6.83	0.00	48.44	74.00	-25.56	Horizontal	Peak
2500.00	13.92	27.20	6.84	0.00	47.96	74.00	-26.04	Horizontal	Peak
2483.49	12.70	27.26	6.83	0.00	46.79	54.00	-7.21	Vertical	Average
2500.00	10.83	27.20	6.84	0.00	44.87	54.00	-9.13	Vertical	Average
2483.49	12.58	27.26	6.83	0.00	46.67	54.00	-7.33	Horizontal	Average
2500.00	11.07	27.20	6.84	0.00	45.11	54.00	-8.89	Horizontal	Average

802.11n(HT40)					CH03				
Frequency (MHz)	Read Level (dBuV)	Antenna Factor (dB/m)	Cable Loss (dB)	Preamp Factor (dB)	Level (dBuV/m)	Limit Line (dBuV/m)	Over Limit (dB)	Polarization	Test value
2310.00	14.57	28.05	6.62	0.00	49.24	74.00	-24.76	Vertical	Peak
2389.99	16.27	27.65	6.75	0.00	50.67	74.00	-23.33	Vertical	Peak
2310.00	14.40	28.05	6.62	0.00	49.07	74.00	-24.93	Horizontal	Peak
2389.99	19.45	27.65	6.75	0.00	53.85	74.00	-20.15	Horizontal	Peak
2310.00	11.27	28.05	6.62	0.00	45.94	54.00	-8.06	Vertical	Average
2389.99	14.73	27.65	6.75	0.00	49.13	54.00	-4.87	Vertical	Average
2310.00	11.30	28.05	6.62	0.00	45.97	54.00	-8.03	Horizontal	Average
2389.99	14.70	27.65	6.75	0.00	49.10	54.00	-4.90	Horizontal	Average

802.11n(HT40)					CH09				
Frequency (MHz)	Read Level (dBuV)	Antenna Factor (dB/m)	Cable Loss (dB)	Preamp Factor (dB)	Level (dBuV/m)	Limit Line (dBuV/m)	Over Limit (dB)	Polarization	Test value
2483.50	12.45	27.26	6.83	0.00	46.54	74.00	-27.46	Vertical	Peak
2500.00	13.84	27.20	6.84	0.00	47.88	74.00	-26.12	Vertical	Peak
2483.50	12.81	27.26	6.83	0.00	46.90	74.00	-27.10	Horizontal	Peak
2500.00	14.14	27.20	6.84	0.00	48.18	74.00	-25.82	Horizontal	Peak
2483.50	12.03	27.26	6.83	0.00	46.12	54.00	-7.88	Vertical	Average
2500.00	11.05	27.20	6.84	0.00	45.09	54.00	-8.91	Vertical	Average
2483.50	11.10	27.26	6.83	0.00	45.19	54.00	-8.81	Horizontal	Average
2500.00	11.13	27.20	6.84	0.00	45.17	54.00	-8.83	Horizontal	Average

6.7. Band edge and Spurious Emissions (conducted)

LIMIT

FCC CFR Title 47 Part 15 Subpart C Section 15.247 (d): In any 100 kHz bandwidth outside the frequency band in which the spread spectrum intentional radiator is operating, the radio frequency power that is produced by the intentional radiator shall be at least 20 dB below that in the 100 kHz bandwidth within the band that contains the highest level of the desired power, based on either an RF conducted or a radiated measurement.

TEST CONFIGURATION

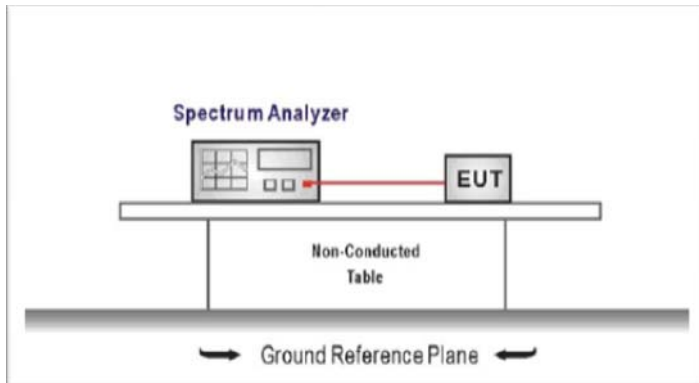

TEST PROCEDURE

1. Connect the antenna port(s) to the spectrum analyzer input.
2. Establish a reference level by using the following procedure
Center frequency=DTS channel center frequency
The span = 1.5 times the DTS bandwidth.
RBW = 100 kHz, VBW \geq 3 x RBW
Detector = peak, Sweep time = auto couple, Trace mode = max hold
Allow trace to fully stabilize
Use the peak marker function to determine the maximum PSD level



Note: the channel found to contain the maximum PSD level can be used to establish the reference level.
3. Emission level measurement
Set the center frequency and span to encompass frequency range to be measured
RBW = 100 kHz, VBW \geq 3 x RBW
Detector = peak, Sweep time = auto couple, Trace mode = max hold
Allow trace to fully stabilize
Use the peak marker function to determine the maximum amplitude level.
4. Place the radio in continuous transmit mode, allow the trace to stabilize, view the transmitter waveform on the spectrum analyzer.
5. Ensure that the amplitude of all unwanted emission outside of the authorized frequency band excluding restricted frequency bands) are attenuated by at least the minimum requirements specified (at least 20 dB relative to the maximum in-band peak PSD level in 100 kHz). Report the three highest emission relative to the limit.

TEST MODE:



Please refer to the clause 3.3



TEST RESULTS

Passed Not Applicable

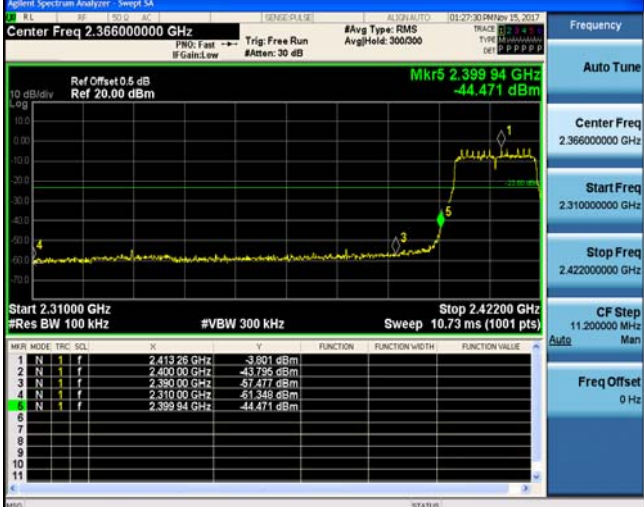
Test Item:	Bandedge	Type:	802.11 b							
CH01			<table border="1"> <tr><td>Frequency</td></tr> <tr><td>Auto Tune</td></tr> <tr><td>Center Freq 2.366000000 GHz</td></tr> <tr><td>Start Freq 2.310000000 GHz</td></tr> <tr><td>Stop Freq 2.422000000 GHz</td></tr> <tr><td>CF Step 11.200000 MHz</td></tr> <tr><td>Freq Offset 0 Hz</td></tr> </table>	Frequency	Auto Tune	Center Freq 2.366000000 GHz	Start Freq 2.310000000 GHz	Stop Freq 2.422000000 GHz	CF Step 11.200000 MHz	Freq Offset 0 Hz
Frequency										
Auto Tune										
Center Freq 2.366000000 GHz										
Start Freq 2.310000000 GHz										
Stop Freq 2.422000000 GHz										
CF Step 11.200000 MHz										
Freq Offset 0 Hz										
CH11			<table border="1"> <tr><td>Frequency</td></tr> <tr><td>Auto Tune</td></tr> <tr><td>Center Freq 2.476000000 GHz</td></tr> <tr><td>Start Freq 2.452000000 GHz</td></tr> <tr><td>Stop Freq 2.500000000 GHz</td></tr> <tr><td>CF Step 4.800000 MHz</td></tr> <tr><td>Freq Offset 0 Hz</td></tr> </table>	Frequency	Auto Tune	Center Freq 2.476000000 GHz	Start Freq 2.452000000 GHz	Stop Freq 2.500000000 GHz	CF Step 4.800000 MHz	Freq Offset 0 Hz
Frequency										
Auto Tune										
Center Freq 2.476000000 GHz										
Start Freq 2.452000000 GHz										
Stop Freq 2.500000000 GHz										
CF Step 4.800000 MHz										
Freq Offset 0 Hz										

Test Item:	Bandedge	Type:	802.11 g																																																						
CH01	<p>Agilent Spectrum Analyzer - Sweep SA Center Freq 2.366000000 GHz Ref Offset 0.5 dB Ref 20.00 dBm Mkr5 2.399 94 GHz -44.710 dBm Start 2.31000 GHz #Res BW 100 kHz #VBW 300 kHz Stop 2.42200 GHz Sweep 10.73 ms (1001 pts)</p> <table border="1"> <thead> <tr> <th>MNR</th> <th>MODE</th> <th>TRC</th> <th>SCL</th> <th>F</th> <th>X</th> <th>FUNCTION</th> <th>FUNCTION WIDTH</th> <th>FUNCTION VALUE</th> </tr> </thead> <tbody> <tr> <td>1</td> <td>N</td> <td>1</td> <td>f</td> <td>2.413 28 GHz</td> <td>-3.429 dBm</td> <td></td> <td></td> <td></td> </tr> <tr> <td>2</td> <td>N</td> <td>1</td> <td>f</td> <td>2.400 00 GHz</td> <td>-5.043 dBm</td> <td></td> <td></td> <td></td> </tr> <tr> <td>3</td> <td>N</td> <td>1</td> <td>f</td> <td>2.390 00 GHz</td> <td>-57.990 dBm</td> <td></td> <td></td> <td></td> </tr> <tr> <td>4</td> <td>N</td> <td>1</td> <td>f</td> <td>2.310 00 GHz</td> <td>-60.068 dBm</td> <td></td> <td></td> <td></td> </tr> <tr> <td>5</td> <td>N</td> <td>1</td> <td>f</td> <td>2.399 94 GHz</td> <td>-44.710 dBm</td> <td></td> <td></td> <td></td> </tr> </tbody> </table>			MNR	MODE	TRC	SCL	F	X	FUNCTION	FUNCTION WIDTH	FUNCTION VALUE	1	N	1	f	2.413 28 GHz	-3.429 dBm				2	N	1	f	2.400 00 GHz	-5.043 dBm				3	N	1	f	2.390 00 GHz	-57.990 dBm				4	N	1	f	2.310 00 GHz	-60.068 dBm				5	N	1	f	2.399 94 GHz	-44.710 dBm			
MNR	MODE	TRC	SCL	F	X	FUNCTION	FUNCTION WIDTH	FUNCTION VALUE																																																	
1	N	1	f	2.413 28 GHz	-3.429 dBm																																																				
2	N	1	f	2.400 00 GHz	-5.043 dBm																																																				
3	N	1	f	2.390 00 GHz	-57.990 dBm																																																				
4	N	1	f	2.310 00 GHz	-60.068 dBm																																																				
5	N	1	f	2.399 94 GHz	-44.710 dBm																																																				
CH11	<p>Agilent Spectrum Analyzer - Sweep SA Center Freq 2.476000000 GHz Ref Offset 0.5 dB Ref 20.00 dBm Mkr4 2.484 784 GHz -53.699 dBm Start 2.45200 GHz #Res BW 100 kHz #VBW 300 kHz Stop 2.50000 GHz Sweep 4.600 ms (1001 pts)</p> <table border="1"> <thead> <tr> <th>MNR</th> <th>MODE</th> <th>TRC</th> <th>SCL</th> <th>F</th> <th>X</th> <th>FUNCTION</th> <th>FUNCTION WIDTH</th> <th>FUNCTION VALUE</th> </tr> </thead> <tbody> <tr> <td>1</td> <td>N</td> <td>1</td> <td>f</td> <td>2.483 280 GHz</td> <td>-3.408 dBm</td> <td></td> <td></td> <td></td> </tr> <tr> <td>2</td> <td>N</td> <td>1</td> <td>f</td> <td>2.483 500 GHz</td> <td>-55.308 dBm</td> <td></td> <td></td> <td></td> </tr> <tr> <td>3</td> <td>N</td> <td>1</td> <td>f</td> <td>2.500 000 GHz</td> <td>-56.821 dBm</td> <td></td> <td></td> <td></td> </tr> <tr> <td>4</td> <td>N</td> <td>1</td> <td>f</td> <td>2.484 784 GHz</td> <td>-53.699 dBm</td> <td></td> <td></td> <td></td> </tr> </tbody> </table>			MNR	MODE	TRC	SCL	F	X	FUNCTION	FUNCTION WIDTH	FUNCTION VALUE	1	N	1	f	2.483 280 GHz	-3.408 dBm				2	N	1	f	2.483 500 GHz	-55.308 dBm				3	N	1	f	2.500 000 GHz	-56.821 dBm				4	N	1	f	2.484 784 GHz	-53.699 dBm												
MNR	MODE	TRC	SCL	F	X	FUNCTION	FUNCTION WIDTH	FUNCTION VALUE																																																	
1	N	1	f	2.483 280 GHz	-3.408 dBm																																																				
2	N	1	f	2.483 500 GHz	-55.308 dBm																																																				
3	N	1	f	2.500 000 GHz	-56.821 dBm																																																				
4	N	1	f	2.484 784 GHz	-53.699 dBm																																																				

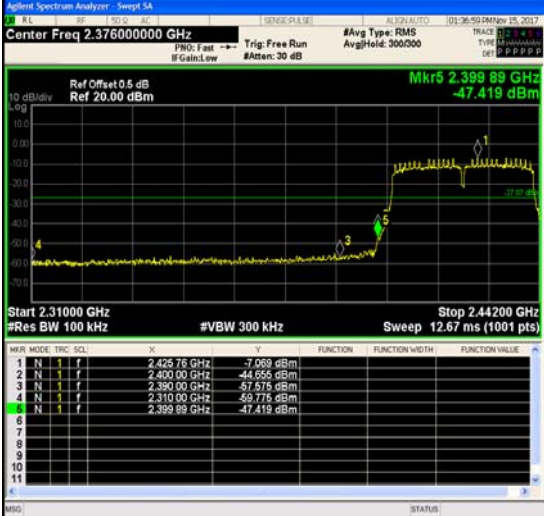
Test Item:	Bandedge	Type:	802.11 n(HT20)																																																						
CH01	 <p>Agilent Spectrum Analyzer - Sweep SA</p> <p>Center Freq 2.366000000 GHz</p> <p>Ref Offset 0.5 dB Ref 20.00 dBm</p> <p>Mkr5 2.399 94 GHz -44.471 dBm</p> <p>Start 2.31000 GHz #Res BW 100 kHz</p> <p>Stop 2.42200 GHz #VBW 300 kHz Sweep 10.73 ms (1001 pts)</p> <table border="1"> <thead> <tr> <th>MNR</th> <th>MODE</th> <th>TRC</th> <th>SCL</th> <th>F</th> <th>P</th> <th>FUNCTION</th> <th>FUNCTION WIDTH</th> <th>FUNCTION VALUE</th> </tr> </thead> <tbody> <tr> <td>1</td> <td>N</td> <td>1</td> <td>f</td> <td>2.413 28 GHz</td> <td>-3.901 dBm</td> <td></td> <td></td> <td></td> </tr> <tr> <td>2</td> <td>N</td> <td>1</td> <td>f</td> <td>2.400 00 GHz</td> <td>-43.736 dBm</td> <td></td> <td></td> <td></td> </tr> <tr> <td>3</td> <td>N</td> <td>1</td> <td>f</td> <td>2.390 00 GHz</td> <td>-57.477 dBm</td> <td></td> <td></td> <td></td> </tr> <tr> <td>4</td> <td>N</td> <td>1</td> <td>f</td> <td>2.310 00 GHz</td> <td>-61.348 dBm</td> <td></td> <td></td> <td></td> </tr> <tr> <td>5</td> <td>N</td> <td>1</td> <td>f</td> <td>2.399 94 GHz</td> <td>-44.471 dBm</td> <td></td> <td></td> <td></td> </tr> </tbody> </table>			MNR	MODE	TRC	SCL	F	P	FUNCTION	FUNCTION WIDTH	FUNCTION VALUE	1	N	1	f	2.413 28 GHz	-3.901 dBm				2	N	1	f	2.400 00 GHz	-43.736 dBm				3	N	1	f	2.390 00 GHz	-57.477 dBm				4	N	1	f	2.310 00 GHz	-61.348 dBm				5	N	1	f	2.399 94 GHz	-44.471 dBm			
MNR	MODE	TRC	SCL	F	P	FUNCTION	FUNCTION WIDTH	FUNCTION VALUE																																																	
1	N	1	f	2.413 28 GHz	-3.901 dBm																																																				
2	N	1	f	2.400 00 GHz	-43.736 dBm																																																				
3	N	1	f	2.390 00 GHz	-57.477 dBm																																																				
4	N	1	f	2.310 00 GHz	-61.348 dBm																																																				
5	N	1	f	2.399 94 GHz	-44.471 dBm																																																				
CH11	 <p>Agilent Spectrum Analyzer - Sweep SA</p> <p>Center Freq 2.476000000 GHz</p> <p>Ref Offset 0.5 dB Ref 20.00 dBm</p> <p>Mkr4 2.490 688 GHz -52.880 dBm</p> <p>Start 2.45200 GHz #Res BW 100 kHz</p> <p>Stop 2.50000 GHz #VBW 300 kHz Sweep 4.600 ms (1001 pts)</p> <table border="1"> <thead> <tr> <th>MNR</th> <th>MODE</th> <th>TRC</th> <th>SCL</th> <th>F</th> <th>P</th> <th>FUNCTION</th> <th>FUNCTION WIDTH</th> <th>FUNCTION VALUE</th> </tr> </thead> <tbody> <tr> <td>1</td> <td>N</td> <td>1</td> <td>f</td> <td>2.488 520 GHz</td> <td>-2.853 dBm</td> <td></td> <td></td> <td></td> </tr> <tr> <td>2</td> <td>N</td> <td>1</td> <td>f</td> <td>2.483 500 GHz</td> <td>-56.176 dBm</td> <td></td> <td></td> <td></td> </tr> <tr> <td>3</td> <td>N</td> <td>1</td> <td>f</td> <td>2.500 000 GHz</td> <td>-57.048 dBm</td> <td></td> <td></td> <td></td> </tr> <tr> <td>4</td> <td>N</td> <td>1</td> <td>f</td> <td>2.490 688 GHz</td> <td>-52.880 dBm</td> <td></td> <td></td> <td></td> </tr> </tbody> </table>			MNR	MODE	TRC	SCL	F	P	FUNCTION	FUNCTION WIDTH	FUNCTION VALUE	1	N	1	f	2.488 520 GHz	-2.853 dBm				2	N	1	f	2.483 500 GHz	-56.176 dBm				3	N	1	f	2.500 000 GHz	-57.048 dBm				4	N	1	f	2.490 688 GHz	-52.880 dBm												
MNR	MODE	TRC	SCL	F	P	FUNCTION	FUNCTION WIDTH	FUNCTION VALUE																																																	
1	N	1	f	2.488 520 GHz	-2.853 dBm																																																				
2	N	1	f	2.483 500 GHz	-56.176 dBm																																																				
3	N	1	f	2.500 000 GHz	-57.048 dBm																																																				
4	N	1	f	2.490 688 GHz	-52.880 dBm																																																				

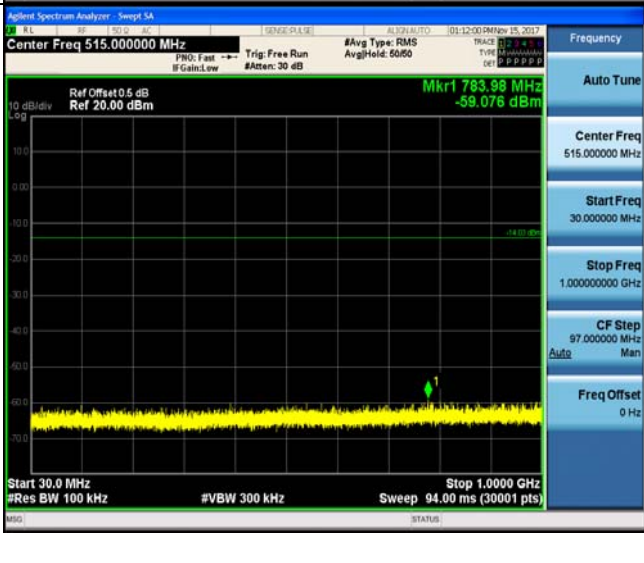
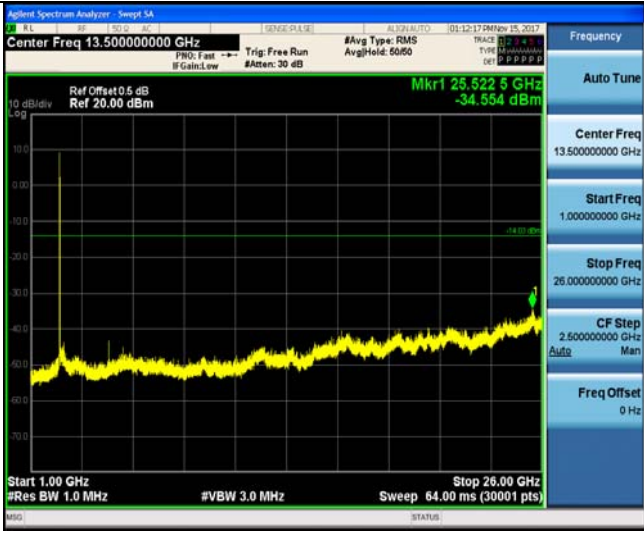

Test Item:	Bandedge	Type:	802.11 n(HT40)																																																						
CH03	 <table border="1" data-bbox="687 577 1233 712"> <thead> <tr> <th>MNR</th> <th>MODE</th> <th>TRC</th> <th>SCL</th> <th>F</th> <th>F</th> <th>FUNCTION</th> <th>FUNCTION WIDTH</th> <th>FUNCTION VALUE</th> </tr> </thead> <tbody> <tr> <td>1</td> <td>N</td> <td>1</td> <td>f</td> <td>2.425 78 GHz</td> <td>-7.909 dBm</td> <td></td> <td></td> <td></td> </tr> <tr> <td>2</td> <td>N</td> <td>1</td> <td>f</td> <td>2.400 00 GHz</td> <td>-44.555 dBm</td> <td></td> <td></td> <td></td> </tr> <tr> <td>3</td> <td>N</td> <td>1</td> <td>f</td> <td>2.390 00 GHz</td> <td>-57.575 dBm</td> <td></td> <td></td> <td></td> </tr> <tr> <td>4</td> <td>N</td> <td>1</td> <td>f</td> <td>2.310 00 GHz</td> <td>-59.775 dBm</td> <td></td> <td></td> <td></td> </tr> <tr> <td>5</td> <td>N</td> <td>1</td> <td>f</td> <td>2.399 89 GHz</td> <td>-47.419 dBm</td> <td></td> <td></td> <td></td> </tr> </tbody> </table>			MNR	MODE	TRC	SCL	F	F	FUNCTION	FUNCTION WIDTH	FUNCTION VALUE	1	N	1	f	2.425 78 GHz	-7.909 dBm				2	N	1	f	2.400 00 GHz	-44.555 dBm				3	N	1	f	2.390 00 GHz	-57.575 dBm				4	N	1	f	2.310 00 GHz	-59.775 dBm				5	N	1	f	2.399 89 GHz	-47.419 dBm			
MNR	MODE	TRC	SCL	F	F	FUNCTION	FUNCTION WIDTH	FUNCTION VALUE																																																	
1	N	1	f	2.425 78 GHz	-7.909 dBm																																																				
2	N	1	f	2.400 00 GHz	-44.555 dBm																																																				
3	N	1	f	2.390 00 GHz	-57.575 dBm																																																				
4	N	1	f	2.310 00 GHz	-59.775 dBm																																																				
5	N	1	f	2.399 89 GHz	-47.419 dBm																																																				
CH09	 <table border="1" data-bbox="687 1104 1233 1238"> <thead> <tr> <th>MNR</th> <th>MODE</th> <th>TRC</th> <th>SCL</th> <th>F</th> <th>F</th> <th>FUNCTION</th> <th>FUNCTION WIDTH</th> <th>FUNCTION VALUE</th> </tr> </thead> <tbody> <tr> <td>1</td> <td>N</td> <td>1</td> <td>f</td> <td>2.455 732 GHz</td> <td>-7.707 dBm</td> <td></td> <td></td> <td></td> </tr> <tr> <td>2</td> <td>N</td> <td>1</td> <td>f</td> <td>2.483 500 GHz</td> <td>-55.359 dBm</td> <td></td> <td></td> <td></td> </tr> <tr> <td>3</td> <td>N</td> <td>1</td> <td>f</td> <td>2.500 000 GHz</td> <td>-57.133 dBm</td> <td></td> <td></td> <td></td> </tr> <tr> <td>4</td> <td>N</td> <td>1</td> <td>f</td> <td>2.483 748 GHz</td> <td>-53.635 dBm</td> <td></td> <td></td> <td></td> </tr> </tbody> </table>			MNR	MODE	TRC	SCL	F	F	FUNCTION	FUNCTION WIDTH	FUNCTION VALUE	1	N	1	f	2.455 732 GHz	-7.707 dBm				2	N	1	f	2.483 500 GHz	-55.359 dBm				3	N	1	f	2.500 000 GHz	-57.133 dBm				4	N	1	f	2.483 748 GHz	-53.635 dBm												
MNR	MODE	TRC	SCL	F	F	FUNCTION	FUNCTION WIDTH	FUNCTION VALUE																																																	
1	N	1	f	2.455 732 GHz	-7.707 dBm																																																				
2	N	1	f	2.483 500 GHz	-55.359 dBm																																																				
3	N	1	f	2.500 000 GHz	-57.133 dBm																																																				
4	N	1	f	2.483 748 GHz	-53.635 dBm																																																				

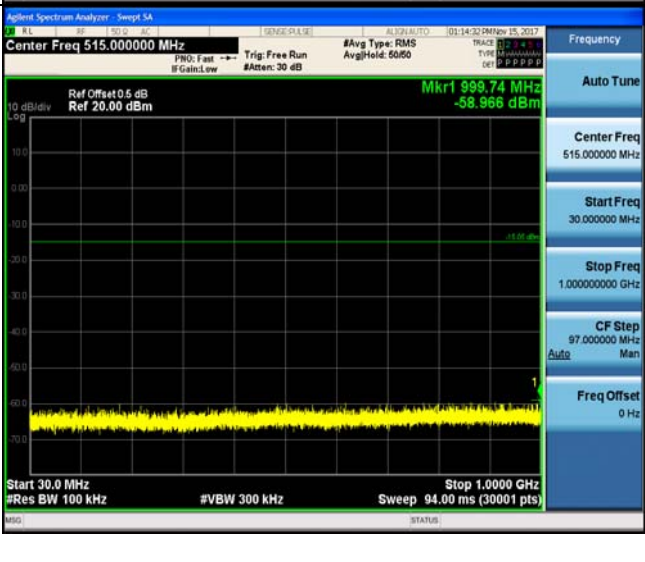
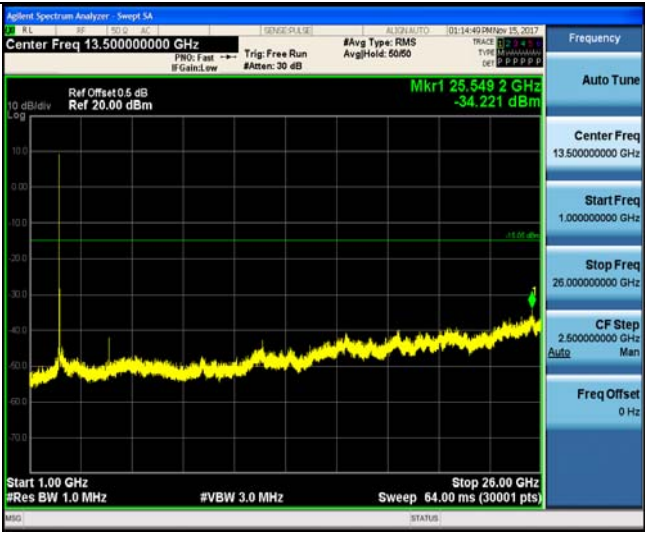
Test Item:	SE	Type:	802.11 b
Reference level CH01			<p>Frequency</p> <p>Auto Tune</p> <p>Center Freq 2.41200000 GHz</p> <p>Start Freq 2.397000000 GHz</p> <p>Stop Freq 2.427000000 GHz</p> <p>CF Step 3.000000 MHz</p> <p>Freq Offset 0 Hz</p>
CH01			<p>Frequency</p> <p>Auto Tune</p> <p>Center Freq 515.000000 MHz</p> <p>Start Freq 30.000000 MHz</p> <p>Stop Freq 1.000000000 GHz</p> <p>CF Step 97.000000 MHz</p> <p>Freq Offset 0 Hz</p>
			<p>Frequency</p> <p>Auto Tune</p> <p>Center Freq 13.50000000 GHz</p> <p>Start Freq 1.000000000 GHz</p> <p>Stop Freq 26.00000000 GHz</p> <p>CF Step 2.50000000 GHz</p> <p>Freq Offset 0 Hz</p>

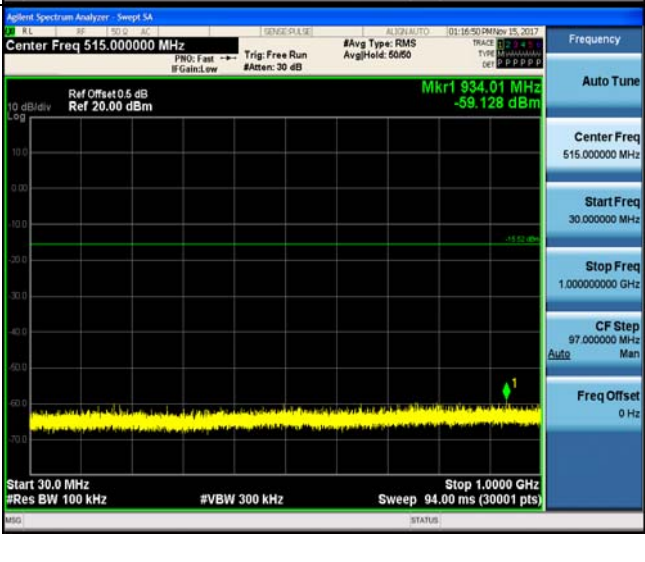
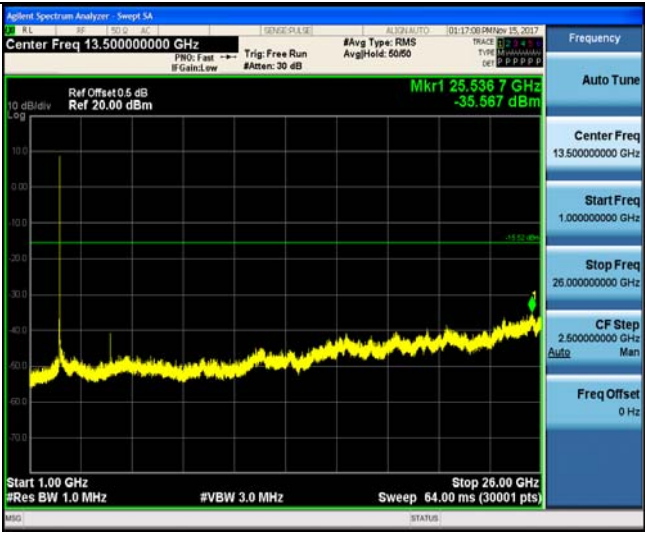
Reference level CH06	 <p>Agilent Spectrum Analyzer - Swept SA</p> <p>Center Freq 2.43700000 GHz</p> <p>Ref Offset 0.5 dB Ref 20.50 dBm</p> <p>Mkr1 2.437 51 GHz -4.948 dBm</p> <p>Center 2.43700 GHz #Res BW 100 kHz #VBW 300 kHz Span 30.00 MHz Sweep 2.933 ms (1001 pts)</p>
CH06	 <p>Agilent Spectrum Analyzer - Swept SA</p> <p>Center Freq 515.000000 MHz</p> <p>Ref Offset 0.5 dB Ref 20.00 dBm</p> <p>Mkr1 999.74 MHz -58.966 dBm</p> <p>Start 30.0 MHz #Res BW 100 kHz #VBW 300 kHz Stop 1.0000 GHz Sweep 94.00 ms (30001 pts)</p>
	 <p>Agilent Spectrum Analyzer - Swept SA</p> <p>Center Freq 13.50000000 GHz</p> <p>Ref Offset 0.5 dB Ref 20.00 dBm</p> <p>Mkr1 25.549 2 GHz -34.221 dBm</p> <p>Start 1.00 GHz #Res BW 1.0 MHz #VBW 3.0 MHz Stop 26.00 GHz Sweep 64.00 ms (30001 pts)</p>

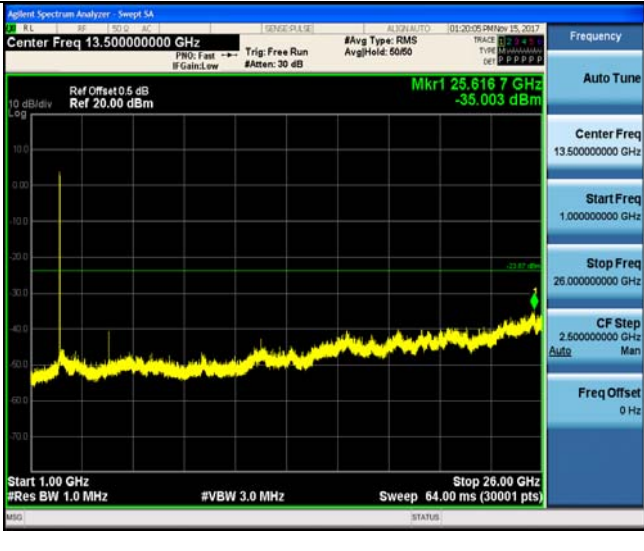
Reference level CH11	 <p>Agilent Spectrum Analyzer - Swept SA</p> <p>Center Freq 2.46200000 GHz</p> <p>Ref Offset 0.5 dB Ref 20.50 dBm</p> <p>Mkr1 2.461 52 GHz 4.482 dBm</p> <p>Center 2.46200 GHz #Res BW 100 kHz #VBW 300 kHz Span 30.00 MHz Sweep 2.933 ms (1001 pts)</p>
CH11	 <p>Agilent Spectrum Analyzer - Swept SA</p> <p>Center Freq 515.000000 MHz</p> <p>Ref Offset 0.5 dB Ref 20.00 dBm</p> <p>Mkr1 934.01 MHz -59.128 dBm</p> <p>Start 30.0 MHz #Res BW 100 kHz #VBW 300 kHz Stop 1.0000 GHz Sweep 94.00 ms (30001 pts)</p>
	 <p>Agilent Spectrum Analyzer - Swept SA</p> <p>Center Freq 13.50000000 GHz</p> <p>Ref Offset 0.5 dB Ref 20.00 dBm</p> <p>Mkr1 25.536 7 GHz -35.567 dBm</p> <p>Start 1.00 GHz #Res BW 1.0 MHz #VBW 3.0 MHz Stop 26.00 GHz Sweep 64.00 ms (30001 pts)</p>

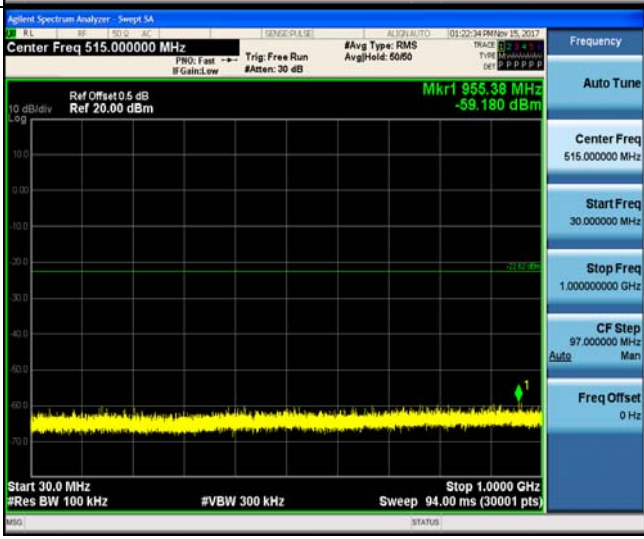
Test Item:	SE	Type:	802.11 g
Reference level CH01			
CH01			
			

<p>Reference level CH06</p>	 <p>Agilent Spectrum Analyzer - Swept SA</p> <p>Center Freq 2.43700000 GHz</p> <p>Ref Offset 0.5 dB Ref 20.50 dBm</p> <p>Mkr1 2.44327 GHz -2.624 dBm</p> <p>Center 2.43700 GHz #Res BW 100 kHz #VBW 300 kHz Span 30.00 MHz Sweep 2.933 ms (1001 pts)</p>
<p>CH06</p>	 <p>Agilent Spectrum Analyzer - Swept SA</p> <p>Center Freq 515.000000 MHz</p> <p>Ref Offset 0.5 dB Ref 20.00 dBm</p> <p>Mkr1 955.38 MHz -59.180 dBm</p> <p>Start 30.0 MHz #Res BW 100 kHz #VBW 300 kHz Stop 1.0000 GHz Sweep 94.00 ms (30001 pts)</p>
	 <p>Agilent Spectrum Analyzer - Swept SA</p> <p>Center Freq 13.50000000 GHz</p> <p>Ref Offset 0.5 dB Ref 20.00 dBm</p> <p>Mkr1 25.5508 GHz -34.471 dBm</p> <p>Start 1.00 GHz #Res BW 1.0 MHz #VBW 3.0 MHz Stop 26.00 GHz Sweep 64.00 ms (30001 pts)</p>

Reference level CH11



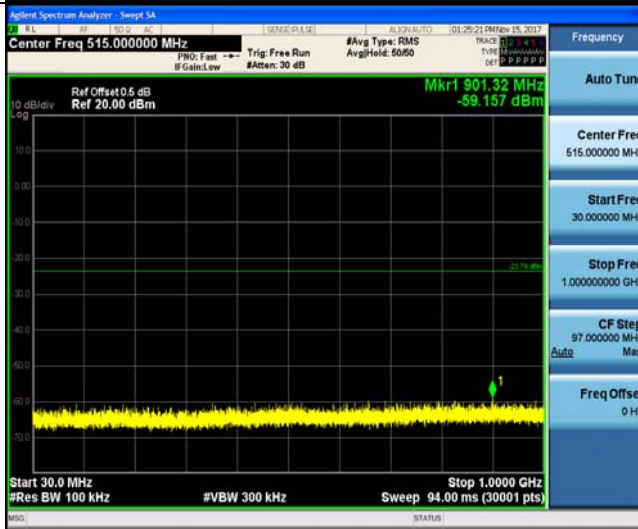

CH11



CH11

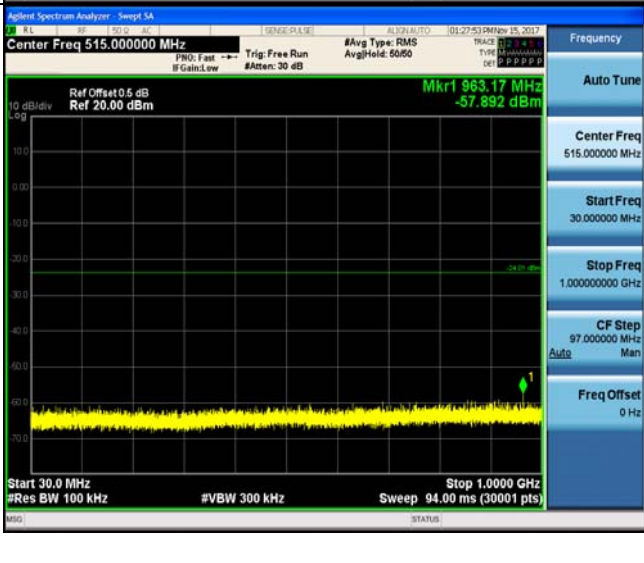
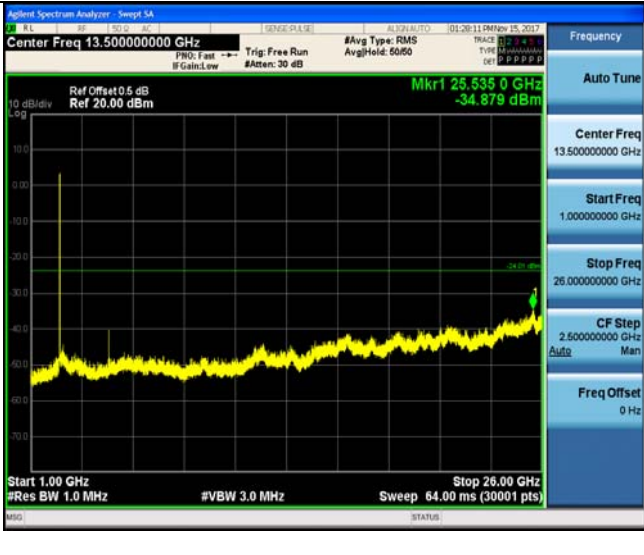

Test Item:	SE	Type:	802.11 n(HT20)
Reference level CH01			
CH01			
			

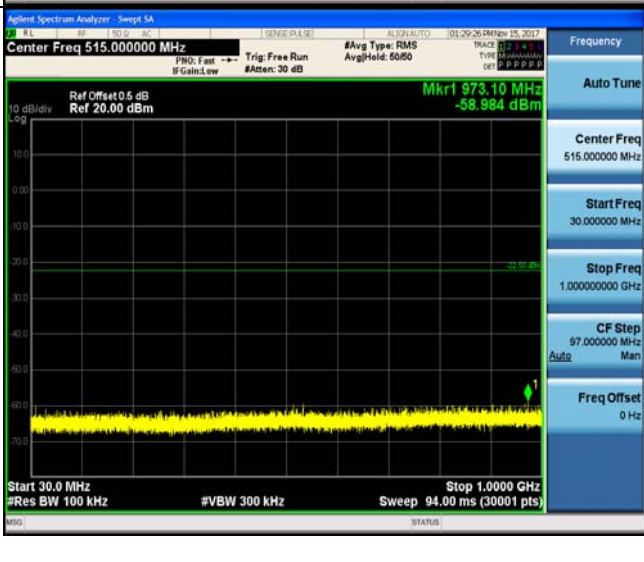
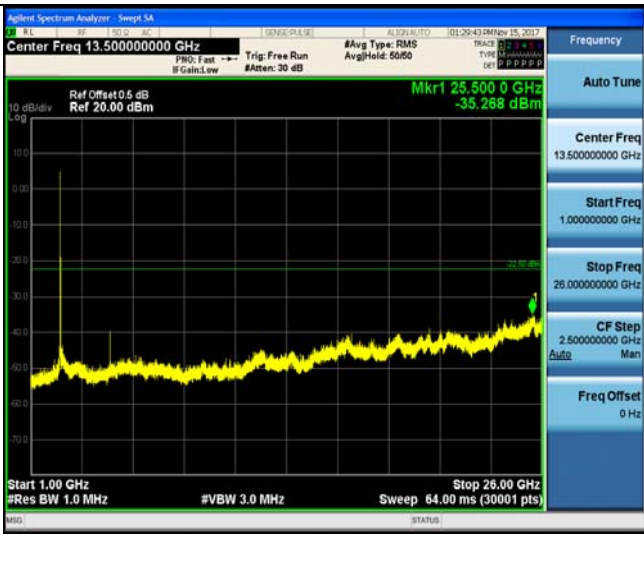
<p>Reference level CH06</p>		
<p>CH06</p>		
		

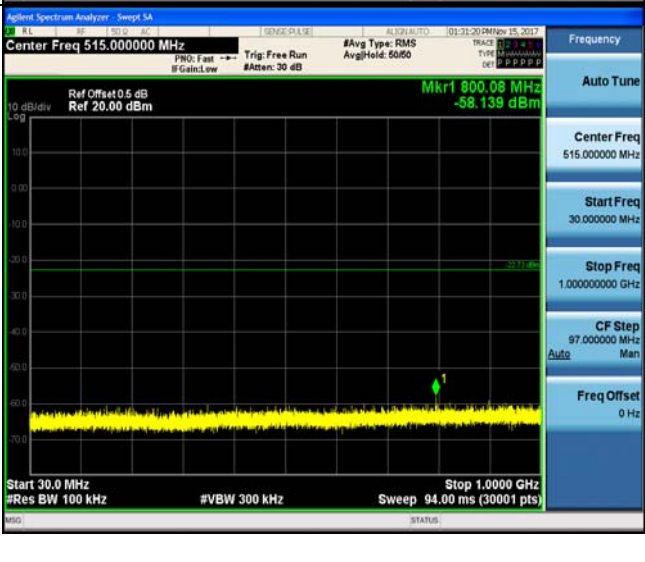
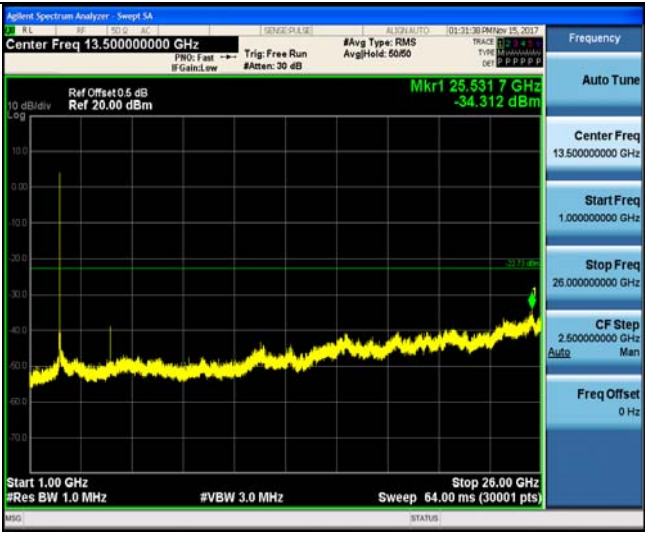
Reference level CH11		
CH11		
		

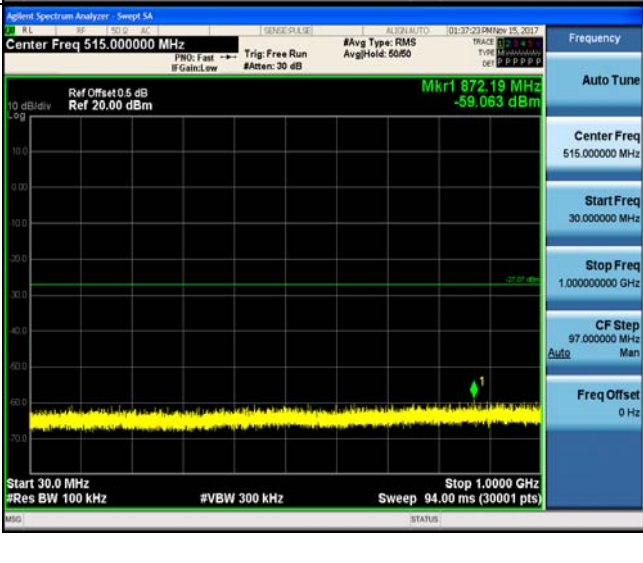
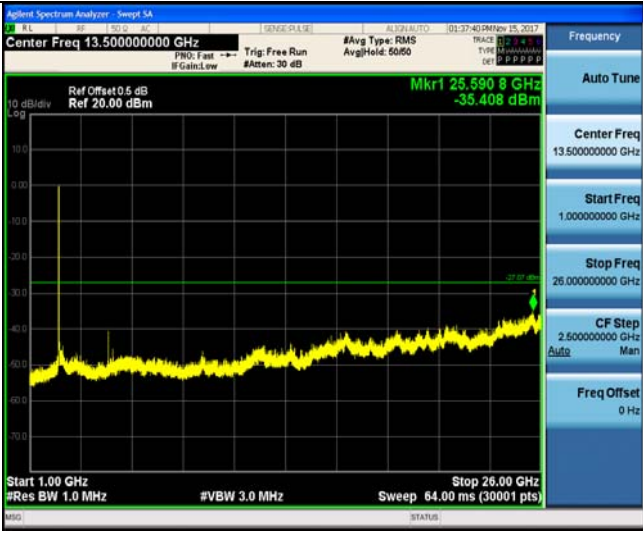
Test Item:	SE	Type:	802.11 n(HT40)
Reference level CH03			
CH03			
			

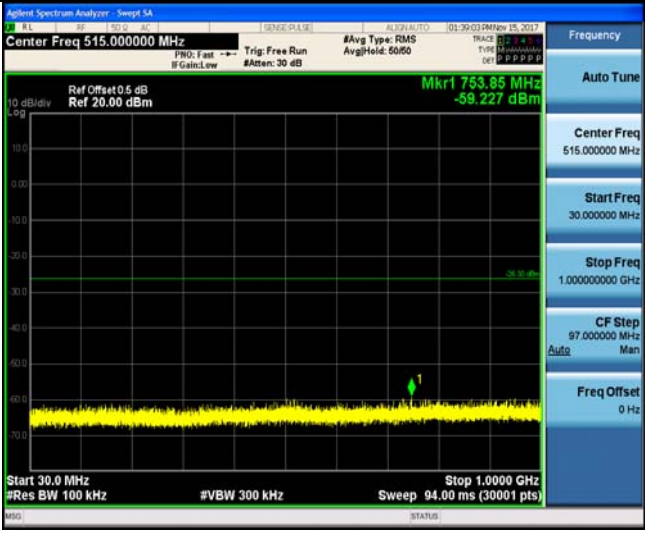
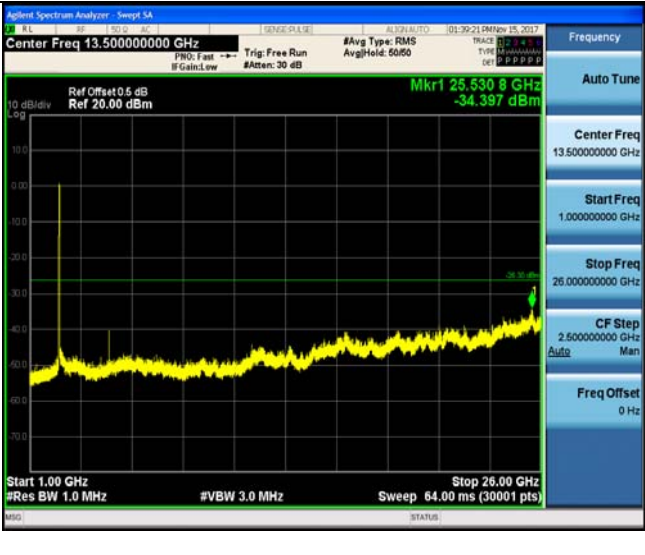
<p>Reference level CH06</p>	 <p>Agilent Spectrum Analyzer - Swept SA</p> <p>Center Freq 2.43700000 GHz</p> <p>Ref Offset 0.5 dB Ref 20.50 dBm</p> <p>Mkr1 2.448 28 GHz -6.298 dBm</p> <p>Center 2.43700 GHz #Res BW 100 kHz #VBW 300 kHz Span 60.00 MHz Sweep 5.800 ms (1001 pts)</p>
<p>CH06</p>	 <p>Agilent Spectrum Analyzer - Swept SA</p> <p>Center Freq 515.000000 MHz</p> <p>Ref Offset 0.5 dB Ref 20.00 dBm</p> <p>Mkr1 753.85 MHz -59.227 dBm</p> <p>Start 30.0 MHz #Res BW 100 kHz #VBW 300 kHz Stop 1.0000 GHz Sweep 94.00 ms (30001 pts)</p>
	 <p>Agilent Spectrum Analyzer - Swept SA</p> <p>Center Freq 13.50000000 GHz</p> <p>Ref Offset 0.5 dB Ref 20.00 dBm</p> <p>Mkr1 25.530 8 GHz -34.397 dBm</p> <p>Start 1.00 GHz #Res BW 1.0 MHz #VBW 3.0 MHz Stop 26.00 GHz Sweep 64.00 ms (30001 pts)</p>

Reference level CH09



CH09



CH09

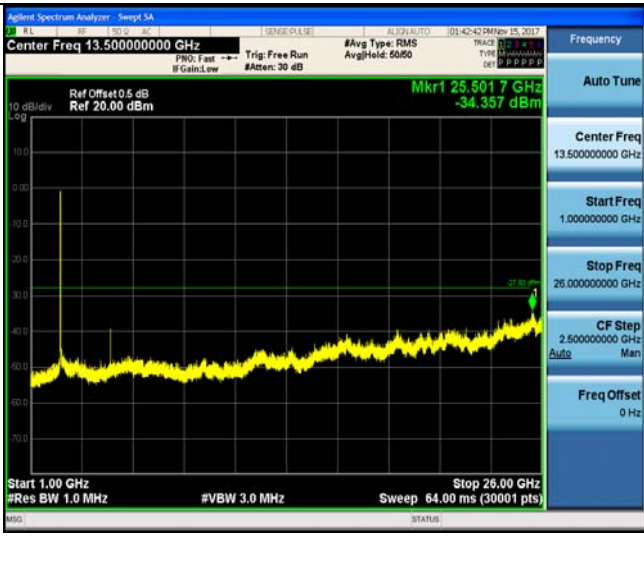

6.8. Spurious Emissions (radiated)

LIMIT

FCC CFR Title 47 Part 15 Subpart C Section 15.209

Frequency	Limit (dBuV/m @3m)	Value
30MHz-88MHz	40.00	Quasi-peak
88MHz-216MHz	43.50	Quasi-peak
216MHz-960MHz	46.00	Quasi-peak
960MHz-1GHz	54.00	Quasi-peak
Above 1GHz	54.00	Average
	74.00	Peak

TEST CONFIGURATION

➤ 9kHz ~30MHz

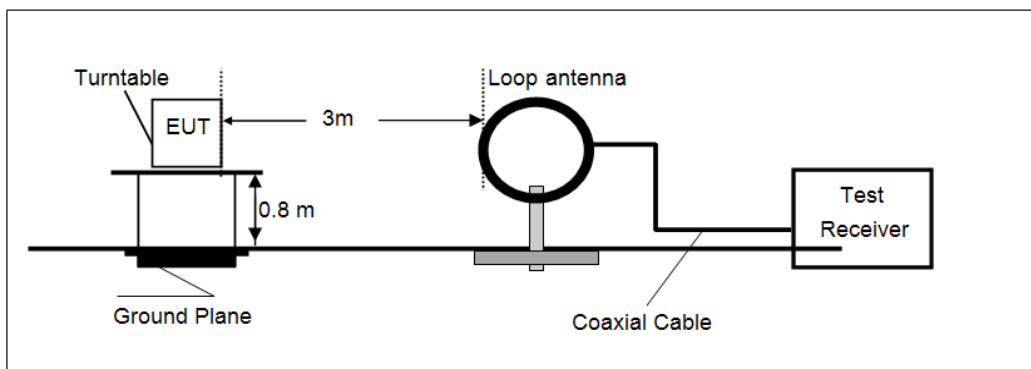

➤ 30MHz ~ 1GHz

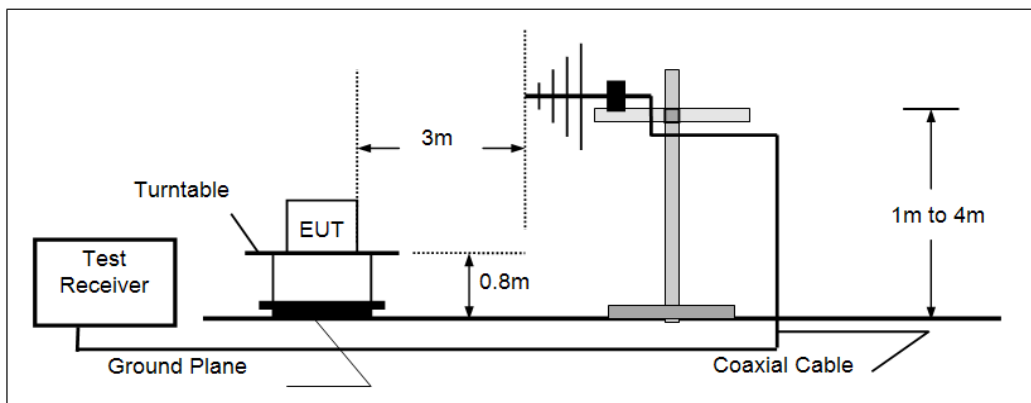

➤ Above 1GHz

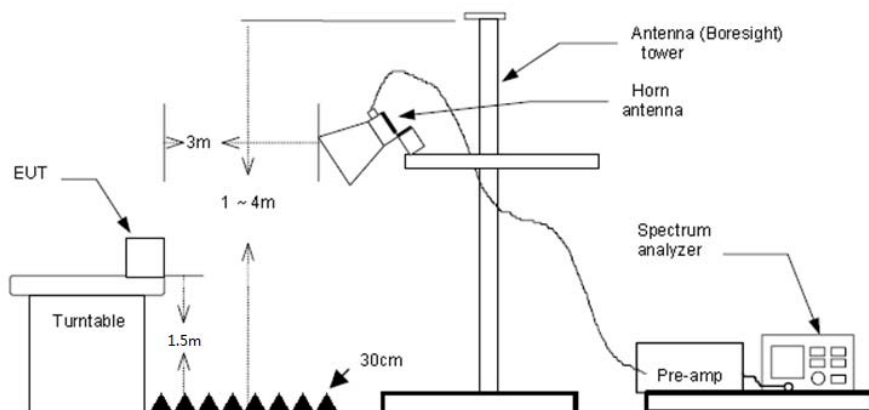

TEST PROCEDURE

1. The EUT was tested according to ANSI C63.10:2013 for compliance to FCC 47CFR 15.247 requirements.
2. The EUT is placed on a turn table which is 0.8 meter above ground. The turn table is rotated 360 degrees to determine the position of the maximum emission level.
3. The EUT was positioned such that the distance from antenna to the EUT was 3 meters.
4. The antenna is scanned from 1 meter to 4 meters to find out the maximum emission level. This is repeated for both horizontal and vertical polarization of the antenna.
5. Use the following spectrum analyzer settings
 - (1) Span shall wide enough to fully capture the emission being measured;
 - (2) Below 1GHz, RBW=120kHz, VBW=300kHz, Sweep=auto, Detector function=peak, Trace=max hold;
If the emission level of the EUT measured by the peak detector is 3 dB lower than the applicable limit, the peak emission level will be reported. Otherwise, the emission measurement will be repeated using the quasi-peak detector and reported.
 - (3) Above 1GHz, RBW=1MHz, VBW=3MHz PEAK detector for Peak value.
RBW=1MHz, VBW=3MHz RMS detector for Average value.

TEST MODE:

Please refer to the clause 3.3

TEST RESULTS

Passed **Not Applicable**

Note:

- 1) Final Level = Receiver Read level + Antenna Factor + Cable Loss – Preamplifier Factor
- 2) The emission levels of other frequencies are very lower than the limit and not show in test report.

➤ **9kHz ~ 30MHz**

The EUT was pre-scanned the frequency band (9kHz~30MHz), found the radiated level lower than the limit, so don't show on the report.

➤ **30MHz ~1000MHz**

Have pre-scan all modulation mode, found the 802.11b mode CH01 which it was worst case, so only the worst case's data on the test report.

➤ 30MHz ~ 1GHz

Polarization: Vertical

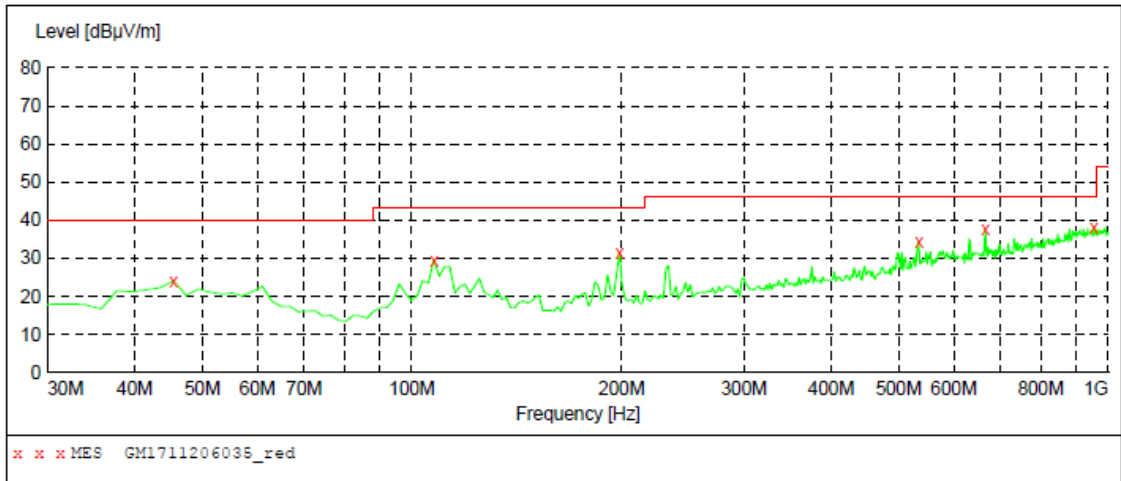

MEASUREMENT RESULT: "GM1711206035_red"

11/20/2017 1:21PM

Frequency MHz	Level dBµV/m	Transd dB	Limit dBµV/m	Margin dB	Det.	Height cm	Azimuth deg	Polarization
45.520000	24.10	-8.8	40.0	15.9	QP	100.0	131.00	VERTICAL
107.600000	29.50	-10.6	43.5	14.0	QP	100.0	301.00	VERTICAL
198.780000	31.60	-9.8	43.5	11.9	QP	100.0	289.00	VERTICAL
534.400000	34.50	-1.1	46.0	11.5	QP	100.0	119.00	VERTICAL
666.320000	37.50	1.9	46.0	8.5	QP	100.0	92.00	VERTICAL
953.440000	38.10	7.3	46.0	7.9	QP	100.0	69.00	VERTICAL

Polarization: Horizontal

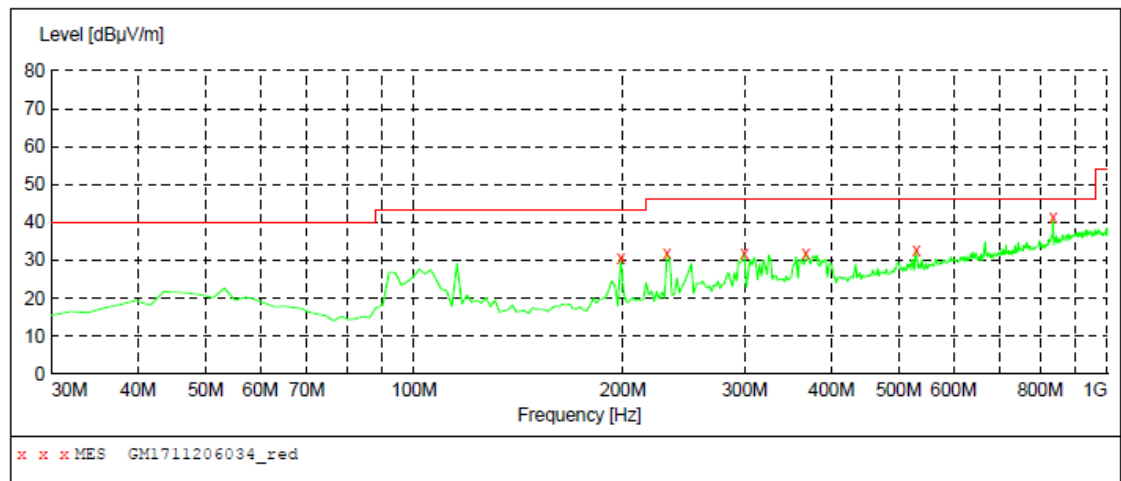

MEASUREMENT RESULT: "GM1711206034_red"

11/20/2017 1:18PM

Frequency MHz	Level dBµV/m	Transd dB	Limit dBµV/m	Margin dB	Det.	Height cm	Azimuth deg	Polarization
198.780000	30.40	-9.8	43.5	13.1	QP	100.0	44.00	HORIZONTAL
231.760000	31.90	-9.2	46.0	14.1	QP	100.0	192.00	HORIZONTAL
299.660000	32.00	-7.3	46.0	14.0	QP	100.0	205.00	HORIZONTAL
367.560000	31.90	-5.5	46.0	14.1	QP	100.0	125.00	HORIZONTAL
530.520000	32.60	-1.1	46.0	13.4	QP	100.0	181.00	HORIZONTAL
835.100000	41.30	5.1	46.0	4.7	QP	300.0	45.00	HORIZONTAL

➤ 1 GHz ~ 25 GHz

802.11b					CH01				
Frequency (MHz)	Read Level (dBuV)	Antenna Factor (dB/m)	Cable Loss (dB)	Preamp Factor (dB)	Level (dBuV/m)	Limit Line (dBuV/m)	Over Limit (dB)	Polarization	Test value
3625.67	40.86	29.30	8.30	38.26	40.20	74.00	-33.80	Vertical	Peak
3983.75	44.66	29.70	8.76	38.12	45.00	74.00	-29.00	Vertical	Peak
4821.76	43.96	31.56	9.55	36.90	48.17	74.00	-25.83	Vertical	Peak
7245.81	35.27	36.25	11.91	35.02	48.41	74.00	-25.59	Vertical	Peak
3128.01	44.77	28.80	7.63	38.21	42.99	74.00	-31.01	Horizontal	Peak
4055.37	44.92	29.81	8.82	37.98	45.57	74.00	-28.43	Horizontal	Peak
4821.76	44.91	31.56	9.55	36.90	49.12	74.00	-24.88	Horizontal	Peak
7245.81	36.14	36.25	11.91	35.02	49.28	74.00	-24.72	Horizontal	Peak

802.11b					CH06				
Frequency (MHz)	Read Level (dBuV)	Antenna Factor (dB/m)	Cable Loss (dB)	Preamp Factor (dB)	Level (dBuV/m)	Limit Line (dBuV/m)	Over Limit (dB)	Polarization	Test value
2269.73	34.64	27.92	6.56	37.54	31.58	74.00	-42.42	Vertical	Peak
2987.92	46.51	28.59	7.47	38.24	44.33	74.00	-29.67	Vertical	Peak
3644.18	47.48	29.30	8.32	38.26	46.84	74.00	-27.16	Vertical	Peak
4871.10	43.28	31.46	9.59	36.76	47.57	74.00	-26.43	Vertical	Peak
3216.84	42.36	28.70	7.74	38.23	40.57	74.00	-33.43	Horizontal	Peak
3498.74	48.77	28.99	8.11	38.41	47.46	74.00	-26.54	Horizontal	Peak
3738.13	46.25	29.42	8.43	38.24	45.86	74.00	-28.14	Horizontal	Peak
4871.10	38.74	31.46	9.59	36.76	43.03	74.00	-30.97	Horizontal	Peak

802.11b					CH11				
Frequency (MHz)	Read Level (dBuV)	Antenna Factor (dB/m)	Cable Loss (dB)	Preamp Factor (dB)	Level (dBuV/m)	Limit Line (dBuV/m)	Over Limit (dB)	Polarization	Test value
2146.12	36.12	27.07	6.39	37.33	32.25	74.00	-41.75	Vertical	Peak
3738.13	48.42	29.42	8.43	38.24	48.03	74.00	-25.97	Vertical	Peak
4920.96	40.90	31.42	9.62	36.62	45.32	74.00	-28.68	Vertical	Peak
6001.77	40.30	32.50	10.67	35.45	48.02	74.00	-25.98	Vertical	Peak
2987.92	39.43	28.59	7.47	38.24	37.25	74.00	-36.75	Horizontal	Peak
3644.18	45.28	29.30	8.32	38.26	44.64	74.00	-29.36	Horizontal	Peak
4983.99	42.59	31.48	9.66	36.44	47.29	74.00	-26.71	Horizontal	Peak
7508.69	34.81	36.11	12.42	34.91	48.43	74.00	-25.57	Horizontal	Peak

Remark:

1. Final Level = Receiver Read level + Antenna Factor + Cable Loss – Pre-amplifier Factor
2. The peak level is lower than average limit(54 dBuV/m), this data is the too weak instrument of signal is unable to test.
3. The emission levels of other frequencies(test frequency band is 1GHz to 25GHz) are very lower than the limit and not show in test report.

802.11g					CH01				
Frequency (MHz)	Read Level (dBuV)	Antenna Factor (dB/m)	Cable Loss (dB)	Preamp Factor (dB)	Level (dBuV/m)	Limit Line (dBuV/m)	Over Limit (dB)	Polarization	Test value
1764.12	37.05	25.33	5.89	37.06	31.21	74.00	-42.79	Vertical	Peak
3498.74	49.54	28.99	8.11	38.41	48.23	74.00	-25.77	Vertical	Peak
4821.76	44.39	31.56	9.55	36.90	48.60	74.00	-25.40	Vertical	Peak
6251.26	37.34	33.00	11.00	35.30	46.04	74.00	-27.96	Vertical	Peak
3489.84	44.02	28.92	8.10	38.42	42.62	74.00	-31.38	Horizontal	Peak
4821.76	41.26	31.56	9.55	36.90	45.47	74.00	-28.53	Horizontal	Peak
6001.77	40.28	32.50	10.67	35.45	48.00	74.00	-26.00	Horizontal	Peak
7245.81	35.29	36.25	11.91	35.02	48.43	74.00	-25.57	Horizontal	Peak

802.11g					CH06				
Frequency (MHz)	Read Level (dBuV)	Antenna Factor (dB/m)	Cable Loss (dB)	Preamp Factor (dB)	Level (dBuV/m)	Limit Line (dBuV/m)	Over Limit (dB)	Polarization	Test value
1689.41	36.23	25.17	5.74	36.91	30.23	74.00	-43.77	Vertical	Peak
3241.50	48.82	28.55	7.77	38.27	46.87	74.00	-27.13	Vertical	Peak
4883.52	44.25	31.43	9.59	36.73	48.54	74.00	-25.46	Vertical	Peak
5986.51	40.02	32.47	10.66	35.44	47.71	74.00	-26.29	Vertical	Peak
1948.25	37.12	25.79	6.19	37.26	31.84	74.00	-42.16	Horizontal	Peak
3241.50	49.02	28.55	7.77	38.27	47.07	74.00	-26.93	Horizontal	Peak
4871.10	44.73	31.46	9.59	36.76	49.02	74.00	-24.98	Horizontal	Peak
6235.36	39.45	32.97	11.01	35.29	48.14	74.00	-25.86	Horizontal	Peak

802.11g					CH11				
Frequency (MHz)	Read Level (dBuV)	Antenna Factor (dB/m)	Cable Loss (dB)	Preamp Factor (dB)	Level (dBuV/m)	Limit Line (dBuV/m)	Over Limit (dB)	Polarization	Test value
2987.92	47.76	28.59	7.47	38.24	45.58	74.00	-28.42	Vertical	Peak
4245.51	44.47	30.09	8.98	37.63	45.91	74.00	-28.09	Vertical	Peak
4933.50	43.29	31.43	9.63	36.59	47.76	74.00	-26.24	Vertical	Peak
7413.73	34.39	36.27	12.11	34.83	47.94	74.00	-26.06	Vertical	Peak
3241.50	46.30	28.55	7.77	38.27	44.35	74.00	-29.65	Horizontal	Peak
3728.63	48.61	29.39	8.42	38.24	48.18	74.00	-25.82	Horizontal	Peak
4933.50	43.19	31.43	9.63	36.59	47.66	74.00	-26.34	Horizontal	Peak
6219.51	38.61	32.94	11.01	35.29	47.27	74.00	-26.73	Horizontal	Peak

Remark:

1. Final Level = Receiver Read level + Antenna Factor + Cable Loss – Pre-amplifier Factor
2. The peak level is lower than average limit (54 dBuV/m), this data is too weak; instrument of signal is unable to test.
3. The emission levels of other frequencies (test frequency band is 1GHz to 25GHz) are very lower than the limit and not show in test report.

802.11n(HT20)					CH01				
Frequency (MHz)	Read Level (dBuV)	Antenna Factor (dB/m)	Cable Loss (dB)	Preamp Factor (dB)	Level (dBuV/m)	Limit Line (dBuV/m)	Over Limit (dB)	Polarization	Test value
3489.84	50.22	28.92	8.10	38.42	48.82	74.00	-25.18	Vertical	Peak
3983.75	46.81	29.70	8.76	38.12	47.15	74.00	-26.85	Vertical	Peak
4821.76	41.39	31.56	9.55	36.90	45.60	74.00	-28.40	Vertical	Peak
6235.36	40.10	32.97	11.01	35.29	48.79	74.00	-25.21	Vertical	Peak
3738.13	48.83	29.42	8.43	38.24	48.44	74.00	-25.56	Horizontal	Peak
4996.69	41.09	31.50	9.67	36.41	45.85	74.00	-28.15	Horizontal	Peak
5986.51	38.64	32.47	10.66	35.44	46.33	74.00	-27.67	Horizontal	Peak
7508.69	35.10	36.11	12.42	34.91	48.72	74.00	-25.28	Horizontal	Peak

802.11n(HT20)					CH06				
Frequency (MHz)	Read Level (dBuV)	Antenna Factor (dB/m)	Cable Loss (dB)	Preamp Factor (dB)	Level (dBuV/m)	Limit Line (dBuV/m)	Over Limit (dB)	Polarization	Test value
3241.50	49.67	28.55	7.77	38.27	47.72	74.00	-26.28	Vertical	Peak
4455.89	42.37	30.61	9.22	37.47	44.73	74.00	-29.27	Vertical	Peak
4983.99	42.09	31.48	9.66	36.44	46.79	74.00	-27.21	Vertical	Peak
7489.60	36.80	36.12	12.36	34.89	50.39	74.00	-23.61	Vertical	Peak
3498.74	50.60	28.99	8.11	38.41	49.29	74.00	-24.71	Horizontal	Peak
3738.13	48.99	29.42	8.43	38.24	48.60	74.00	-25.40	Horizontal	Peak
4871.10	40.50	31.46	9.59	36.76	44.79	74.00	-29.21	Horizontal	Peak
6235.36	39.99	32.97	11.01	35.29	48.68	74.00	-25.32	Horizontal	Peak

802.11n(HT20)					CH11				
Frequency (MHz)	Read Level (dBuV)	Antenna Factor (dB/m)	Cable Loss (dB)	Preamp Factor (dB)	Level (dBuV/m)	Limit Line (dBuV/m)	Over Limit (dB)	Polarization	Test value
2987.92	47.38	28.59	7.47	38.24	45.20	74.00	-28.80	Vertical	Peak
3983.75	48.47	29.70	8.76	38.12	48.81	74.00	-25.19	Vertical	Peak
4908.44	44.51	31.41	9.61	36.66	48.87	74.00	-25.13	Vertical	Peak
6235.36	40.28	32.97	11.01	35.29	48.97	74.00	-25.03	Vertical	Peak
2456.10	42.57	27.37	6.81	37.88	38.87	74.00	-35.13	Horizontal	Peak
3472.12	50.42	28.78	8.07	38.45	48.82	74.00	-25.18	Horizontal	Peak
4933.50	45.28	31.43	9.63	36.59	49.75	74.00	-24.25	Horizontal	Peak
6235.36	40.53	32.97	11.01	35.29	49.22	74.00	-24.78	Horizontal	Peak

Remark:

1. Final Level = Receiver Read level + Antenna Factor + Cable Loss – Preamplifier Factor
2. The peak level is lower than average limit(54 dBuV/m), this data is the too weak instrument of signal is unable to test.
3. The emission levels of other frequencies(test frequency band is 1GHz to 25GHz) are very lower than the limit and not show in test report.

802.11n(HT40)					CH03				
Frequency (MHz)	Read Level (dBuV)	Antenna Factor (dB/m)	Cable Loss (dB)	Preamp Factor (dB)	Level (dBuV/m)	Limit Line (dBuV/m)	Over Limit (dB)	Polarization	Test value
2987.92	48.11	28.59	7.47	38.24	45.93	74.00	-28.07	Vertical	Peak
3973.62	48.74	29.70	8.74	38.13	49.05	74.00	-24.95	Vertical	Peak
4908.44	42.99	31.41	9.61	36.66	47.35	74.00	-26.65	Vertical	Peak
5971.29	40.52	32.44	10.66	35.43	48.19	74.00	-25.81	Vertical	Peak
3241.50	46.62	28.55	7.77	38.27	44.67	74.00	-29.33	Horizontal	Peak
3747.66	49.90	29.44	8.44	38.24	49.54	74.00	-24.46	Horizontal	Peak
5971.29	41.29	32.44	10.66	35.43	48.96	74.00	-25.04	Horizontal	Peak
7508.69	34.72	36.11	12.42	34.91	48.34	74.00	-25.66	Horizontal	Peak

802.11n(HT40)					CH06				
Frequency (MHz)	Read Level (dBuV)	Antenna Factor (dB/m)	Cable Loss (dB)	Preamp Factor (dB)	Level (dBuV/m)	Limit Line (dBuV/m)	Over Limit (dB)	Polarization	Test value
3480.97	49.91	28.85	8.09	38.44	48.41	74.00	-25.59	Vertical	Peak
3983.75	46.70	29.70	8.76	38.12	47.04	74.00	-26.96	Vertical	Peak
4871.10	41.18	31.46	9.59	36.76	45.47	74.00	-28.53	Vertical	Peak
6235.36	39.49	32.97	11.01	35.29	48.18	74.00	-25.82	Vertical	Peak
3241.50	50.75	28.55	7.77	38.27	48.80	74.00	-25.20	Horizontal	Peak
3738.13	48.59	29.42	8.43	38.24	48.20	74.00	-25.80	Horizontal	Peak
4996.69	44.12	31.50	9.67	36.41	48.88	74.00	-25.12	Horizontal	Peak
7489.60	35.13	36.12	12.36	34.89	48.72	74.00	-25.28	Horizontal	Peak

802.11n(HT40)					CH09				
Frequency (MHz)	Read Level (dBuV)	Antenna Factor (dB/m)	Cable Loss (dB)	Preamp Factor (dB)	Level (dBuV/m)	Limit Line (dBuV/m)	Over Limit (dB)	Polarization	Test value
3480.97	49.15	28.85	8.09	38.44	47.65	74.00	-26.35	Vertical	Peak
3993.90	48.32	29.70	8.77	38.11	48.68	74.00	-25.32	Vertical	Peak
4920.96	44.51	31.42	9.62	36.62	48.93	74.00	-25.07	Vertical	Peak
7357.33	34.83	36.30	12.03	34.88	48.28	74.00	-25.72	Vertical	Peak
3489.84	49.39	28.92	8.10	38.42	47.99	74.00	-26.01	Horizontal	Peak
3738.13	49.03	29.42	8.43	38.24	48.64	74.00	-25.36	Horizontal	Peak
4895.97	44.23	31.41	9.60	36.69	48.55	74.00	-25.45	Horizontal	Peak
6001.77	40.89	32.50	10.67	35.45	48.61	74.00	-25.39	Horizontal	Peak

Remark:

1. Final Level = Receiver Read level + Antenna Factor + Cable Loss – Preamplifier Factor
2. The peak level is lower than average limit(54 dBuV/m), this data is the too weak instrument of signal is unable to test.
3. The emission levels of other frequencies(test frequency band is 1GHz to 25GHz) are very lower than the limit and not show in test report.

7. TEST SETUP PHOTOS

Conducted Emissions

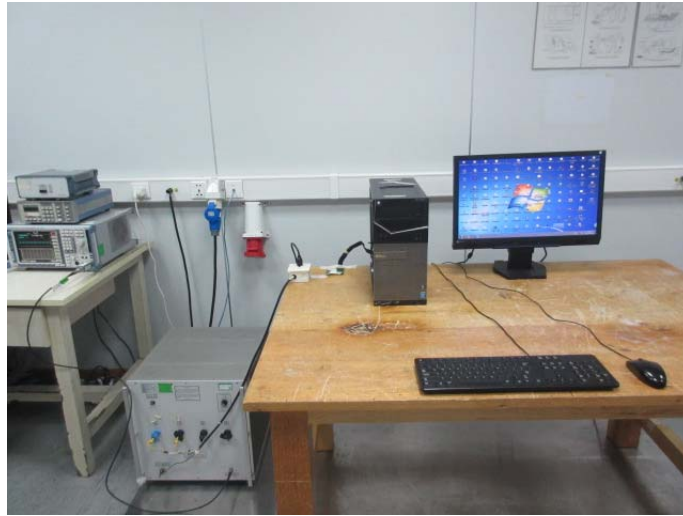

Radiated Emissions



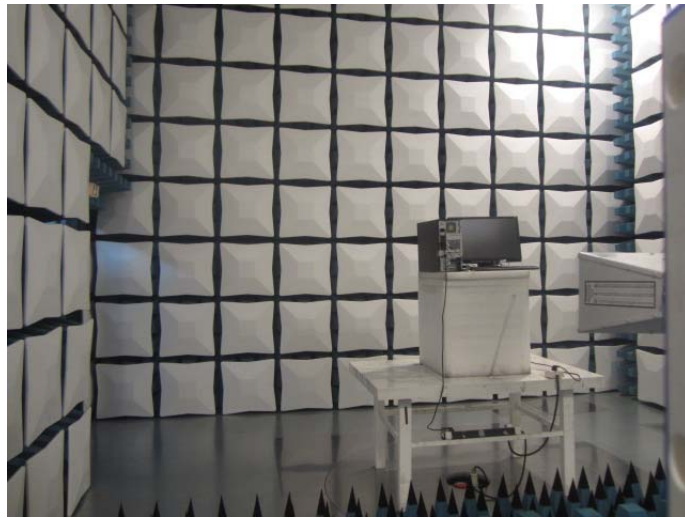

8. EXTERNAL AND INTERNAL PHOTOS

External photos of the EUT

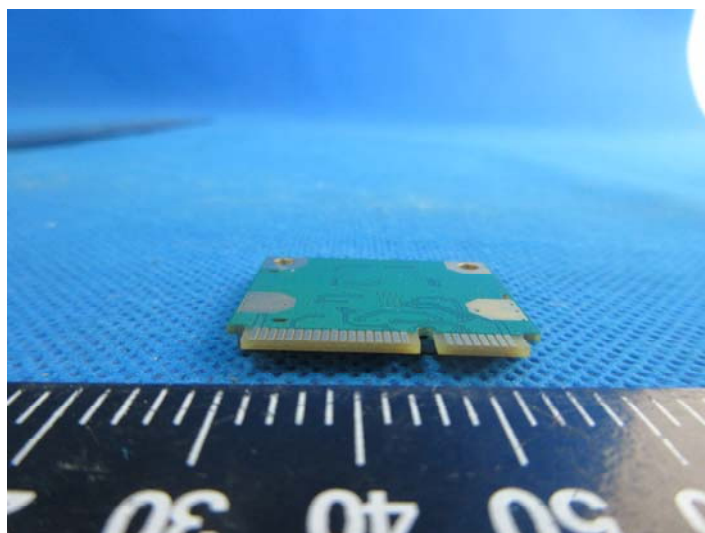
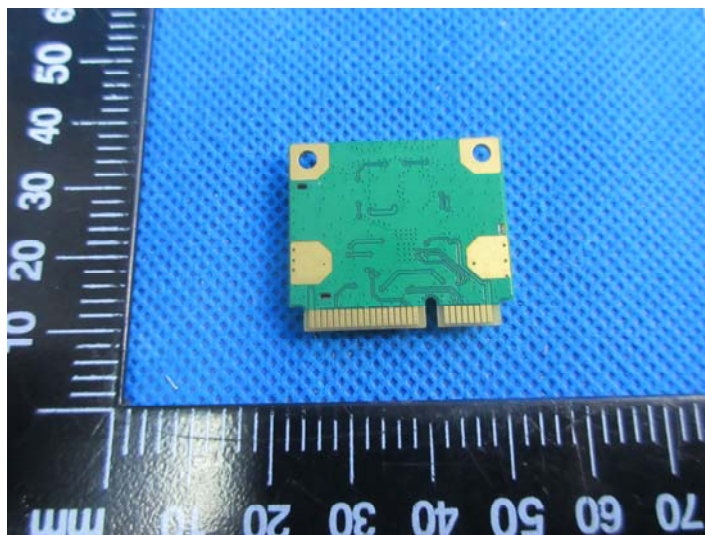
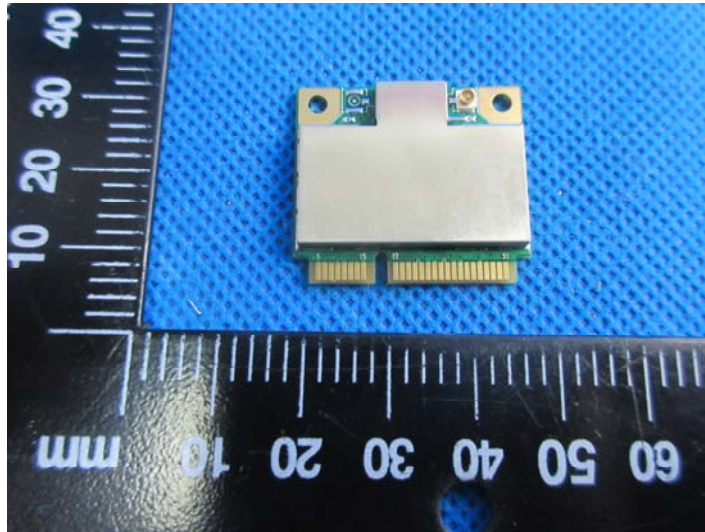

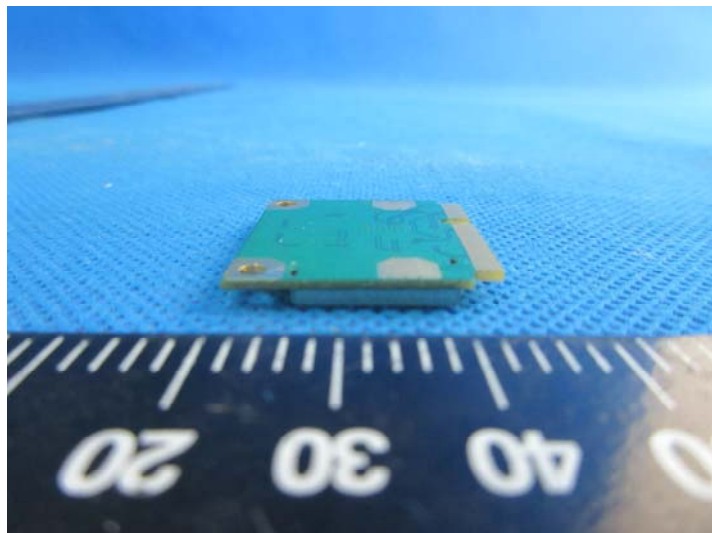
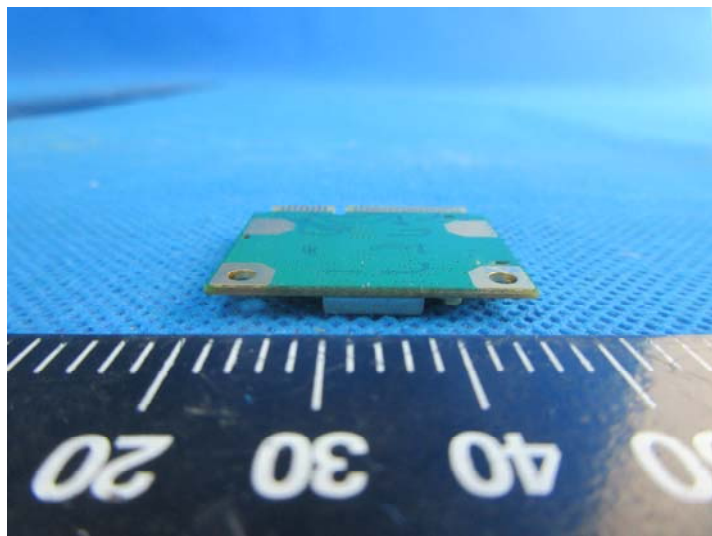
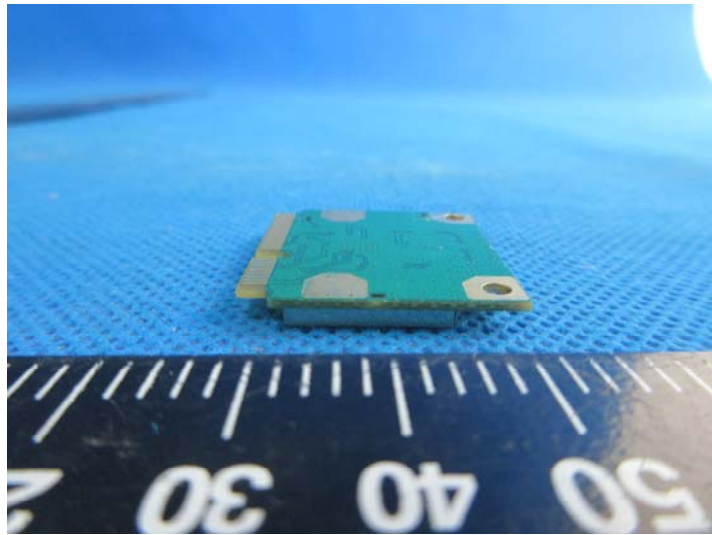

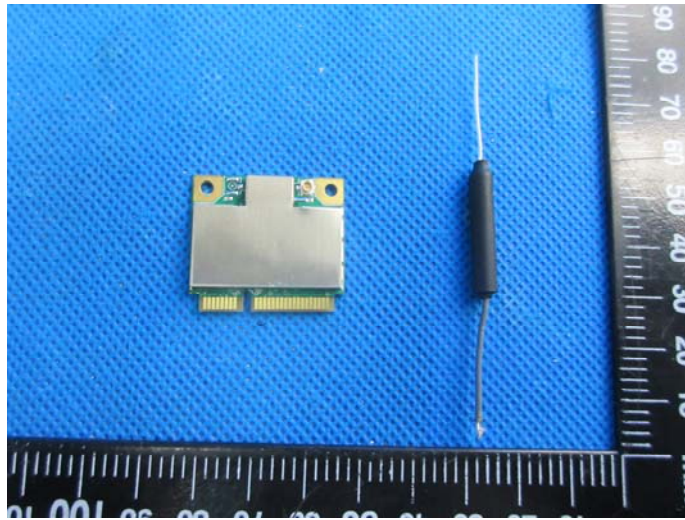

Internal photos of the EUT

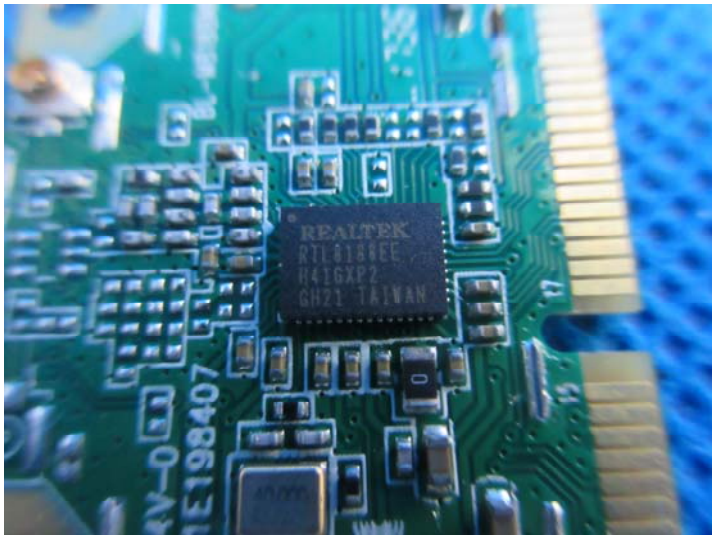
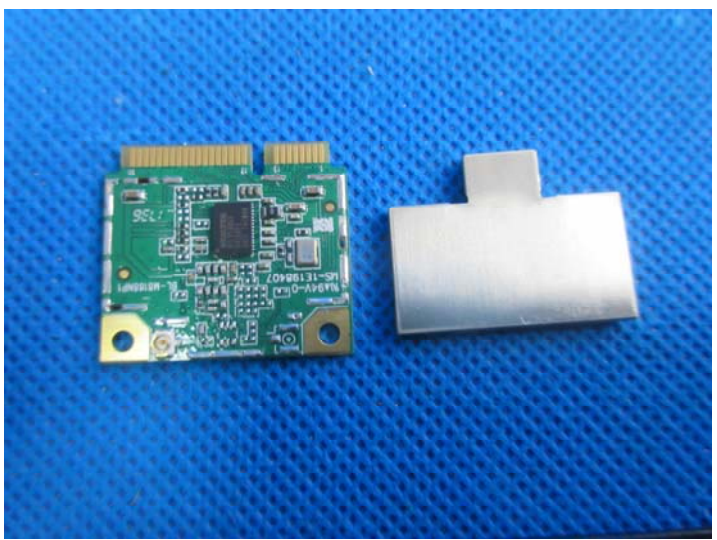
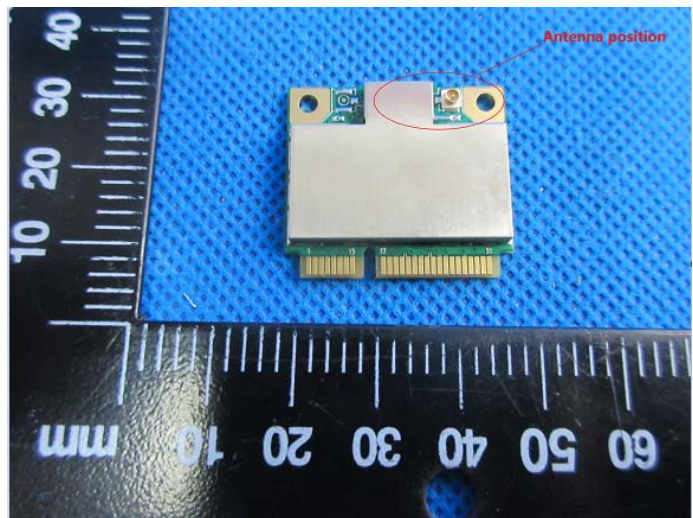

.....End of Report.....