

FCC Radio Test Report

FCC ID: 2AL64-WESTGATE

Original Grant

Report No. : TB-FCC153920
Applicant : Shenzhen qiuyu Electronic Co.,Ltd
Equipment Under Test (EUT)
EUT Name : Tablet PC
Model No. : PTV-R78-3288
Series Model No. : Westgate Owner Tablet
Brand Name : Westgate Owner
Receipt Date : 2017-05-12
Test Date : 2017-05-13 to 2017-05-18
Issue Date : 2017-05-19
Standards : FCC Part 15, Subpart C (15.247:2016)
Test Method : ANSI C63.10: 2013
Conclusions : **PASS**

In the configuration tested, the EUT complied with the standards specified above,
The EUT technically complies with the FCC and IC requirements

Test/Witness Engineer : Terry.Su

**Approved &
Authorized**

: 

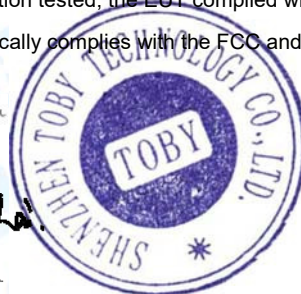

This report details the results of the testing carried out on one sample. The results contained in this test report do not relate to other samples of the same product. The manufacturer should ensure that all products in series production are in conformity with the product sample detailed in the report.

Contents

CONTENTS	2
1. GENERAL INFORMATION ABOUT EUT	4
1.1 Client Information.....	4
1.2 General Description of EUT (Equipment Under Test)	4
1.3 Block Diagram Showing the Configuration of System Tested.....	5
1.4 Description of Support Units	5
1.5 Description of Test Mode.....	6
1.6 Description of Test Software Setting	7
1.7 Measurement Uncertainty	7
1.8 Test Facility.....	8
2. TEST SUMMARY	9
3. TEST EQUIPMENT	10
4. CONDUCTED EMISSION TEST	11
4.1 Test Standard and Limit.....	11
4.2 Test Setup.....	11
4.3 Test Procedure.....	11
4.4 EUT Operating Mode	12
4.5 Test Data.....	12
5. RADIATED EMISSION TEST	17
5.1 Test Standard and Limit.....	17
5.2 Test Setup.....	18
5.3 Test Procedure.....	19
5.4 EUT Operating Condition	19
5.5 Test Data.....	20
6. RESTRICTED BANDS REQUIREMENT	47
6.1 Test Standard and Limit.....	47
6.2 Test Setup.....	47
6.3 Test Procedure.....	47
6.4 EUT Operating Condition	48
6.5 Test Data.....	48
7. BANDWIDTH TEST	69
7.1 Test Standard and Limit.....	69
7.2 Test Setup.....	69
7.3 Test Procedure.....	69
7.4 EUT Operating Condition	69
7.5 Test Data.....	70
8. PEAK OUTPUT POWER TEST	78
8.1 Test Standard and Limit.....	78
8.2 Test Setup.....	78

8.3 Test Procedure.....	78
8.4 EUT Operating Condition	78
8.5 Test Data.....	79
9. POWER SPECTRAL DENSITY TEST	82
9.1 Test Standard and Limit.....	82
9.2 Test Setup.....	82
9.3 Test Procedure.....	82
9.4 EUT Operating Condition	82
9.5 Test Data.....	83
10. ANTENNA REQUIREMENT.....	91
10.1 Standard Requirement.....	91
10.2 Antenna Connected Construction.....	91

1. General Information about EUT

1.1 Client Information

Applicant : Shenzhen qiuyu Electronic Co.,Ltd
Address : 3F, E Building, Hongzhuyongqi Industrial Park, Lezhujiao village, xixiang town, Bao' an District, Shenzhen, China
Manufacturer : Shenzhen qiuyu Electronic Co.,Ltd
Address : 3F, E Building, Hongzhuyongqi Industrial Park, Lezhujiao village, xixiang town, Bao' an District, Shenzhen, China

1.2 General Description of EUT (Equipment Under Test)

EUT Name	:	Tablet PC	
Models No.	:	PTV-R78-3288, Westgate Owner Tablet	
Model Difference	:	All these models are identical in the same PCB layout and electrical circuit, the only difference is model name for commercial.	
Product Description	:	Operation Frequency:	802.11b/g/n(HT20): 2412MHz~2462MHz 802.11n(HT40): 2422MHz~2452MHz
	:	Number of Channel:	802.11b/g/n(HT20):11 channels <i>see note(3)</i> 802.11n(HT40):9 channels <i>see note(3)</i>
	:	RF Output Power:	802.11b: 8.47 dBm 802.11g: 8.96 dBm 802.11n (HT20): 8.91 dBm 802.11n (HT40): 8.41 dBm
	:	Antenna Gain:	1.4 dBi Integral Antenna
	:	Modulation Type:	802.11b: DSSS(CCK, DQPSK, DBPSK) 802.11g/n:OFDM(BPSK,QPSK,16QAM, 64QAM)
	:	Bit Rate of Transmitter:	802.11b:11/5.5/2/1 Mbps 802.11g:54/48/36/24/18/12/9/6 Mbps 802.11n:up to 150Mbps
	Power Supply	:	DC Voltage supplied by AC/DC Adapter DC Voltage supplied by Li-ion battery
Power Rating	:	AC/DC Adapter (K-T100502000U): Input: AC 100~240V, 50/60Hz, 0.35A. Output: DC 5V, 2.0A. DC 3.7V by 3500mAh Li-ion battery.	
Connecting I/O Port(S)	:	Please refer to the User's Manual	

Note:

(1) This Test Report is FCC Part 15.247 for 802.11b/g/n, the test procedure follows the FCC

KDB 558074 D01 DTS Meas Guidance v04.

(2) For a more detailed features description, please refer to the manufacturer’s specifications or the User’s Manual.

(3) Channel List:

Channel	Frequency (MHz)	Channel	Frequency (MHz)	Channel	Frequency (MHz)
01	2412	05	2432	09	2452
02	2417	06	2437	10	2457
03	2422	07	2442	11	2462
04	2427	08	2447		

Note:CH 01~CH 11 for 802.11b/g/n(HT20), CH 03~CH 09 for 802.11n(HT40)

(4) The Antenna information about the equipment is provided by the applicant.

1.3 Block Diagram Showing the Configuration of System Tested

USB Charging Mode

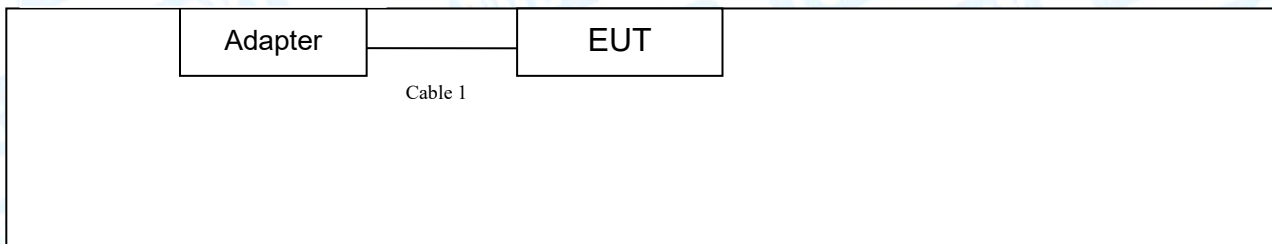

TX Mode

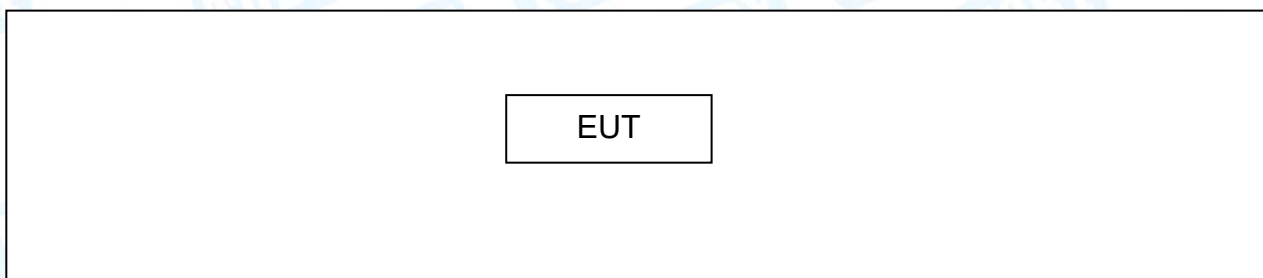

1.4 Description of Support Units

Equipment Information				
Name	Model	FCC ID/VOC	Manufacturer	Used “√”
Cable Information				
Number	Shielded Type	Ferrite Core	Length	Note
Cable 1	YES	NO	1.0M	

1.5 Description of Test Mode

To investigate the maximum EMI emission characteristics generates from EUT, the test system was pre-scanning tested base on the consideration of following EUT operation mode or test configuration mode which possible have effect on EMI emission level. Each of these EUT operation mode(s) or test configuration mode(s) mentioned follow was evaluated respectively.

For Conducted Test	
Final Test Mode	Description
Mode 1	USB Charging with TX B Mode

For Radiated Test	
Final Test Mode	Description
Mode 2	TX Mode B Mode Channel 01/06/11
Mode 3	TX Mode G Mode Channel 01/06/11
Mode 4	TX Mode N(HT20) Mode Channel 01/06/11
Mode 5	TX Mode N(HT40) Mode Channel 03/06/09

Note:

- (1) For all test, we have verified the construction and function in typical operation. And all the test modes were carried out with the EUT in transmitting operation in maximum power with all kinds of data rate.
According to ANSI C63.10 standards, the measurements are performed at the highest, Middle, lowest available channels, and the worst case data rate as follows:
 - 802.11b Mode: CCK (1 Mbps)
 - 802.11g Mode: OFDM (6 Mbps)
 - 802.11n (HT20) Mode: MCS 0 (6.5 Mbps)
 - 802.11n (HT40) Mode: MCS 0 (13 Mbps)
- (2) During the testing procedure, the continuously transmitting with the maximum power mode was programmed by the customer.
- (3) The EUT is considered a portable unit; in normal use it was positioned on X-plane. The worst case was found positioned on X-plane. Therefore only the test data of this X-plane was used for radiated emission measurement test.

1.6 Description of Test Software Setting

During testing channel&Power controlling software provided by the customer was used to control the operating channel as well as the output power level. The RF output power selection is for the setting of RF output power expected by the customer and is going to be fixed on the firmware of the final end product power parameters of WLAN.

Test Software Version	RtkWiFiTest-v1.8.1		
Channel	CH 01	CH 06	CH 11
IEEE 802.11b DSSS	DEF	DEF	DEF
IEEE 802.11g OFDM	DEF	DEF	DEF
IEEE 802.11n (HT20)	DEF	DEF	DEF
Channel	CH 03	CH 06	CH 09
IEEE 802.11n (HT40)	DEF	DEF	DEF

1.7 Measurement Uncertainty

The reported uncertainty of measurement $y \pm U$, where expanded uncertainty U is based on a standard uncertainty multiplied by a coverage factor of $k=2$, providing a level of confidence of approximately 95 %.

Test Item	Parameters	Expanded Uncertainty (U_{Lab})
Conducted Emission	Level Accuracy: 9kHz~150kHz	± 3.42 dB
	150kHz to 30MHz	± 3.42 dB
Radiated Emission	Level Accuracy: 9kHz to 30 MHz	± 4.60 dB
Radiated Emission	Level Accuracy: 30MHz to 1000 MHz	± 4.40 dB
Radiated Emission	Level Accuracy: Above 1000MHz	± 4.20 dB

1.8 Test Facility

The testing report were performed by the Shenzhen Toby Technology Co., Ltd., in their facilities located at 1A/F., Bldg.6, Yusheng Industrial Zone, The National Road No.107 Xixiang Section 467, Xixiang, Bao'an, Shenzhen, Guangdong, China. At the time of testing, the following bodies accredited the Laboratory:

CNAS (L5813)

The Laboratory has been accredited by CNAS to ISO/IEC 17025: 2005 General Requirements for the Competence of Testing and Calibration Laboratories for the competence in the field of testing. And the Registration No.: CNAS L5813.

FCC List No.: (811562)

The Laboratory is listed in the United States of American Federal Communications Commission (FCC), and the registration number is 811562.

IC Registration No.: (11950A-1)

The Laboratory has been registered by Certification and Engineering Bureau of Industry Canada for radio equipment testing. The site registration: Site# 11950A-1.

2. Test Summary

FCC Part 15 Subpart C(15.247)/ RSS 247 Issue 1				
Standard Section		Test Item	Judgment	Remark
FCC	IC			
15.203	/	Antenna Requirement	PASS	N/A
15.207	RSS-GEN 7.2.4	Conducted Emission	PASS	N/A
15.205	RSS-GEN 7.2.2	Restricted Bands	PASS	N/A
15.247(a)(2)	RSS 247 5.2 (1)	6dB Bandwidth	PASS	N/A
15.247(b)	RSS 247 5.4 (4)	Peak Output Power	PASS	N/A
15.247(e)	RSS 247 5.2 (2)	Power Spectral Density	PASS	N/A
15.247(d)	RSS 247 5.5	Band Edge	PASS	N/A
15.247(d)& 15.209	RSS 247 5.5	Transmitter Radiated Spurious Emission	PASS	N/A

Note: “/” for no requirement for this test item.
N/A is an abbreviation for Not Applicable.

3. Test Equipment

Conducted Emission Test					
Equipment	Manufacturer	Model No.	Serial No.	Last Cal.	Cal. Due Date
EMI Test Receiver	Rohde & Schwarz	ESCI	100321	Jul. 22, 2016	Jul. 21, 2017
RF Switching Unit	Compliance Direction Systems Inc	RSU-A4	34403	Jul. 22, 2016	Jul. 21, 2017
AMN	SCHWARZBECK	NNBL 8226-2	8226-2/164	Jul. 22, 2016	Jul. 21, 2017
LISN	Rohde & Schwarz	ENV216	101131	Jul. 22, 2016	Jul. 21, 2017
Radiation Emission Test					
Equipment	Manufacturer	Model No.	Serial No.	Last Cal.	Cal. Due Date
Spectrum Analyzer	Agilent	E4407B	MY45106456	Jul. 22, 2016	Jul. 21, 2017
EMI Test Receiver	Rohde & Schwarz	ESPI	100010/007	Jul. 22, 2016	Jul. 21, 2017
Bilog Antenna	ETS-LINDGREN	3142E	00117537	Mar.25, 2017	Mar. 24, 2018
Bilog Antenna	ETS-LINDGREN	3142E	00117542	Mar.25, 2017	Mar. 24, 2018
Horn Antenna	ETS-LINDGREN	3117	00143207	Mar.24, 2017	Mar. 23, 2018
Horn Antenna	ETS-LINDGREN	3117	00143209	Mar.24, 2017	Mar. 23, 2018
Loop Antenna	Laplace instrument	RF300	0701	Mar.24, 2017	Mar. 23, 2018
Pre-amplifier	Sonoma	310N	185903	Mar.25, 2017	Mar. 24, 2018
Pre-amplifier	HP	8449B	3008A00849	Mar.26, 2016	Mar. 25, 2017
Cable	HUBER+SUHNER	100	SUCOFLEX	Mar.26, 2016	Mar. 25, 2017
Positioning Controller	ETS-LINDGREN	2090	N/A	N/A	N/A
Antenna Conducted Emission					
Equipment	Manufacturer	Model No.	Serial No.	Last Cal.	Cal. Due Date
Spectrum Analyzer	Agilent	E4407B	MY45106456	Jul. 22, 2016	Jul. 21, 2017
Spectrum Analyzer	Rohde & Schwarz	ESCI	100010/007	Jul. 22, 2016	Jul. 21, 2017
Power Meter	Anritsu	ML2495A	25406005	Jul. 22, 2016	Jul. 21, 2017
Power Sensor	Anritsu	ML2411B	25406005	Jul. 22, 2016	Jul. 21, 2017

4. Conducted Emission Test

4.1 Test Standard and Limit

4.1.1 Test Standard

FCC Part 15.207

4.1.2 Test Limit

Conducted Emission Test Limit

Frequency	Maximum RF Line Voltage (dB μ V)	
	Quasi-peak Level	Average Level
150kHz~500kHz	66 ~ 56 *	56 ~ 46 *
500kHz~5MHz	56	46
5MHz~30MHz	60	50

Notes:

(1) *Decreasing linearly with logarithm of the frequency.

(2) The lower limit shall apply at the transition frequencies.

(3) The limit decrease in line with the logarithm of the frequency in the range of 0.15 to 0.50MHz.

4.2 Test Setup

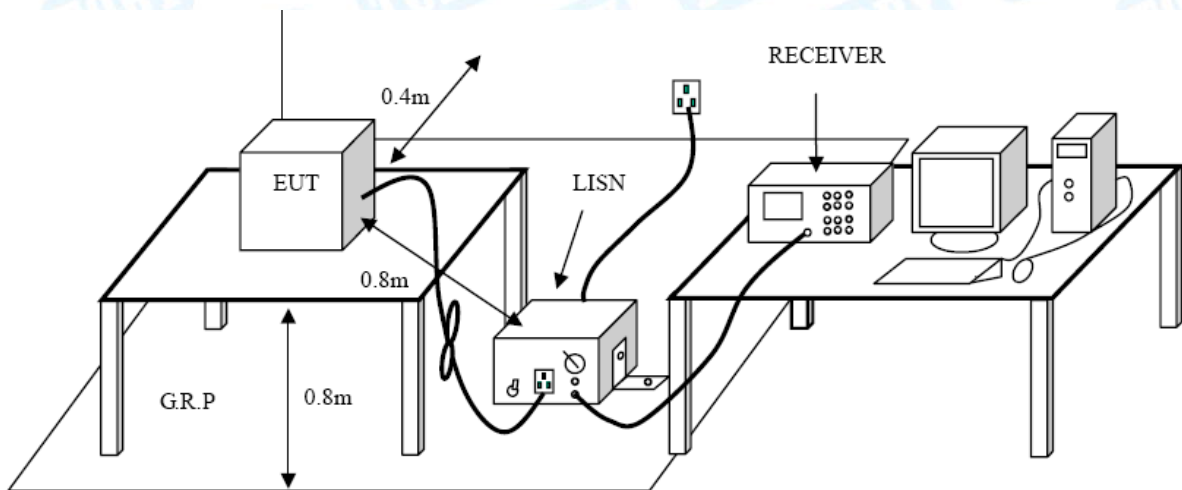

4.3 Test Procedure

The EUT was placed 0.8 meters from the horizontal ground plane with EUT being connected to the power mains through a line impedance stabilization network (LISN). All other support equipments powered from additional LISN(s). The LISN provide 50 Ohm/ 50uH of coupling impedance for the measuring instrument.

Interconnecting cables that hang closer than 40 cm to the ground plane shall be folded back and forth in the center forming a bundle 30 to 40 cm long.

I/O cables that are not connected to a peripheral shall be bundled in the center. The end of the cable may be terminated, if required, using the correct terminating impedance. The overall length shall not exceed 1 m.

LISN at least 80 cm from nearest part of EUT chassis.

The bandwidth of EMI test receiver is set at 9kHz, and the test frequency band is from 0.15MHz to 30MHz.

4.4 EUT Operating Mode

Please refer to the description of test mode.

4.5 Test Data

Please see the next page.

EUT:	Tablet PC	Model Name :	PTV-R78-3288
Temperature:	25 °C	Relative Humidity:	55%
Test Voltage:	AC 120V/60Hz		
Terminal:	Line		
Test Mode:	Charging with TX B Mode		
Remark:	Only worse case is reported		

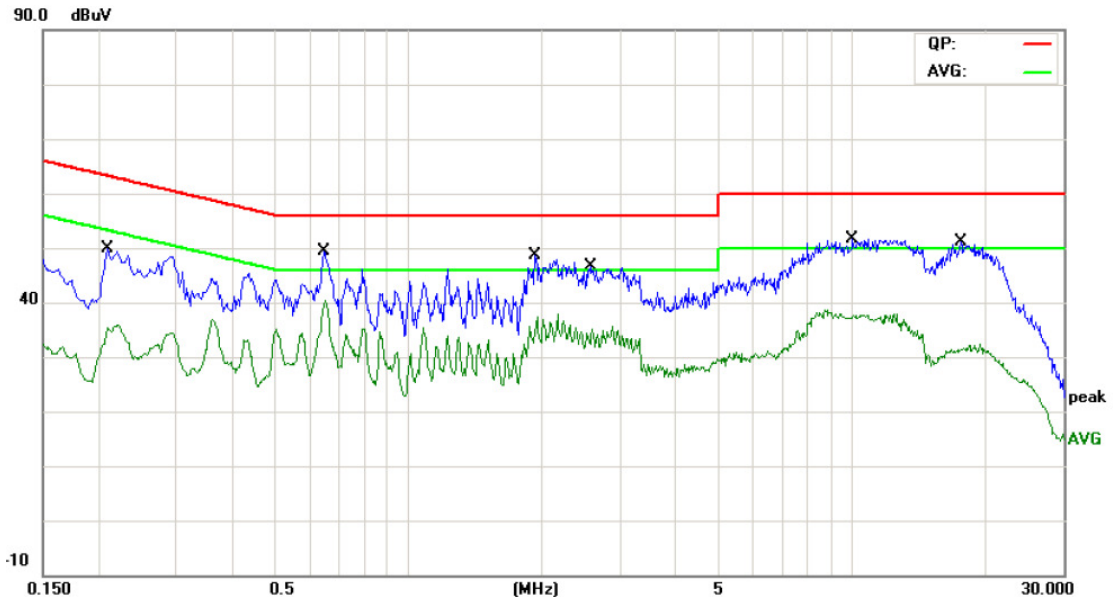

No.	Mk.	Freq. MHz	Reading Level dBuV	Correct Factor dB	Measure- ment dBuV	Limit dBuV	Over dB	Detector
1		0.2100	12.19	10.02	22.21	63.20	-40.99	QP
2		0.2100	-1.95	10.02	8.07	53.20	-45.13	AVG
3		0.6460	12.38	10.09	22.47	56.00	-33.53	QP
4		0.6460	2.24	10.09	12.33	46.00	-33.67	AVG
5		1.9380	22.11	10.06	32.17	56.00	-23.83	QP
6		1.9380	5.92	10.06	15.98	46.00	-30.02	AVG
7	*	2.5940	24.22	10.04	34.26	56.00	-21.74	QP
8		2.5940	9.83	10.04	19.87	46.00	-26.13	AVG
9		10.0338	11.33	10.16	21.49	60.00	-38.51	QP
10		10.0338	-3.11	10.16	7.05	50.00	-42.95	AVG
11		17.6018	22.03	10.21	32.24	60.00	-27.76	QP
12		17.6018	4.98	10.21	15.19	50.00	-34.81	AVG

Emission Level= Read Level+ Correct Factor

EUT:	Tablet PC	Model Name :	PTV-R78-3288
Temperature:	25 °C	Relative Humidity:	55%
Test Voltage:	AC 120V/60Hz		
Terminal:	Neutral		
Test Mode:	Charging with TX B Mode		
Remark:	Only worse case is reported		

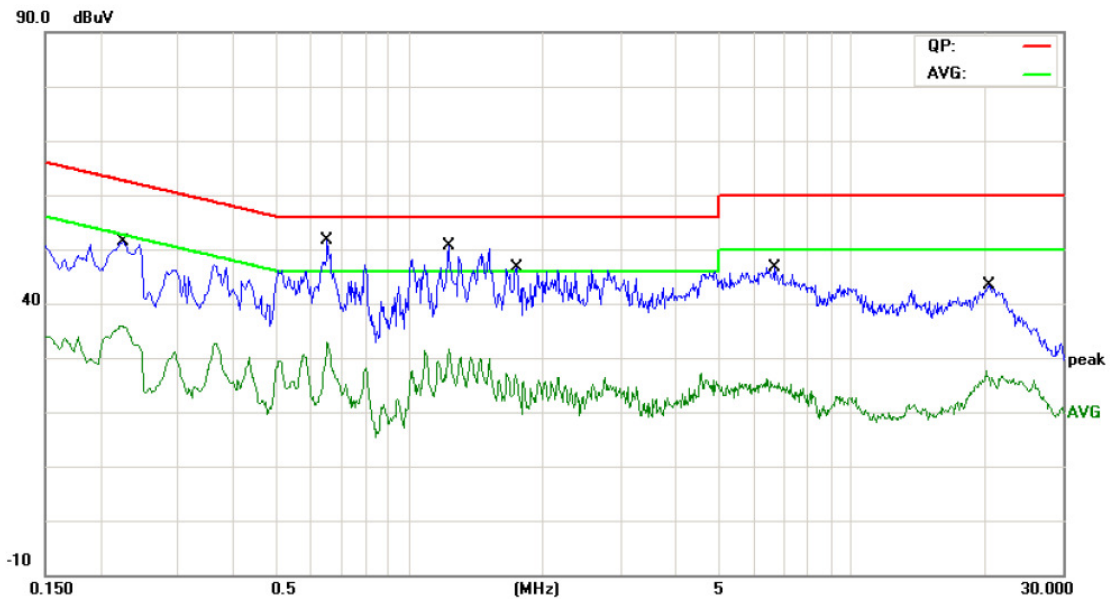

No.	Mk.	Freq. MHz	Reading Level dBuV	Correct Factor dB	Measure- ment dBuV	Limit dBuV	Over dB	Detector
1	*	0.2260	32.70	10.11	42.81	62.59	-19.78	QP
2		0.2260	13.34	10.11	23.45	52.59	-29.14	AVG
3		0.6540	10.79	10.02	20.81	56.00	-35.19	QP
4		0.6540	0.18	10.02	10.20	46.00	-35.80	AVG
5		1.2260	15.38	10.14	25.52	56.00	-30.48	QP
6		1.2260	5.34	10.14	15.48	46.00	-30.52	AVG
7		1.7460	22.19	10.09	32.28	56.00	-23.72	QP
8		1.7460	4.46	10.09	14.55	46.00	-31.45	AVG
9		6.6779	13.23	10.06	23.29	60.00	-36.71	QP
10		6.6779	4.19	10.06	14.25	50.00	-35.75	AVG
11		20.3940	28.94	10.06	39.00	60.00	-21.00	QP
12		20.3940	10.34	10.06	20.40	50.00	-29.60	AVG

Emission Level= Read Level+ Correct Factor

EUT:	Tablet PC	Model Name :	PTV-R78-3288
Temperature:	25 °C	Relative Humidity:	55%
Test Voltage:	AC 240V/60Hz		
Terminal:	Line		
Test Mode:	Charging with TX B Mode		
Remark:	Only worse case is reported		

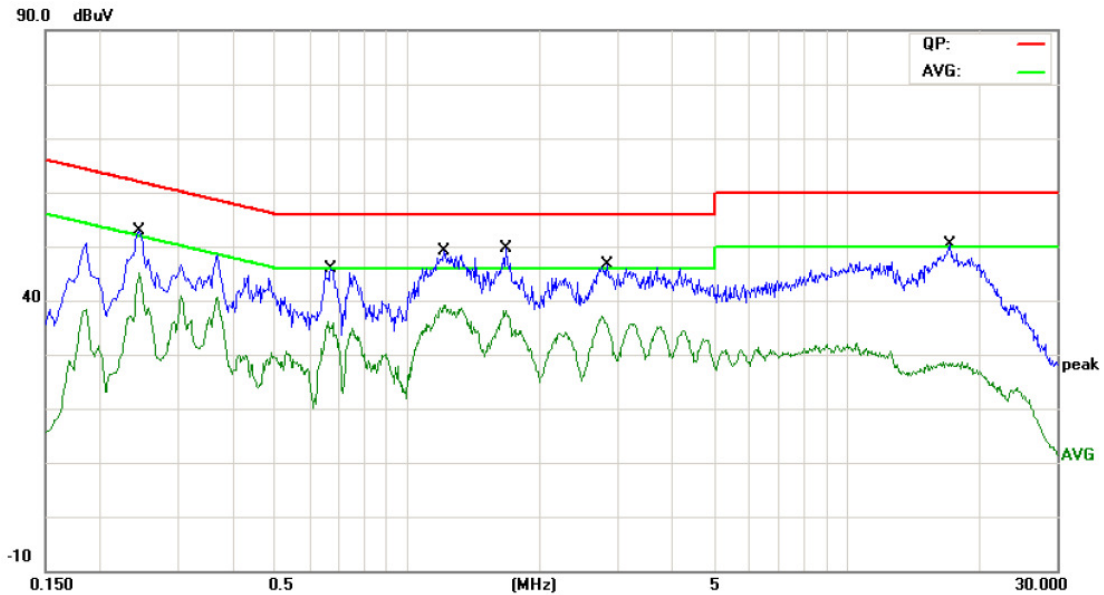

No.	Mk.	Freq. MHz	Reading Level dBuV	Correct Factor dB	Measure- ment dBuV	Limit dBuV	Over dB	Detector
1		0.2460	29.43	10.02	39.45	61.89	-22.44	QP
2		0.2460	9.42	10.02	19.44	51.89	-32.45	AVG
3		0.6700	15.18	10.10	25.28	56.00	-30.72	QP
4		0.6700	5.72	10.10	15.82	46.00	-30.18	AVG
5		1.2100	12.78	10.06	22.84	56.00	-33.16	QP
6		1.2100	1.28	10.06	11.34	46.00	-34.66	AVG
7	*	1.6780	24.21	10.06	34.27	56.00	-21.73	QP
8		1.6780	9.14	10.06	19.20	46.00	-26.80	AVG
9		2.8500	12.55	10.03	22.58	56.00	-33.42	QP
10		2.8500	-1.61	10.03	8.42	46.00	-37.58	AVG
11		17.1818	8.18	10.22	18.40	60.00	-41.60	QP
12		17.1818	-4.69	10.22	5.53	50.00	-44.47	AVG

Emission Level= Read Level+ Correct Factor

EUT:	Tablet PC	Model Name :	PTV-R78-3288
Temperature:	25 °C	Relative Humidity:	55%
Test Voltage:	AC 240V/60Hz		
Terminal:	Neutral		
Test Mode:	Charging with TX B Mode		
Remark:	Only worse case is reported		

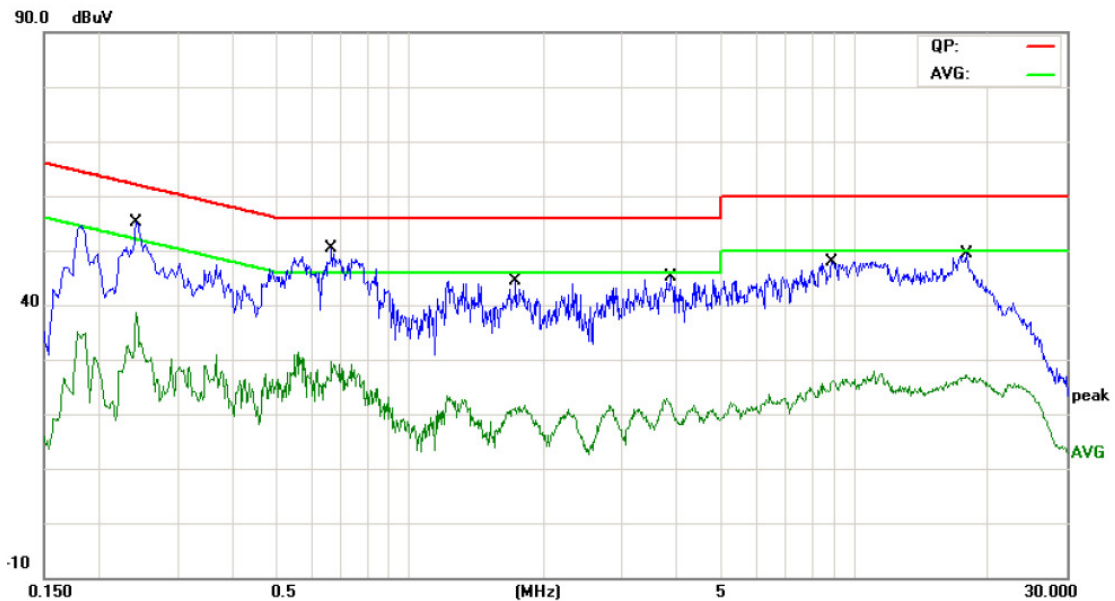

No.	Mk.	Freq. MHz	Reading Level dBuV	Correct Factor dB	Measure- ment dBuV	Limit dBuV	Over dB	Detector
1		0.2419	11.96	10.11	22.07	62.03	-39.96	QP
2		0.2419	-0.51	10.11	9.60	52.03	-42.43	AVG
3		0.6660	14.05	10.02	24.07	56.00	-31.93	QP
4		0.6660	4.76	10.02	14.78	46.00	-31.22	AVG
5		1.7259	20.53	10.09	30.62	56.00	-25.38	QP
6		1.7259	7.07	10.09	17.16	46.00	-28.84	AVG
7		3.8500	14.24	10.06	24.30	56.00	-31.70	QP
8		3.8500	5.01	10.06	15.07	46.00	-30.93	AVG
9		8.8899	10.35	10.12	20.47	60.00	-39.53	QP
10		8.8899	-3.54	10.12	6.58	50.00	-43.42	AVG
11	*	17.8858	27.79	10.06	37.85	60.00	-22.15	QP
12		17.8858	10.25	10.06	20.31	50.00	-29.69	AVG

Emission Level= Read Level+ Correct Factor

5. Radiated Emission Test

5.1 Test Standard and Limit

5.1.1 Test Standard
FCC Part 15.209

5.1.2 Test Limit

Radiated Emission Limits (9 kHz~1000 MHz)

Frequency (MHz)	Field Strength (microvolt/meter)	Measurement Distance (meters)
0.009~0.490	2400/F(KHz)	300
0.490~1.705	24000/F(KHz)	30
1.705~30.0	30	30
30~88	100	3
88~216	150	3
216~960	200	3
Above 960	500	3

Radiated Emission Limit (Above 1000MHz)

Frequency (MHz)	Distance of 3m (dBuV/m)	
	Peak	Average
Above 1000	74	54

Note:

- (1) The tighter limit applies at the band edges.
- (2) Emission Level(dBuV/m)=20log Emission Level(uV/m)

5.2 Test Setup

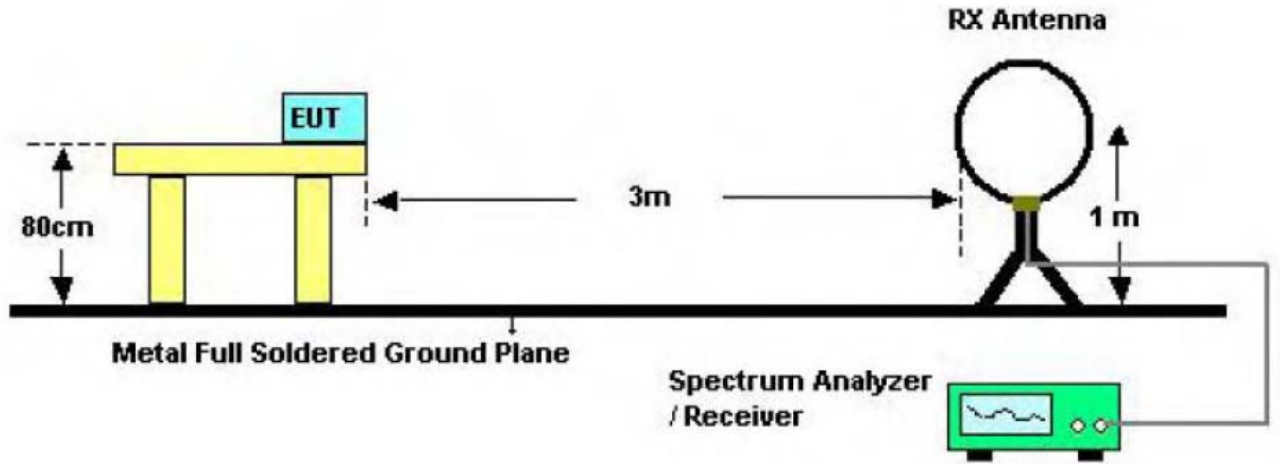

Below 30MHz Test Setup

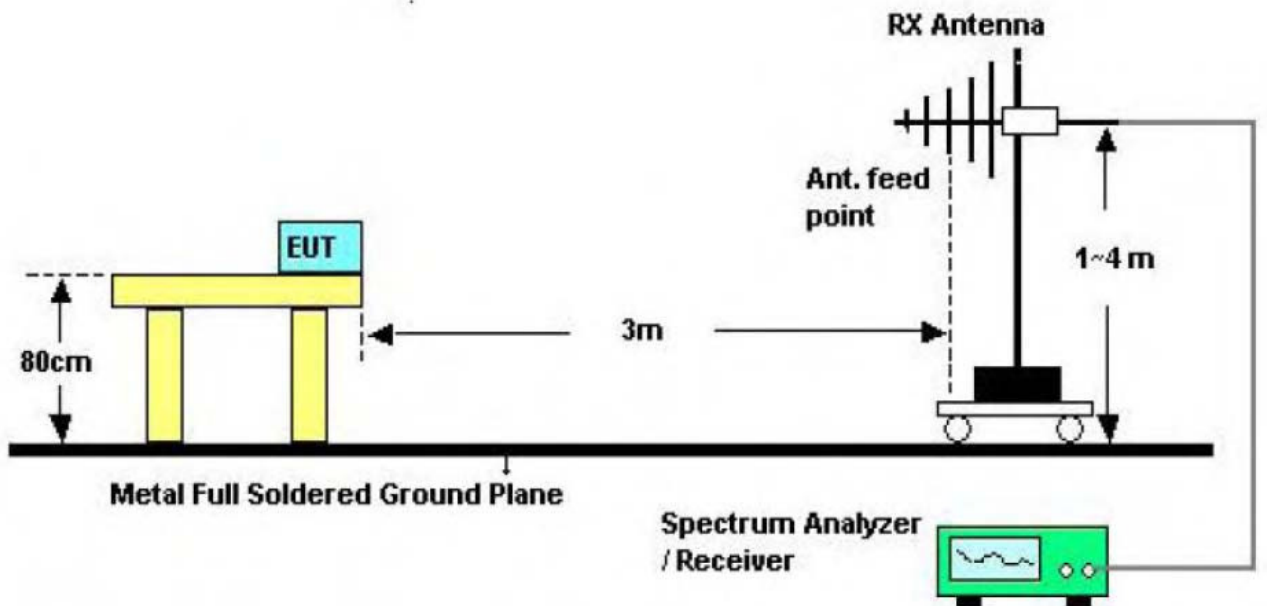

Below 1000MHz Test Setup

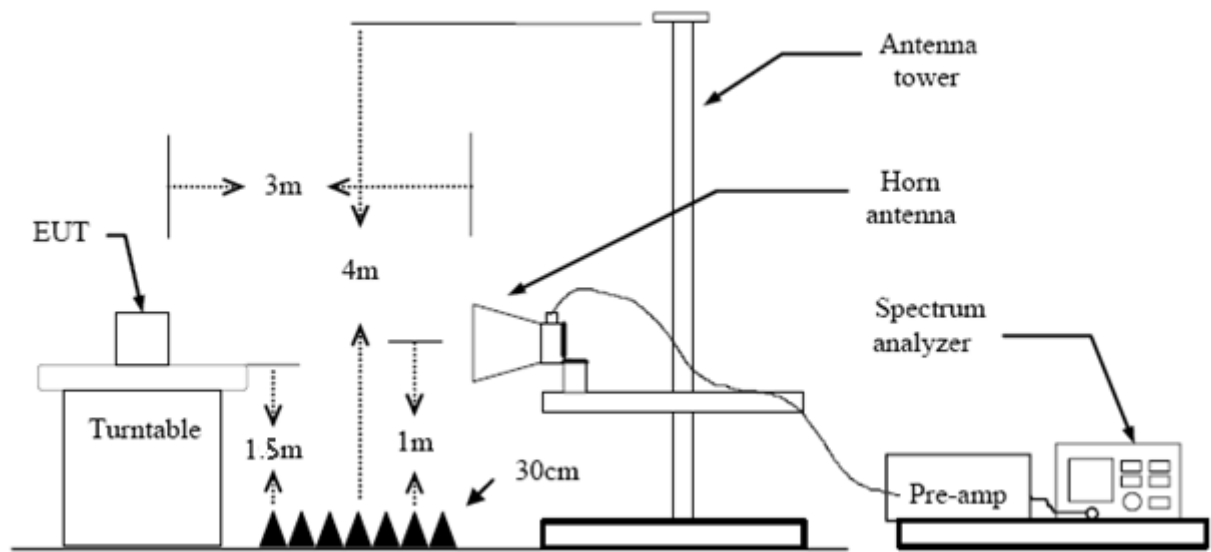

Above 1GHz Test Setup

5.3 Test Procedure

- (1) Measurements at frequency above 1GHz. The EUT was placed on a rotating 1.5m high above the ground. RF absorbers covered the ground plane with a minimum area of 3.0m by 3.0m between the EUT and measurement receiver antenna. The RF absorber shall not exceed 30cm in high above the conducting floor. The table was rotated 360 degrees to determine the position of the highest radiation.
- (2) The Test antenna shall vary between 1m and 4m, Both Horizontal and Vertical antenna are set to make measurement.
- (3) The initial step in collecting conducted emission data is a spectrum analyzer peak detector mode pre-scanning the measurement frequency range. Significant peaks are then marked and then Quasi Peak detector mode re-measured.
- (4) If the Peak Mode measured value compliance with and lower than Quasi Peak Mode Limit Bellow 1 GHz, the EUT shall be deemed to meet QP Limits and then no additional QP Mode measurement performed. But the Peak Value and average value both need to comply with applicable limit above 1 GHz.
- (5) Testing frequency range below 1GHz the measuring instrument use VBW=120 kHz with Quasi-peak detection.
- (6) Testing frequency range above 1GHz the measuring instrument use RBW=1 MHz and VBW=3 MHz with Peak Detector for Peak Values, and use RBW=1 MHz and VBW=10 Hz with Peak Detector for Average Values.
- (7) For the actual test configuration, please see the test setup photo.

5.4 EUT Operating Condition

The Equipment Under Test was set to Continual Transmitting in maximum power.

5.5 Test Data

Remark: During testing above 1GHz the measuring instrument use RBW=1 MHz and VBW=3 MHz with Peak Detector for Peak Values, and use RBW=1 MHz and VBW=10 Hz with Peak Detector for Average Values.

Test data please refer the following pages.

9KHz~30MHz

From 9KHz to 30MHz: Conclusion: PASS

Note: The amplitude of spurious emissions which are attenuated by more than 20dB below the permissible value has no need to be reported.

30MHz~1GHz

EUT:	Tablet PC	Model:	PTV-R78-3288
Temperature:	25 °C	Relative Humidity:	55%
Test Voltage:	DC 3.7V		
Ant. Pol.	Horizontal		
Test Mode:	TX B Mode 2412MHz		
Remark:	Only worse case is reported		

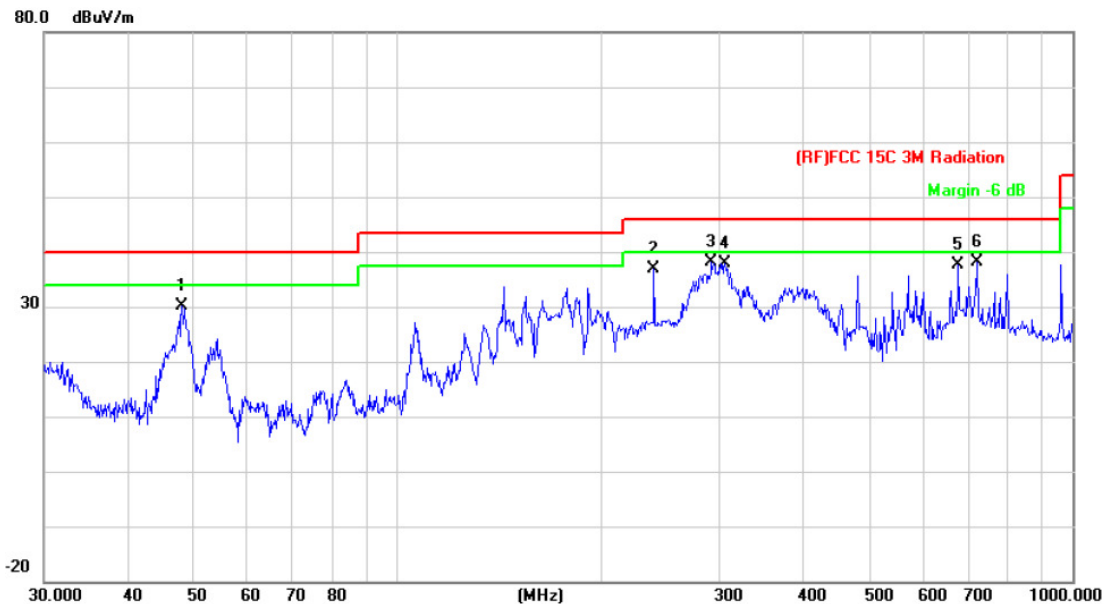

No.	Mk.	Freq. MHz	Reading Level dBuV	Correct Factor dB/m	Measurement dBuV/m	Limit dBuV/m	Over dB	Detector
1		47.9938	53.87	-23.65	30.22	40.00	-9.78	peak
2		239.9874	55.11	-18.18	36.93	46.00	-9.07	peak
3		292.0581	54.84	-16.81	38.03	46.00	-7.97	peak
4		305.6800	54.41	-16.43	37.98	46.00	-8.02	peak
5		677.5797	44.11	-6.50	37.61	46.00	-8.39	peak
6	*	721.7259	44.20	-6.00	38.20	46.00	-7.80	peak

*:Maximum data x:Over limit !:over margin

Emission Level= Read Level+ Correct Factor

EUT:	Tablet PC	Model:	PTV-R78-3288
Temperature:	25 °C	Relative Humidity:	55%
Test Voltage:	DC 3.7V		
Ant. Pol.	Vertical		
Test Mode:	TX B Mode 2412MHz		
Remark:	Only worse case is reported		

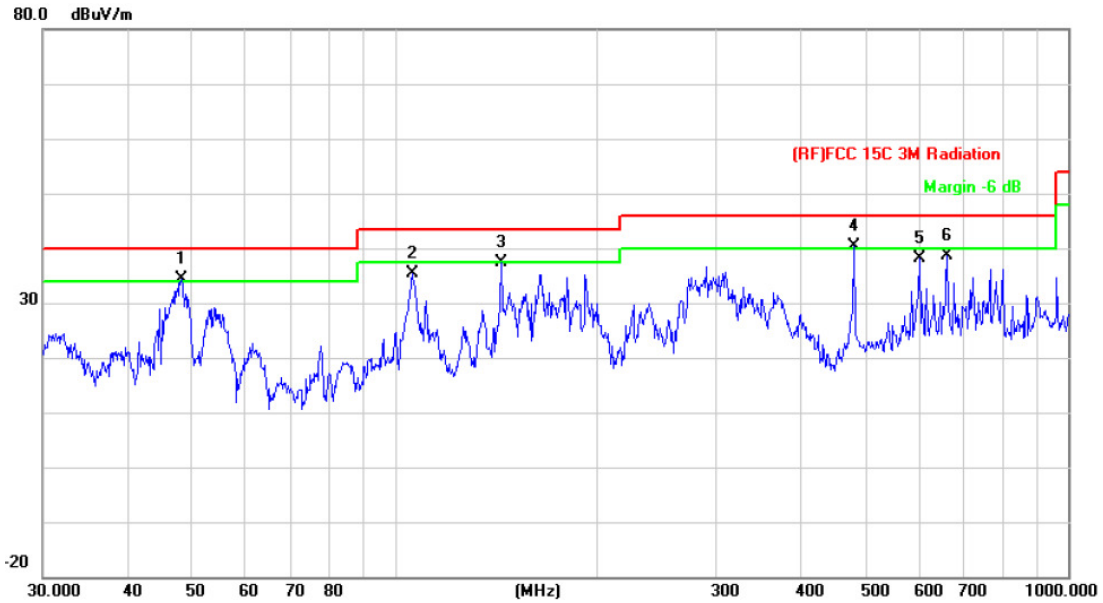

No.	Mk.	Freq. MHz	Reading Level dBuV	Correct Factor dB/m	Measure- ment dBuV/m	Limit dBuV/m	Over dB	Detector
1	*	48.1625	58.13	-23.72	34.41	40.00	-5.59	peak
2		106.0126	57.25	-21.85	35.40	43.50	-8.10	peak
3		143.8293	58.78	-21.51	37.27	43.50	-6.23	peak
4	!	480.5276	51.45	-11.13	40.32	46.00	-5.68	peak
5		601.4265	46.73	-8.67	38.06	46.00	-7.94	peak
6		661.1503	46.06	-7.32	38.74	46.00	-7.26	peak

*:Maximum data x:Over limit !:over margin

Emission Level= Read Level+ Correct Factor

Above 1GHz

EUT:	Tablet PC	Model:	PTV-R78-3288
Temperature:	25 °C	Relative Humidity:	55%
Test Voltage:	DC 3.7V		
Ant. Pol.	Horizontal		
Test Mode:	TX B Mode 2412MHz		
Remark:	No report for the emission which more than 10 dB below the prescribed limit.		

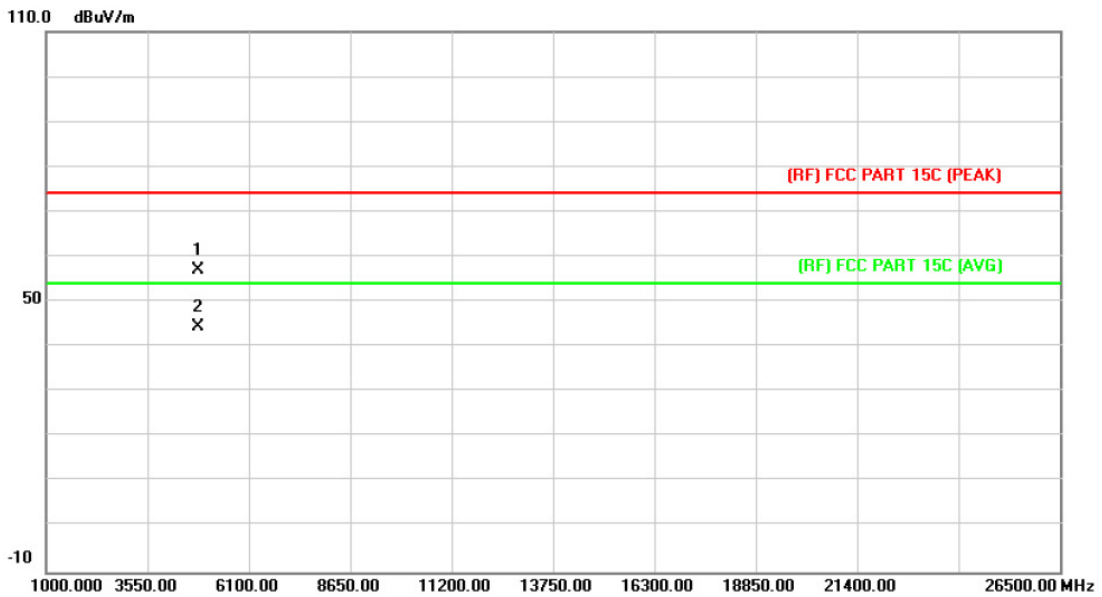

No.	Mk.	Freq. MHz	Reading Level dBuV	Correct Factor dB/m	Measure- ment dBuV/m	Limit dBuV/m	Over dB	Detector
1		4823.769	43.57	13.56	57.13	74.00	-16.87	peak
2	*	4824.162	30.90	13.56	44.46	54.00	-9.54	AVG

Emission Level= Read Level+ Correct Factor

EUT:	Tablet PC	Model:	PTV-R78-3288
Temperature:	25 °C	Relative Humidity:	55%
Test Voltage:	DC 3.7V		
Ant. Pol.	Vertical		
Test Mode:	TX B Mode 2412MHz		
Remark:	No report for the emission which more than 10 dB below the prescribed limit.		

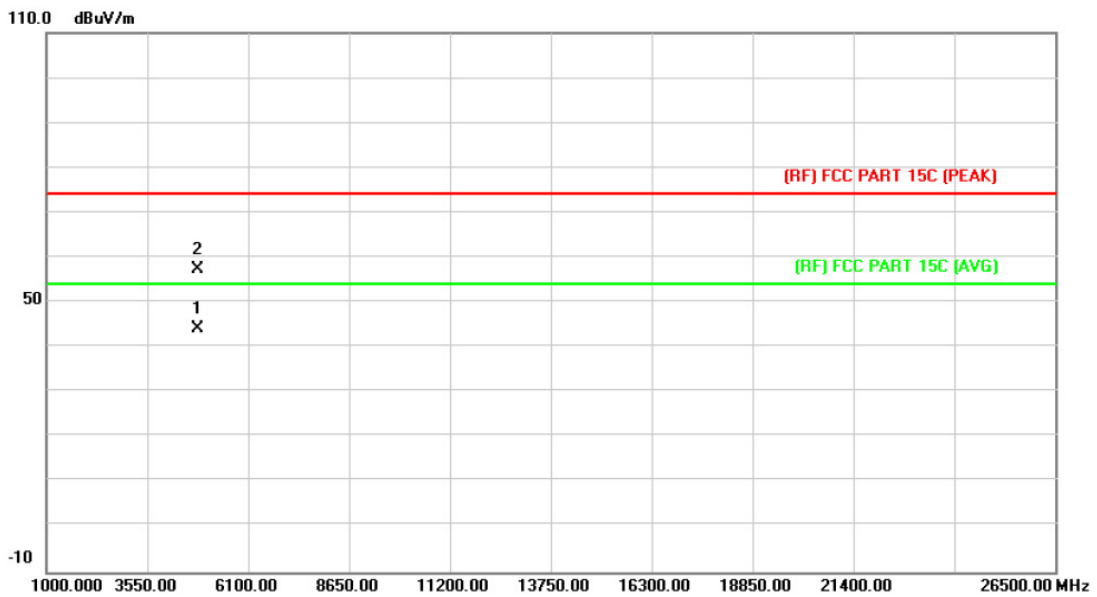

No.	Mk.	Freq.	Reading Level	Correct Factor	Measurement	Limit	Over	Detector
		MHz	dBuV	dB/m	dBuV/m	dBuV/m	dB	
1	*	4823.946	30.67	13.56	44.23	54.00	-9.77	AVG
2		4825.455	43.87	13.57	57.44	74.00	-16.56	peak

Emission Level= Read Level+ Correct Factor

EUT:	Tablet PC	Model:	PTV-R78-3288
Temperature:	25 °C	Relative Humidity:	55%
Test Voltage:	DC 3.7V		
Ant. Pol.	Horizontal		
Test Mode:	TX B Mode 2437MHz		
Remark:	No report for the emission which more than 10 dB below the prescribed limit.		

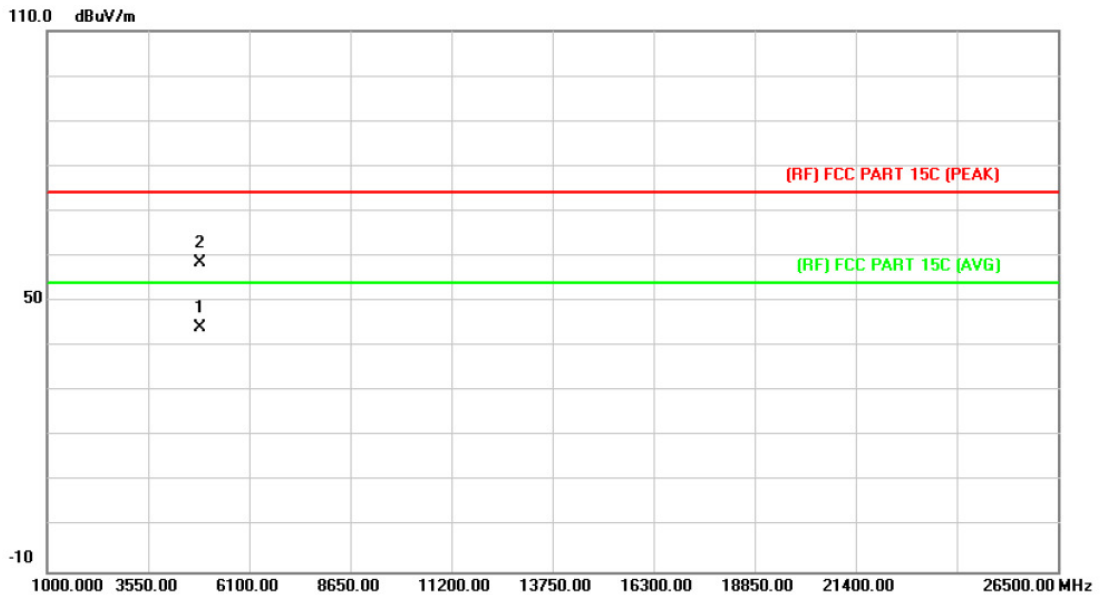

No.	Mk.	Freq.	Reading Level	Correct Factor	Measurement	Limit	Over	Detector
		MHz	dBuV	dB/m	dBuV/m	dBuV/m	dB	
1	*	4872.851	30.18	13.85	44.03	54.00	-9.97	AVG
2		4873.388	44.63	13.86	58.49	74.00	-15.51	peak

Emission Level= Read Level+ Correct Factor

EUT:	Tablet PC	Model:	PTV-R78-3288
Temperature:	25 °C	Relative Humidity:	55%
Test Voltage:	DC 3.7V		
Ant. Pol.	Vertical		
Test Mode:	TX B Mode 2437MHz		
Remark:	No report for the emission which more than 10 dB below the prescribed limit.		

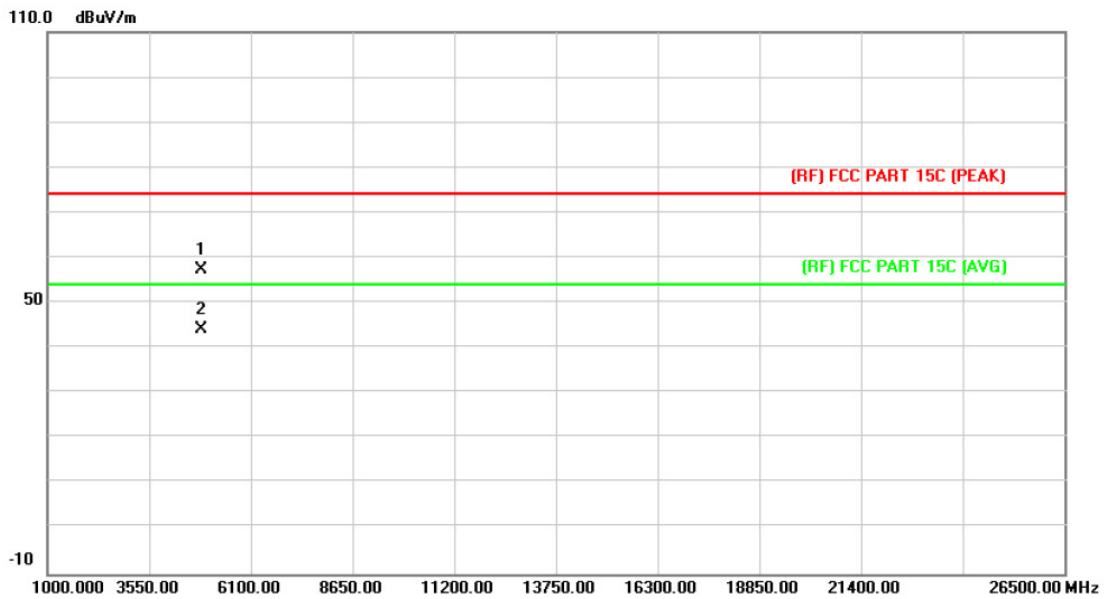

No.	Mk.	Freq. MHz	Reading Level dBuV	Correct Factor dB/m	Measure- ment dBuV/m	Limit dBuV/m	Over dB	Detector
1		4874.747	43.38	13.86	57.24	74.00	-16.76	peak
2	*	4875.221	30.26	13.87	44.13	54.00	-9.87	AVG

Emission Level= Read Level+ Correct Factor

EUT:	Tablet PC	Model:	PTV-R78-3288
Temperature:	25 °C	Relative Humidity:	55%
Test Voltage:	DC 3.7V		
Ant. Pol.	Horizontal		
Test Mode:	TX B Mode 2462MHz		
Remark:	No report for the emission which more than 10 dB below the prescribed limit.		

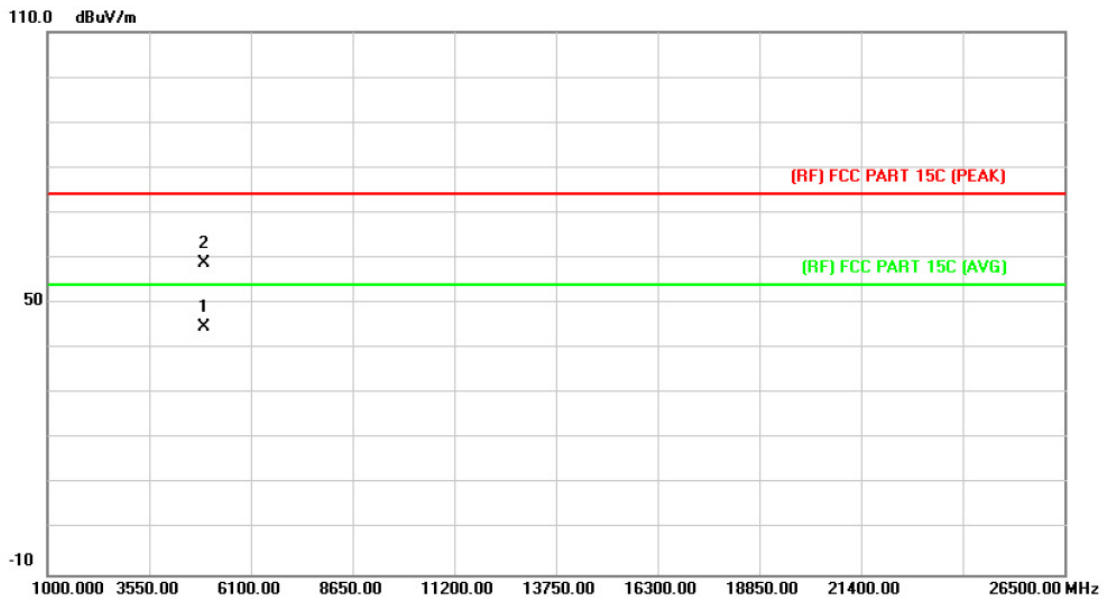

No.	Mk.	Freq.	Reading Level	Correct Factor	Measurement	Limit	Over	Detector
		MHz	dBuV	dB/m	dBuV/m	dBuV/m	dB	
1	*	4923.538	30.64	14.15	44.79	54.00	-9.21	AVG
2		4923.958	44.69	14.15	58.84	74.00	-15.16	peak

Emission Level= Read Level+ Correct Factor

EUT:	Tablet PC	Model:	PTV-R78-3288
Temperature:	25 °C	Relative Humidity:	55%
Test Voltage:	DC 3.7V		
Ant. Pol.	Vertical		
Test Mode:	TX B Mode 2462MHz		
Remark:	No report for the emission which more than 10 dB below the prescribed limit.		

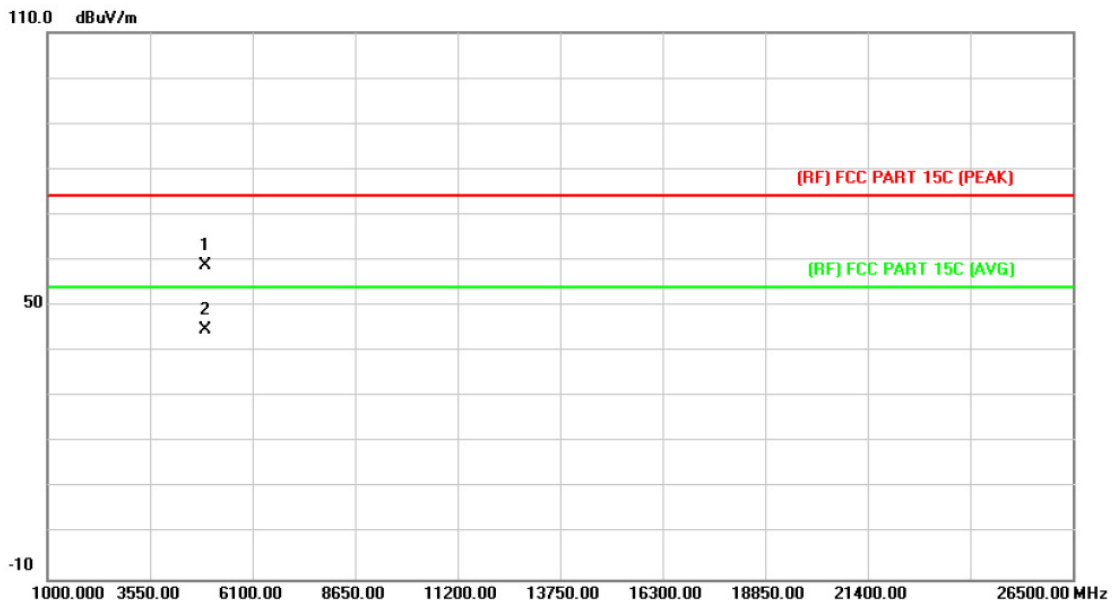

No.	Mk.	Freq. MHz	Reading Level dBuV	Correct Factor dB/m	Measure- ment dBuV/m	Limit dBuV/m	Over dB	Detector
1		4924.144	44.64	14.15	58.79	74.00	-15.21	peak
2	*	4924.651	30.65	14.15	44.80	54.00	-9.20	AVG

Emission Level= Read Level+ Correct Factor

EUT:	Tablet PC	Model:	PTV-R78-3288
Temperature:	25 °C	Relative Humidity:	55%
Test Voltage:	DC 3.7V		
Ant. Pol.	Horizontal		
Test Mode:	TX G Mode 2412MHz		
Remark:	No report for the emission which more than 10 dB below the prescribed limit.		

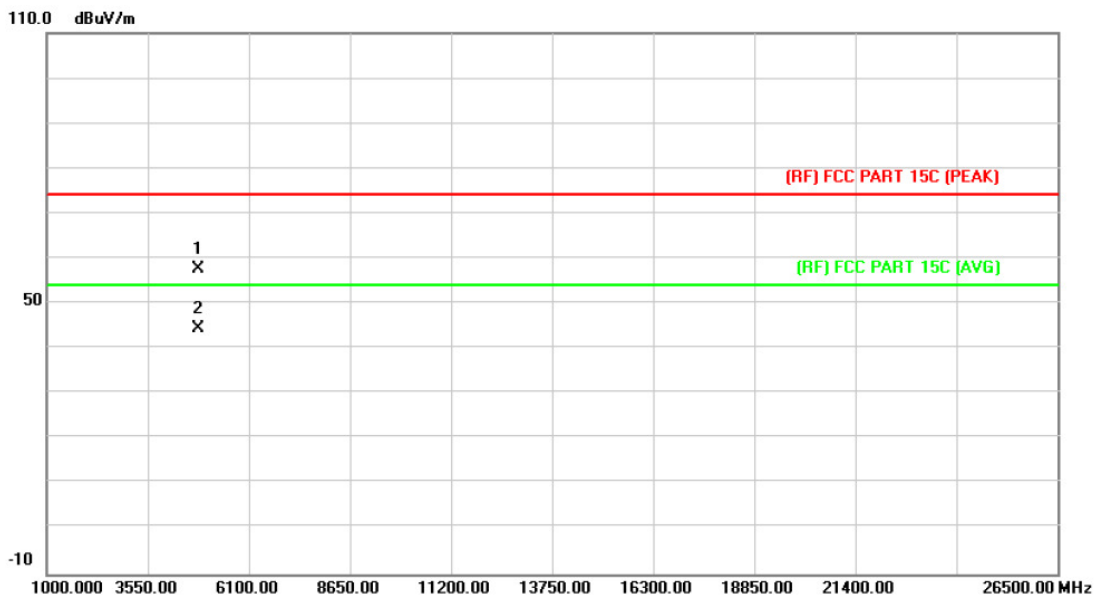

No.	Mk.	Freq. MHz	Reading Level dBuV	Correct Factor dB/m	Measure- ment dBuV/m	Limit dBuV/m	Over dB	Detector
1		4824.042	44.03	13.56	57.59	74.00	-16.41	peak
2	*	4824.066	30.76	13.56	44.32	54.00	-9.68	AVG

Emission Level= Read Level+ Correct Factor

EUT:	Tablet PC	Model:	PTV-R78-3288
Temperature:	25 °C	Relative Humidity:	55%
Test Voltage:	DC 3.7V		
Ant. Pol.	Vertical		
Test Mode:	TX G Mode 2412MHz		
Remark:	No report for the emission which more than 10 dB below the prescribed limit.		

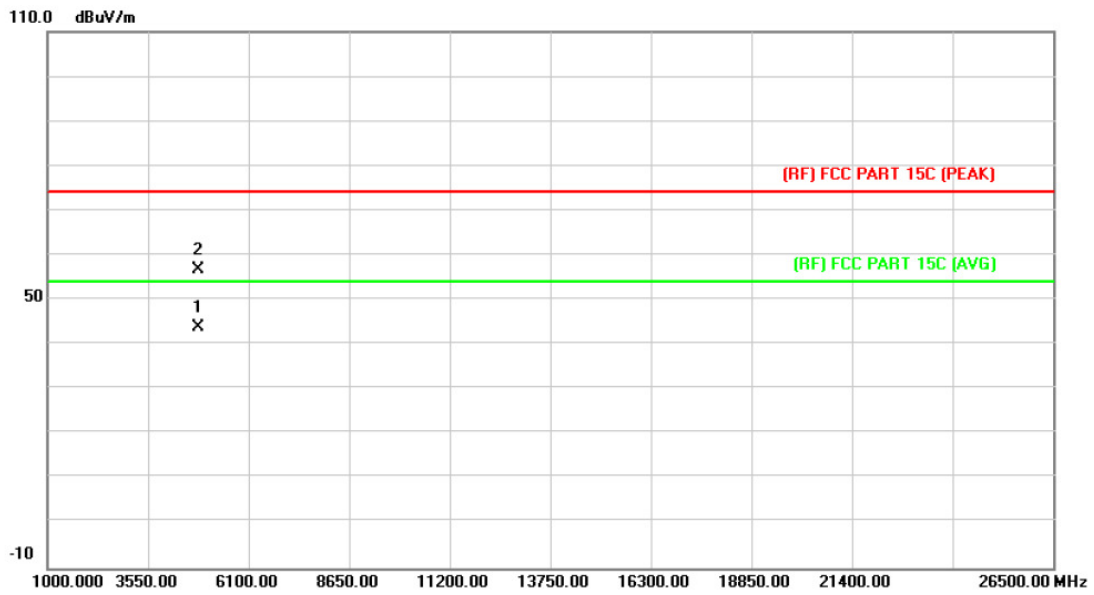

No.	Mk.	Freq. MHz	Reading Level dBuV	Correct Factor dB/m	Measure- ment dBuV/m	Limit dBuV/m	Over dB	Detector
1	*	4824.624	30.33	13.56	43.89	54.00	-10.11	AVG
2		4825.293	43.29	13.57	56.86	74.00	-17.14	peak

Emission Level= Read Level+ Correct Factor

EUT:	Tablet PC	Model:	PTV-R78-3288
Temperature:	25 °C	Relative Humidity:	55%
Test Voltage:	DC 3.7V		
Ant. Pol.	Horizontal		
Test Mode:	TX G Mode 2437MHz		
Remark:	No report for the emission which more than 10 dB below the prescribed limit.		

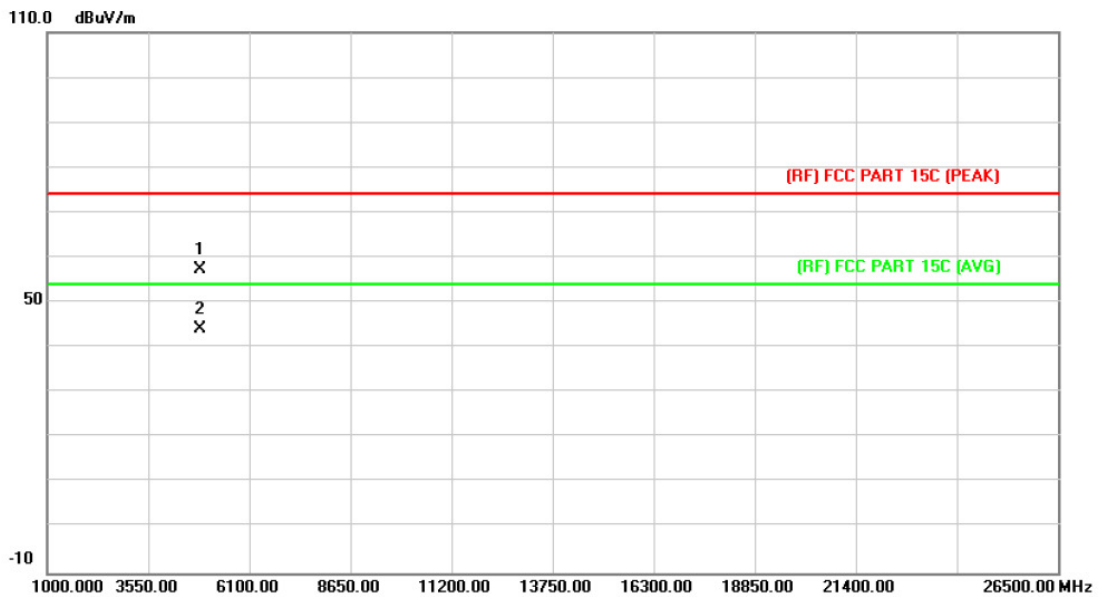

No.	Mk.	Freq. MHz	Reading Level dBuV	Correct Factor dB/m	Measure- ment dBuV/m	Limit dBuV/m	Over dB	Detector
1		4873.796	43.49	13.86	57.35	74.00	-16.65	peak
2	*	4875.452	30.36	13.87	44.23	54.00	-9.77	AVG

Emission Level= Read Level+ Correct Factor

EUT:	Tablet PC	Model:	PTV-R78-3288
Temperature:	25 °C	Relative Humidity:	55%
Test Voltage:	DC 3.7V		
Ant. Pol.	Vertical		
Test Mode:	TX G Mode 2437MHz		
Remark:	No report for the emission which more than 10 dB below the prescribed limit.		

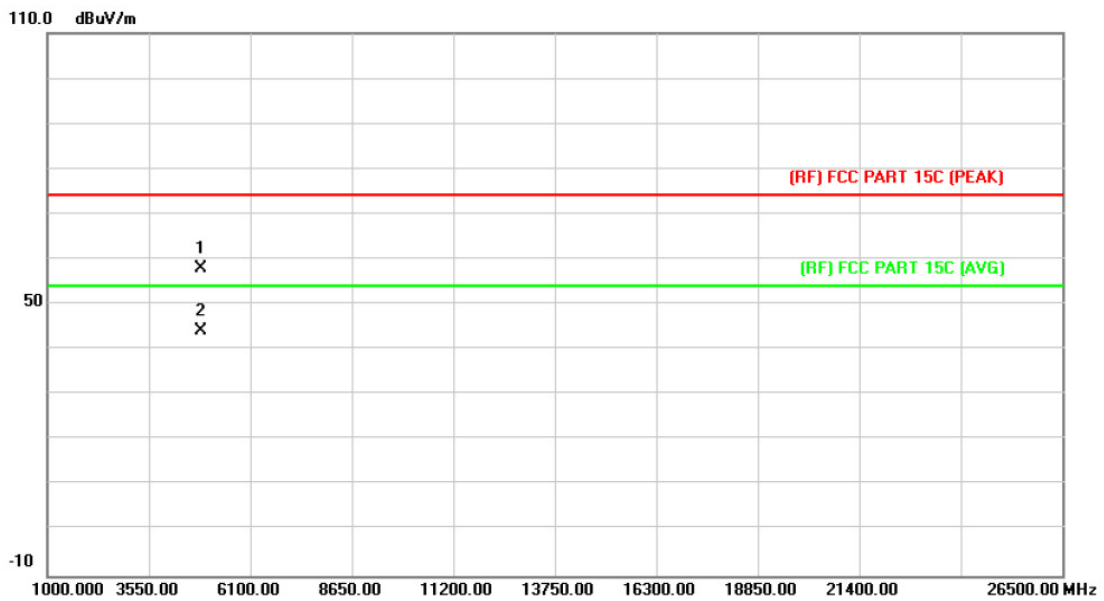

No.	Mk.	Freq.	Reading Level	Correct Factor	Measurement	Limit	Over	Detector
		MHz	dBuV	dB/m	dBuV/m	dBuV/m	dB	
1		4873.445	44.08	13.86	57.94	74.00	-16.06	peak
2	*	4874.816	30.28	13.86	44.14	54.00	-9.86	AVG

Emission Level= Read Level+ Correct Factor

EUT:	Tablet PC	Model:	PTV-R78-3288
Temperature:	25 °C	Relative Humidity:	55%
Test Voltage:	DC 3.7V		
Ant. Pol.	Horizontal		
Test Mode:	TX G Mode 2462MHz		
Remark:	No report for the emission which more than 10 dB below the prescribed limit.		

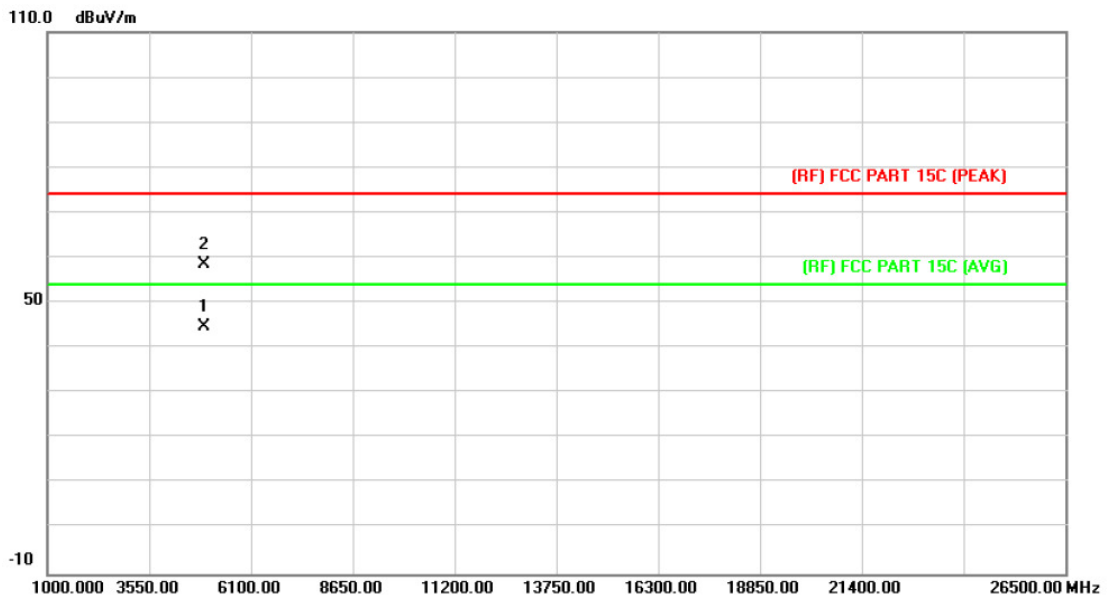

No.	Mk.	Freq.	Reading Level	Correct Factor	Measurement	Limit	Over	Detector
		MHz	dBuV	dB/m	dBuV/m	dBuV/m	dB	
1	*	4922.836	30.75	14.14	44.89	54.00	-9.11	AVG
2		4924.018	44.43	14.15	58.58	74.00	-15.42	peak

Emission Level= Read Level+ Correct Factor

EUT:	Tablet PC	Model:	PTV-R78-3288
Temperature:	25 °C	Relative Humidity:	55%
Test Voltage:	DC 3.7V		
Ant. Pol.	Vertical		
Test Mode:	TX G Mode 2462MHz		
Remark:	No report for the emission which more than 10 dB below the prescribed limit.		

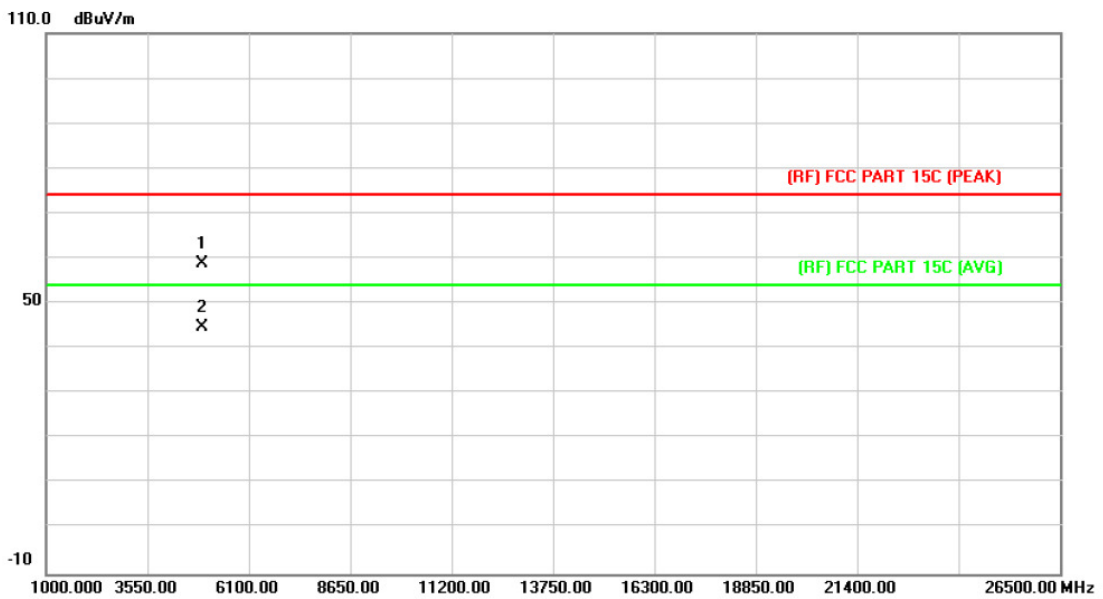

No.	Mk.	Freq. MHz	Reading Level dBuV	Correct Factor dB/m	Measure- ment dBuV/m	Limit dBuV/m	Over dB	Detector
1		4924.144	44.64	14.15	58.79	74.00	-15.21	peak
2	*	4925.254	30.51	14.16	44.67	54.00	-9.33	AVG

Emission Level= Read Level+ Correct Factor

EUT:	Tablet PC	Model:	PTV-R78-3288
Temperature:	25 °C	Relative Humidity:	55%
Test Voltage:	DC 3.7V		
Ant. Pol.	Horizontal		
Test Mode:	TX N(HT20) Mode 2412MHz		
Remark:	No report for the emission which more than 10 dB below the prescribed limit.		

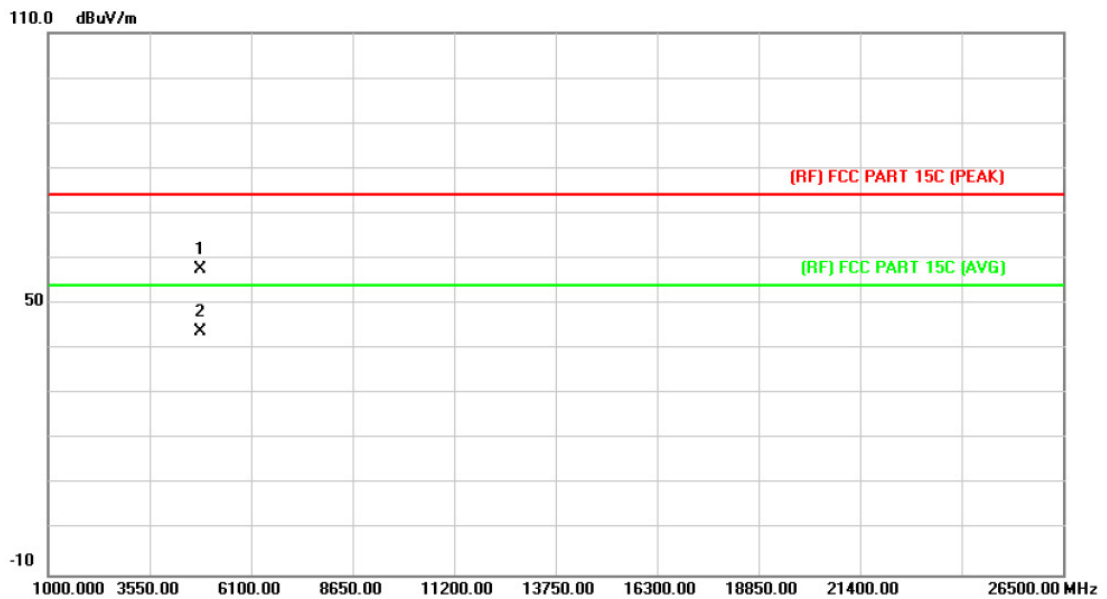

No.	Mk.	Freq. MHz	Reading Level dBuV	Correct Factor dB/m	Measure- ment dBuV/m	Limit dBuV/m	Over dB	Detector
1	*	4823.886	44.08	13.56	57.64	74.00	-16.36	peak
2		4824.882	30.24	13.56	43.80	74.00	-30.20	peak

Emission Level= Read Level+ Correct Factor

EUT:	Tablet PC	Model:	PTV-R78-3288
Temperature:	25 °C	Relative Humidity:	55%
Test Voltage:	DC 3.7V		
Ant. Pol.	Vertical		
Test Mode:	TX N(HT20) Mode 2412MHz		
Remark:	No report for the emission which more than 10 dB below the prescribed limit.		

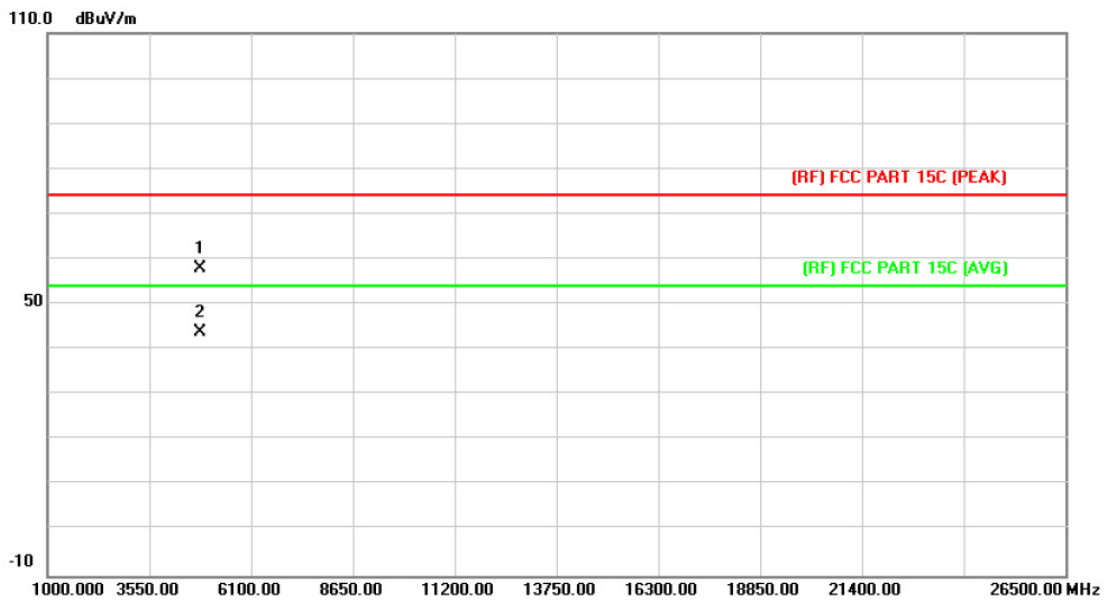

No.	Mk.	Freq.	Reading Level	Correct Factor	Measurement	Limit	Over	Detector
		MHz	dBuV	dB/m	dBuV/m	dBuV/m	dB	
1		4822.992	44.32	13.55	57.87	74.00	-16.13	peak
2	*	4825.011	30.14	13.57	43.71	54.00	-10.29	AVG

Emission Level= Read Level+ Correct Factor

EUT:	Tablet PC	Model:	PTV-R78-3288
Temperature:	25 °C	Relative Humidity:	55%
Test Voltage:	DC 3.7V		
Ant. Pol.	Horizontal		
Test Mode:	TX N(HT20) Mode 2437MHz		
Remark:	No report for the emission which more than 10 dB below the prescribed limit.		

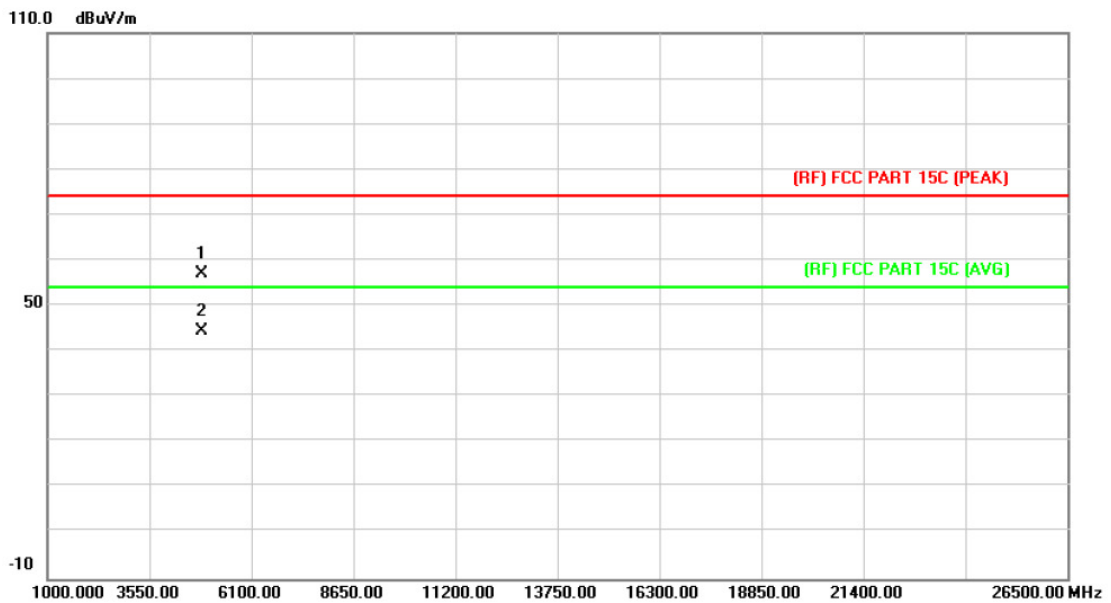

No.	Mk.	Freq. MHz	Reading Level dBuV	Correct Factor dB/m	Measure- ment dBuV/m	Limit dBuV/m	Over dB	Detector
1		4872.608	43.28	13.85	57.13	74.00	-16.87	peak
2	*	4874.405	30.53	13.86	44.39	54.00	-9.61	AVG

Emission Level= Read Level+ Correct Factor

EUT:	Tablet PC	Model:	PTV-R78-3288
Temperature:	25 °C	Relative Humidity:	55%
Test Voltage:	DC 3.7V		
Ant. Pol.	Vertical		
Test Mode:	TX N(HT20) Mode 2437MHz		
Remark:	No report for the emission which more than 10 dB below the prescribed limit.		

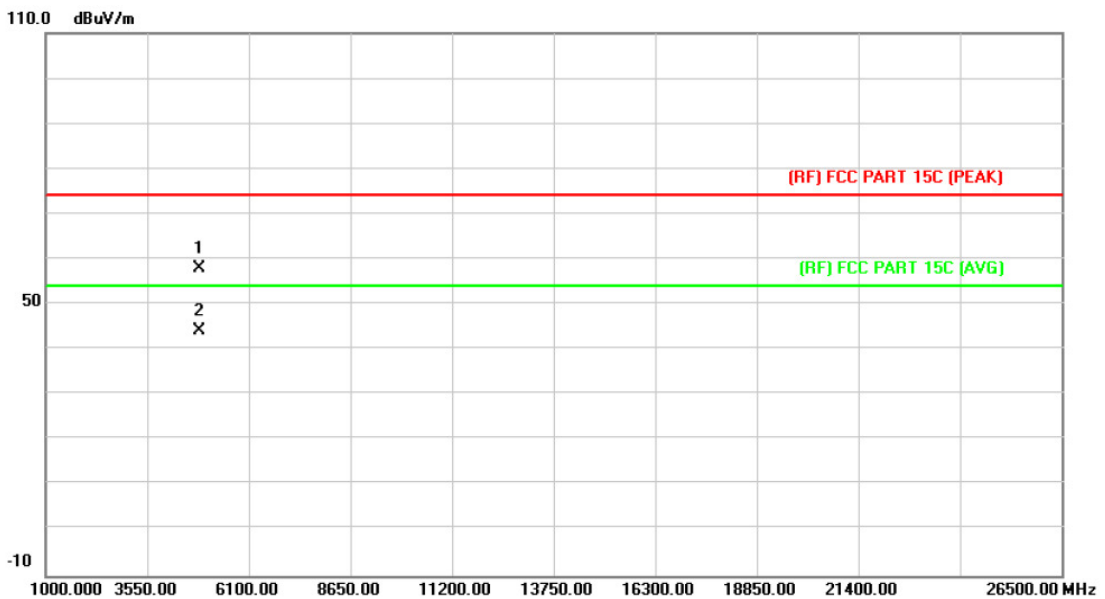

No.	Mk.	Freq. MHz	Reading Level dBuV	Correct Factor dB/m	Measure- ment dBuV/m	Limit dBuV/m	Over dB	Detector
1		4873.718	44.04	13.86	57.90	74.00	-16.10	peak
2	*	4875.305	30.34	13.87	44.21	54.00	-9.79	AVG

Emission Level= Read Level+ Correct Factor

EUT:	Tablet PC	Model:	PTV-R78-3288
Temperature:	25 °C	Relative Humidity:	55%
Test Voltage:	DC 3.7V		
Ant. Pol.	Horizontal		
Test Mode:	TX N(HT20) Mode 2462MHz		
Remark:	No report for the emission which more than 10 dB below the prescribed limit.		

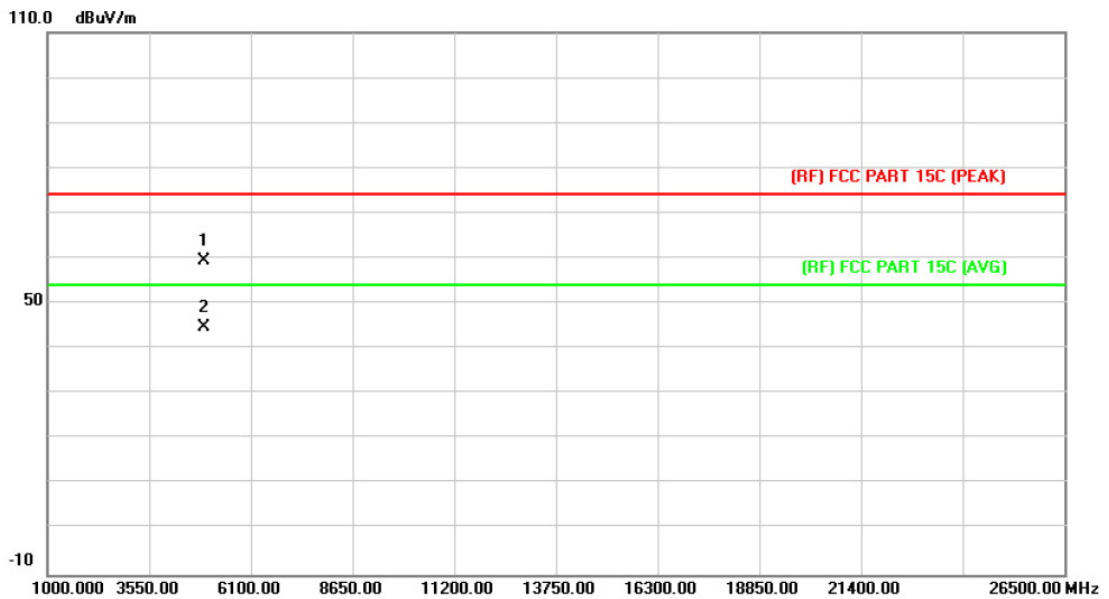

No.	Mk.	Freq.	Reading Level	Correct Factor	Measurement	Limit	Over	Detector
		MHz	dBuV	dB/m	dBuV/m	dBuV/m	dB	
1		4922.749	45.36	14.14	59.50	74.00	-14.50	peak
2	*	4925.119	30.46	14.16	44.62	54.00	-9.38	AVG

Emission Level= Read Level+ Correct Factor

EUT:	Tablet PC	Model:	PTV-R78-3288
Temperature:	25 °C	Relative Humidity:	55%
Test Voltage:	DC 3.7V		
Ant. Pol.	Vertical		
Test Mode:	TX N(HT20) Mode 2462MHz		
Remark:	No report for the emission which more than 10 dB below the prescribed limit.		

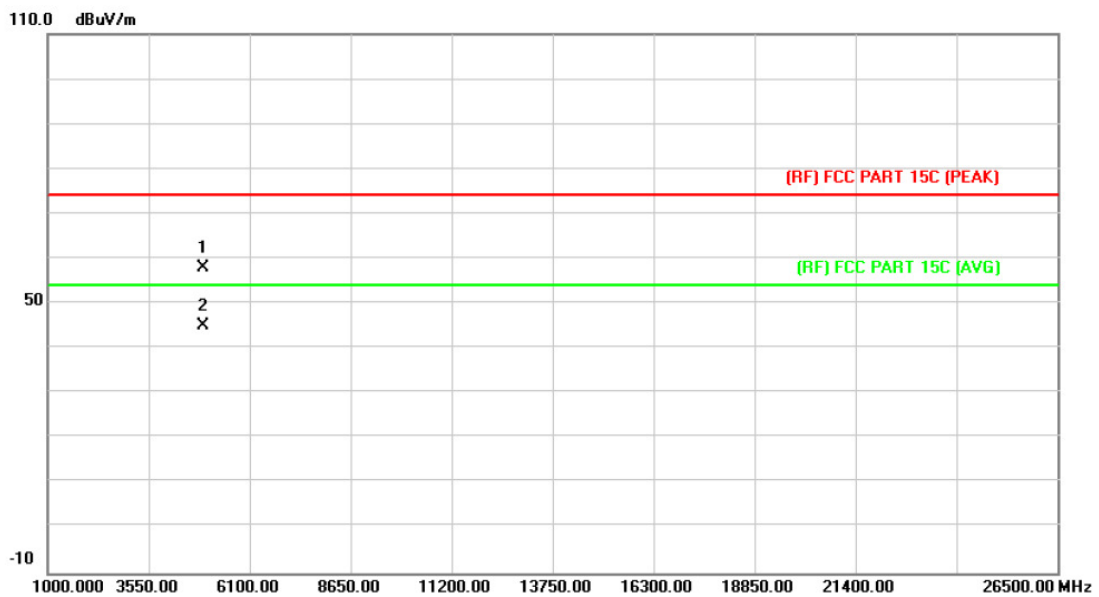

No.	Mk.	Freq.	Reading Level	Correct Factor	Measurement	Limit	Over	Detector
		MHz	dBuV	dB/m	dBuV/m	dBuV/m	dB	
1		4922.944	43.67	14.14	57.81	74.00	-16.19	peak
2	*	4924.960	30.77	14.15	44.92	54.00	-9.08	AVG

Emission Level= Read Level+ Correct Factor

EUT:	Tablet PC	Model:	PTV-R78-3288
Temperature:	25 °C	Relative Humidity:	55%
Test Voltage:	DC 3.7V		
Ant. Pol.	Horizontal		
Test Mode:	TX N(HT40) Mode 2422MHz		
Remark:	No report for the emission which more than 10 dB below the prescribed limit.		

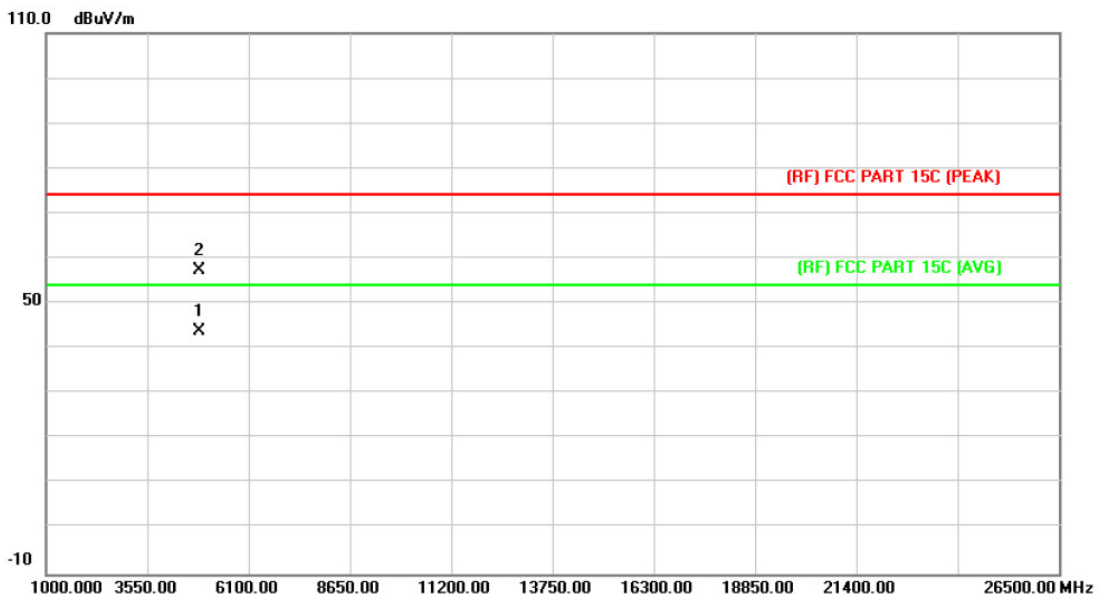

No.	Mk.	Freq.	Reading Level	Correct Factor	Measurement	Limit	Over	Detector
		MHz	dBuV	dB/m	dBuV/m	dBuV/m	dB	
1	*	4843.142	30.27	13.68	43.95	54.00	-10.05	AVG
2		4843.235	43.63	13.68	57.31	74.00	-16.69	peak

Emission Level= Read Level+ Correct Factor

EUT:	Tablet PC	Model:	PTV-R78-3288
Temperature:	25 °C	Relative Humidity:	55%
Test Voltage:	DC 3.7V		
Ant. Pol.	Vertical		
Test Mode:	TX N(HT40) Mode 2422MHz		
Remark:	No report for the emission which more than 10 dB below the prescribed limit.		

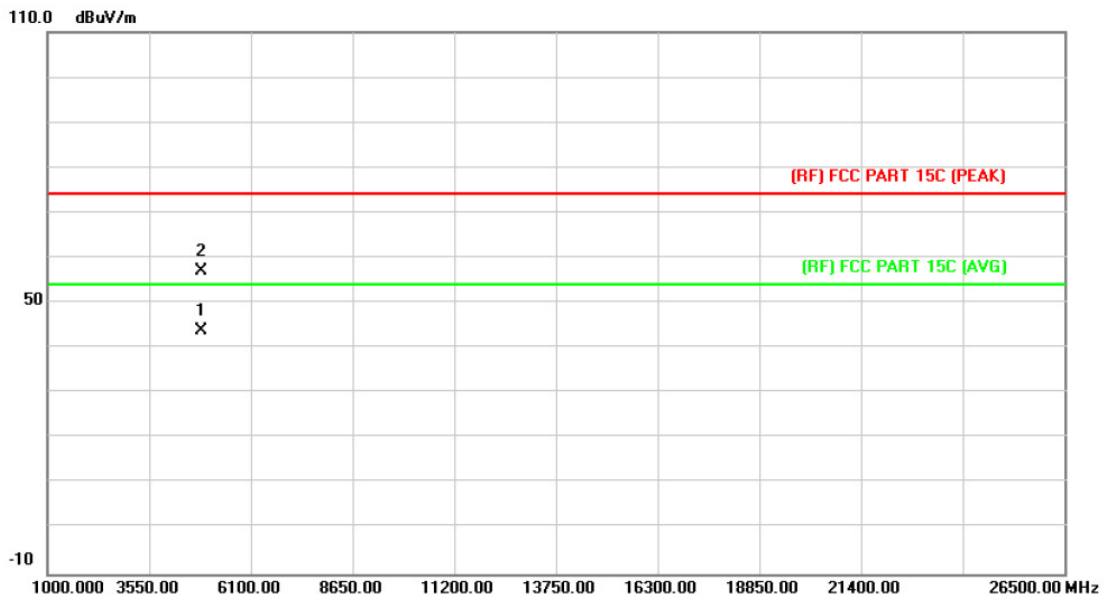

No.	Mk.	Freq. MHz	Reading Level dBuV	Correct Factor dB/m	Measure- ment dBuV/m	Limit dBuV/m	Over dB	Detector
1	*	4843.841	30.18	13.68	43.86	54.00	-10.14	AVG
2		4844.642	43.38	13.68	57.06	74.00	-16.94	peak

Emission Level= Read Level+ Correct Factor

EUT:	Tablet PC	Model:	PTV-R78-3288
Temperature:	25 °C	Relative Humidity:	55%
Test Voltage:	DC 3.7V		
Ant. Pol.	Horizontal		
Test Mode:	TX N(HT40) Mode 2437MHz		
Remark:	No report for the emission which more than 10 dB below the prescribed limit.		

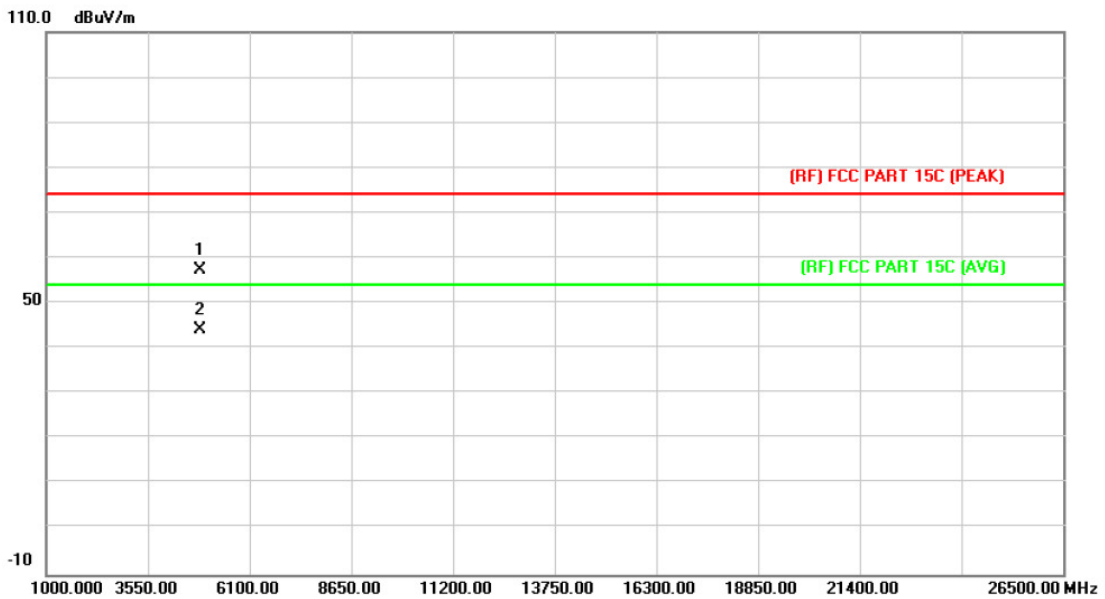

No.	Mk.	Freq.	Reading Level	Correct Factor	Measurement	Limit	Over	Detector
		MHz	dBuV	dB/m	dBuV/m	dBuV/m	dB	
1		4873.553	43.37	13.86	57.23	74.00	-16.77	peak
2	*	4874.486	30.29	13.86	44.15	54.00	-9.85	AVG

Emission Level= Read Level+ Correct Factor

EUT:	Tablet PC	Model:	PTV-R78-3288
Temperature:	25 °C	Relative Humidity:	55%
Test Voltage:	DC 3.7V		
Ant. Pol.	Vertical		
Test Mode:	TX N(HT40) Mode 2437MHz		
Remark:	No report for the emission which more than 10 dB below the prescribed limit.		

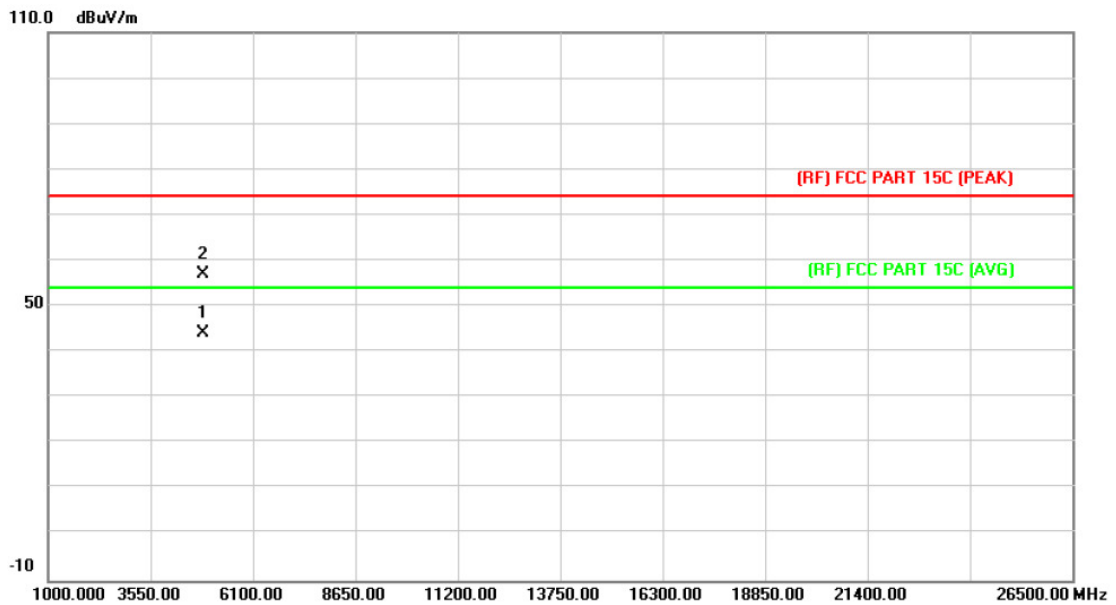

No.	Mk.	Freq. MHz	Reading Level dBuV	Correct Factor dB/m	Measure- ment dBuV/m	Limit dBuV/m	Over dB	Detector
1	*	4873.250	30.29	13.86	44.15	54.00	-9.85	AVG
2		4874.213	43.24	13.86	57.10	74.00	-16.90	peak

Emission Level= Read Level+ Correct Factor

EUT:	Tablet PC	Model:	PTV-R78-3288
Temperature:	25 °C	Relative Humidity:	55%
Test Voltage:	DC 3.7V		
Ant. Pol.	Horizontal		
Test Mode:	TX N(HT40) Mode 2452MHz		
Remark:	No report for the emission which more than 10 dB below the prescribed limit.		

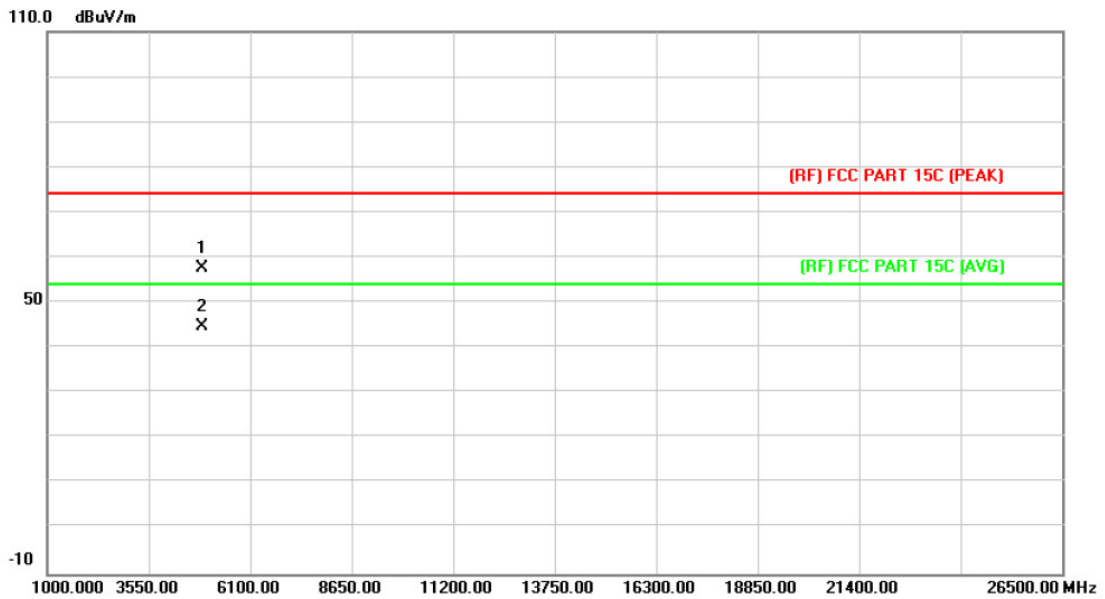

No.	Mk.	Freq.	Reading Level	Correct Factor	Measurement	Limit	Over	Detector
		MHz	dBuV	dB/m	dBuV/m	dBuV/m	dB	
1		4903.508	43.72	14.03	57.75	74.00	-16.25	peak
2	*	4905.146	30.60	14.04	44.64	54.00	-9.36	AVG

Emission Level= Read Level+ Correct Factor

EUT:	Tablet PC	Model:	PTV-R78-3288
Temperature:	25 °C	Relative Humidity:	55%
Test Voltage:	DC 3.7V		
Ant. Pol.	Vertical		
Test Mode:	TX N(HT40) Mode 2452MHz		
Remark:	No report for the emission which more than 10 dB below the prescribed limit.		

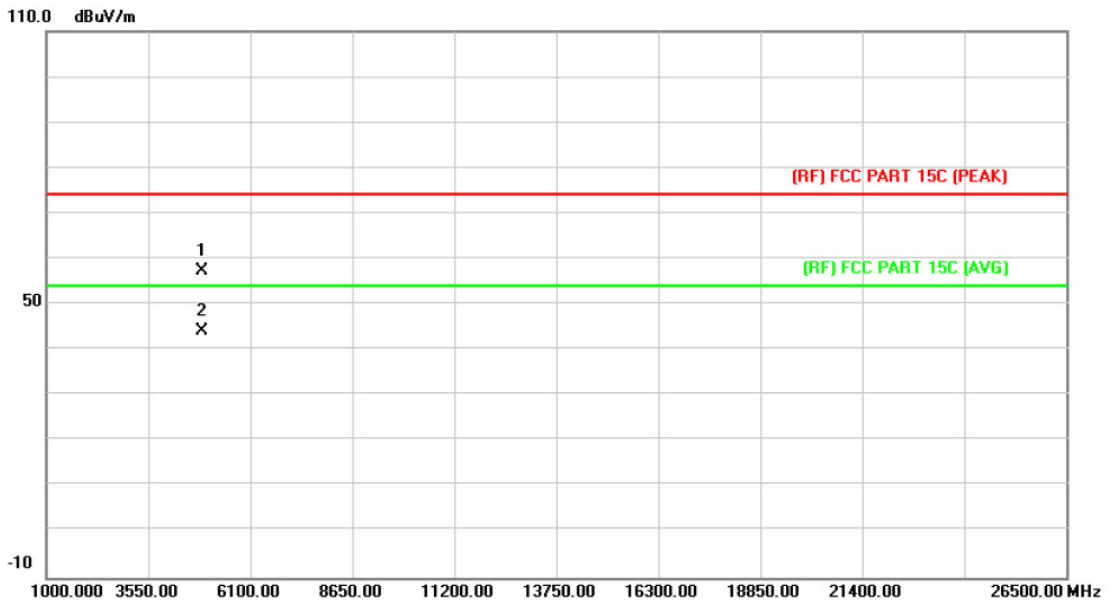

No.	Mk.	Freq. MHz	Reading Level dBuV	Correct Factor dB/m	Measure- ment dBuV/m	Limit dBuV/m	Over dB	Detector
1		4904.231	43.47	14.03	57.50	74.00	-16.50	peak
2	*	4904.870	30.25	14.03	44.28	54.00	-9.72	AVG

Emission Level= Read Level+ Correct Factor

6. Restricted Bands Requirement

6.1 Test Standard and Limit

- 6.1.1 Test Standard
 - FCC Part 15.247(d)
 - FCC Part 15.209
 - FCC Part 15.205

6.1.2 Test Limit

Restricted Frequency Band (MHz)	Distance of 3m (dBuV/m)	
	Peak	Average
2310 ~2390	74	54
2483.5 ~2500	74	54

6.2 Test Setup

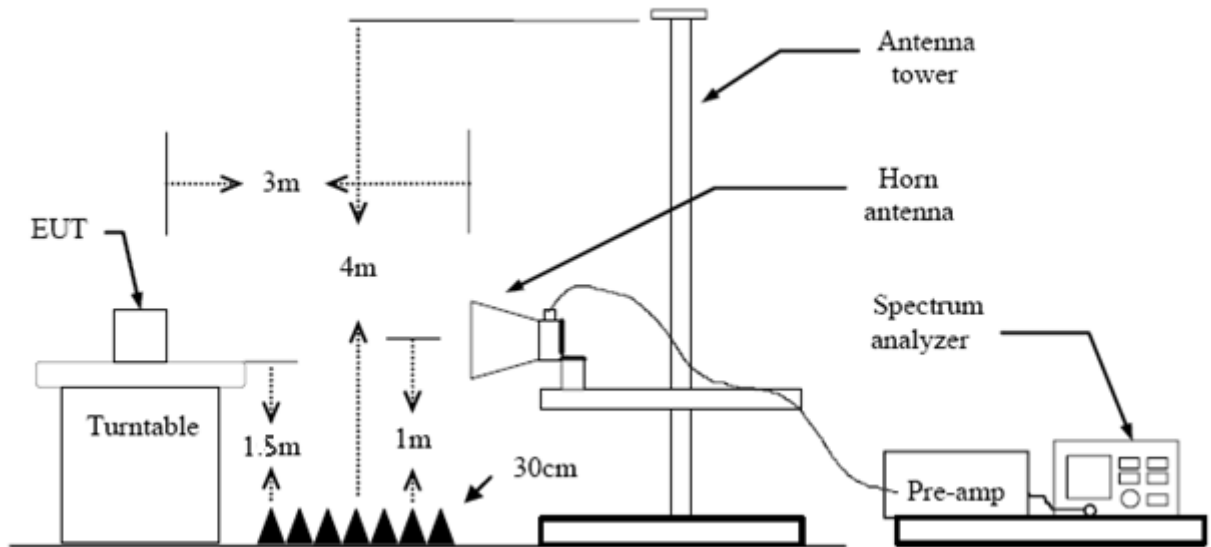

6.3 Test Procedure

- (1) The measuring distance of 3m shall be used for measurements at frequency up to 1GHz and above 1 GHz. The EUT was placed on a rotating 0.8m high above ground, the table was rotated 360 degrees to determine the position of the highest radiation.
- (2) Measurements at frequency above 1GHz. The EUT was placed on a rotating 1.5m high above the ground. RF absorbers covered the ground plane with a minimum area of 3.0m by 3.0m between the EUT and measurement receiver antenna. The RF absorber shall not exceed 30cm in high above the conducting floor. The table was rotated 360 degrees to determine the position of the highest radiation.

- (3) The Test antenna shall vary between 1m and 4m, Both Horizontal and Vertical antenna are set to make measurement.
- (4) The initial step in collecting conducted emission data is a spectrum analyzer peak detector mode pre-scanning the measurement frequency range. Significant peaks are then marked and then Quasi Peak detector mode re-measured.
- (5) If the Peak Mode measured value compliance with and lower than Quasi Peak Mode Limit Bellow 1 GHz, the EUT shall be deemed to meet QP Limits and then no additional QP Mode measurement performed. But the Peak Value and average value both need to comply with applicable limit above 1 GHz.
- (6) Testing frequency range below 1GHz the measuring instrument use VBW=120 kHz with Quasi-peak detection.
- (7) Testing frequency range above 1GHz the measuring instrument use RBW=1 MHz and VBW=3 MHz with Peak Detector for Peak Values, and use RBW=1 MHz and VBW=10 Hz with Peak Detector for Average Values.
- (8) For the actual test configuration, please see the test setup photo.

6.4 EUT Operating Condition

The Equipment Under Test was set to Continual Transmitting in maximum power.

6.5 Test Data

Please see the next page.

(1) Radiation Test

EUT:	Tablet PC	Model:	PTV-R78-3288
Temperature:	25 °C	Relative Humidity:	55%
Test Voltage:	DC 3.7V		
Ant. Pol.	Horizontal		
Test Mode:	TX B Mode 2412MHz		
Remark:	N/A		

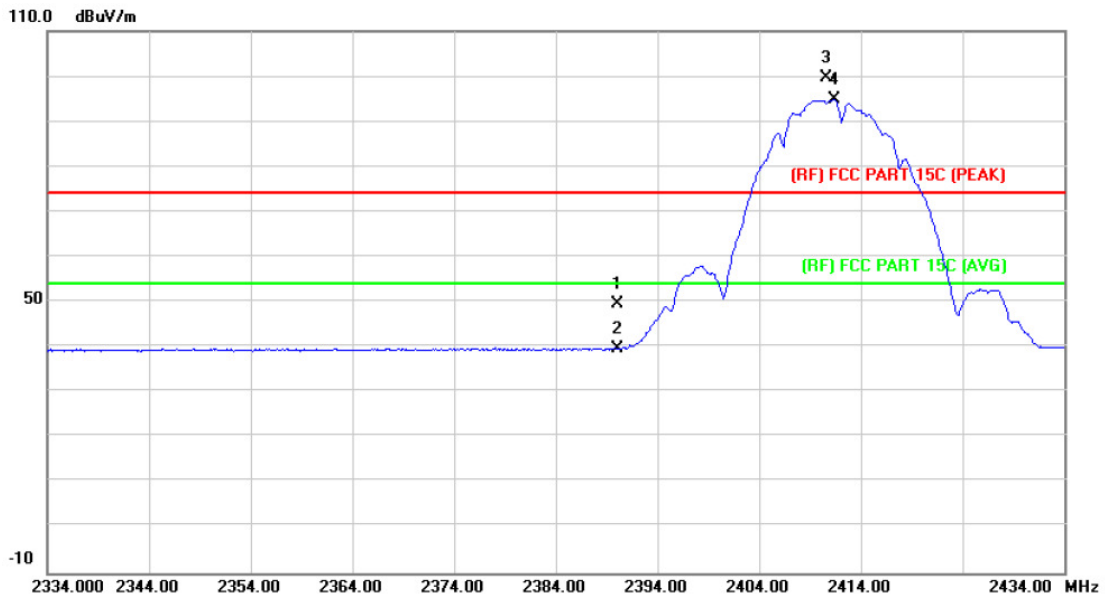

No.	Mk.	Freq.	Reading Level	Correct Factor	Measurement	Limit	Over	
		MHz	dBuV	dB/m	dBuV/m	dBuV/m	dB	Detector
1		2390.000	48.71	0.77	49.48	74.00	-24.52	peak
2		2390.000	38.86	0.77	39.63	54.00	-14.37	AVG
3	X	2410.600	98.78	0.86	99.64	Fundamental Frequency		peak
4	*	2411.400	93.98	0.86	94.84	Fundamental Frequency		AVG

Emission Level= Read Level+ Correct Factor

EUT:	Tablet PC	Model:	PTV-R78-3288
Temperature:	25 °C	Relative Humidity:	55%
Test Voltage:	DC 3.7V		
Ant. Pol.	Vertical		
Test Mode:	TX B Mode 2412MHz		
Remark:	N/A		

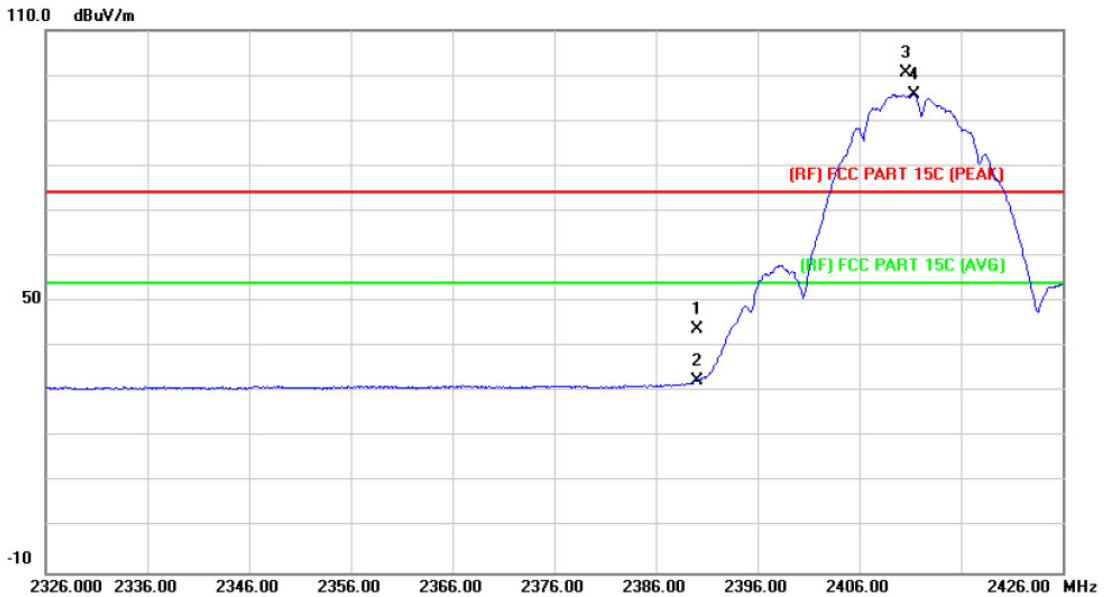

No.	Mk.	Freq. MHz	Reading Level dBuV	Correct Factor dB/m	Measure- ment dBuV/m	Limit dBuV/m	Over dB	Detector
1		2390.000	43.22	0.77	43.99	74.00	-30.01	peak
2		2390.000	31.73	0.77	32.50	54.00	-21.50	AVG
3	X	2410.600	99.73	0.86	100.59	Fundamental Frequency		peak
4	*	2411.400	95.03	0.86	95.89	Fundamental Frequency		AVG

Emission Level= Read Level+ Correct Factor

EUT:	Tablet PC	Model:	PTV-R78-3288
Temperature:	25 °C	Relative Humidity:	55%
Test Voltage:	DC 3.7V		
Ant. Pol.	Horizontal		
Test Mode:	TX B Mode 2462MHz		
Remark:	N/A		

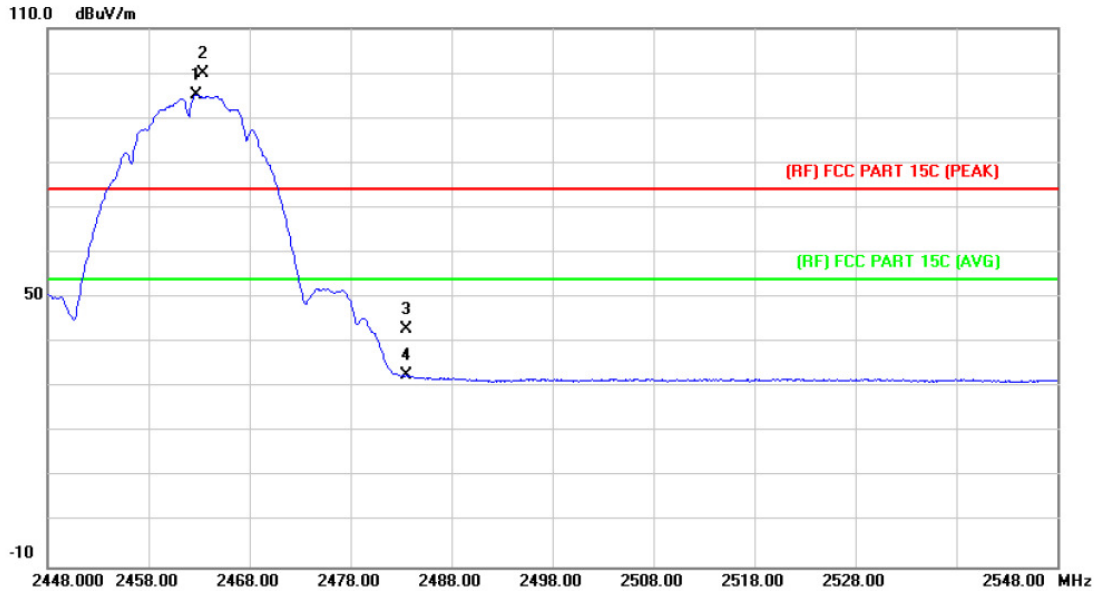

No.	Mk.	Freq. MHz	Reading Level dBuV	Correct Factor dB/m	Measure- ment dBuV/m	Limit dBuV/m	Over dB	Detector
1	*	2462.700	94.09	1.08	95.17	Fundamental Frequency		AVG
2	X	2463.400	98.87	1.08	99.95	Fundamental Frequency		peak
3		2483.500	41.64	1.17	42.81	74.00	-31.19	peak
4		2483.500	31.49	1.17	32.66	54.00	-21.34	AVG

Emission Level= Read Level+ Correct Factor

EUT:	Tablet PC	Model:	PTV-R78-3288
Temperature:	25 °C	Relative Humidity:	55%
Test Voltage:	DC 3.7V		
Ant. Pol.	Vertical		
Test Mode:	TX B Mode 2462MHz		
Remark:	N/A		

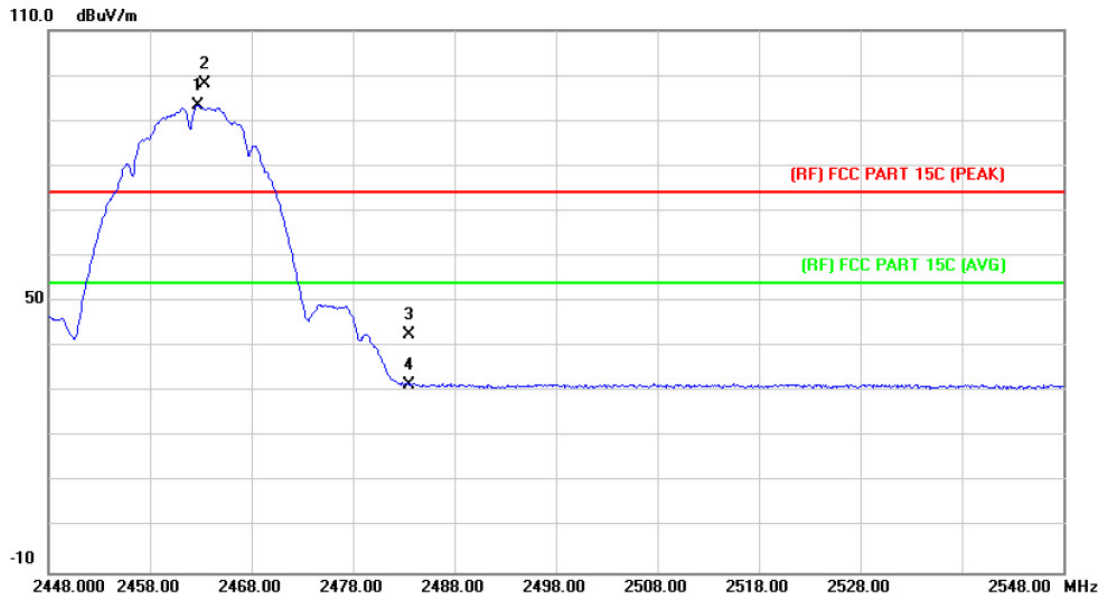

No.	Mk.	Freq. MHz	Reading Level dBuV	Correct Factor dB/m	Measure- ment dBuV/m	Limit dBuV/m	Over dB	Detector
1	*	2462.700	92.28	1.08	93.36	Fundamental Frequency		AVG
2	X	2463.400	96.96	1.08	98.04	Fundamental Frequency		peak
3		2483.500	41.36	1.17	42.53	74.00	-31.47	peak
4		2483.500	30.51	1.17	31.68	54.00	-22.32	AVG

Emission Level= Read Level+ Correct Factor

EUT:	Tablet PC	Model:	PTV-R78-3288
Temperature:	25 °C	Relative Humidity:	55%
Test Voltage:	DC 3.7V		
Ant. Pol.	Horizontal		
Test Mode:	TX G Mode 2412MHz		
Remark:	N/A		

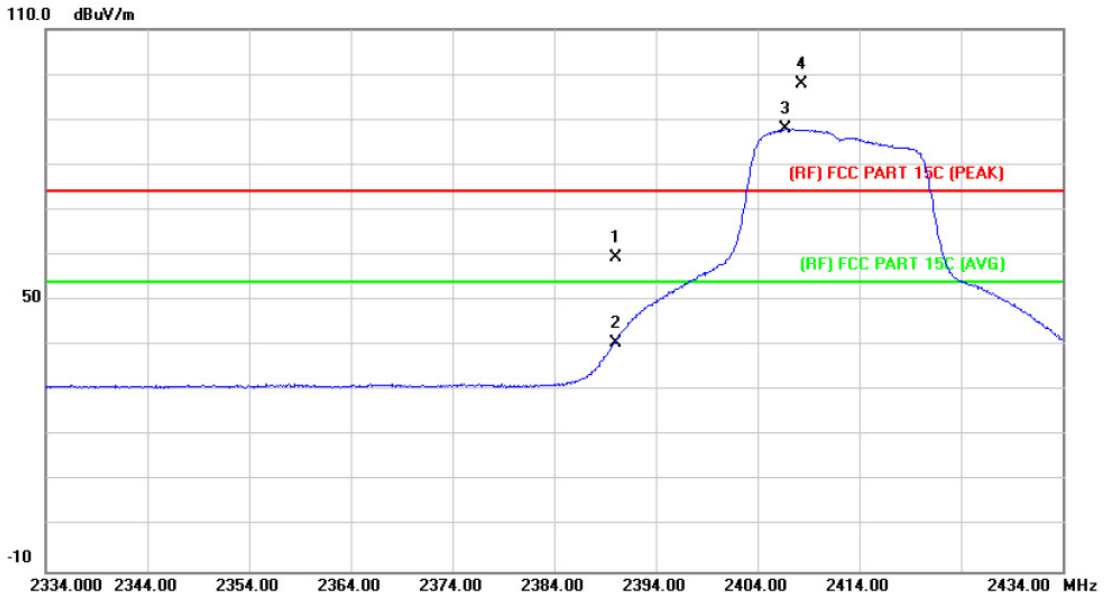

No.	Mk.	Freq. MHz	Reading Level dBuV	Correct Factor dB/m	Measure- ment dBuV/m	Limit dBuV/m	Over dB	Detector
1		2390.000	58.58	0.77	59.35	74.00	-14.65	peak
2		2390.000	39.81	0.77	40.58	54.00	-13.42	AVG
3	*	2406.700	87.08	0.84	87.92	Fundamental Frequency		AVG
4	X	2408.300	96.89	0.85	97.74	Fundamental Frequency		peak

Emission Level= Read Level+ Correct Factor

EUT:	Tablet PC	Model:	PTV-R78-3288
Temperature:	25 °C	Relative Humidity:	55%
Test Voltage:	DC 3.7V		
Ant. Pol.	Vertical		
Test Mode:	TX G Mode 2412MHz		
Remark:	N/A		

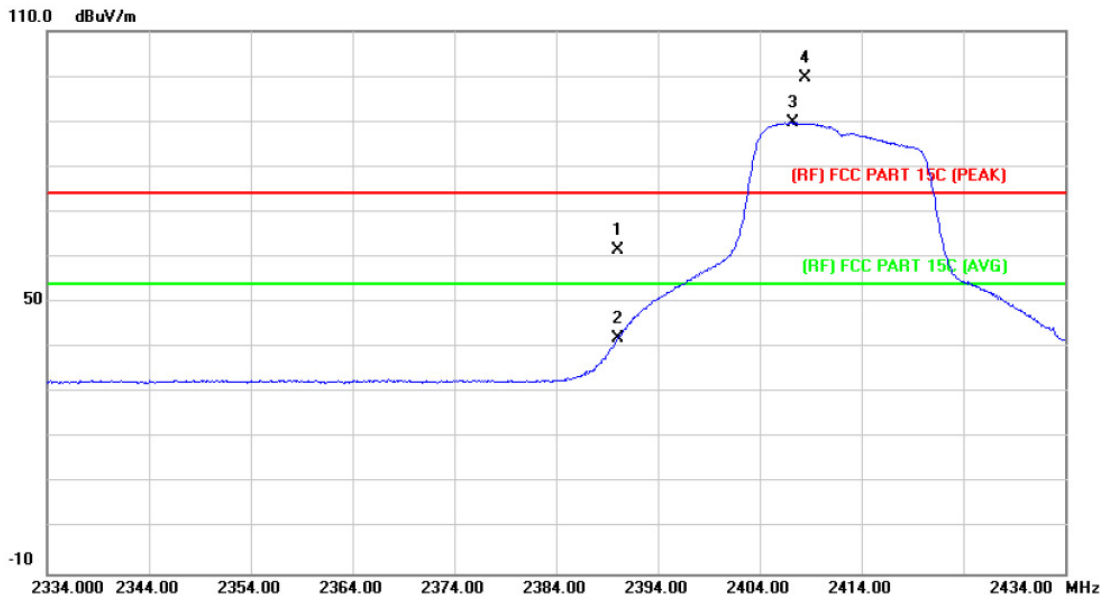

No.	Mk.	Freq. MHz	Reading Level dBuV	Correct Factor dB/m	Measure- ment dBuV/m	Limit dBuV/m	Over dB	Detector
1		2390.000	60.81	0.77	61.58	74.00	-12.42	peak
2		2390.000	41.28	0.77	42.05	54.00	-11.95	AVG
3	*	2407.300	88.91	0.85	89.76	Fundamental Frequency		AVG
4	X	2408.500	98.81	0.85	99.66	Fundamental Frequency		peak

Emission Level= Read Level+ Correct Factor

EUT:	Tablet PC	Model:	PTV-R78-3288
Temperature:	25 °C	Relative Humidity:	55%
Test Voltage:	DC 3.7V		
Ant. Pol.	Horizontal		
Test Mode:	TX G Mode 2462MHz		
Remark:	N/A		

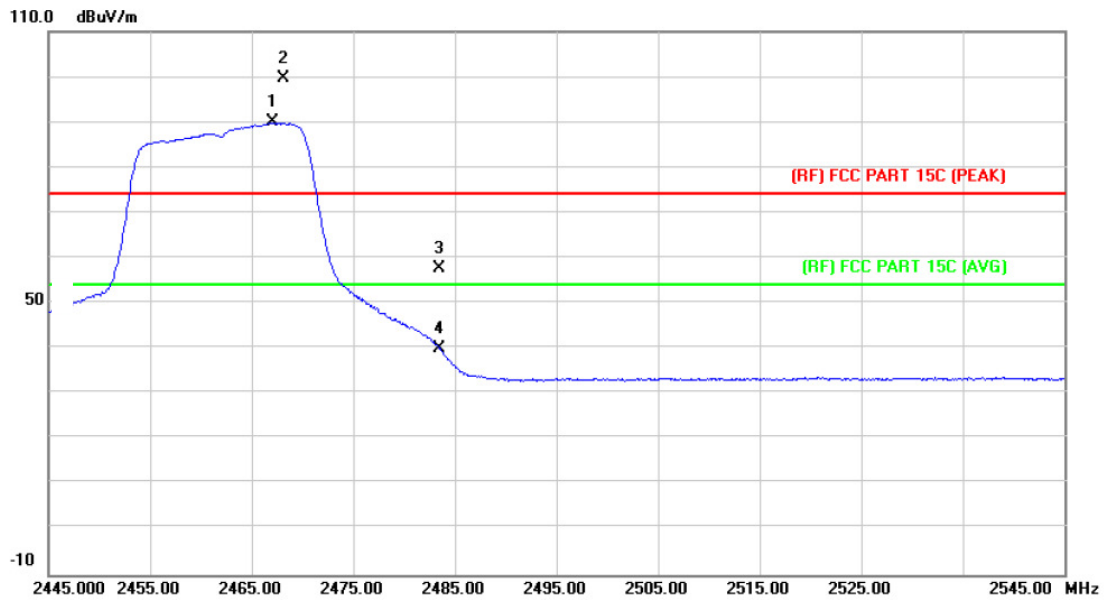

No.	Mk.	Freq. MHz	Reading Level dBuV	Correct Factor dB/m	Measure- ment dBuV/m	Limit dBuV/m	Over dB	Detector
1	*	2467.000	88.80	1.10	89.90	Fundamental Frequency		AVG
2	X	2468.200	98.63	1.11	99.74	Fundamental Frequency		peak
3		2483.500	56.38	1.17	57.55	74.00	-16.45	peak
4		2483.500	38.73	1.17	39.90	54.00	-14.10	AVG

Emission Level= Read Level+ Correct Factor

EUT:	Tablet PC	Model:	PTV-R78-3288
Temperature:	25 °C	Relative Humidity:	55%
Test Voltage:	DC 3.7V		
Ant. Pol.	Vertical		
Test Mode:	TX G Mode 2462MHz		
Remark:	N/A		

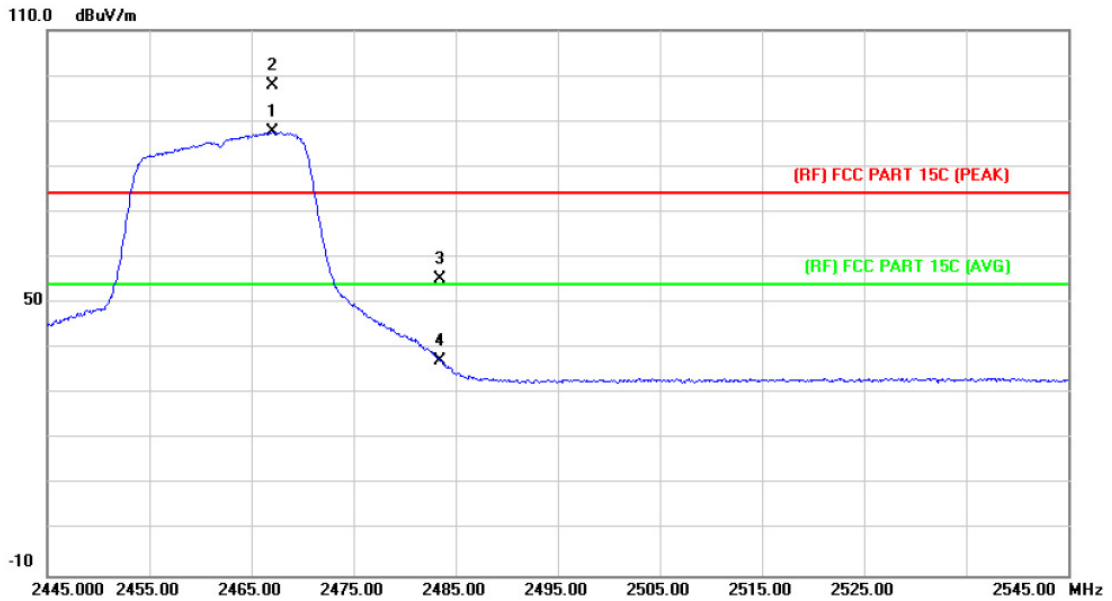

No.	Mk.	Freq. MHz	Reading Level dBuV	Correct Factor dB/m	Measure- ment dBuV/m	Limit dBuV/m	Over dB	Detector
1	*	2467.000	86.63	1.10	87.73	Fundamental Frequency		AVG
2	X	2467.100	96.77	1.10	97.87	Fundamental Frequency		peak
3		2483.500	53.96	1.17	55.13	74.00	-18.87	peak
4		2483.500	36.09	1.17	37.26	54.00	-16.74	AVG

Emission Level= Read Level+ Correct Factor

EUT:	Tablet PC	Model:	PTV-R78-3288
Temperature:	25 °C	Relative Humidity:	55%
Test Voltage:	DC 3.7V		
Ant. Pol.	Horizontal		
Test Mode:	TX N(HT20) Mode 2412MHz		
Remark:	N/A		

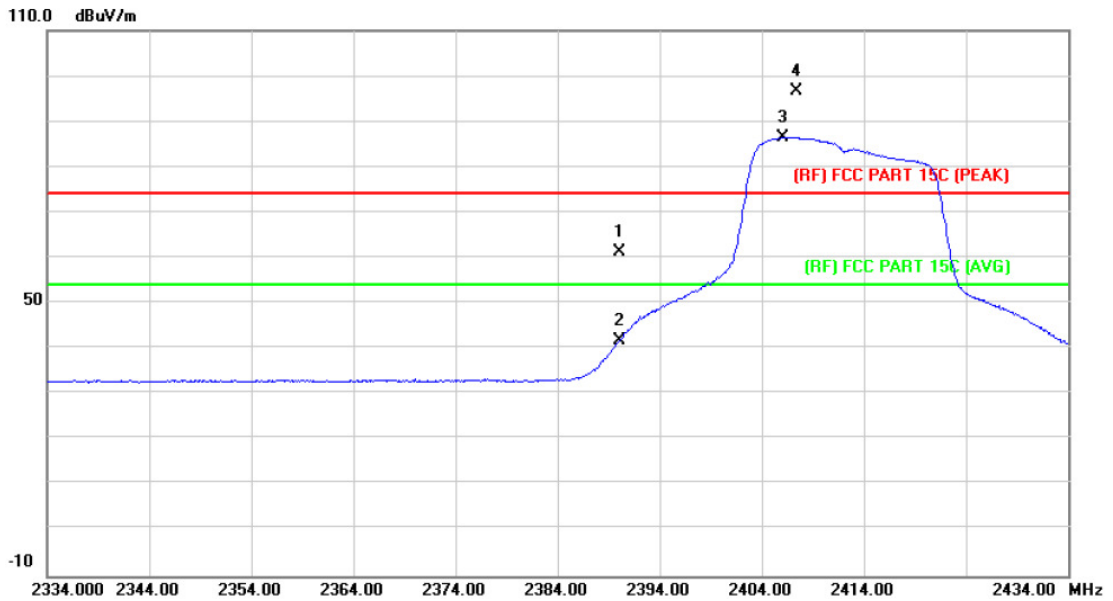

No.	Mk.	Freq. MHz	Reading Level dBuV	Correct Factor dB/m	Measure- ment dBuV/m	Limit dBuV/m	Over dB	Detector
1		2390.000	60.60	0.77	61.37	74.00	-12.63	peak
2		2390.000	40.85	0.77	41.62	54.00	-12.38	AVG
3	*	2406.000	85.69	0.84	86.53	Fundamental Frequency		AVG
4	X	2407.400	95.91	0.85	96.76	Fundamental Frequency		peak

Emission Level= Read Level+ Correct Factor

EUT:	Tablet PC	Model:	PTV-R78-3288
Temperature:	25 °C	Relative Humidity:	55%
Test Voltage:	DC 3.7V		
Ant. Pol.	Vertical		
Test Mode:	TX N(HT20) Mode 2412MHz		
Remark:	N/A		

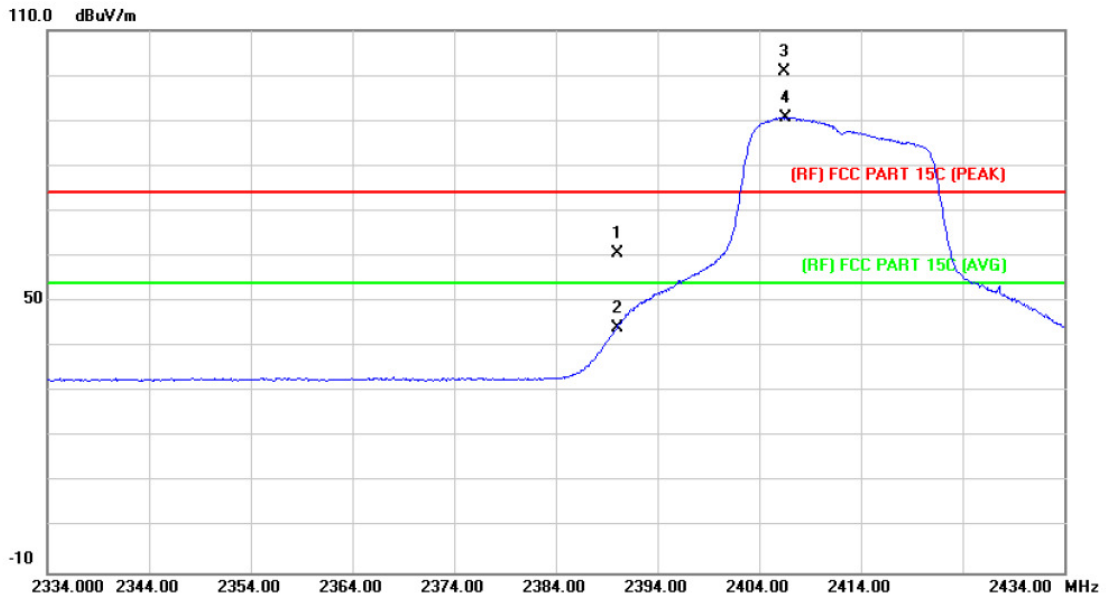

No.	Mk.	Freq. MHz	Reading Level dBuV	Correct Factor dB/m	Measure- ment dBuV/m	Limit dBuV/m	Over dB	Detector
1		2390.000	59.74	0.77	60.51	74.00	-13.49	peak
2		2390.000	43.44	0.77	44.21	54.00	-9.79	AVG
3	X	2406.500	100.10	0.84	100.94	Fundamental Frequency		peak
4	*	2406.600	89.96	0.84	90.80	Fundamental Frequency		AVG

Emission Level= Read Level+ Correct Factor

EUT:	Tablet PC	Model:	PTV-R78-3288
Temperature:	25 °C	Relative Humidity:	55%
Test Voltage:	DC 3.7V		
Ant. Pol.	Horizontal		
Test Mode:	TX N(HT20) Mode 2462MHz		
Remark:	N/A		

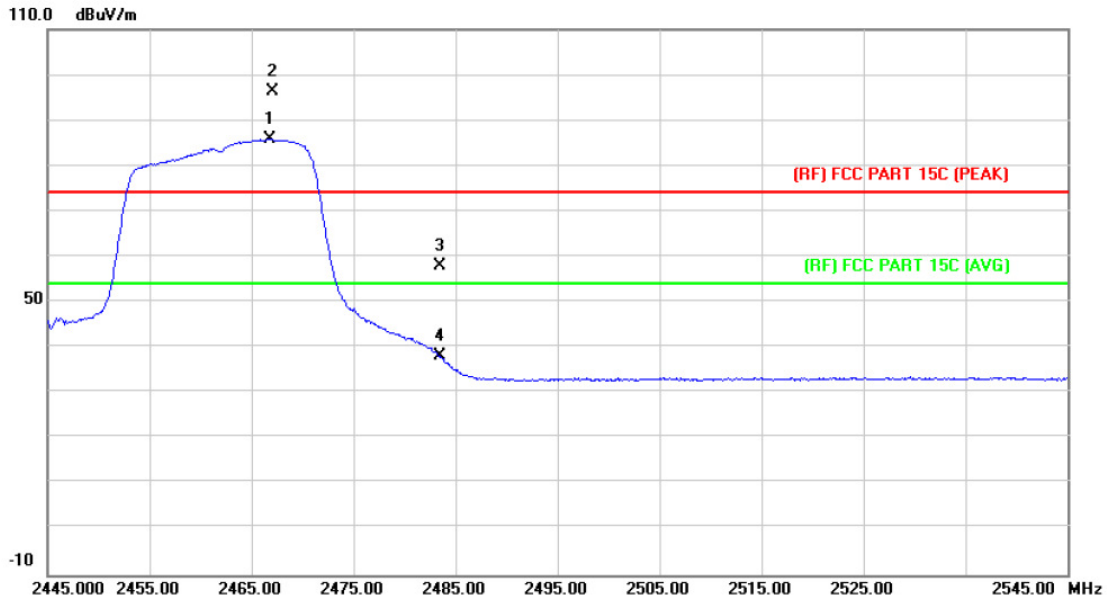

No.	Mk.	Freq. MHz	Reading Level dBuV	Correct Factor dB/m	Measure- ment dBuV/m	Limit dBuV/m	Over dB	Detector
1	*	2466.800	84.73	1.10	85.83	Fundamental Frequency		AVG
2	X	2467.000	95.31	1.10	96.41	Fundamental Frequency		peak
3		2483.500	56.85	1.17	58.02	74.00	-15.98	peak
4		2483.500	37.01	1.17	38.18	54.00	-15.82	AVG

Emission Level= Read Level+ Correct Factor

EUT:	Tablet PC	Model:	PTV-R78-3288
Temperature:	25 °C	Relative Humidity:	55%
Test Voltage:	DC 3.7V		
Ant. Pol.	Vertical		
Test Mode:	TX N(HT20) Mode 2462MHz		
Remark:	N/A		

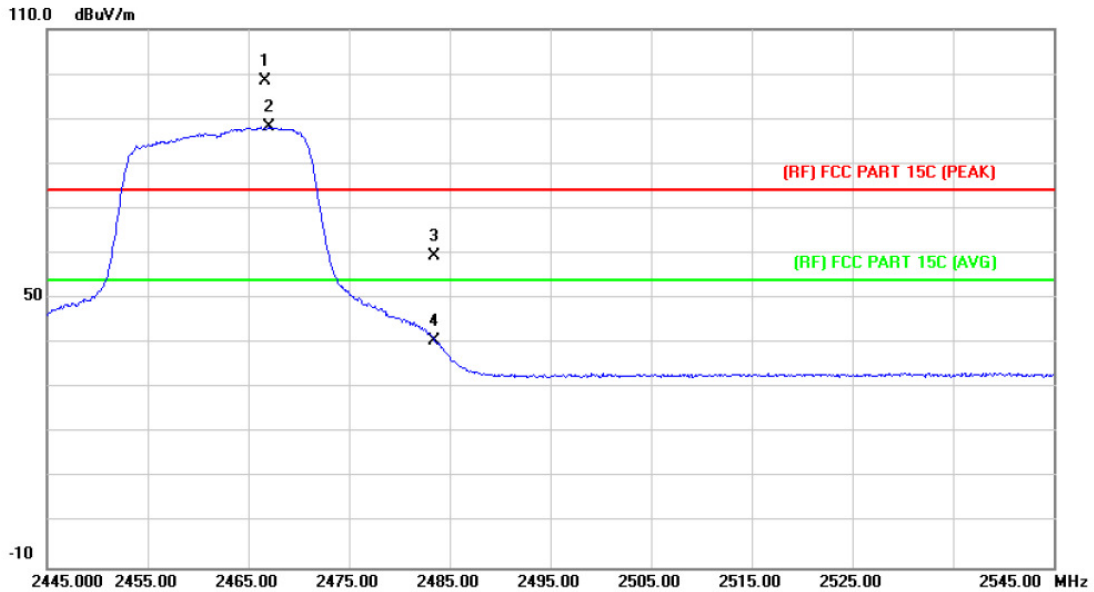

No.	Mk.	Freq. MHz	Reading Level dBuV	Correct Factor dB/m	Measure- ment dBuV/m	Limit dBuV/m	Over dB	Detector
1	X	2466.700	97.26	1.10	98.36	Fundamental Frequency		peak
2	*	2467.000	87.21	1.10	88.31	Fundamental Frequency		AVG
3		2483.500	58.14	1.17	59.31	74.00	-14.69	peak
4		2483.500	39.36	1.17	40.53	54.00	-13.47	AVG

Emission Level= Read Level+ Correct Factor

EUT:	Tablet PC	Model:	PTV-R78-3288
Temperature:	25 °C	Relative Humidity:	55%
Test Voltage:	DC 3.7V		
Ant. Pol.	Horizontal		
Test Mode:	TX N(HT40) Mode 2422MHz		
Remark:	N/A		

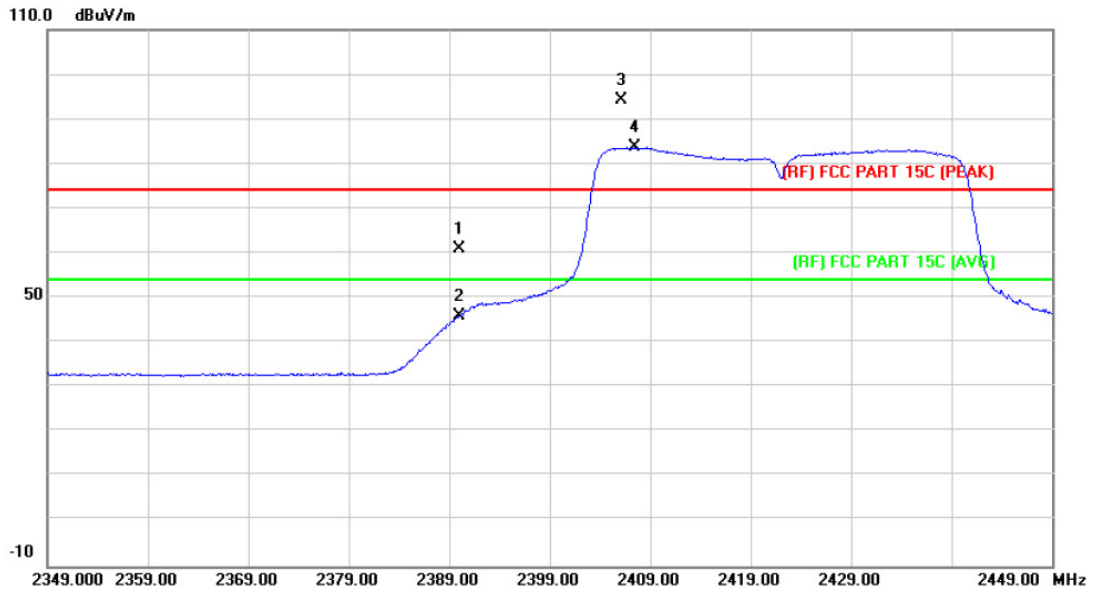

No.	Mk.	Freq. MHz	Reading Level dBuV	Correct Factor dB/m	Measure- ment dBuV/m	Limit dBuV/m	Over dB	Detector
1		2390.000	60.19	0.77	60.96	74.00	-13.04	peak
2		2390.000	45.17	0.77	45.94	54.00	-8.06	AVG
3	X	2406.200	93.49	0.84	94.33	Fundamental Frequency		peak
4	*	2407.500	82.86	0.85	83.71	Fundamental Frequency		AVG

Emission Level= Read Level+ Correct Factor

EUT:	Tablet PC	Model:	PTV-R78-3288
Temperature:	25 °C	Relative Humidity:	55%
Test Voltage:	DC 3.7V		
Ant. Pol.	Vertical		
Test Mode:	TX N(HT40) Mode 2422MHz		
Remark:	N/A		

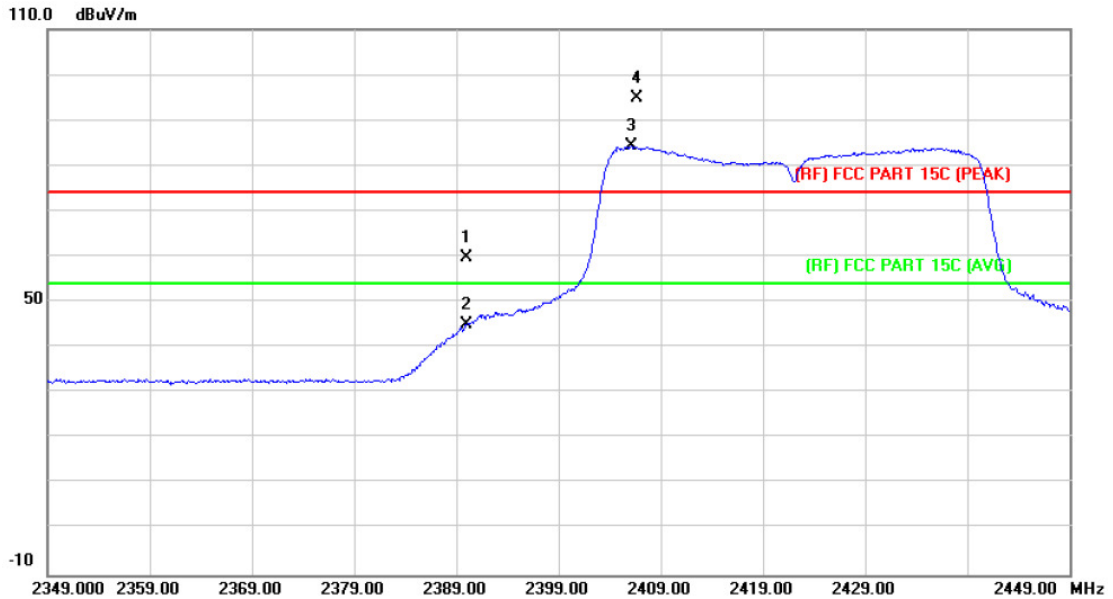

No.	Mk.	Freq. MHz	Reading Level dBuV	Correct Factor dB/m	Measure- ment dBuV/m	Limit dBuV/m	Over dB	Detector
1		2390.000	59.04	0.77	59.81	74.00	-14.19	peak
2		2390.000	44.39	0.77	45.16	54.00	-8.84	AVG
3	*	2406.100	83.45	0.84	84.29	Fundamental Frequency		AVG
4	X	2406.700	94.02	0.84	94.86	Fundamental Frequency		peak

Emission Level= Read Level+ Correct Factor

EUT:	Tablet PC	Model:	PTV-R78-3288
Temperature:	25 °C	Relative Humidity:	55%
Test Voltage:	DC 3.7V		
Ant. Pol.	Horizontal		
Test Mode:	TX N(HT40) Mode 2452MHz		
Remark:	N/A		

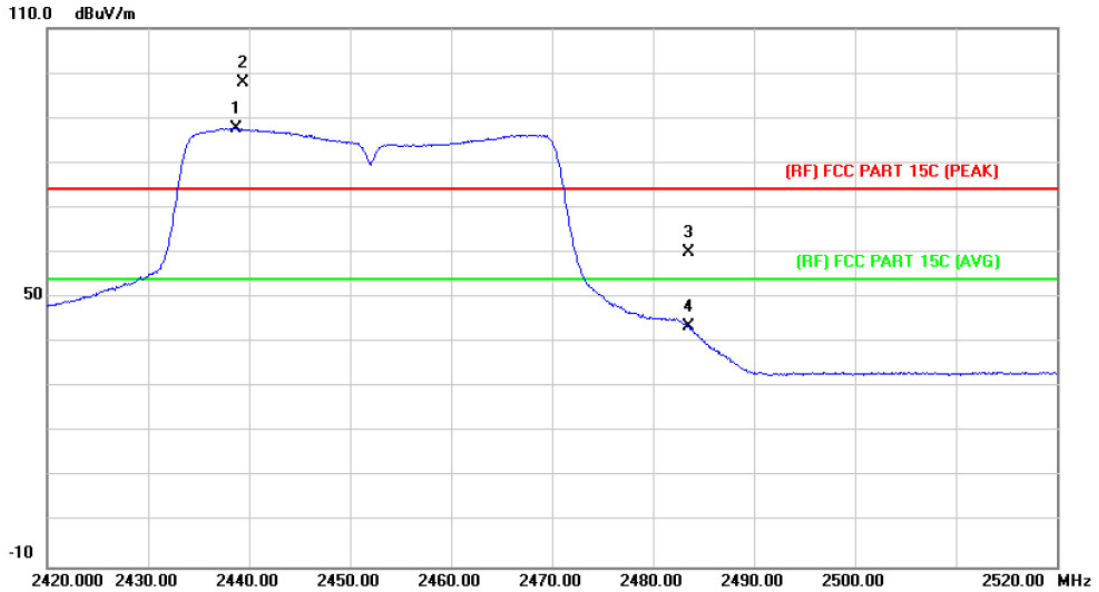

No.	Mk.	Freq. MHz	Reading Level dBuV	Correct Factor dB/m	Measure- ment dBuV/m	Limit dBuV/m	Over dB	Detector
1	*	2438.700	86.78	0.98	87.76	Fundamental Frequency		AVG
2	X	2439.400	97.00	0.98	97.98	Fundamental Frequency		peak
3		2483.500	58.76	1.17	59.93	74.00	-14.07	peak
4		2483.500	42.43	1.17	43.60	54.00	-10.40	AVG

Emission Level= Read Level+ Correct Factor

EUT:	Tablet PC	Model:	PTV-R78-3288
Temperature:	25 °C	Relative Humidity:	55%
Test Voltage:	DC 3.7V		
Ant. Pol.	Vertical		
Test Mode:	TX N(HT40) Mode 2452MHz		
Remark:	N/A		

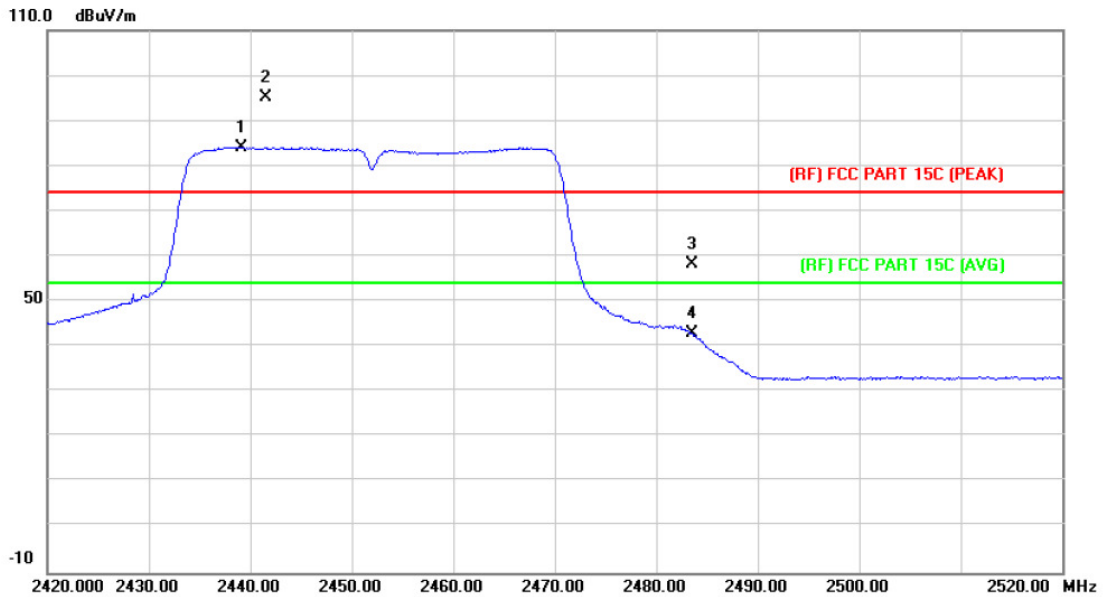

No.	Mk.	Freq. MHz	Reading Level dBuV	Correct Factor dB/m	Measure- ment dBuV/m	Limit dBuV/m	Over dB	Detector
1	*	2439.100	83.20	0.98	84.18	Fundamental Frequency		AVG
2	X	2441.600	94.09	0.99	95.08	Fundamental Frequency		peak
3		2483.500	57.23	1.17	58.40	74.00	-15.60	peak
4		2483.500	41.73	1.17	42.90	54.00	-11.10	AVG

Emission Level= Read Level+ Correct Factor

(2) Conducted Test

EUT:	Tablet PC	Model:	PTV-R78-3288
Temperature:	25 °C	Relative Humidity:	55%
Test Voltage:	DC 3.7V		
Test Mode:	TX B Mode 2412MHz / TX B Mode 2462MHz		
Remark:	The EUT is programed in continuously transmitting mode		

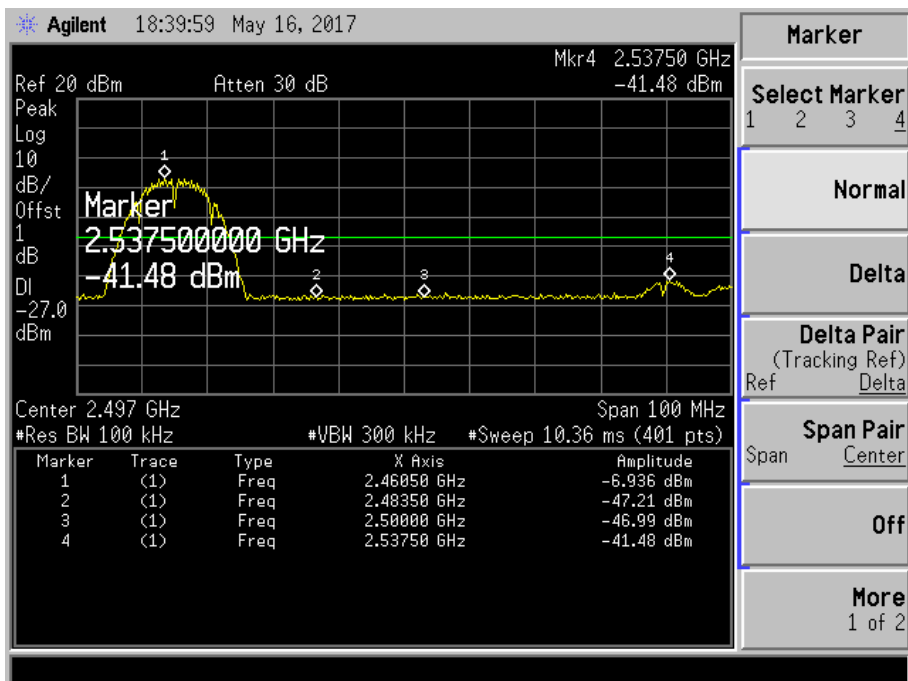
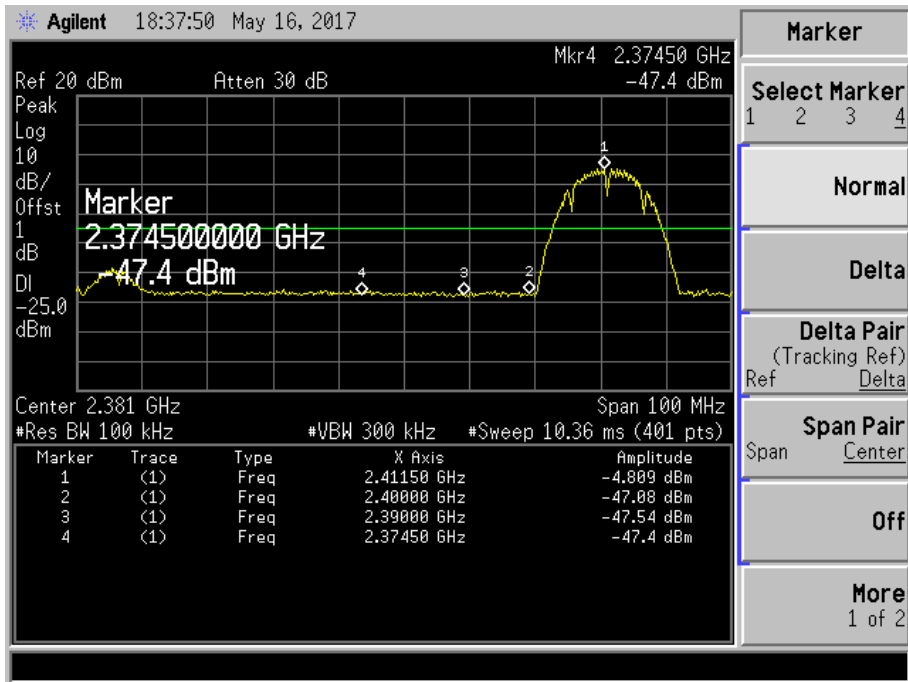

EUT:	Tablet PC	Model:	PTV-R78-3288
Temperature:	25 °C	Relative Humidity:	55%
Test Voltage:	DC 3.7V		
Test Mode:	TX G Mode 2412MHz / TX G Mode 2462MHz		
Remark:	The EUT is programed in continuously transmitting mode		

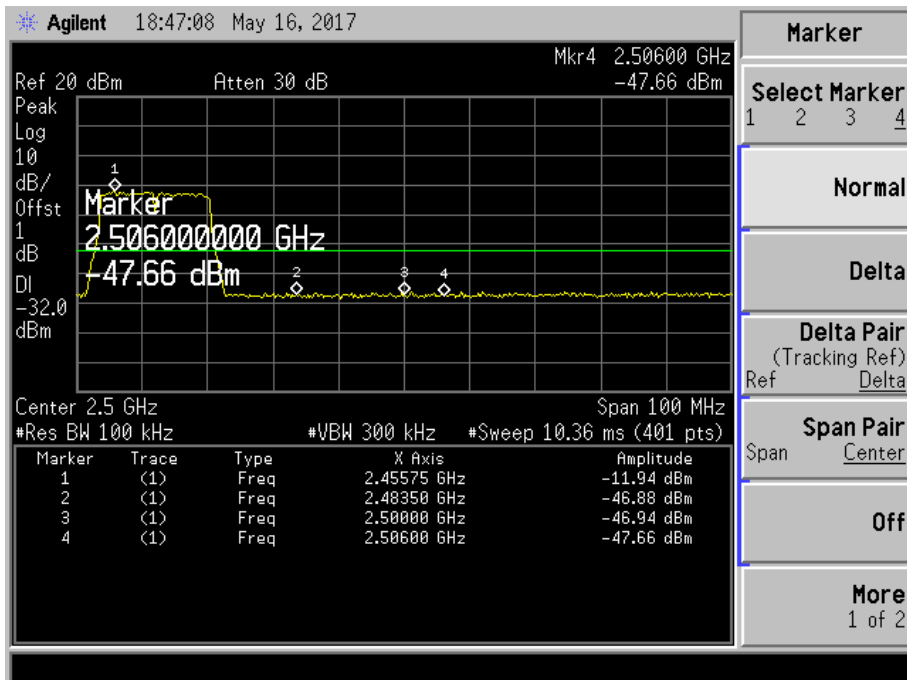
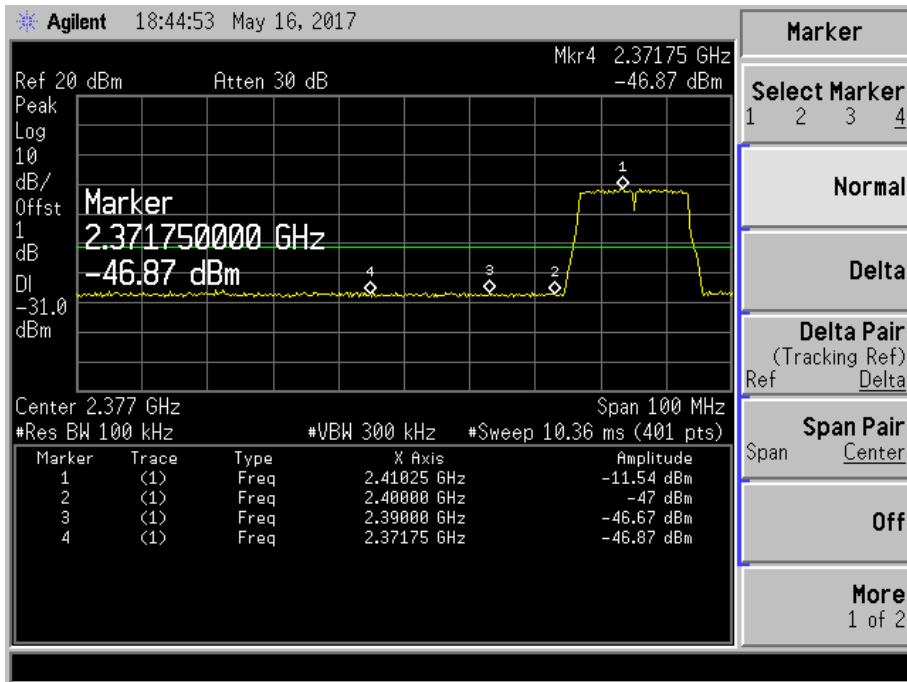

EUT:	Tablet PC	Model:	PTV-R78-3288
Temperature:	25 °C	Relative Humidity:	55%
Test Voltage:	DC 3.7V		
Test Mode:	TX N(HT20) Mode 2412MHz / TX N(HT20) Mode 2462MHz		
Remark:	The EUT is programed in continuously transmitting mode		

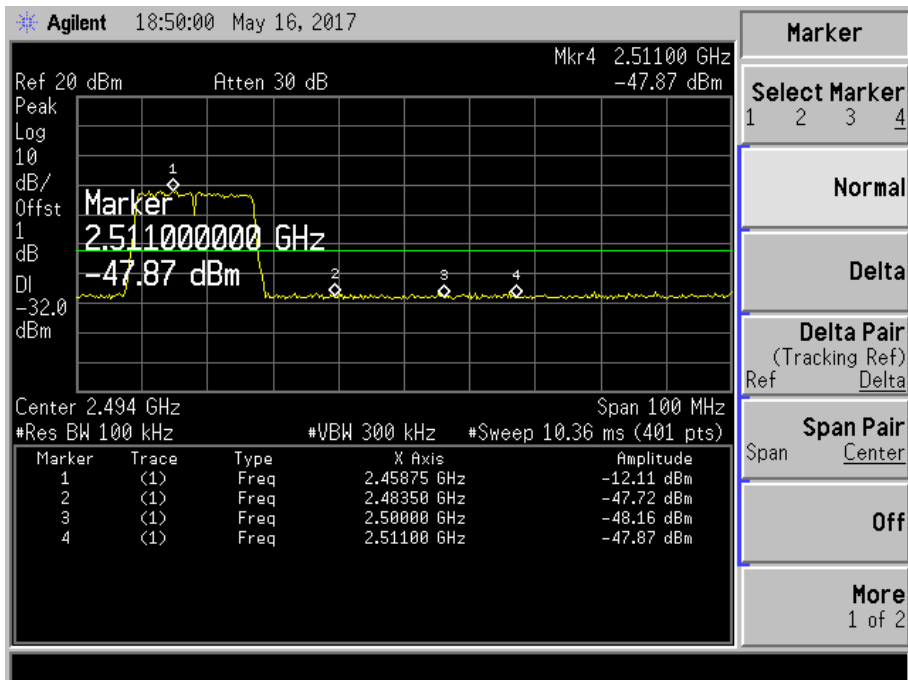
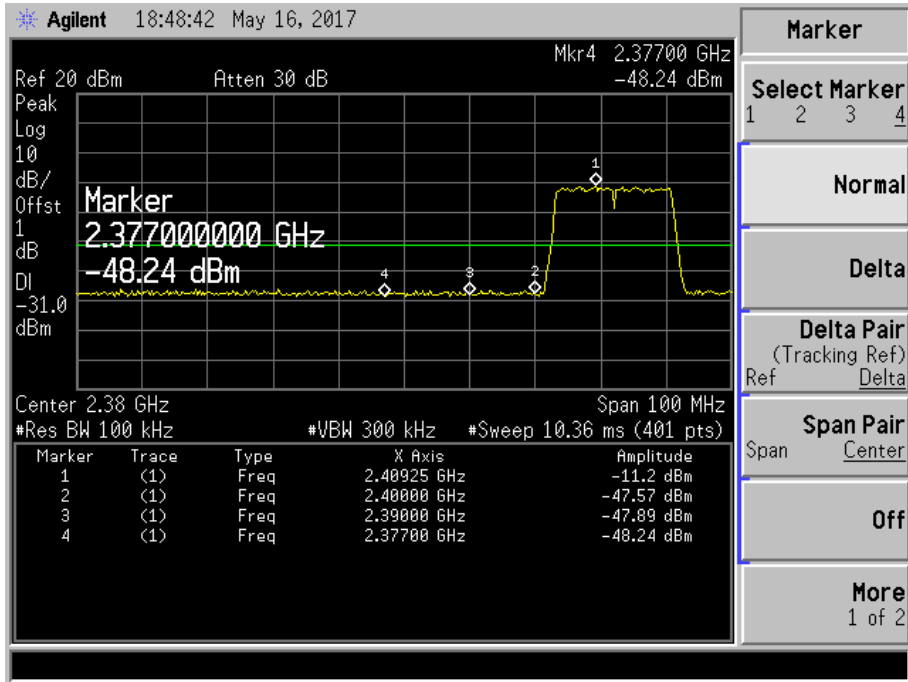

EUT:	Tablet PC	Model:	PTV-R78-3288
Temperature:	25 °C	Relative Humidity:	55%
Test Voltage:	DC 3.7V		
Test Mode:	TX N(HT40) Mode 2422MHz / TX N(HT40) Mode 2452MHz		
Remark:	The EUT is programed in continuously transmitting mode		

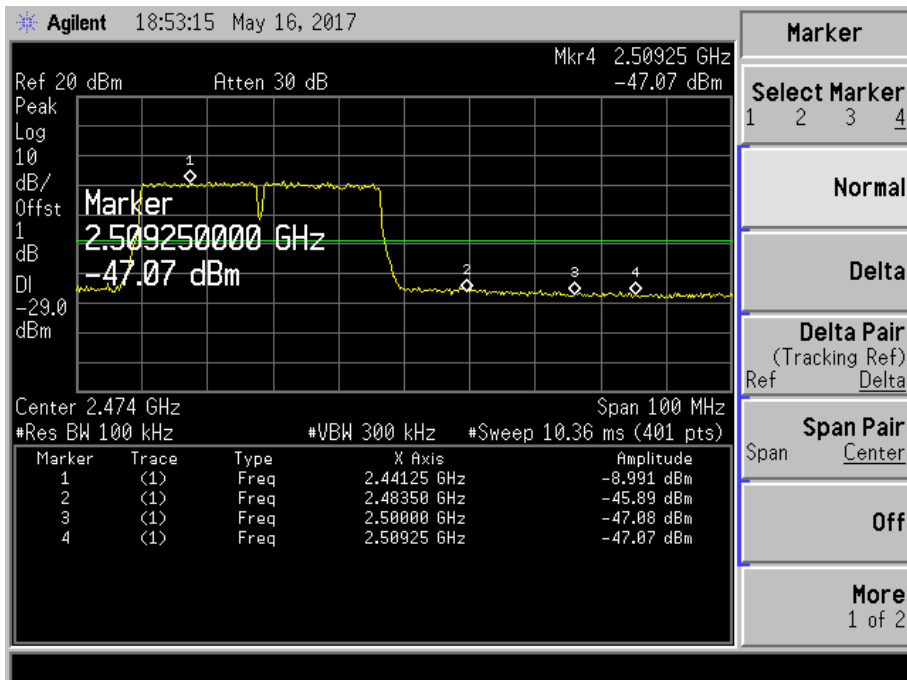
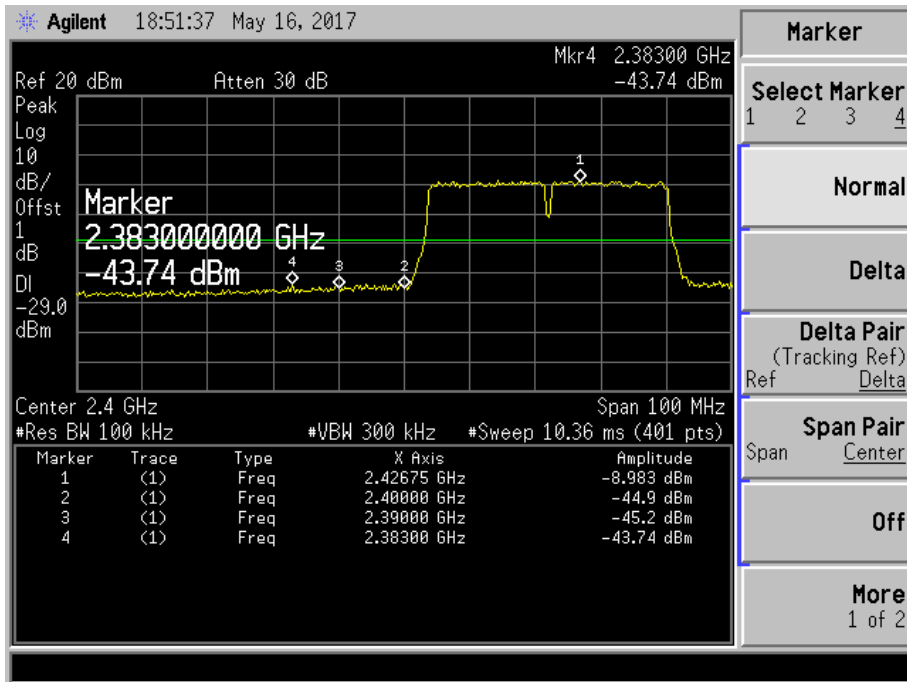

7. Bandwidth Test

7.1 Test Standard and Limit

7.1.1 Test Standard

FCC Part 15.247 (a)(2)

7.1.2 Test Limit

FCC Part 15 Subpart C(15.247)/RSS-210		
Test Item	Limit	Frequency Range(MHz)
Bandwidth	≥ 500 KHz (6dB bandwidth)	2400~2483.5

7.2 Test Setup

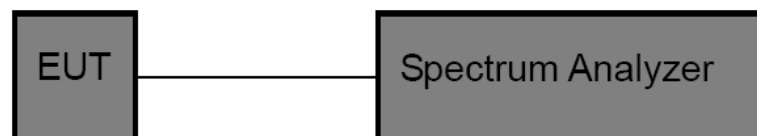

7.3 Test Procedure

- (1) The EUT was directly connected to the spectrum analyzer and antenna output port as show in the block diagram above.
- (2) The bandwidth is measured at an amplitude level reduced 6dB from the reference level. The reference level is the level of the highest amplitude signal observed from the transmitter at the fundamental frequency. Once the reference level is established, the equipment is conditioned with typical modulating signal to produce the worst -case (i.e the widest) bandwidth.
- (3) Measure the channel separation the spectrum analyzer was set to Resolution Bandwidth:100 kHz, and Video Bandwidth:300 kHz, Detector: Peak, Sweep Time set auto.

7.4 EUT Operating Condition

The EUT was set to continuously transmitting in each mode and low, Digital photo framesdle and high channel for the test.

7.5 Test Data

EUT:	Tablet PC	Model:	PTV-R78-3288
Temperature:	25 °C	Relative Humidity:	55%
Test Voltage:	DC 3.7V		
Test Mode:	TX 802.11B Mode		
Channel frequency (MHz)	6dB Bandwidth (MHz)	99% Bandwidth (MHz)	Limit (MHz)
2412	10.055	14.4973	≥0.5
2437	10.052	14.4642	
2462	10.055	14.4947	

802.11B Mode

2412 MHz

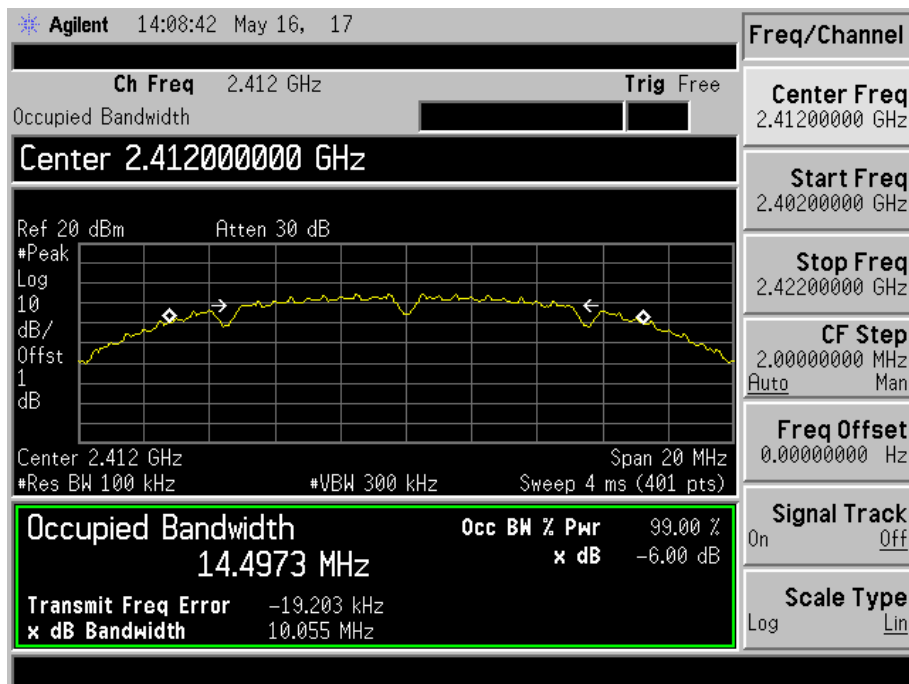

802.11B Mode

2437 MHz

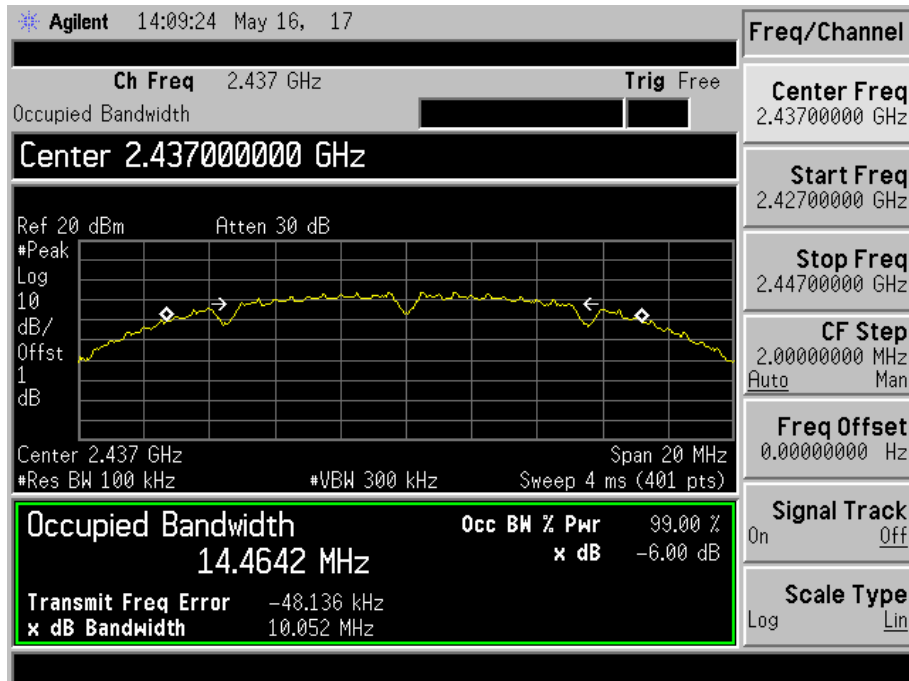

802.11B Mode

2462 MHz

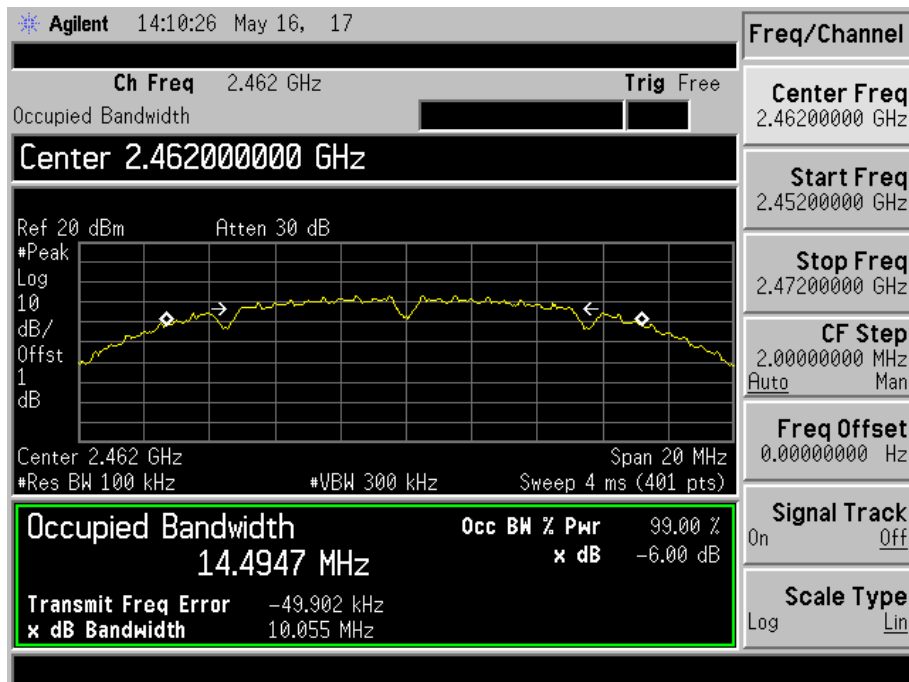

EUT:	Tablet PC	Model:	PTV-R78-3288
Temperature:	25 °C	Relative Humidity:	55%
Test Voltage:	DC 3.7V		
Test Mode:	TX 802.11G Mode		
Channel frequency (MHz)	6dB Bandwidth (MHz)	99% Bandwidth (MHz)	Limit (MHz)
2412	16.603	16.4731	≥0.5
2437	16.598	16.4661	
2462	16.596	16.4845	

802.11G Mode

2412 MHz

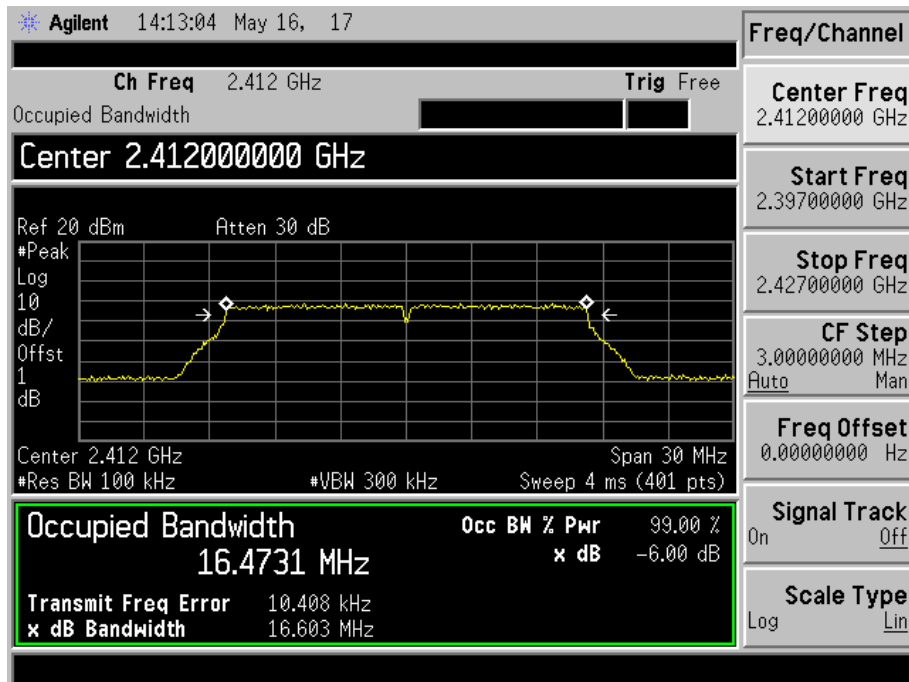

802.11G Mode

2437 MHz

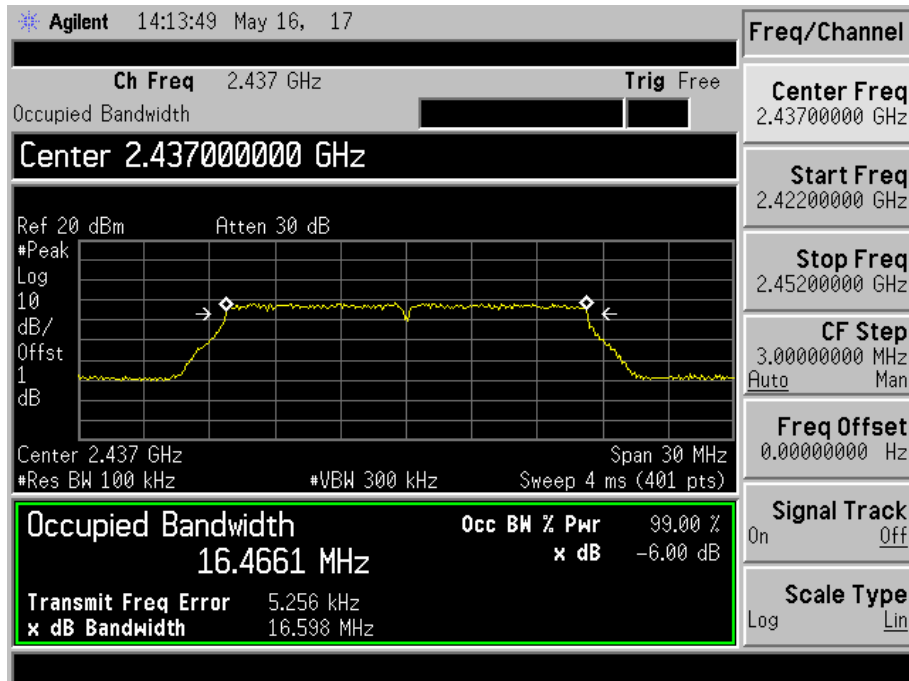

802.11G Mode

2462 MHz

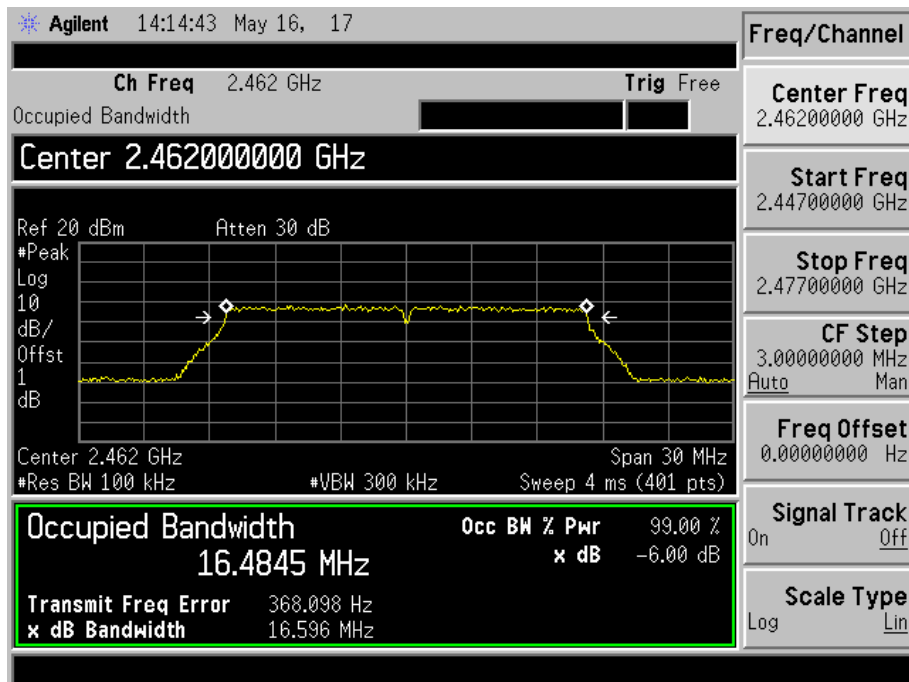

EUT:	Tablet PC	Model:	PTV-R78-3288
Temperature:	25 °C	Relative Humidity:	55%
Test Voltage:	DC 3.7V		
Test Mode:	TX 802.11N(HT20) Mode		
Channel frequency (MHz)	6dB Bandwidth (MHz)	99% Bandwidth (MHz)	Limit (MHz)
2412	17.834	17.6415	≥0.5
2437	17.835	17.6449	
2462	17.858	17.6484	

802.11N(HT20) Mode

2412 MHz

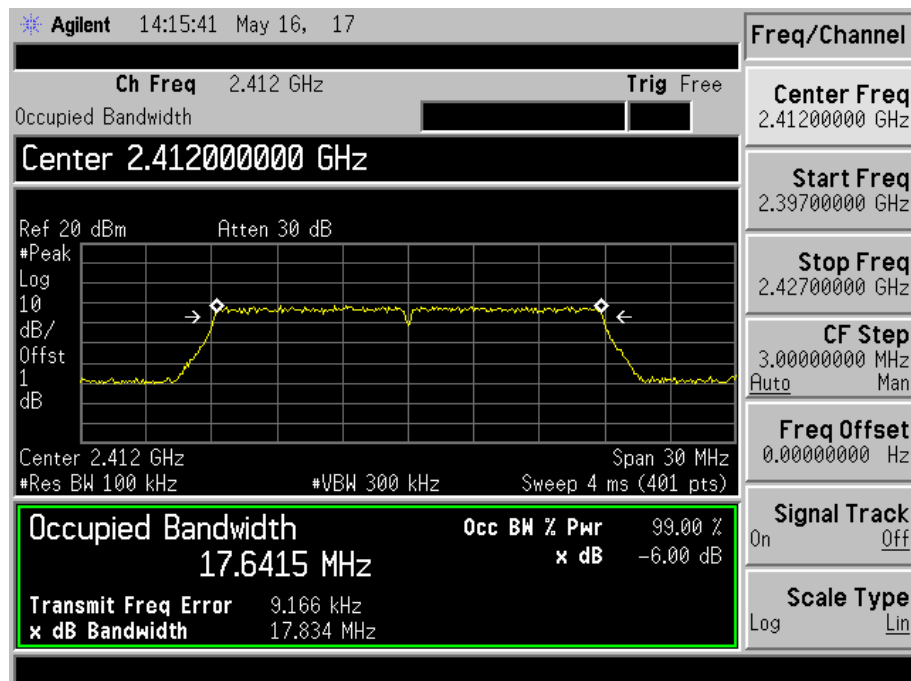

802.11N(HT20) Mode

2437 MHz

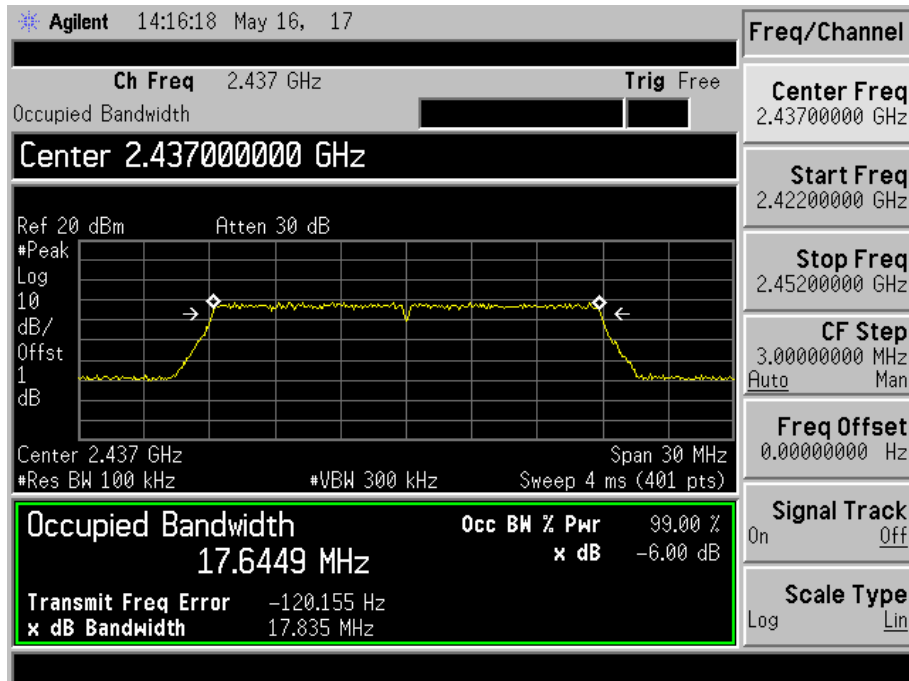

802.11N(HT20) Mode

2462 MHz

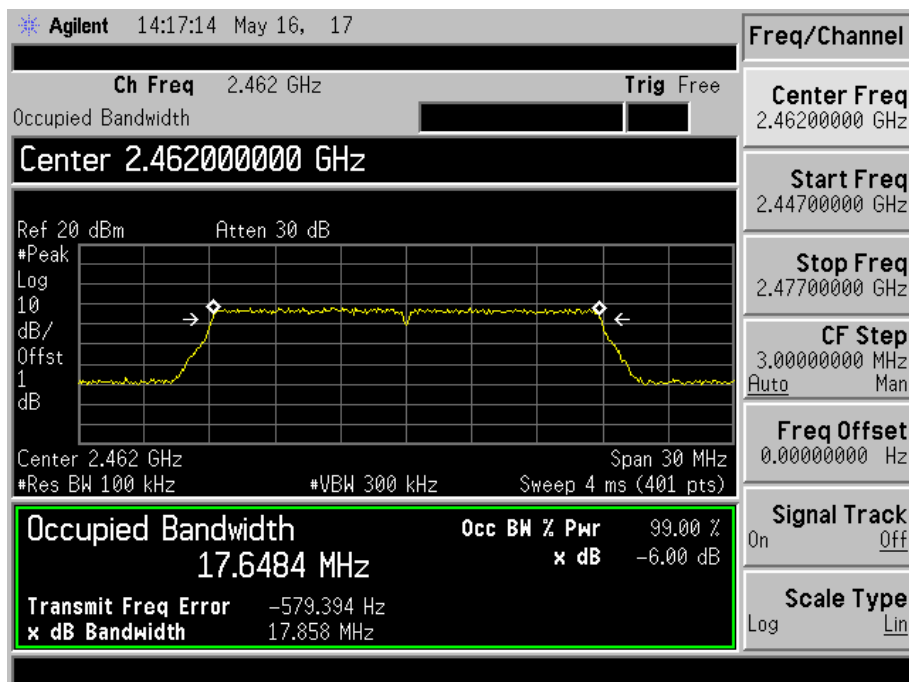

EUT:	Tablet PC	Model:	PTV-R78-3288
Temperature:	25 °C	Relative Humidity:	55%
Test Voltage:	DC 3.7V		
Test Mode:	TX 802.11N(HT40) Mode		
Channel frequency (MHz)	6dB Bandwidth (MHz)	99% Bandwidth (MHz)	Limit (MHz)
2422	36.552	36.0595	≥0.5
2437	36.561	36.0430	
2452	36.591	36.0594	
802.11N(HT40) Mode			
2422 MHz			
<p>The screenshot shows an Agilent spectrum analyzer interface. The main display area shows a signal trace at 2.422 GHz. The graph has a vertical axis labeled 'dB' and a horizontal axis labeled 'MHz'. The signal trace is a yellow line with a peak at 2.422 GHz. The graph is titled 'Center 2.422000000 GHz'. The graph also shows 'Ref 20 dBm' and 'Atten 30 dB'. The graph has a grid. The graph also shows 'Span 60 MHz', '#Res BW 100 kHz', '#VBW 300 kHz', and 'Sweep 6.216 ms (401 pts)'. The graph also shows 'Occupied Bandwidth 36.0595 MHz', 'Occ BW % Pwr 99.00 %', and 'x dB -6.00 dB'. The graph also shows 'Transmit Freq Error 255.255 Hz' and 'x dB Bandwidth 36.552 MHz'. The graph also shows 'Signal Track On' and 'Scale Type Log'. The graph also shows 'Freq/Channel' parameters: 'Center Freq 2.42200000 GHz', 'Start Freq 2.39200000 GHz', 'Stop Freq 2.45200000 GHz', 'CF Step 6.00000000 MHz', 'Freq Offset 0.00000000 Hz', and 'Scale Type Log'. The graph also shows 'Ch Freq 2.422 GHz' and 'Trig Free'. The graph also shows 'Occupied Bandwidth'.</p>			

802.11N(HT40) Mode

2437 MHz

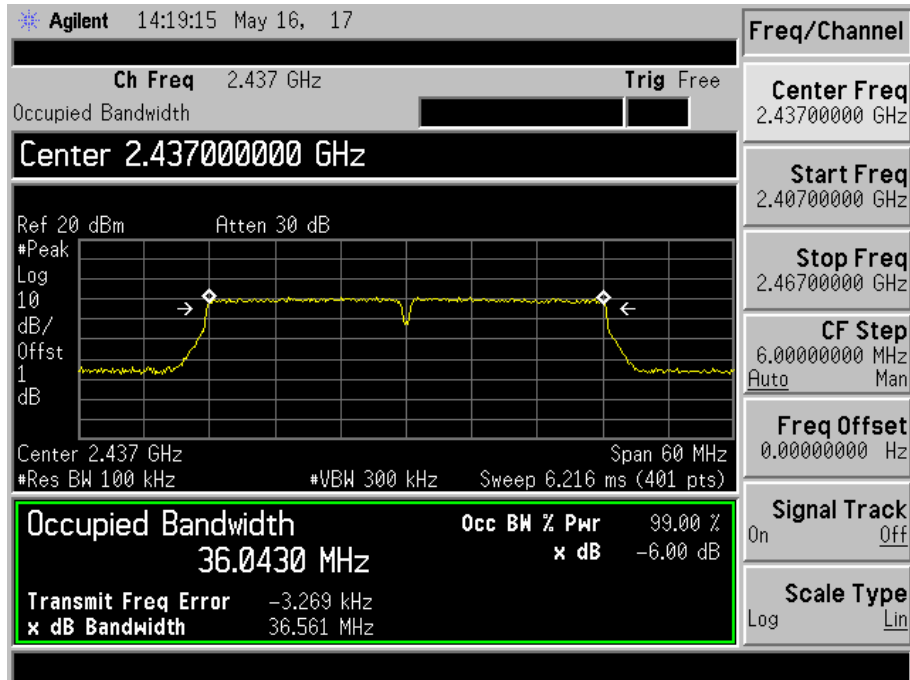

802.11N(HT40) Mode

2452 MHz

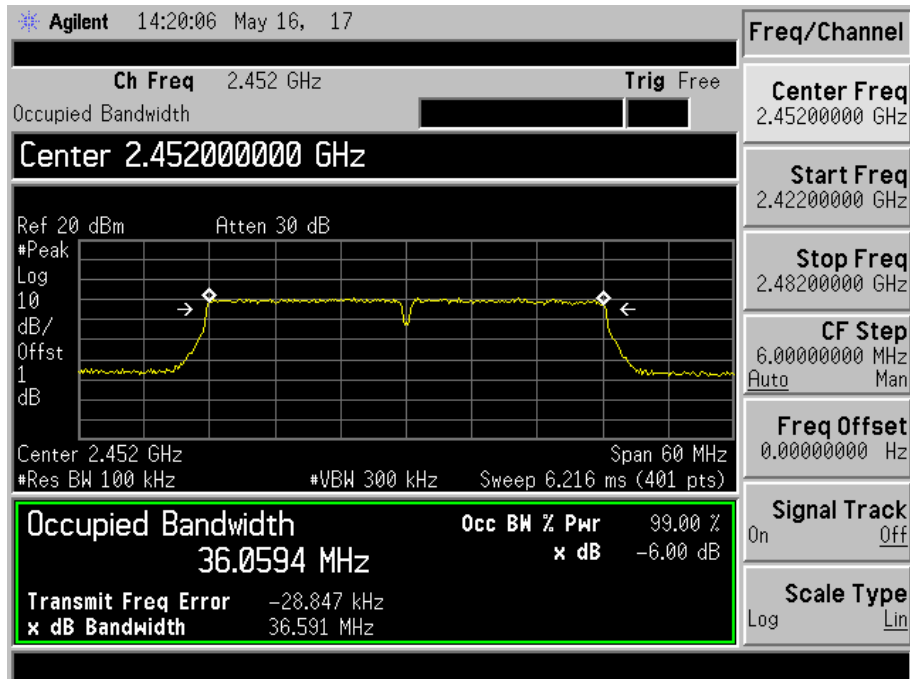

8. Peak Output Power Test

8.1 Test Standard and Limit

8.1.1 Test Standard

FCC Part 15.247 (b)

8.1.2 Test Limit

FCC Part 15 Subpart C(15.247)/RSS-210		
Test Item	Limit	Frequency Range(MHz)
Peak Output Power	1 Watt or 30 dBm	2400~2483.5

8.2 Test Setup

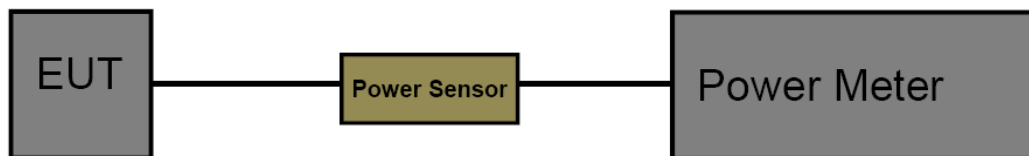

8.3 Test Procedure

The measurement is according to section 9.1.2 of KDB 558074 D01 DTS Meas Guidance v04. The EUT was connected to RF power meter via a broadband power sensor as show the block above. The power sensor video bandwidth is greater than or equal to the DTS bandwidth of the equipment.

8.4 EUT Operating Condition

The EUT was set to continuously transmitting in the max power during the test.

8.5 Test Data

EUT:	Tablet PC	Model:	PTV-R78-3288
Temperature:	25 °C	Relative Humidity:	55%
Test Voltage:	DC 3.7V		
Mode	Channel frequency (MHz)	Test Result (dBm)	Limit (dBm)
802.11b	2412	8.47	30
	2437	7.85	
	2462	6.95	
802.11g	2412	8.52	
	2437	8.69	
	2462	7.97	
802.11n (HT20)	2412	8.91	
	2437	8.72	
	2462	8.48	
802.11n (HT40)	2422	8.41	
	2437	8.31	
	2452	8.28	
Result: PASS			

Duty Cycle		
Mode	Channel frequency (MHz)	Test Result
802.11b	2412	>98%
	2437	
	2462	
802.11g	2412	
	2437	
	2462	
802.11n (HT20)	2412	
	2437	
	2462	
802.11n (HT40)	2422	
	2437	
	2452	
Please see below plots		

802.11 B Mode 2437 MHz

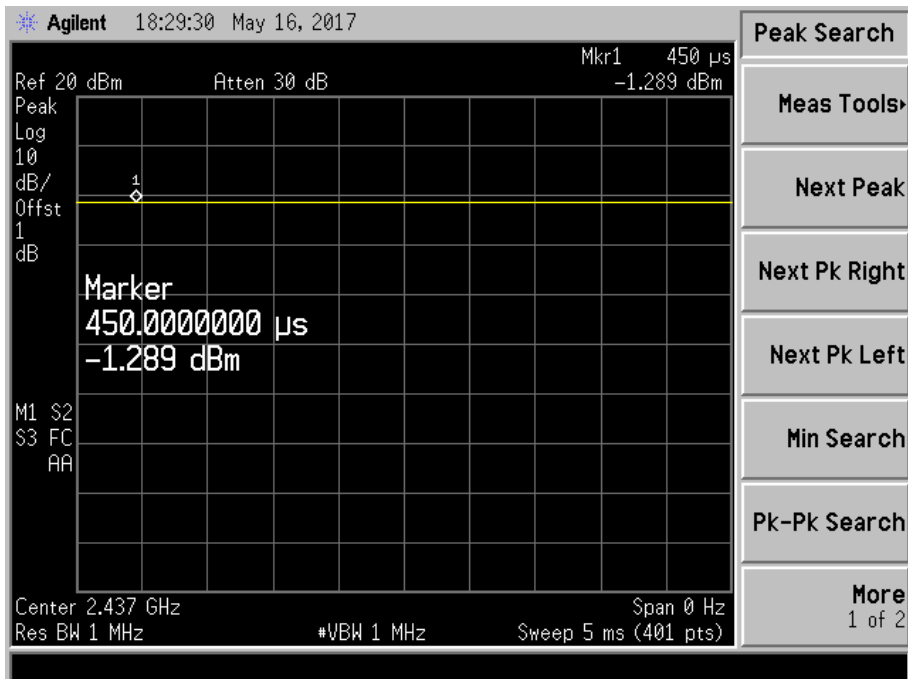

802.11 G Mode 2437 MHz

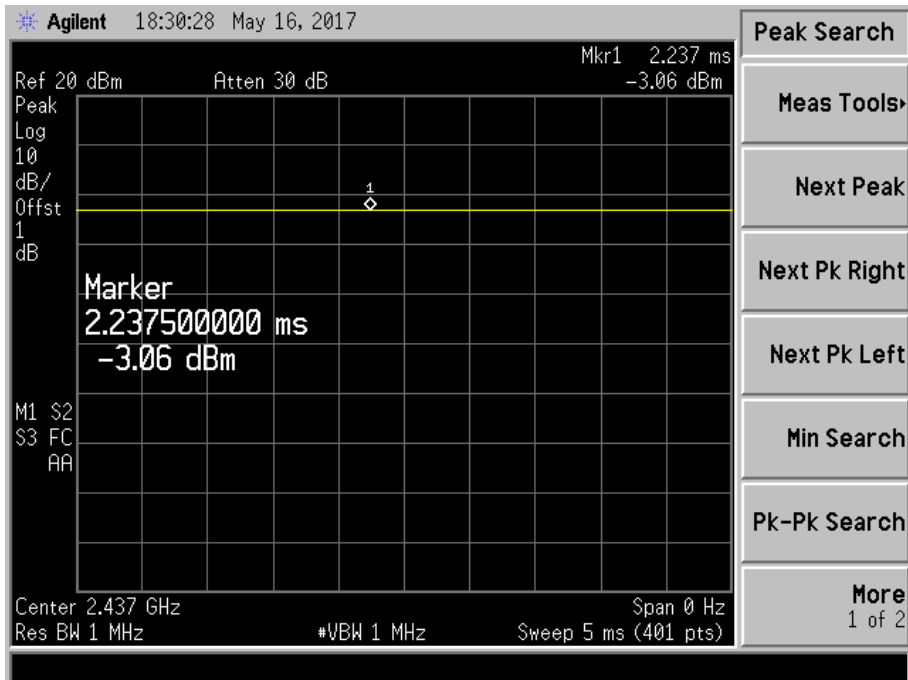

802.11 N(HT20) Mode 2437 MHz

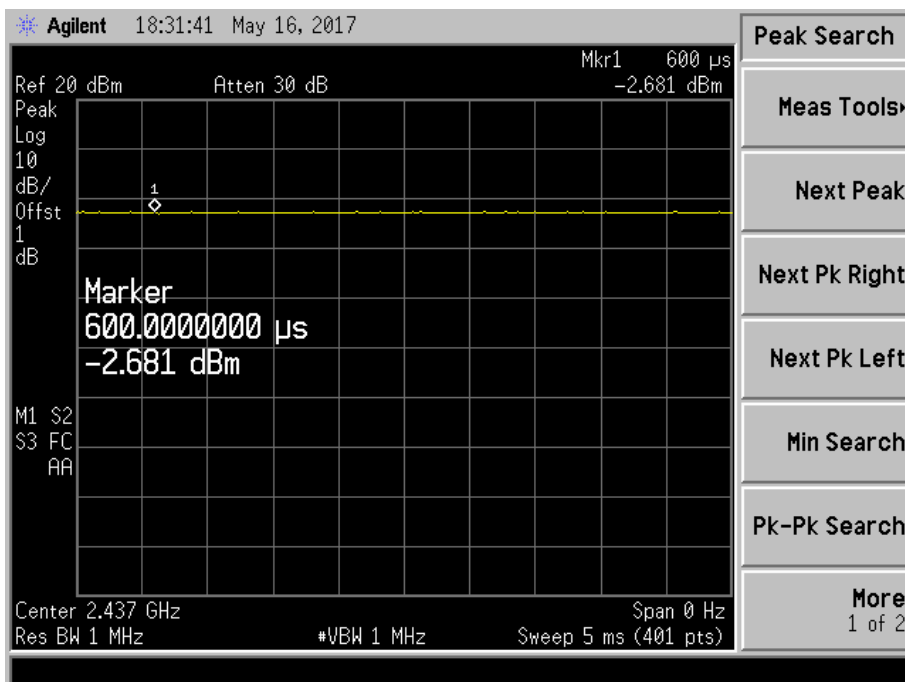

802.11 N(HT40) Mode 2437 MHz

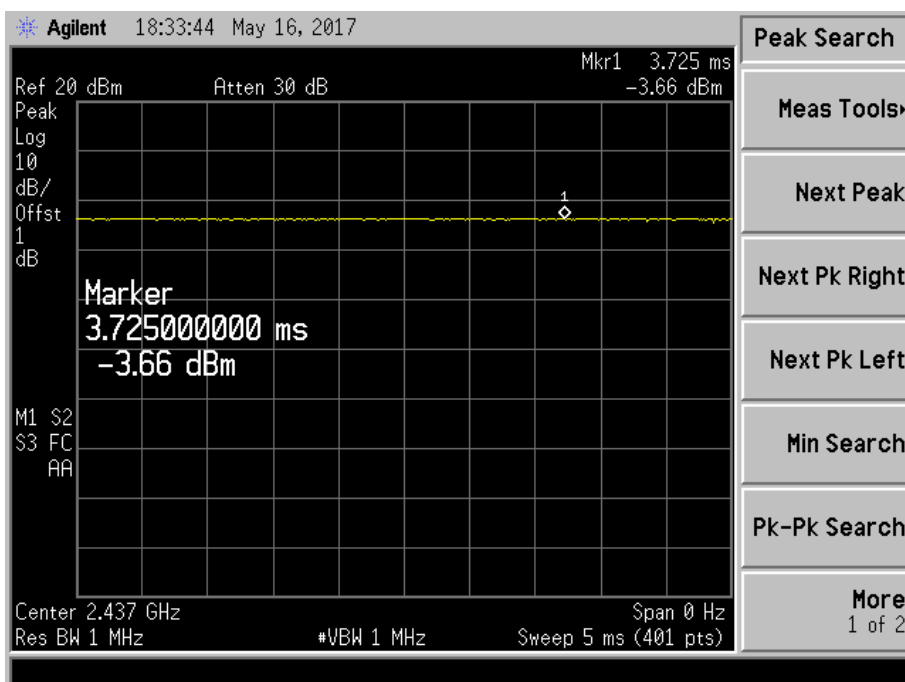

9. Power Spectral Density Test

9.1 Test Standard and Limit

9.1.1 Test Standard

FCC Part 15.247 (e)

9.1.2 Test Limit

FCC Part 15 Subpart C(15.247)		
Test Item	Limit	Frequency Range(MHz)
Power Spectral Density	8dBm(in any 3 kHz)	2400~2483.5

9.2 Test Setup

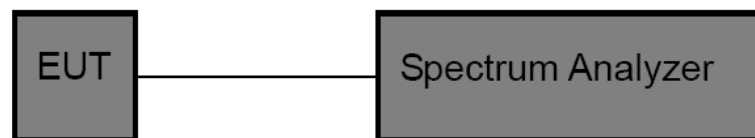

9.3 Test Procedure

The EUT was directly connected to the Spectrum Analyzer and antenna output port as show in the block diagram above. The measurement according to section 10.2 of KDB 558074 D01 DTS Meas Guidance v04.

- (1) The EUT was directly connected to the spectrum analyzer and antenna output port as show in the block diagram above.
- (2) Set analyser center frequency to DTS channel center frequency.
- (3) Set the span to 1.5 times the DTS bandwidth.
- (4) Set the RBW to: 3 kHz
- (5) Set the VBW to: 10 kHz
- (6) Detector: peak
- (7) Sweep time: auto
- (8) Allow trace to fully stabilize. Then use the peak marker function to determine the maximum amplitude level.

9.4 EUT Operating Condition

The EUT was set to continuously transmitting in each mode and low, Digital photo framesdle and high channel for the test.

9.5 Test Data

EUT:	Tablet PC	Model:	PTV-R78-3288
Temperature:	25 °C	Relative Humidity:	55%
Test Voltage:	DC 3.7V		
Test Mode:	TX 802.11B Mode		
Channel Frequency (MHz)	Power Density (3 kHz/dBm)	Limit (dBm)	
2412	-24.13	8	
2437	-24.80		
2462	-25.74		
802.11B Mode			
2412 MHz			
<p>The screenshot shows an Agilent spectrum analyzer interface. At the top, it displays 'Agilent 14:32:28 May 16, 2017'. The main display area shows a signal trace with a peak at 2.41125000 GHz and a power density of -24.13 dBm. The interface includes a grid, a marker, and various measurement tools on the right side. The bottom status bar shows 'Center 2.412 GHz', 'Span 15 MHz', '#Res BW 3 kHz', '#WBW 10 kHz', and 'Sweep 1.715 s (401 pts)'.</p>			

802.11B Mode

2437 MHz

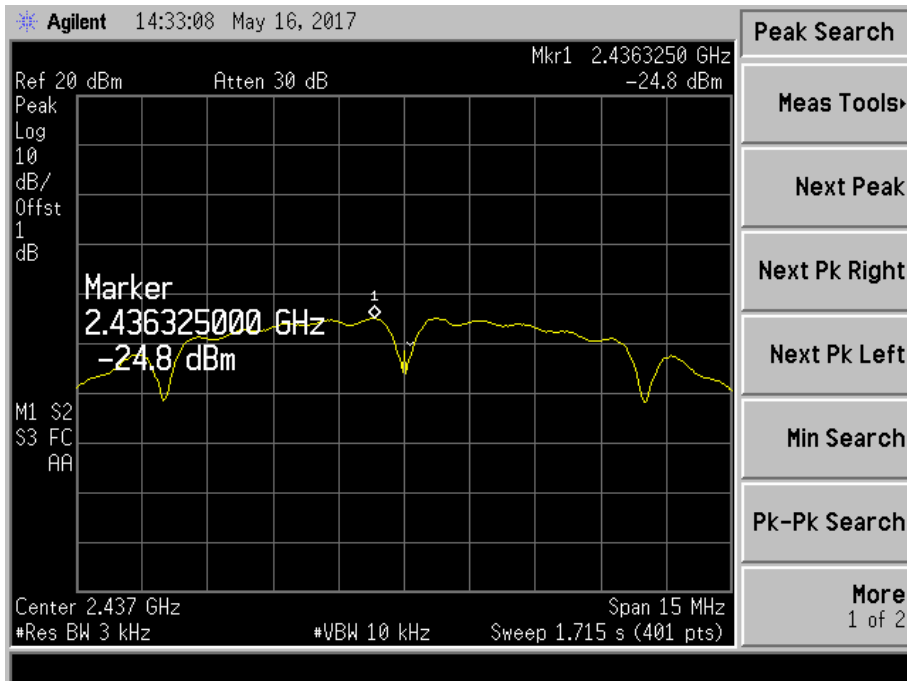

802.11B Mode

2462 MHz

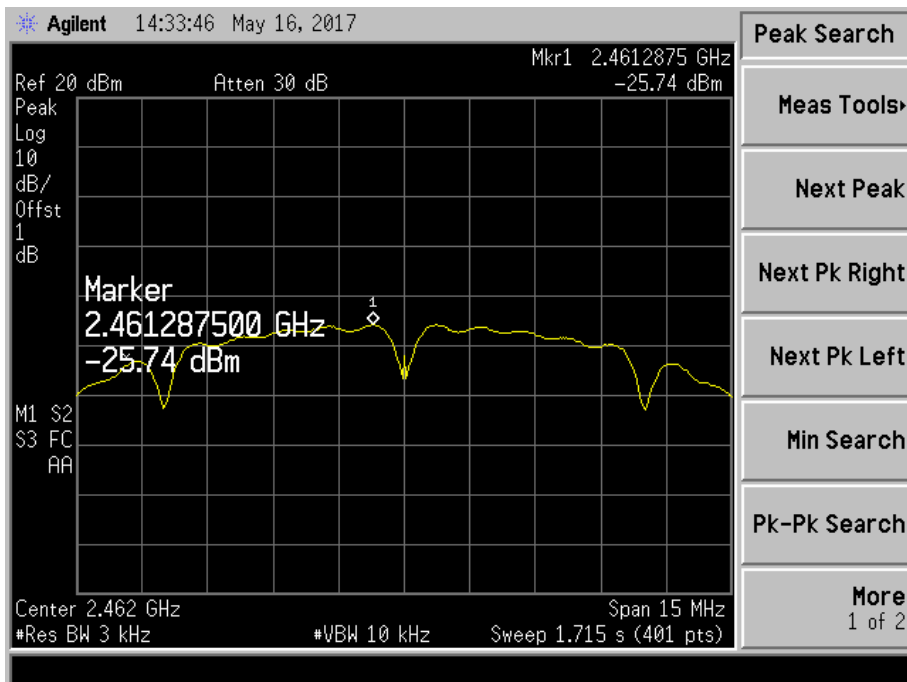

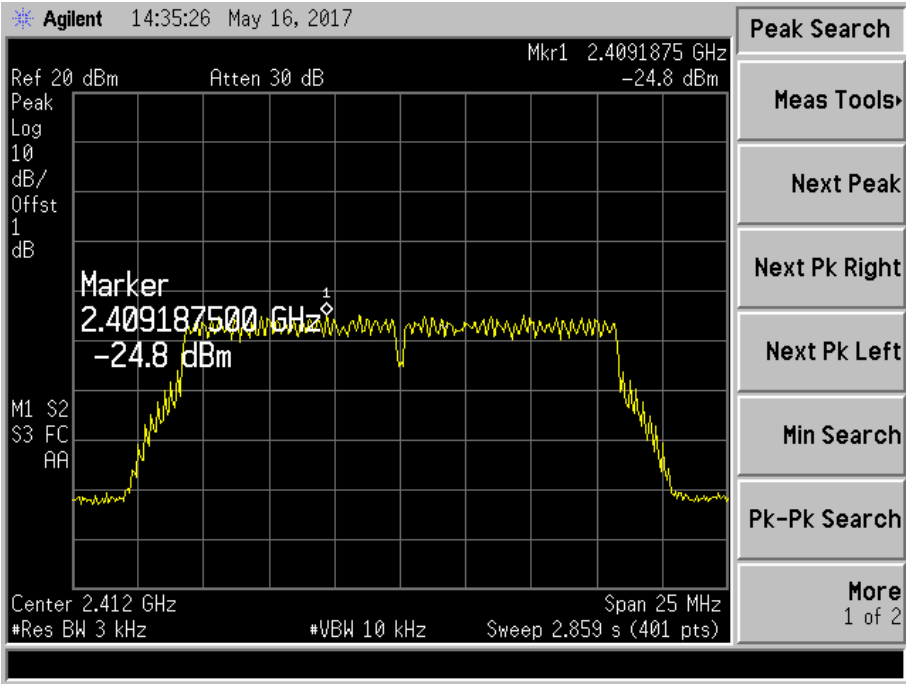
EUT:	Tablet PC	Model:	PTV-R78-3288
Temperature:	25 °C	Temperature:	25 °C
Test Voltage:	DC 3.7V		
Test Mode:	TX 802.11G Mode		
Channel Frequency (MHz)	Power Density (3 kHz/dBm)	Limit (dBm)	
2412	-24.80	8	
2437	-24.72		
2462	-25.05		
802.11G Mode			
2412 MHz			
			

802.11G Mode

2437 MHz

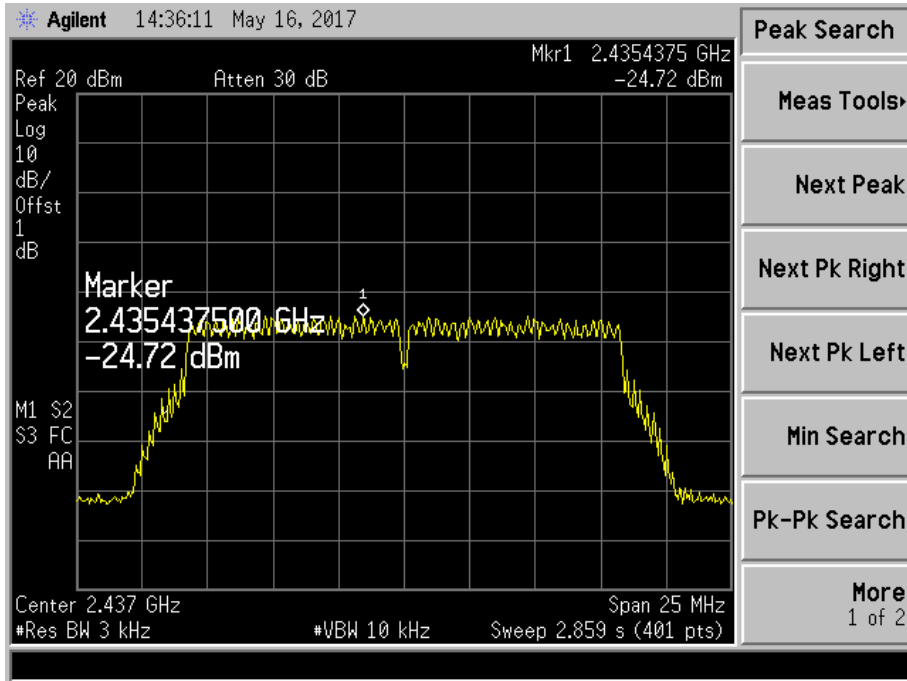

802.11G Mode

2462 MHz

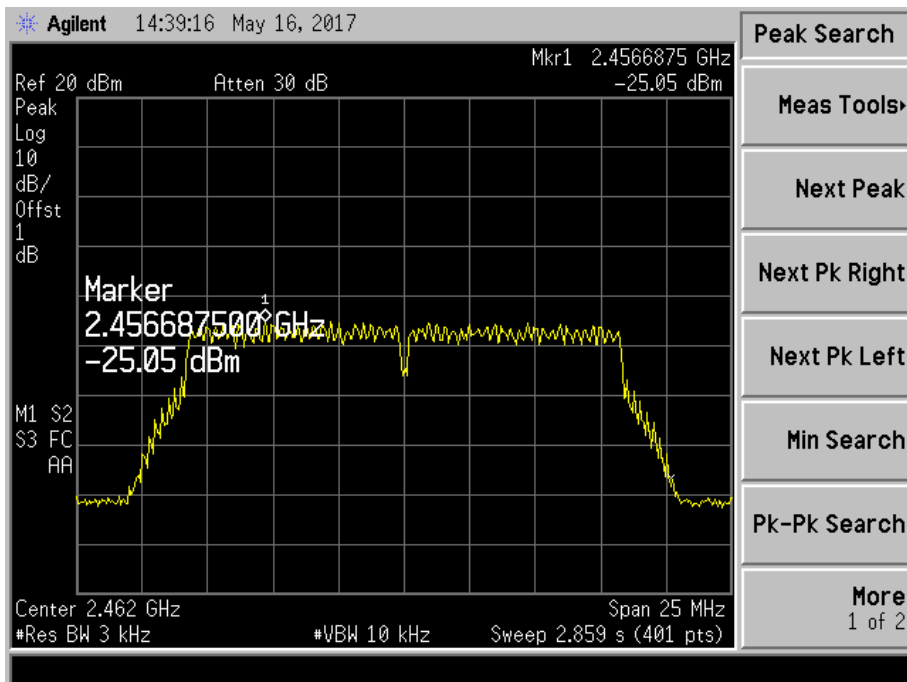

EUT:	Tablet PC	Model:	PTV-R78-3288
Temperature:	25 °C	Temperature:	25 °C
Test Voltage:	DC 3.7V		
Test Mode:	TX 802.11N(HT20) Mode		
Channel Frequency (MHz)	Power Density (3 kHz/dBm)	Limit (dBm)	
2412	-24.31	8	
2437	-25.07		
2462	-24.98		
802.11N(HT20) Mode			
2412 MHz			

The screenshot shows an Agilent spectrum analyzer interface. The main display area shows a signal trace with a peak marker at 2.418565 GHz and a power density of -24.31 dBm. The reference level is 20 dBm and the attenuation is 30 dB. The resolution bandwidth is 3 kHz and the span is 26 MHz. The center frequency is 2.412 GHz. The sweep time is 2.973 seconds with 401 points. The display is in log mode with a 10 dB offset. The peak search tool is active, showing the peak at 2.418565 GHz.

802.11N(HT20) Mode

2437 MHz

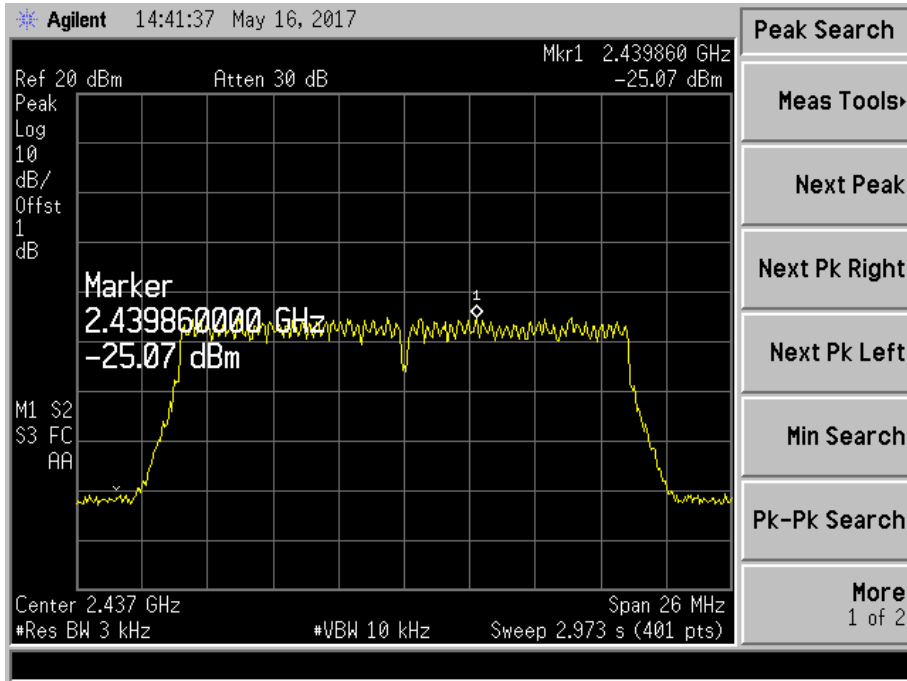

802.11N(HT20) Mode

2462 MHz

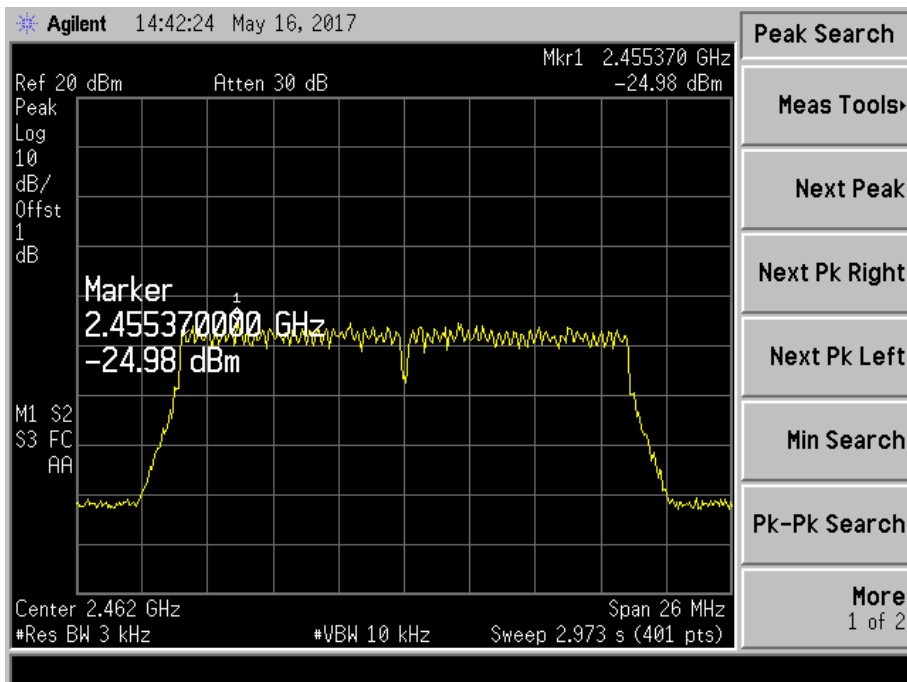

EUT:	Tablet PC	Model:	PTV-R78-3288
Temperature:	25 °C	Temperature:	25 °C
Test Voltage:	DC 3.7V		
Test Mode:	TX 802.11N(HT40) Mode		
Channel Frequency (MHz)	Power Density (3 kHz/dBm)	Limit (dBm)	
2422	-21.62	8	
2437	-22.13		
2452	-21.60		
802.11N(HT40) Mode			
2422 MHz			
<p>Agilent 14:52:13 May 16, 2017</p> <p>Ref 20 dBm Atten 30 dB Mkr1 2.41856 GHz -21.62 dBm</p> <p>Peak Log 10 dB/Offst 1 dB</p> <p>Marker 2.418562500 GHz -21.62 dBm</p> <p>M1 S2 S3 FC AA</p> <p>Center 2.422 GHz Span 55 MHz #Res BW 3 kHz #WBW 10 kHz Sweep 6.29 s (401 pts)</p>			
		Peak Search Meas Tools Next Peak Next Pk Right Next Pk Left Min Search Pk-Pk Search More 1 of 2	

802.11N(HT40) Mode

2437 MHz

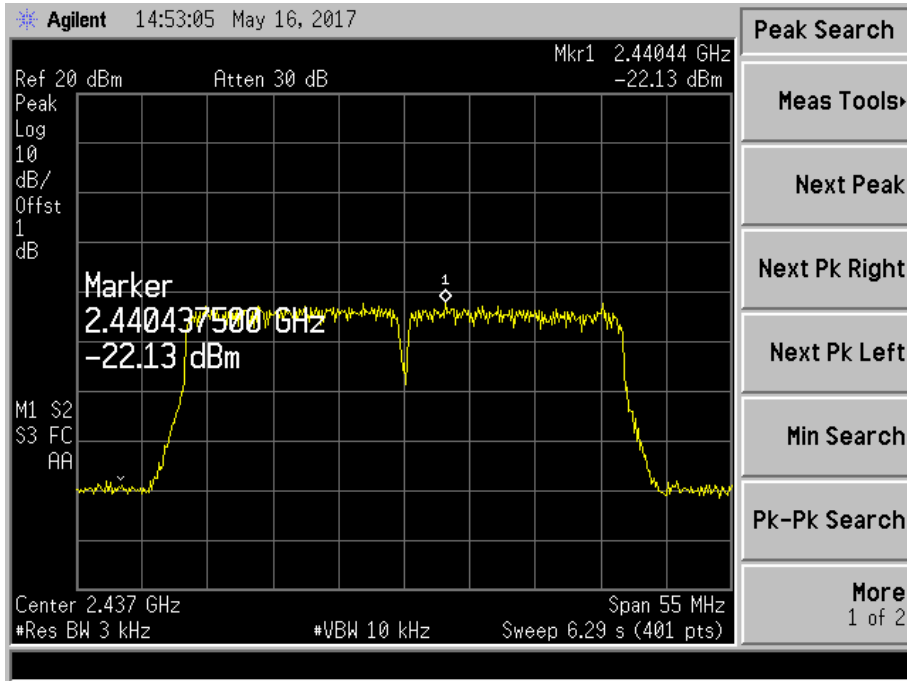

802.11N(HT40) Mode

2452 MHz

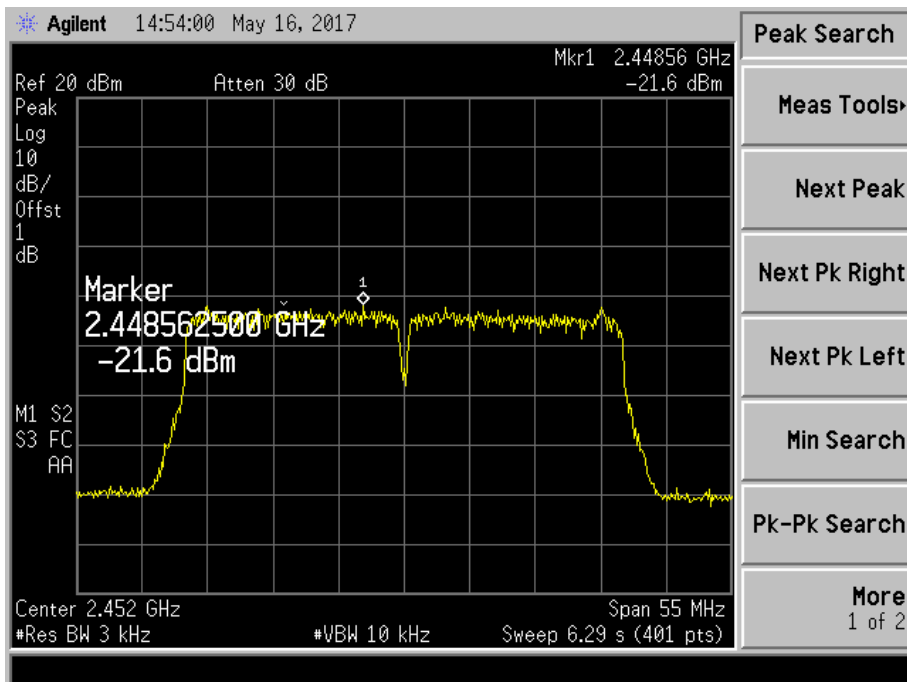

10. Antenna Requirement

10.1 Standard Requirement

10.1.1 Standard

FCC Part 15.203

10.1.2 Requirement

An intentional radiator shall be designed to ensure that no antenna other than that furnished by the responsible party shall be used with the device. The use of a permanently attached antenna or of an antenna that uses a unique coupling to the intentional radiator shall be considered sufficient to comply with the provisions of this Section. The manufacturer may design the unit so that a broken antenna can be replaced by the user, but the use of a standard antenna jack or electrical connector is prohibited.

10.2 Antenna Connected Construction

The directional gains of the antenna used for transmitting is 1.4 dBi, and the antenna de-signed with permanent attachment and no consideration of replacement. Please see the EUT photo for details.

Result

The EUT antenna is a FPC Antenna. It complies with the standard requirement.

Antenna Type
<input type="checkbox"/> Permanent attached antenna
<input checked="" type="checkbox"/> Unique connector antenna
<input type="checkbox"/> Professional installation antenna

-----END OF REPORT-----