

FCC PART 15C
Measurement and Test Report
For
Shenzhen Qiuyu Electronic Co., Ltd

FCC ID: 2AL64-QY-BWKT

FCC Rule(s)/Methods:	FCC CFR Title 47 Part 15 Subpart C Section 15.247 ANSI C63.10:2013
Product Description:	Kids tablet
Trademark	BWJBSW
Model/Type reference.:	KT802, KT803, KT805, KT806, KT808, KT810, KT812, KT815, KT816, KT818, KT820, KT821, KT822, KT825, KT102, KT103, KT105, KT106, KT107, KT108, KT109, KT110, KT112, KT115, KT116, KT118, KT119, KT120, KT121, KT122, KT123, KT125, KT126, KT128, KT129, KT1062, KT1063, KT702, KT705, KT706, KT708, KT710, KT712, KT716, KT718, KT720
Report No.:	BSL2405208275097F-2
Date of receipt of test item:	May 24, 2024
Date of sampling:	May 28, 2024
Tested Date:	Jun. 02, 2024 to Jun. 15, 2024
Issued Date:	Jun. 15, 2024
Tested By:	Lris Yao/ Engineer <i>Lris Yao</i>
Reviewed By:	Levi Xiao/ EMC Manager <i>Levi Xiao</i>
Approved & Authorized By:	Salon Ouyang / PSQ Manager <i>Salon Ouyang</i>
BSL Testing Co.,LTD.	
1/F, Building B, Xinshidai GR Park, Shiyan Street, Bao'an District, Shenzhen, Shiyan Street, Bao'an District, Shenzhen, Guangdong, 518052, People' s Republic of China	
Tel: 400-882-9628	Fax: 86- 755-26508703

Table of Contents

	Page
1. VERSION	4
2. SUMMARY OF TEST RESULTS	5
2.1 TEST FACILITY	6
2.2 MEASUREMENT UNCERTAINTY	6
3. GENERAL INFORMATION	7
3.1 GENERAL DESCRIPTION OF EUT	7
3.2 DESCRIPTION OF TEST MODES	8
3.3 BLOCK DIGRAM SHOWING THE CONFIGURATION OF SYSTEM TESTED	8
3.4 DESCRIPTION OF SUPPORT UNITS(CONDUCTED MODE)	9
3.5EQUIPMENTS LIST FOR ALL TEST ITEMS	10
4. EMC EMISSION TEST	12
4.1 CONDUCTED EMISSION MEASUREMENT	12
4.1.1 POWER LINE CONDUCTED EMISSION Limits	12
4.1.2 TEST PROCEDURE	12
4.1.3 DEVIATION FROM TEST STANDARD	12
4.1.4 TEST SETUP	13
4.1.5 EUT OPERATING CONDITIONS	13
4.1.6 TEST RESULTS	13
4.2 RADIATED EMISSION MEASUREMENT	16
4.2.1 RADIATED EMISSION LIMITS	16
4.2.2 TEST PROCEDURE	16
4.2.3 DEVIATION FROM TEST STANDARD	17
4.2.4 TEST SETUP	17
4.2.5 EUT OPERATING CONDITIONS	18
4.2.6 TEST RESULTS	18
5.RADIATED BAND EMISSIONMEASUREMENT	27
5.1 TEST REQUIREMENT:	27
5.2 TEST PROCEDURE	27
5.3 DEVIATION FROM TEST STANDARD	27
5.4 TEST SETUP	28
5.5 EUT OPERATING CONDITIONS	28
5.6 TEST RESULT	29
6.POWER SPECTRAL DENSITY TEST	33
6.1 APPLIED PROCEDURES / LIMIT	33
6.2 TEST PROCEDURE	33
6.3 DEVIATION FROM STANDARD	33
6.4 TEST SETUP	33

- 6.5 EUT OPERATION CONDITIONS 33**
- 6.6 TEST RESULT34**
- 7. CHANNEL BANDWIDTH 39**
 - 7.1 APPLIED PROCEDURES / LIMIT 39**
 - 7.2 TEST PROCEDURE 39**
 - 7.3 DEVIATION FROM STANDARD 39**
 - 7.4 TEST SETUP39**
 - 7.5 EUT OPERATION CONDITIONS 39**
 - 7.6 TEST RESULT40**
- 8.PEAK OUTPUT POWER TEST 45**
 - 8.1 APPLIED PROCEDURES/LIMIT 45**
 - 8.2 TEST PROCEDURE 45**
 - 8.3 DEVIATION FROM STANDARD 45**
 - 8.4 TEST SETUP45**
 - 8.5 EUT OPERATION CONDITIONS 45**
 - 8.6 TEST RESULT46**
- 9. CONDUCTED BAND EDGE AND SPURIOUS EMISSION 47**
 - 9.1 APPLICABLE STANDARD47**
 - 9.2 TEST PROCEDURE 47**
 - 9.3 DEVIATION FROM STANDARD 47**
 - 9.4 TEST SETUP47**
 - 9.5 EUT OPERATION CONDITIONS 47**
 - 9.6 TEST RESULTS 47**
- 10. ANTENNA REQUIREMENT 64**
- 11. TEST SETUP PHOTO 65**
- 12. EUT CONSTRUCTIONAL DETAILS 65**

1. VERSION

ReportNo.	Version	Description	Approved
BSL2405208275097F-2	Rev.01	Initial issue of report	Jun. 15, 2024

2. SUMMARY OF TEST RESULTS

Test procedures according to the technical standards:

FCC Part15 (15.247) , Subpart C KDB 558074 D01			
Standard Section	Test Item	Result	Remark
FCC part 15.203/15.247 (c)	Antenna requirement	PASS	
FCC part 15.207	AC Power Line Conducted Emission	PASS	
FCC part 15.247 (b)(3)	Conducted Peak Output Power	PASS	
FCC part 15.247 (a)(2)	Channel Bandwidth&	PASS	
FCC part 15.247 (e)	Power Spectral Density	PASS	
FCC part 15.247(d)	Band Edge	PASS	
FCC part 15.247(d)	Conducted Spurious Emission	PASS	
FCC part 15.205/15.209	Spurious Emission	PASS	

NOTE:

(1) " N/A" denotes test is not applicable in this Test Report

2.1 TEST FACILITY

BSL TESTING CO., LTD

Add. : 1/F, Building B, Xinshidai GR Park, Shiyao Street, Bao'an District, Shenzhen, Shiyao Street, Bao'an District, Shenzhen, Guangdong, 518052, People's Republic of China

FCC Test Firm Registration Number: 562200

Designation Number: CN1338

IC Registered No.: 11093A

Designation Number: CN0019

2.2 MEASUREMENT UNCERTAINTY

The reported uncertainty of measurement $y \pm U$ · where expanded uncertainty U is based on a standard uncertainty multiplied by a coverage factor of $k=2$ · providing a level of confidence of approximately 95 % ·

No.	Item	Uncertainty
1	3m chamber Radiated spurious emission(9KHz-30MHz)	U=4.5dB
2	3m chamber Radiated spurious emission(30MHz-1GHz)	U=4.8dB
3	3m chamber Radiated spurious emission(1GHz-6GHz)	U=4.9dB
4	3m chamber Radiated spurious emission(6GHz-40GHz)	U=5.0dB
5	Conducted disturbance	U=3.2dB
6	RF Band Edge	U=1.68dB
7	RF power conducted	U=1.86dB
8	RF conducted Spurious Emission	U=2.2dB
9	RF Occupied Bandwidth	U=1.8dB
10	RF Power Spectral Density	U=1.75dB
11	humidity uncertainty	U=5.3%
12	Temperature uncertainty	U=0.59°C

3. GENERAL INFORMATION

3.1 GENERAL DESCRIPTION OF EUT

Applicant:	Shenzhen Qiuyu Electronic Co., Ltd
Address of applicant:	3F, Building E, Hongzhuyongqi Technology Park, Lezhujiao village, Xixiang town, Bao'an district, Shenzhen, China
Manufacturer:	Shenzhen Qiuyu Electronic Co., Ltd
Address of manufacturer:	3F, Building E, Hongzhuyongqi Technology Park, Lezhujiao village, Xixiang town, Bao'an district, Shenzhen, China
Product Name:	Kids tablet
Model No.:	KT802, KT803, KT805, KT806, KT808, KT810, KT812, KT815, KT816, KT818, KT820, KT821, KT822, KT825, KT102, KT103, KT105, KT106, KT107, KT108, KT109, KT110, KT112, KT115, KT116, KT118, KT119, KT120, KT121, KT122, KT123, KT125, KT126, KT128, KT129, KT1062, KT1063, KT702, KT705, KT706, KT708, KT710, KT712, KT716, KT718, KT720
Test Model:	KT802
Model Different.:	All Model are same in all respects. Only the model names are different for different market requirement. They are identical in structure, circuit, circuit, screen printing, bit number, RF module, antenna, etc.
Serial No.:	N/A
HVIN/Hardware version:	V1.0
FVIN/Software version:	V1.0
Sample(s) Status:	Engineer sample
Channel numbers:	802.11b/802.11g /802.11n(HT20):11
Channel separation:	5MHz
Modulation technology:	802.11b: Direct Sequence Spread Spectrum(DSSS) 802.11g/802.11n(H20) Orthogonal Frequency Division Multiplexing(OFDM)
Antenna Type:	FPC antenna
Antenna gain:	1.31dBi
Power supply:	DC 5V from USB port; Battery: DC 3.8V, 4000mAh

Operation Frequency each of channel							
Channel	Frequency	Chann el	Frequency	Chann el	Frequency	Chann el	Frequency
1	2412MHz	4	2427MHz	7	2442MHz	10	2457MHz
2	2417MHz	5	2432MHz	8	2447MHz	11	2462MHz
3	2422MHz	6	2437MHz	9	2452MHz	X	

Note:

In section 15.31(m), regards to the operating frequency range over 10 MHz, the Lowest frequency, the middle frequency, and the highest frequency of channel were selected to perform the test, and the selected channel see below:

Test channel	Frequency (MHz)	
		802.11b/802.11g/802.11n(HT20)
Lowest channel	2412MHz	/
Middle channel	2437MHz	/
Highest channel	2462MHz	/

3.2 DESCRIPTION OF TEST MODES

Transmitting mode	Keep the EUT in continuously transmitting mode
Remark: During the test,the dutycycle >98%, the test voltage was tuned from 85% to 115% of the nominal rated supply voltage, and found that the worst case was under the nominal rated supply condition. So the report just shows that condition's data.	

We have verified the construction and function in typical operation. All the test modes were carried out with the EUT in transmitting operation, which was shown in this test report and defined as follows:				
Pre-scan all kind of data rate in lowest channel, and found the follow list which it was worst case.				
Mode	802.11b	802.11g	802.11n(HT20)	/
Data rate	1Mbps	6Mbps	6.5Mbps	/

Test Software	TROLiNIK
Power level setup	<13dBm

3.3 BLOCK DIGRAM SHOWING THE CONFIGURATION OF SYSTEM TESTED

Conducted Emission

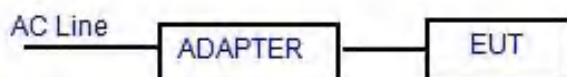

Radiated Emission



Conducted Spurious

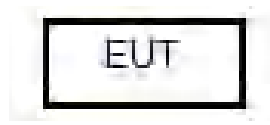

3.4 DESCRIPTION OF SUPPORT UNITS(CONDUCTED MODE)

The EUT has been tested as an independent unit together with other necessary accessories or support units. The following support units or accessories were used to form a representative test configuration during the tests.

Item	Equipment	Mfr/Brand	Model/Type No.	Series No.	Note
/	ADAPTER	/	ADS-5002000C	/	DC5V/2A

Item	Shielded Type	Ferrite Core	Length	Note

Note:

- (1) The support equipment was authorized by Declaration of Confirmation.
- (2) For detachable type I/O cable should be specified the length in cm in 『Length』 column.

3.5EQUIPMENTS LIST FOR ALL TEST ITEMS

Radiation Test equipment

Item	Equipment	Manufacturer	Type No.	Serial No.	Last calibration	Calibrated until
1	Communication Tester	Rohde & Schwarz	CMW500	100358 Fireware: 4.43 SP4	Oct. 22, 2023	Oct. 21, 2024
2	Spectrum Analyzer	KEYSIGHT	9020A	MY55370835	Oct. 22, 2023	Oct. 21, 2024
3	Test Receiver	R&S	ESC17	US47140102 Fireware: 4.42 SP3	Oct. 22, 2023	Oct. 21, 2024
4	Signal Generator	HP	83630B	3844A01028	Oct. 22, 2023	Oct. 21, 2024
5	Signal Generator	IFR	2023A	202307/242	Oct. 22, 2023	Oct. 21, 2024
6	Amplifier	Agilent	8449B	4035A00116	Oct. 22, 2023	Oct. 21, 2024
7	Amplifier	HP	8447E	2945A02770	Oct. 22, 2023	Oct. 21, 2024
8	Broadband Antenna	SCHAFFNER	2774	2774	Feb.28,2022	Feb.27,2025
9	Biconical and log periodic antennas	ELECTRO-METRICS	EM-6917B-1	171	Feb.28,2022	Feb.27,2025
10	Horn Antenna	R&S	HF906	100253	Feb.28,2022	Feb.27,2025
11	Horn Antenna	Schwarzbeck	BBHA9170	00814	Feb.28,2022	Feb.27,2025
12	Horn Antenna	EM	EM-6961	6462	Feb.28,2022	Feb.27,2025
13	3m Semi-Anechoic Chamber	Chengyu Electron	9 (L)*6 (W)* 6 (H)	BSL086	Feb.28,2022	Feb.27,2025
14	Loop Antenna	ZHINAN	ZN30900C	20073	Feb.28,2022	Feb.27,2025
15	power meter	DARE	RPR3006W	15I00041SNO0	Oct.27,2023	Oct.26,2024
16	RF Control Unit	MWRFtest	Mw100	-	Oct.27,2023	Oct.26,2024
17	Test software	MWRFtest	V8310	-	-	-
18	Turntable	MF	MF-7802BS	N/A	\	\

Conduction Test equipment

Item	Kind of Equipment	Manufacturer	Type No.	Serial No.	Last calibration	Calibrated until
1	LISN	R&S	ENV216	101471	Oct.27,2023	Oct.26,2024
2	LISN	CYBERTEK	EM5040A	E1850400149	Oct.27,2023	Oct.26,2024
3	Test Cable	N/A	C01	N/A	Oct.27,2023	Oct.26,2024
4	Test Cable	N/A	C02	N/A	Oct.27,2023	Oct.26,2024
5	EMI Test Receiver	R&S	ESC13	101393	Oct.27,2023	Oct.26,2024
6	Absorbing Clamp	DZ	ZN23201	15034	Oct.27,2023	Oct.26,2024
7	EMC Software	Frad	EZ-EMC	Ver.EMC-CON 3A1.1	\	\

RF Conduction Test equipment

Item	Kind of Equipment	Manufacturer	Type No.	Serial No.	Last calibration	Calibrated until
1	Spectrum Analyzer (9kHz-26.5GHz)	KEYSIGHT	9020A	MY55370835	Oct.27,2023	Oct.26,2024
2	MWRF Power Meter Test system	MW	MW100-RPCB	N/A	Oct.27,2023	Oct.26,2024
3	D.C. Power Supply	LongWei	TPR-6405D	N/A	\	\
4	RF Software	MW	MTS8310	V2.0.0.0	\	\

4. EMC EMISSION TEST

4.1 CONDUCTED EMISSION MEASUREMENT

Test Requirement:	FCC Part15 C Section 15.207
Test Method:	ANSI C63.10:2013
Test Frequency Range:	150KHz to 30MHz
Receiver setup:	RBW=9KHz, VBW=30KHz, Sweep time=auto

4.1.1 POWER LINE CONDUCTED EMISSION Limits

FREQUENCY (MHz)	Limit (dBuV)		Standard
	Quasi-peak	Average	
0.15 -0.5	66 - 56 *	56 - 46 *	FCC
0.50 -5.0	56.00	46.00	FCC
5.0 -30.0	60.00	50.00	FCC

Note:

(1) *Decreases with the logarithm of the frequency.

4.1.2 TEST PROCEDURE

- a. The EUT was placed 0.1 meters from the horizontal ground plane with EUT being connected to the power mains through a line impedance stabilization network (LISN). All other support equipments powered from additional LISN(s). The LISN provide 50 Ohm/ 50uH of coupling impedance for the measuring instrument.
- b. Interconnecting cables that hang closer than 40 cm to the ground plane shall be folded back and forth in the center forming a bundle 30 to 40 cm long.
- c. I/O cables that are not connected to a peripheral shall be bundled in the center. The end of the cable may be terminated, if required, using the correct terminating impedance. The overall length shall not exceed 1 m.
- d. LISN at least 80 cm from nearest part of EUT chassis.
- e. For the actual test configuration, please refer to the related Item –EUT Test Photos.

4.1.3 DEVIATION FROM TEST STANDARD

No deviation

4.1.4 TEST SETUP

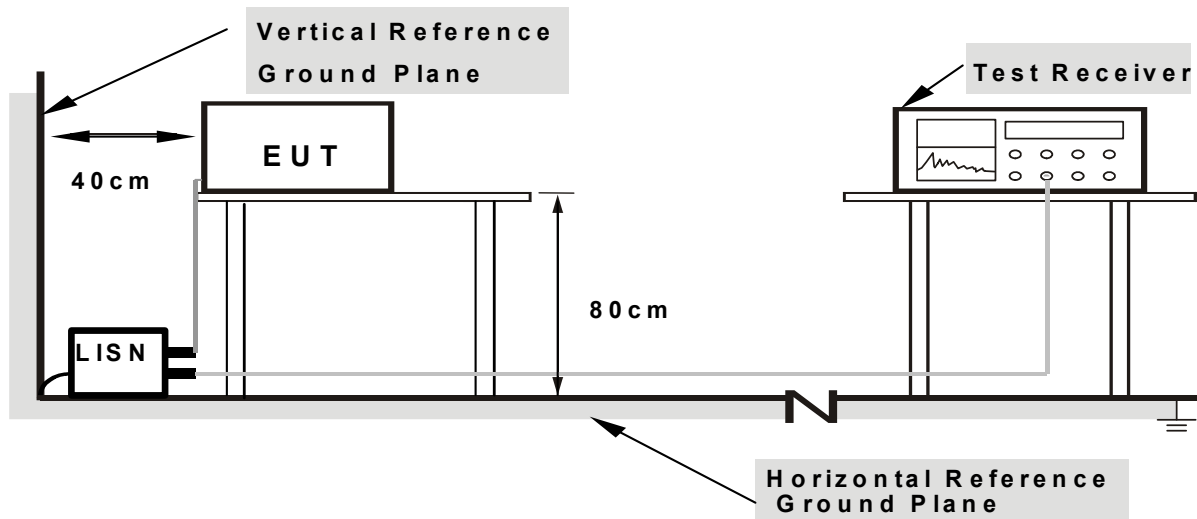

- Note: 1.Support units were connected to second LISN.**
2.Both of LISNs (AMN) are 80 cm from EUT and at least 80 from other units and other metal planes

4.1.5 EUT OPERATING CONDITIONS

The EUT was configured for testing in a typical fashion (as a customer would normally use it). The EUT has been programmed to continuously transmit during test. This operating condition was tested and used to collect the included data.

We pretest AC 120V and AC 230V, the worst voltage was AC 120V and the data recording in the report.

4.1.6 TEST RESULTS

PASS

Note : Worst case is 802.11b 2412MHz TX

Temperature :	26°C	Relative Humidity:	54%
Pressure :	101 kPa	Phase :	L
Test Voltage :	AC 120V/60Hz	Test Mode	802.11b 2412MHz TX (Worst case)

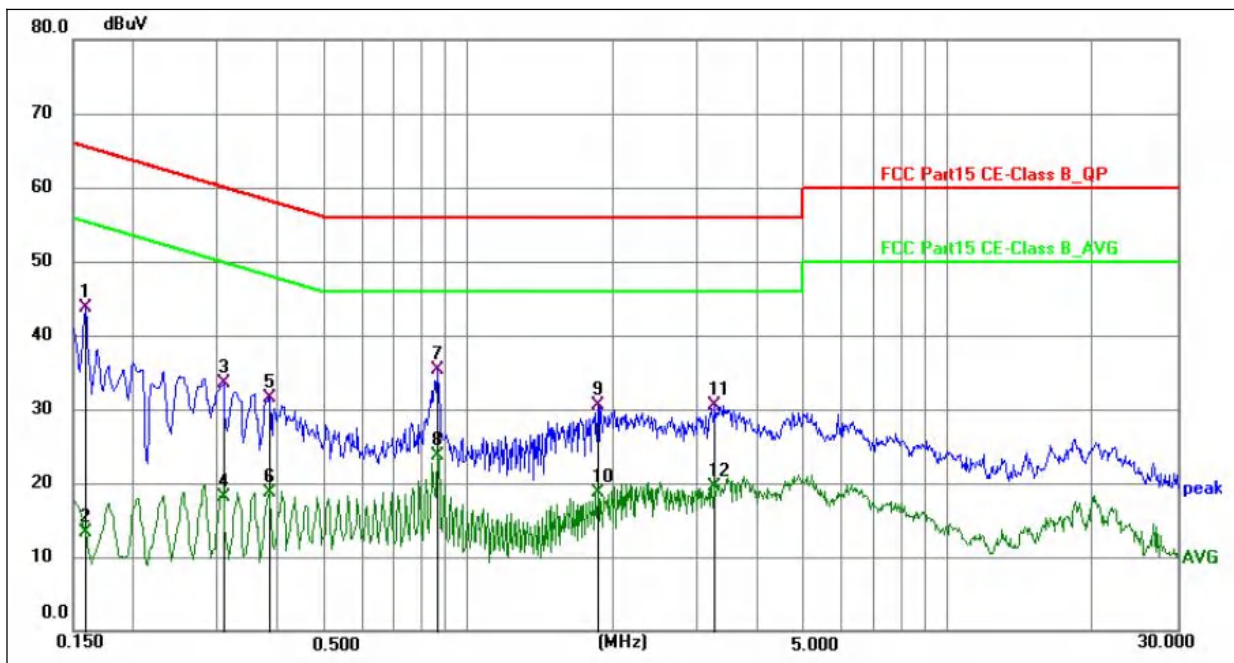

No.	Frequency (MHz)	Reading (dBuV)	Factor (dB)	Level (dBuV)	Limit (dBuV)	Margin (dB)	Detector	P/F	Remark
1	0.1590	34.12	9.55	43.67	65.52	-21.85	QP	P	
2	0.1590	3.81	9.55	13.36	55.52	-42.16	AVG	P	
3	0.3074	23.80	9.67	33.47	60.04	-26.57	QP	P	
4	0.3074	8.49	9.67	18.16	50.04	-31.88	AVG	P	
5	0.3840	21.89	9.65	31.54	58.19	-26.65	QP	P	
6	0.3840	9.04	9.65	18.69	48.19	-29.50	AVG	P	
7 *	0.8655	25.71	9.61	35.32	56.00	-20.68	QP	P	
8	0.8655	14.05	9.61	23.66	46.00	-22.34	AVG	P	
9	1.8645	20.77	9.69	30.46	56.00	-25.54	QP	P	
10	1.8645	8.92	9.69	18.61	46.00	-27.39	AVG	P	
11	3.2683	20.98	9.60	30.58	56.00	-25.42	QP	P	
12	3.2683	9.95	9.60	19.55	46.00	-26.45	AVG	P	

Temperature :	26°C	Relative Humidity:	54%
Pressure :	101 kPa	Phase :	N
Test Voltage :	AC 120V/60Hz	Test Mode	802.11b 2412MHz TX (Worst case)

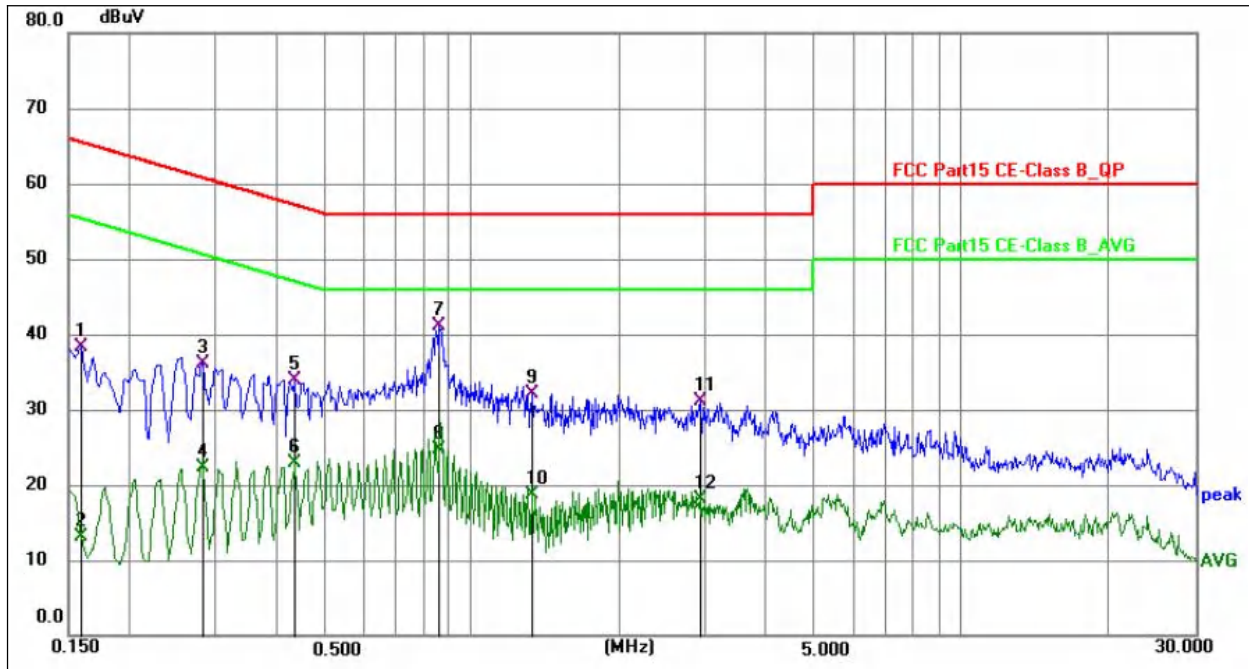

No.	Frequency (MHz)	Reading (dBuV)	Factor (dB)	Level (dBuV)	Limit (dBuV)	Margin (dB)	Detector	P/F	Remark
1	0.1590	28.79	9.55	38.34	65.52	-27.18	QP	P	
2	0.1590	3.60	9.55	13.15	55.52	-42.37	AVG	P	
3	0.2805	26.45	9.68	36.13	60.80	-24.67	QP	P	
4	0.2805	12.66	9.68	22.34	50.80	-28.46	AVG	P	
5	0.4334	24.31	9.63	33.94	57.19	-23.25	QP	P	
6	0.4334	13.23	9.63	22.86	47.19	-24.33	AVG	P	
7 *	0.8609	31.46	9.61	41.07	56.00	-14.93	QP	P	
8	0.8609	15.05	9.61	24.66	46.00	-21.34	AVG	P	
9	1.3245	22.55	9.58	32.13	56.00	-23.87	QP	P	
10	1.3245	9.16	9.58	18.74	46.00	-27.26	AVG	P	
11	2.9355	21.45	9.63	31.08	56.00	-24.92	QP	P	
12	2.9355	8.45	9.63	18.08	46.00	-27.92	AVG	P	

4.2 RADIATED EMISSION MEASUREMENT

Test Requirement:	FCC Part15 C Section 15.209				
Test Method:	ANSI C63.10:2013				
Test Frequency Range:	9kHz to 25GHz				
Test site:	Measurement Distance: 3m				
Receiver setup:	Frequency	Detector	RBW	VBW	Value
	9KHz-150KHz	Quasi-peak	200Hz	600Hz	Quasi-peak
	150KHz-30MHz	Quasi-peak	9KHz	30KHz	Quasi-peak
	30MHz-1GHz	Quasi-peak	100KHz	300KHz	Quasi-peak
	Above 1GHz	Peak	1MHz	3MHz	Peak
Peak		1MHz	10Hz	Average	

4.2.1 RADIATED EMISSION LIMITS

Frequencies (MHz)	Field Strength (micorvolts/meter)	Measurement Distance (meters)
0.009~0.490	2400/F(KHz)	300
0.490~1.705	24000/F(KHz)	30
1.705~30.0	30	30
30~88	100	3
88~216	150	3
216~960	200	3
Above 960	500	3

LIMITS OF RADIATED EMISSION MEASUREMENT

FREQUENCY (MHz)	Limit (dBuV/m) (at 3M)	
	PEAK	AVERAGE
Above 1000	74	54

Notes:

- (1) The limit for radiated test was performed according to FCC PART 15C.
- (2) The tighter limit applies at the band edges.
- (3) Emission level (dBuV/m)=20log Emission level (uV/m).

4.2.2 TEST PROCEDURE

Below 1GHz test procedure as below:

- a. The EUT was placed on the top of a rotating table 0.1 meters above the ground at a 3 meter semi-anechoiccamber. The table was rotated 360 degrees to determine the position of the highest radiation.
- b. The EUT was set 3 meters away from the interference-receiving antenna, which was mounted on the top of avariable-height antenna tower.

- c. The antenna height is varied from one meter to four meters above the ground to determine the maximum value of the field strength. Both horizontal and vertical polarizations of the antenna are set to make the measurement.
- d. For each suspected emission, the EUT was arranged to its worst case and then the antenna was tuned to heights from 1 meter to 4 meters (for the test frequency of below 30MHz, the antenna was tuned to heights 1meter) and the rotatable table was turned from 0 degrees to 360 degrees to find the maximum reading.
- e. The test-receiver system was set to Peak Detect Function and Specified Bandwidth with Maximum Hold Mode.
- f. If the emission level of the EUT in peak mode was 10dB lower than the limit specified, then testing could be stopped and the peak values of the EUT would be reported. Otherwise the emissions that did not have 10dB margin would be re-tested one by one using peak, quasi-peak or average method as specified and then reported in a data sheet.

Above 1GHz test procedure as below:

- g. Different between above is the test site, change from Semi- Anechoic Chamber to fully Anechoic Chamber and change form table 0.8 meter to 1.5 meter (Above 18GHz the distance is 1 meter and table is 1.5 meter).
- h. Test the EUT in the lowest channel ,the middle channel ,the Highest channel

Note:

Both horizontal and vertical antenna polarities were tested and performed pretest to three orthogonal axis. The worst case emissions were reported

4.2.3 DEVIATION FROM TEST STANDARD

No deviation

4.2.4 TEST SETUP

(A) Radiated Emission Test-Up Frequency Below 30MHz

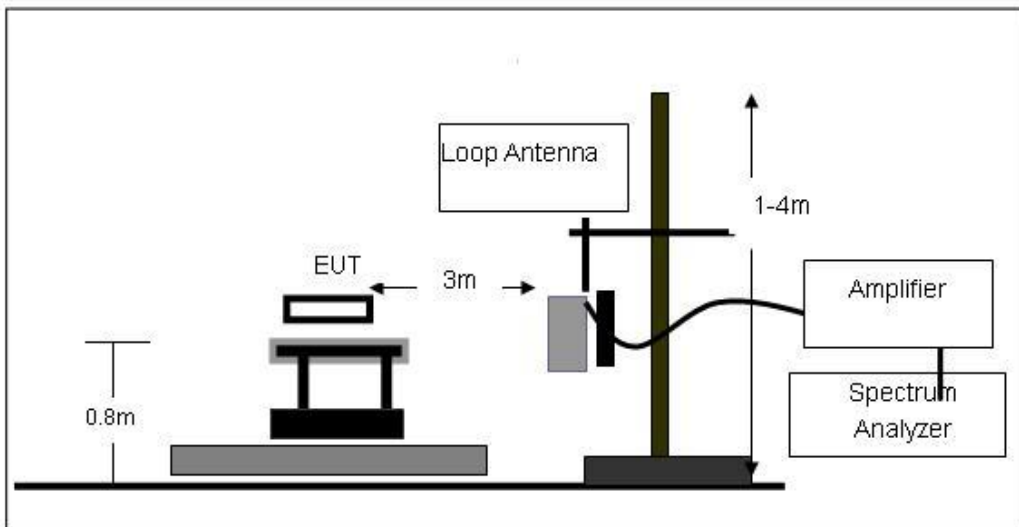

(B) Radiated Emission Test-Up Frequency 30MHz~1GHz

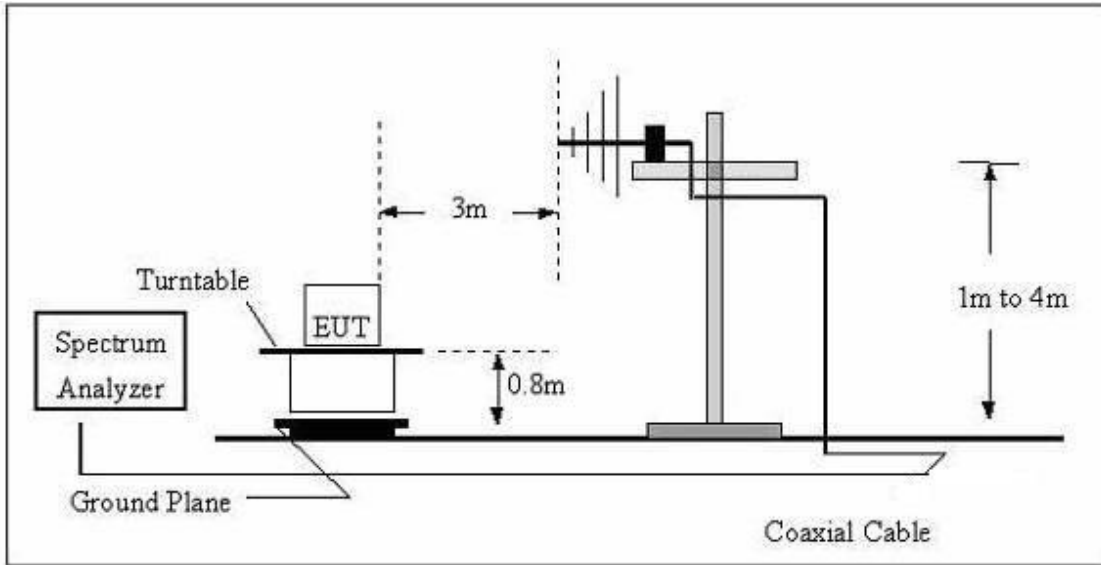

(C) Radiated Emission Test-Up Frequency Above 1GHz

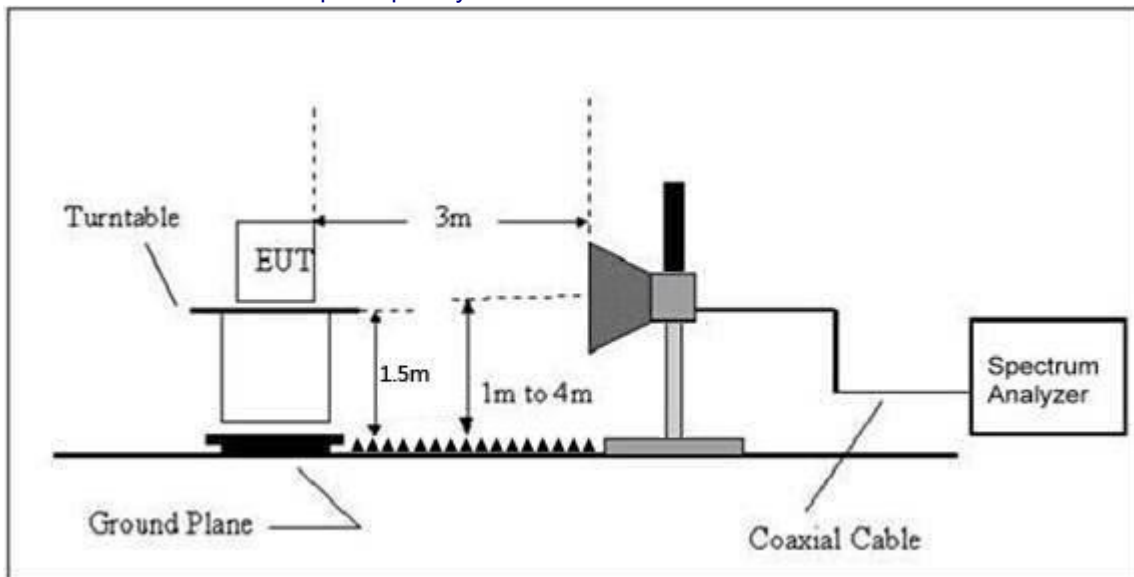

4.2.5 EUT OPERATING CONDITIONS

The EUT tested system was configured as the statements of 2.4 Unless otherwise a special operating condition is specified in the follows during the testing.

4.2.6 TEST RESULTS

Between 9KHz – 30MHz

The emission from 9 kHz to 30MHz was pre-tested and found the result was 20dB lower than the limit, and according to 15.31(o) & RSS-Gen 6.13, the test result no need to reported.

Between 30MHz – 1GHz

Temperature:	26°C	Relative Humidity:	54%
Pressure:	101 kPa	Polarization:	Horizontal
Test Voltage:	DC 3.8V	Test Mode	802.11b 2412MHz TX (Worst case)

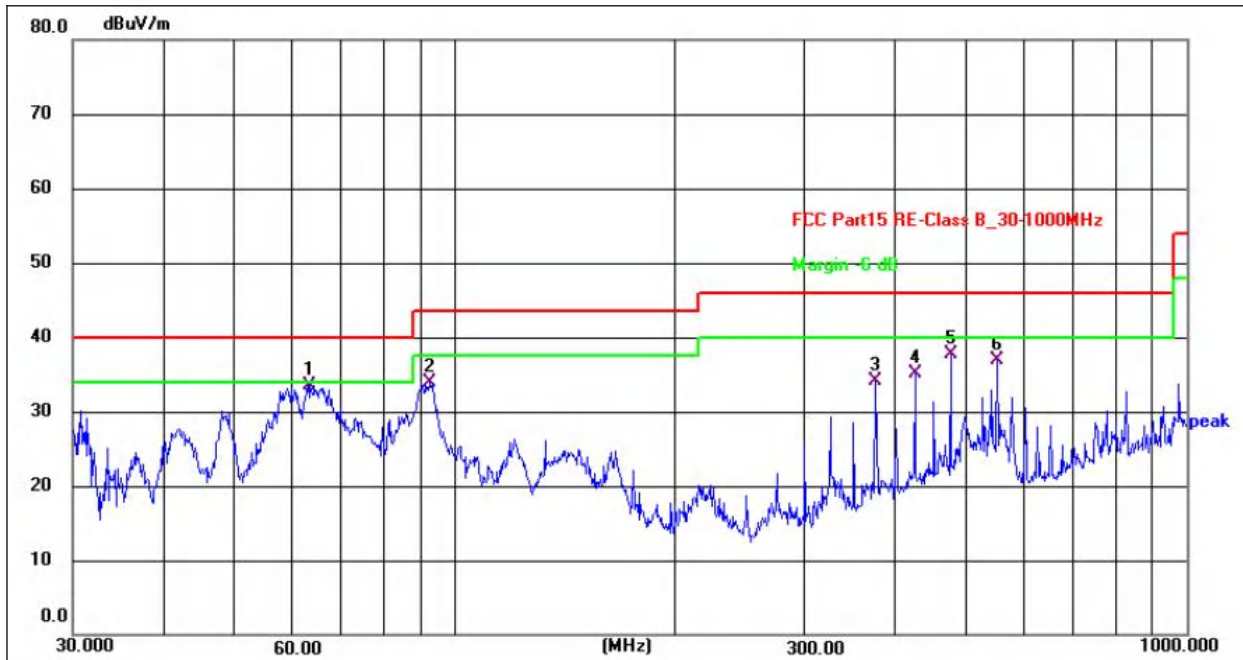

No.	Frequency (MHz)	Reading (dBuV)	Factor (dB/m)	Level (dBuV/m)	Limit (dBuV/m)	Margin (dB)	Detector
1 *	63.3132	51.19	-17.60	33.59	40.00	-6.41	QP
2	92.1388	53.98	-20.13	33.85	43.50	-9.65	QP
3	375.9385	48.24	-14.11	34.13	46.00	-11.87	QP
4	425.0280	47.56	-12.53	35.03	46.00	-10.97	QP
5	475.4991	49.12	-11.35	37.77	46.00	-8.23	QP
6	550.9480	46.68	-9.72	36.96	46.00	-9.04	QP

Temperature:	26°C	Relative Humidity:	54%
Pressure:	101kPa	Polarization:	Vertical
Test Voltage:	DC 3.8V	Test Mode	802.11b 2412MHz TX (Worst case)

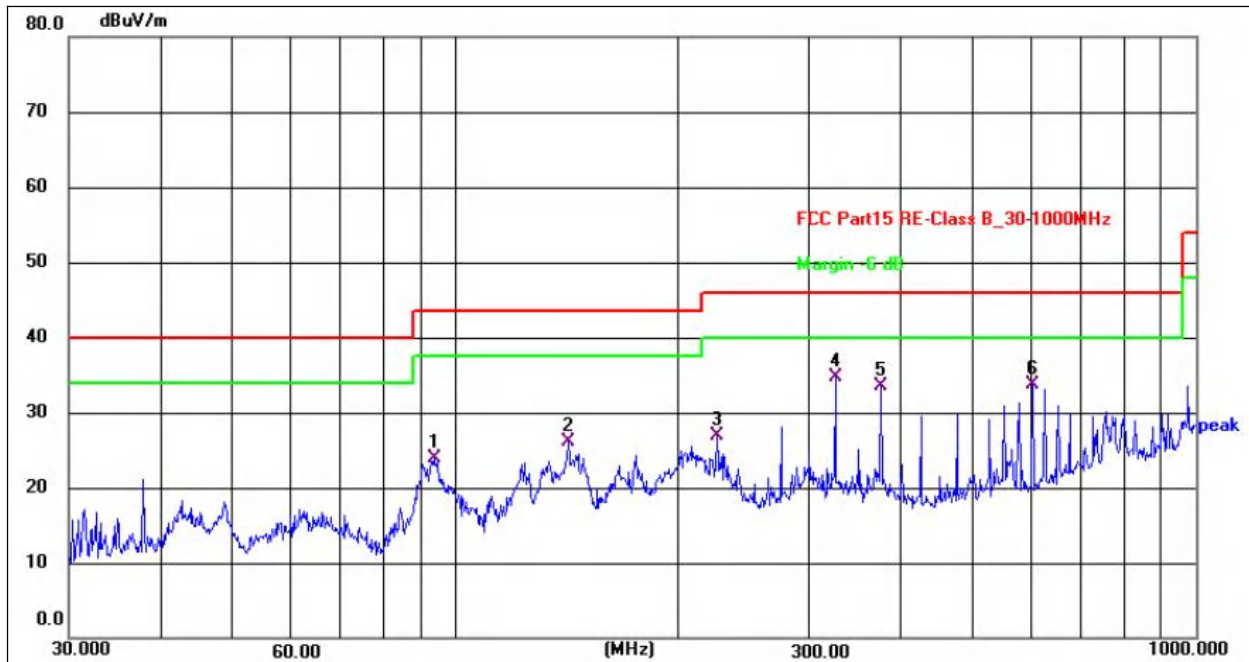

No.	Frequency (MHz)	Reading (dBuV)	Factor (dB/m)	Level (dBuV/m)	Limit (dBuV/m)	Margin (dB)	Detector
1	93.4402	44.02	-20.07	23.95	43.50	-19.55	QP
2	141.8262	42.75	-16.62	26.13	43.50	-17.37	QP
3	225.3080	45.80	-18.96	26.84	46.00	-19.16	QP
4 *	325.5958	50.11	-15.34	34.77	46.00	-11.23	QP
5	375.9385	47.59	-14.11	33.48	46.00	-12.52	QP
6	601.4265	42.63	-8.86	33.77	46.00	-12.23	QP

Remarks:

- 1.Final Level =Receiver Read level + Antenna Factor + Cable Loss – Pre-amplifier Factor
- 2.The emission levels of other frequencies are very lower than the limit and not show in test report.
- 3.The test data shows only the worst case 802.11b mode

1GHz~25GHz

802.11b

Polar (H/V)	Frequency	Meter Reading	Pre-ampl ifier	Cable Loss	Antenna Factor	Emission Level	Limits	Margin	Detect or Type
	(MHz)	(dBuV)	(dB)	(dB)	(dB)	(dBuV/m)	(dBuV/ m)	(dB)	
Low Channel:2412MHz									
V	4824.00	54.90	30.55	5.77	24.66	52.00	74.00	-22.00	Pk
V	4824.00	43.68	30.55	5.77	24.66	43.56	54.00	-10.44	AV
V	7236.00	52.31	30.33	6.32	24.55	52.85	74.00	-21.15	Pk
V	7236.00	43.55	30.33	6.32	24.55	44.09	54.00	-9.91	AV
V	9648.00	51.07	30.85	7.45	24.69	52.36	74.00	-21.64	Pk
V	9648.00	43.16	30.85	7.45	24.69	44.45	54.00	-9.55	AV
V	12060.00	50.83	31.02	8.99	25.57	54.37	74.00	-19.63	Pk
V	12060.00	43.75	31.02	8.99	25.57	47.29	54.00	-6.71	AV
H	4824.00	50.59	30.55	5.77	24.66	50.47	74.00	-23.53	Pk
H	4824.00	43.55	30.55	5.77	24.66	43.43	54.00	-10.57	AV
H	7236.00	52.77	30.33	6.32	24.55	53.31	74.00	-20.69	Pk
H	7236.00	43.08	30.33	6.32	24.55	43.62	54.00	-10.38	AV
H	9648.00	50.27	30.85	7.45	24.69	51.56	74.00	-22.44	Pk
H	9648.00	43.09	30.85	7.45	24.69	44.38	54.00	-9.62	AV
H	12060.00	51.10	31.02	8.99	25.57	54.64	74.00	-19.36	Pk
H	12060.00	43.98	31.02	8.99	25.57	47.52	54.00	-6.48	AV

Polar (H/V)	Frequency	Meter Reading	Pre-ampl ifier	Cable Loss	Antenna Factor	Emission Level	Limits	Margin	Detect or Type
	(MHz)	(dBuV)	(dB)	(dB)	(dB)	(dBuV/m)	(dBuV/ m)	(dB)	
Middle Channel:2437MHz									
V	4874.00	50.54	30.55	5.77	24.66	50.42	74.00	-23.58	Pk
V	4874.00	43.98	30.55	5.77	24.66	43.86	54.00	-10.14	AV
V	7311.00	53.42	30.33	6.32	24.55	53.96	74.00	-20.04	Pk
V	7311.00	43.58	30.33	6.32	24.55	44.12	54.00	-9.88	AV
V	9748.00	50.25	30.85	7.45	24.69	51.54	74.00	-22.46	Pk
V	9748.00	43.92	30.85	7.45	24.69	45.21	54.00	-8.79	AV
V	12185.00	52.10	31.02	8.99	25.57	55.64	74.00	-18.36	Pk
V	12185.00	43.97	31.02	8.99	25.57	47.51	54.00	-6.49	AV
H	4874.00	54.20	30.55	5.77	24.66	54.08	74.00	-19.92	Pk
H	4874.00	43.75	30.55	5.77	24.66	43.63	54.00	-10.37	AV
H	7311.00	53.26	30.33	6.32	24.55	53.80	74.00	-20.20	Pk
H	7311.00	43.11	30.33	6.32	24.55	43.65	54.00	-10.35	AV
H	9748.00	52.94	30.85	7.45	24.69	54.23	74.00	-19.77	Pk
H	9748.00	43.28	30.85	7.45	24.69	44.57	54.00	-9.43	AV
H	12185.00	53.02	31.02	8.99	25.57	56.56	74.00	-17.44	Pk
H	12185.00	43.23	31.02	8.99	25.57	46.77	54.00	-7.23	AV

Polar (H/V)	Frequency	Meter Reading	Pre-ampli fier	Cable Loss	Antenna Factor	Emission Level	Limits	Margin	Detect or Type
	(MHz)	(dBuV)	(dB)	(dB)	(dB)	(dBuV/m)	(dBuV/ m)	(dB)	
High Channel:2462MHz									
V	4924.00	53.27	30.55	5.77	24.66	53.15	74.00	-20.85	Pk
V	4924.00	43.99	30.55	5.77	24.66	43.87	54.00	-10.13	AV
V	7386.00	51.31	30.33	6.32	24.55	51.85	74.00	-22.15	Pk
V	7386.00	43.69	30.33	6.32	24.55	44.23	54.00	-9.77	AV
V	9848.00	52.82	30.85	7.45	24.69	54.11	74.00	-19.89	Pk
V	9848.00	43.42	30.85	7.45	24.69	44.71	54.00	-9.29	AV
V	12310.00	54.15	31.02	8.99	25.57	57.69	74.00	-16.31	Pk
V	12310.00	43.32	31.02	8.99	25.57	46.86	54.00	-7.14	AV
H	4924.00	53.59	30.55	5.77	24.66	53.47	74.00	-20.53	Pk
H	4924.00	43.38	30.55	5.77	24.66	43.26	54.00	-10.74	AV
H	7386.00	52.23	30.33	6.32	24.55	52.77	74.00	-21.23	Pk
H	7386.00	43.29	30.33	6.32	24.55	43.83	54.00	-10.17	AV
H	9848.00	54.06	30.85	7.45	24.69	55.35	74.00	-18.65	Pk
H	9848.00	43.91	30.85	7.45	24.69	45.20	54.00	-8.80	AV
H	12310.00	52.91	31.02	8.99	25.57	56.45	74.00	-17.55	Pk
H	12310.00	43.56	31.02	8.99	25.57	47.10	54.00	-6.90	AV

Remark:

1. Emission Level = Meter Reading + Antenna Factor + Cable Loss – Pre-amplifier,

Margin= Emission Level - Limit

2. If peak below the average limit, the average emission was no test.

3. The amplitude of spurious emissions which are attenuated by more than 20dB below the permissible value has no need to be reported.

802.11g

Polar (H/V)	Frequency	Meter Reading	Pre-amplifier	Cable Loss	Antenna Factor	Emission Level	Limits	Margin	Detect or Type
	(MHz)	(dBuV)	(dB)	(dB)	(dB)	(dBuV/m)	(dBuV/m)	(dB)	
Low Channel:2412MHz									
V	4824.00	50.26	30.55	5.77	24.66	50.14	74.00	-23.86	Pk
V	4824.00	43.93	30.55	5.77	24.66	43.81	54.00	-10.19	AV
V	7236.00	51.70	30.33	6.32	24.55	52.24	74.00	-21.76	Pk
V	7236.00	43.44	30.33	6.32	24.55	43.98	54.00	-10.02	AV
V	9648.00	51.58	30.85	7.45	24.69	52.87	74.00	-21.13	Pk
V	9648.00	43.14	30.85	7.45	24.69	44.43	54.00	-9.57	AV
V	12060.00	54.31	31.02	8.99	25.57	57.85	74.00	-16.15	Pk
V	12060.00	43.59	31.02	8.99	25.57	47.13	54.00	-6.87	AV
H	4824.00	53.23	30.55	5.77	24.66	53.11	74.00	-20.89	Pk
H	4824.00	43.14	30.55	5.77	24.66	43.02	54.00	-10.98	AV
H	7236.00	50.17	30.33	6.32	24.55	50.71	74.00	-23.29	Pk
H	7236.00	43.46	30.33	6.32	24.55	44.00	54.00	-10.00	AV
H	9648.00	51.34	30.85	7.45	24.69	52.63	74.00	-21.37	Pk
H	9648.00	43.07	30.85	7.45	24.69	44.36	54.00	-9.64	AV
H	12060.00	52.78	31.02	8.99	25.57	56.32	74.00	-17.68	Pk
H	12060.00	43.16	31.02	8.99	25.57	46.70	54.00	-7.30	AV

Polar (H/V)	Frequency	Meter Reading	Pre-amplifier	Cable Loss	Antenna Factor	Emission Level	Limits	Margin	Detect or Type
	(MHz)	(dBuV)	(dB)	(dB)	(dB)	(dBuV/m)	(dBuV/m)	(dB)	
Middle Channel:2437MHz									
V	4874.00	54.92	30.55	5.77	24.66	54.80	74.00	-19.20	Pk
V	4874.00	43.35	30.55	5.77	24.66	43.23	54.00	-10.77	AV
V	7311.00	53.00	30.33	6.32	24.55	53.54	74.00	-20.46	Pk
V	7311.00	43.13	30.33	6.32	24.55	43.67	54.00	-10.33	AV
V	9748.00	51.90	30.85	7.45	24.69	53.19	74.00	-20.81	Pk
V	9748.00	43.34	30.85	7.45	24.69	44.63	54.00	-9.37	AV
V	12185.00	54.49	31.02	8.99	25.57	58.03	74.00	-15.97	Pk
V	12185.00	43.62	31.02	8.99	25.57	47.16	54.00	-6.84	AV
H	4874.00	53.93	30.55	5.77	24.66	53.81	74.00	-20.19	Pk
H	4874.00	43.42	30.55	5.77	24.66	43.30	54.00	-10.70	AV
H	7311.00	53.60	30.33	6.32	24.55	54.14	74.00	-19.86	Pk
H	7311.00	43.42	30.33	6.32	24.55	43.96	54.00	-10.04	AV
H	9748.00	50.24	30.85	7.45	24.69	51.53	74.00	-22.47	Pk
H	9748.00	43.59	30.85	7.45	24.69	44.88	54.00	-9.12	AV
H	12185.00	51.33	31.02	8.99	25.57	54.87	74.00	-19.13	Pk
H	12185.00	43.66	31.02	8.99	25.57	47.20	54.00	-6.80	AV

Polar (H/V)	Frequency	Meter Reading	Pre-amplifier	Cable Loss	Antenna Factor	Emission Level	Limits	Margin	Detect or Type
	(MHz)	(dBuV)	(dB)	(dB)	(dB)	(dBuV/m)	(dBuV/m)	(dB)	
High Channel:2462MHz									
V	4924.00	53.62	30.55	5.77	24.66	53.50	74.00	-20.50	Pk
V	4924.00	43.62	30.55	5.77	24.66	43.50	54.00	-10.50	AV
V	7386.00	51.81	30.33	6.32	24.55	52.35	74.00	-21.65	Pk
V	7386.00	43.42	30.33	6.32	24.55	43.96	54.00	-10.04	AV
V	9848.00	53.49	30.85	7.45	24.69	54.78	74.00	-19.22	Pk
V	9848.00	43.45	30.85	7.45	24.69	44.74	54.00	-9.26	AV
V	12310.00	54.39	31.02	8.99	25.57	57.93	74.00	-16.07	Pk
V	12310.00	43.36	31.02	8.99	25.57	46.90	54.00	-7.10	AV
H	4924.00	54.98	30.55	5.77	24.66	54.86	74.00	-19.14	Pk
H	4924.00	43.46	30.55	5.77	24.66	43.34	54.00	-10.66	AV
H	7386.00	50.29	30.33	6.32	24.55	50.83	74.00	-23.17	Pk
H	7386.00	43.07	30.33	6.32	24.55	43.61	54.00	-10.39	AV
H	9848.00	51.20	30.85	7.45	24.69	52.49	74.00	-21.51	Pk
H	9848.00	43.78	30.85	7.45	24.69	45.07	54.00	-8.93	AV
H	12310.00	54.83	31.02	8.99	25.57	58.37	74.00	-15.63	Pk
H	12310.00	43.45	31.02	8.99	25.57	46.99	54.00	-7.01	AV

Remark:

1. Emission Level = Meter Reading + Antenna Factor + Cable Loss – Pre-amplifier,
Margin= Emission Level - Limit
2. If peak below the average limit, the average emission was no test.
3. The amplitude of spurious emissions which are attenuated by more than 20dB below the permissible value has no need to be reported.

802.11n20

Polar (H/V)	Frequency	Meter Reading	Pre-ampl ifier	Cable Loss	Antenna Factor	Emission Level	Limits	Margin	Detect or Type
	(MHz)	(dBuV)	(dB)	(dB)	(dB)	(dBuV/m)	(dBuV/ m)	(dB)	
Low Channel:2412MHz									
V	4824.00	54.81	30.55	5.77	24.66	54.69	74.00	-19.31	Pk
V	4824.00	43.15	30.55	5.77	24.66	43.03	54.00	-10.97	AV
V	7236.00	51.73	30.33	6.32	24.55	52.27	74.00	-21.73	Pk
V	7236.00	43.57	30.33	6.32	24.55	44.11	54.00	-9.89	AV
V	9648.00	53.95	30.85	7.45	24.69	55.24	74.00	-18.76	Pk
V	9648.00	43.14	30.85	7.45	24.69	44.43	54.00	-9.57	AV
V	12060.00	52.83	31.02	8.99	25.57	56.37	74.00	-17.63	Pk
V	12060.00	43.68	31.02	8.99	25.57	47.22	54.00	-6.78	AV
H	4824.00	53.99	30.55	5.77	24.66	53.87	74.00	-20.13	Pk
H	4824.00	43.61	30.55	5.77	24.66	43.49	54.00	-10.51	AV
H	7236.00	50.10	30.33	6.32	24.55	50.64	74.00	-23.36	Pk
H	7236.00	43.16	30.33	6.32	24.55	43.70	54.00	-10.30	AV
H	9648.00	52.13	30.85	7.45	24.69	53.42	74.00	-20.58	Pk
H	9648.00	43.06	30.85	7.45	24.69	44.35	54.00	-9.65	AV
H	12060.00	50.44	31.02	8.99	25.57	53.98	74.00	-20.02	Pk
H	12060.00	43.24	31.02	8.99	25.57	46.78	54.00	-7.22	AV

Polar (H/V)	Frequency	Meter Reading	Pre-ampl ifier	Cable Loss	Antenna Factor	Emission Level	Limits	Margin	Detect or Type
	(MHz)	(dBuV)	(dB)	(dB)	(dB)	(dBuV/m)	(dBuV/ m)	(dB)	
Middle Channel:2437MHz									
V	4874.00	53.63	30.55	5.77	24.66	53.51	74.00	-20.49	Pk
V	4874.00	43.70	30.55	5.77	24.66	43.58	54.00	-10.42	AV
V	7311.00	54.63	30.33	6.32	24.55	55.17	74.00	-18.83	Pk
V	7311.00	43.14	30.33	6.32	24.55	43.68	54.00	-10.32	AV
V	9748.00	54.34	30.85	7.45	24.69	55.63	74.00	-18.37	Pk
V	9748.00	43.28	30.85	7.45	24.69	44.57	54.00	-9.43	AV
V	12185.00	50.98	31.02	8.99	25.57	54.52	74.00	-19.48	Pk
V	12185.00	43.72	31.02	8.99	25.57	47.26	54.00	-6.74	AV
H	4874.00	50.77	30.55	5.77	24.66	50.65	74.00	-23.35	Pk
H	4874.00	43.03	30.55	5.77	24.66	42.91	54.00	-11.09	AV
H	7311.00	50.48	30.33	6.32	24.55	51.02	74.00	-22.98	Pk
H	7311.00	43.86	30.33	6.32	24.55	44.40	54.00	-9.60	AV
H	9748.00	51.90	30.85	7.45	24.69	53.19	74.00	-20.81	Pk
H	9748.00	43.14	30.85	7.45	24.69	44.43	54.00	-9.57	AV
H	12185.00	52.25	31.02	8.99	25.57	55.79	74.00	-18.21	Pk
H	12185.00	43.18	31.02	8.99	25.57	46.72	54.00	-7.28	AV

Polar (H/V)	Frequency	Meter Reading	Pre-amplifier	Cable Loss	Antenna Factor	Emission Level	Limits	Margin	Detect or Type
	(MHz)	(dBuV)	(dB)	(dB)	(dB)	(dBuV/m)	(dBuV/m)	(dB)	
High Channel:2462MHz									
V	4924.00	51.33	30.55	5.77	24.66	51.21	74.00	-22.79	Pk
V	4924.00	43.28	30.55	5.77	24.66	43.16	54.00	-10.84	AV
V	7386.00	52.81	30.33	6.32	24.55	53.35	74.00	-20.65	Pk
V	7386.00	43.19	30.33	6.32	24.55	43.73	54.00	-10.27	AV
V	9848.00	54.59	30.85	7.45	24.69	55.88	74.00	-18.12	Pk
V	9848.00	43.83	30.85	7.45	24.69	45.12	54.00	-8.88	AV
V	12310.00	54.37	31.02	8.99	25.57	57.91	74.00	-16.09	Pk
V	12310.00	43.65	31.02	8.99	25.57	47.19	54.00	-6.81	AV
H	4924.00	51.08	30.55	5.77	24.66	50.96	74.00	-23.04	Pk
H	4924.00	43.61	30.55	5.77	24.66	43.49	54.00	-10.51	AV
H	7386.00	53.02	30.33	6.32	24.55	53.56	74.00	-20.44	Pk
H	7386.00	43.23	30.33	6.32	24.55	43.77	54.00	-10.23	AV
H	9848.00	51.71	30.85	7.45	24.69	53.00	74.00	-21.00	Pk
H	9848.00	43.44	30.85	7.45	24.69	44.73	54.00	-9.27	AV
H	12310.00	50.07	31.02	8.99	25.57	53.61	74.00	-20.39	Pk
H	12310.00	43.97	31.02	8.99	25.57	47.51	54.00	-6.49	AV

Remark:

1. Emission Level = Meter Reading + Antenna Factor + Cable Loss – Pre-amplifier,
Margin= Emission Level - Limit
2. If peak below the average limit, the average emission was no test.
3. The amplitude of spurious emissions which are attenuated by more than 20dB below the permissible value has no need to be reported.

5.RADIATED BAND EMISSIONMEASUREMENT

5.1 TEST REQUIREMENT:

Test Requirement:	FCC Part15 C Section 15.209 and 15.205				
Test Method:	ANSI C63.10: 2013				
Test Frequency Range:	All of the restrict bands were tested, only the worst band's (2310MHz to 2500MHz) data was showed.				
Test site:	Measurement Distance: 3m				
Receiver setup:	Frequency	Detector	RBW	VBW	Value
	Above	Peak	1MHz	3MHz	Peak
	1GHz	Peak	1MHz	10Hz	Average

LIMITS OF RADIATED EMISSION MEASUREMENT (Above 1000MHz)

FREQUENCY (MHz)	Class B (dBuV/m) (at 3M)	
	PEAK	AVERAGE
Above 1000	74	54

Notes:

- (1) The limit for radiated test was performed according to FCC PART 15C.
- (2) The tighter limit applies at the band edges.
- (3) Emission level (dBuV/m)=20log Emission level (uV/m).

5.2 TEST PROCEDURE

Above 1GHz test procedure as below:

- a. 1. The EUT was placed on the top of a rotating table 1.5 meters above the ground at a 3 meter camber. The table was rotated 360 degrees to determine the position of the highest radiation.
- b. The EUT was set 3 meters away from the interference-receiving antenna, which was mounted on the top of a variable-height antenna tower.
- c. The antenna height is varied from one meter to four meters above the ground to determine the maximum value of the field strength. Both horizontal and vertical polarizations of the antenna are set to make the measurement.
- d. For each suspected emission, the EUT was arranged to its worst case and then the antenna was tuned to heights from 1 meter to 4 meters and the rota table was turned from 0 degrees to 360 degrees to find the maximum reading.
- e. The test-receiver system was set to Peak Detect Function and Specified Bandwidth with Maximum Hold Mode.
- f. If the emission level of the EUT in peak mode was 10dB lower than the limit specified, then testing could bestopped and the peak values of the EUT would be reported. Otherwise the emissions that did not have 10dBmargin would be re-tested one by one using peak, quasi-peak or average method as specified and then reportedin a data sheet.
- g. Test the EUT in the lowest channel,the Highest channel

Note:

Both horizontal and vertical antenna polarities were tested and performed pretest to three orthogonal axis. The worst case emissions were reported

5.3 DEVIATION FROM TEST STANDARD

No deviation

5.4 TEST SETUP

Radiated Emission Test-Up Frequency Above 1GHz

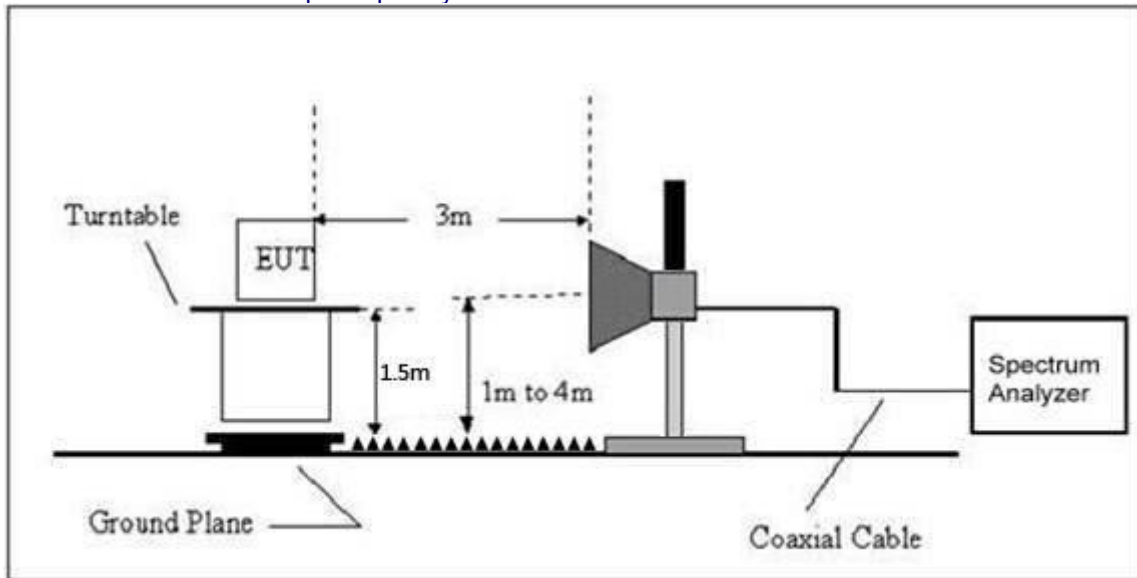

5.5 EUT OPERATING CONDITIONS

The EUT tested system was configured as the statements of 2.3 Unless otherwise a special operating condition is specified in the follows during the testing.

5.6 TEST RESULT

All modes were tested (Worst case 802.11b)

Temperature:	26°C	Relative Humidity:	54%
Pressure:	101kPa	Polarization:	Horizontal
Test Voltage:	DC 3.8V	Test channel	2412MHz (Worst case)

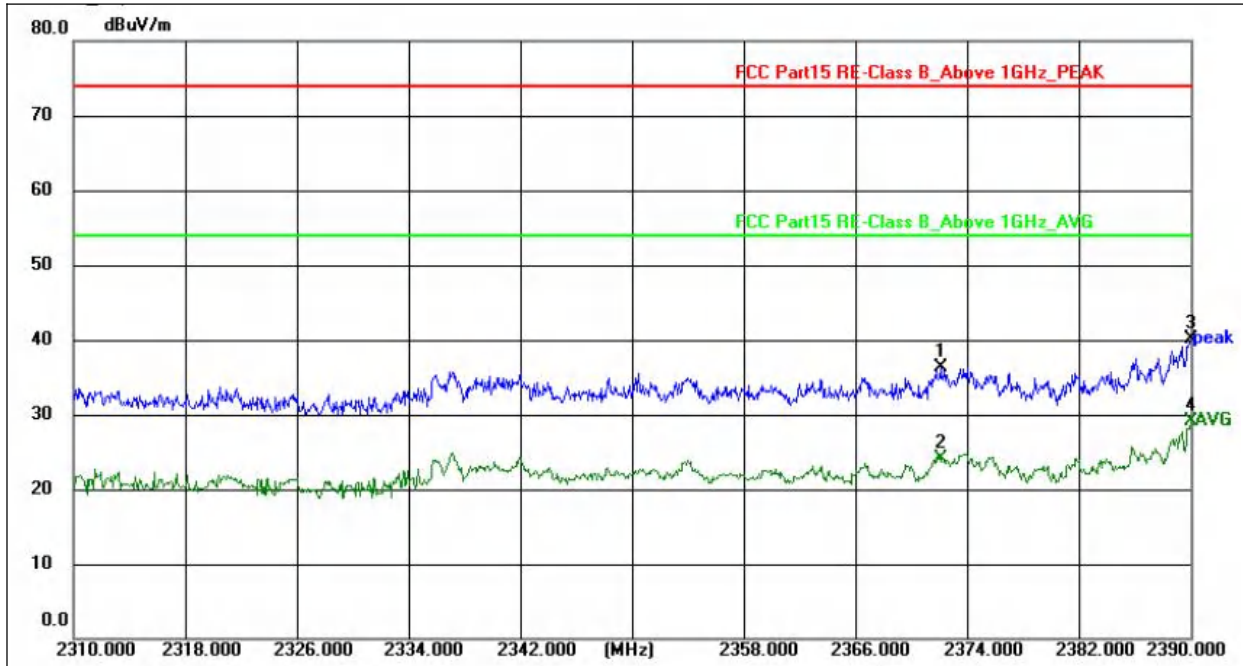

No.	Frequency (MHz)	Reading (dBuV)	Factor (dB/m)	Level (dBuV/m)	Limit (dBuV/m)	Margin (dB)	Detector
1	2372.080	40.33	-4.05	36.28	74.00	-37.72	peak
2	2372.080	28.20	-4.05	24.15	54.00	-29.85	AVG
3	2390.000	44.15	-3.96	40.19	74.00	-33.81	peak
4 *	2390.000	33.07	-3.96	29.11	54.00	-24.89	AVG

Temperature:	26°C	Relative Humidity:	54%
Pressure:	101kPa	Polarization:	Vertical
Test Voltage:	DC 3.8V	Test channel	2412MHz (Worst case)

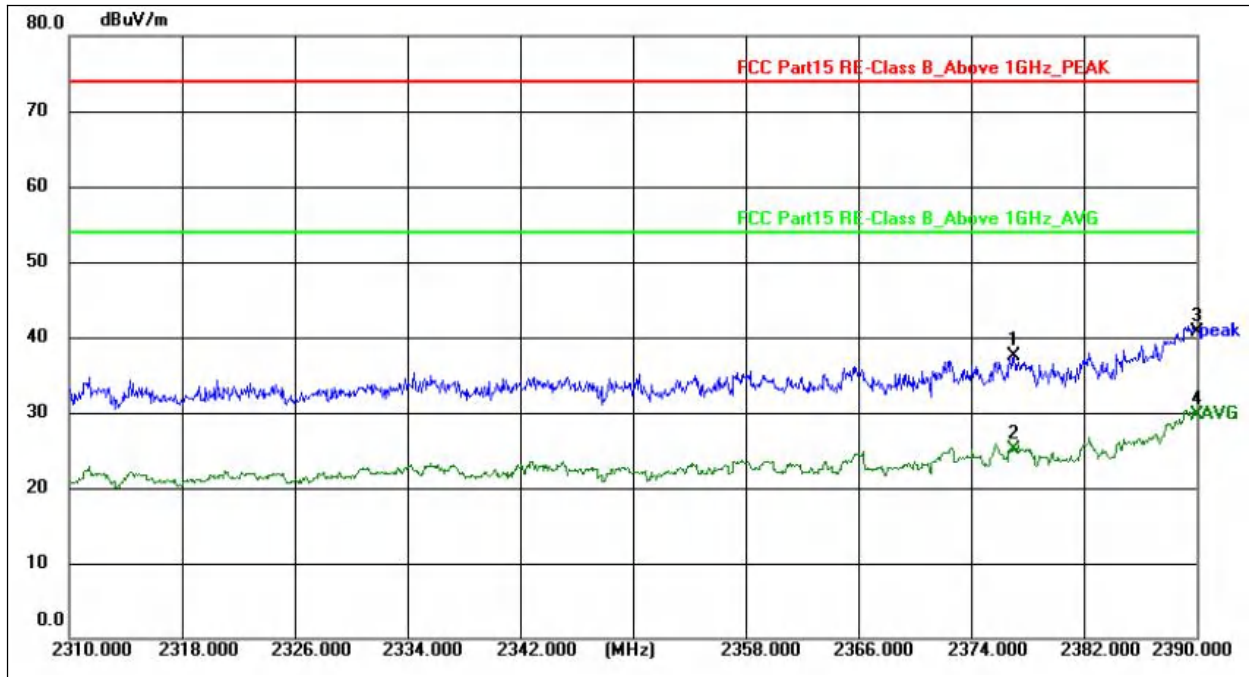

No.	Frequency (MHz)	Reading (dBuV)	Factor (dB/m)	Level (dBuV/m)	Limit (dBuV/m)	Margin (dB)	Detector
1	2377.040	41.44	-4.02	37.42	74.00	-36.58	peak
2	2377.040	29.12	-4.02	25.10	54.00	-28.90	AVG
3	2390.000	44.65	-3.96	40.69	74.00	-33.31	peak
4 *	2390.000	33.57	-3.96	29.61	54.00	-24.39	AVG

Temperature:	26°C	Relative Humidity:	54%
Pressure:	101kPa	Polarization:	Horizontal
Test Voltage:	DC 3.8V	Test channel	2462MHz (Worst case)

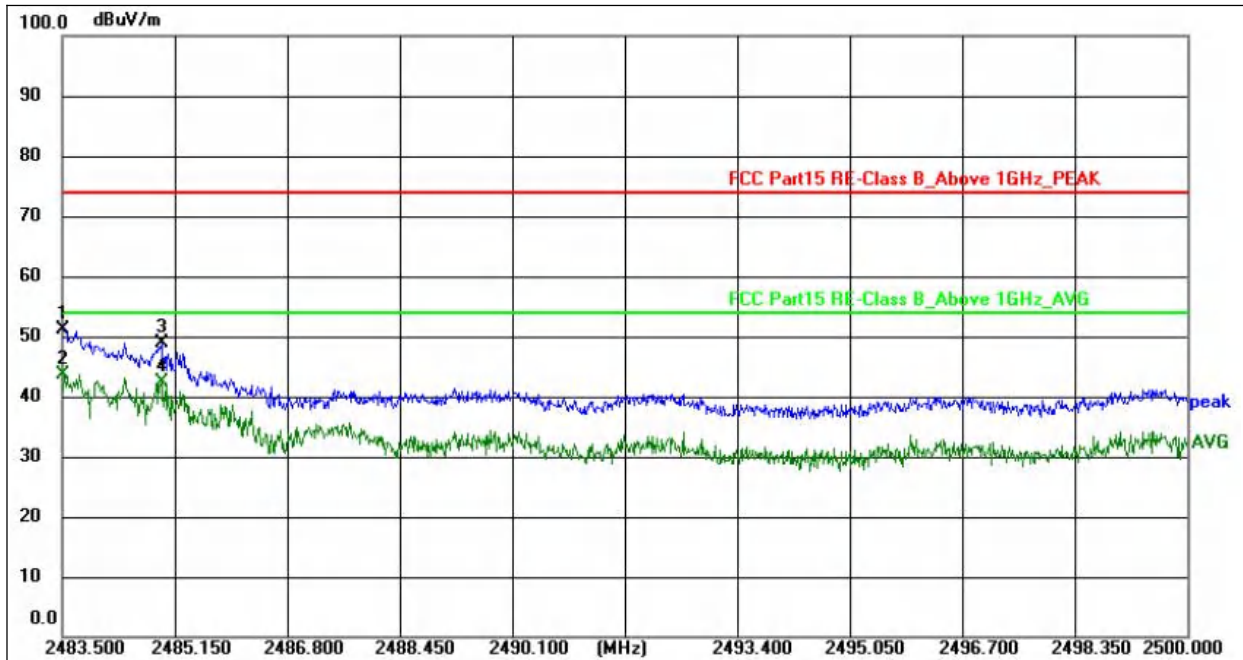

No.	Frequency (MHz)	Reading (dBuV)	Factor (dB/m)	Level (dBuV/m)	Limit (dBuV/m)	Margin (dB)	Detector
1	2483.500	54.65	-3.58	51.07	74.00	-22.93	peak
2 *	2483.500	47.23	-3.58	43.65	54.00	-10.35	AVG
3	2484.974	52.52	-3.57	48.95	74.00	-25.05	peak
4	2484.974	46.03	-3.57	42.46	54.00	-11.54	AVG

Temperature:	26°C	Relative Humidity:	54%
Pressure:	101kPa	Polarization:	Vertical
Test Voltage:	DC 3.8V	Test channel	2462MHz (Worst case)

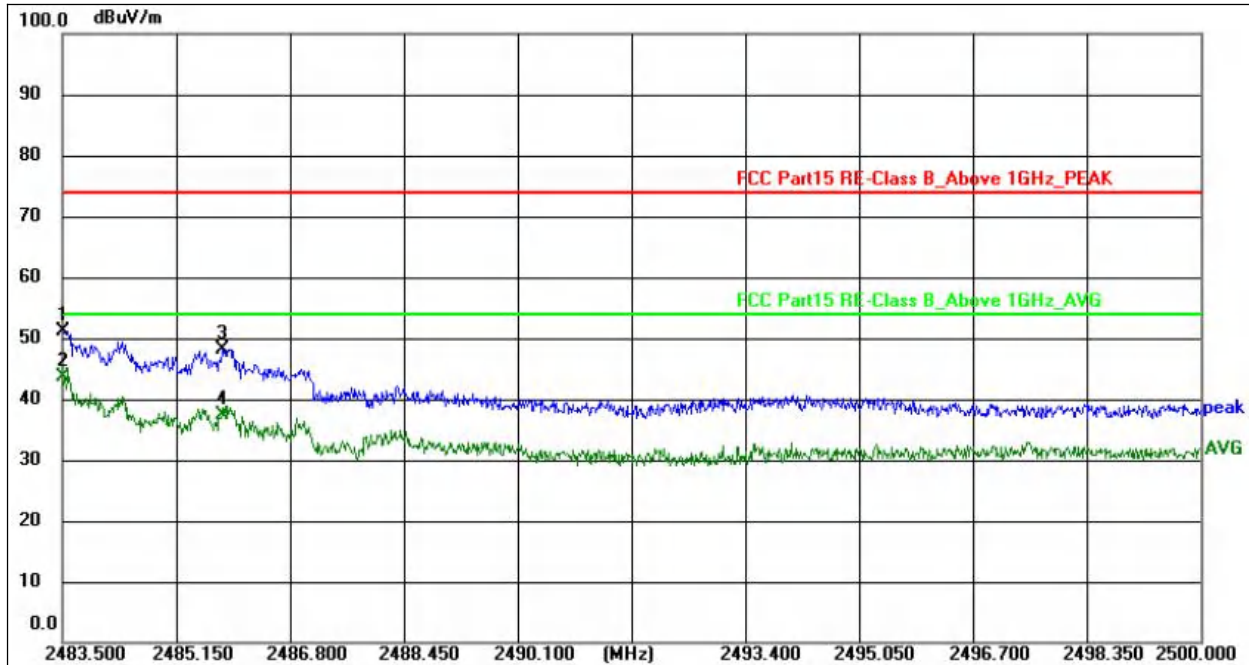

No.	Frequency (MHz)	Reading (dBuV)	Factor (dB/m)	Level (dBuV/m)	Limit (dBuV/m)	Margin (dB)	Detector
1	2483.500	54.65	-3.58	51.07	74.00	-22.93	peak
2 *	2483.500	47.23	-3.58	43.65	54.00	-10.35	AVG
3	2485.856	51.82	-3.57	48.25	74.00	-25.75	peak
4	2485.856	40.99	-3.57	37.42	54.00	-16.58	AVG

6.POWER SPECTRAL DENSITY TEST

Test Requirement:	FCC Part15 C Section 15.247 (e)
Test Method:	KDB558074 D0115.247 Meas Guidancev05r02

6.1 APPLIED PROCEDURES / LIMIT

FCC Part15 (15.247) , Subpart C				
Section	Test Item	Limit	Frequency Range (MHz)	Result
15.247	Power Spectral Density	8dBm/3kHz(SISO)	2400-2483.5	PASS

6.2 TEST PROCEDURE

1. Set analyzer center frequency to DTS channel center frequency.
2. Set the span to 1.5 times the DTS bandwidth.
3. Set the RBW to: $3\text{ kHz} \leq \text{RBW} \leq 100\text{ kHz}$.
4. Set the VBW $\geq 3 \times \text{RBW}$.
5. Detector = peak.
6. Sweep time = auto couple.
7. Trace mode = max hold.
8. Allow trace to fully stabilize.
9. Use the peak marker function to determine the maximum amplitude level within the RBW.
10. If measured value exceeds limit, reduce RBW (no less than 3 kHz) and repeat.

6.3 DEVIATION FROM STANDARD

No deviation.

6.4 TEST SETUP



6.5 EUT OPERATION CONDITIONS

The EUT tested system was configured as the statements of 2.1 Unless otherwise a special operating condition is specified in the follows during the testing.

6.6 TEST RESULT

Mode	Frequency (MHz)	Conducted PSD (dBm/3kHz)	Limit (dBm/3kHz) <=	Verdict
b	2412	-30.73	8	Pass
b	2437	-30.95	8	Pass
b	2462	-31.14	8	Pass
g	2412	-29.87	8	Pass
g	2437	-29.73	8	Pass
g	2462	-30.24	8	Pass
n20	2412	-29.16	8	Pass
n20	2437	-28.9	8	Pass
n20	2462	-29.02	8	Pass



PSD NVNT b 2412MHz Ant1



PSD NVNT b 2437MHz Ant1

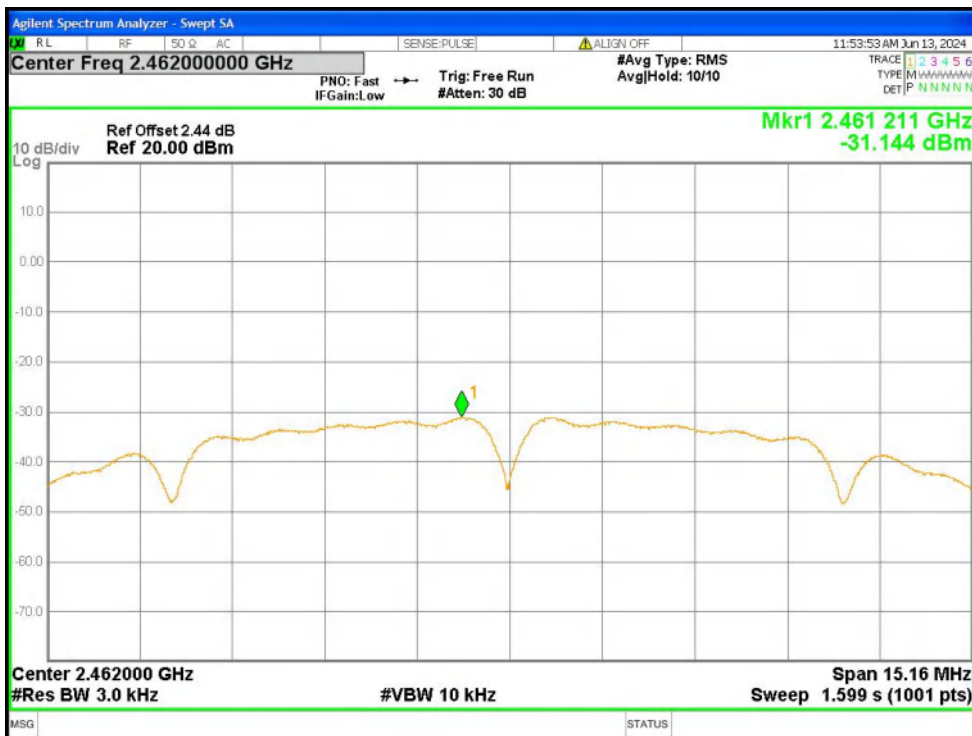

PSD NVNT b 2462MHz Ant1

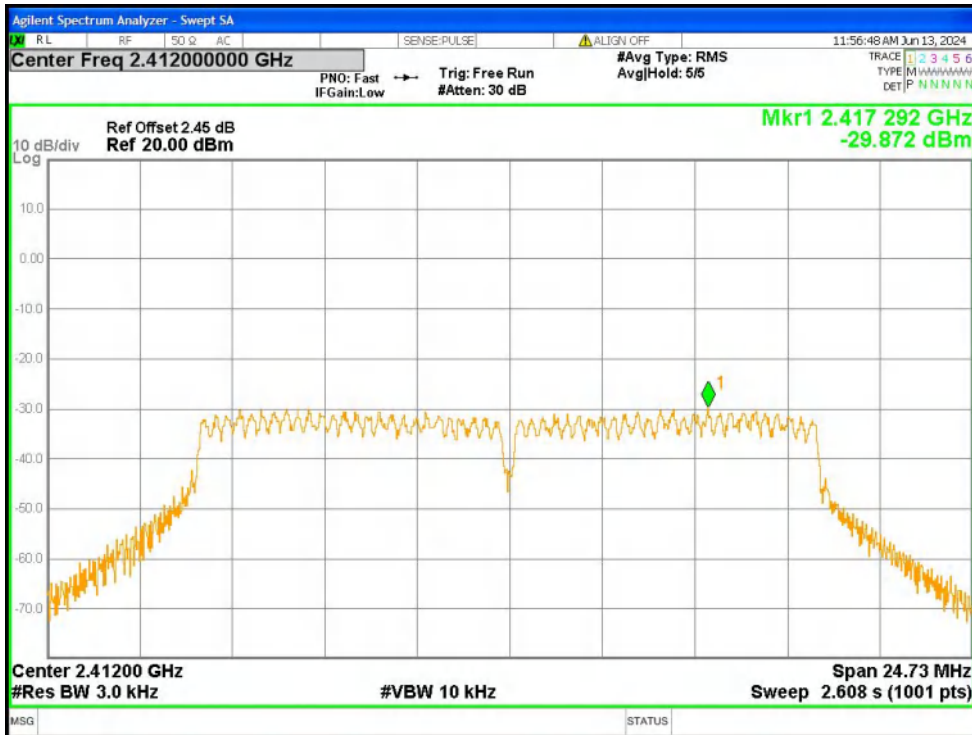

PSD NVNT g 2412MHz Ant1

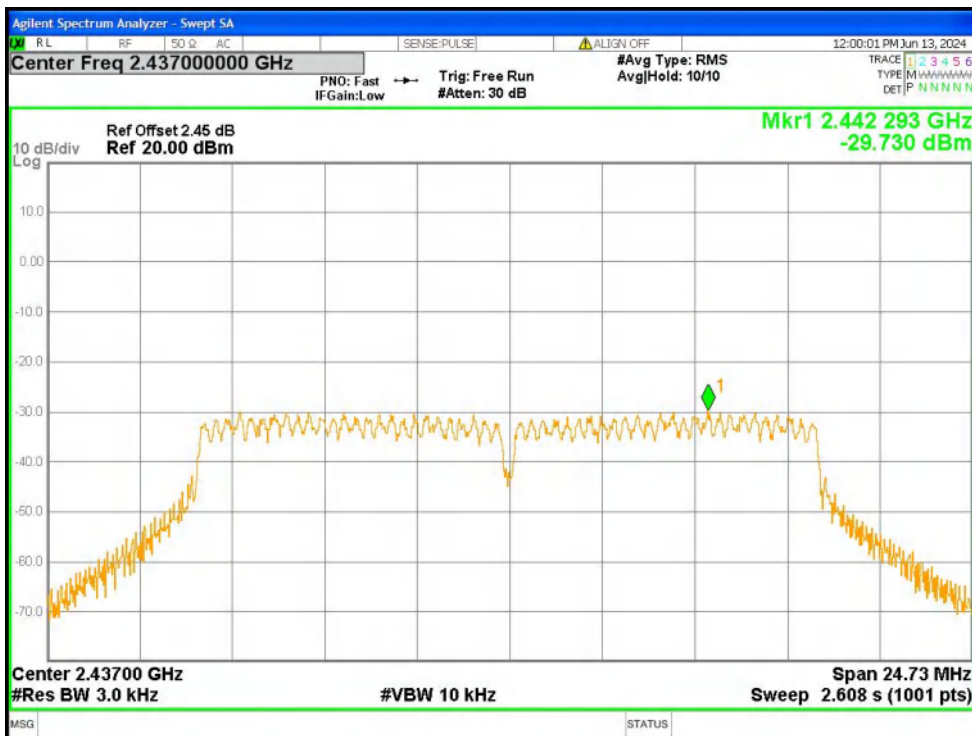

PSD NVNT g 2437MHz Ant1

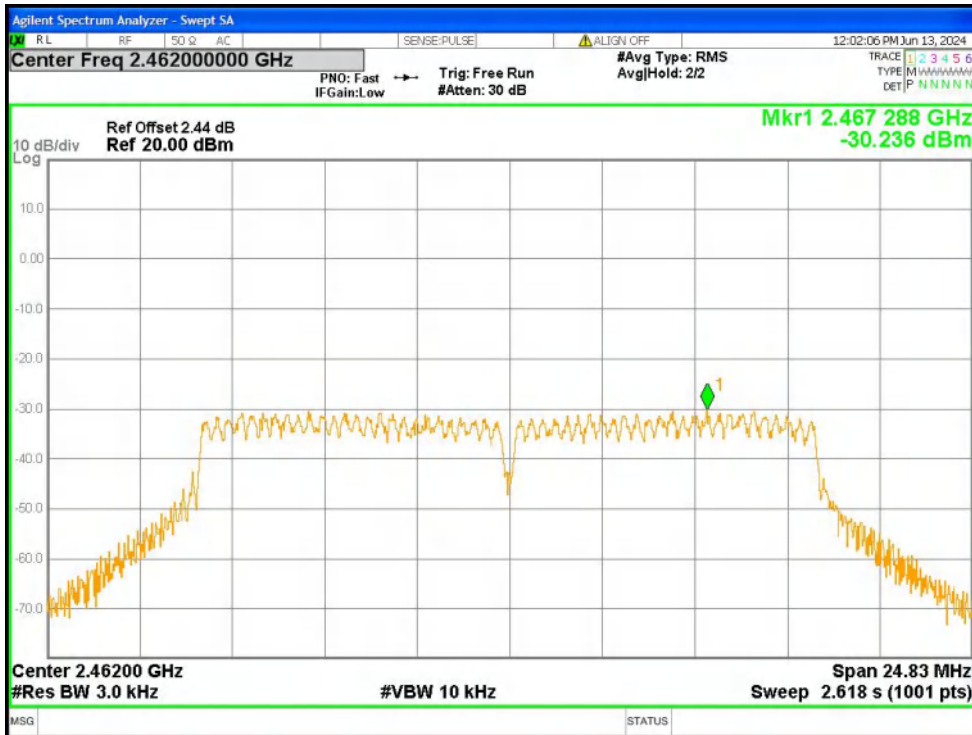

PSD NVNT g 2462MHz Ant1

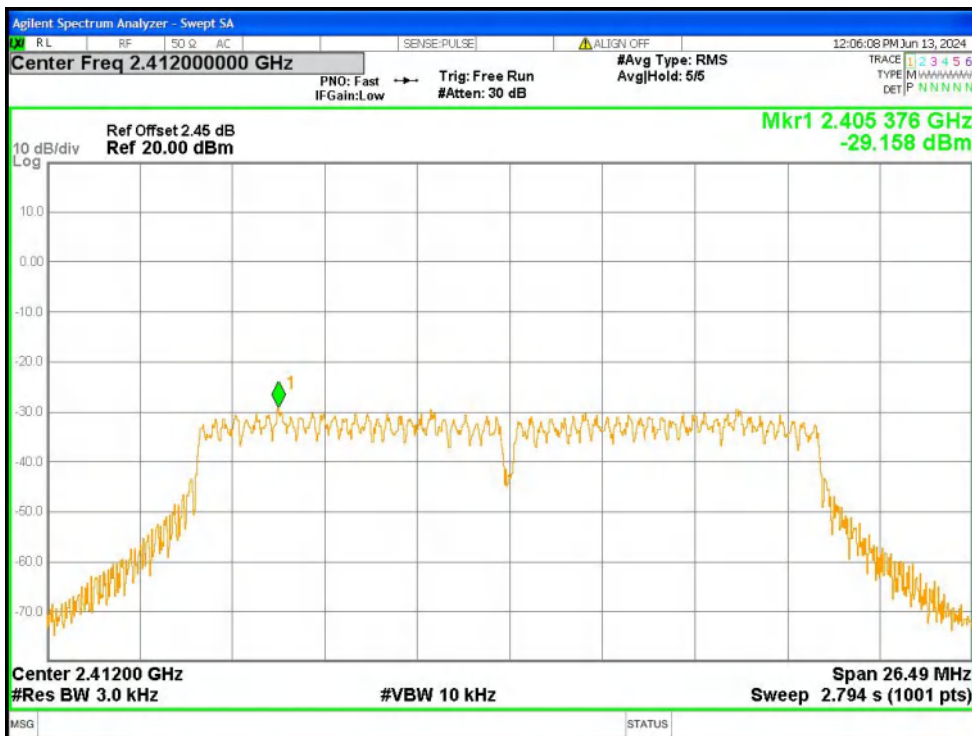

PSD NVNT n20 2412MHz Ant1

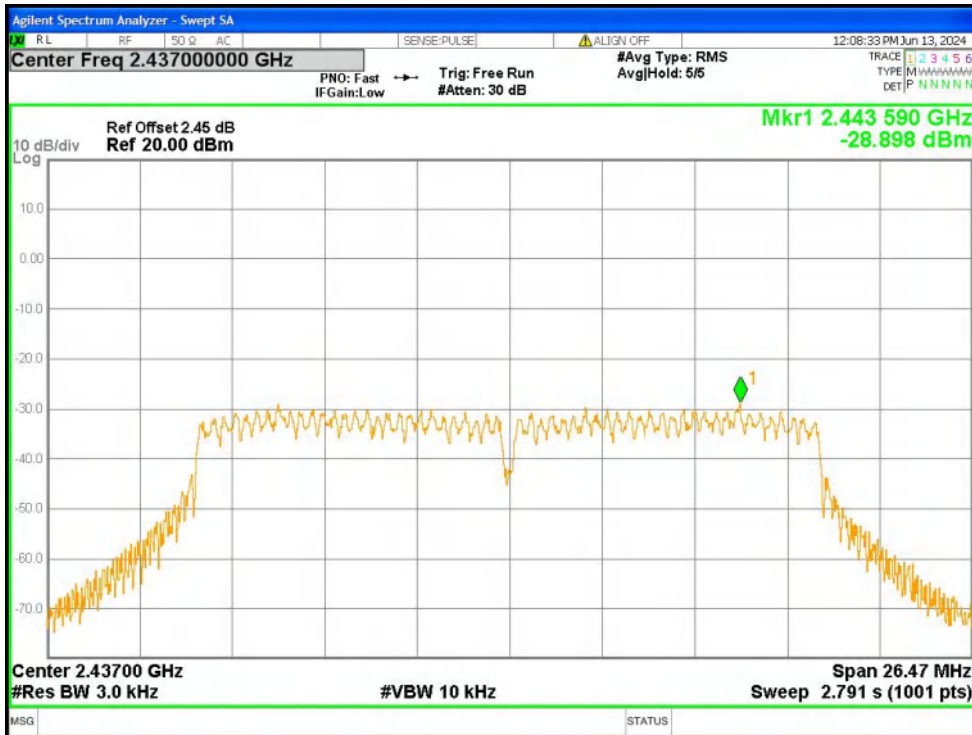

PSD NVNT n20 2437MHz Ant1

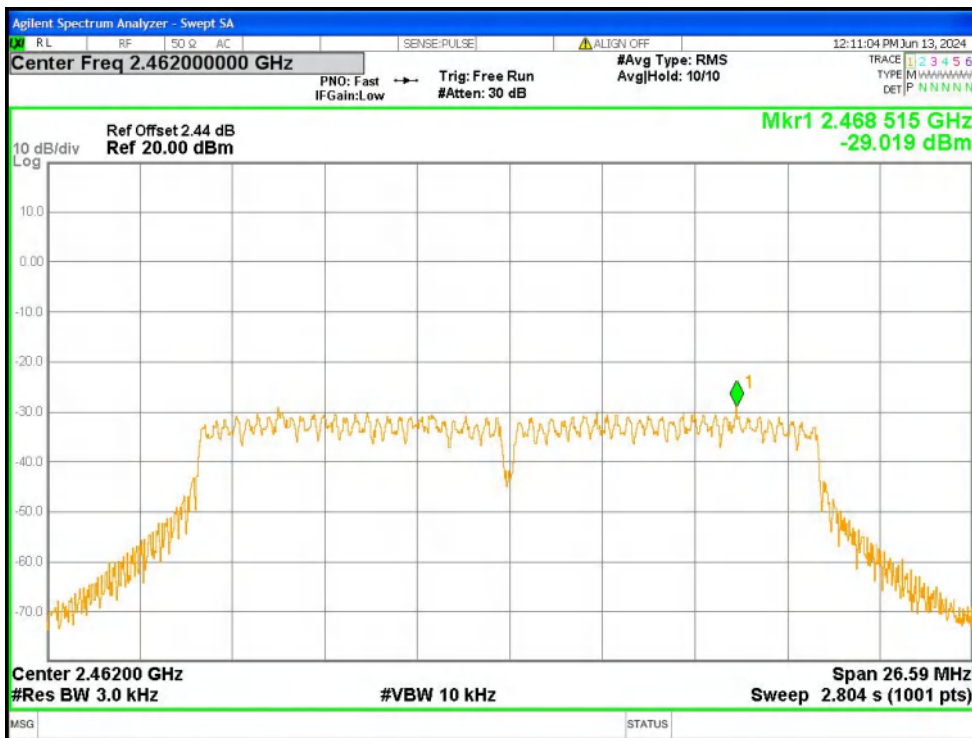

PSD NVNT n20 2462MHz Ant1

7. CHANNEL BANDWIDTH

Test Requirement:	FCC Part15 C Section 15.247 (a)(2)
Test Method:	KDB558074 D0115.247 Meas Guidancev05r02

7.1 APPLIED PROCEDURES / LIMIT

FCC Part15 (15.247) , Subpart C				
Section	Test Item	Limit	Frequency Range (MHz)	Result
15.247(a)(2)	Bandwidth	$\geq 500\text{KHz}$ (6dB bandwidth)	2400-2483.5	PASS

7.2 TEST PROCEDURE

1. Set RBW = 100 kHz.
2. Set the video bandwidth (VBW) $\geq 3 \times \text{RBW}$.
3. Detector = Peak.
4. Trace mode = max hold.
5. Sweep = auto couple.
6. Allow the trace to stabilize.
7. Measure the maximum width of the emission that is constrained by the frequencies associated with the two outermost amplitude points (upper and lower frequencies) that are attenuated by 6 dB relative to the maximum level measured in the fundamental emission.

7.3 DEVIATION FROM STANDARD

No deviation.

7.4 TEST SETUP

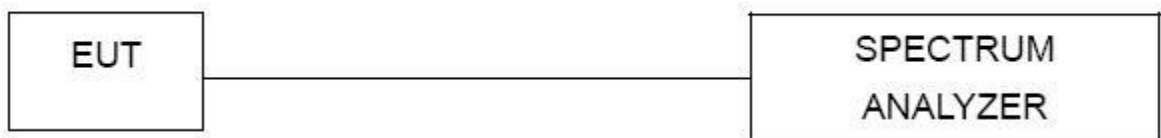

7.5 EUT OPERATION CONDITIONS

The EUT tested system was configured as the statements of 2.4 Unless otherwise a special operating condition is specified in the follows during the testing.

7.6 TEST RESULT

Mode	Frequency (MHz)	-6 dB Bandwidth (MHz)	Limit -6 dB Bandwidth (MHz)	Verdict
b	2412	10.096	0.5	Pass
b	2437	10.076	0.5	Pass
b	2462	10.109	0.5	Pass
g	2412	16.487	0.5	Pass
g	2437	16.488	0.5	Pass
g	2462	16.551	0.5	Pass
n20	2412	17.663	0.5	Pass
n20	2437	17.644	0.5	Pass
n20	2462	17.729	0.5	Pass

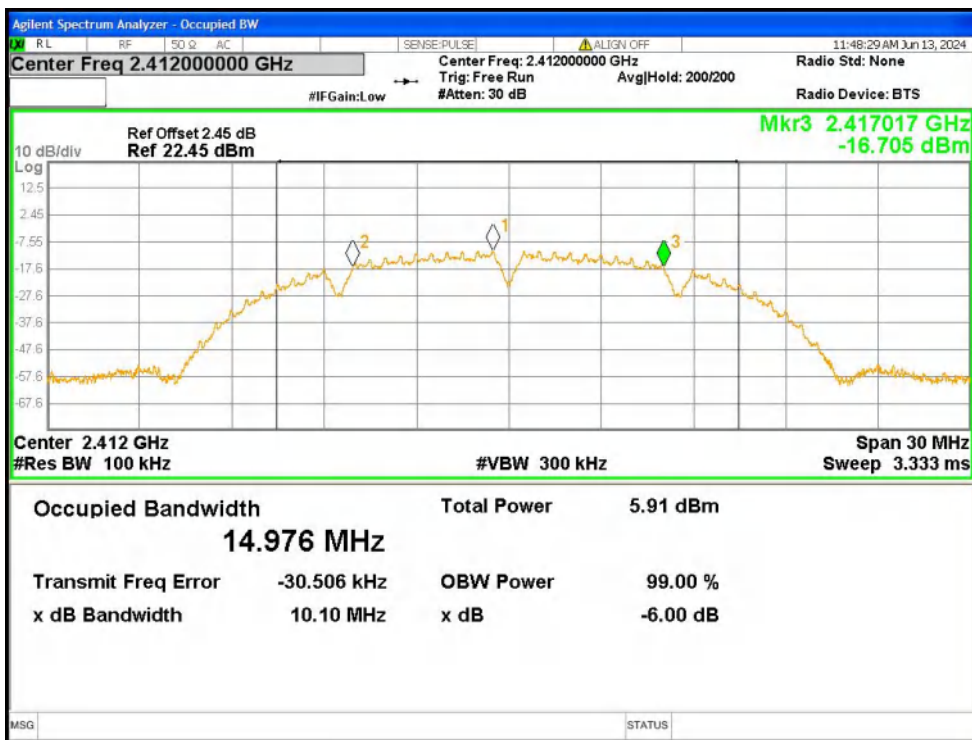

-6dB Bandwidth NVNT b 2412MHz Ant1

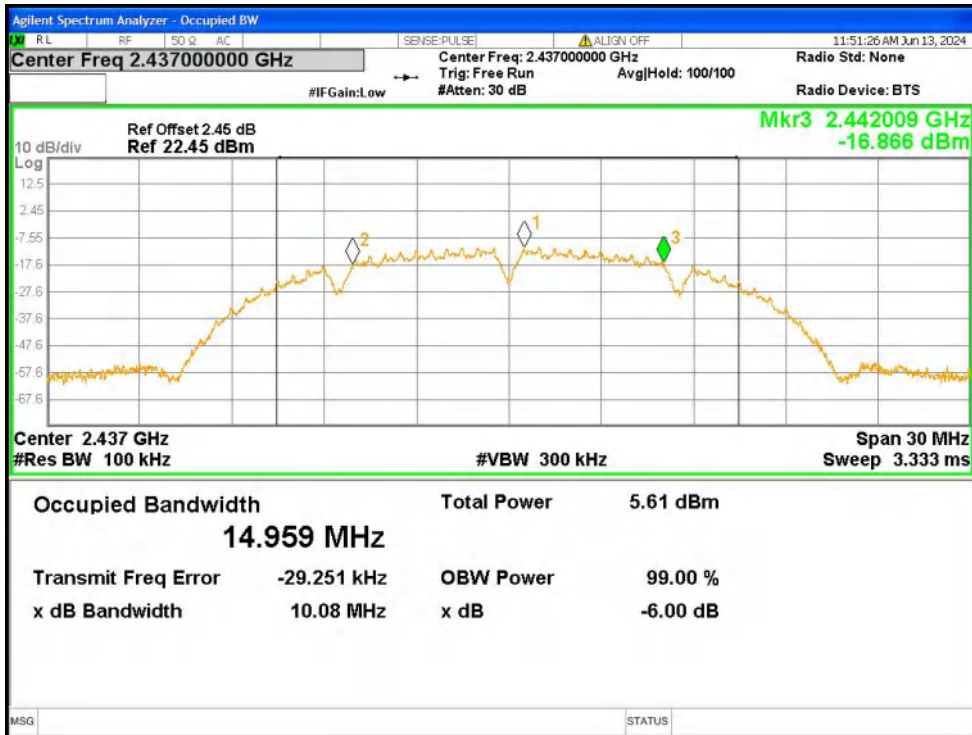

-6dB Bandwidth NVNT b 2437MHz Ant1

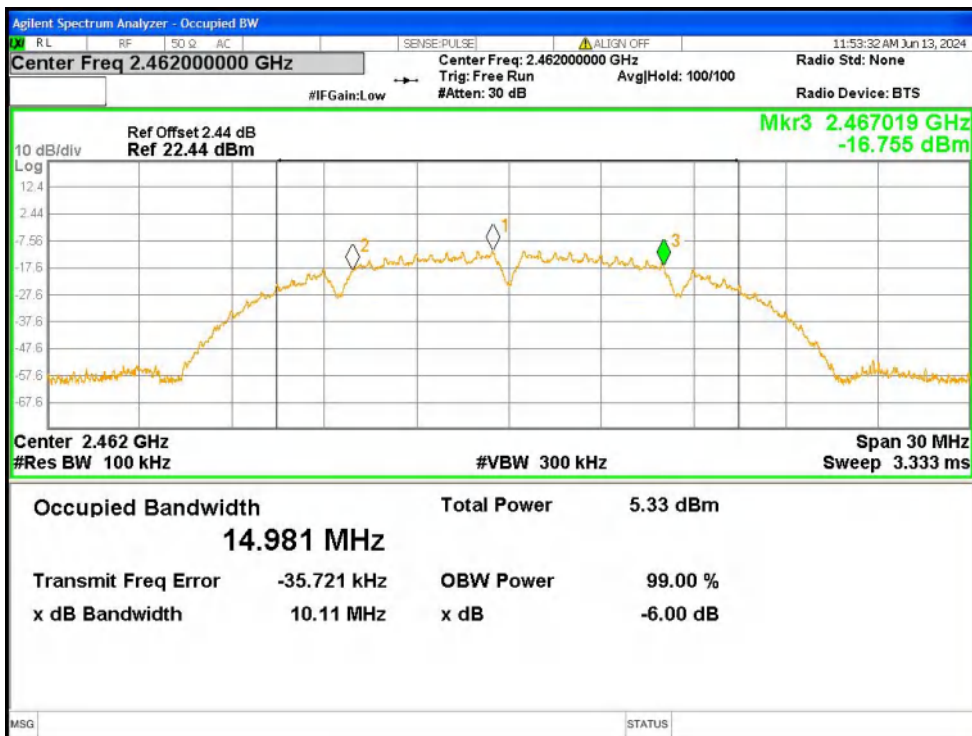

-6dB Bandwidth NVNT b 2462MHz Ant1

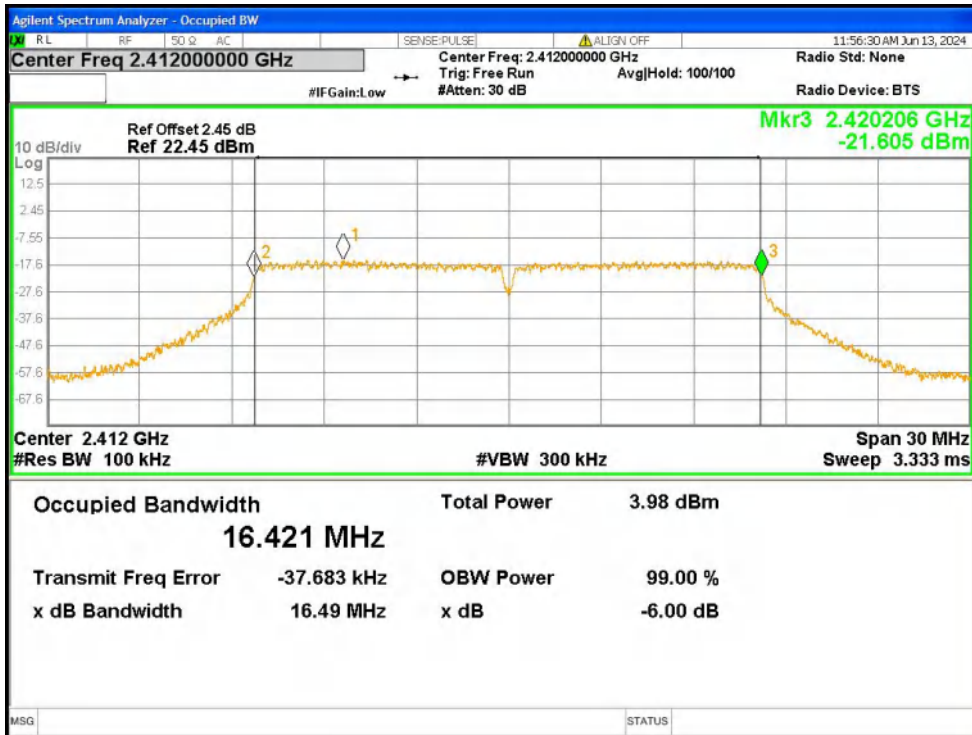

-6dB Bandwidth NVNT g 2412MHz Ant1

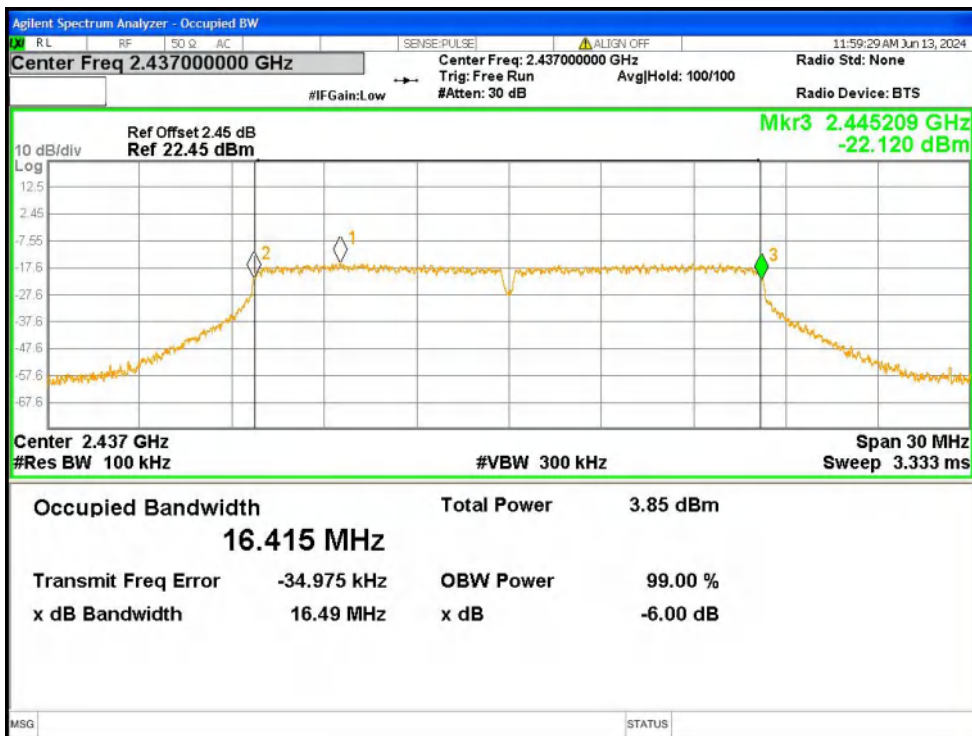

-6dB Bandwidth NVNT g 2437MHz Ant1

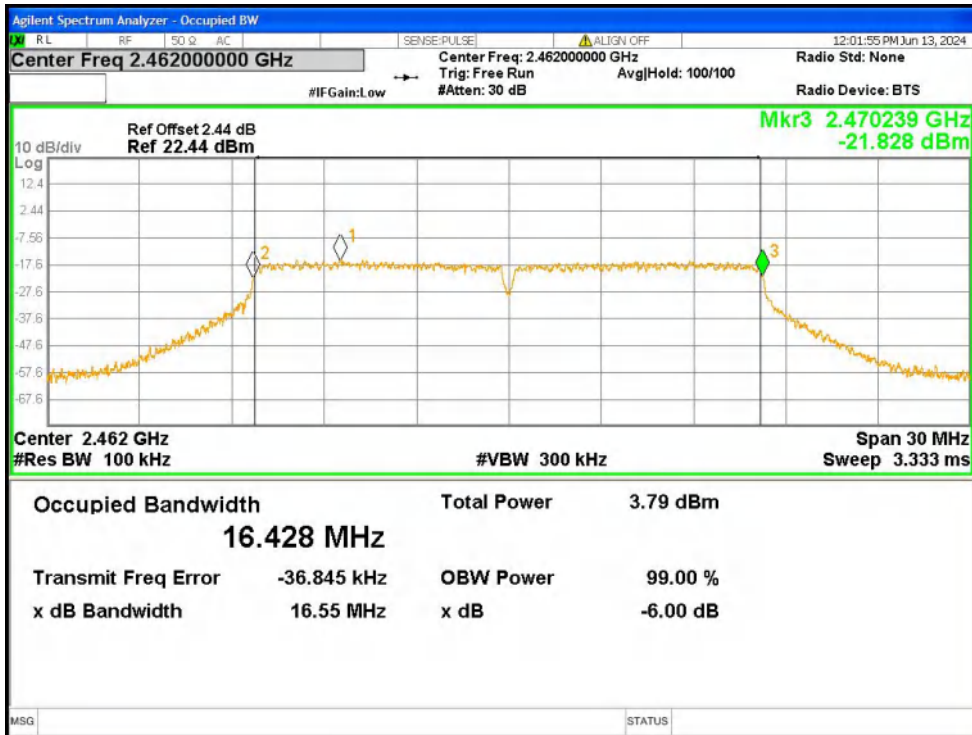

-6dB Bandwidth NVNT g 2462MHz Ant1

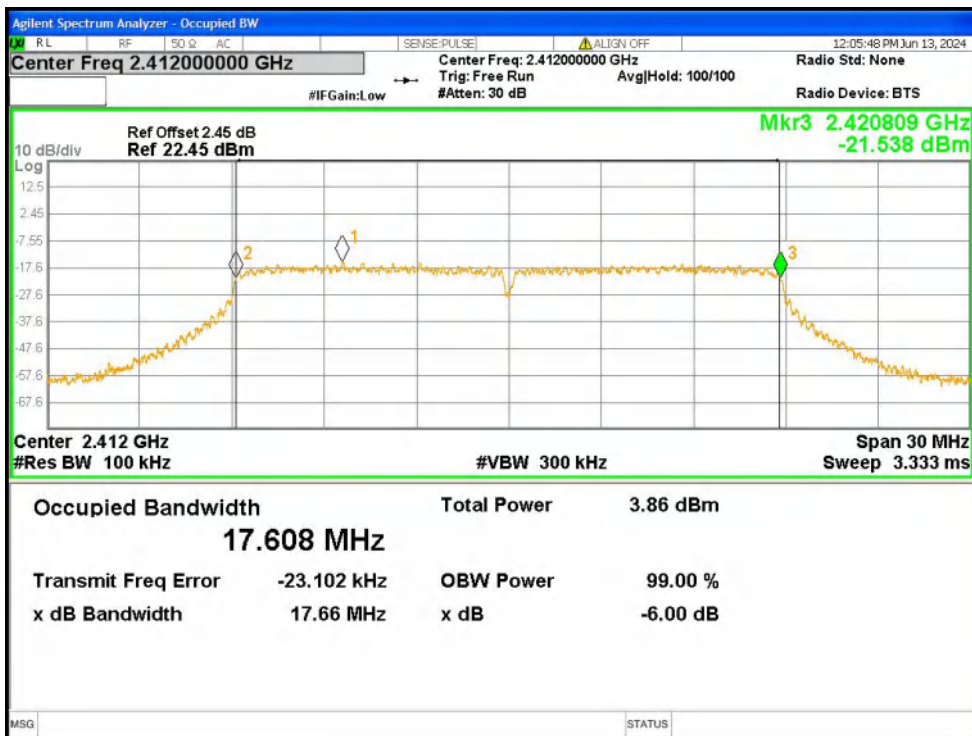

-6dB Bandwidth NVNT n20 2412MHz Ant1

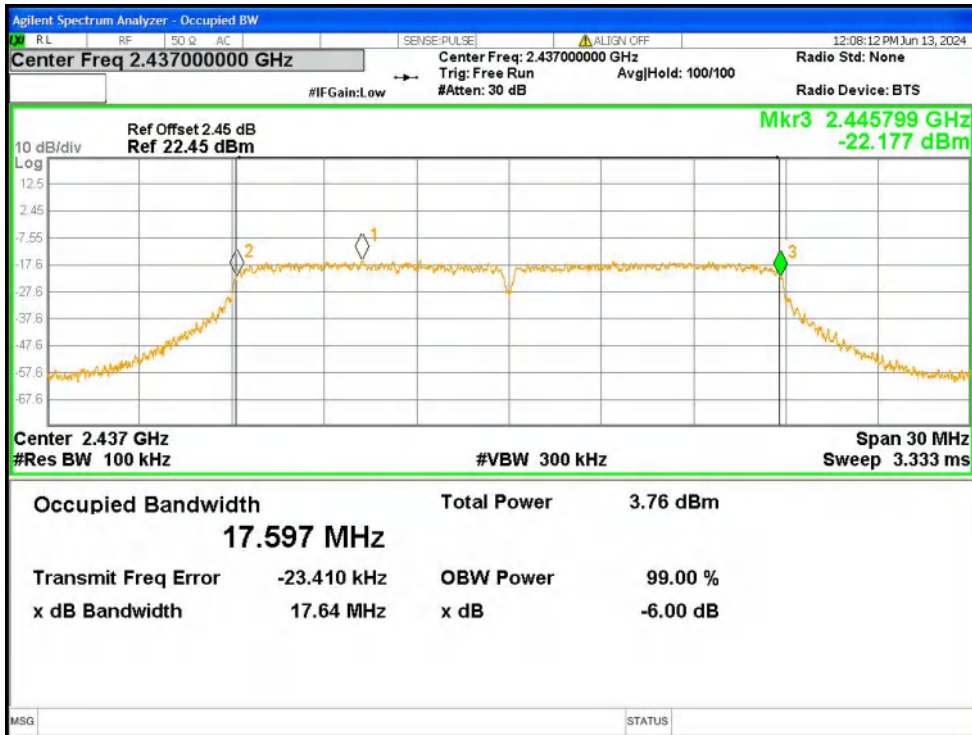

-6dB Bandwidth NVNT n20 2437MHz Ant1

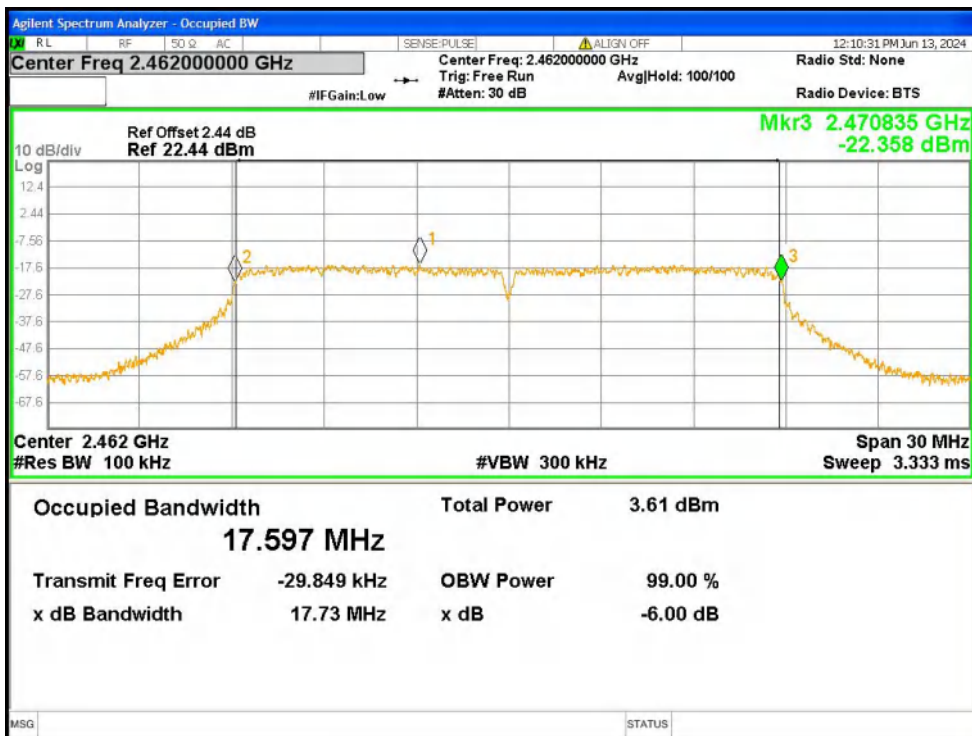

-6dB Bandwidth NVNT n20 2462MHz Ant1

8. PEAK OUTPUT POWER TEST

Test Requirement:	FCC Part15 C Section 15.247 (b)(3)
Test Method:	KDB558074 D0115.247 Meas Guidancev05r02

8.1 APPLIED PROCEDURES/LIMIT

FCC Part15 (15.247) , Subpart C				
Section	Test Item	Limit	Frequency Range (MHz)	Result
15.247(b)(3)	Peak Output Power(SISO)	1 watt or 30dBm	2400-2483.5	PASS

8.2 TEST PROCEDURE

- a. The EUT was directly connected to the Power meter

8.3 DEVIATION FROM STANDARD

No deviation.

8.4 TEST SETUP



8.5 EUT OPERATION CONDITIONS

The EUT tested system was configured as the statements of 2.4 Unless otherwise a special operating condition is specified in the follows during the testing.

8.6 TEST RESULT

Mode	Frequency (MHz)	Conducted Power (dBm)	Limit (dBm)	Verdict
b	2412	1.91	30	Pass
b	2437	1.7	30	Pass
b	2462	1.42	30	Pass
g	2412	1.17	30	Pass
g	2437	1.13	30	Pass
g	2462	0.98	30	Pass
n20	2412	1.17	30	Pass
n20	2437	1.05	30	Pass
n20	2462	0.88	30	Pass

9. CONDUCTED BAND EDGE AND SPURIOUS EMISSION

Test Requirement:	FCC Part15 C Section 15.247 (d)
Test Method:	KDB558074 D0115.247 Meas Guidancev05r02

9.1 APPLICABLE STANDARD

in any 100 kHz bandwidth outside the frequency bands in which the spread spectrum intentional radiator is operating, the radio frequency power that is produced by the intentional radiator shall be at least 20dB below that in the 100kHz bandwidth within the band that contains the highest level of the desired power, In addition, radiated emissions which fall in the restricted bands, as defined in§15.205(a), must also comply with the radiated emission limits specified in15.209(a).

9.2 TEST PROCEDURE

Using the following spectrum analyzer setting:

- A) Set the RBW = 100KHz.
- B) Set the VBW = 300KHz.
- C) Sweep time = auto couple.
- D) Detector function = peak.
- E) Trace mode = max hold.
- F) Allow trace to fully stabilize.

9.3 DEVIATION FROM STANDARD

No deviation.

9.4 TEST SETUP



9.5 EUT OPERATION CONDITIONS

The EUT tested system was configured as the statements of 2.4 Unless otherwise a special operating condition is specified in the follows during the testing.

9.6 TEST RESULTS

Mode	Frequency (MHz)	Max Value (dBc)	Limit (dBc)	Verdict
b	2412	-32.21	-20	Pass
b	2437	-31.24	-20	Pass
b	2462	-31.99	-20	Pass
g	2412	-25.93	-20	Pass
g	2437	-26.52	-20	Pass
g	2462	-27.46	-20	Pass
n20	2412	-25.68	-20	Pass
n20	2437	-26.83	-20	Pass
n20	2462	-26.29	-20	Pass



Tx. Spurious NVNT b 2412MHz Ant1 Ref

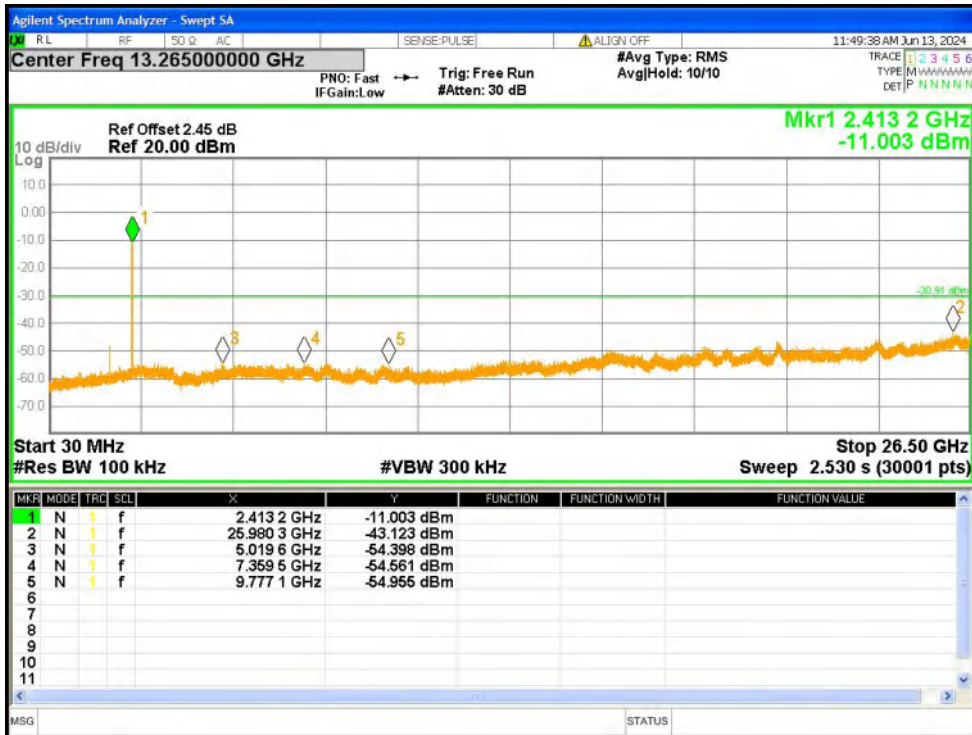

Tx. Spurious NVNT b 2412MHz Ant1 Emission

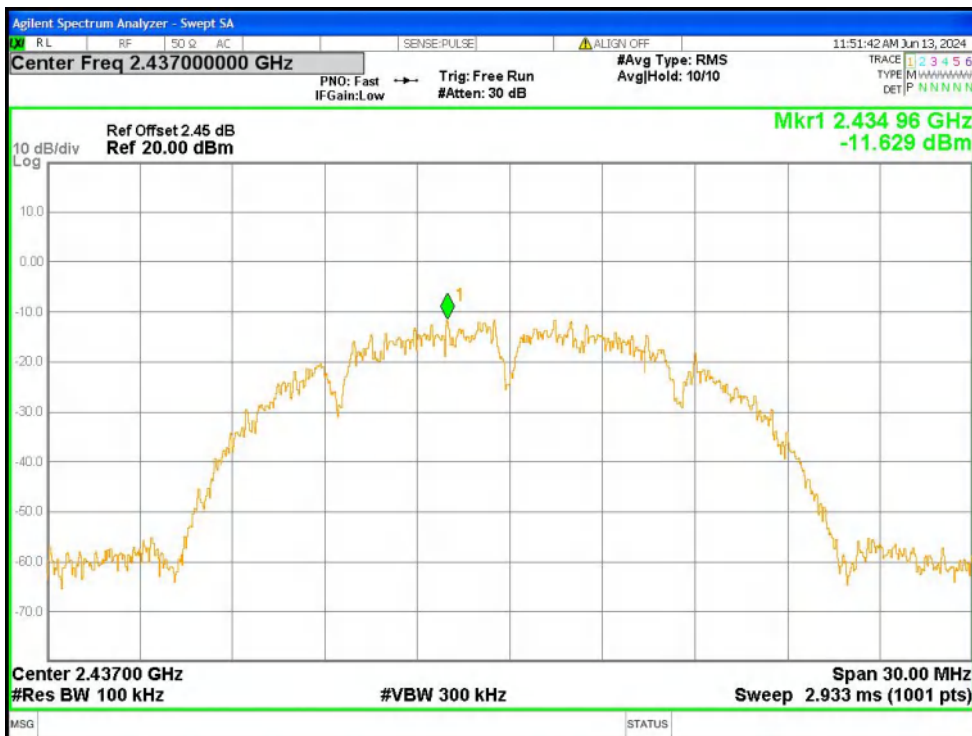

Tx. Spurious NVNT b 2437MHz Ant1 Ref

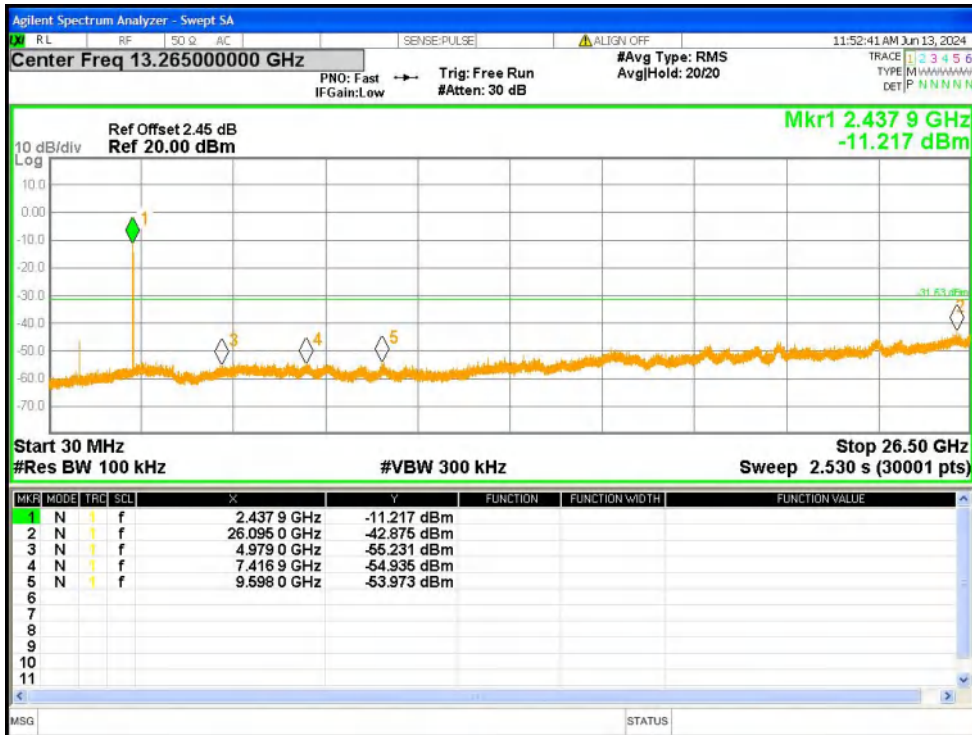

Tx. Spurious NVNT b 2437MHz Ant1 Emission

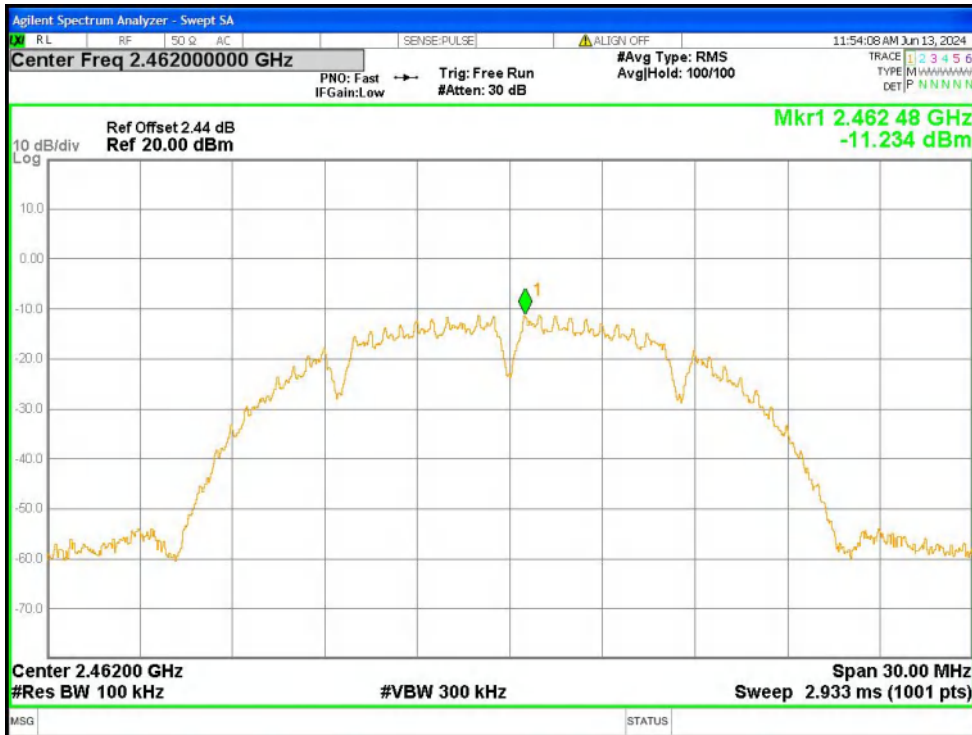

Tx. Spurious NVNT b 2462MHz Ant1 Ref

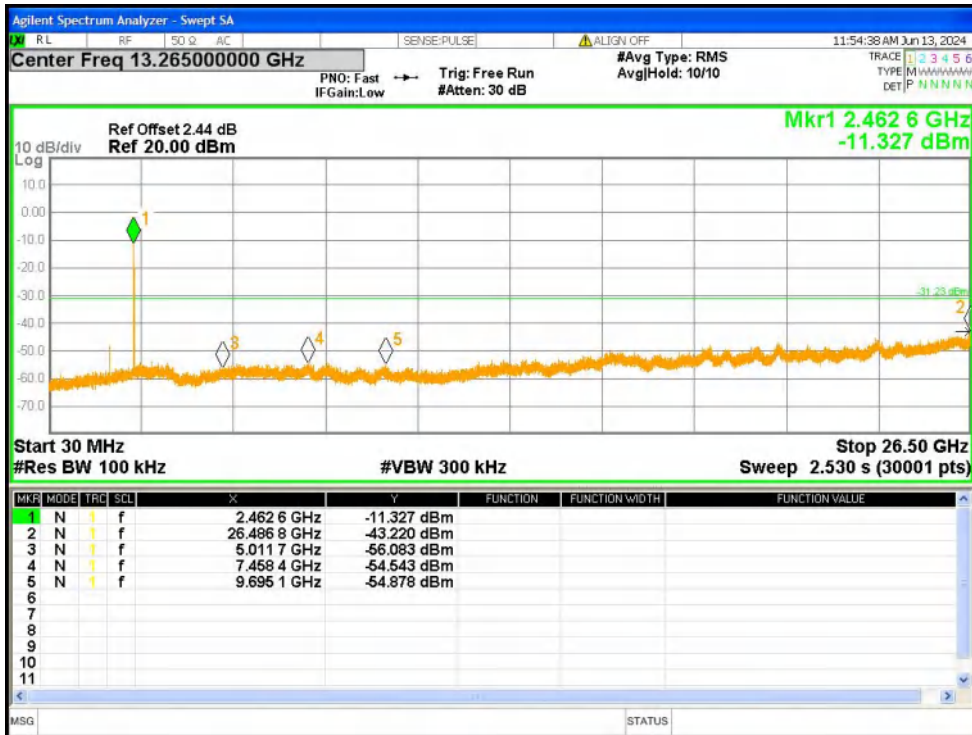

Tx. Spurious NVNT b 2462MHz Ant1 Emission

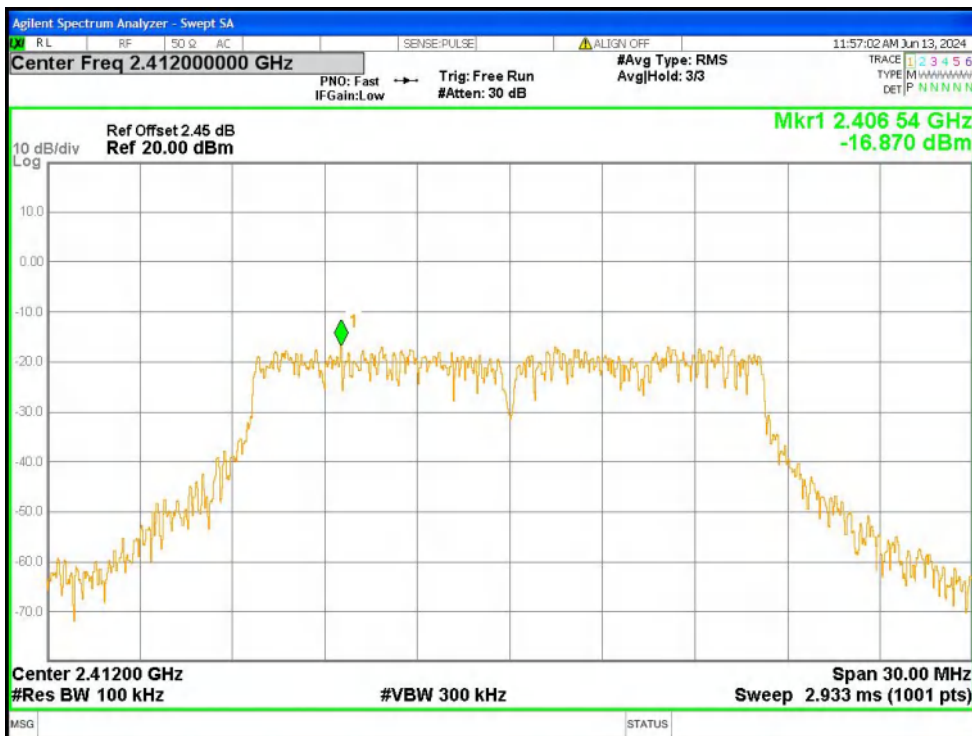

Tx. Spurious NVNT g 2412MHz Ant1 Ref

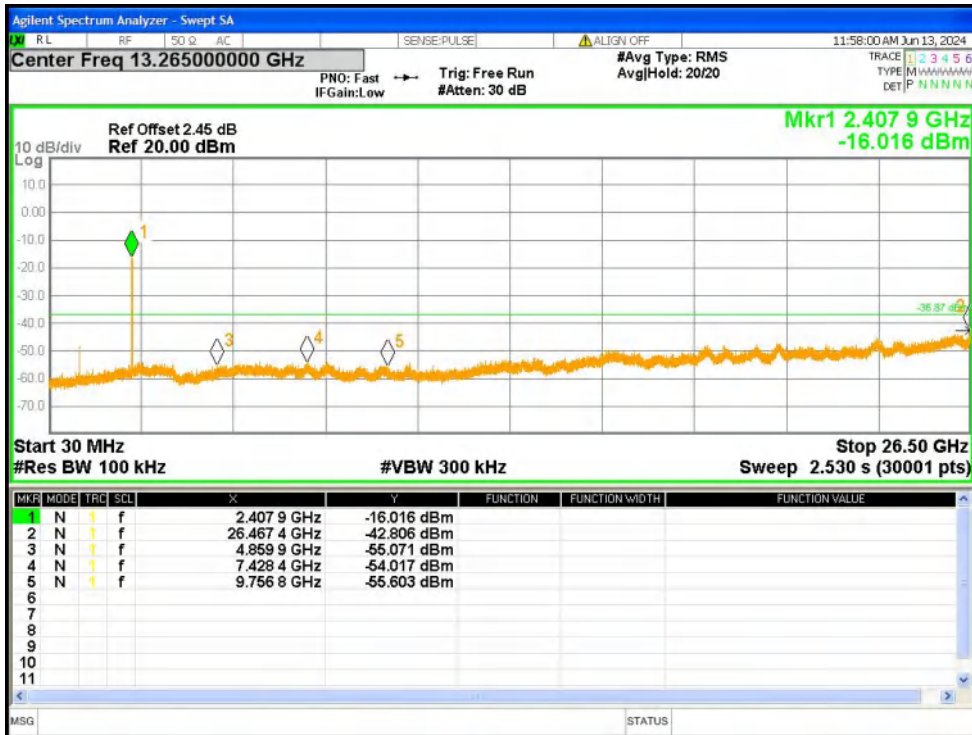

Tx. Spurious NVNT g 2412MHz Ant1 Emission

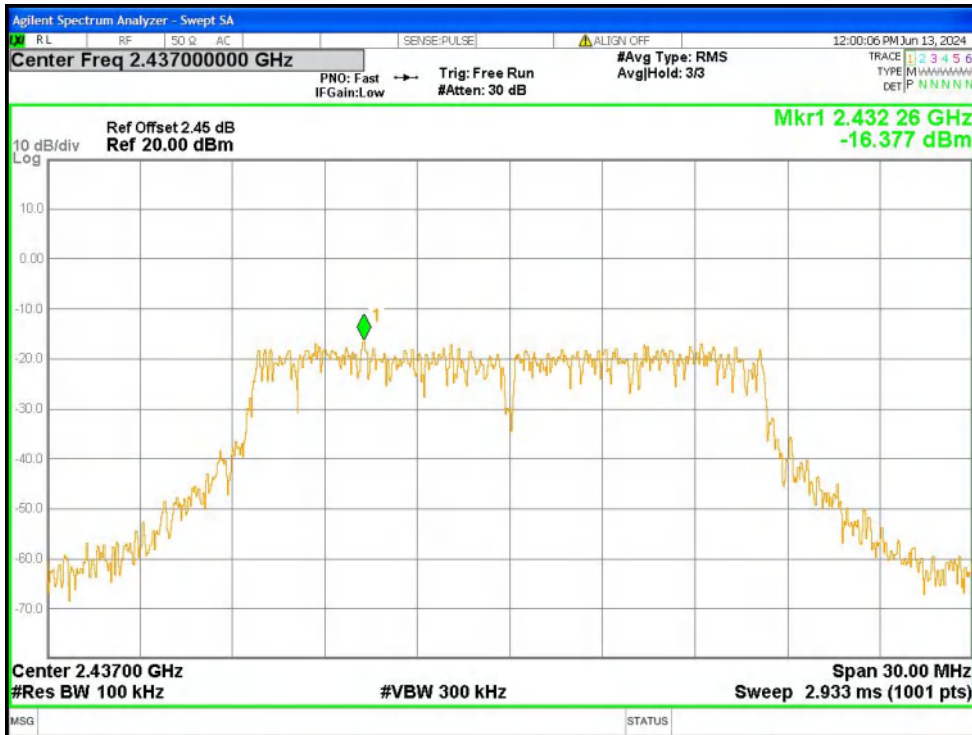

Tx. Spurious NVNT g 2437MHz Ant1 Ref

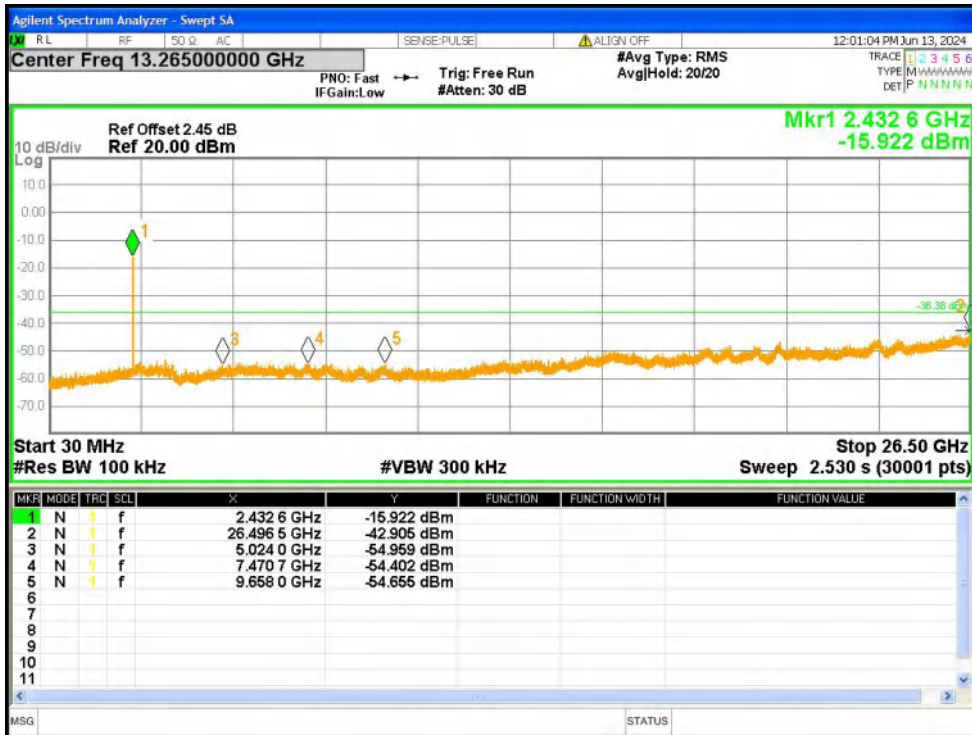

Tx. Spurious NVNT g 2437MHz Ant1 Emission

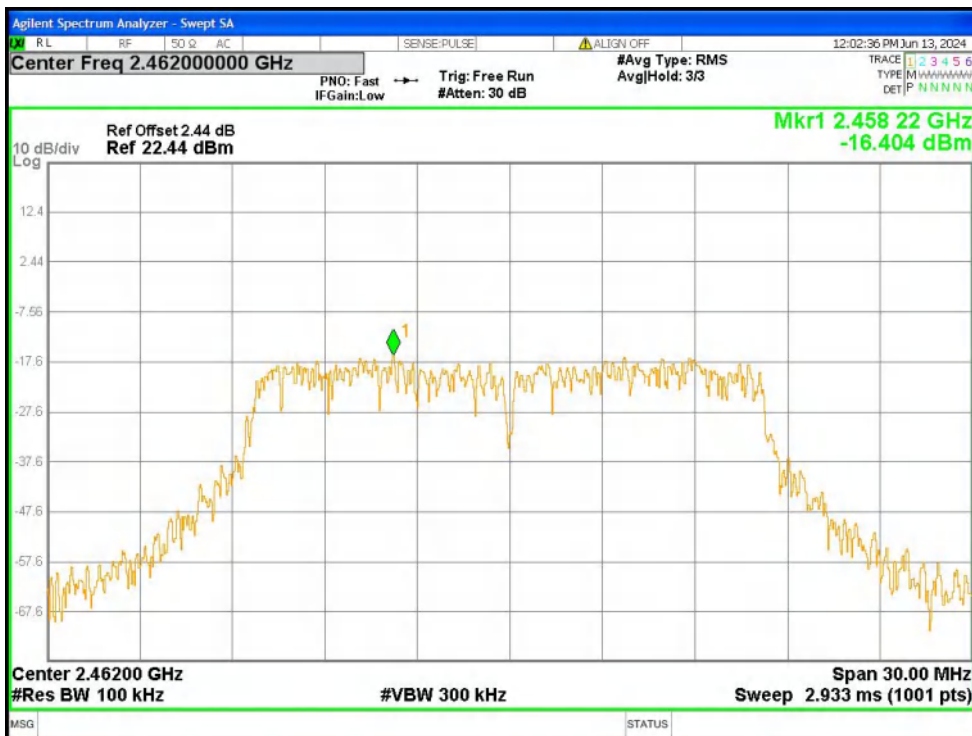

Tx. Spurious NVNT g 2462MHz Ant1 Ref

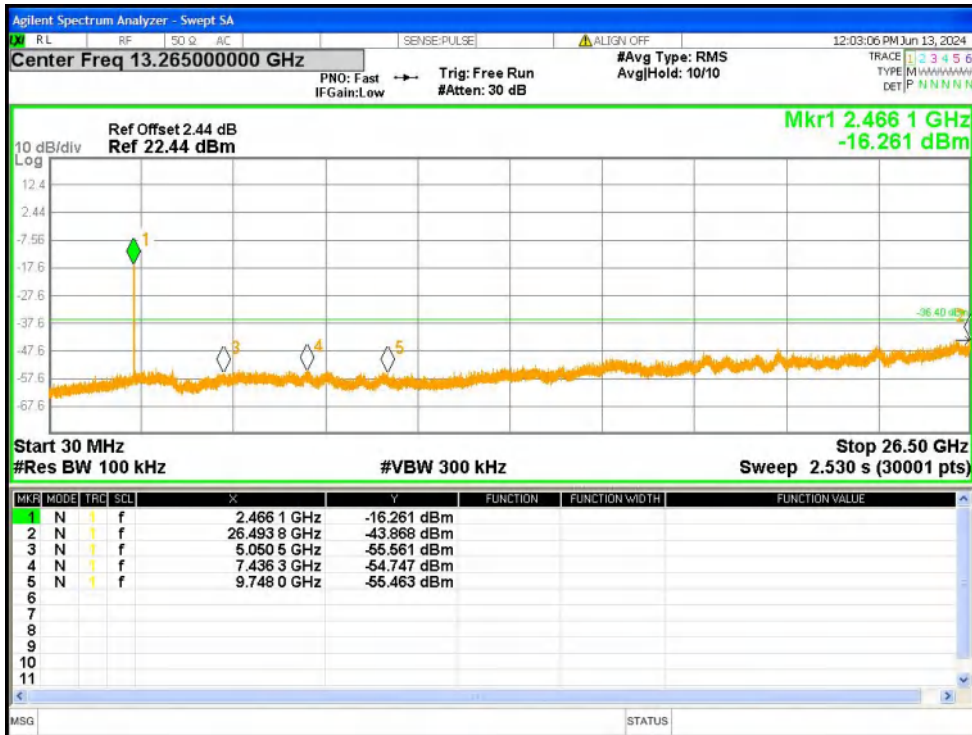

Tx. Spurious NVNT g 2462MHz Ant1 Emission

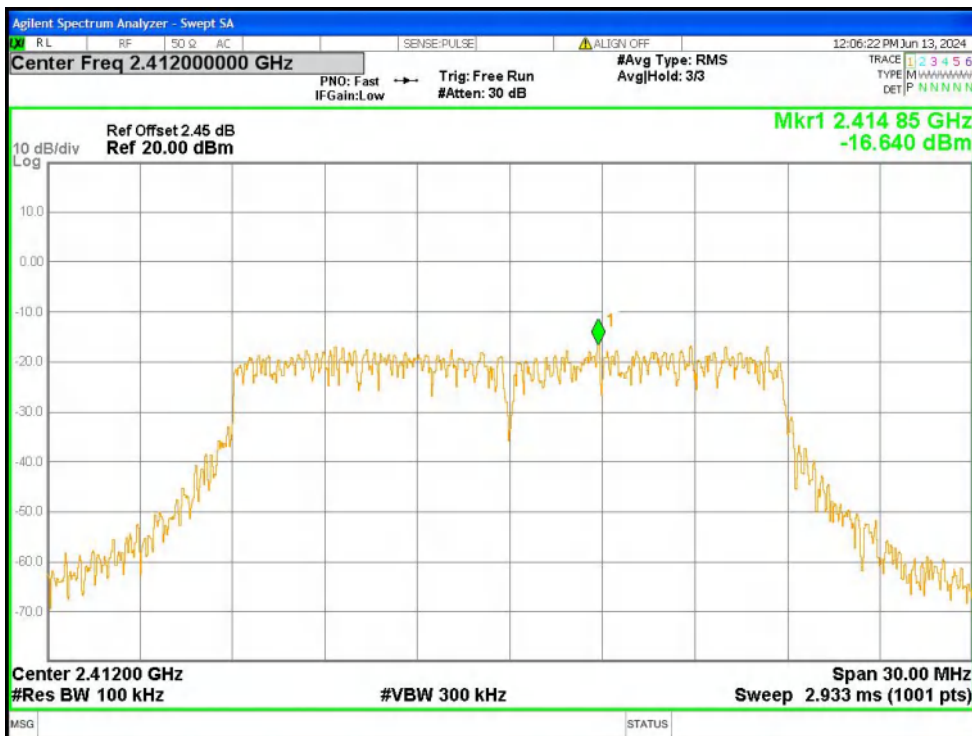

Tx. Spurious NVNT n20 2412MHz Ant1 Ref

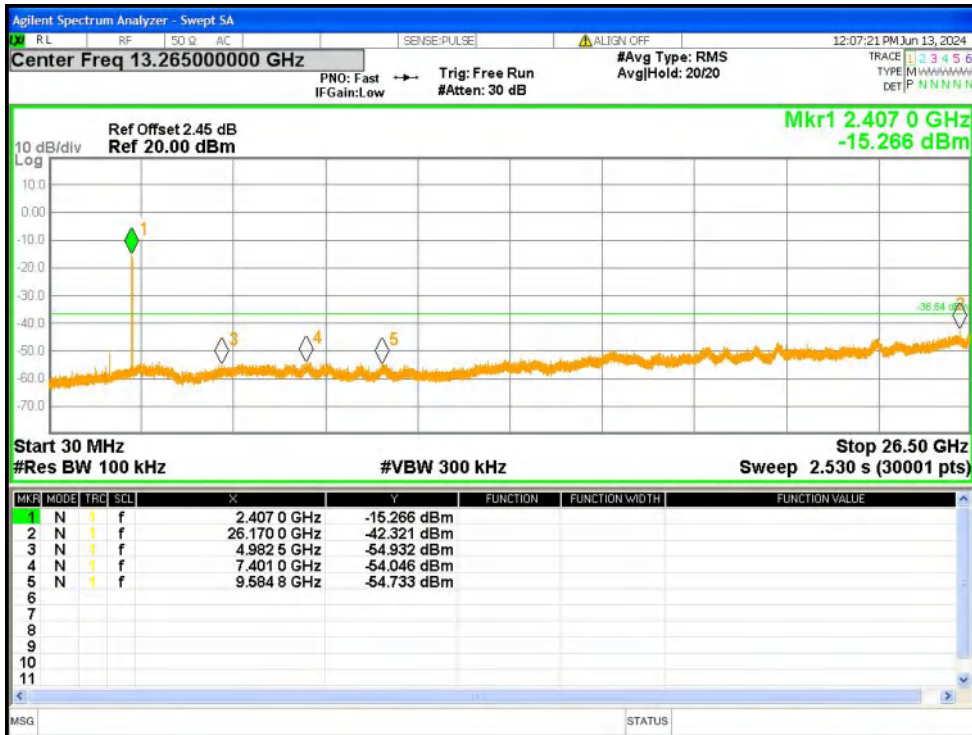

Tx. Spurious NVNT n20 2412MHz Ant1 Emission

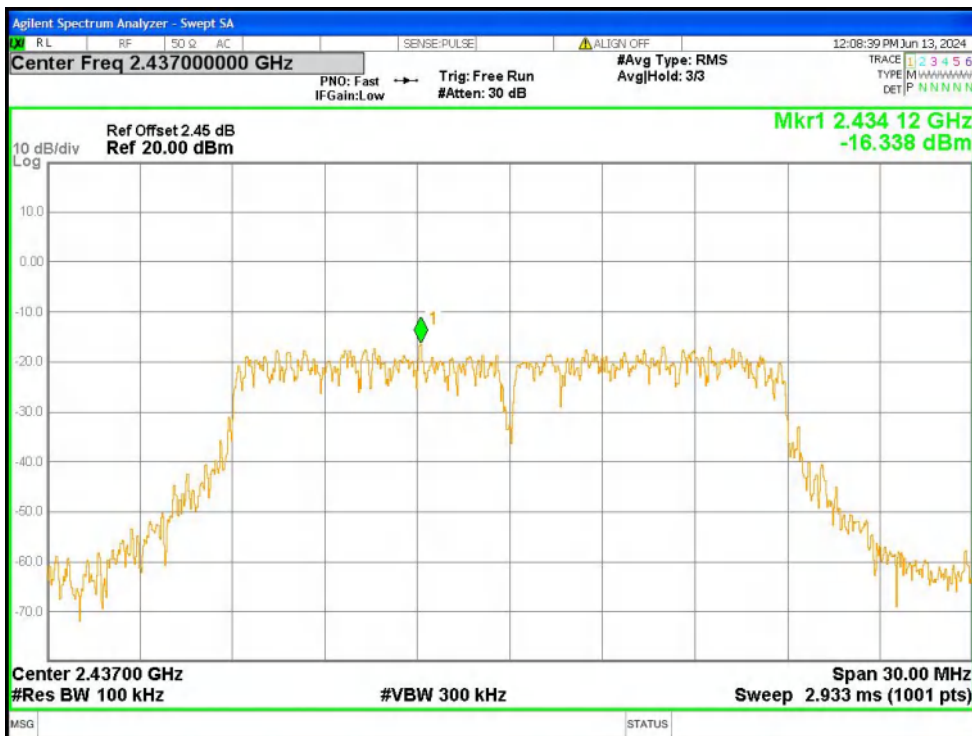

Tx. Spurious NVNT n20 2437MHz Ant1 Ref

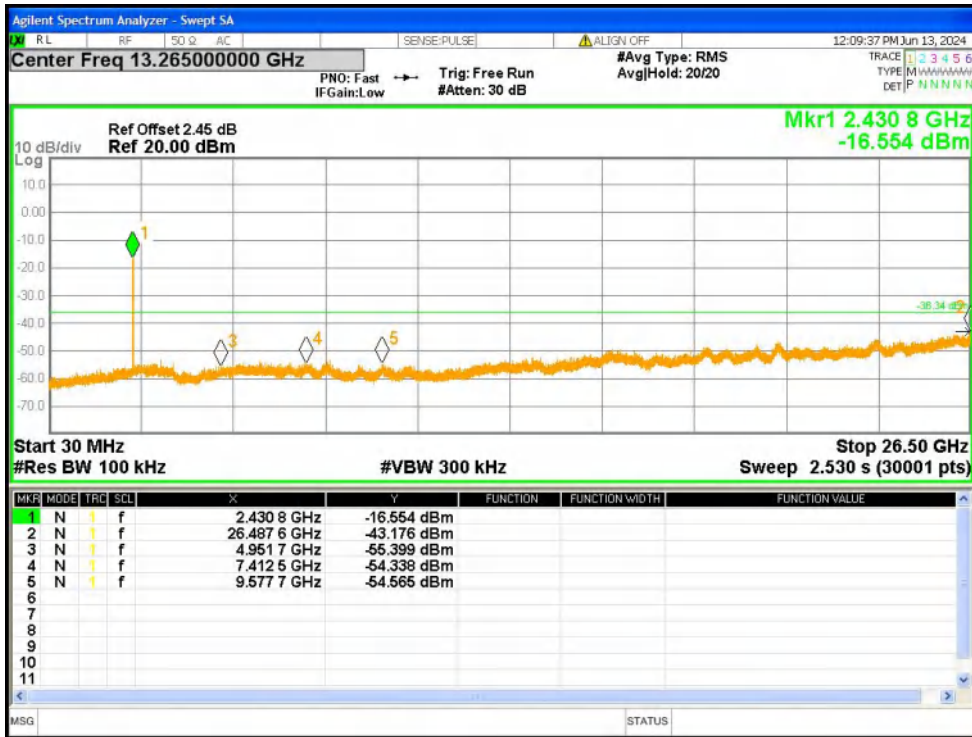

Tx. Spurious NVNT n20 2437MHz Ant1 Emission

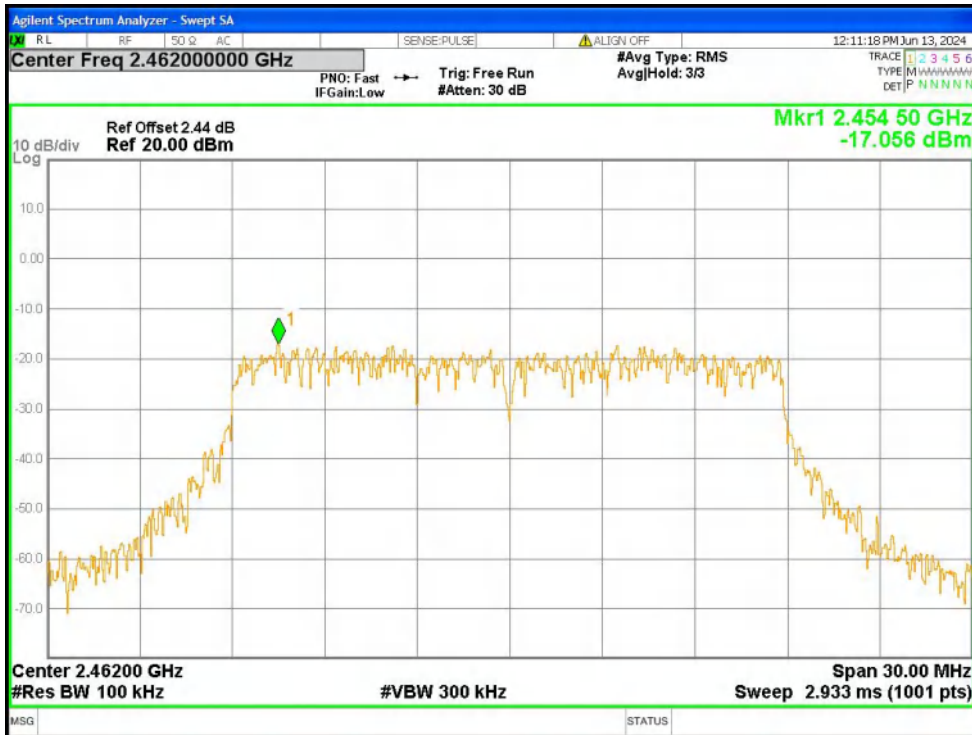

Tx. Spurious NVNT n20 2462MHz Ant1 Ref

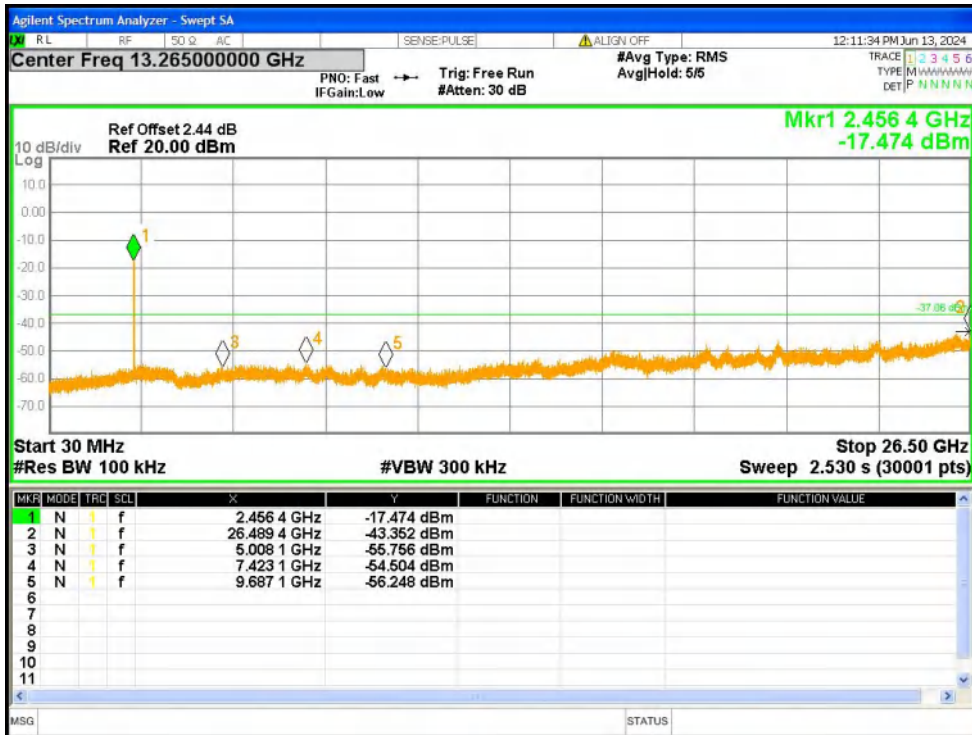

Tx. Spurious NVNT n20 2462MHz Ant1 Emission

Mode	Frequency (MHz)	Antenna	Max Value (dBc)	Limit (dBc)	Verdict
b	2412	Ant1	-42.67	-20	Pass
b	2462	Ant1	-45.17	-20	Pass
g	2412	Ant1	-34.51	-20	Pass
g	2462	Ant1	-40.49	-20	Pass
n20	2412	Ant1	-34.7	-20	Pass
n20	2462	Ant1	-40.68	-20	Pass

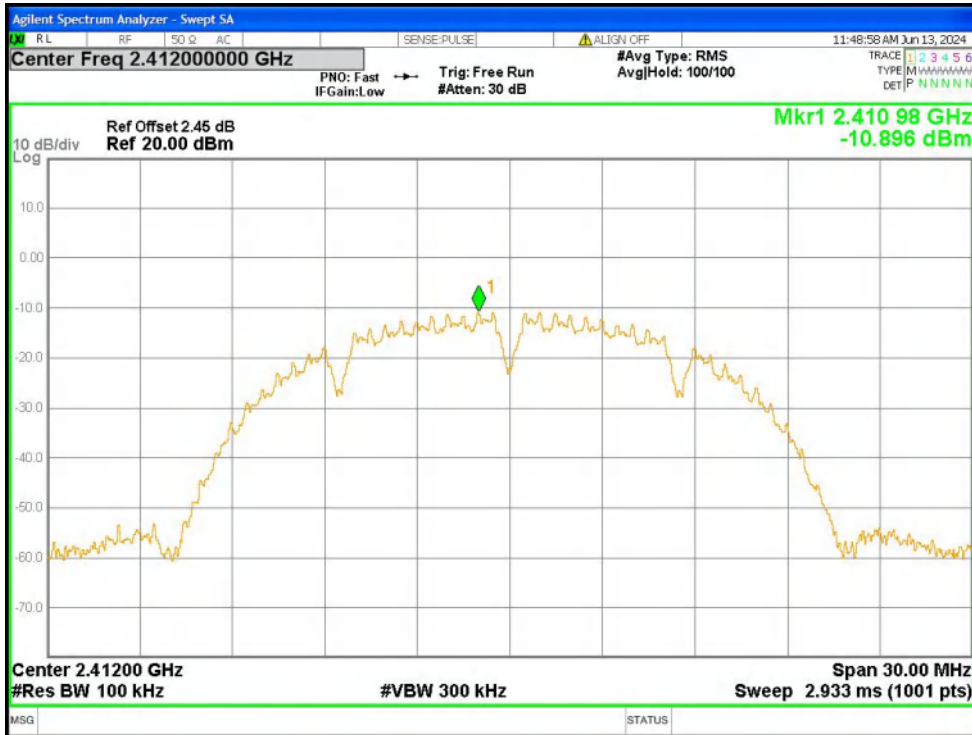

Band Edge NVNT b 2412MHz Ant1 Ref

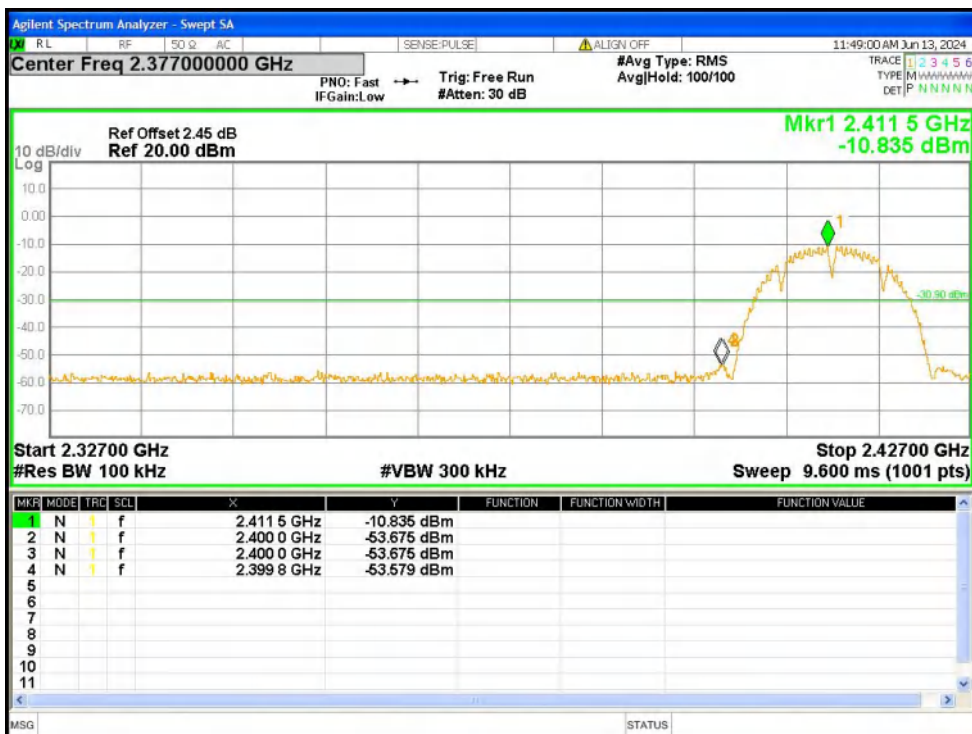

Band Edge NVNT b 2412MHz Ant1 Emission

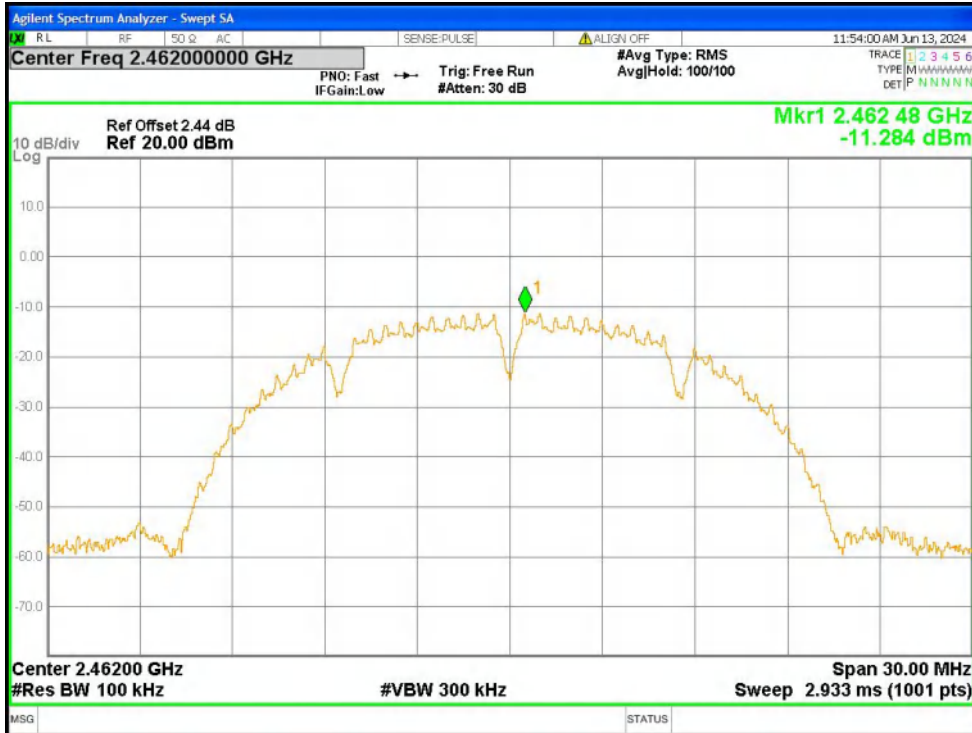

Band Edge NVNT b 2462MHz Ant1 Ref

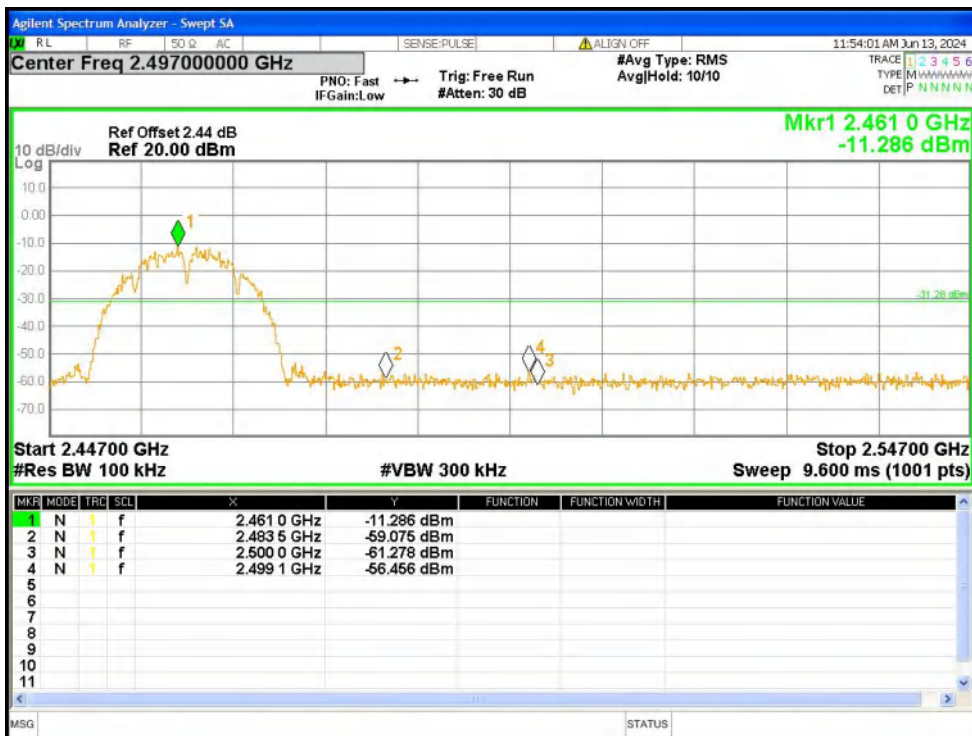

Band Edge NVNT b 2462MHz Ant1 Emission

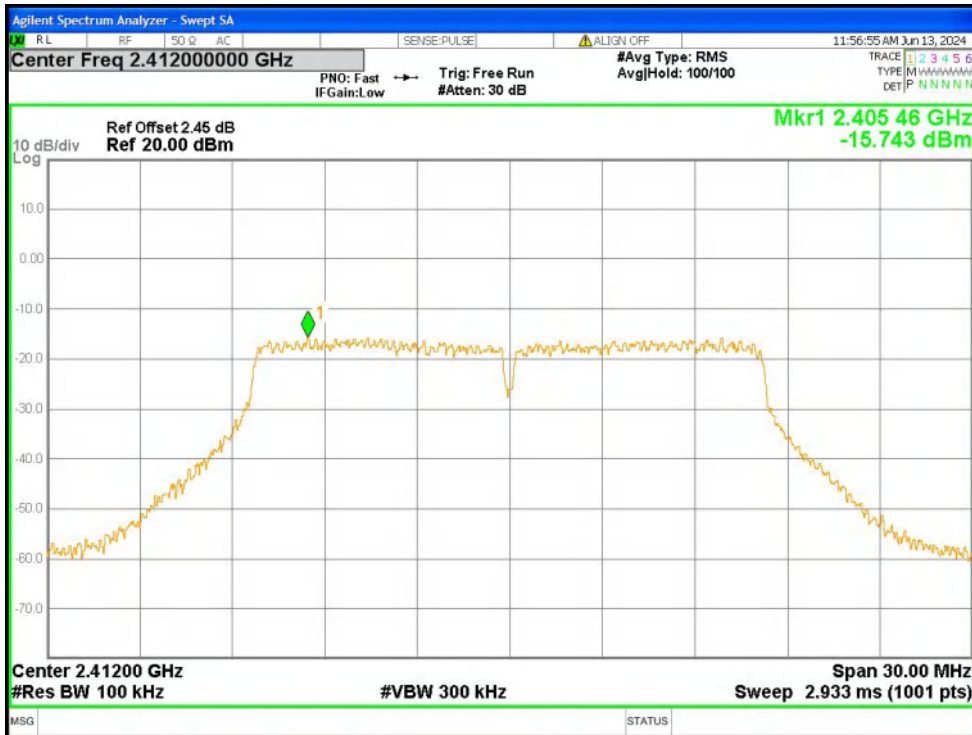

Band Edge NVNT g 2412MHz Ant1 Ref

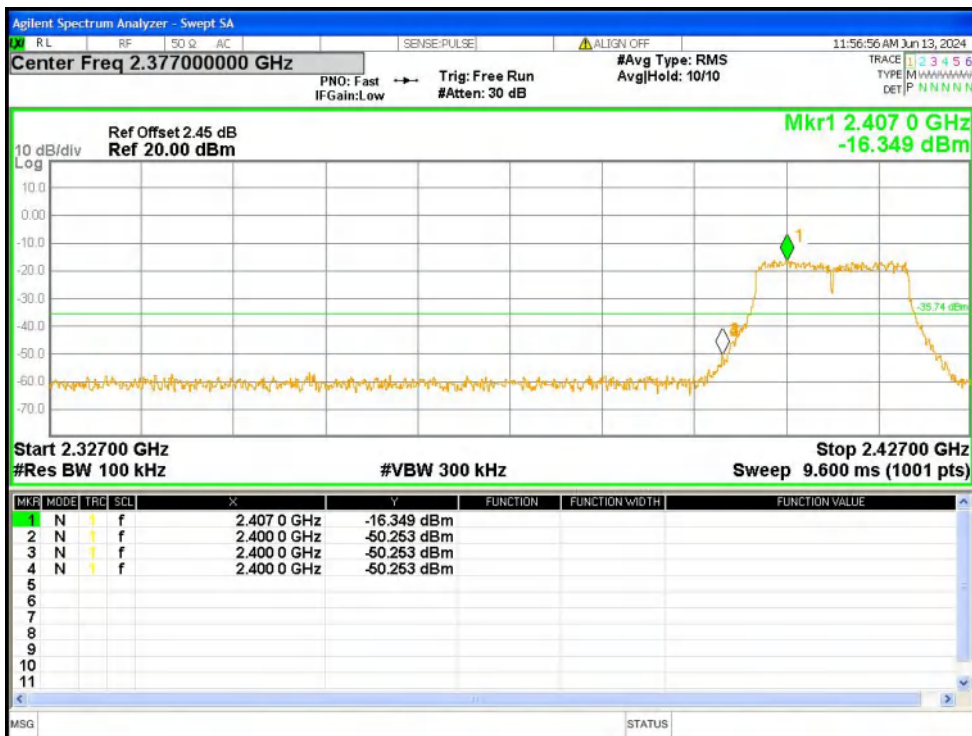

Band Edge NVNT g 2412MHz Ant1 Emission

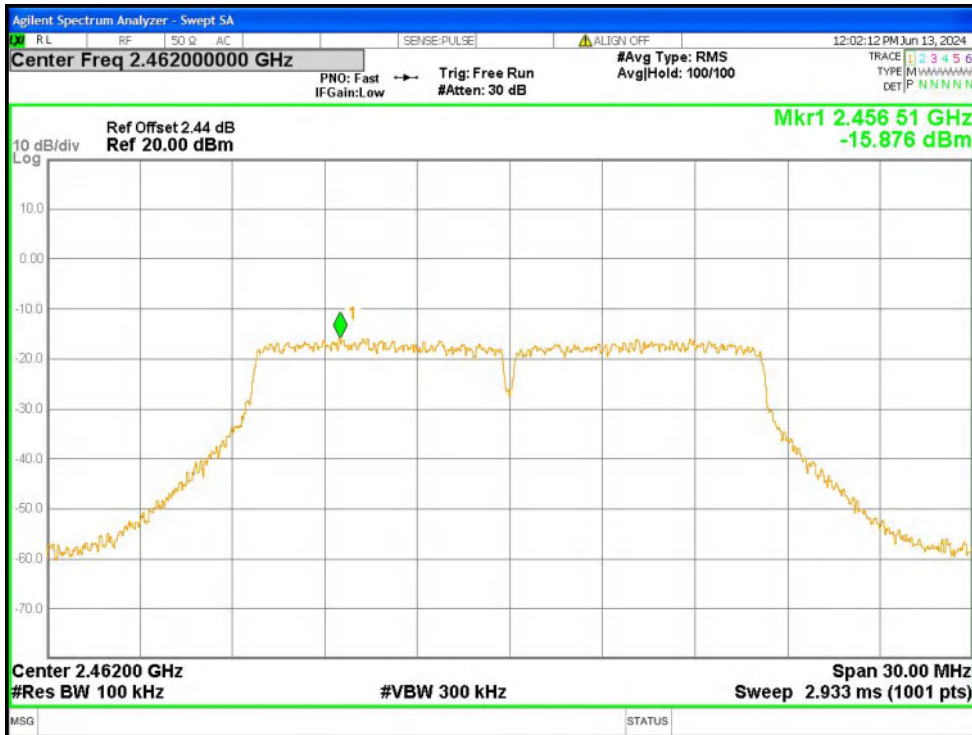

Band Edge NVNT g 2462MHz Ant1 Ref

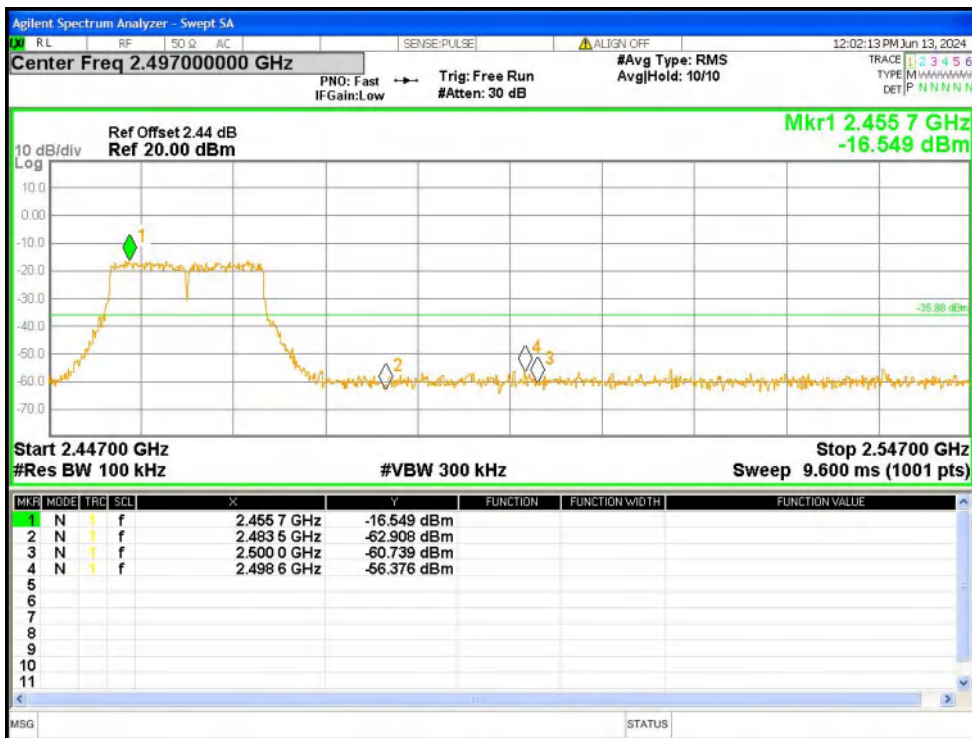

Band Edge NVNT g 2462MHz Ant1 Emission

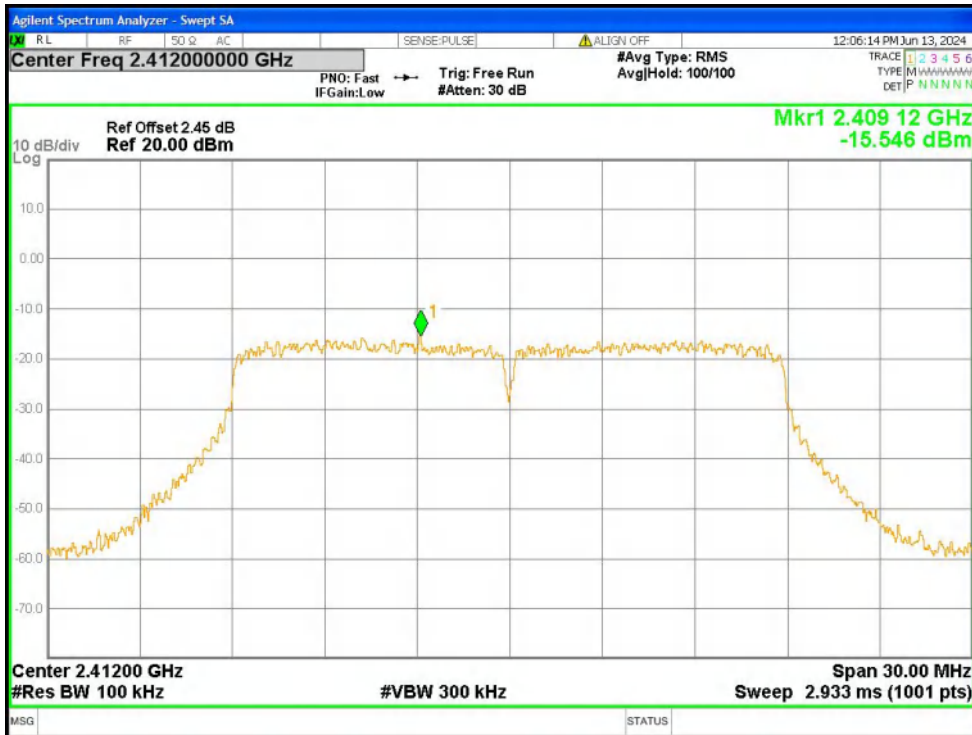

Band Edge NVNT n20 2412MHz Ant1 Ref

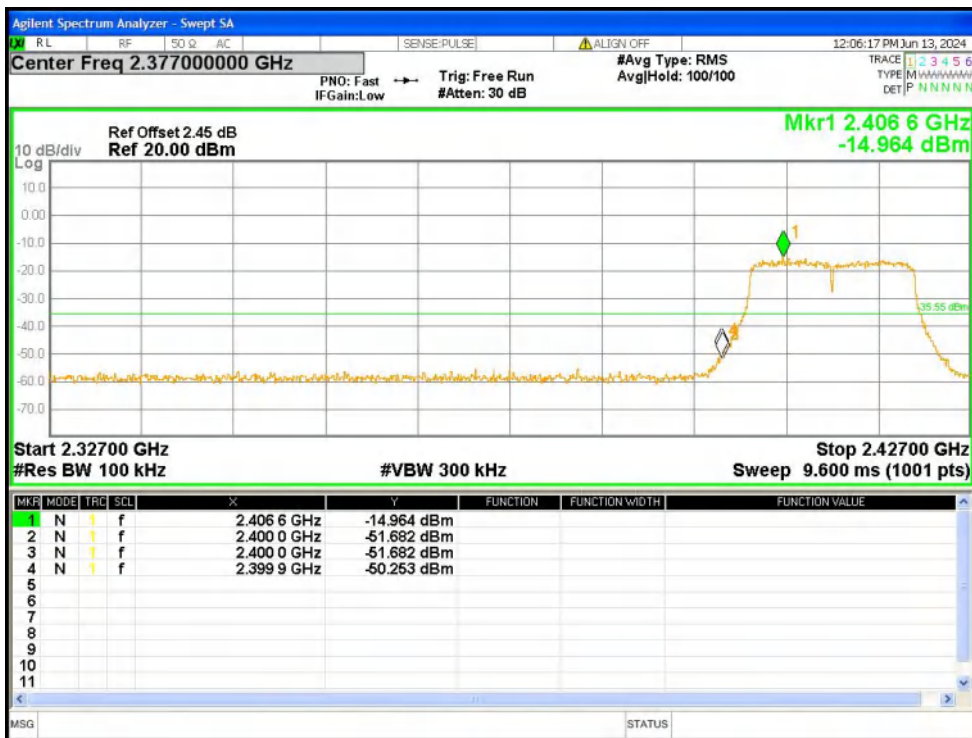

Band Edge NVNT n20 2412MHz Ant1 Emission

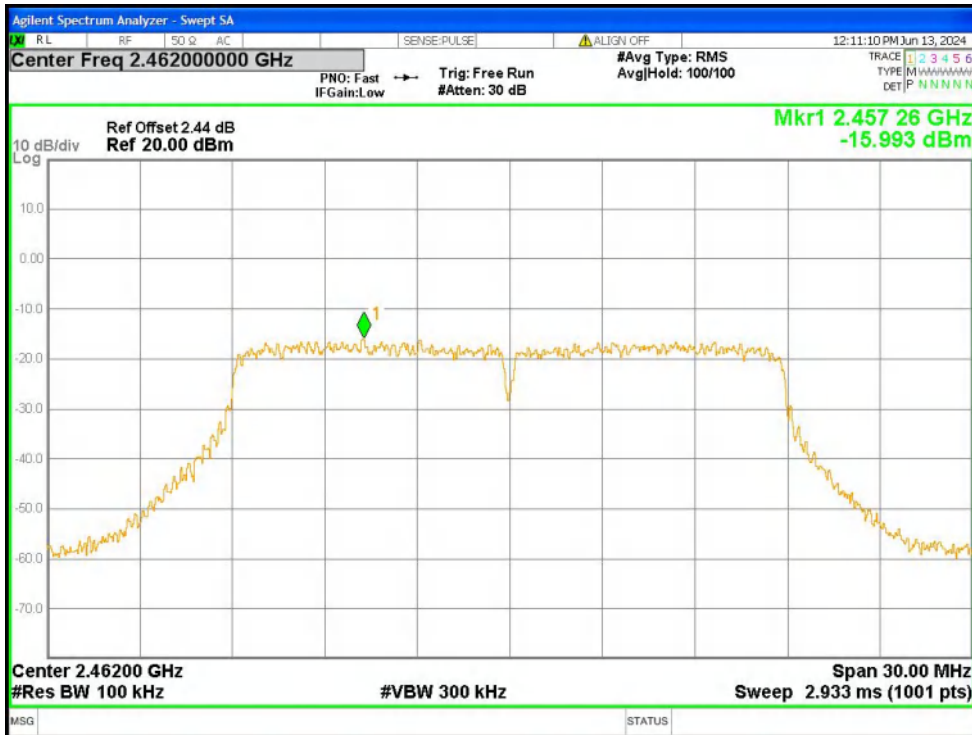

Band Edge NVNT n20 2462MHz Ant1 Ref

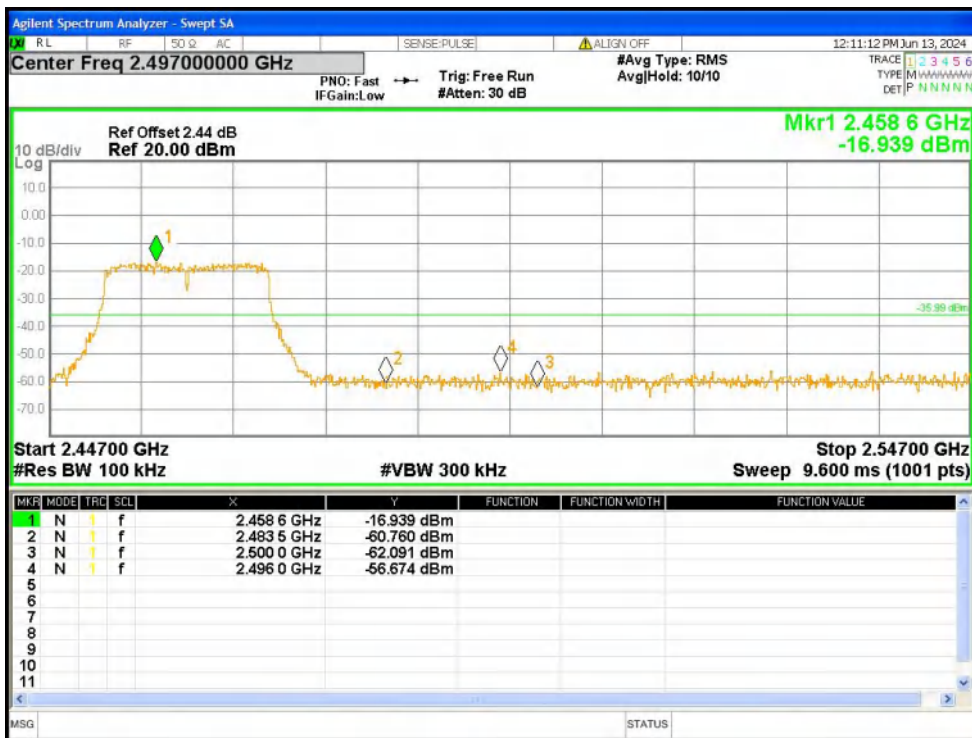

Band Edge NVNT n20 2462MHz Ant1 Emission

10. ANTENNA REQUIREMENT

Standard requirement:	FCC Part15 C Section 15.203 /247(c)
<p>15.203 requirement: An intentional radiator shall be designed to ensure that no antenna other than that furnished by the responsible party shall be used with the device. The use of a permanently attached antenna or of an antenna that uses a unique coupling to the intentional radiator, the manufacturer may design the unit so that a broken antenna can be replaced by the user, but the use of a standard antenna jack or electrical connector is prohibited.</p> <p>15.247(c) (1)(i) requirement: (i) Systems operating in the 2400-2483.5 MHz band that is used exclusively for fixed. Point-to-point operations may employ transmitting antennas with directional gain greater than 6dBi provided the maximum conducted output power of the intentional radiator is reduced by 1 dB for every 3 dB that the directional gain of the antenna exceeds 6dBi.</p>	
EUT Antenna:	
The WIFI 2.4G antenna is FPC antenna, the best case gain for the antenna is 1.31dBi, reference to the appendix II for details	

11. TEST SETUP PHOTO

Reference to the appendix I for details.

12. EUT CONSTRUCTIONAL DETAILS

Reference to the appendix II for details.

******* END OF REPORT *******