

Appendix A

RF Test Data for BT V5.0 (BDR/EDR) (Conducted Measurement)

Product Name: Bluetooth earphone

Trade Mark: IVANTE

Test Model: S2

Environmental Conditions

Temperature:	23.4 ° C
Relative Humidity:	65%
ATM Pressure:	100.0 kPa
Test Engineer:	AKING JIN
Supervised by:	JAYDEN ZHUO

A.1 Maximum Conducted Peak Output Power

Mode	Channel.	Maximum Peak Output Power [dBm]	Limit [dBm]	Verdict
GFSK	LCH	-0.631	21	PASS
	MCH	-0.058	21	PASS
	HCH	-0.208	21	PASS
$\pi/4$ DQPSK	LCH	1.927	21	PASS
	MCH	2.435	21	PASS
	HCH	1.997	21	PASS
8DPSK	LCH	2.324	21	PASS
	MCH	2.864	21	PASS
	HCH	2.291	21	PASS

Test Graphs

GFSK/LCH

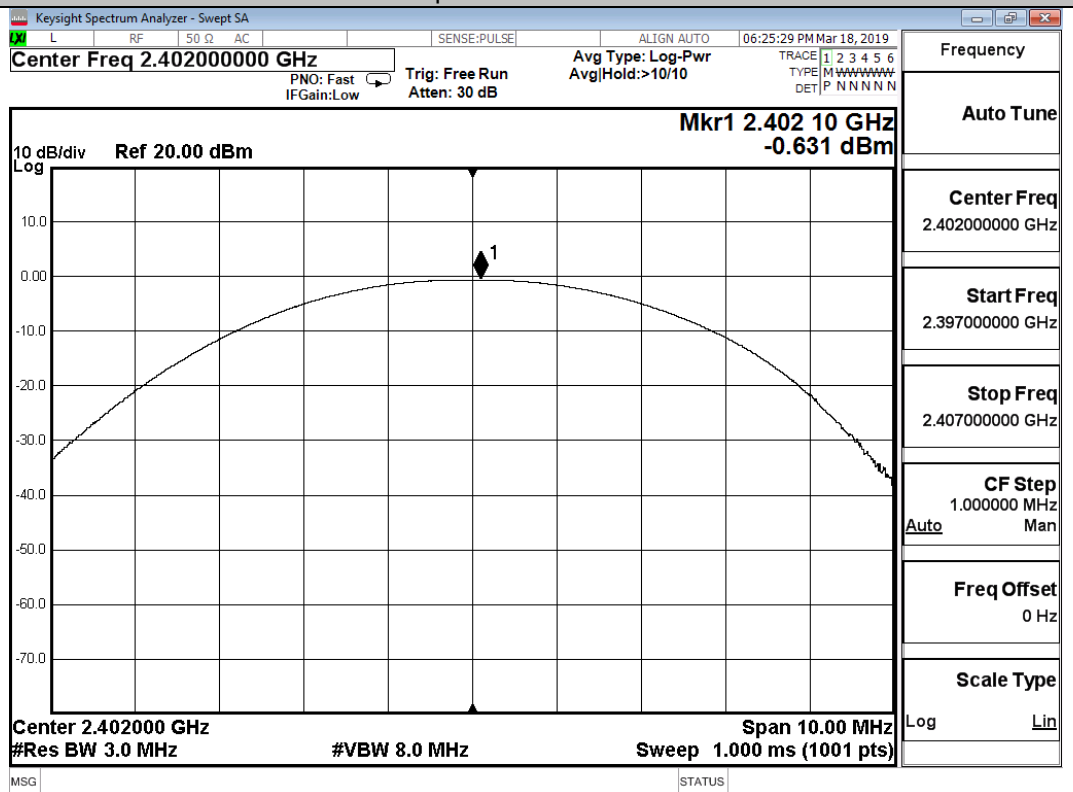

GFSK/MCH

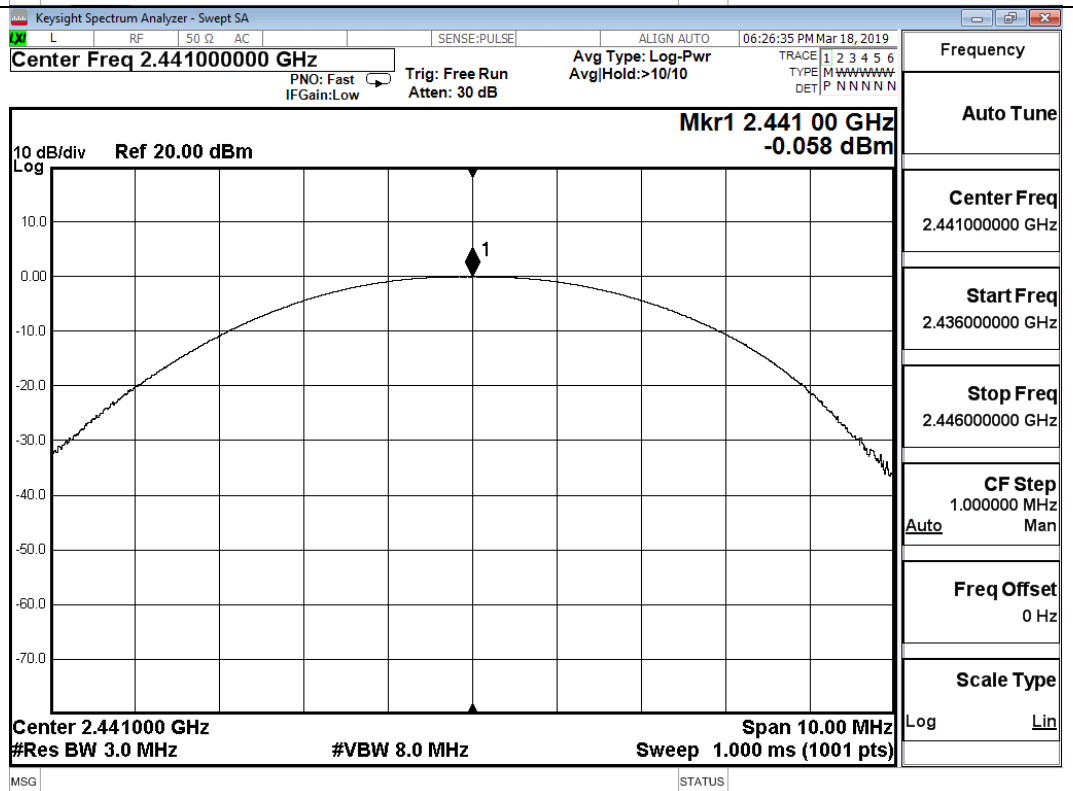

GFSK/HCH

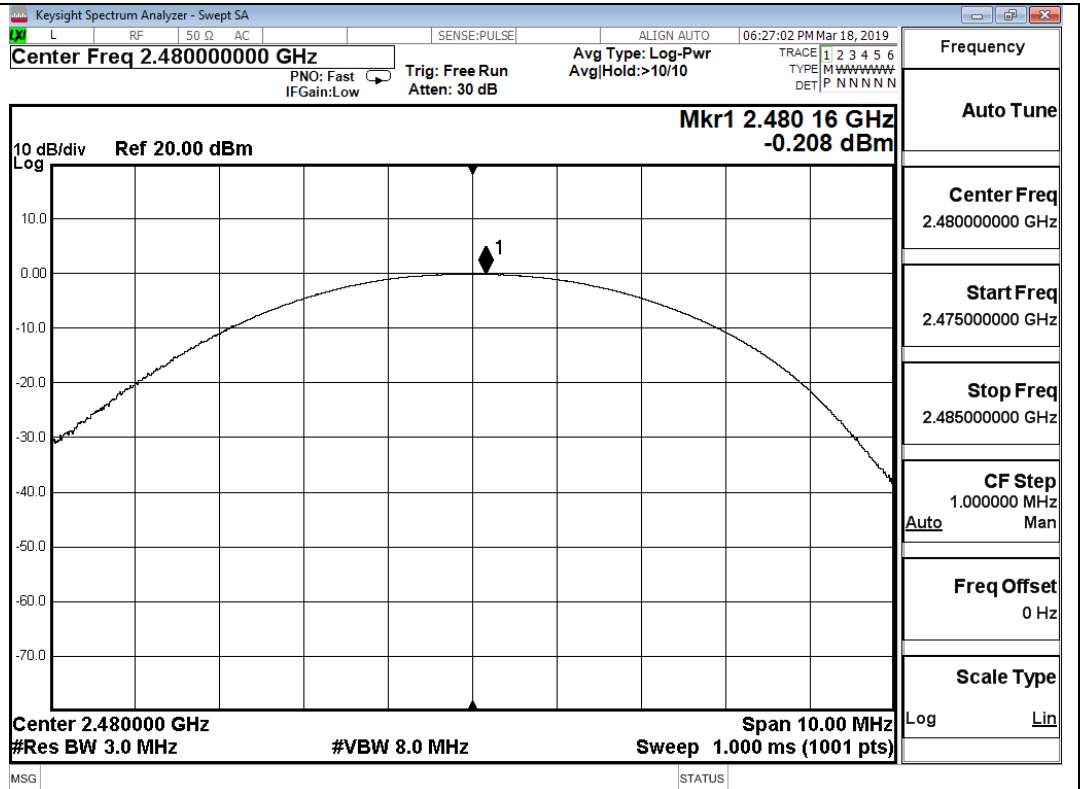

$\pi/4$ DQPSK/LCH

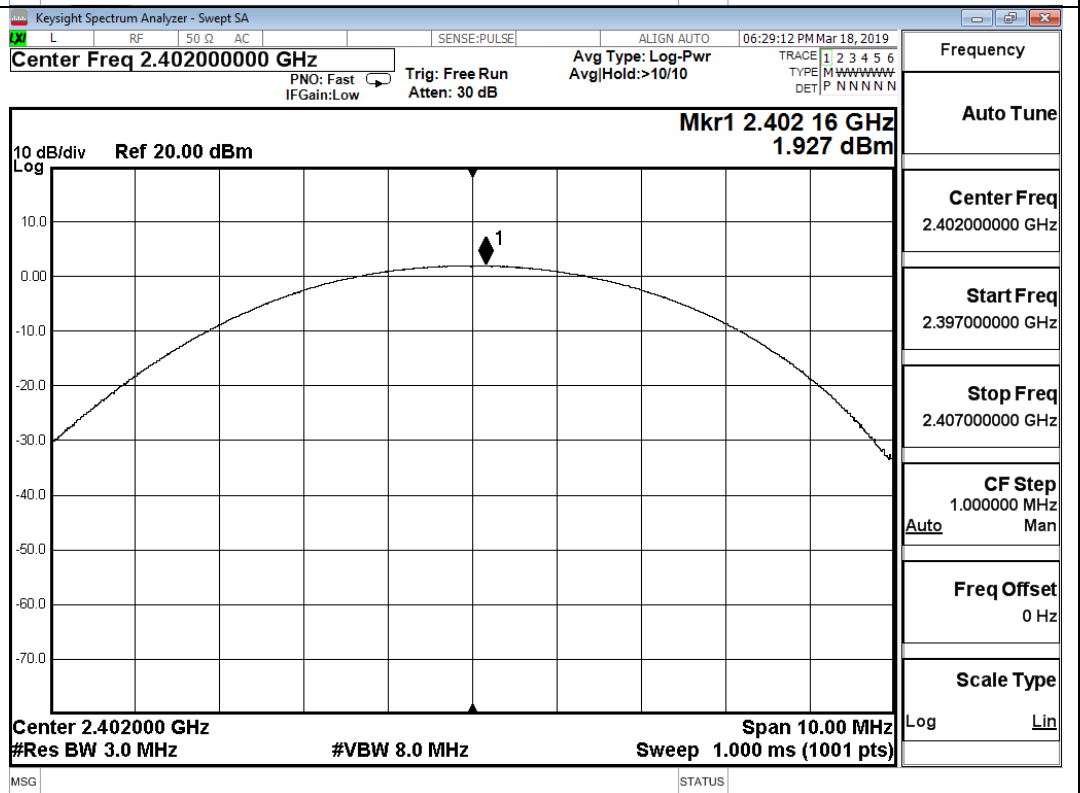

$\pi/4$ DQPSK/MCH

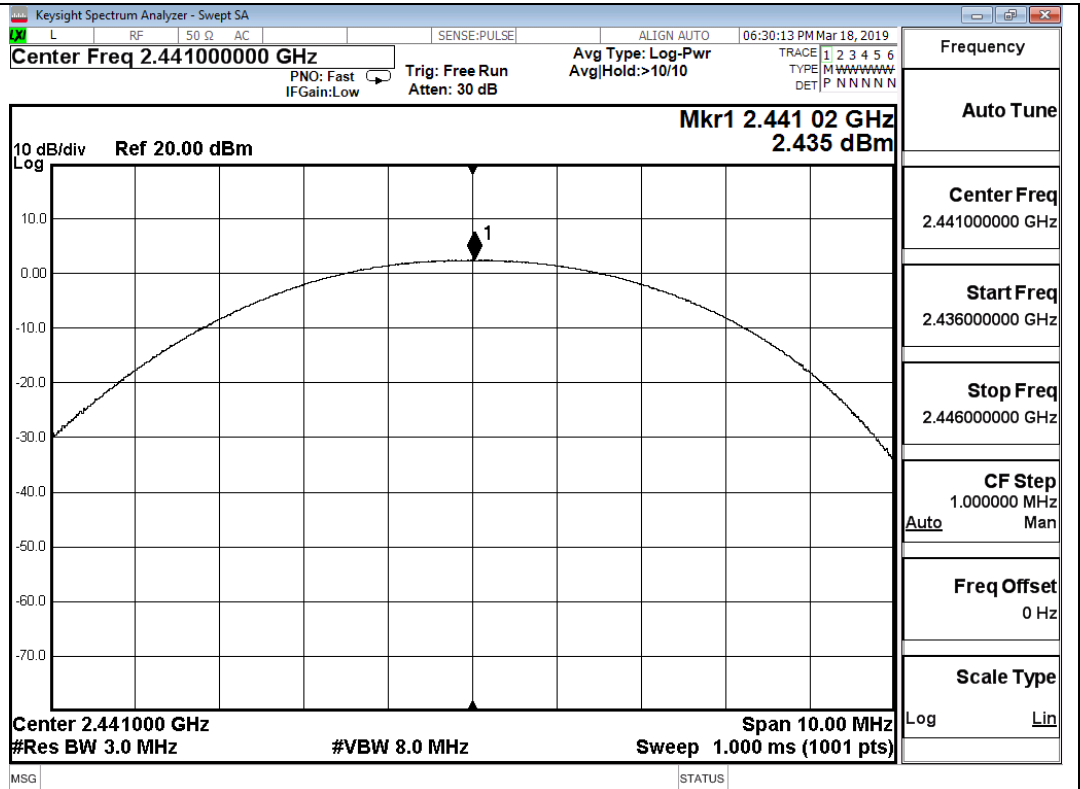

$\pi/4$ DQPSK/HCH

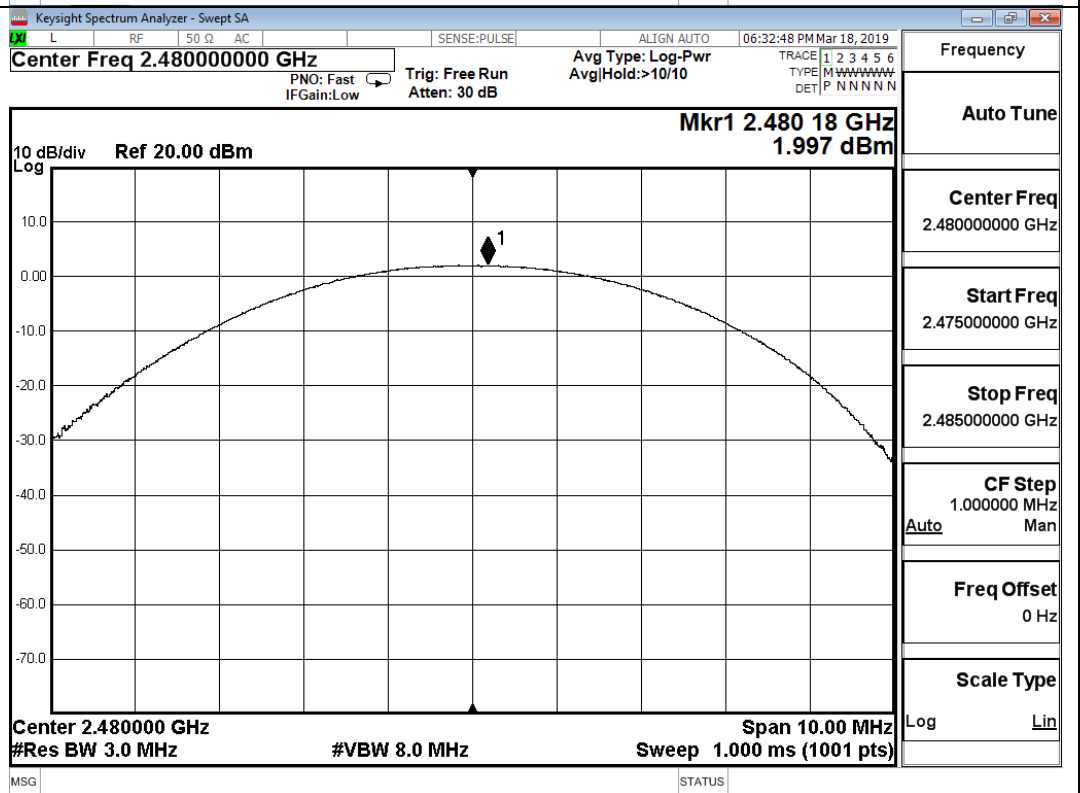

8DPSK/LCH

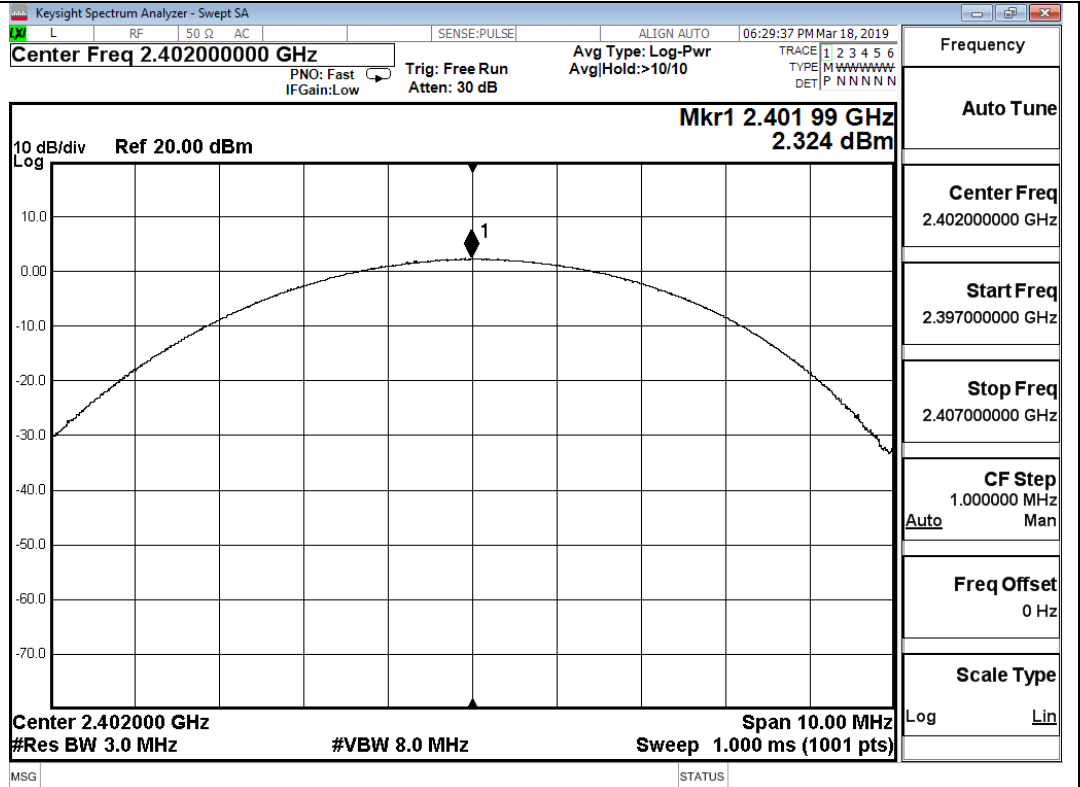

8DPSK/MCH

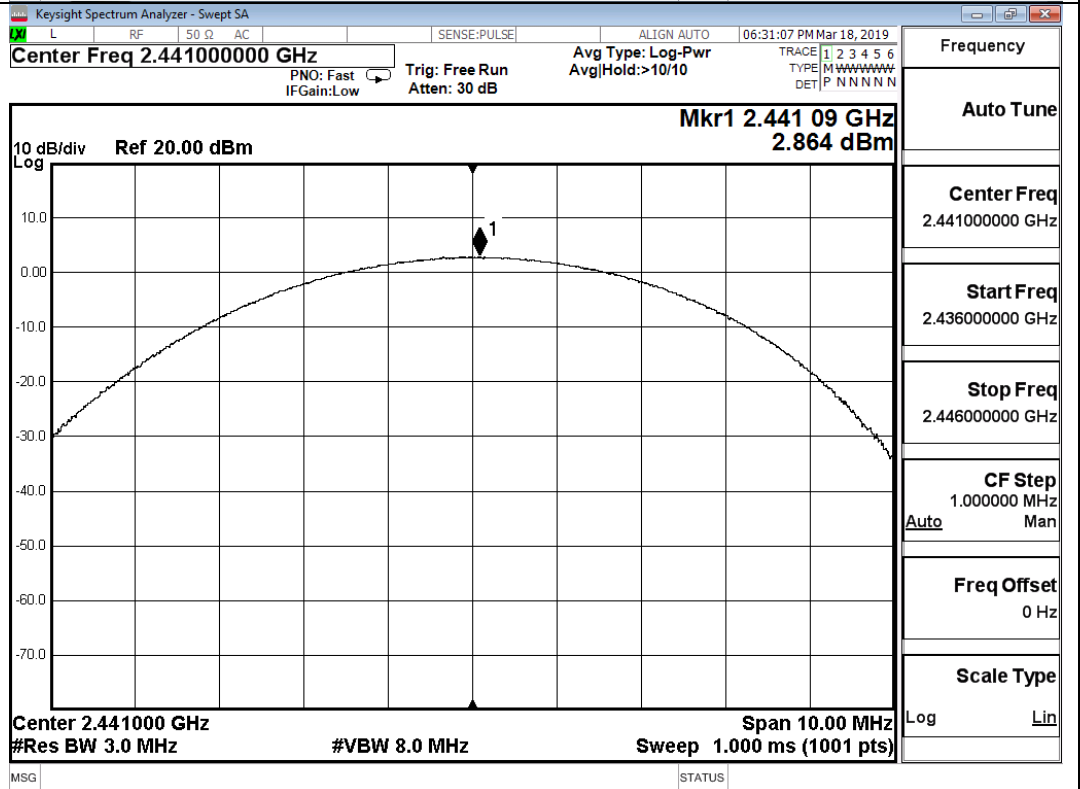

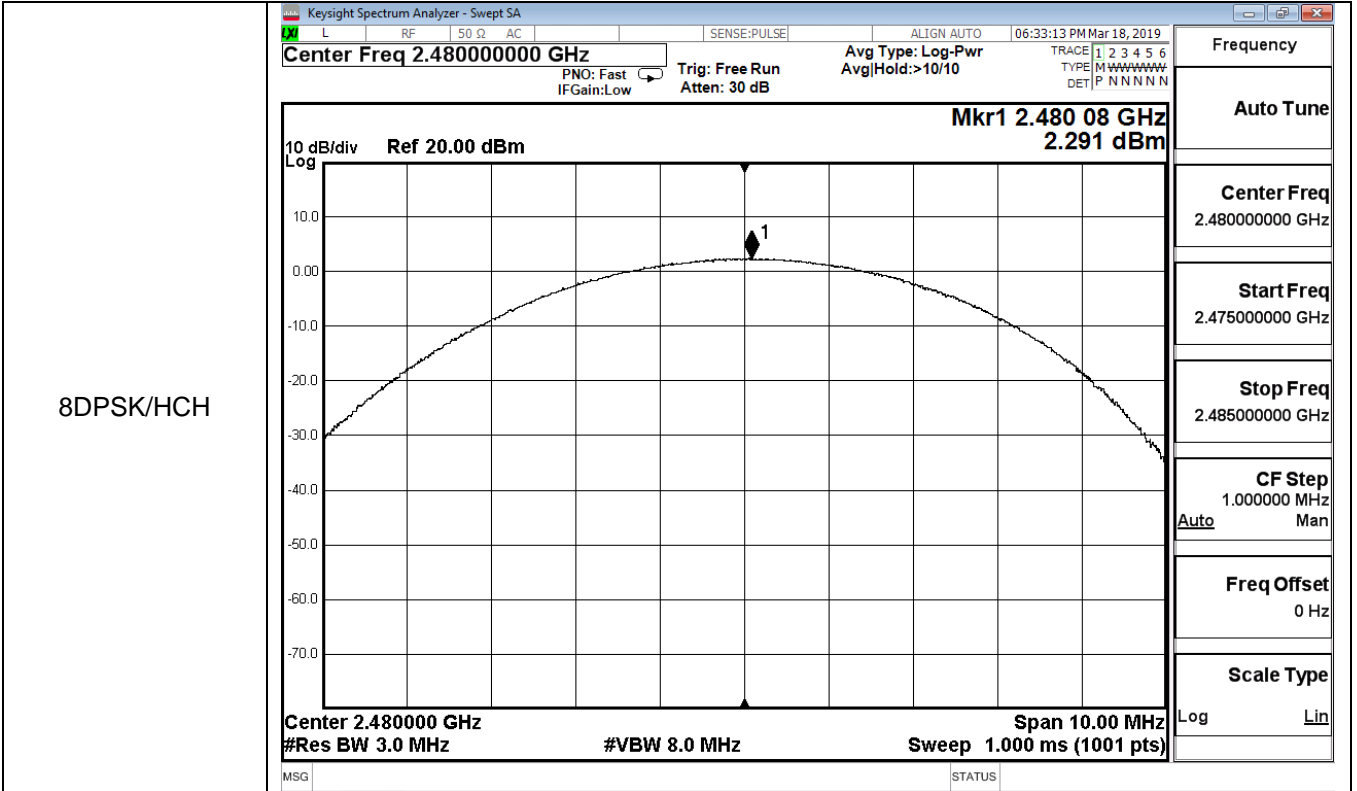

A.2 99% and 20dB Bandwidth

Mode	Channel.	99% Bandwidth [MHz]	20dB Bandwidth [MHz]	Limit [MHz]	Verdict
GFSK	LCH	0.86548	0.8869	Not Specified	PASS
	MCH	0.85358	0.8781	Not Specified	PASS
	HCH	0.86445	0.8921	Not Specified	PASS
π/4DQPSK	LCH	1.1375	1.217	Not Specified	PASS
	MCH	1.1411	1.211	Not Specified	PASS
	HCH	1.1424	1.223	Not Specified	PASS
8DPSK	LCH	1.1570	1.262	Not Specified	PASS
	MCH	1.1423	1.265	Not Specified	PASS
	HCH	1.1485	1.262	Not Specified	PASS

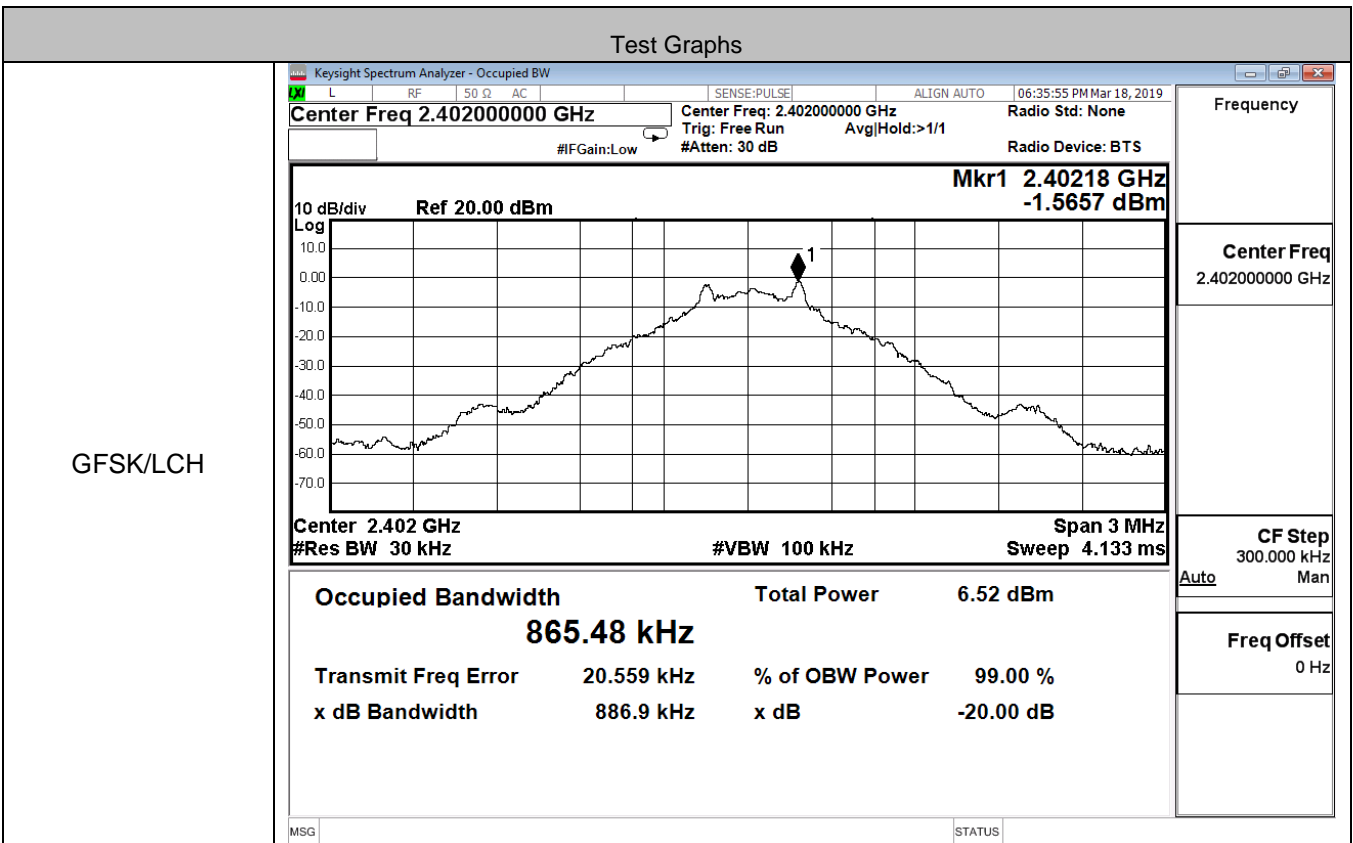

GFSK/MCH

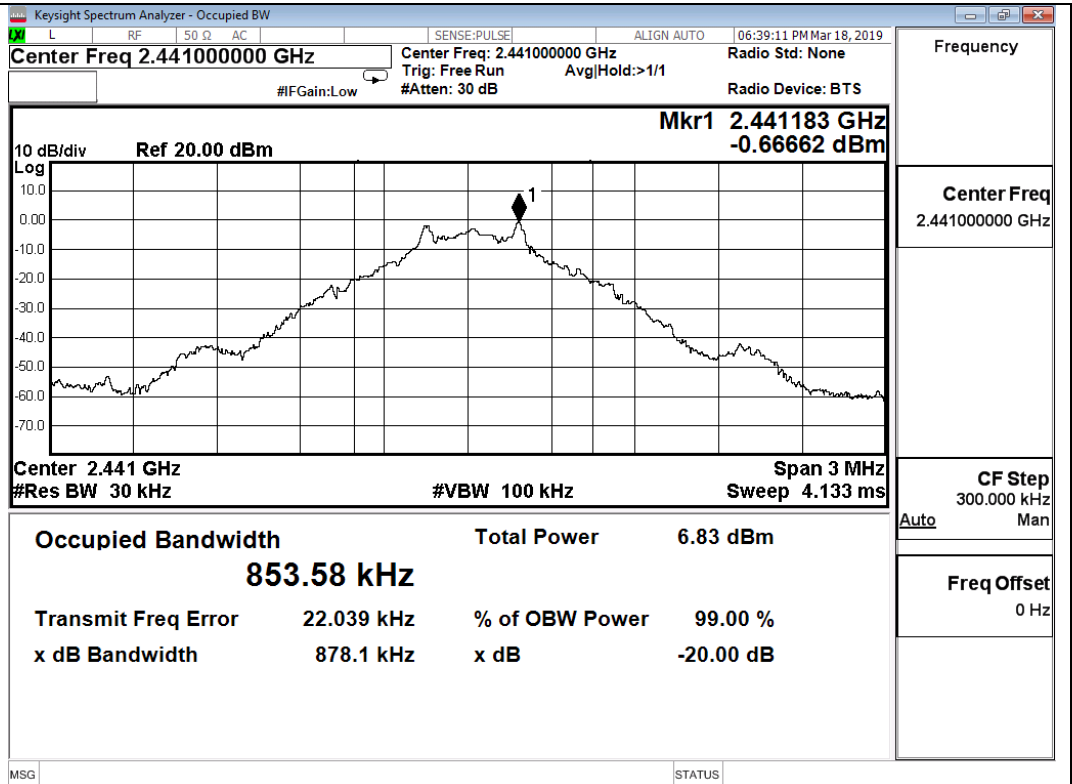

Frequency	2.441000000 GHz
Center Freq	2.441000000 GHz
CF Step	300.000 kHz
Auto	Man
Freq Offset	0 Hz

GFSK/HCH

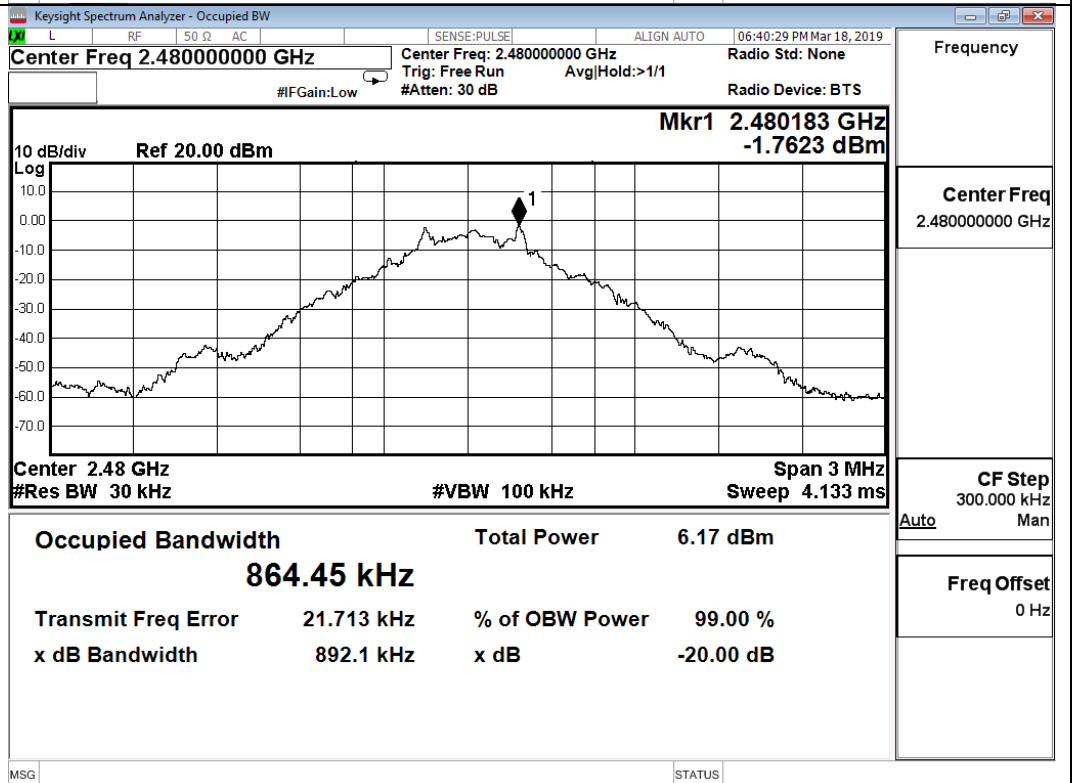

Frequency	2.480000000 GHz
Center Freq	2.480000000 GHz
CF Step	300.000 kHz
Auto	Man
Freq Offset	0 Hz

$\pi/4$ DQPSK/LCH

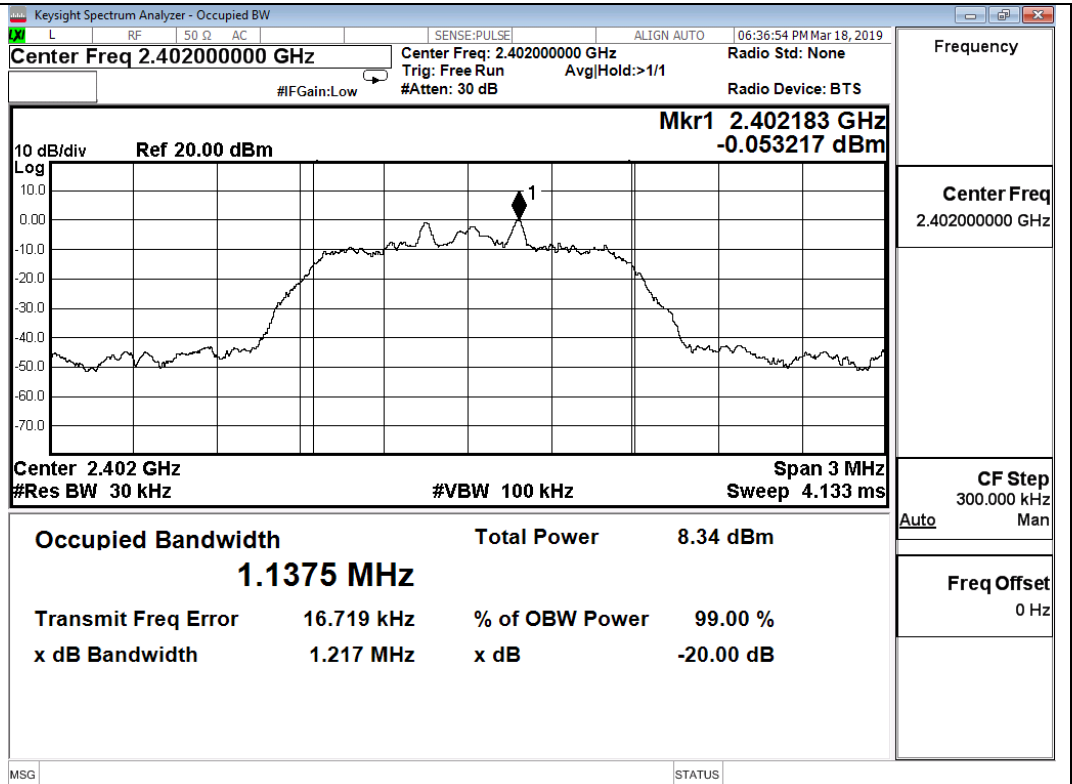

$\pi/4$ DQPSK/MCH

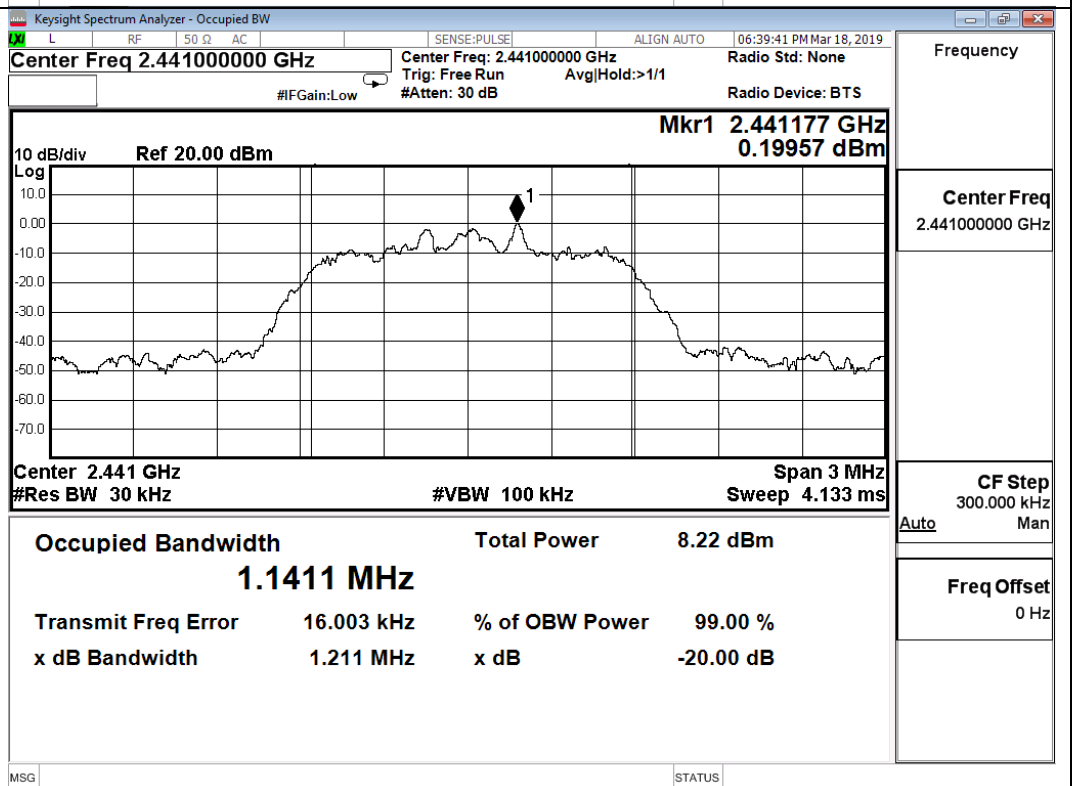

$\pi/4$ DQPSK/HCH

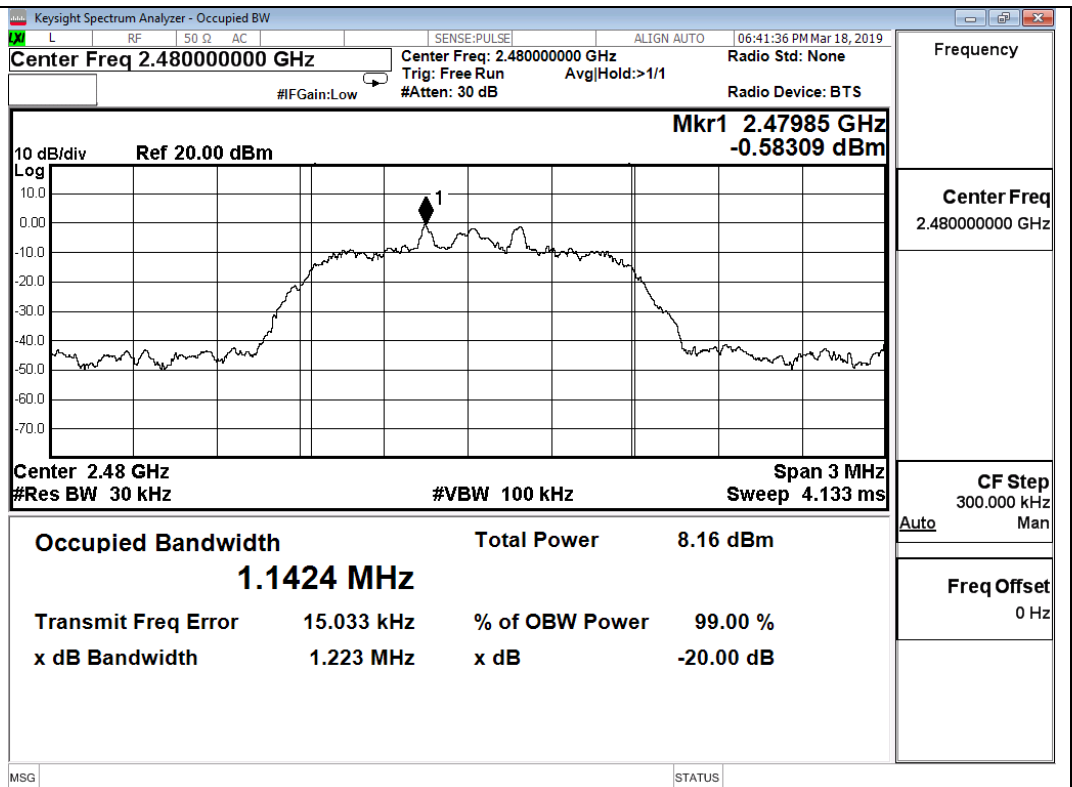

8DPSK/LCH

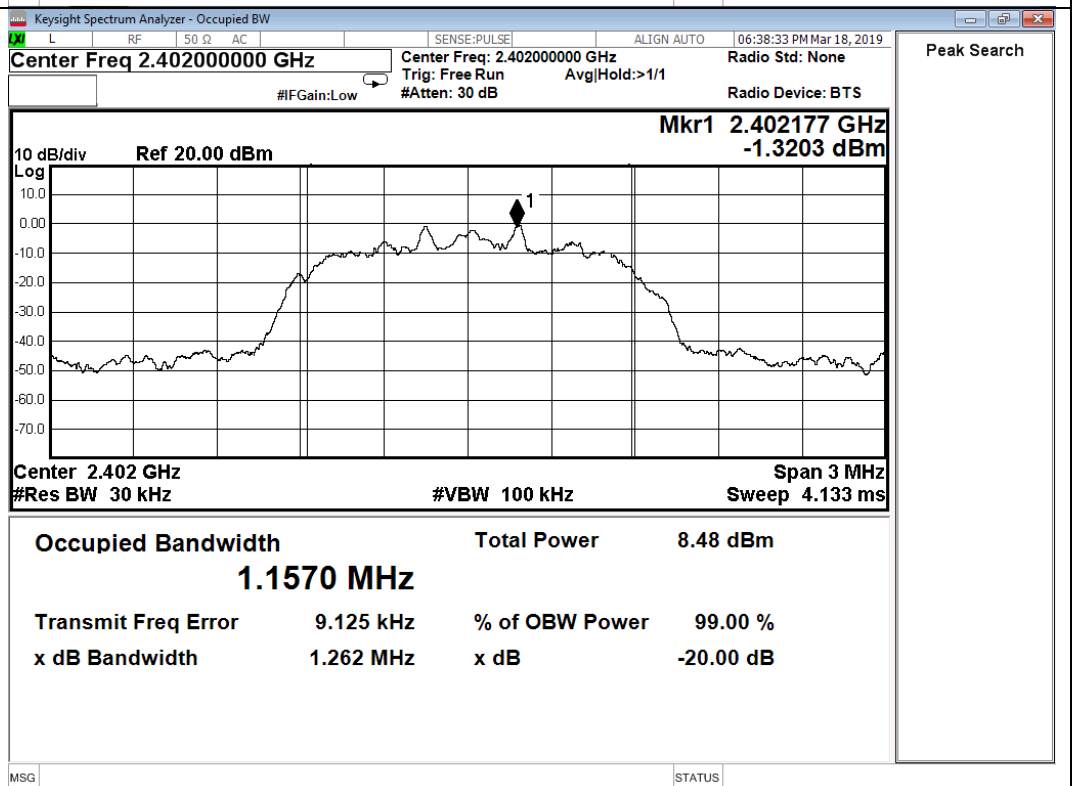

8DPSK/MCH

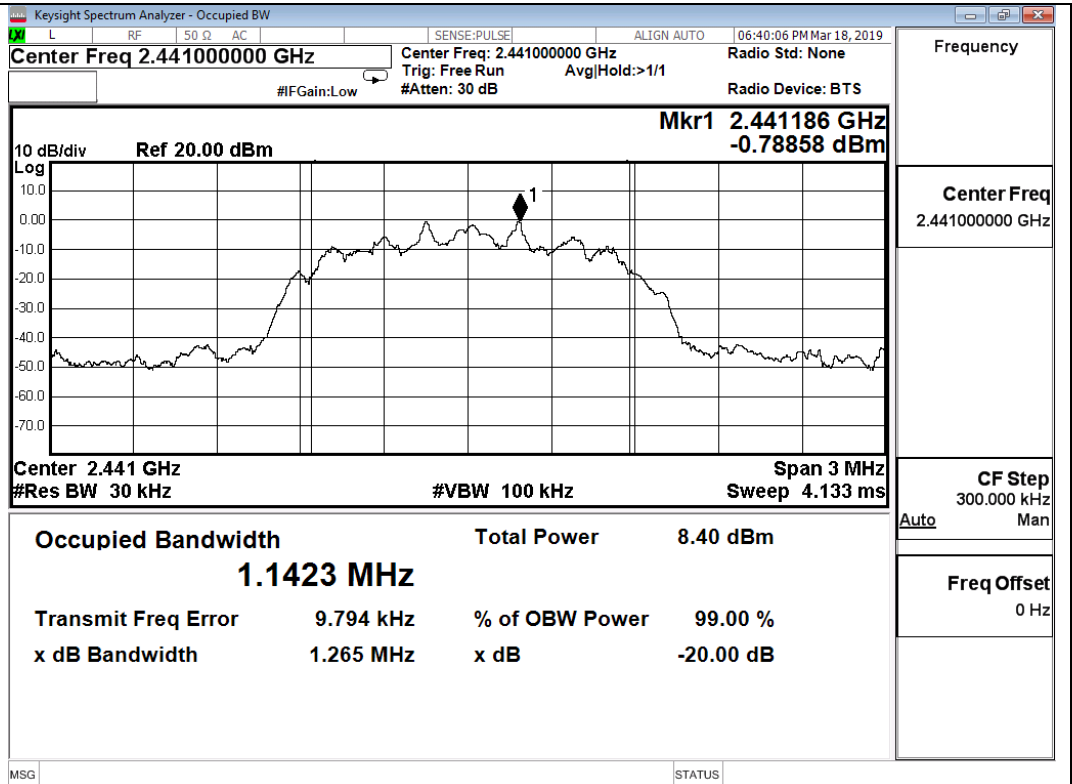

8DPSK/HCH

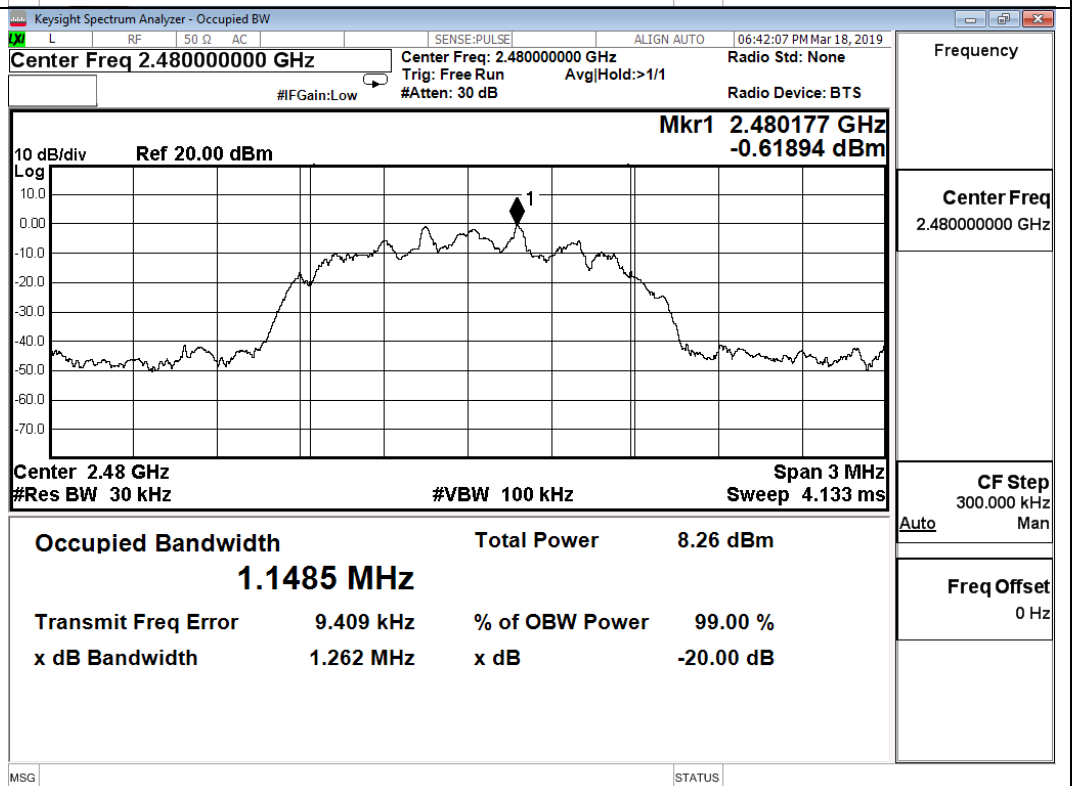

A.3 Carrier Frequency Separation

Mode	Channel.	Carrier Frequency Separation [MHz]	Limit [MHz] 2/3*20dB Bandwidth	Verdict
GFSK	LCH	1.001	0.591	PASS
	MCH	0.995	0.585	PASS
	HCH	0.999	0.595	PASS
π/4DQPSK	LCH	1.010	0.811	PASS
	MCH	1.026	0.807	PASS
	HCH	1.006	0.815	PASS
8DPSK	LCH	1.024	0.841	PASS
	MCH	1.009	0.843	PASS
	HCH	1.029	0.841	PASS

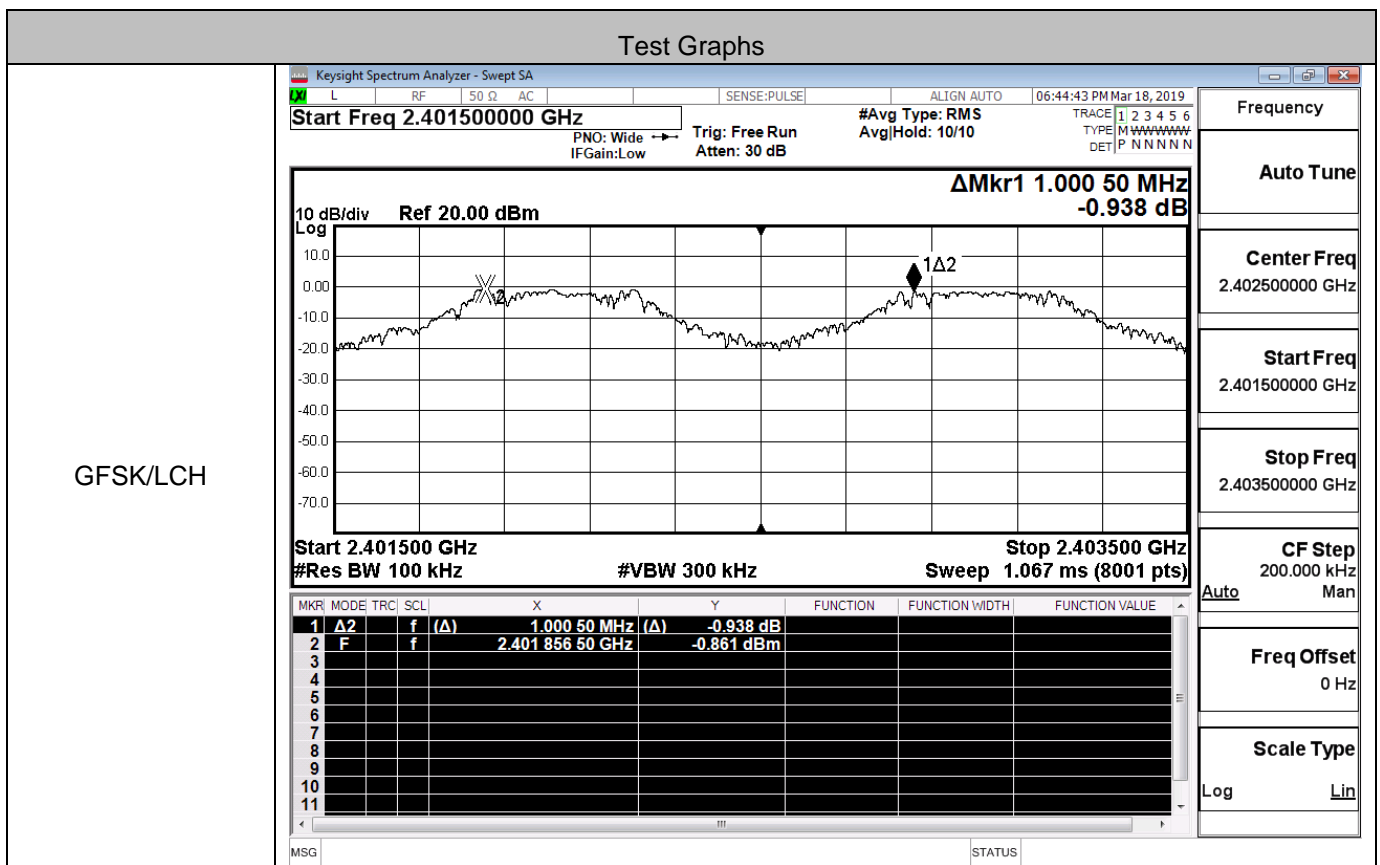

GFSK/MCH

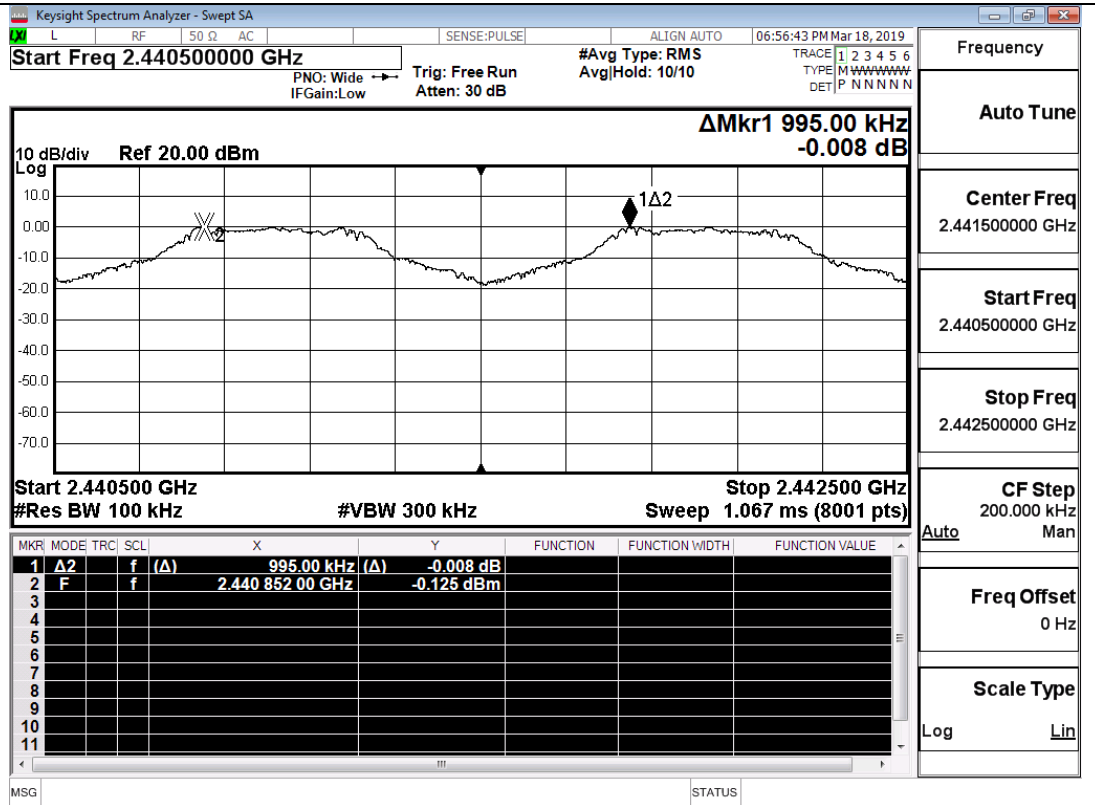

GFSK/HCH

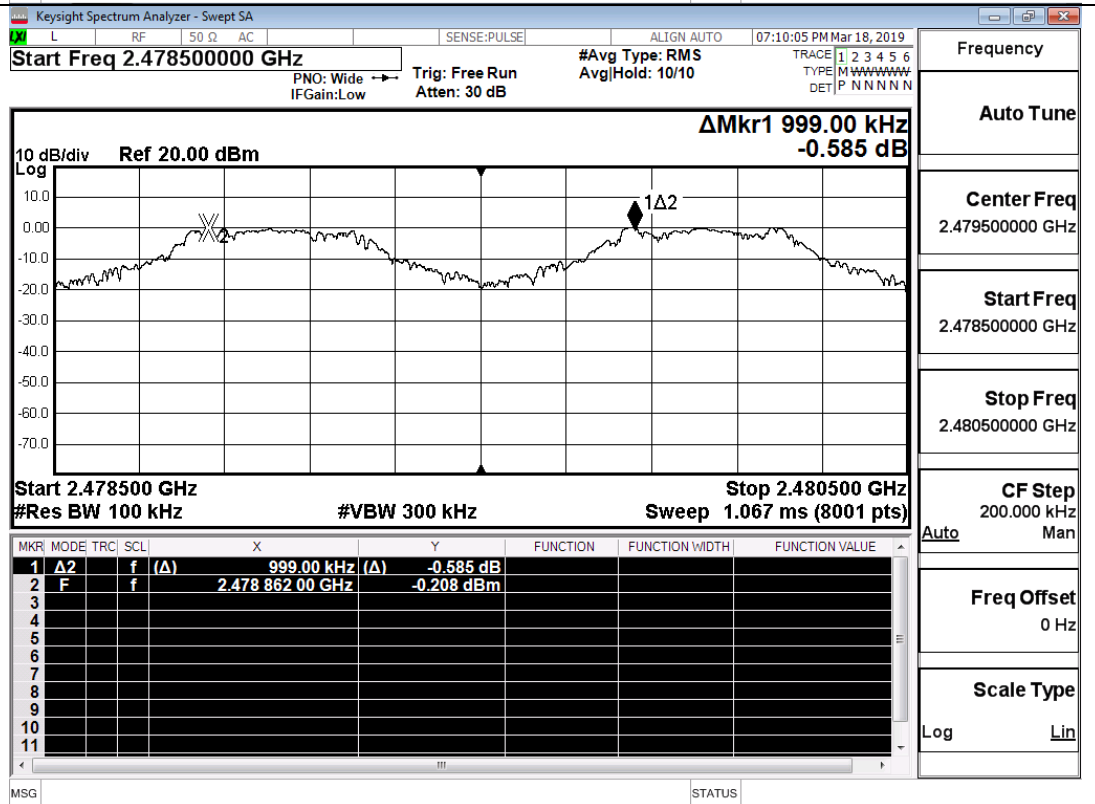

$\pi/4$ DQPSK/LCH

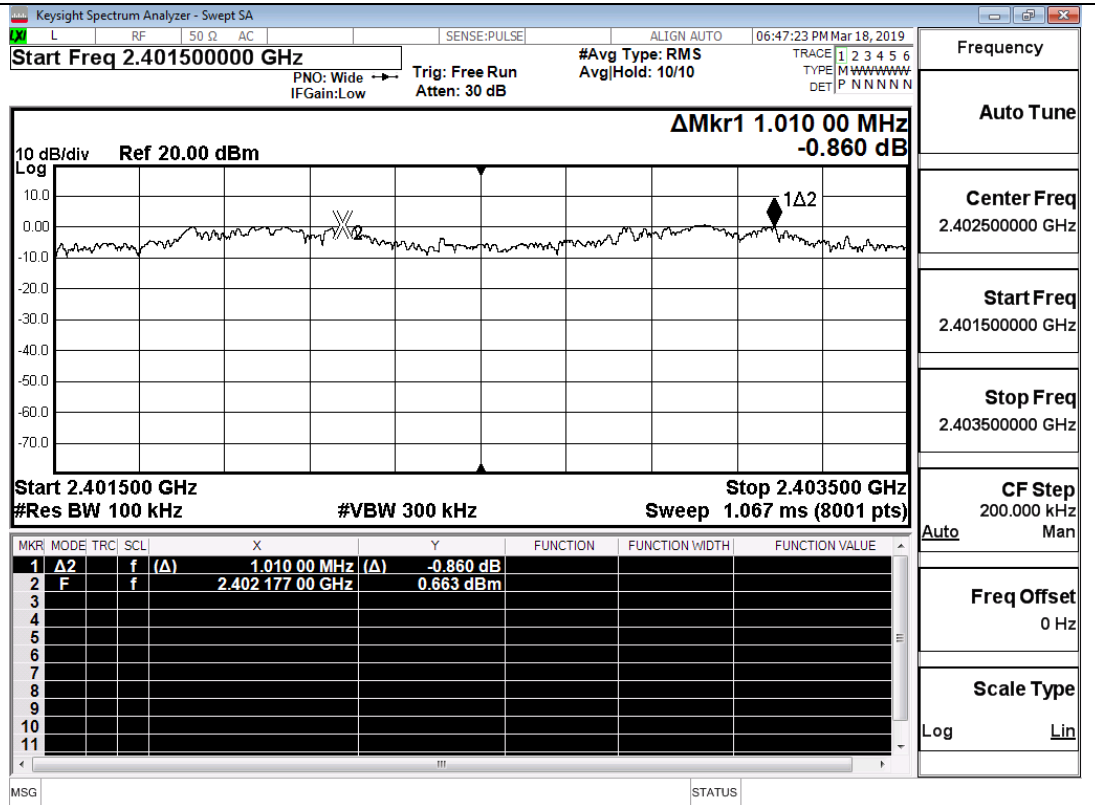

$\pi/4$ DQPSK/MCH

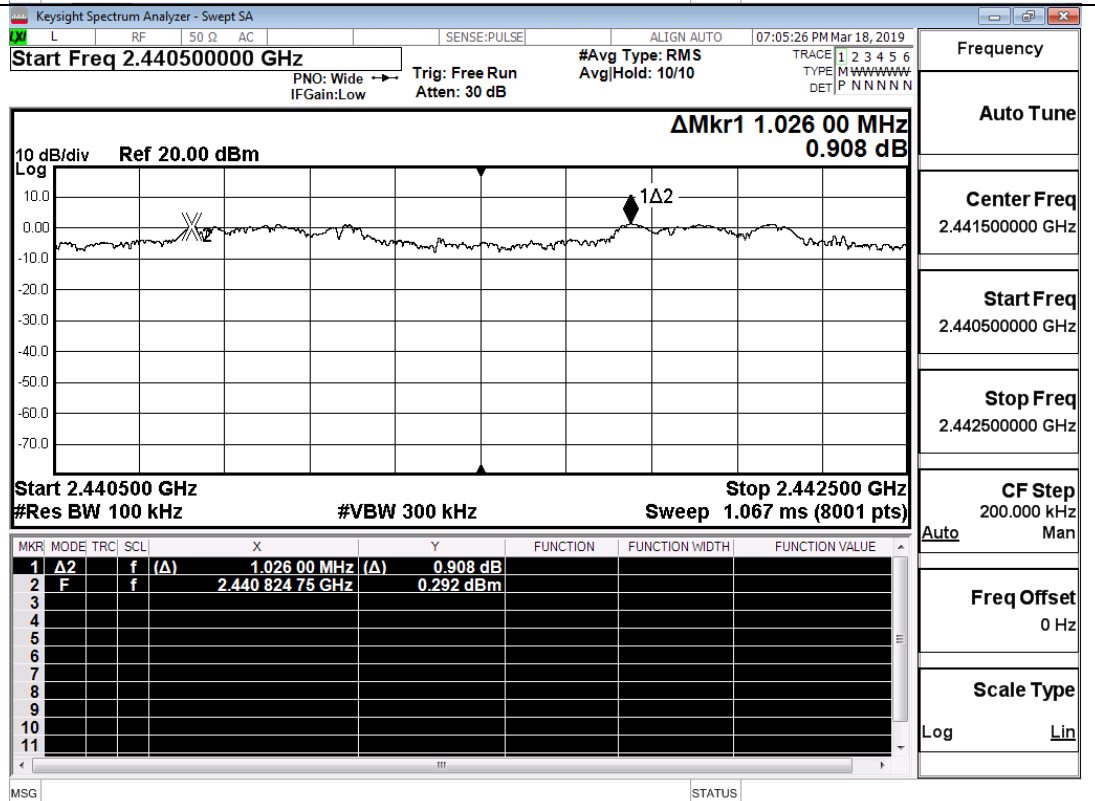

$\pi/4$ DQPSK/HCH

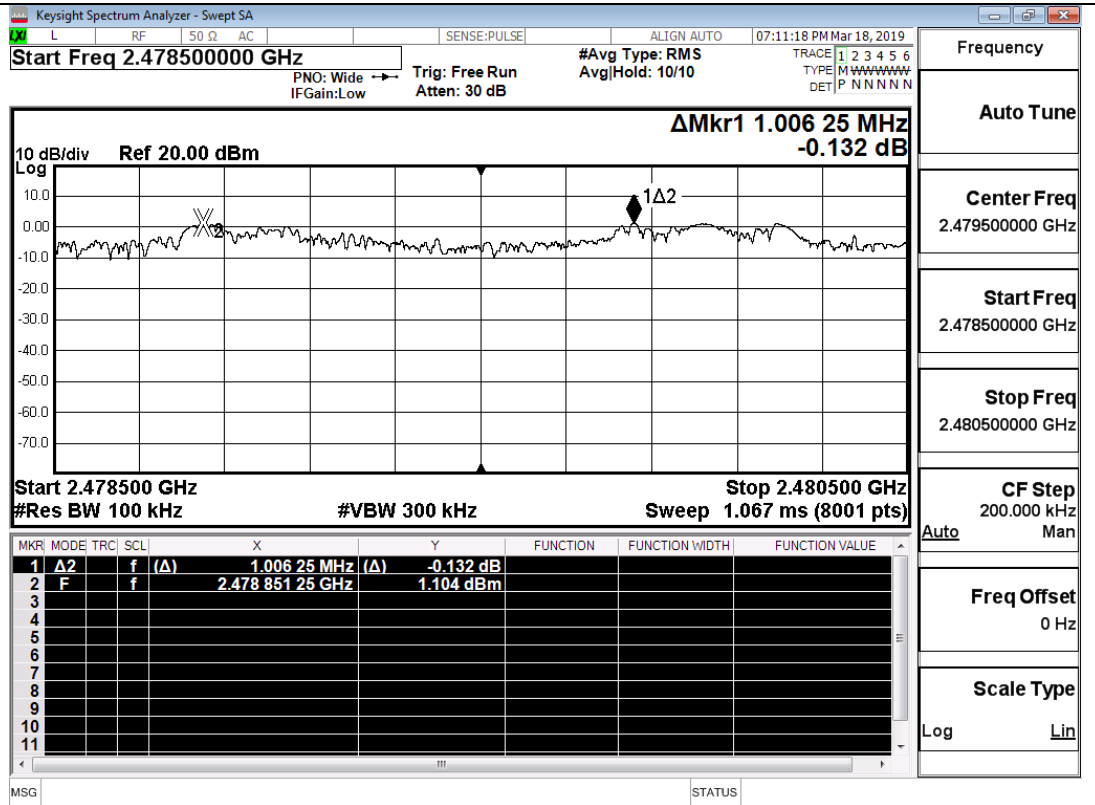

8DPSK/LCH

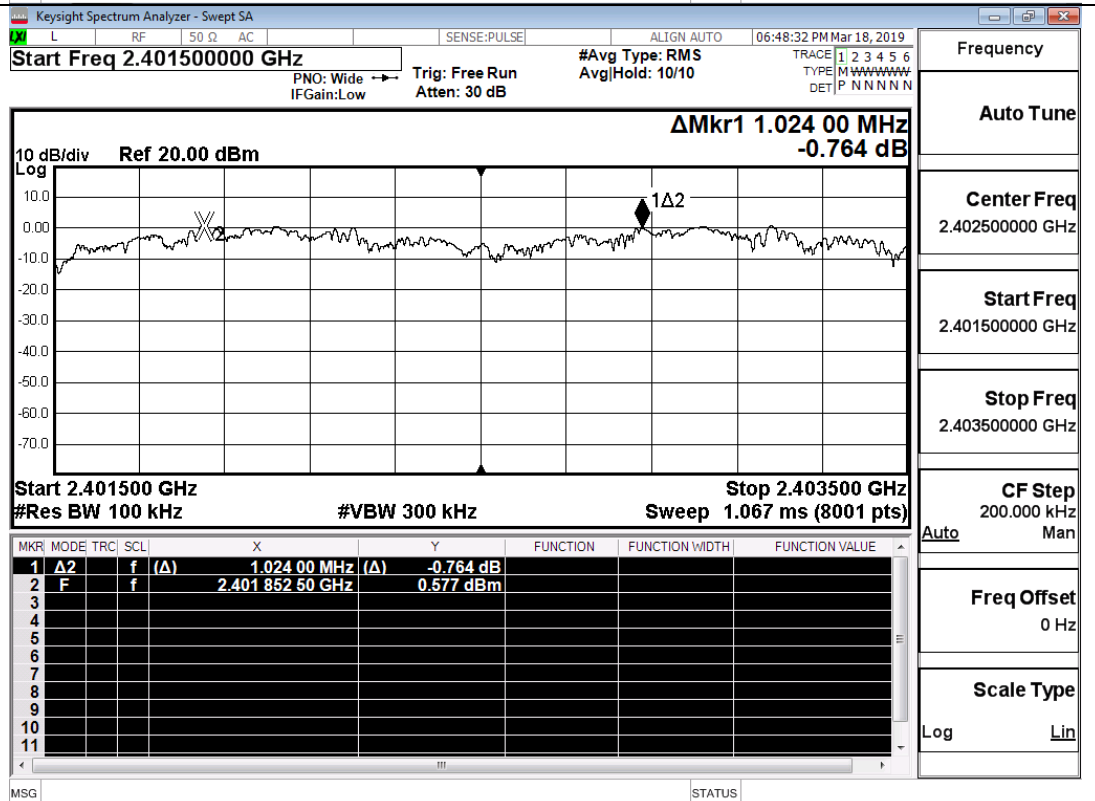

8DPSK/MCH

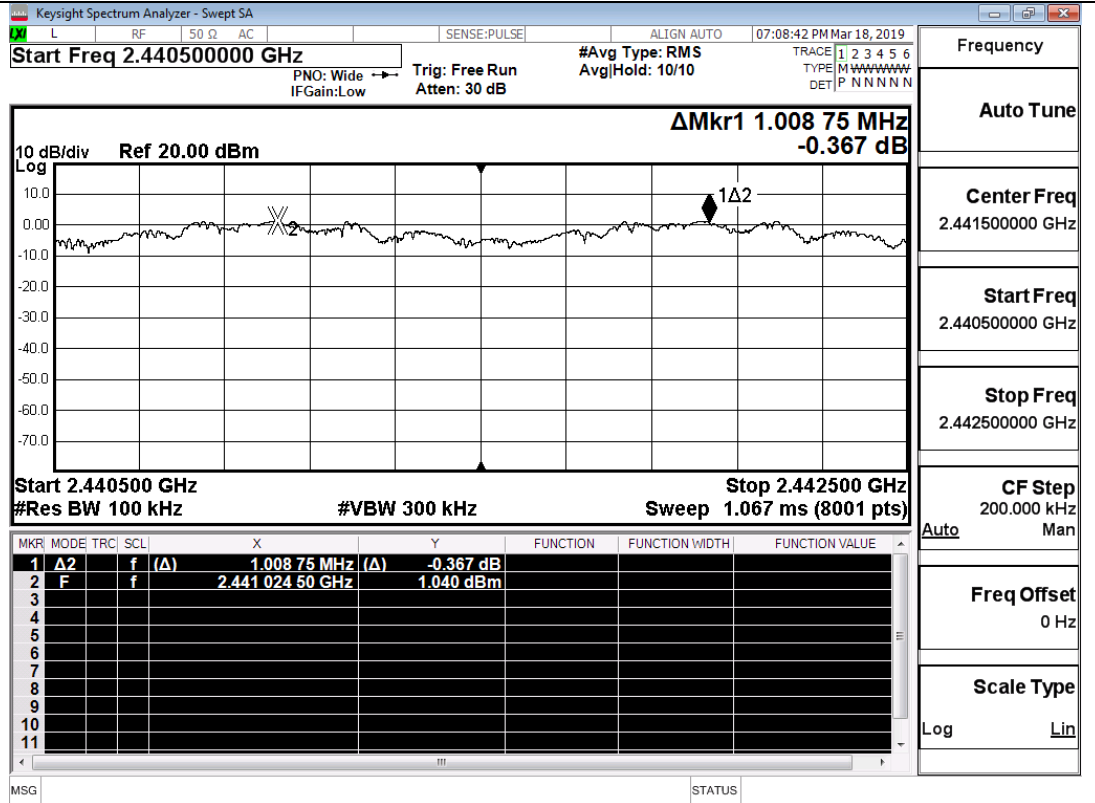

8DPSK/HCH

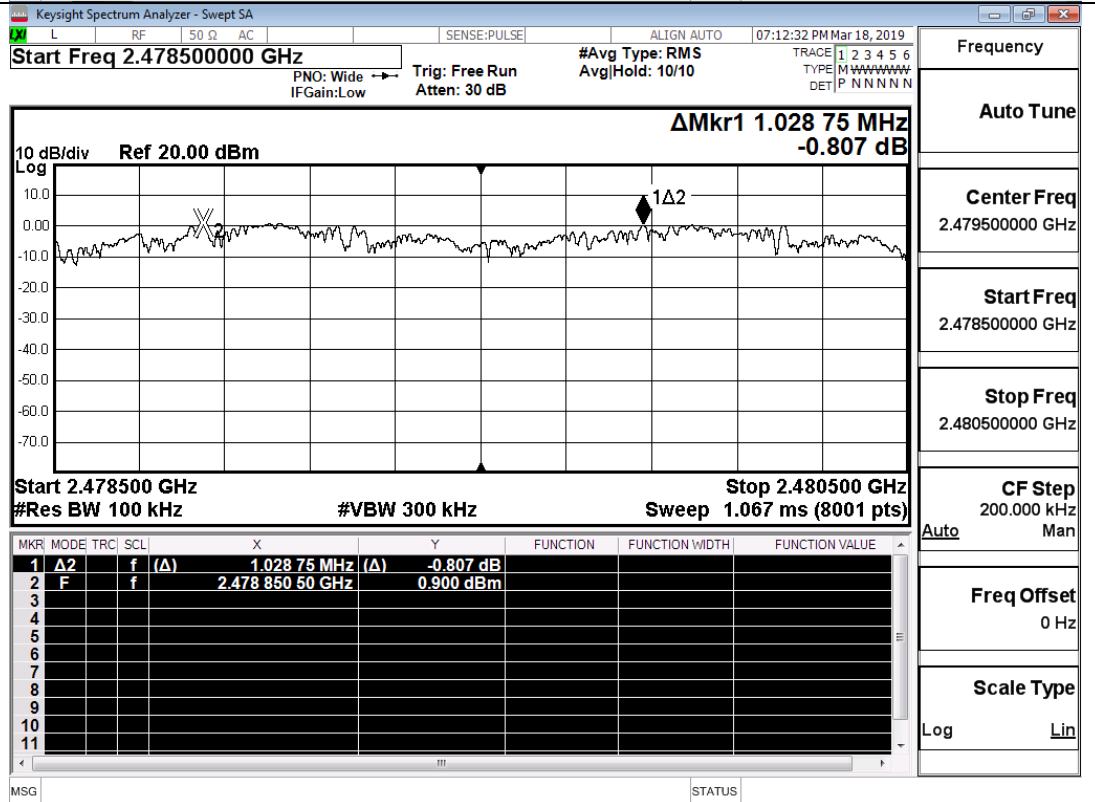

A.4 Hopping Channel Number

Mode	Channel.	Number of Hopping Channel [N]	Limit [N]	Verdict
GFSK	Hop	79	>=15	PASS
$\pi/4$ DQPSK	Hop	79	>=15	PASS
8DPSK	Hop	79	>=15	PASS

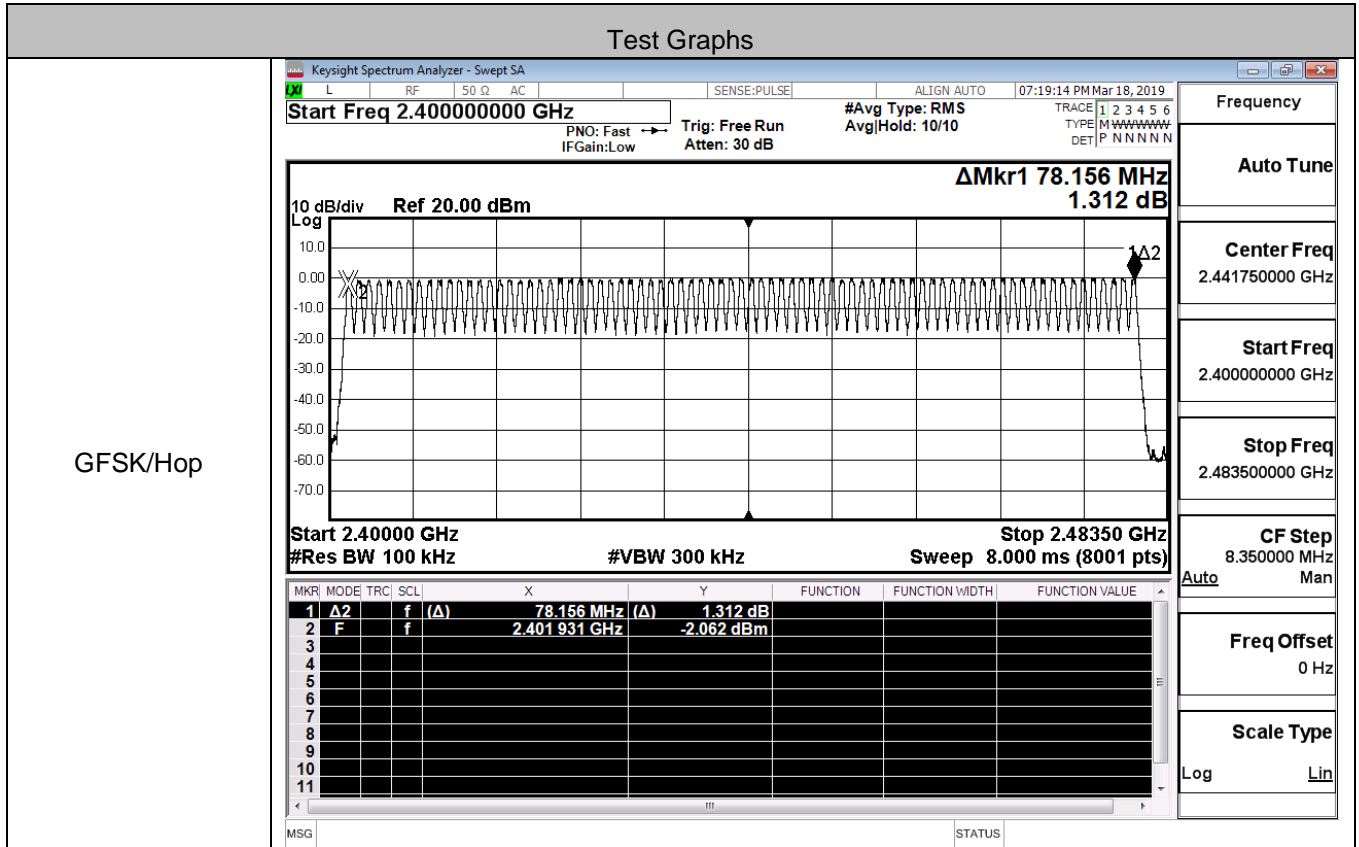

$\pi/4$ DQPSK/Hop

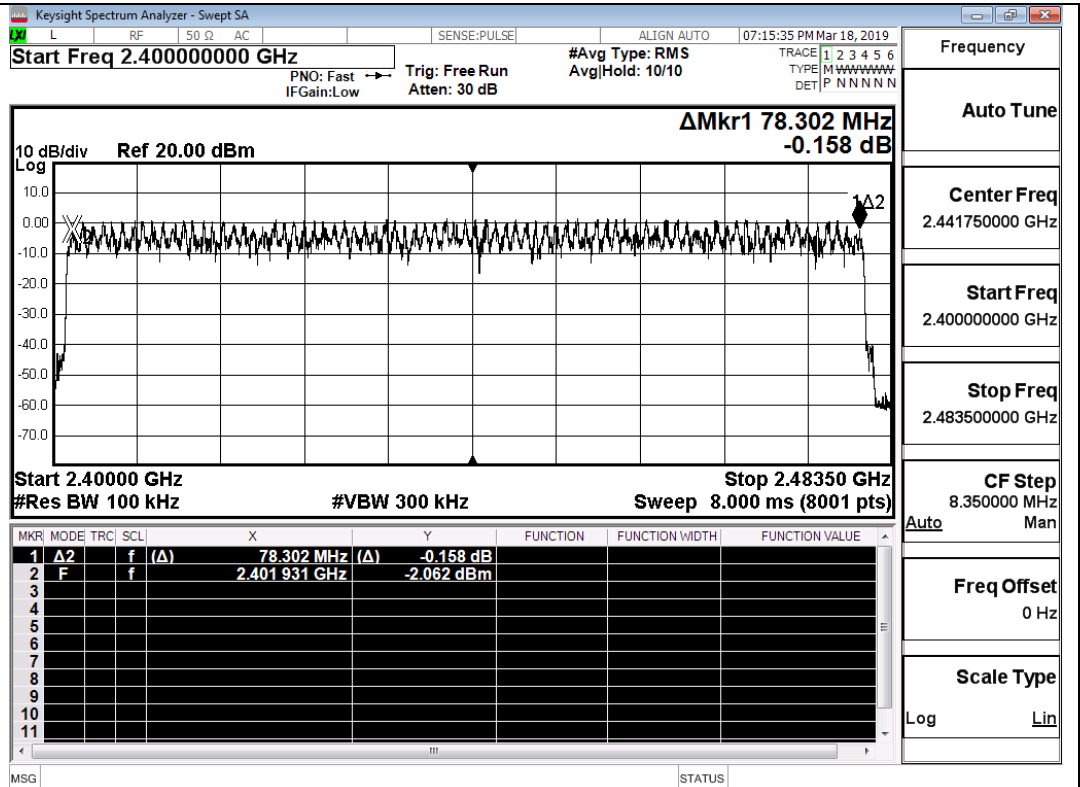

8DPSK/Hop

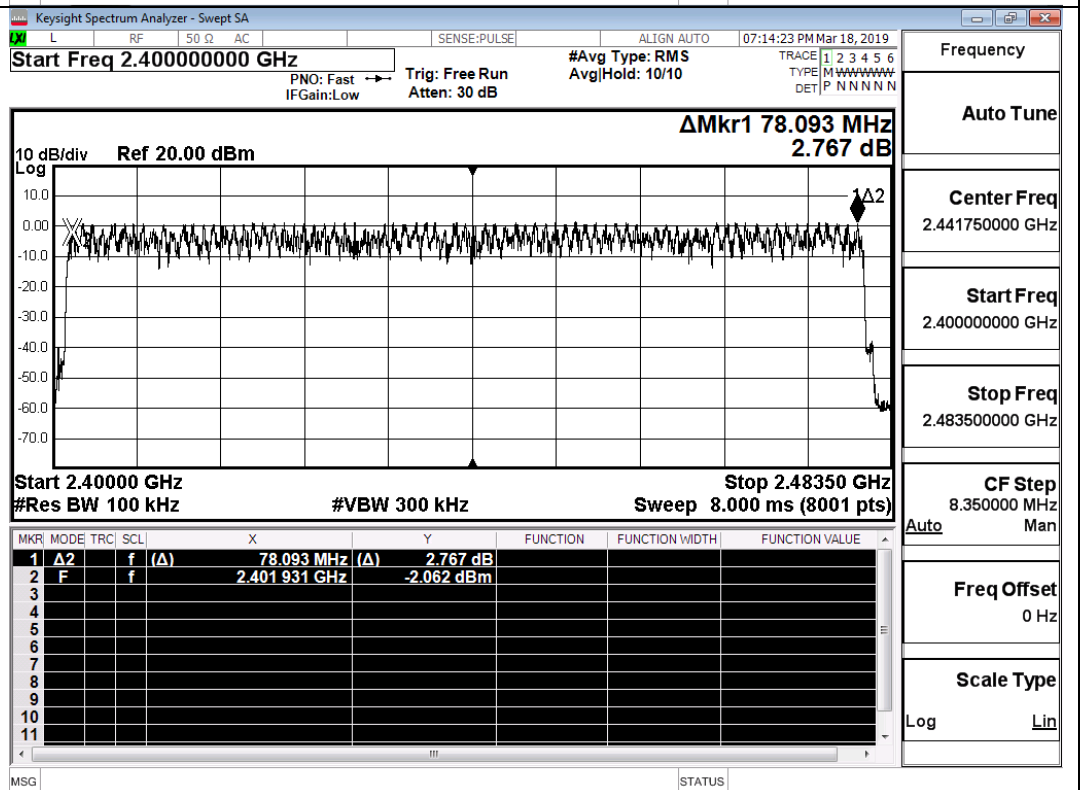

A.5 Dwell Time

Mode	Packet	Channel	Burst Width [ms/hop/ch]	Total Hops[hop*ch]	Dwell Time[s]	Limit [s]	Verdict
GFSK	DH5	LCH	2.88	106.7	0.307	0.4	PASS
	DH5	MCH	2.89	106.7	0.308	0.4	PASS
	DH5	HCH	2.88	106.7	0.307	0.4	PASS
π/4DQPSK	2DH5	LCH	2.88	106.7	0.307	0.4	PASS
	2DH5	MCH	2.89	106.7	0.308	0.4	PASS
	2DH5	HCH	2.89	106.7	0.308	0.4	PASS
8DPSK	3DH5	LCH	2.89	106.7	0.308	0.4	PASS
	3DH5	MCH	2.89	106.7	0.308	0.4	PASS
	3DH5	HCH	2.89	106.7	0.308	0.4	PASS

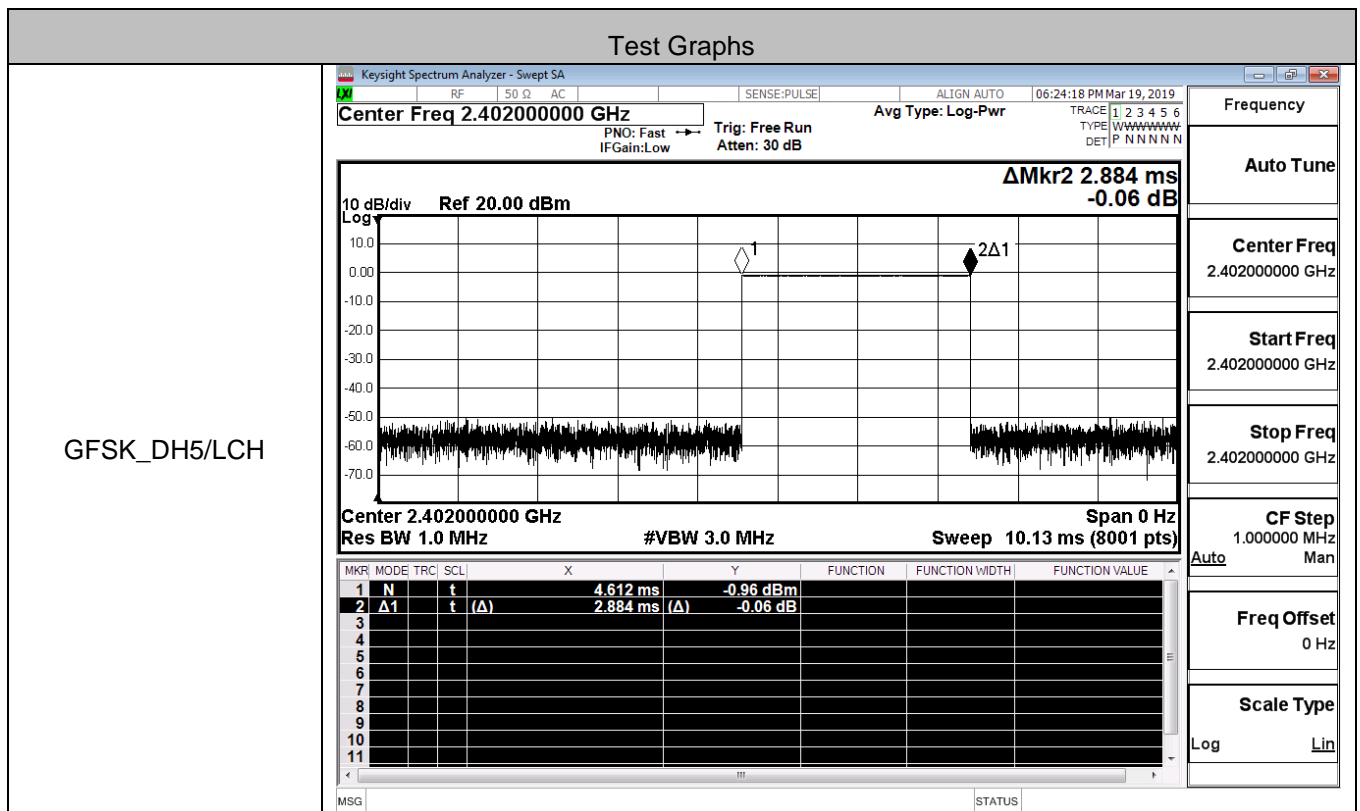

GFSK_DH5/MCH

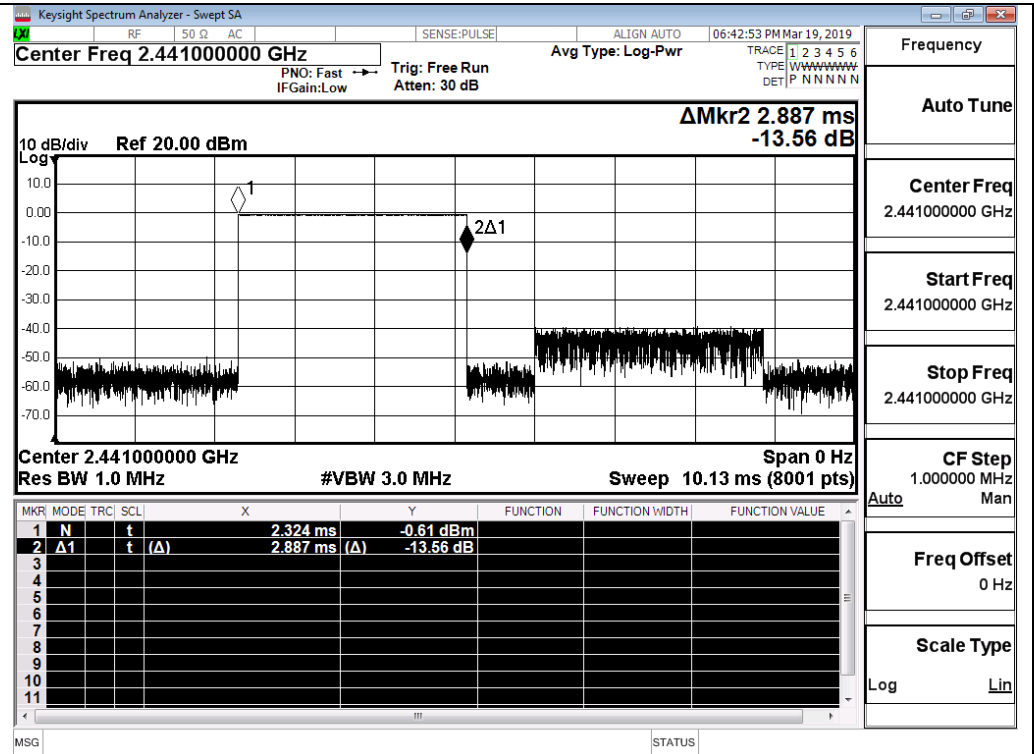

GFSK_DH5/HCH

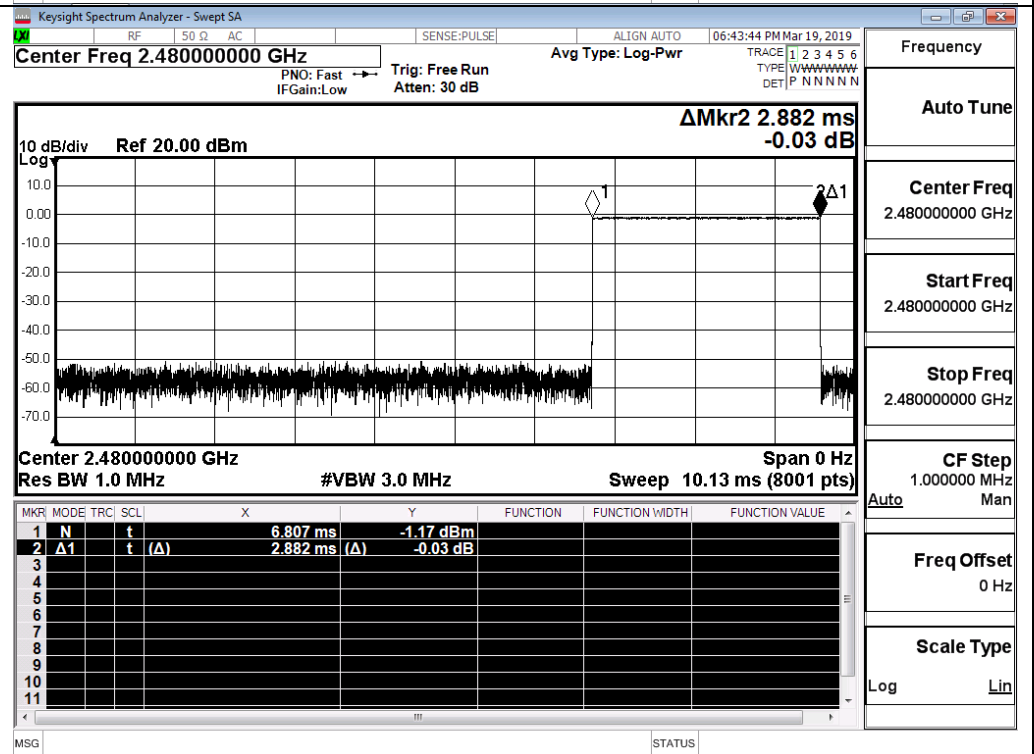

$\pi/4$ DQPSK
_2DH5/LCH

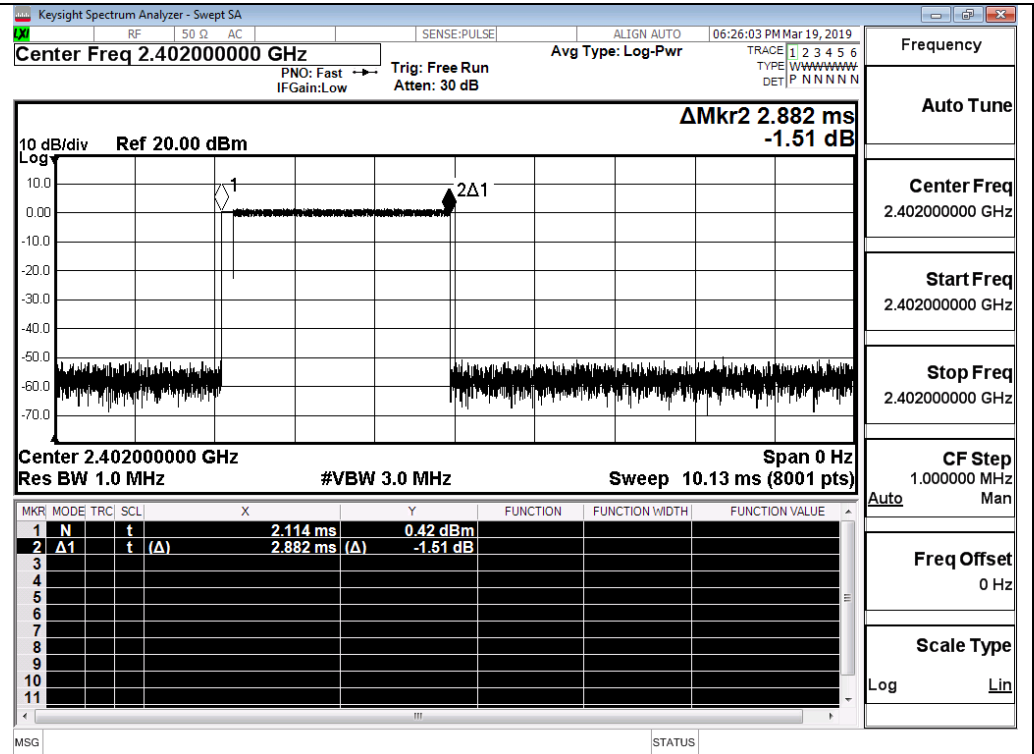

$\pi/4$ DQPSK
_2DH5/MCH

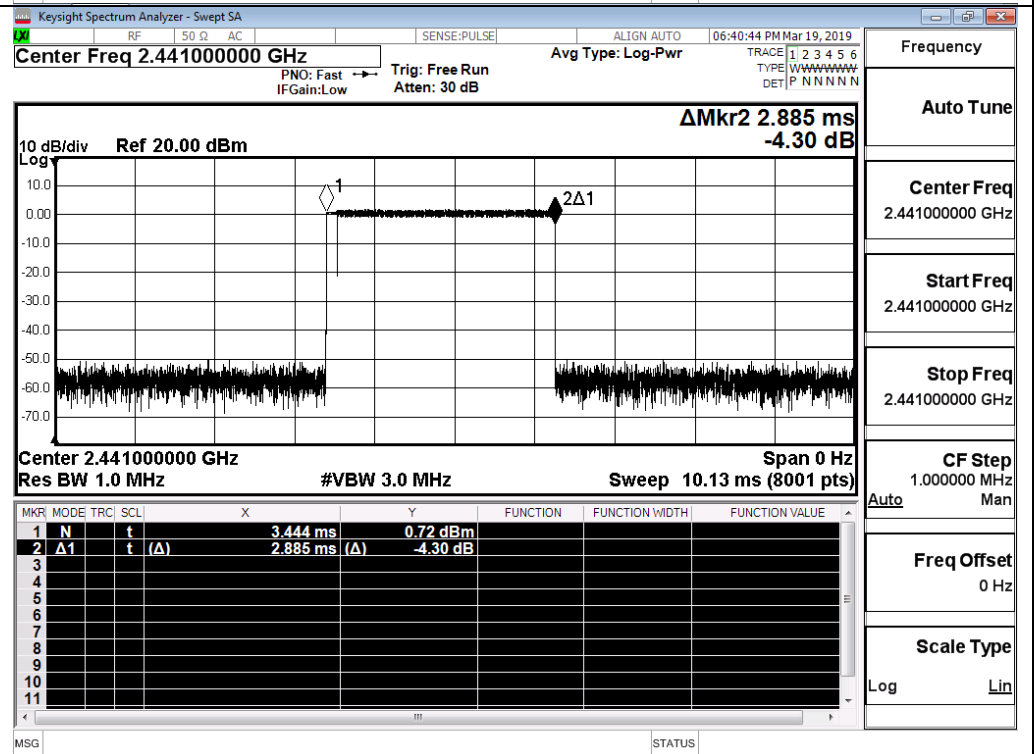

$\pi/4$ DQPSK
_2DH5/HCH

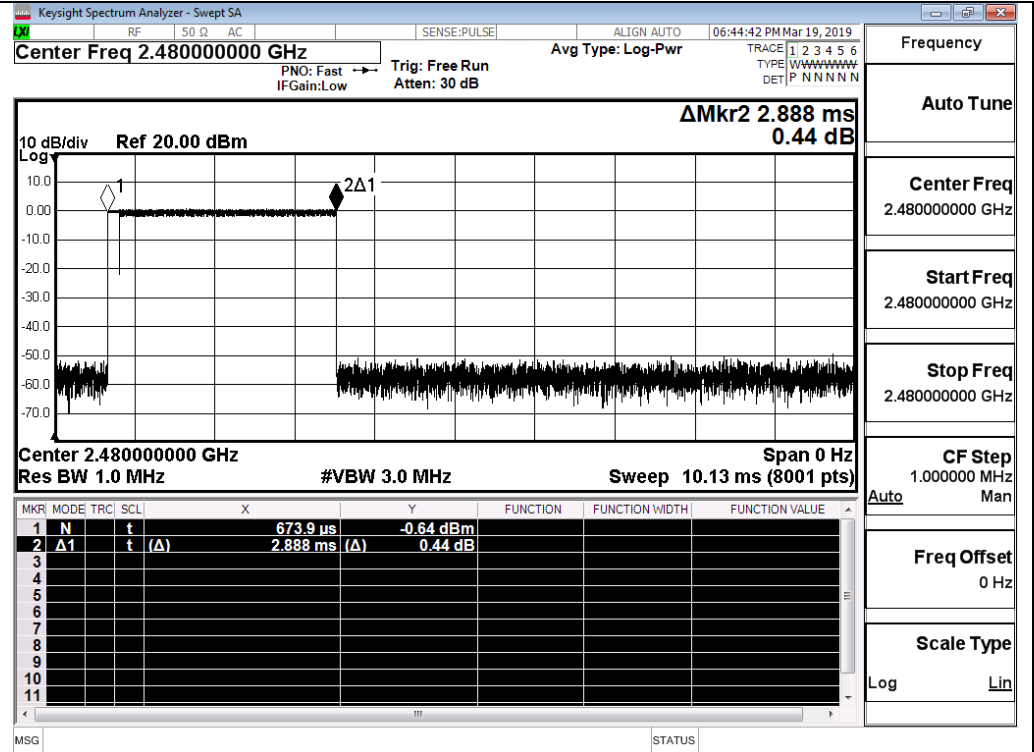

8DPSK_3DH5/LCH

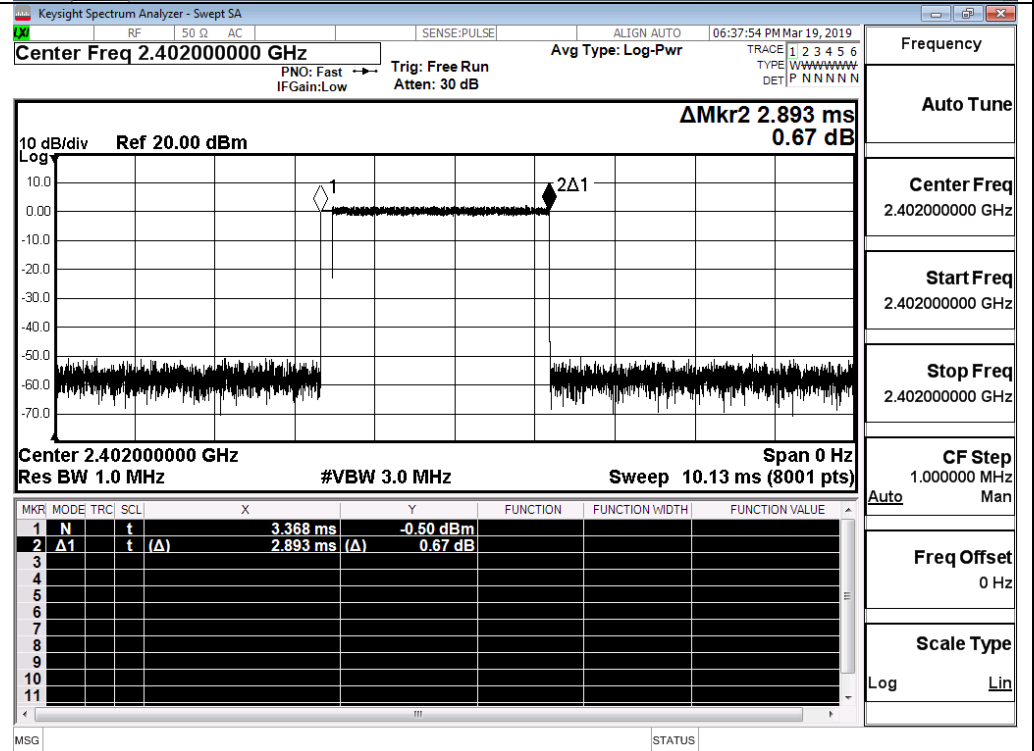

8DPSK_3DH5/MCH

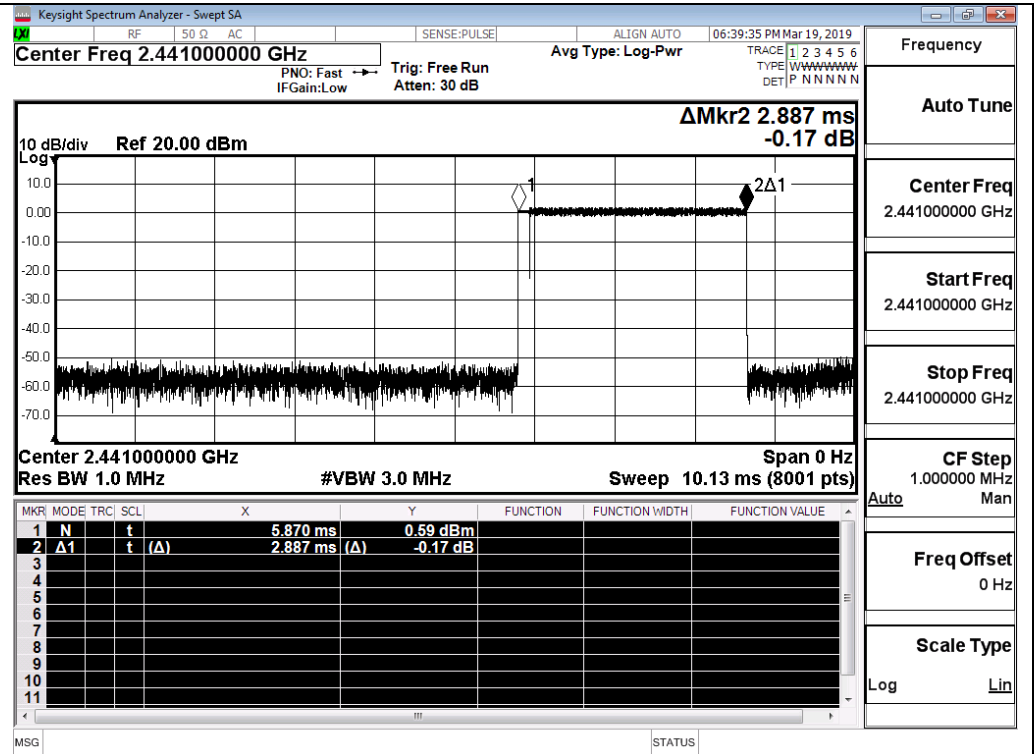

8DPSK_3DH5/HCH

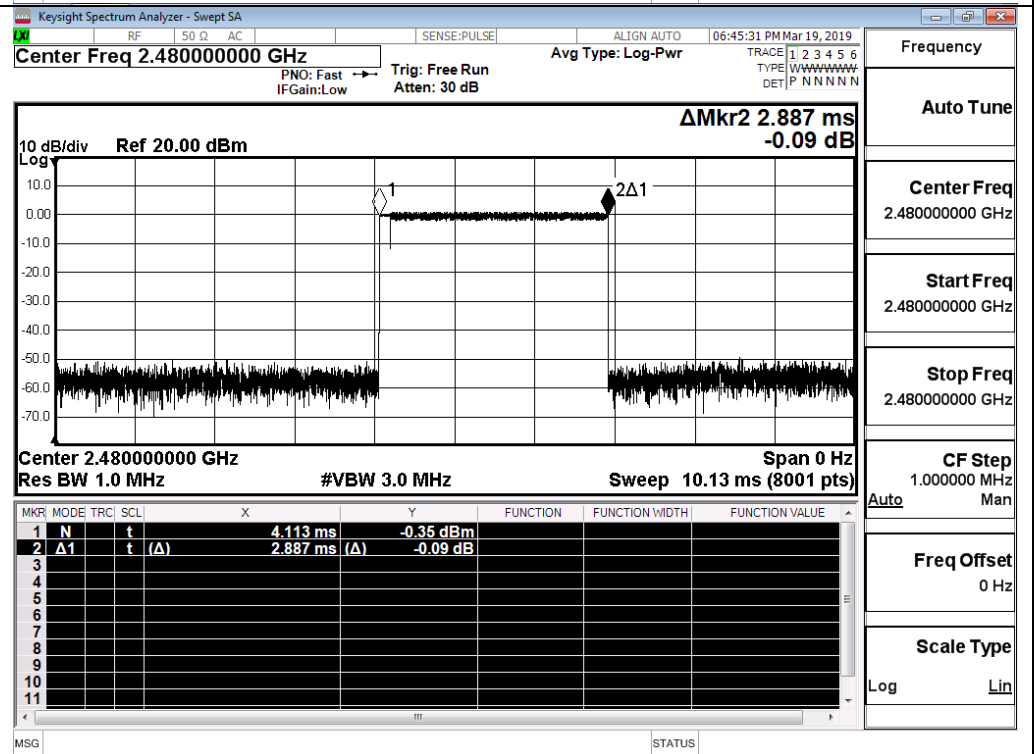

A.6 RF Conducted Spurious Emissions

Mode	Channel	Pref [dBm]	Max. Level [dBm]	Limit [dBm]	Verdict
GFSK	LCH	-0.844	-43.423	-20.84	PASS
	MCH	-0.388	-43.399	-20.39	PASS
	HCH	-0.953	-41.678	-20.95	PASS
$\pi/4$ DQPSK	LCH	0.529	-39.234	-19.47	PASS
	MCH	1.213	-36.157	-18.79	PASS
	HCH	0.077	-42.211	-19.92	PASS
8DPSK	LCH	0.485	-43.953	-19.52	PASS
	MCH	1.014	-39.880	-18.99	PASS
	HCH	0.542	-40.162	-19.46	PASS

GFSK_LCH_Graphs

Pref

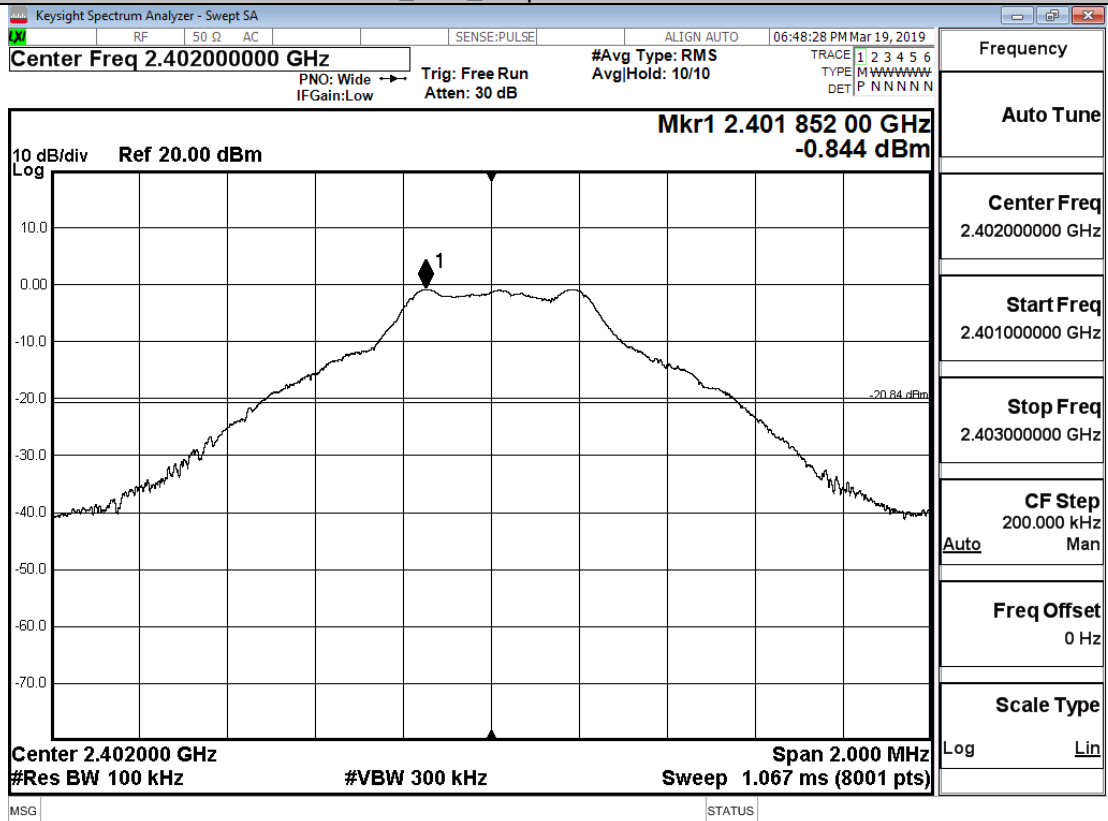

Puw

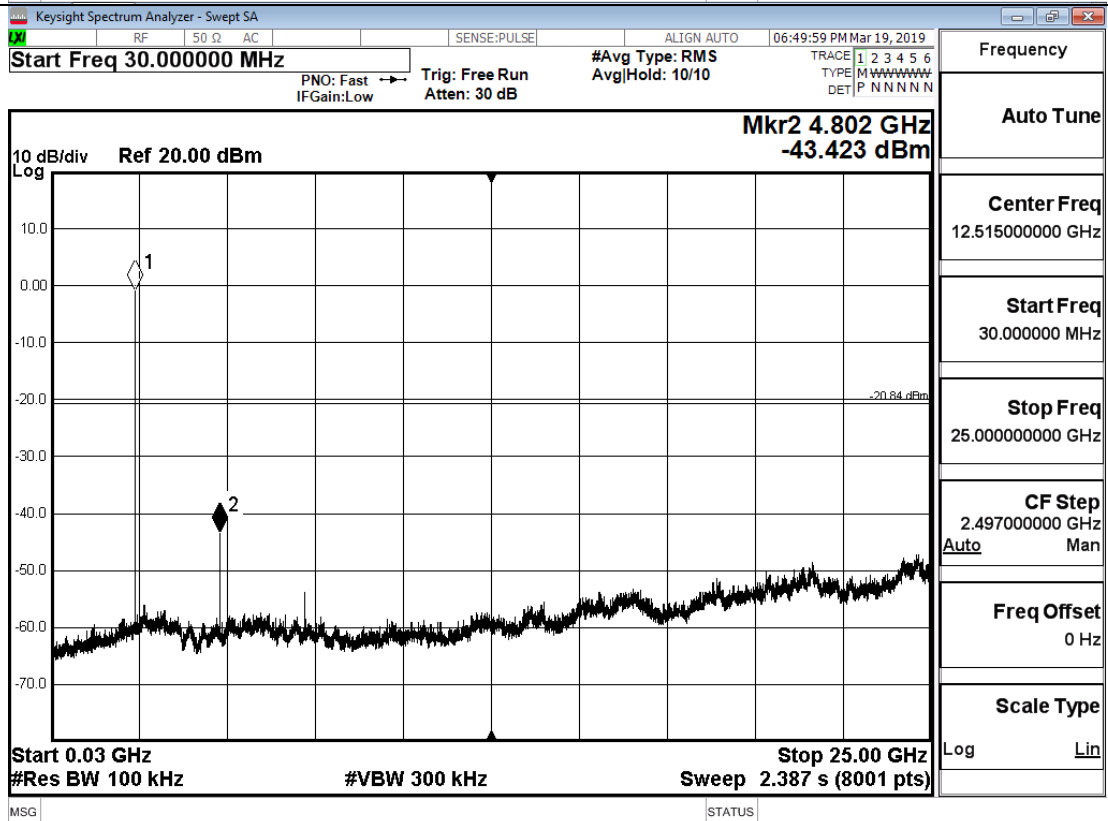

GFSK_MCH_Graphs

Pref

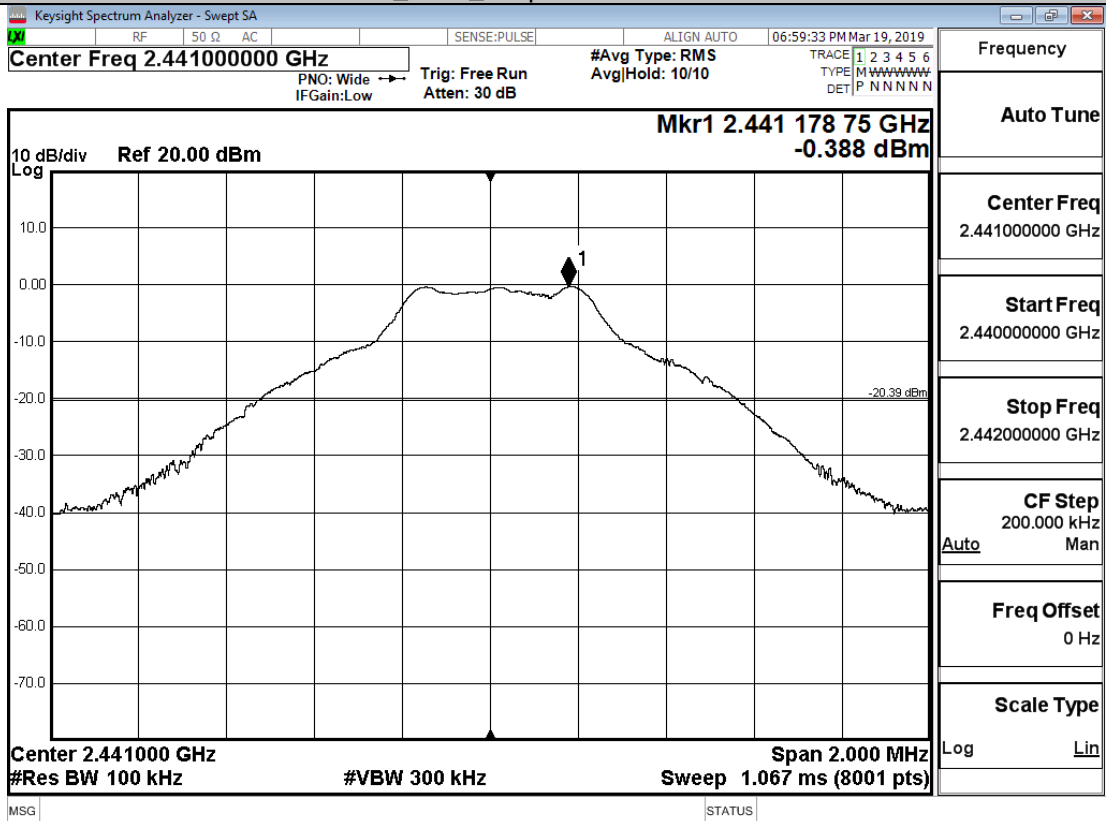

Puw

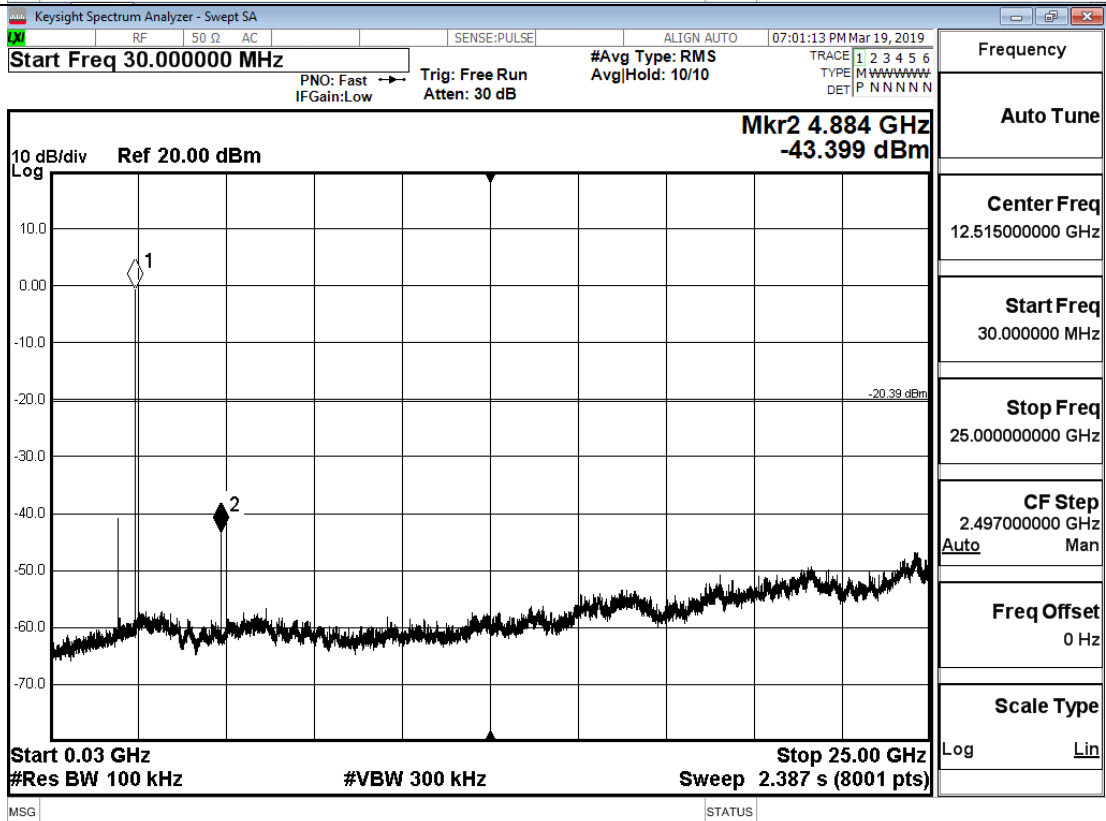

GFSK_HCH_Graphs

Pref

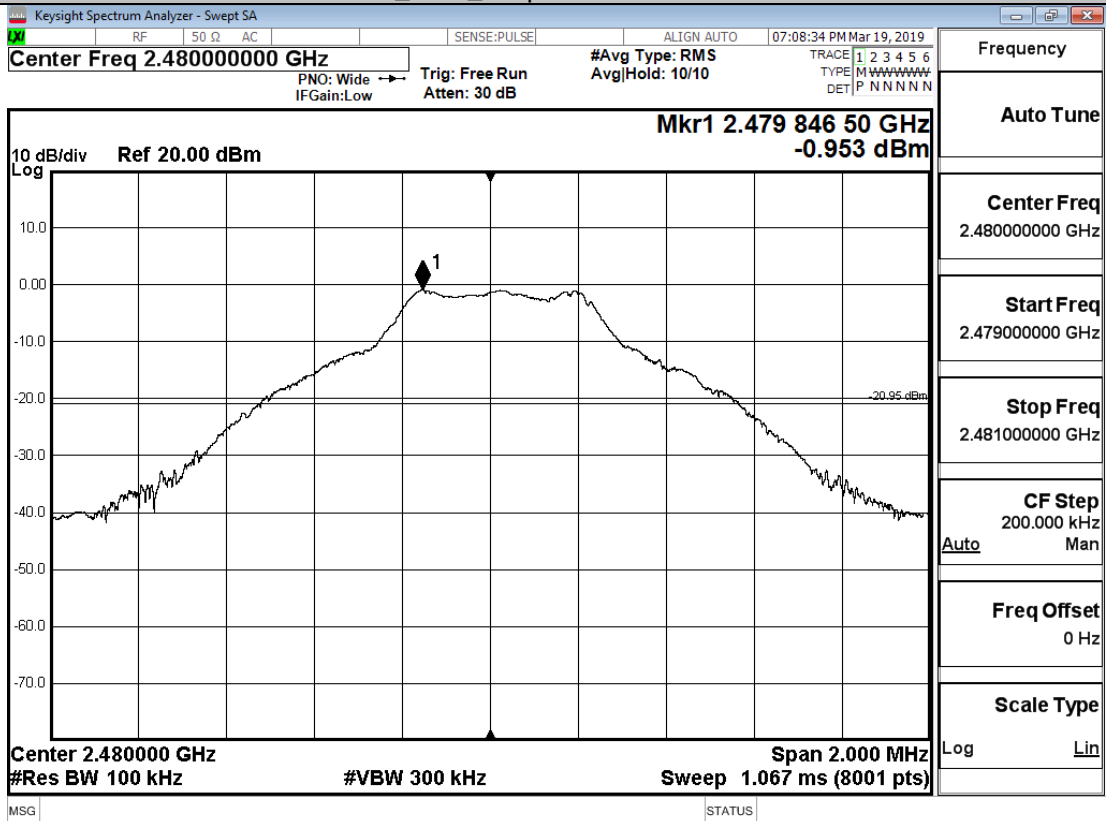

Puw

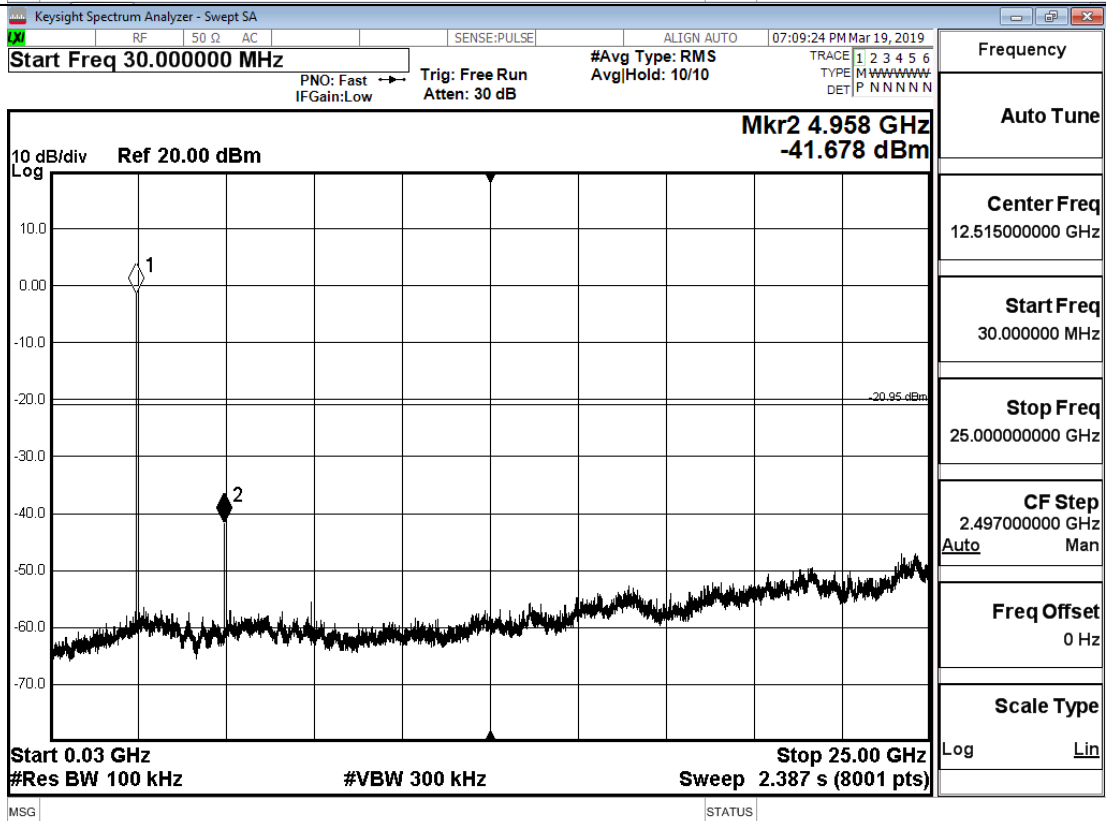

$\pi/4$ DQPSK_LCH_Graphs

Pref

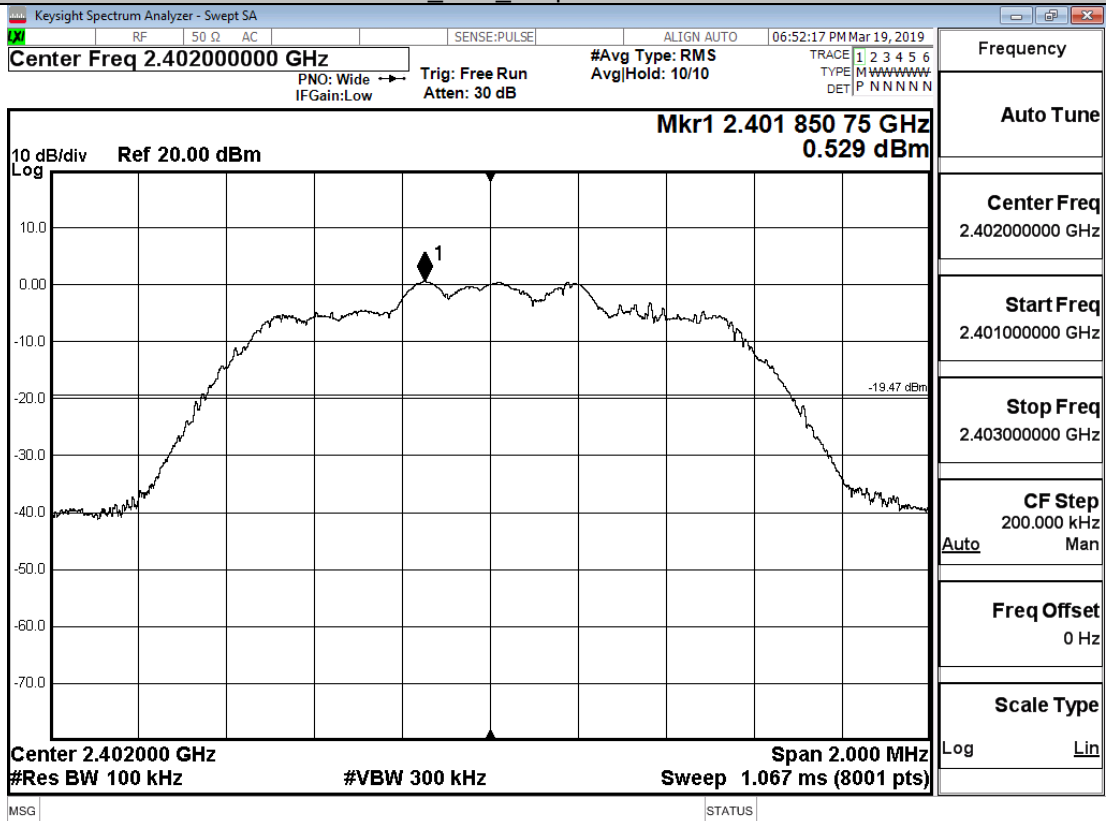

Puw

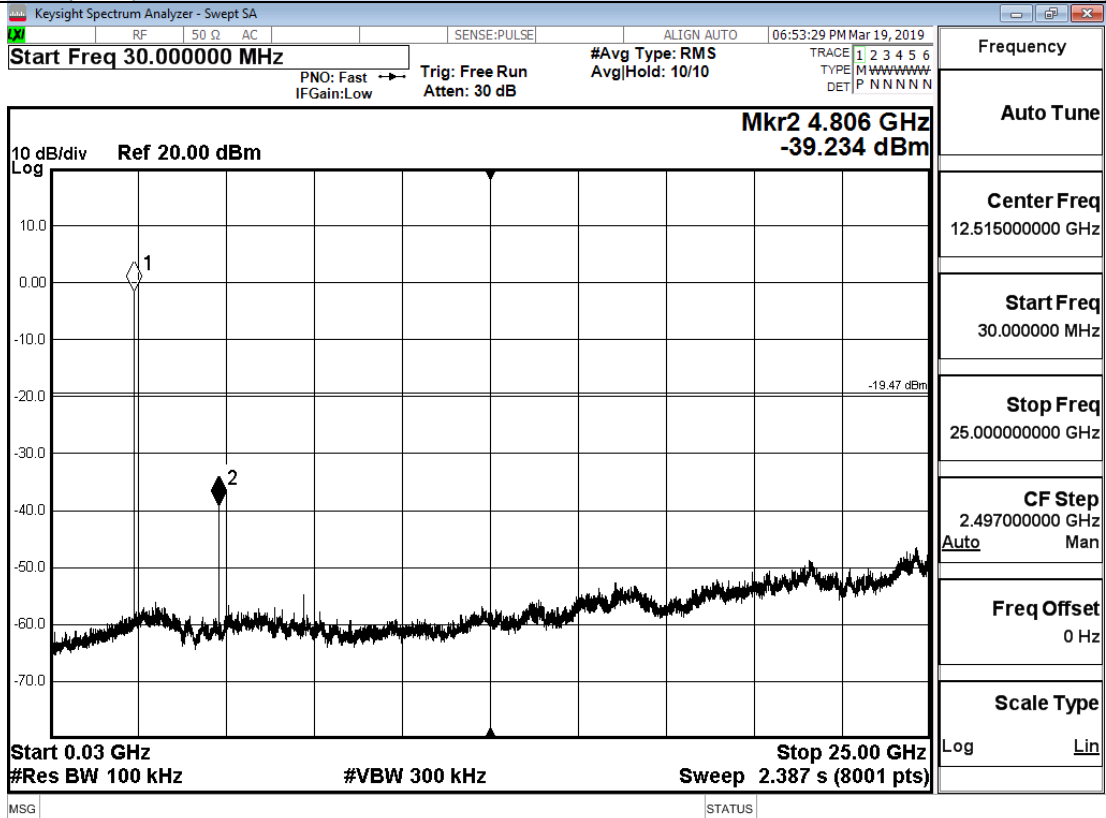

$\pi/4$ DQPSK_MCH_Graphs

Pref

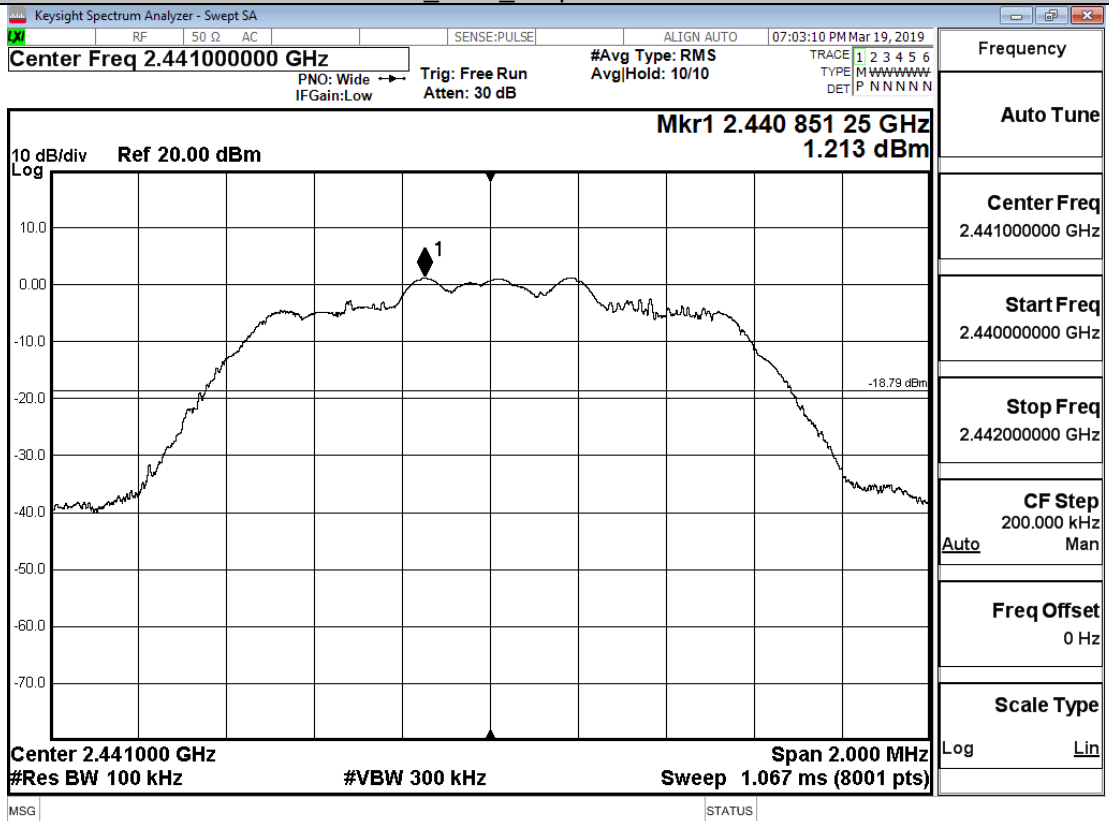

Puw

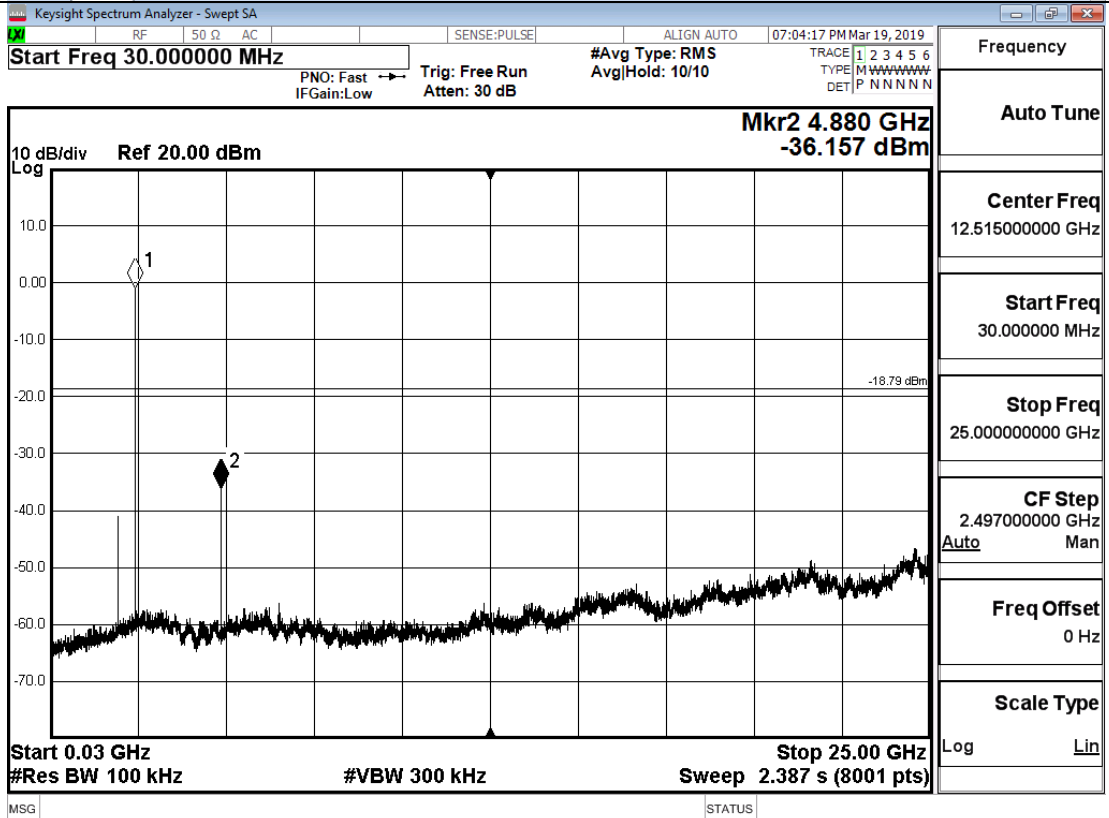

$\pi/4$ DQPSK_HCH_Graphs

Pref

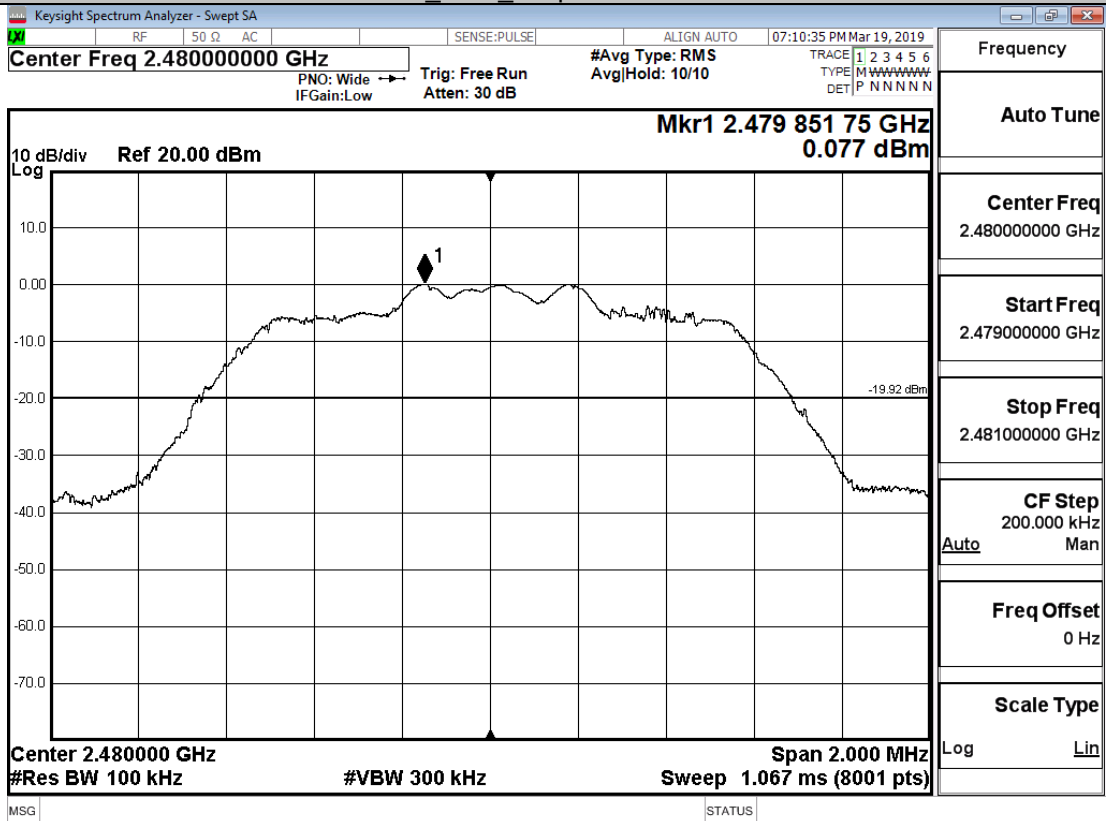

Puw

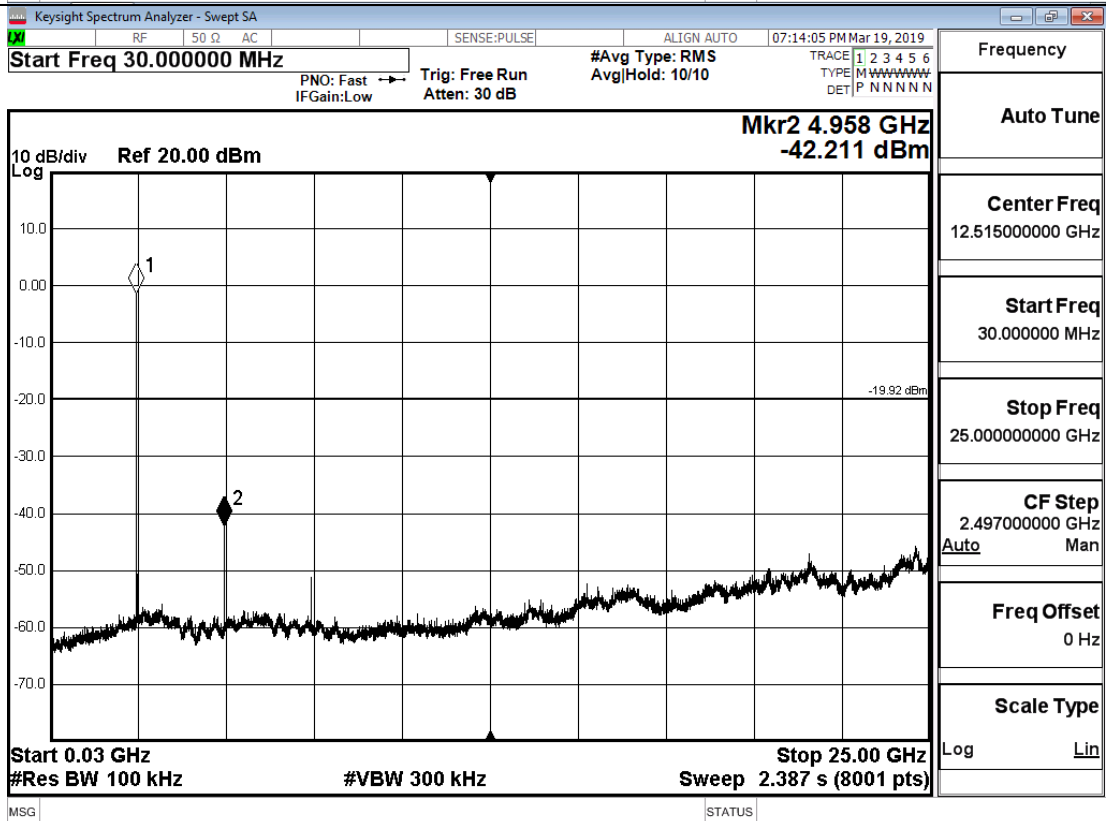

8DPSK_LCH_Graphs

Pref

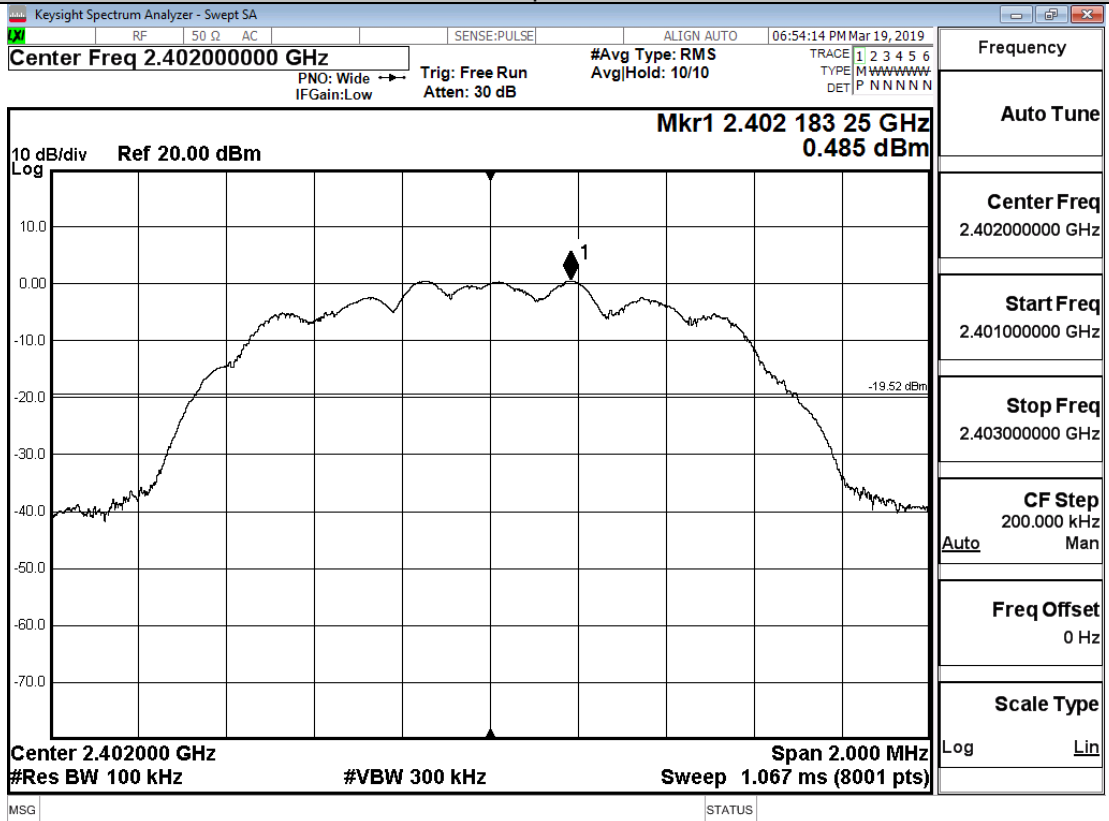

Puw

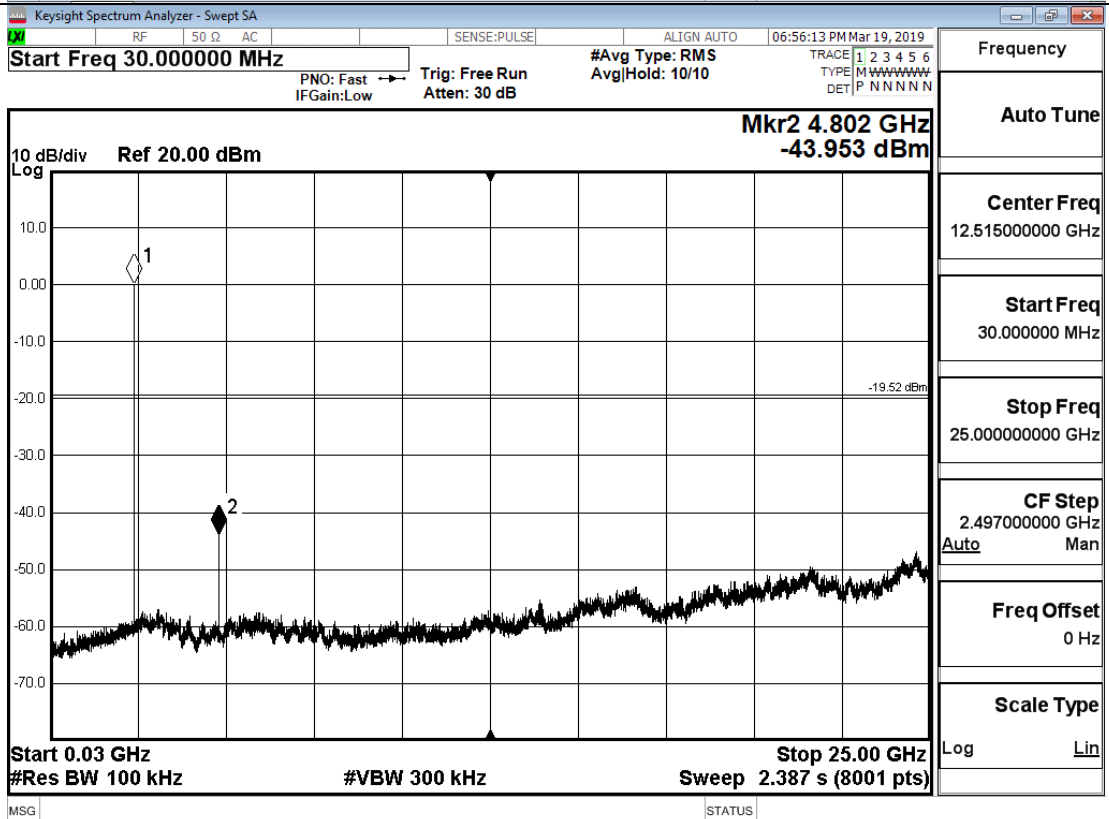

8DPSK_MCH_Graphs

Pref

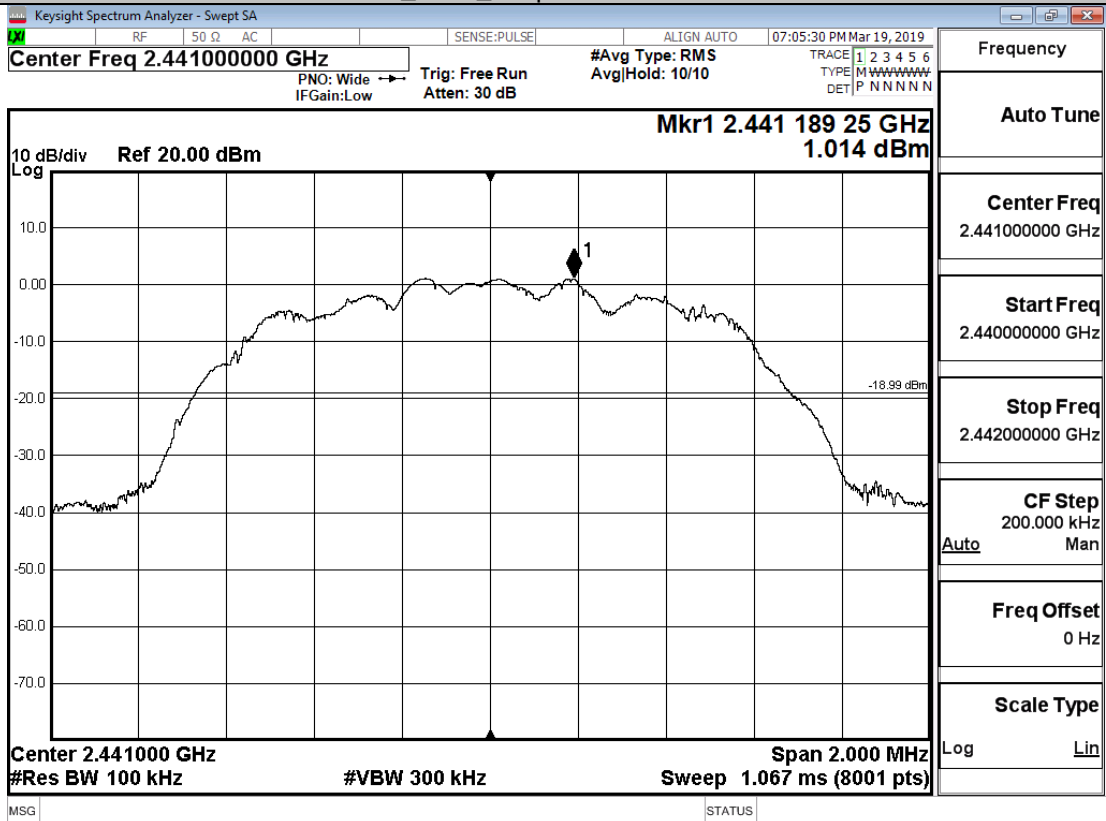

Puw

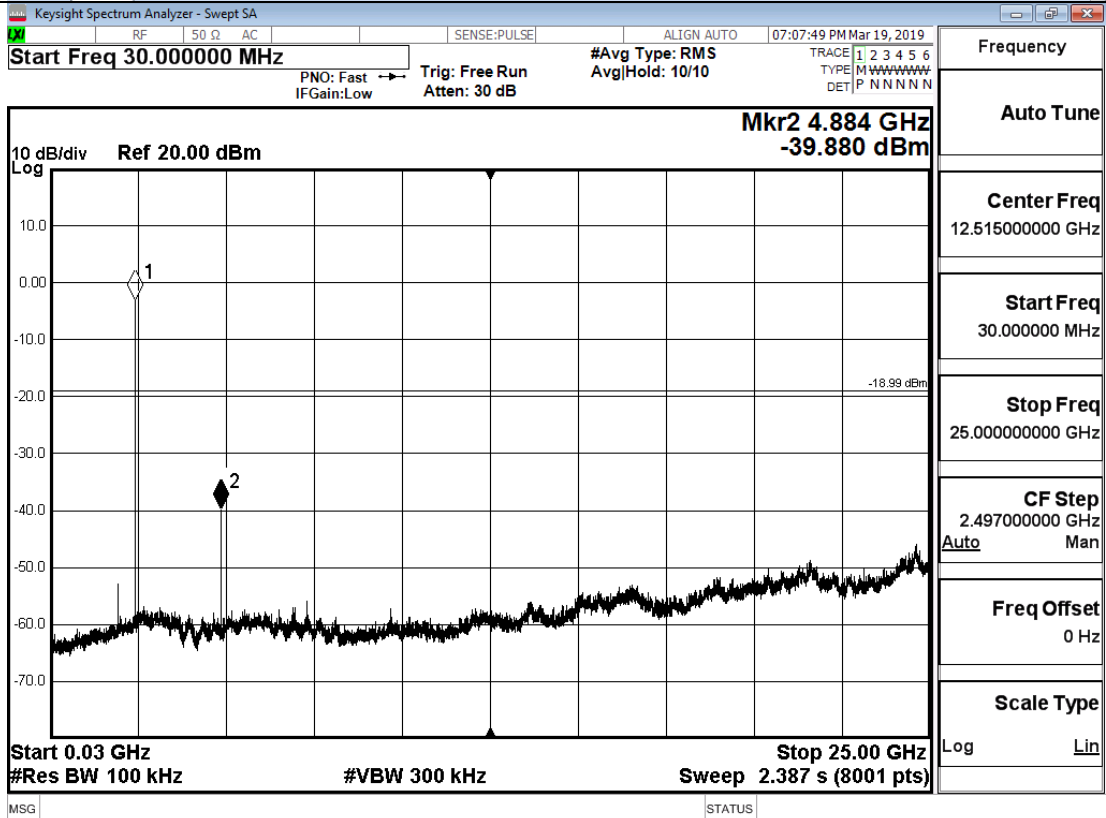

8DPSK_HCH_Graphs

Pref

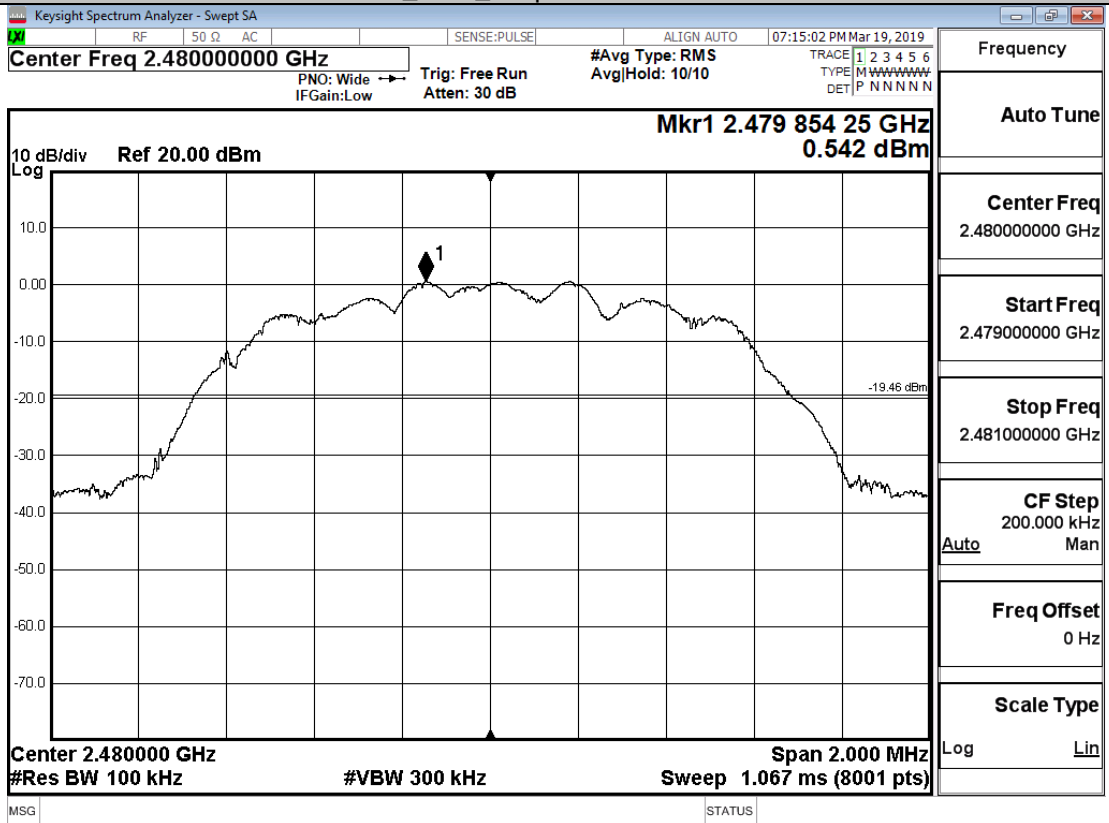

Puw

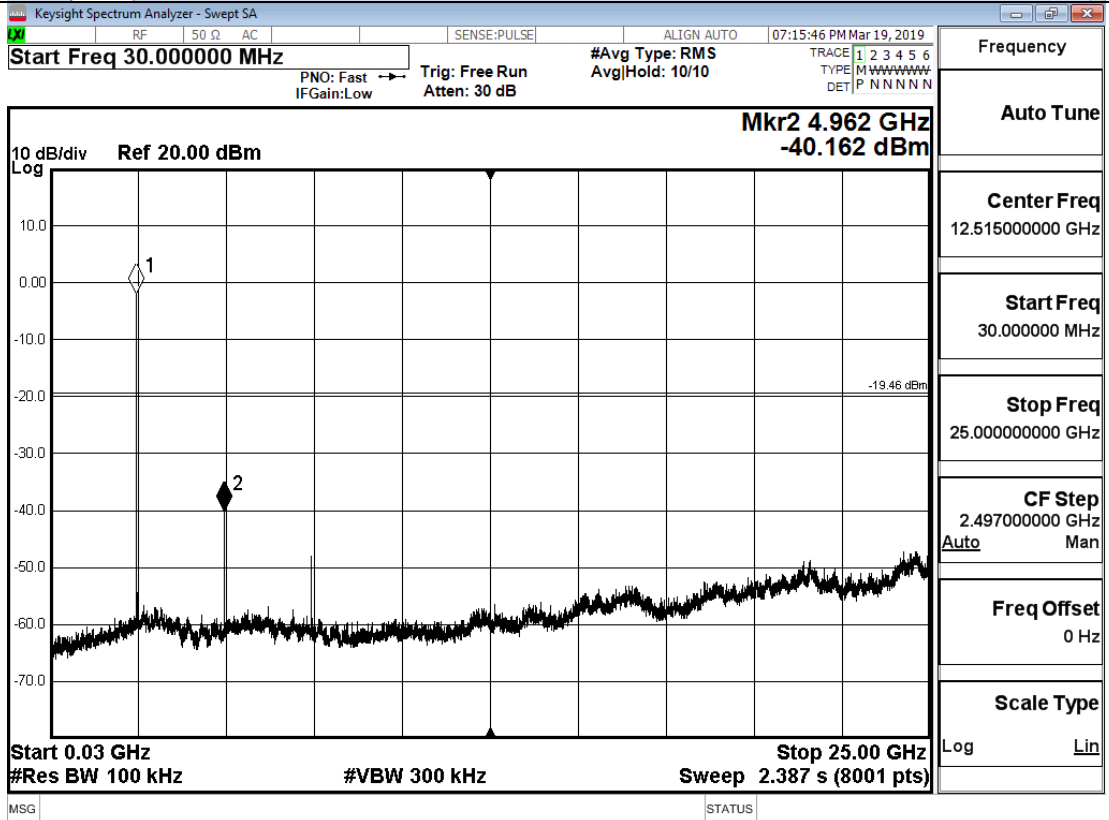

A.7 Band-edge for RF Conducted Emissions

Mode	Channel	Carrier Frequency [MHz]	Carrier Power [dBm]	Frequency Hopping	Max Spurious Level [dBm]	Limit [dBm]	Verdict
GFSK	LCH	2402	-0.210	Off	-59.344	-20.21	PASS
			0.094	On	-54.752	-19.91	PASS
	HCH	2480	1.767	Off	-54.383	-18.23	PASS
			1.750	On	-56.664	-18.25	PASS
$\pi/4$ DQPSK	LCH	2402	1.129	Off	-55.048	-18.87	PASS
			1.232	On	-54.269	-18.77	PASS
	HCH	2480	2.890	Off	-53.534	-17.11	PASS
			2.587	On	-57.846	-17.41	PASS
8DPSK	LCH	2402	1.133	Off	-56.772	-18.87	PASS
			1.017	On	-52.223	-18.98	PASS
	HCH	2480	2.825	Off	-52.569	-17.18	PASS
			2.455	On	-57.616	-17.55	PASS

Test Graphs

GFSK/LCH/No Hop

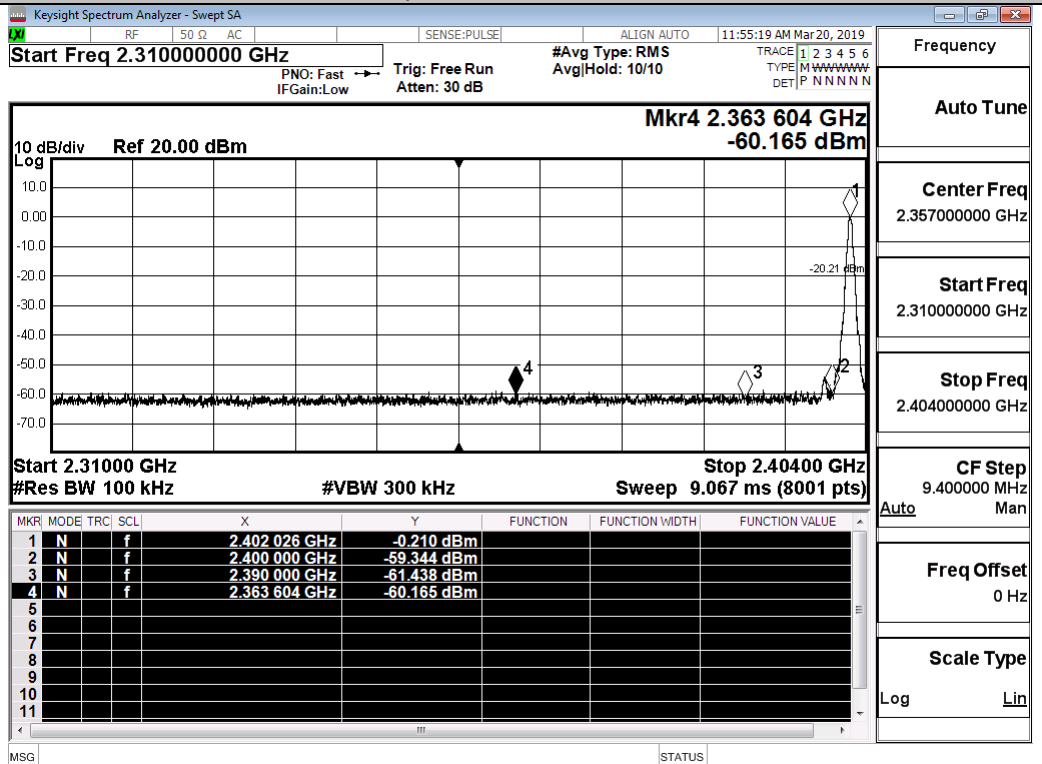

GFSK/LCH/Hop

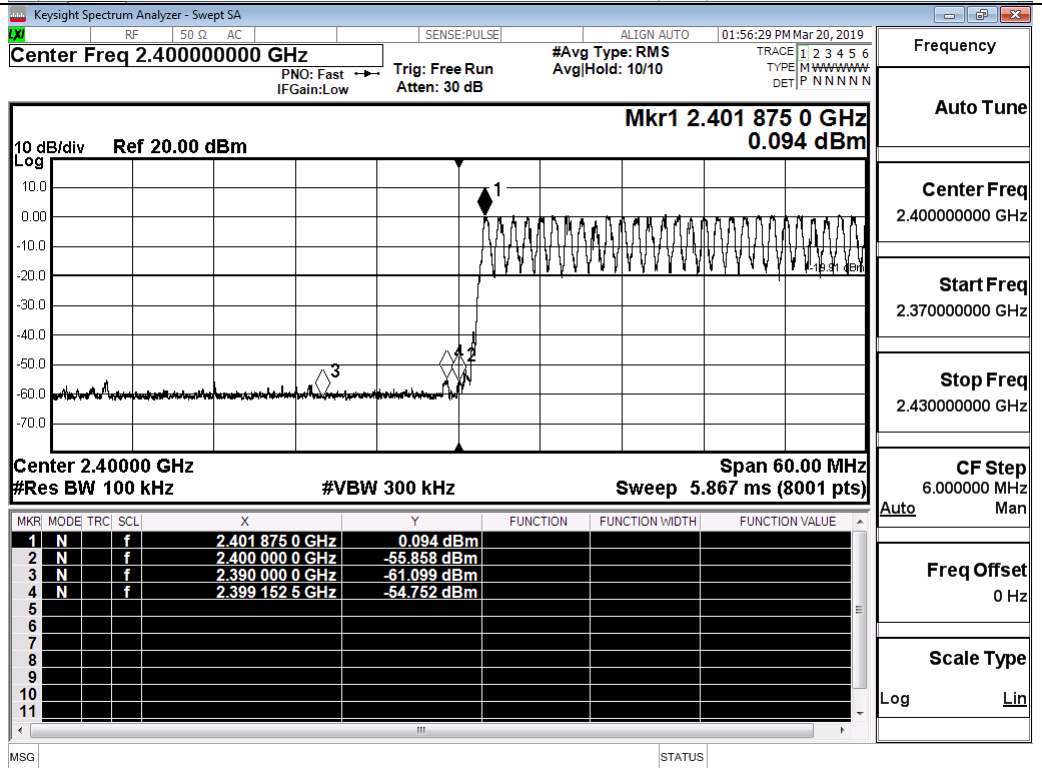

GFSK/HCH/No Hop

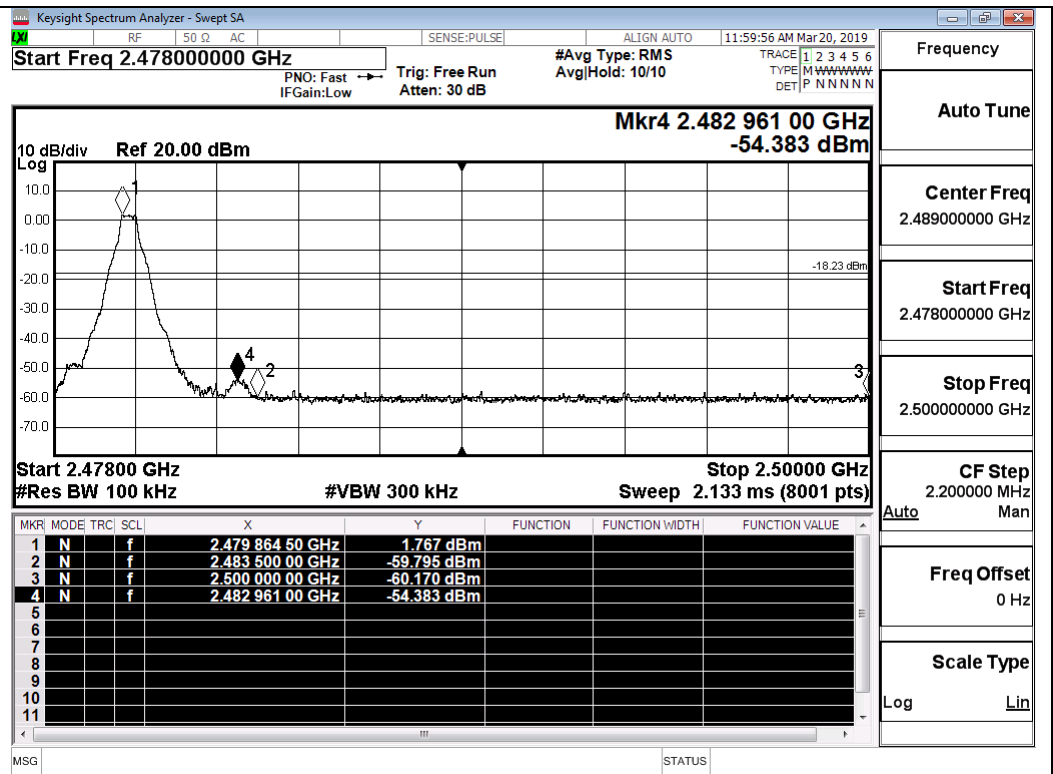

GFSK/HCH/Hop

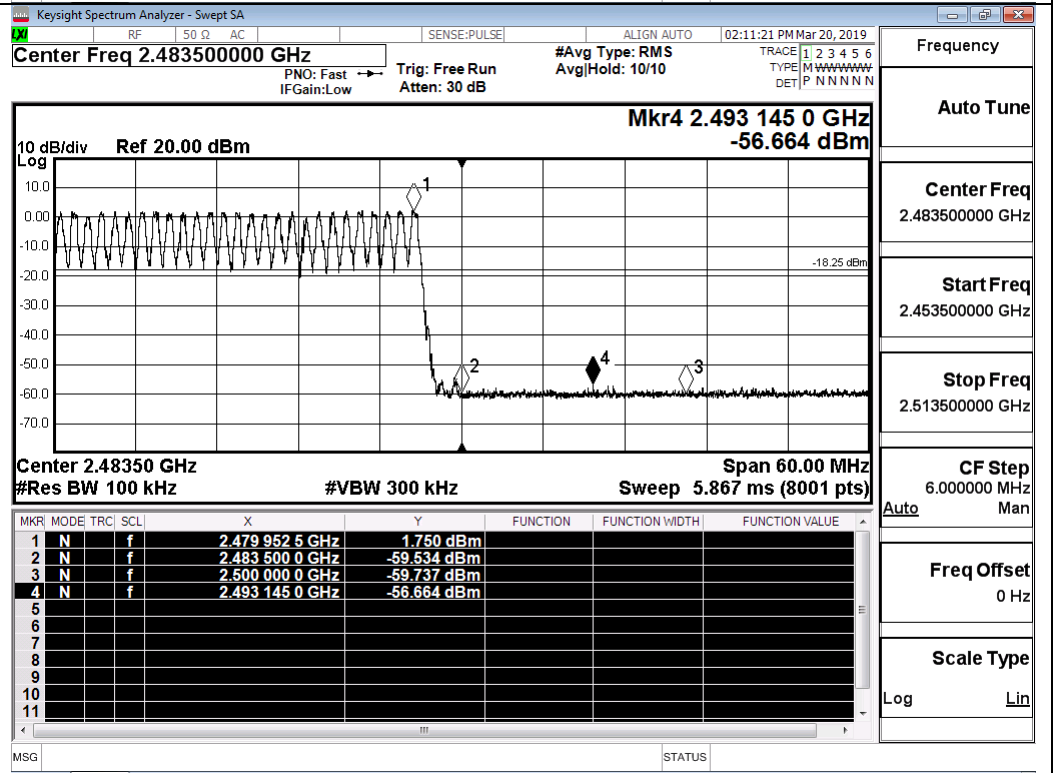

$\pi/4$ DQPSK/LCH/No
Hop

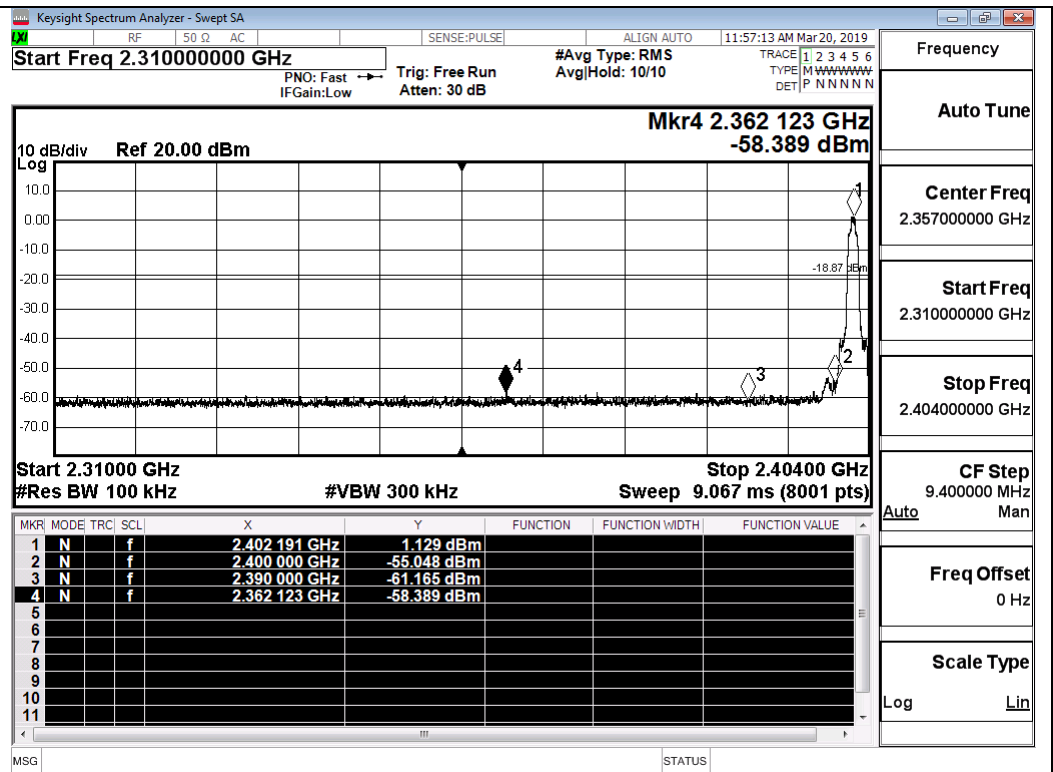

$\pi/4$ DQPSK/LCH/Hop

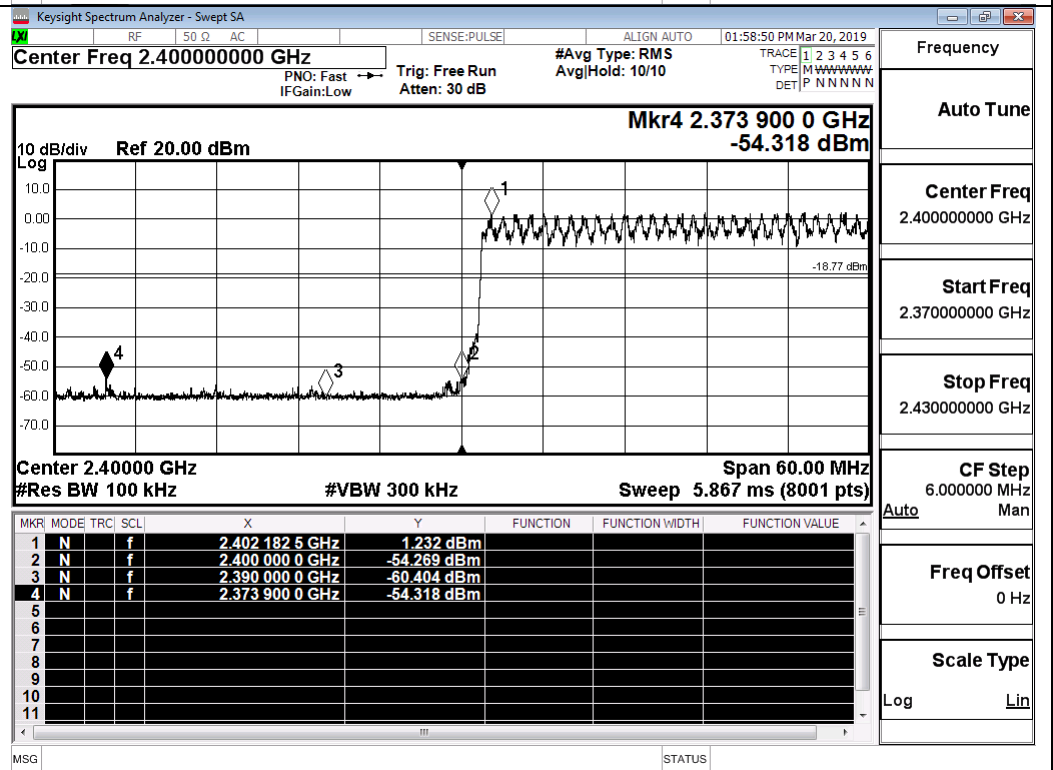

$\pi/4$ DQPSK/HCH/No Hop

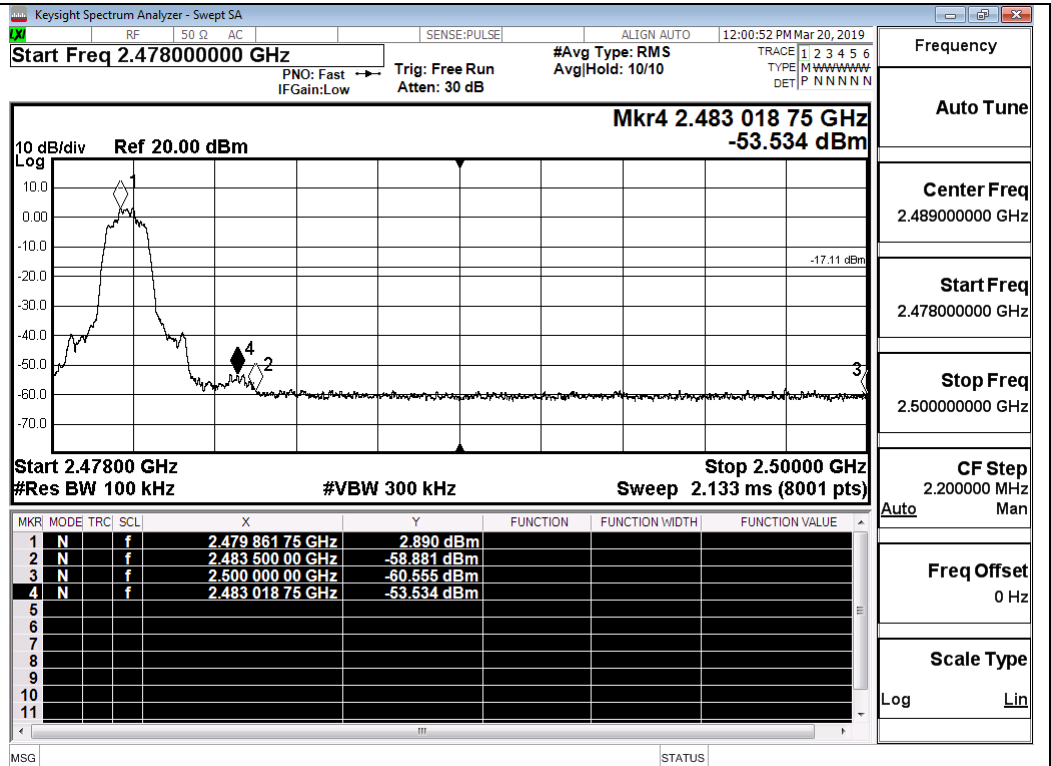

$\pi/4$ DQPSK/HCH/Hop

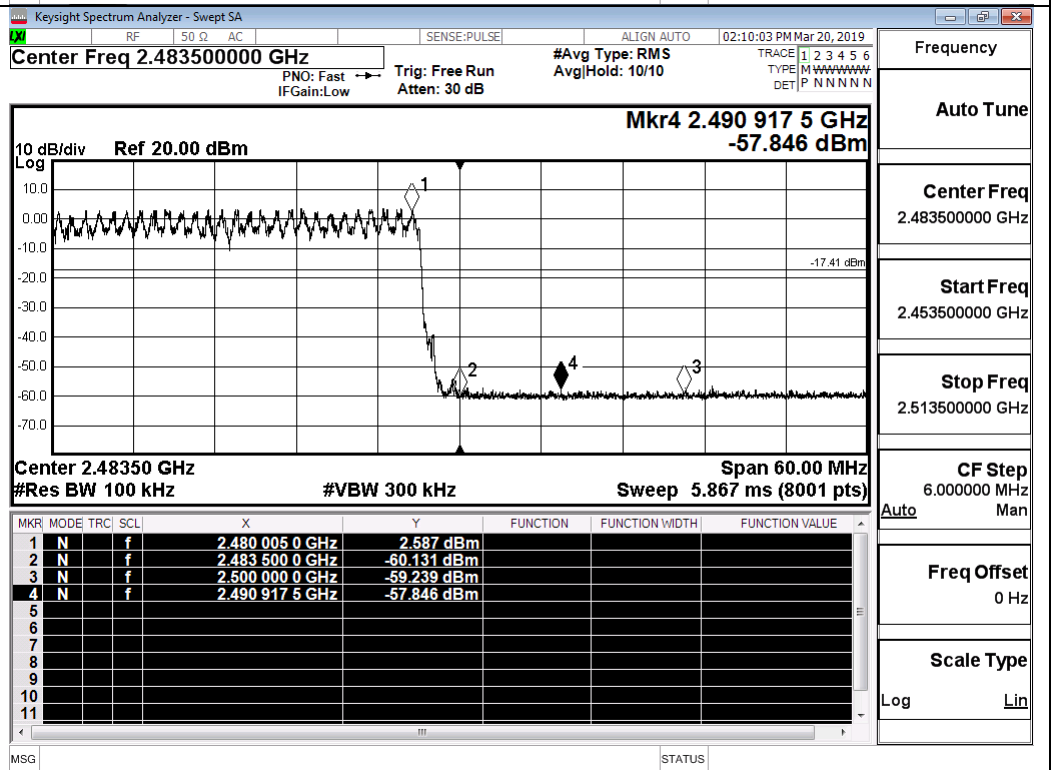

8DPSK/LCH/No Hop

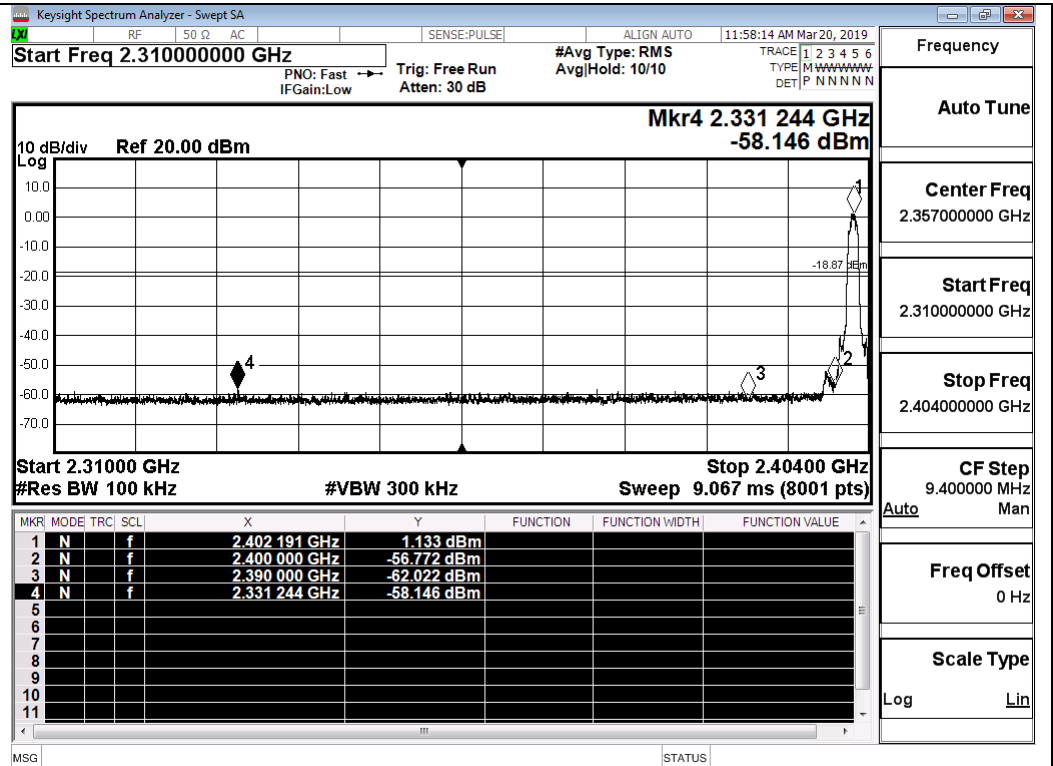

8DPSK/LCH/Hop

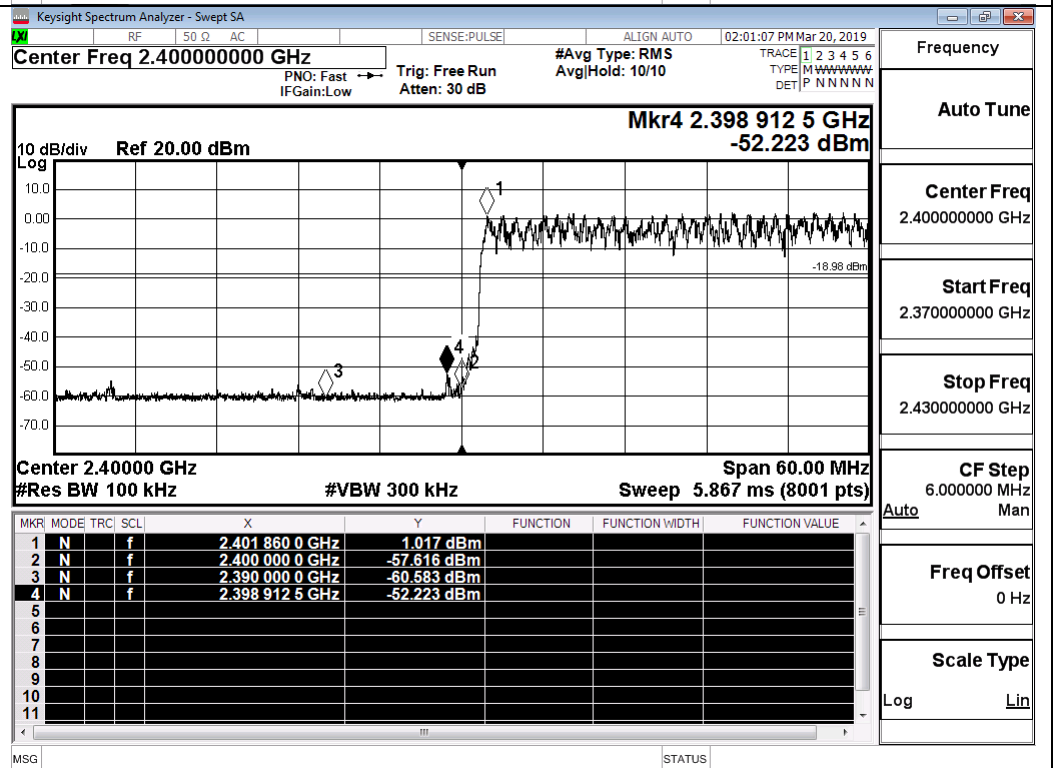

8DPSK/HCH/No Hop

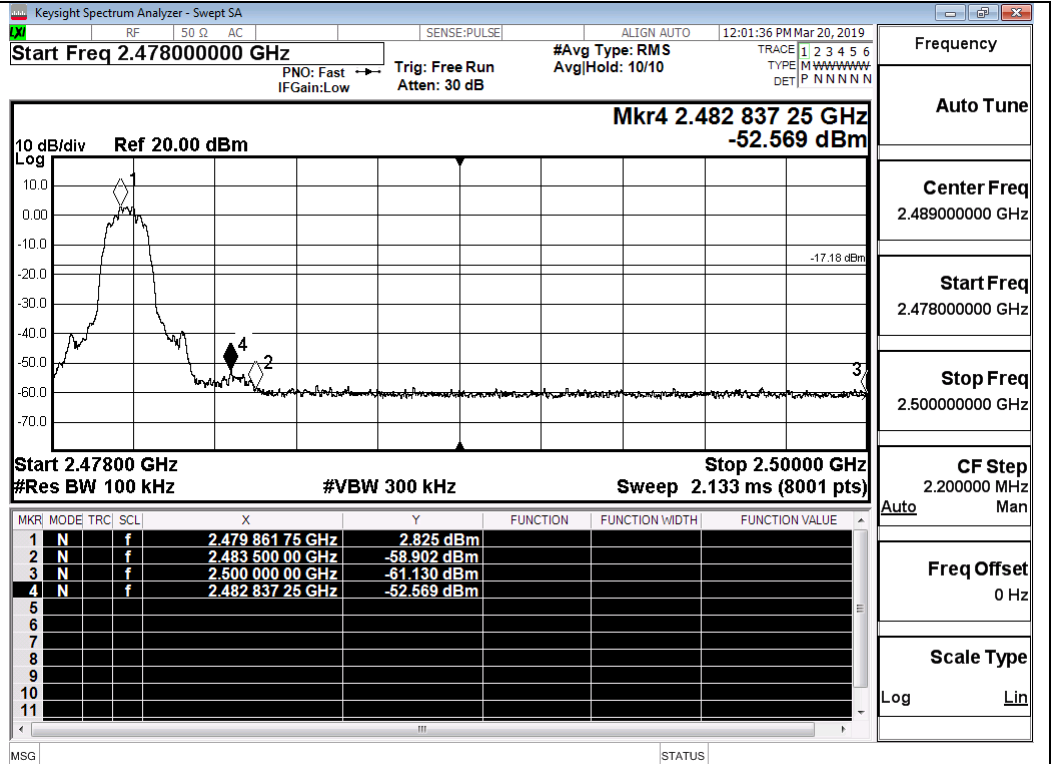

8DPSK/HCH/Hop

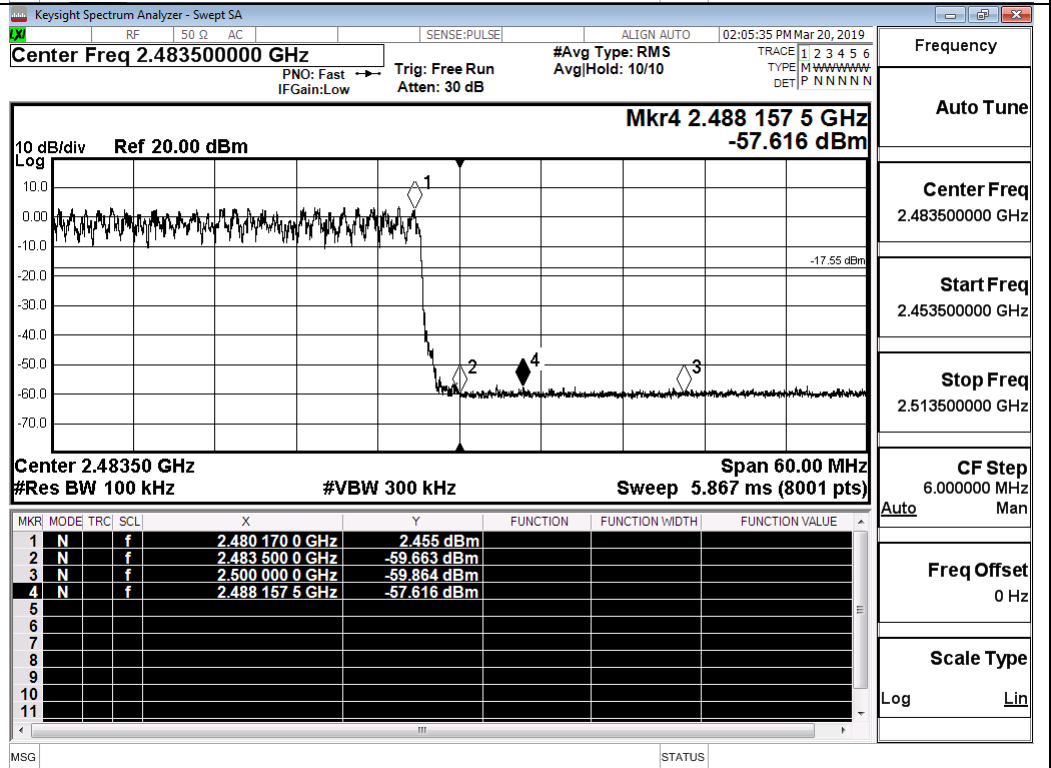

A.8 Restrict-band band-edge measurements

Test Mode	Hopping	Freq.	Power [dBm]	Gain	Ground Factor	E [dBuV/m]	Detector	Limit [dBuV/m]	Verdict
GFSK	Off	2310.0	-51.887	2.000	0	45.343	PEAK	54	PASS
	Off	2390.0	-51.522	2.000	0	45.708	PEAK	54	PASS
	Off	2483.5	-48.886	2.000	0	48.344	PEAK	54	PASS
	Off	2500.0	-50.460	2.000	0	46.770	PEAK	54	PASS
$\pi/4$ DQPSK	Off	2310.0	-52.006	2.000	0	45.224	PEAK	54	PASS
	Off	2390.0	-50.890	2.000	0	46.340	PEAK	54	PASS
	Off	2483.5	-47.466	2.000	0	49.764	PEAK	54	PASS
	Off	2500.0	-51.751	2.000	0	45.479	PEAK	54	PASS
8DPSK	Off	2310.0	-52.659	2.000	0	44.571	PEAK	54	PASS
	Off	2390.0	-51.689	2.000	0	45.541	PEAK	54	PASS
	Off	2483.5	-47.944	2.000	0	49.286	PEAK	54	PASS
	Off	2500.0	-51.206	2.000	0	46.024	PEAK	54	PASS

Restrict-band band-edge measurements_Hopping Off_GFSK_PEAK (Low Channel)

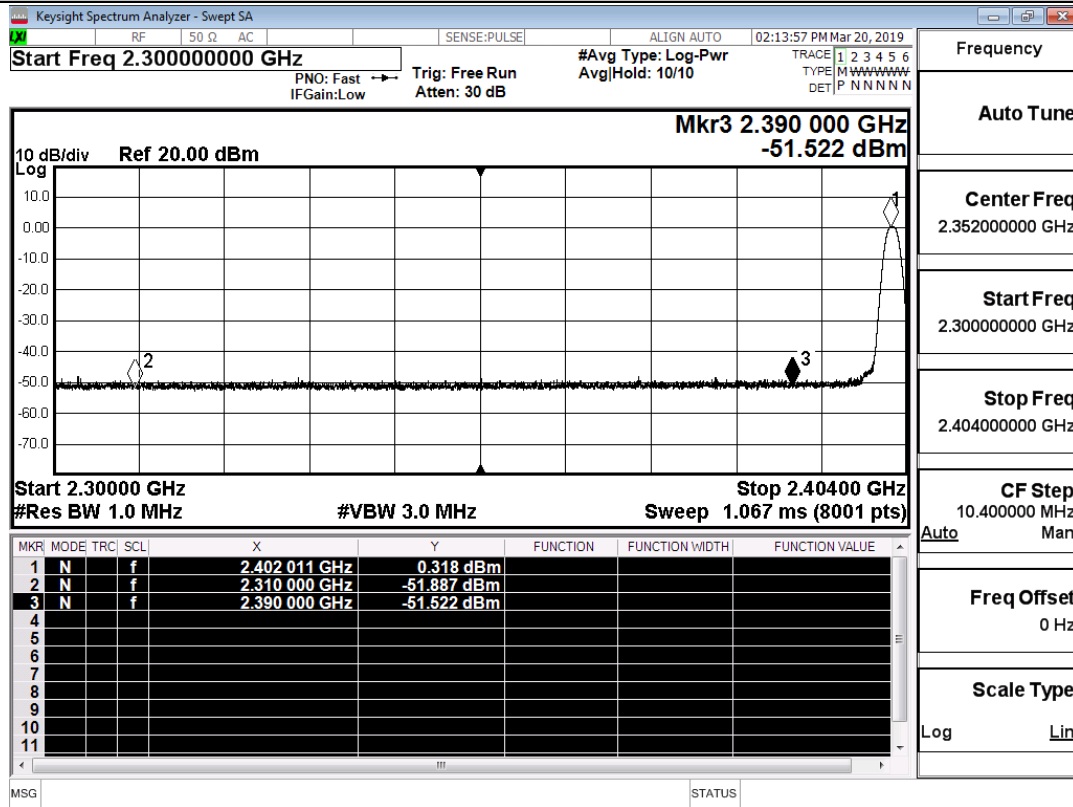

Restrict-band band-edge measurements_Hopping Off_GFSK_PEAK (High Channel)

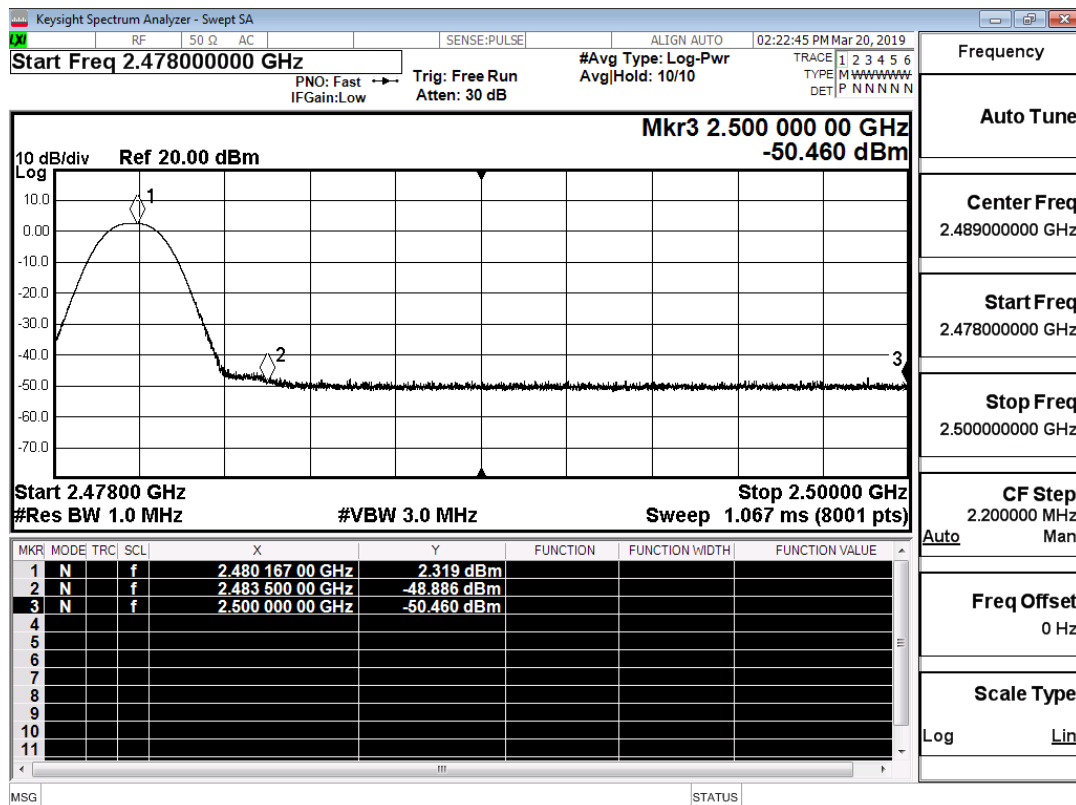

Restrict-band band-edge measurements_Hopping Off_π/4-DQPSK_PEAK (Low Channel)

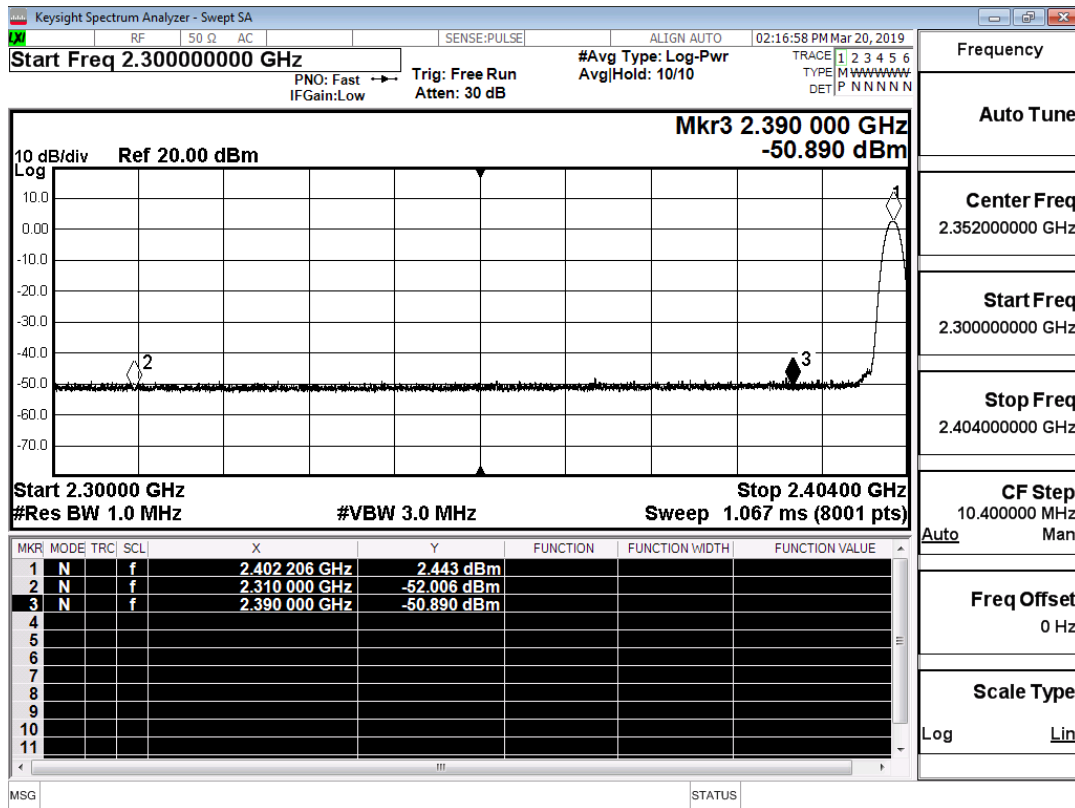

Restrict-band band-edge measurements_Hopping Off_π/4-DQPSK_PEAK (High Channel)

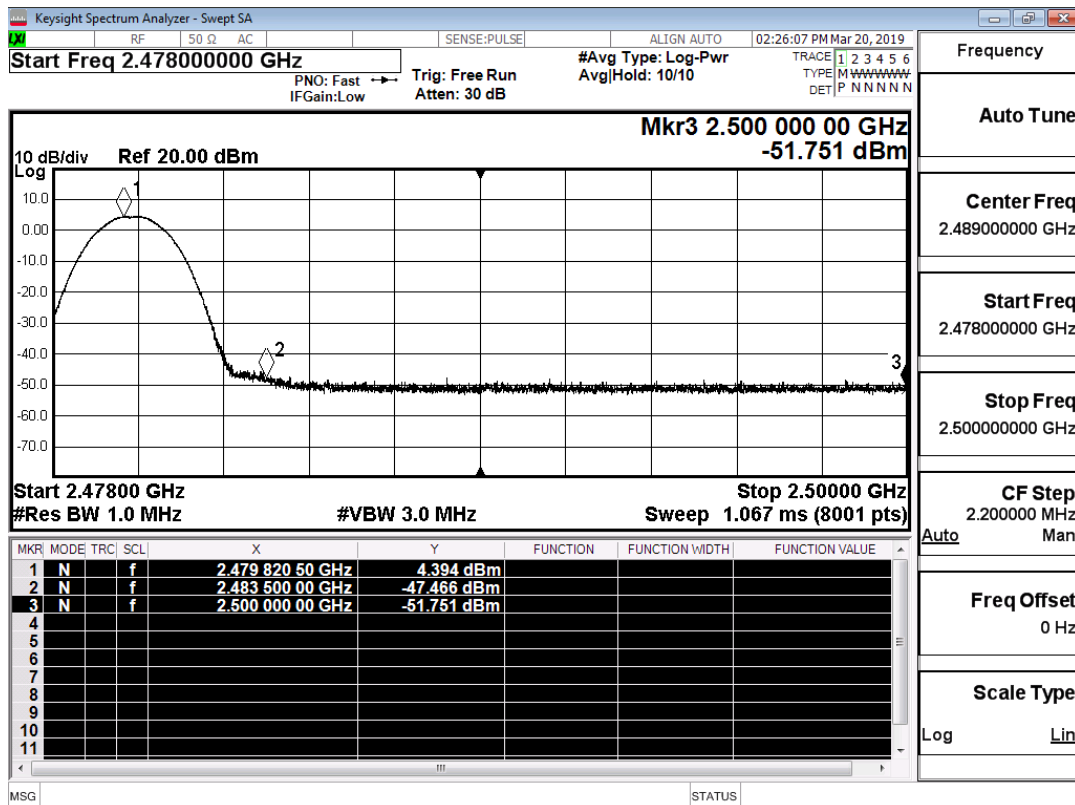

Restrict-band band-edge measurements_Hopping Off_8DPSK_PEAK (Low Channel)

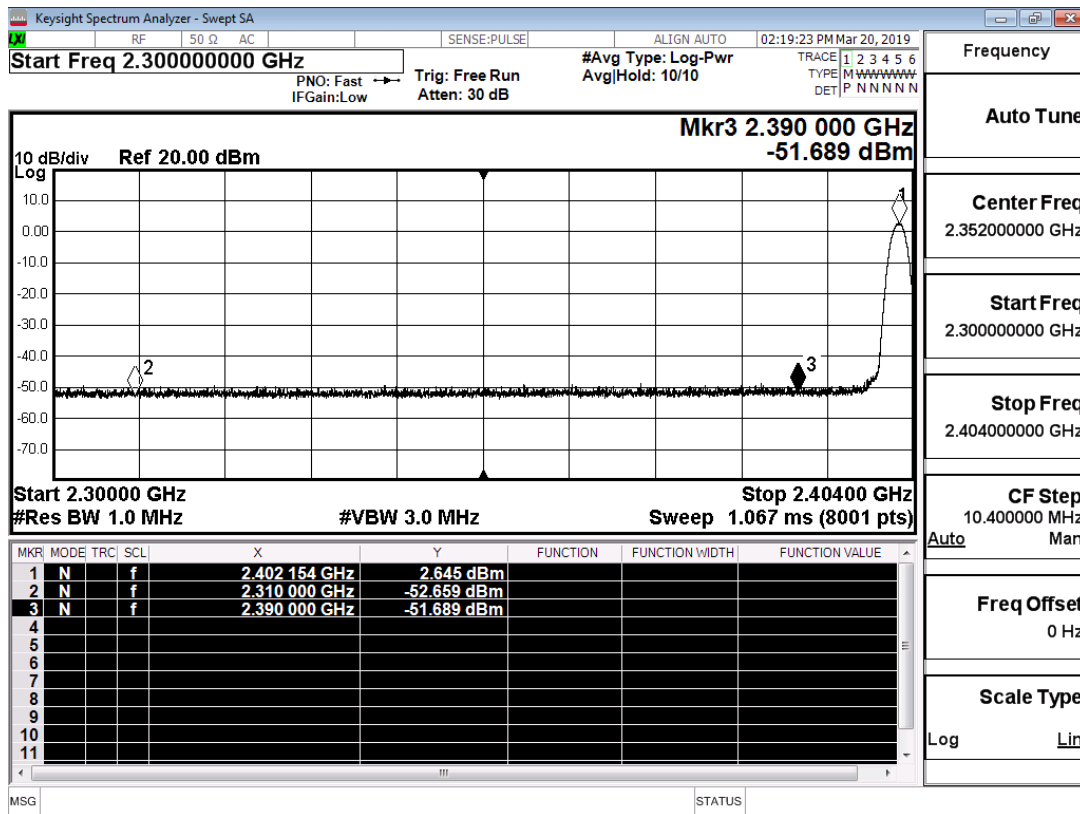

Restrict-band band-edge measurements_Hopping Off_8DPSK_PEAK (High Channel)

