

**S3**

**User's Manual**

Thanks for purchasing S3 wireless stereo bluetooth earbuds. This user guide will help you how to use this bluetooth earbuds rightly. Before using this products, pls be familiar with your mobile' s bluetooth function in advance in order to enjoy music and start your wonderful music journey.

## Safety Rules

1. For safety, we highly suggest read and comply with rules on this user manual carefully before use bluetooth earbuds.
2. Please be attention to avoiding possible damage like sharp edge scratch, non-smooth surface, metal parts, accessories and package
3. Please do not remove, repair this product, this may lead to fire, electronic breakdown or even thoroughly damage to this product, these are not in the warranty list.
4. Do not wipe the product with oil and other volatile liquids.
5. Please do not use this product in a dangerous place.

## Accessories List

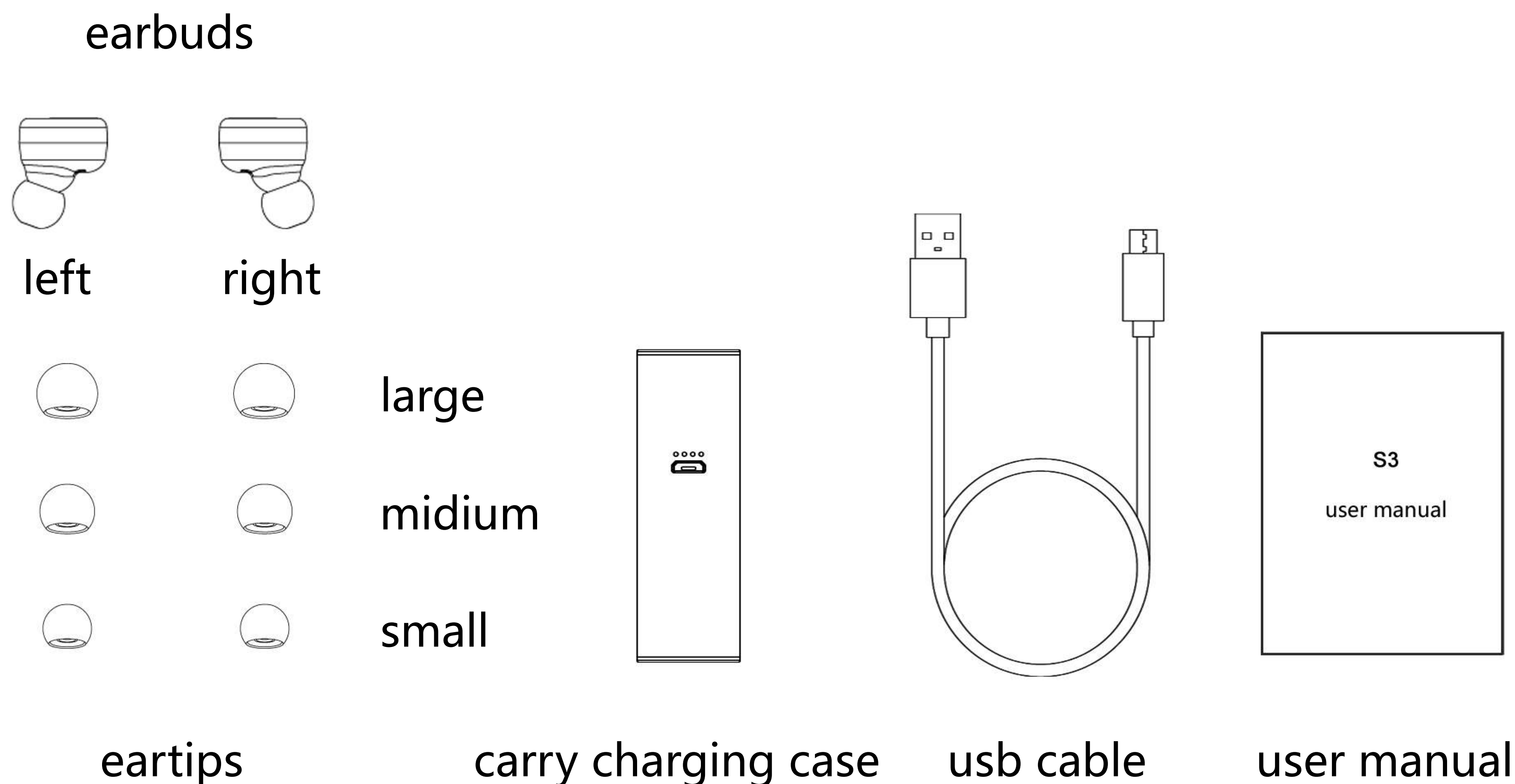

## diagrammatic presentation

- 1.Homekey
- 2.Earbuds indicator light
- 3.Microphone
- 4.Charging case indicator
- 5.USB input

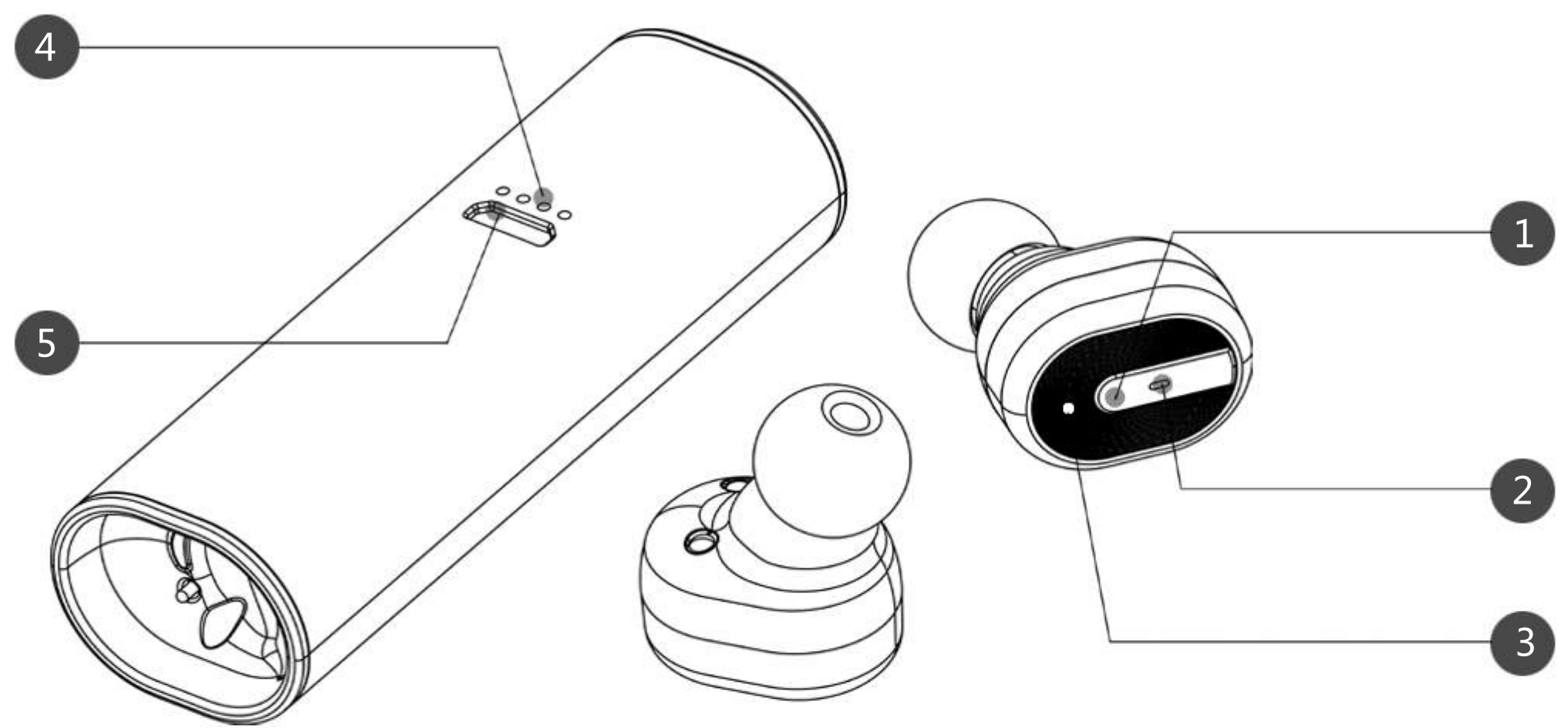

## adjustment

For the best audio experience, pls try each of the different sizes of eartips.choosing the right size will be more comfortable and not falling down.

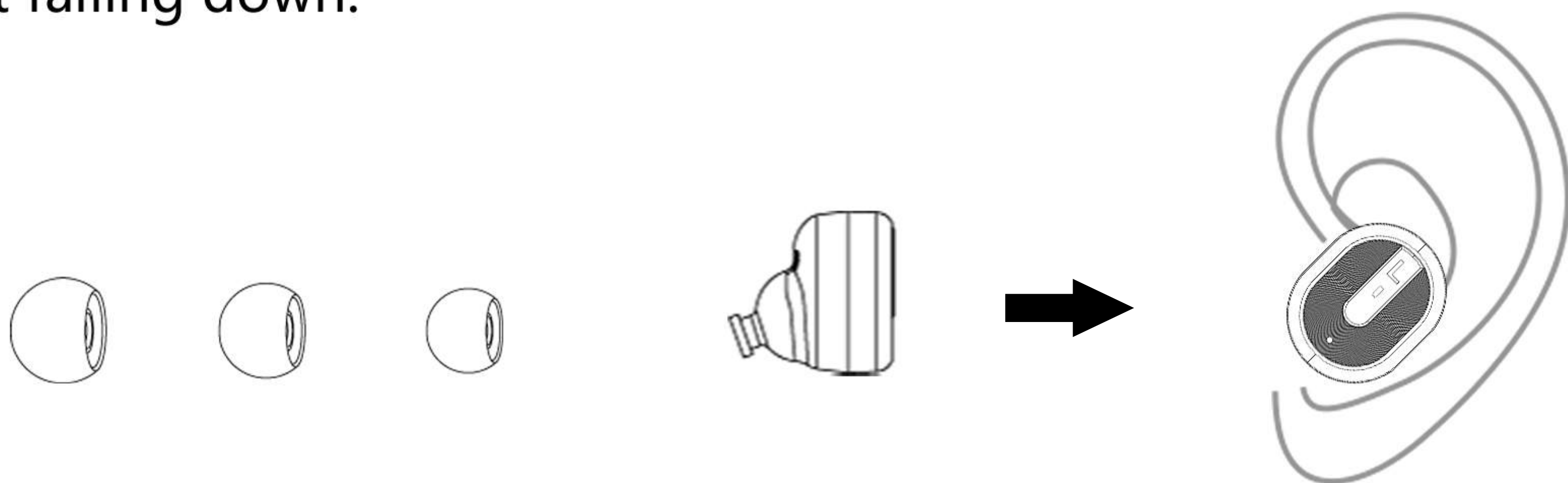

In order to get longer signal distance,pls keep the orientation like photo show when wearing ( round part on the homekey is directly toward themouth orientation).



## Earbuds Charging Usage

Pls full charging the carrying charging case and earbuds in advance.  
Magnetic charging: Red light will always on when charging; Red light to blue light for 5 seconds then light extinguished when full charge.



Carrying charging case can support charge two earbuds more than 2 time.

The carry charging case blue light turn off means two earbuds full battery.

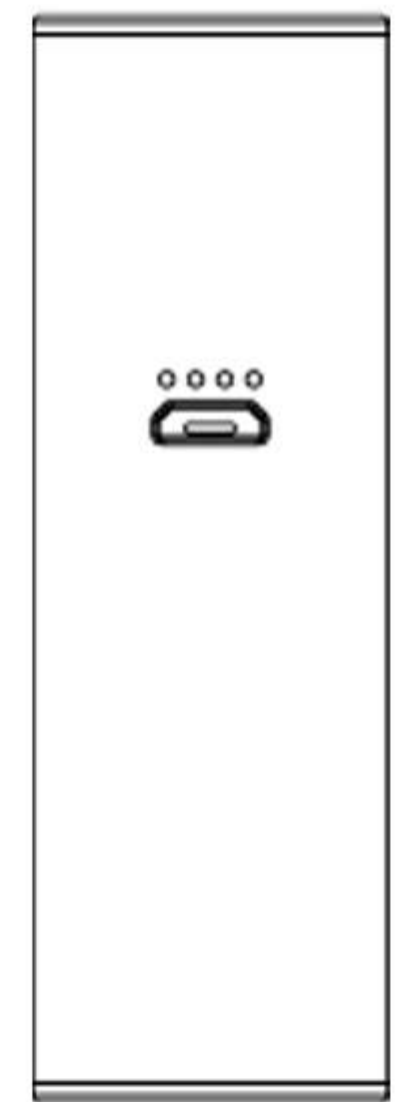
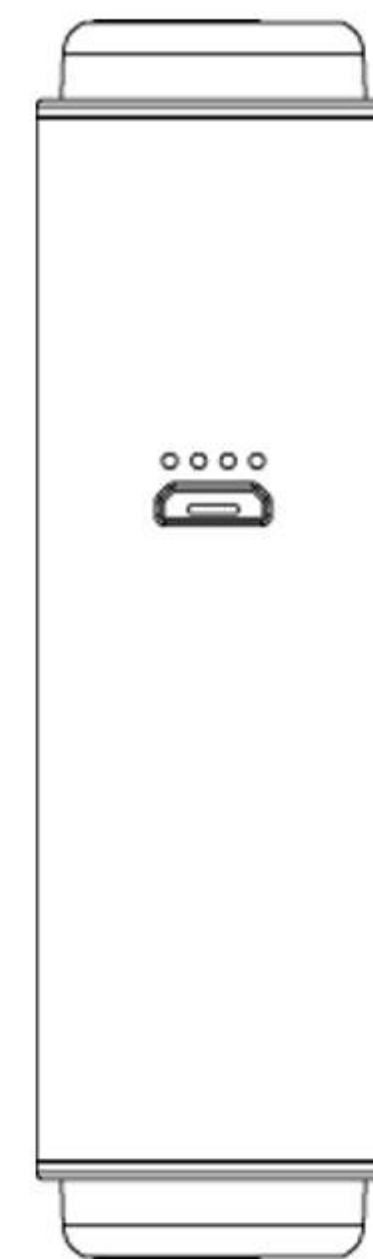

- PS :
- 1.Earbuds slowly flash LED blue light when playing music.
  - 2.Earbuds flash red light when power low.
  - 3.Earbuds will automatically turn off when charging.

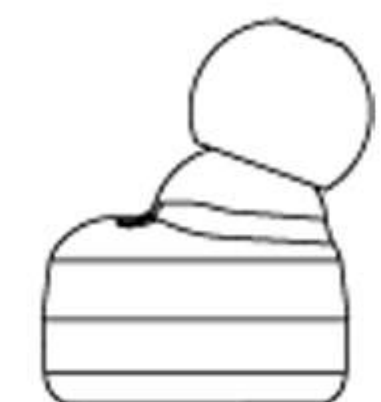

## Carry charging case instruction

Pls use usb cable to connect power adaptor or Mic-usb with laptop for charging carrying case.Indicator light: Four green indicator light quickly flash when charging;if four green light always on means full charge.

## use single earbud user instruction

### 1 turn on/turn off

Turn on: Hold the homekey for 3 seconds until you hear a voice prompt and LED blue light flash for turn on.

Turn off: Hold the homekey for 3 seconds until you hear a voice prompt and led turn red light about 1 second for turn off.

3 seconds

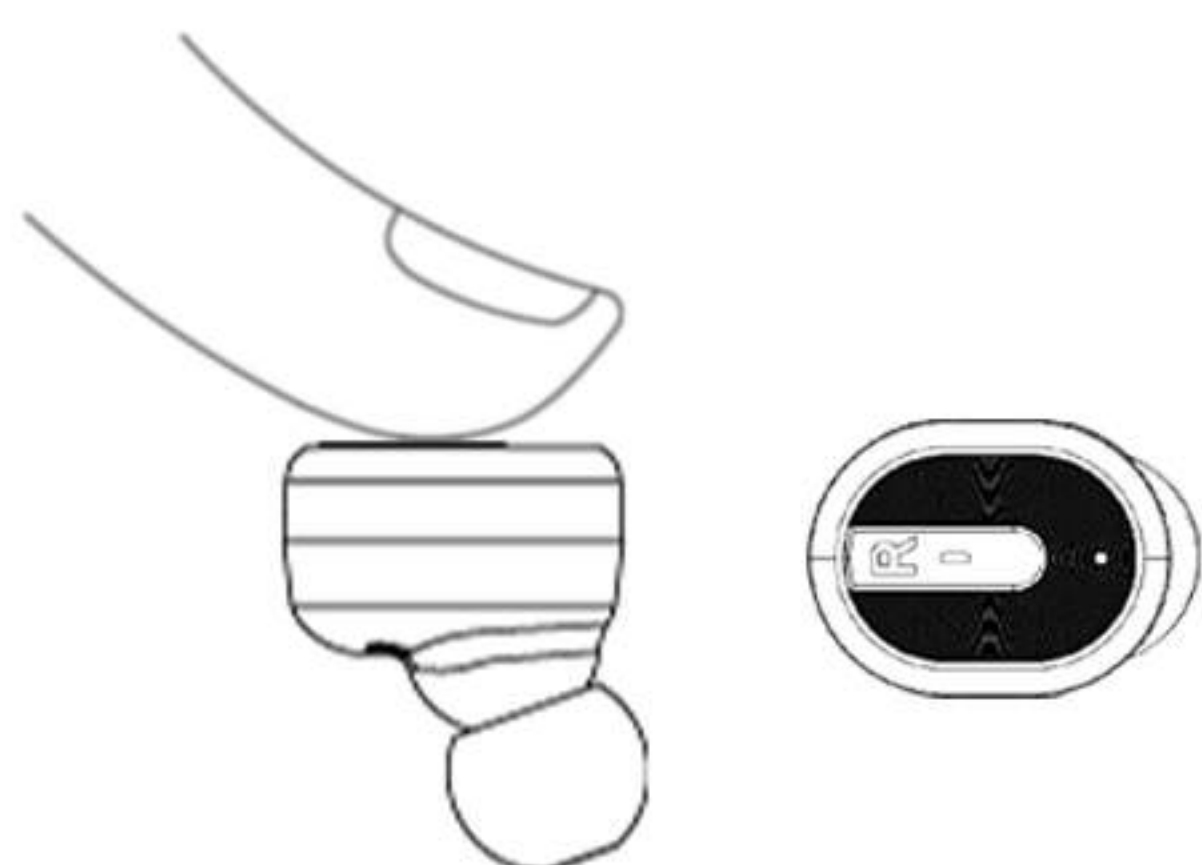

turn on

3 seconds

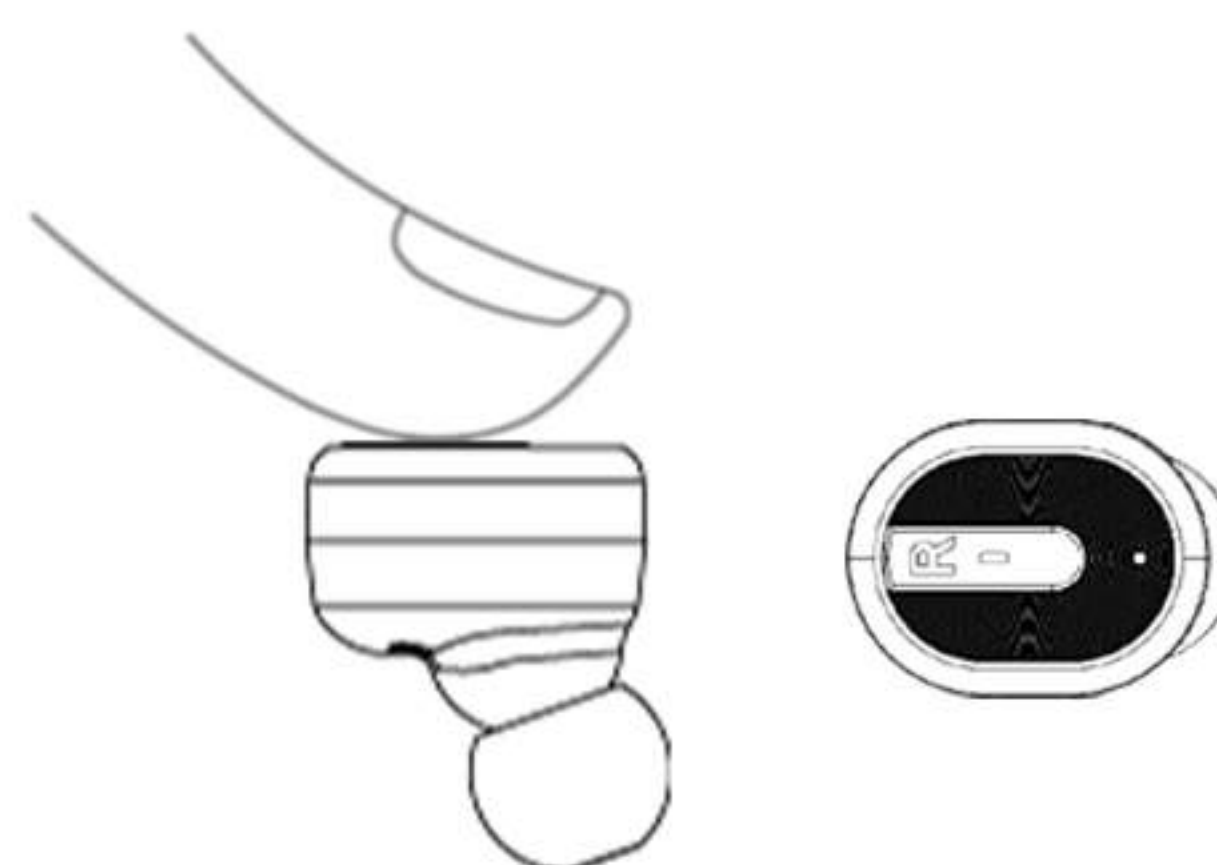

turn off

### 2 Device pairing: First connect

On the power off state, hold home key for 5 seconds and red blue light alternately flash. then, open mobile bluetooth function and search the device "S3" and click it to connect.

5 second

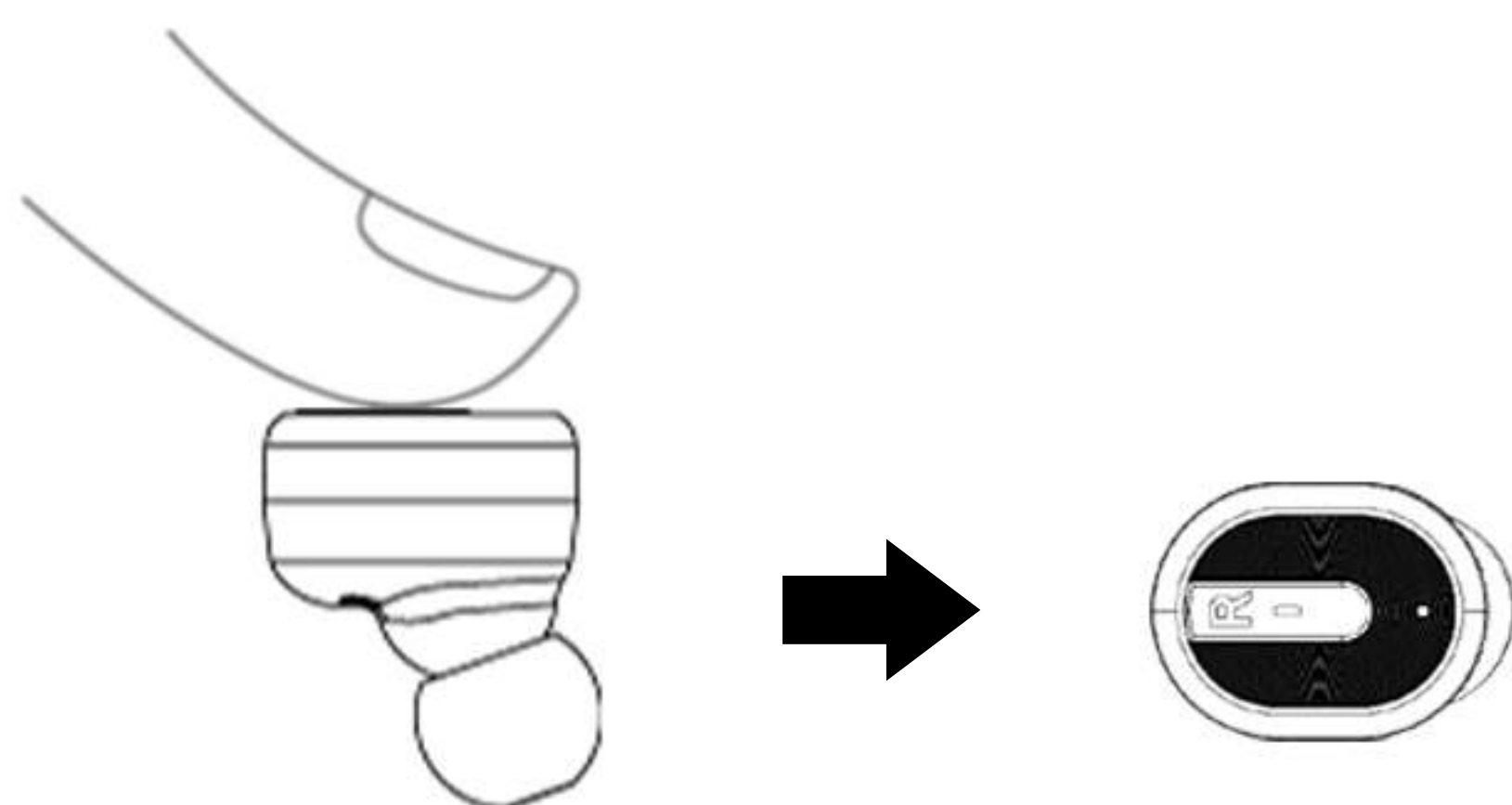

- 3 After pairing successfully, can choose listen music or calling, enjoy wireless audio experience
- 4 Answer call: click homekey during call income
- 5 Reject call : hold home key for 2 seconds during call income
- 6 Next track: on music playing state, double click home key into next song playing
- 7 Music Playing/Pause: single click home key to play or pause

#### two earbuds stereo sound instruction

#### 1 Turn on:

hold home key for 3 second untill hear a voice prompt and led blue light flash 3 second

3 second

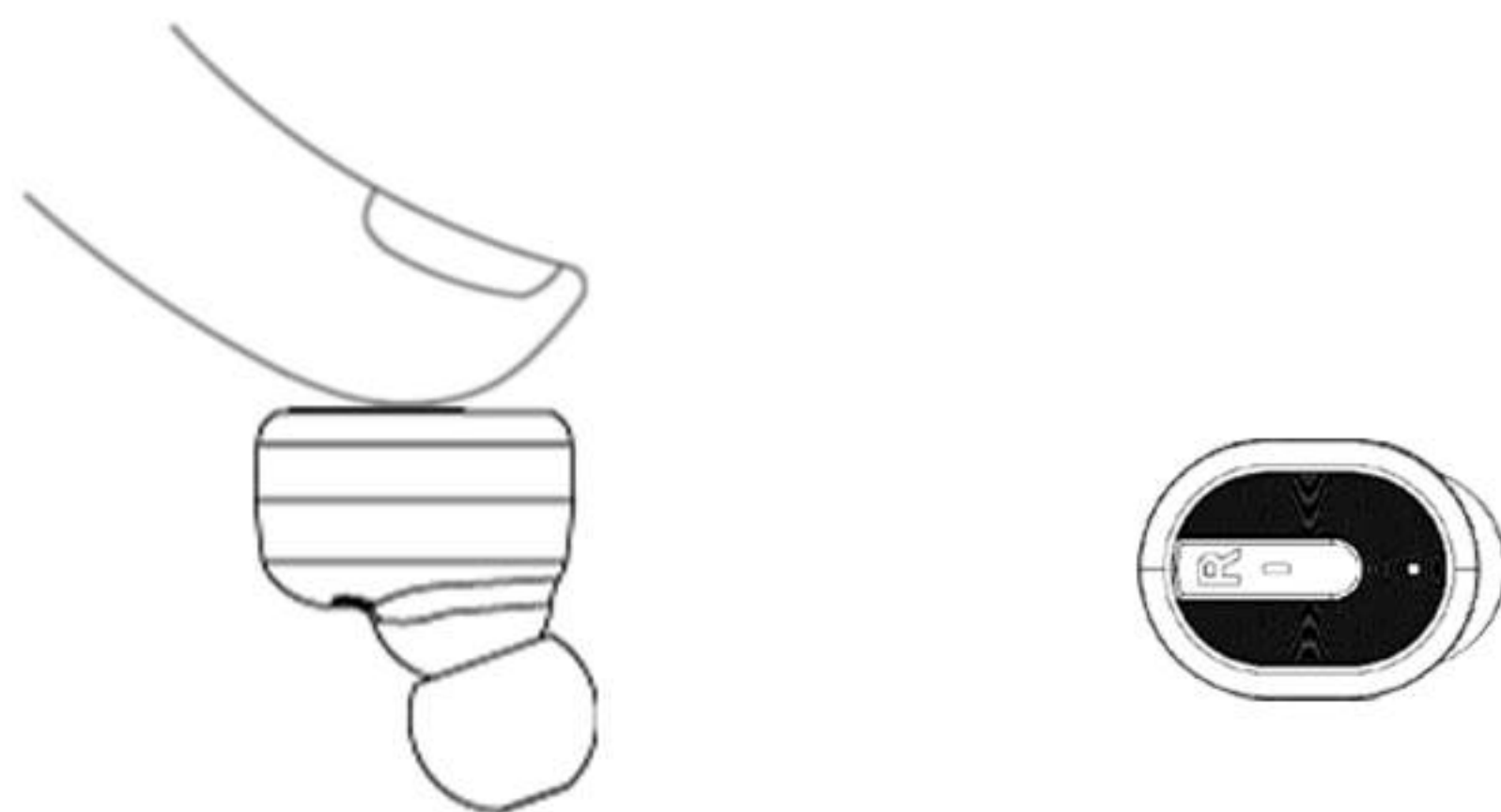

Turn on

## 2 Turn off:

click homekey of either earbud for 3 seconds until hear a voice prompt and red light gone.(when two earbuds pairing successfully on the turn on state,only use one earbud to turn off,the other one will automatically sync turn off).

## 3 device pairing: first use

- 1、 Hold two earbuds about 5 seconds on the power off state,then automatically into pairing state.Click either of each earbud into TWS function opening mode(no need two earbuds click), the click earbud will be connect and pairing with mobile.  
TWS earbuds pairing ok, the red light will be flash twice.

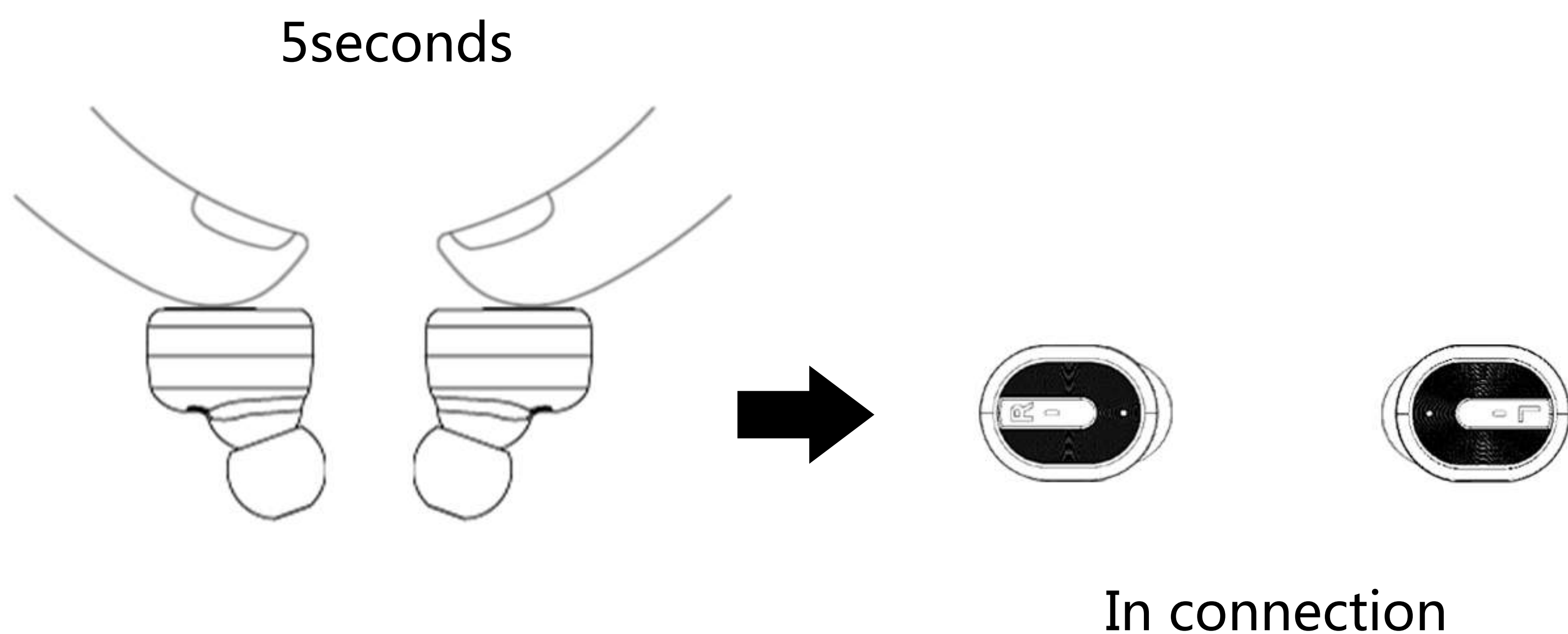

2、 Two earbuds will be automatically pairing.After left and right earbud connect,one earbud will flash blue light,another will alternately flash red and blue that be seted host earbud(Left channel earbud),at that time,the mobile will be find only one" S3" and connected.

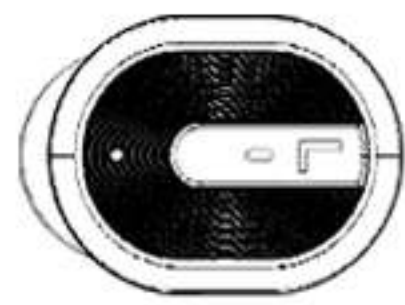

Host(Right)

Connection success



#### 4 searching and connecting

The host earbud alternately flash red blue light quickly,pls wait few second till the mobile only show one "S3" ,then click it and connect.



Host



Attention:Before two earbuds pairing,pls do not click any S3 on mobile,otherwise,cann' t achieve stereo function.



## 5 Pairing

After pairing okay, the host earbud will flash blue light, also the the same as vice earbud. Mobile only find one S3 means two earbuds paired and connected. (As long as successful paired earbuds and mobile, next time can automatically re-connect).



host earbud/right channel

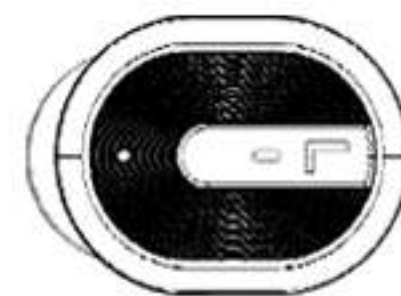

vice earbud/left channel

## 6 Calling

the host earbud button is valid when calling (with a call tone), and only the host earbud can call

**Answer / end call:** short press the homekey to answer the call; short press homekey to hang up the call.

**Rejected calls:** long press the homekey about 2 seconds to refuse call.

## 7 music playing

**Music play:** short press either of two earbud to play music.

**Music pause:** short press either of two earbud to pause music on playing mode.

**Next Track:** double click homekey into next song when playing.

## Precautions

1. Mobile can't search earbuds bluetooth name if earbuds not into pairing state, pls confirm it into pairing mode (red blue light alternately flash) before use mobile searching.
2. If earbuds can't find the pairing device about 5 minutes, it will shut down automatically.

## tips

Must choose the regular charger with certification to charging (pls charge it again over 3 month no use).

## warning

1. Do not place it in a low or too high temperature (0 °C or more above 40° C better). Extreme temperature will cause deformation, reduce charging capacity, and shorten the service life.
2. Do not use this products in thunderstorms because easy increase the risk of products failure and electric shock.
3. Do not disassemble or modify this products for any reason, otherwise may cause earbuds to damage or burn. Please send it to an authorized service center for repairing immediately.
4. Please place this products and accessories beyond children and pets reach, otherwise, swallowing small accessories may cause suffocation and serious consequences.
5. Do not put it under water.

## specification

	item	parameter
earbud	battery	lithium polymer 45mah
	bluetooth version	V 4.2
	working voltage	3.2V-4.2V
	Microphone sensitivity	-40±2db
	bluetooth frequency	2.4-2.48GHZ
	bluetooth distance	10M
	bluetooth protocol	A2DP/HFP/HSP/AVRCP
carrying	battery	400mAh
charging case	output voltage	DC5V
	MAX output current	1A
	charging voltage	DC5V
	MAX charging current	1A

Certification:FCC/CE/ROHS

## Regular problems and solutions

Problems description	Cause	Solution
Can not Start	The power used up	Charge the battery fully before use
	Press home button too short	Press the home key for 3 seconds to re-start the headset
Can not charge	Plug is not placed well	Check the plug well
Can not find the headset when searching pairing devices	Not enter pairing state	Till the red/blue light flash alternately
	The headset is not in searching status	Set the headset on searching status
	Mobile phone bluetooth software eerror	Close the mobile phone and re-start

**FCC STATEMENT :**

This device complies with Part 15 of the FCC Rules. Operation is subject to the following two conditions:

- (1) This device may not cause harmful interference, and
- (2) This device must accept any interference received, including interference that may cause undesired operation.

**Warning:** Changes or modifications not expressly approved by the party responsible for compliance could void the user's authority to operate the equipment.

NOTE: This equipment has been tested and found to comply with the limits for a Class B digital device, pursuant to Part 15 of the FCC Rules. These limits are designed to provide reasonable protection against harmful interference in a residential installation. This equipment generates uses and can radiate radio frequency energy and, if not installed and used in accordance with the instructions, may cause harmful interference to radio communications. However, there is no guarantee that interference will not occur in a particular installation. If this equipment does cause harmful interference to radio or television reception, which can be determined by turning the equipment off and on, the user is encouraged to try to correct the interference by one or more of the following measures:

- Reorient or relocate the receiving antenna.
- Increase the separation between the equipment and receiver.
- Connect the equipment into an outlet on a circuit different from that to which the receiver is connected.
- Consult the dealer or an experienced radio/TV technician for help.

**RF warning statement:**

The device has been evaluated to meet general RF exposure requirement. The device can be used in portable exposure condition without restriction.