

TRT-5380-12

USER MANUAL

August 2022

NOTE

The information in this manual is subject to change without notice.

Table of Contents

Chapter 1	Getting Started	1
	Getting the Tablet Running	2
	Unpacking	2
	Connecting to AC Power	3
	Turning On and Off the Tablet	4
	Taking a Look at the Tablet	6
	Front Components	7
	Rear Components	8
	Left-Side Components	9
	Right-Side Components	9
	Top Components	10
	Bottom Components	10
Chapter 2	Operating Your Tablet	11
	Using Wireless Connections	12
	Using the WLAN	13
	Using the Bluetooth Feature	14
Chapter 3	Managing Power	15
	AC Adapter	16
	Battery Pack	17
	Charging the Battery Pack	17
	Checking the Battery Level	18
	Low Battery	18
	Replacing the Battery Pack	19
	Power-Saving Tips	20

Chapter 4	Expanding Your Tablet	21
	Connecting Peripheral Devices	22
	Connecting a USB Device	22
	Connecting a Type-C Device	22
	Connecting a Monitor	23
	Connecting a Serial Device	23
	Connecting an Audio Device	24
	TF Card	24
Chapter 5	Using BIOS Setup	25
	When and How to Use	26
	Menu Descriptions	27
	Main Menu	27
	Advanced Menu & Chipset Menu	29
	Security Menu	29
	Boot Menu	30
	Save & Exit Menu	31
Chapter 6	Care and Maintenance	32
	Protecting the Tablet	33
	Using an Anti-Virus Strategy	33
	Using the Cable Lock	33
	Taking Care of the Tablet	34
	Location Guidelines	34
	General Guidelines	35
	Cleaning Guidelines	35
	Battery Pack Guidelines	36
	Touchscreen Guidelines	37
	When Traveling	38

Chapter 7 Troubleshooting	39
Preliminary Checklist	40
Solving Common Problems	41
Battery Problems	41
Bluetooth Problems	42
Display Problems	42
Hardware Device Problems	43
Power Management Problems	43
Software Problems	44
Sound Problems	44
Startup Problems	44
WLAN Problems	45
Restart the Tablet	46
System Recovery	47
Windows RE	47
Recovery Partition	48

Chapter 1

Getting Started

This chapter first tells you step by step how to get the tablet up and running. Then, you will find a section briefly introducing the external components of the tablet.

Getting the Tablet Running

Unpacking

After unpacking the shipping carton, you should find these standard items:

- I22J 2 12.2 inch Full Ruggedized Tablet

- AC power cord



- AC adapter



- Hand-strap



- Battery pack



- Carry handle



Connecting to AC Power

CAUTION : Use only the AC adapter included with your Tablet. Using other AC adapters may damage the Tablet.

NOTE :

- The battery pack is shipped to you in power saving mode that protects it from charging/discharging. It will get out of the mode to be ready for use when you install the battery pack and connect AC power to the Tablet for the very first time.
- When the AC adapter is connected, it also charges the battery pack. For information on using battery power, see Chapter 3.

You must use power when starting up the Tablet for the very first time.

1. Open the waterproof plug of DC interface.



DC interface

2. The DC power cord of the power adapter is inserted into the power jack of the flat panel.
3. Insert the female port end of the AC power cord into the power adapter and the male port end into the power socket.
4. The power socket supplies power to the flat panel through the adapter. Now you can turn on the tablet power.

Turning On and Off the Tablet





Turning On

2. Press the power button (). The Windows operating system should start.



Turning Off

When you finish a working session, you can stop the system by turning off the power or leaving it in Sleep or Hibernation mode:

To...	Do this...
Power off (Shutdown)	Click  → [ Power] → [Shutdown].
Sleep	Use one of these methods: <ul style="list-style-type: none">● Press the power button.● Click  → [ Power] → [Sleep].
Hibernate	By default, this option is not shown in the Start menu. If you want to use the feature, set up accordingly in Windows settings.

*“Sleep ” is the default result of the action. You can change what the action does through Windows settings.

Taking a Look at the Tablet

NOTE : Depending on the specific model you purchased, the color and look of your model may not exactly match the graphics shown in this document.

CAUTION : You need to open the protective covers to access the connectors. When not using a connector, make sure to close the cover completely for water-proof, and dust-proof integrity.

Front Components



Ref	Component	Description
①	Indicator Light	Left: The power on is always on blue, and the power off light is off. Right: Red is displayed when charging, and the low battery red light flashes.
②	Touch Screen	Corning gorilla glass touch screen.
③	Front Camera	Front 5.0MP.

Rear Components

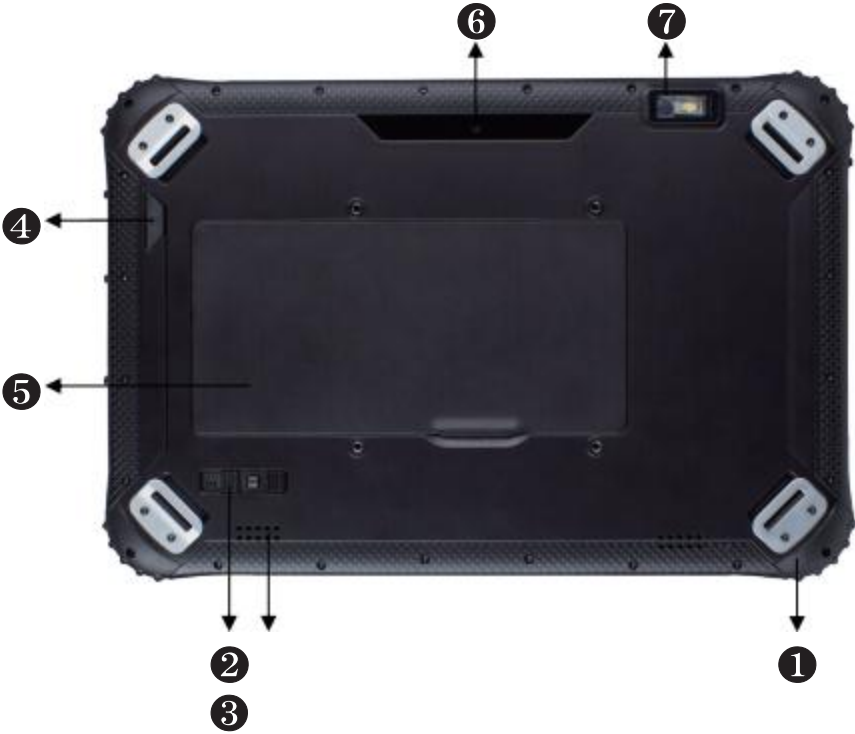

Ref	Component	Description
①	Anti Wrestling	It can protect the equipment to a certain extent.
②	Battery Lock	Lock battery and remove.
③	Speaker	Let the sound spread farther and bigger.
④	F key	Used to trigger the scan function.
⑤	Battery	For power supply.
⑥	Rear Camera	Rear 8.0MP.
⑦	Scan Window	Support barcode scanning.

Top Components

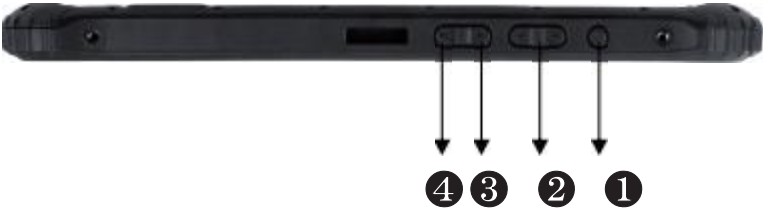

Ref	Component	Description
①	Power Key	Control the power on and off of the tablet. (the default is to enter the sleep state when it is turned off)
②	Volume +/- Key	Used to adjust the increase / decrease volume.
③	P1 Key	Windows key, customizable without barcode.
④	P2 Key	Control panel, customizable without barcode.

Right-Side Components



Ref	Component	Description
①	RS232 Port	Connect RS-232 serial mouse or serial communication device.
②	RS485 Port	Connect RS-485 serial mouse or serial communication device.
③	USB3.0 Port	Connect USB device.

Left-Side Components

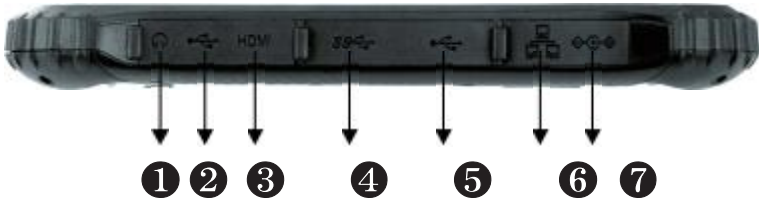

Ref	Component	Description
①	Headphone Jack	Connect the audio device.
②	TYPE-C Port	Can connect devices that support thunderbolt or USB-C.
③	HDMI Port	Connect HDMI monitor or projector.
④	USB3.0 Port	Connect USB device.
⑤	USB2.0 Port	Connect USB device.
⑥	RJ45 network port	Connect LAN network cable.
⑦	DC Power Jack	Connect the power adapter.

Bottom Components



Ref	Component	Description
①	Pogo PIN	It is used to connect Docking charger or Vehicle mount.

Chapter 2

Operating Your Tablet

This chapter provides information about the use of the Tablet.

If you are new to Tablets, reading this chapter will help you learn the operating basics. If you are already a Tablet user, you may choose to read only the parts containing information unique to your Tablet.

CAUTION :

- Do not expose your skin to the Tablet when operating it in a very hot or cold environment.
- The Tablet can get uncomfortably warm when you use it in high temperatures. As a safety precaution in such a circumstance, do not place the Tablet on your lap or touch it with your bare hands for extended periods of time. Prolonged body contact can cause discomfort and potentially a burn.

Using Wireless Connections

Using the LAN

The built-in 10/100/1000M LAN (local area network) module allows your tablet to connect to the network. Plug one end of the network cable into the RJ45 interface of the tablet and the other end into the network hub.



Using the WLAN

The WLAN (Wireless Local Area Network) module supports IEEE 802.11ax.

Turning On / Off the WLAN Radio

To turn on the WLAN radio:

Click the network connection icon in the lower right corner to open the network settings. Click  to open the wireless network.

To turn off the WLAN radio:

You can turn off the WLAN radio the same way you turn it on.

If you want to quickly turn off all radio frequencies at once, just turn on the flight mode:

Click the network connection icon in the lower right corner to open network settings and click flight mode.

Connecting to a WLAN Network

1. Make sure that the WLAN function is enabled (as described above).
2. Click the network icon  in the lower right of the task bar.
3. In the list of available wireless networks, click a network, and then click Connect.
4. Some networks require a network security key or passphrase. To connect to one of those networks, ask your network administrator or Internet service provider (ISP) for the security key or passphrase.

For more information on setting a wireless network connection, refer to Windows online help.

Using the Bluetooth Feature

The Bluetooth technology allows short-range wireless communications between devices without requiring a cable connection. Data can be transmitted through walls, pockets and briefcases as long as two devices are within range.

Turning On / Off the Bluetooth Radio

To turn on the Bluetooth radio:

Click the network connection icon in the lower right corner to open the network settings. Click  to open the location of the wireless network.

To turn off the Bluetooth radio:

You can turn off the Bluetooth radio the same way you turn it on.

If you want to quickly turn off all radio frequencies at once, just turn on the flight mode:

Click the network connection icon in the lower right corner to open network settings and click flight mode.

Connecting to another Bluetooth Device

1. Make sure that the Bluetooth function is enabled (as described above).
2. Make sure that the target Bluetooth device is turned on, discoverable and within close range. (See the documentation that came with the Bluetooth device.)
3. Long press the Bluetooth icon  -- Click to go to **[Settings]** -- select **[Add device]**.
4. Select the device you want to connect from the search results.
5. Depending on the type of Bluetooth device that you want to connect to, you will need to enter the pertinent information.

For detailed information on using the Bluetooth feature, see Windows' online Help.

Chapter 3

Managing Power

Your Tablet operates either on external AC power or on internal battery power.

This chapter tells you how you can effectively manage power. To maintain optimal battery performance, it is important that you use the battery in the proper way.

AC Adapter

CAUTION :

- The AC adapter is designed for use with your Tablet only. Connecting the AC adapter to another device can damage the adapter.
- The AC power cord supplied with your Tablet is for use in the country where you purchased your Tablet. If you plan to go overseas with the Tablet, consult your dealer for the appropriate power cord.
- When you disconnect the AC adapter, disconnect from the electrical outlet first and then from the Tablet. A reverse procedure may damage the AC adapter or Tablet.
- When unplugging the connector, always hold the plug head. Never pull on the cord.

The AC adapter serves as a converter from AC (Alternating Current) to DC (Direct Current) power because your Tablet runs on DC power, but an electrical outlet usually provides AC power. It also charges the battery pack when connected to AC power.

The adapter operates on any voltage in the range of 100~240V AC.

Battery Pack

The battery pack is the internal power source for the Tablet. It is rechargeable using the AC adapter.

CAUTION : The time to unplug the battery pack is limited to when the battery is not being charged.

NOTE : Care and maintenance information for the battery is provided in the “Battery Pack Guidelines” section in Chapter 6.

Charging the Battery Pack

NOTE : The rechargeable temperature of the battery is between 0°C and 50°C.

To charge the battery pack, connect the AC adapter to the Tablet and an electrical outlet. The Battery Indicator () on the Tablet glows red to indicate that charging is in progress. When the battery is fully charged, the Battery Indicator lights green.

CAUTION : After the Tablet has been fully recharged, do not immediately disconnect and reconnect the AC adapter to charge it again. Doing so may damage the battery.

Checking the Battery Level

NOTE : Any battery level indication is an estimated result. The actual operating time can be different from the estimated time, depending on how you are using the Tablet.

When the battery is fully charged, its power supply time depends on how you use the Tablet. If the software you use requires frequent use of peripheral devices, the power may run out soon.

You can find the battery icon on the Windows taskbar (lower-right corner). The icon shows the approximate battery level.

If your model has more than one battery pack installed, the battery pack discharges in parallel.

Battery Low Signals and Actions

When the battery is low, please connect the adapter immediately, put the Tablet into hibernation, or turn off the Tablet's power.

Replacing the Battery Pack

CAUTION :

- There is danger of explosion if the battery is incorrectly replaced. Replace the battery only with the Tablet manufacturer' soptional battery packs. Discard used batteries according to the dealer' sinstructions.
- Do not attempt to disassemble the battery pack.
- The battery pack will become hot under long-term operation. Do not touch the hot battery pack with bare hands. After removing the battery pack, place it in a ventilated place.

NOTE :When replacing the battery, be sure to turn off the device so that the device can save the work in progress.

1. Carefully turn the plate so that its bottom is upward.
2. Identify the location of the battery pack to be replaced.
3. Push the battery door latch to the unlocking position () and press the battery cover toward the door latch at the same time.
4. Take out the battery pack.



Power-Saving Tips

Aside from enabling your Tablet's power saving mode, you can do your part to maximize the battery's operating time by following these suggestions.

- Do not disable Power Management.
- Decrease the LCD brightness to the lowest comfortable level.
- Shorten the length of time before Windows turn off the display.
- When not using a connected device, disconnect it.
- Turn off the wireless radio if you are not using the wireless module (such as WLAN or Bluetooth).
- Turn off the Tablet when you are not using it.

Chapter 4

Expanding Your Tablet

You can expand the capabilities of your Tablet by connecting other peripheral devices.

When using a device, be sure to read the instructions accompanying the device together with the relevant section in this chapter.

Connecting Peripheral Devices

Connecting a USB Device

Your Tablet has two USB 3.0 ports and one USB 2.0 port for connecting USB devices, such as a digital camera, scanner, printer, modem, and mouse.



Connecting a Monitor

Your Tablet supports HDMI and DisplayPort connectors. Please connect the monitor to the corresponding interface according to the specifications.



Connecting a Serial Device

Your Tablet have one RS232 serial port and one RS232 serial port for connecting a serial device.



Connecting an Audio Device

Your Tablet is equipped with a composite audio port, which is 3.5mm in size, which can be connected to a compatible headset microphone.



AFETY WARNING : 

To prevent possible hearing damage, do not listen at high volume levels for long period.

TF Card

Please unload the battery of the back cover to see the TF card slot.



Chapter 5

Using BIOS Setup

BIOS Setup Utility is a program for configuring the BIOS (Basic Input / Output System) settings of the Tablet. BIOS is a layer of software, called firmware, that translates instructions from other layers of software into instructions that the Tablet hardware can understand. The BIOS settings are needed by your Tablet to identify the types of installed devices and establish special features.

This chapter tells you how to use the BIOS Setup Utility.

When and How to Use

You need to run BIOS Setup Utility when:

- You see an error message on the screen requesting you to run BIOS Setup Utility.
- You want to restore the factory default BIOS settings.
- You want to modify some specific settings according to the hardware.
- You want to modify some specific settings to optimize the system performance.

To run BIOS Setup Utility:

1. First, the device is in the shutdown state, connect the external keyboard, press the power key to start the device, and then press the "ESC" key to enter the BIOS interface after the characters appear on the screen..
2. In general, you can use the external keyboard, use the arrow keys to move around and + / – keys to change the setup values. Keyboard information can be found at the bottom of the screen.

NOTE :

- The actual setting items on your model may differ from those described in this chapter.
- The availability of some setting items depends on the Windows version your Tablet is running.

Menu Descriptions

Main Menu

The Main menu contains the various system settings.

- **Build Date and Time** (BIOS version date) : Record the Tablet bios version.
- **Serial number** (SN) : Record Tablet factory code.

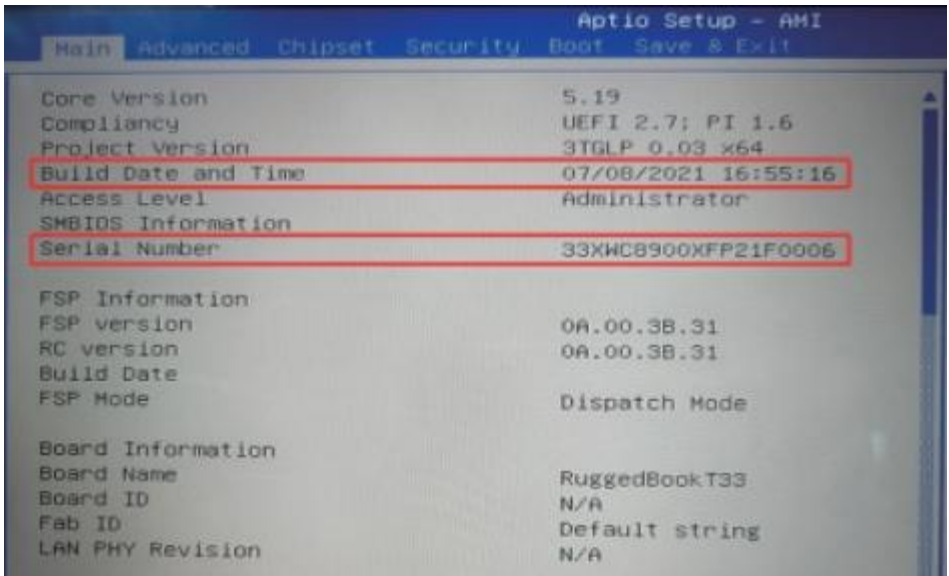

- **EC FM Version** : Record EC firmware information.
- **System Language** : Setsystem language.
- **System Date** : Sets the system date.
- **System Time** : Sets the system time.

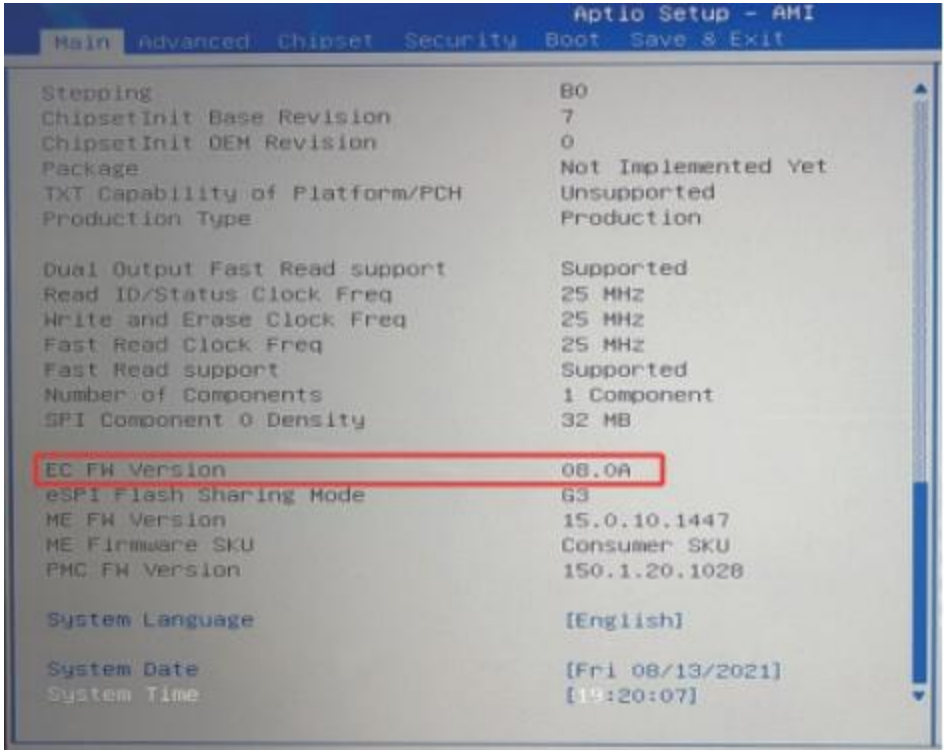

Advanced Menu & Chipset Menu

The setting options contained in the Advanced menu and the Chipset chip setting menu are for debugging by developers. Please do not change them at will.

Security Menu

The Security menu contains the security settings, which safeguard your system against unauthorized use.

Note :

- You can set the user password only when the supervisor password has been set.
- If both the administrator and user passwords are set, you can enter any of them for starting up the system and/or entering BIOS Setup. However, the user password only allows you to view/change the settings of certain items.
- A password setting is applied right after it is confirmed. To cancel a password, leave the password empty by pressing the Enter key.
- **Set Administrator / User Password** : Sets the supervisor/user password. You can set the supervisor / user password to be required for starting up the system and / or entering BIOS Setup.
- **Secure Boot** : Setup the safe boot function. This item can only be used after the supervisor password is set. (Secure Boot secure boot function can prevent unauthorized firmware, operating system, or UEFI driver from running during boot.)

Boot Menu

The Boot menu sets the sequence of the devices to be searched for the operating system.

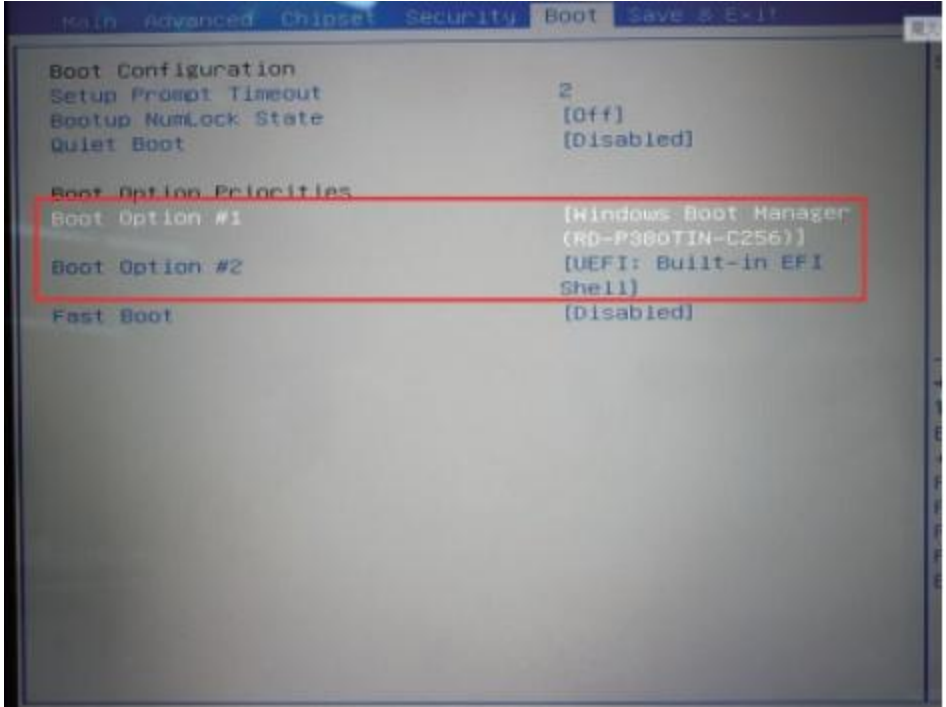

Save & Exit Menu

The Save & Exit menu displays ways of exiting BIOS Setup Utility. After finishing with your settings, you must save and exit so that the changes can take effect.

- **Save Changes and Exit** : Saves the changes you have made and exits BIOS Setup Utility.
- **Discard Changes and Exit** : Exits BIOS Setup Utility without saving the changes you have made.
- **Save Changes and Reset** : Saves the changes you have made and restart the device.
- **Discard Changes and Reset** : Restart the Tablet without saving the changes you have made.
- **Restore Default** : Load the factory default values of all items.
- **Save as User Defaults** : Save user default settings.
- **Restore User Defaults** : Load factory default values for all items.
- **Saves Changes** : Save the changes you have made.
- **Discard Changes** : All items are restored to their original values.

Chapter 6

Care and Maintenance

Taking good care of your Tablet will ensure a trouble-free operation and reduce the risk of damage to your Tablet.

This chapter gives you guidelines covering areas such as protecting, storing, cleaning, and traveling.

Protecting the Tablet

To safeguard the integrity of your Tablet data as well as the Tablet itself, you can protect the Tablet in several ways as described in this section.

Using an Anti-Virus Strategy

You can install a virus-detecting program to monitor potential viruses that could damage your files.

Use Cable lock

You can use a Kensington-type cable lock to protect your Tablet against theft. The cable lock is available in most Tablet stores.

To use the lock, loop the lock cable around a stationary object such as a table. Insert the lock to the Kensington lock hole and turn the key to secure the lock. Store the key in a safe place.



Taking Care of the Tablet

Location Guidelines

- For optimal performance, use the Tablet where the recommended temperature is between 0 °C and 40 °C . (Actual operating temperature depends on product specifications.)
- Avoid placing the Tablet in a location subject to high humidity, extreme temperatures, mechanical vibration, direct sunlight, or heavy dust. Using the Tablet in extreme environments for long periods can result in product deterioration and a shortened product life.
- Operating in an environment with metallic dust is not allowed.
- Place the Tablet on a flat and steady surface. Do not stand the Tablet on its side or store it in an upside-down position. A strong impact by dropping or hitting may damage the Tablet.
- Do not cover or block any ventilation openings on the Tablet. For example, do not place the Tablet on a bed, sofa, rug, or other similar surface. Otherwise, overheating may occur that results in damage to the Tablet.
- As the Tablet can become very hot during operation, keep it away from objects that are vulnerable to heat.
- Keep the Tablet at least 13 cm (5 inches) away from electrical appliances that can generate a strong magnetic field such as a TV, refrigerator, motor, or a large audio speaker.
- Avoid moving the Tablet abruptly from a cold to a warm place. A temperature difference of more than 10 °C (18 °F) may cause condensation inside the unit, which may damage the storage media.

General Guidelines

- Do not place heavy objects on top of the Tablet when it is closed as this may damage the display.
- To avoid damaging the screen, do not touch it with any sharp object.
- LCD image sticking occurs when a fixed pattern is displayed on the screen for a prolonged period of time. You can avoid the problem by limiting the amount of static content on the display. It is recommended that you use a screen saver or turn off the display when it is not in use.
- To maximize the life of the backlight in the display, allow the backlight to automatically turn off as a result of power management.

Cleaning Guidelines

- Never clean the Tablet with its power on.
- Use a soft cloth moistened with water or a non-alkaline detergent to wipe the exterior of the Tablet.
- Gently wipe the display with a soft, lint-free cloth.
- If water or liquid is spilled onto the Tablet, wipe it dry and clean when possible. Though your Tablet is water-proof, do not leave the Tablet wet when you can dry it.
- If the Tablet gets wet where the temperature is 0°C (32°F) or below, freeze damage may occur. Make sure to dry the wet Tablet.

Battery Pack Guidelines

● The battery pack is a consumable product and the following conditions will shorten its life:

– when frequently charging the battery pack.

– when using, charging, or storing in high temperature condition.

● To avoid hastening the deterioration of the battery pack thereby prolonging its useful life, minimize the number of times you charge it so as not to frequently increase its internal temperature.

● Charge the battery pack between 10 °C ~ 30 °C (50 °F ~ 86 °F) temperature range. A higher environment temperature will cause the battery pack' s temperature to rise. Avoid charging the battery pack inside a closed vehicle and in hot weather condition. Also, charging will not start if the battery pack is not within the allowed temperature range.

● It is recommended that you do not charge the battery pack more than once a day.

● It is recommended that you charge the battery pack with the Tablet' s power off.

● To maintain the battery pack' s operating efficiency, store it in a cool dark place removed from the Tablet and with 30 % ~ 40 % charge remaining.

● Important guidelines when using the battery pack. When installing or removing the battery pack take note of the following:

– avoid installing or removing the battery pack when the Tablet is in Sleep mode.

Abruptly removing the battery pack may cause loss of data or the Tablet may become unstable.

– avoid touching the battery pack terminals or damage may occur, thereby causing improper operation to it or the Tablet.

The Tablet' input voltage and surrounding temperature will directly affect the battery pack' scharge and discharge time:

– charging time will be prolonged when the Tablet is turned on.

To shorten the charging time, it is recommended that you place the Tablet in sleep or hibernation mode.

– a low temperature will prolong the charging time as well as hasten the discharge time.

● When using battery power in an extremely low temperature environment, you may experience shortened operating time and incorrect battery level reading. This phenomenon comes from the chemical characteristics of batteries.

● Do not leave the battery pack in storage for more than six months without recharging it.

Touchscreen Guidelines

● Use the finger or stylus on the display. Using a sharp or metallic object other than your finger or stylus may cause scratches and damage the display, thereby causing errors.

● Use a soft cloth to remove dirt on the display. The touchscreen surface has a special protective coating that prevents dirt from sticking to it. Not using a soft cloth may cause damage to the special protective coating on the touchscreen surface.

● Turn off the Tablet power when cleaning the display. Cleaning the display with the power on may cause improper operation.

● Do not use excessive force on the display. Avoid placing objects on top of the display as this may cause the glass to break thereby damaging the display.

● In low and high temperatures the touchscreen may have a slower response time or register the touch in the wrong location. It will go back to normal after returning to room temperature.

When Traveling

- Make sure that the battery pack is fully charged.
- Make sure that the Tablet is turned off.
- Make sure that all the connector covers are closed completely to ensure the waterproof integrity.
- Disconnect the AC adapter from the Tablet and take it with you. Use the AC adapter as the power source and as a battery-charger.
- Hand-carry the Tablet. Do not check it in as luggage.
- If you need to leave the Tablet in the car, put it in the trunk of the car to avoid exposing the Tablet to excessive heat.
- When going through airport security, it is recommended that you send the Tablet and flash disks through the X-ray machine (the device you set your bags on). Avoid the magnetic detector (the device you walk through) or the magnetic wand (the handheld device used by security personnel).
- If you plan to travel abroad with your Tablet, consult your dealer for the appropriate AC power cord for use in your country of destination.

Chapter 7

Troubleshooting

Tablet problems can be caused by hardware, software, or both. When you encounter any problem, it might be a typical problem that can easily be solved.

This chapter tells you what actions to take when solving common Tablet problems.

Preliminary Checklist

Here are helpful hints to follow before you take further actions when you encounter any problem:

- Try to isolate which part of the Tablet is causing the problem.
- Make sure that you turn on all peripheral devices before turning on the Tablet.
- If an external device has a problem, make sure that the cable connections are correct and secure.
- Make sure that the configuration information is properly set in the BIOS Setup program.
- Make sure that all the device drivers are correctly installed.
- Make notes of your observations. Are there any messages on the screen? Do any indicators light? Do you hear any beeps? Detailed descriptions are useful to the service personnel when you need to consult one for assistance.

If any problem persists after you follow the instructions in this chapter, contact an authorized dealer for help.

Solving Common Problems

Battery Problems

The battery does not charge (The red indicator is not on) .

- Make sure that the AC adapter is properly connected.
- Make sure that the battery is not too hot or cold. Allow time for the battery pack to return to room temperature.
- If the battery doesn't charge after it has been stored in very low temperatures, try disconnecting and reconnecting the AC adapter to solve the problem.
- Make sure that the battery pack is installed correctly.
- Make sure that the battery terminals are clean.

The operating time of a fully charged battery becomes shorter.

- If you often partially recharge and discharge, the battery might not be charged to its full potential. Initialize the battery to solve the problem. (Fully charge in the shutdown state, discharge to 0%, and then fully charge the shutdown, cycle 2-3 times).

The battery operating time indicated by the battery meter does not match the actual operating time.

- The actual operating time can be different from the estimated time, depending on how you are using the Tablet. If the actual operating time is much less than the estimated time, initialize the battery.

Bluetooth Problems

I cannot connect to another Bluetooth-enabled device.

- Make sure that both devices have activated Bluetooth feature.
- Make sure that the distance between the two devices is within the limit and that there are no walls or other obstructions between the devices.
- Make sure that the other device is not in “Hidden ” mode.
- Make sure that both devices are compatible.

Display Problems

Nothing appears on the screen.

- automatically turn off as a result of power management. Press any key to see if the screen comes back.
- The brightness level might be too low. Increase brightness.
- The screen output may be switched to an external device. Please switch the display via Windows [**Control Panel**].

The characters on the screen are dim.

- Adjust the brightness and / or contrast.

Bad dots appear on the display at all times.

- A small number of missing, discolored, or bright dots on the screen are an intrinsic characteristic of TFT LCD technology. It is not regarded as a LCD defect.

Hardware Device Problems

The Tablet does not recognize a newly installed device.

- Make sure if any device driver needs to be installed. (Refer to the documentation that came with the device.)
- The device may not be correctly configured in the BIOS Setup program. Run the BIOS Setup program to identify the new type.
- Check the cables or power cords for correct connections.
- For an external device that has its own power switch, make sure that the power is turned on.

Power Management Problems

The Tablet does not enter Sleep or Hibernation mode automatically.

- If you have a connection to another Tablet, the Tablet does not enter Sleep or Hibernation mode if the connection is actively in use.
- Make sure that the Sleep or Hibernation time-out is enabled.

The Tablet does not enter Sleep or Hibernation mode immediately.

- If the Tablet is performing an operation, it normally waits for the operation to finish.

The Tablet does not resume from Sleep or Hibernation mode.

- The Tablet automatically enters Sleep or Hibernation mode when the battery pack is empty. Do any one of the following:
 - Connect the AC adapter to the Tablet.
 - Replace the empty battery pack with a fully charged one.

Software Problems

An application program does not work correctly.

- Make sure that the software is correctly installed.
- If an error message appears on the screen, consult the software program's documentation for further information.
- If you are sure the operation has stop, reset the Tablet.

Sound Problems

No sound is produced.

- Make sure that the volume control is not set too low.
- Make sure that the Tablet is not in mute mode.
- Make sure that the Tablet is not in Sleep mode.
- If using an external speaker, make sure that the speaker is properly connected.

Distorted sound is produced.

- Make sure that the volume control is not set too high or too low. In most cases, a high setting can cause the audio electronics to distort the sound.

Startup Problems

When you turn on the Tablet, it does not seem to respond.

- If you are using an external AC power, make sure that the AC adapter is correctly and securely connected. If so, make sure that the electrical outlet works properly.
- If you are using the battery power, make sure that the battery is not discharged.

WLAN Problems

I cannot use the WLAN feature.

- Make sure that the WLAN feature is turned on.

Transmission quality is poor.

- Your Tablet may be in an out-of-range situation. Move your Tablet closer to the Access Point or another WLAN device it is associated with.
- Check if there is high interference around the environment and solve the problem as described next.

Radio interference exists.

- Move your Tablet away from the device causing the radio interference such as microwave oven and large metal objects.
- Plug your Tablet into an outlet on a different branch circuit from that used by the affecting device.
- Consult your dealer or an experienced radio technician for help.

I cannot connect to another WLAN device.

- Make sure that the WLAN feature is turned on.
- Make sure that the SSID setting is the same for every WLAN device in the network.
- Your Tablet is not recognizing changes. Restart the Tablet.
- Make sure that the IP address or subnet mask setting is correct.

I cannot access the network.

- Make sure that the network configuration is appropriate.
- Make sure that the user name or password is correct.
- You have moved out of range of the network.

Restart the Tablet

When the Tablet crashes due to a problem, you may need to restart the Tablet.

If you are sure that the Tablet has crashed and you cannot use the reboot function provided by the operating system, please press and hold the power button for more than 5 seconds to force the Tablet to shut down. Then turn it on again.

System Recovery

Using Windows RE

Windows 11 has a recovery environment (Windows RE) that provides recovery, repair, and troubleshooting tools. The tools are referred to as Advanced Startup Options. You can access these options by selecting  → [Settings] → [System] → [Recovery] → [Advanced startup], select restart now to enter the windows recovery environment, where users can use the keyboard shortcut to open the easy access function.

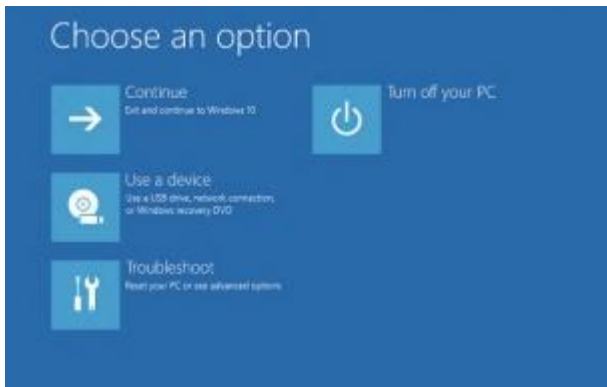

NOTE :

- If you are in a situation where your Tablet won't boot into Windows, you can access the Advanced Startup Options by running the BIOS Setup Utility and selecting **Advanced** → **Windows RE**.
- System recovery for Windows 11 typically will take several hours to complete.

Using Recovery Partition

When necessary, you can restore your Windows 10 system to the factory default state by using the “recovery partition” feature. Recovery partition is a portion of your hard disk drive that is set aside by the manufacturer to hold the original image of your system.

WARNING :

- Using this feature will reinstall Windows to your system and configure it to the system’s factory default settings. All data on the hard disk drive will be lost.
- Make sure that power is not interrupted during the recovery process. An unsuccessful recovery may result in Windows startup problems.

To restore your system to the factory default state:

1. Connect the AC adapter.
2. Run BIOS Setup Utility. Select **Advanced** → **Recovery Partition**. (See Chapter 5 for more information.)
3. Follow the onscreen instructions to complete the process.
4. For quick installation, you can use hard disk partition and image installation.

*Try not to recover the system. It will take a long time and may cause system defects. It is recommended to consult the local dealer or business and send the original image to manually install the system.

Use warnings:

- ①. With the wrong type of battery replacement will be explosive danger, be sure to use the original battery.
- ②. The company shall not take any responsibility for the loss or removal of the information in the tablet, which is caused by the operation, maintenance or other accidents of the non-normal operation of the software and hardware.
- ③. Please backup your important information at any time.
- ④ . Please do not disassemble the tablet; otherwise it will lose the right to guarantee.
- ⑤. Adapter description:

INPUT: 100 - 240V~50/60Hz 1.5A max OUTPUT:19V DC 3.42A

Manufacturer's Name: Teguar Corporation

Address: 3/F, Bldg 5th,2920 Whitehall Park Drive Charlotte NC 28273 United Statesna

Product name : 12.2 inch Full Ruggedized Tablet Model number: EM-I22J

FCC ID: 2AL2MTRT-5380-12

Operating Temperature: - 20° C to 60° C

This device was tested for typical body - worn operations. To comply with RF exposure requirements, a minimum separation distance of 0mm must be maintained between the user's body and the handset, including the antenna. Third - party belt - clips, holsters, and similar accessories used by this device should not contain any metallic components. Body - worn accessories that do not meet these requirements may not comply with RF exposure requirements and should be avoided. Use only the supplied or an approved antenna.

This device in compliance with the essential requirements and other relevant provisions of Directive 2014/53/EU. All essential radio test suites have been carried out.

1. Use careful with the earphone maybe possible excessive sound pressure from earphones and headphones can cause hearing loss.

2. CAUTION : RISK OF EXPLOSION IF BATTERY IS REPLACED BY AN INCORRECT TYPE.

DISPOSE OF

USED BATTERIES ACCORDING TO THE INSTRUCTIONS

3. This product can be connected to the USB interface of USB 3.0

4. Adapter shall be installed near the equipment and shall be easily accessible.

5. The plug considered as disconnect device of adapter

6. The device complies with RF specifications when the device used at 0mm from your body

7. Operations in the 5.15 - 5.25GHz band are restricted to indoor usage only.

Restrictions in the 5 GHz band:

According to Article 10 (10) of Directive 2014/53/EU, the packaging shows that this radio equipment will be subject to some restrictions when placed on the market in Belgium (BE), Bulgaria(BG), the Czech Republic (CZ),Denmark (DK), Germany (DE), Estonia (EE), Ireland (IE), Greece (EL), Spain(ES), France (FR), Croatia (HR), Italy (IT), Cyprus (CY), Latvia (LV), Lithuania(LT), Luxembourg (LU), Hungary (HU), Malta (MT), Netherlands (NL), Austria(AT), Poland (PL), Portugal (PT), Romania (RO), Slovenia (SI), Slovakia (SK),Finland (FI), Sweden(SE),Turkey (TR), Norway(NO), Switzerland (CH), Iceland (IS), and Liechtenstein (LI).The WLAN function for this device is restricted to indoor use only when operating in the 5180 to 5240 MHz frequency range.

Manufacturer's Name: Teguar Corporation

Address: 3/F, Bldg 5th,2920 Whitehall Park Drive Charlotte NC 28273 United Statesna

Product name : 12.2 inch Full Ruggedized Tablet Model number: EM-I22J

FCC ID: 2AL2MTRT-5380-12

Made In China

This device complies with part 15 of the FCC Rules. Operation is subject to the following two conditions:

(1) this device may not cause harmful interference, and (2) this device must accept any interference received, including interference that may cause undesired operation.

Any changes or modifications not expressly approved by the party responsible for compliance

could void the user's authority to operate the equipment.

NOTE: This equipment has been tested and found to comply with the limits for a Class B digital device, pursuant to Part 15 of the FCC Rules. These limits are designed to provide reasonable protection against

harmful interference in a residential installation. This equipment generates, uses and can radiate radio frequency energy and, if not installed and used in accordance with the instructions, may cause harmful interference to radio communications. However, there is no guarantee that interference will not occur in a

particular installation.

If this equipment does cause harmful interference to radio or television reception,

which can be determined by turning the equipment off and on, the user is encouraged to try to correct the

interference by one or more of the following measures:

-- Reorient or relocate the receiving antenna.

-- Increase the separation between the equipment and receiver.

-- Connect the equipment into an outlet on a circuit different from that to which the receiver is connected.

-- Consult the dealer or an experienced radio/TV technician for help. The device has been evaluated to meet general RF exposure requirement. The device can be used in portable exposure condition without restriction.

Body-worn operation; this device was tested for typical body-worn operations with the back of the Tablet kept 0mm for body worn. To maintain compliance with RF exposure requirements, use accessories that maintain a 0mm for body worn. The use of belt clips, holsters and similar accessories should not contain metallic components in its assembly. The use of accessories that do not satisfy these requirements may not comply with RF exposure requirements, and should be avoided. This radio is designed for and classified as "General population/uncontrolled Use", the guidelines are based on standards that were developed by independent scientific organizations through periodic and thorough evaluation of scientific studies. The standards include a substantial safety margin designed to assure the safety of all persons regardless of age or health. The exposure standard for wireless radio employs a unit of measurement known as the Specific Absorption Rate, or SAR, the SAR limit set 1.6W/kg.

The highest reported SAR value for worn on the body 0.740W/kg and Simultaneous SAR is 0.721 W/kg.