







CAR TONG

Report of prepress

Customer : sw

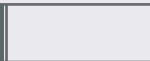
| | | | | | | |
|-------------|---|---|---|---|--|---|
| P/N | SW-1068 | | | | | |
| Size | 121.00 x 37.60 mm | Tolerance | ± | | | |
| Category | label | | | | | |
| Material | + | | | | | |
| Color |  |  |  |  |  |  |
| | 3005U | K | pring | 301 | CG10 | |
| |  | | | | | |
| | die | | | | | |
| Remarks | | | | | | |
| Participant | maggie | | | | | |
| Date | 2018/9/7 10:11:50 | | | | | |

TEGUAR
Computers

TEGUAR.Co.,Ltd <http://www.teguar.com>
 製造商: TEGUAR Computers
 Made in Taiwan 台灣製造 T5
 Computer 電腦
 Model No: TMT-4391-08
 型號
 Input: 5V === 3A
 輸入 

SN: 18APR8100778
 PN:

FCC ID : 2AL2M-TMT-4391-08



GSCA181788

FCC CE   

CLASSIFIED
E465187
3LY4 MEDICAL-GENERAL MEDICAL EQUIPMENT
 AS TO ELECTRICAL SHOCK, FIRE AND MECHANICAL
 HAZARDS ONLY IN ACCORDANCE WITH ANSI/AAMI
 ES 60601-1 (2005) + AMD (2012)
 CAN/CSA-C22.2 No.60801-1 (2008) (2014)

CAUTION!! To prevent shock. Do not remove cover. No user serviceable parts inside. Refer servicing to qualified personnel.

ATTENTION!
 Pour éviter tout risque d'électrocution, ne pas enlever le couvercle. Aucune pièce réparable par l'utilisateur ne se trouve à l'intérieur. Confier tout entretien à un personnel qualifié uniquement.

Battery: 3.8V ===, 4900mAh, 18.62Wh

Contact Address: 4235 S. Stream Blvd. L-130, Charlotte, NC 28217

Only use the adaptor PHIHONG TECHNOLOGY CO., LTD Type MM18M-59A
 INPUT 100-240V~, 0.8A max, 50-60Hz, OUTPUT 5V === 3A

注意
 產品避免撞擊，勿自行拆卸機殼。機臺內部無客戶可自行處理部份。
 若有問題請洽詢專業人員。

Reference

| | | | | | |
|--------|----------------------|-----------|-----------|-----------|-----------|
| Label | ± 0.2mm | | | | |
| Manual | ± 2mm | | | | |
| Box | AB/F ± 5mm | A/F ± 4mm | B/F ± 3mm | E/F ± 2mm | F/F ± 2mm |
| | Folding Carton ± 2mm | | | | |



CAR TONG CO.,LTD

Drawing:

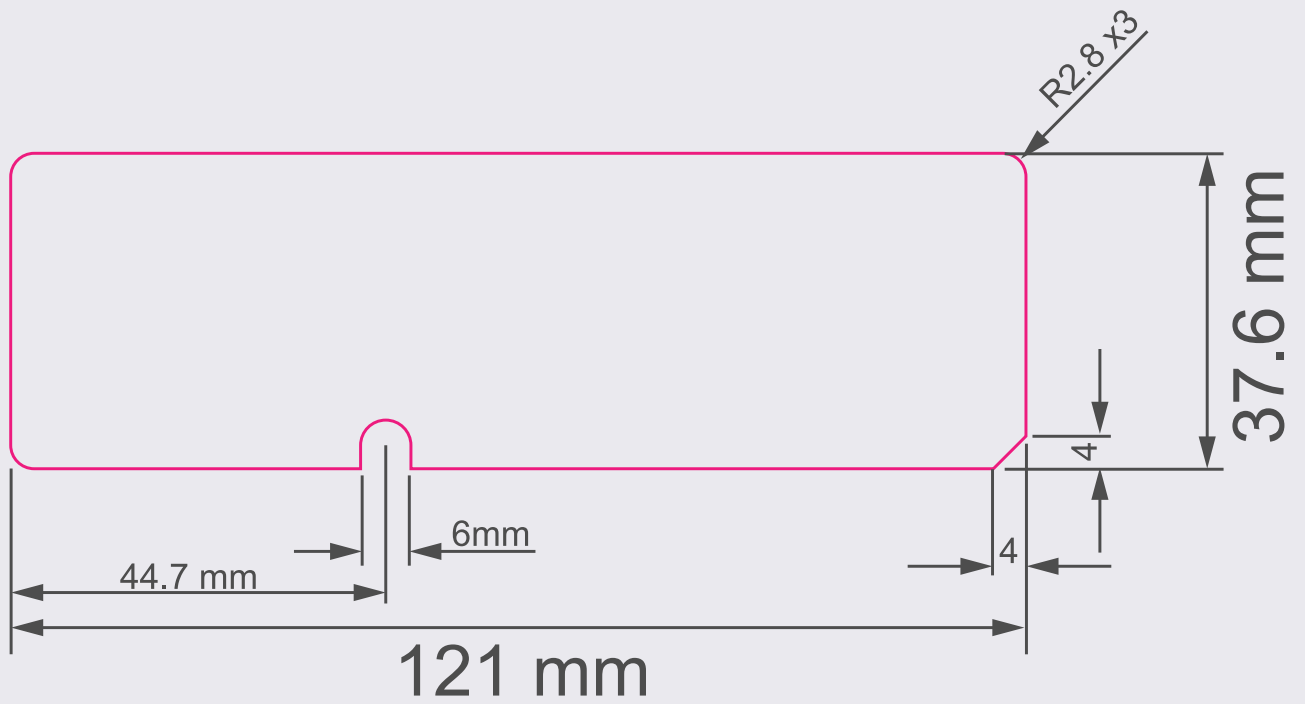

Customer : sw

| | | | | | | |
|-------------|--------------------|-----------|---|--|--|--|
| P/N | SW-1140 | | | | | |
| Size | 60.00 x 7.00 mm | Tolerance | ± | | | |
| Category | label | | | | | |
| Material | + | | | | | |
| Color | | | | | | |
| | K | die | | | | |
| | | | | | | |
| Remarks | | | | | | |
| Participant | maggie | | | | | |
| Date | 2018/10/2 14:33:08 | | | | | |

This device complies with Part 15 of the FCC Rules. Operation is subject to the following two conditions: (1) this device may not cause harmful interference, and (2) this device must accept any interference received, including interference that may cause undesired operation.

Reference

| | | | | | |
|--------|----------------------|-----------|-----------|-----------|-----------|
| Label | ± 0.2mm | | | | |
| Manual | ± 2mm | | | | |
| Box | AB/F ± 5mm | A/F ± 4mm | B/F ± 3mm | E/F ± 2mm | F/F ± 2mm |
| | Folding Carton ± 2mm | | | | |

Drawing:

