FCC Test Report

Report No.: AGC02762220807FE09

FCC ID : 2AL26-K6
APPLICATION PURPOSE : Original Equipment
PRODUCT DESIGNATION : Body Worn Camera
BRAND NAME : Reveal Media
MODEL NAME : K6
APPLICANT : Reveal Media Limited
DATE OF ISSUE : Oct. 13, 2022
STANDARD(S) : FCC Part 15.407
TEST PROCEDURE(S) : KDB 905462 D02
REPORT VERSION : V1.0

Attestation of Global Compliance (Shenzhen) Co., Ltd



Any report having not been signed by authorized approver, or having been altered without authorization, or having not been stamped by the "Dedicated Testing/Inspection Stamp" is deemed to be invalid. Copying or excerpting portion of, or altering the content of the report is not permitted without the written authorization of AGC. The test results presented in the report apply only to the tested sample. Any objections to report issued by AGC should be submitted to AGC within 15days after the issuance of the test report. Further enquiry of validity or verification of the test report should be addressed to AGC by agc01@agccert.com.



Report Revise Record

Report Version	Revise Time	Issued Date	Valid Version	Notes
V1.0	/	Oct. 13, 2022	Valid	Initial Release

Any report having not been signed by authorized approver, or having been altered without authorization, or having not been stamped by the "Dedicated Testing/Inspection Stamp" is deemed to be invalid. Copying or excerpting portion of, or altering the content of the report is not permitted without the written authorization of AGC. The test results presented in the report apply only to the tested sample. Any objections to report issued by AGC should be submitted to AGC within 15days after the issuance of the test report. Further enquiry of validity or verification of the test report should be addressed to AGC by agc01@agccert.com.

TABLE OF CONTENTS

1. VERIFICATION OF CONFORMITY 4

2. GENERAL INFORMATION 5

3. DESCRIPTION OF TEST MODES..... 6

4. SUMMARY OF TEST RESULTS 7

5. TEST FACILITY 7

6. DYNAMIC FREQUENCY SELECTION (DFS) 8

 6.1. APPLICABILITY OF DFS REQUIREMENTS 8

 6.2. TEST SET-UP 9

 6.3. LIMITS 9

 6.4. RADAR TEST WAVEFORMS.....11

 6.5. TEST PROCEDURE11

 6.6. TEST RESULT11

APPENDIX A: PHOTOGRAPHS OF TEST SETUP 17

APPENDIX B: PHOTOGRAPHS OF EUT 17

Any report having not been signed by authorized approver, or having been altered without authorization, or having not been stamped by the “Dedicated Testing/Inspection Stamp” is deemed to be invalid. Copying or excerpting portion of, or altering the content of the report is not permitted without the written authorization of AGC. The test results presented in the report apply only to the tested sample. Any objections to report issued by AGC should be submitted to AGC within 15days after the issuance of the test report. Further enquiry of validity or verification of the test report should be addressed to AGC by agc01@agccert.com.

1. VERIFICATION OF CONFORMITY

Applicant	Reveal Media Limited
Address	Riverview House, 20 Old Bridge Street, Hampton Wick, KT1 4BU, UNITED KINGDOM
Manufacturer	Reveal Media Hong Kong Ltd.
Address	6/F., Luk Kwok Centre, 72 Gloucester Road, Wan Chai, Hong Kong
Factory	Reveal Media Hong Kong Ltd.
Address	6/F., Luk Kwok Centre, 72 Gloucester Road, Wan Chai, Hong Kong
Product Designation	Body Worn Camera
Brand Name	Reveal Media
Test Model	K6
Date of receipt of test item	Aug. 17, 2022
Date of test	Aug. 17, 2022~Oct. 13, 2022
Deviation	No any deviation from the test method
Condition of Test Sample	Normal
Test Result	Pass
Report Template	AGCRT-US-BGN/RF

We hereby certify that:

The above equipment was tested by Attestation of Global Compliance (Shenzhen) Co., Ltd. The test data, data evaluation, test procedures, and equipment configurations shown in this report were made in accordance with the procedures given in KDB 905462 D02.

Prepared By

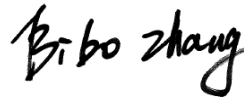

Bibo Zhang
(Project Engineer)

Oct. 13, 2022

Reviewed By



Calvin Liu
(Reviewer)

Oct. 13, 2022

Approved By



Max Zhang
Authorized Officer

Oct. 13, 2022

Any report having not been signed by authorized approver, or having been altered without authorization, or having not been stamped by the "Dedicated Testing/Inspection Stamp" is deemed to be invalid. Copying or excerpting portion of, or altering the content of the report is not permitted without the written authorization of AGC. The test results presented in the report apply only to the tested sample. Any objections to report issued by AGC should be submitted to AGC within 15days after the issuance of the test report. Further enquiry of validity or verification of the test report should be addressed to AGC by agc01@agccert.com.

Attestation of Global Compliance(Shenzhen)Co., Ltd

Attestation of Global Compliance(Shenzhen)Std & Tech Co., Ltd

Tel: +86-755 2523 4088 E-mail: agc@agccert.com Web: http://www.agccert.com/

2. GENERAL INFORMATION

The EUT is designed as “Wireless data terminal”. It is designed by way of utilizing the OFDM technology to achieve the system operation.

Equipment Type	<input type="checkbox"/> Outdoor access points	<input type="checkbox"/> Indoor access points
	<input type="checkbox"/> Fixed P2P access points	<input checked="" type="checkbox"/> Client devices
Operation Frequency	<input checked="" type="checkbox"/> U-NII 1:5150MHz~5250MHz	<input checked="" type="checkbox"/> U-NII 2A: 5250MHz~5350MHz
	<input checked="" type="checkbox"/> U-NII 2C:5470MHz~5725MHz	<input checked="" type="checkbox"/> U-NII 3: 5725MHz~5850MHz
DFS Design Type	<input type="checkbox"/> Master	<input type="checkbox"/> Slave with radar detection
	<input checked="" type="checkbox"/> Slave without radar detection	
TPC Function	<input type="checkbox"/> Yes <input checked="" type="checkbox"/> No	
Test Frequency Range	For 802.11a/n-HT20/ac-VHT20: 5180~5240MHz, 5260~5320MHz, 5500~5720MHz, 5745~5825MHz For 802.11n-HT40/ac-VHT40: 5190~5230MHz, 5270~5310MHz, 5510~5710MHz, 5755~5795MHz For 802.11ac-VHT80: 5210MHz, 5290MHz, 5530~5690MHz, 5775MHz	
Max Average Power	IEEE 802.11a:12.81dBm; IEEE 802.11n-HT20:12.54dBm; IEEE 802.11n-HT40:12.48dBm; IEEE 802.11ac-VHT20:11.50dBm; IEEE 802.11ac-VHT40:11.41dBm; IEEE 802.11ac-VHT80:10.84dBm	
Modulation	802.11a: OFDM (BPSK, QPSK, 16QAM, 64QAM) 802.11n: OFDM (BPSK, QPSK, 16QAM, 64QAM,128QAM) 802.11ac: OFDM (BPSK, QPSK, 16QAM, 64QAM,128QAM,256QAM)	
Data Rate	802.11a: 6/9/12/18/24/36/48/54Mbps 802.11n: up to 300Mbps 802.11ac: up to 868.8Mbps	
Number of channels	7 channels of U-NII-1 Band 7 channels of U- NII-2A Band 21 channels of U-NII-2C Band 8 channels of U- NII 3 Band	
Hardware Version	EP-VRM04MB-03	
Software Version	V1.0	
Antenna Designation	PIFA Antenna (Comply with requirements of the FCC part 15.203)	
Antenna Gain	1.82dBi	
Power Supply	DC 3.8V 4500Mah by battery	

Note:

1. This device does not support radar monitoring.
2. The signal loading method between the client device and the Master device is TCP technology.
3. Distribution of start-up time of Master device and client device:

Equipment	Boot time(s)
Passive device(client)	10s
Active device(master)	40s

3. DESCRIPTION OF TEST MODES

The tests in this section are run sequentially and the UUT must pass all tests successfully.

If the UUT fails any one of the tests it will count as a failure of compliance.

To show compliance, all tests must be performed with waveforms randomly generated as specified with test results meeting the required percentage of successful detection criteria.

One frequency will be chosen from the operating Channels of the UUT within the 5250-5350 MHz or 5470-5725 MHz bands.

4. SUMMARY OF TEST RESULTS

FCC RULES	DESCRIPTION OF TEST	RESULT
§15.407(h)(2)	Dynamic Frequency Selection Channel Move Time and Channel Closing Transmission Time	Compliant

5. TEST FACILITY

Test Site	Attestation of Global Compliance (Shenzhen) Co., Ltd
Location	1-2/F, Building 19, Junfeng Industrial Park, Chongqing Road, Heping Community, Fuhai Street, Bao'an District, Shenzhen, Guangdong, China
Designation Number	CN1259
FCC Test Firm Registration Number	975832
A2LA Cert. No.	5054.02
Description	Attestation of Global Compliance(Shenzhen) Co., Ltd is accredited by A2LA

Description	Manufacturer	Model No.	S/N	Calibration Due.	Calibration Due.
MXG X-Series Vector Signal Generator	Agilent	N5182B	MY53050647	Aug. 03, 2022	Aug. 02, 2023
EXA Signal Analyzer	Agilent	N9020A	MY49100060	Aug. 03, 2022	Aug. 02, 2023
Attenuator	ZHINAN	E-002	N/A	Aug. 04, 2022	Aug. 03, 2024
Power splitter	Mini-Circuits	ZFRSC-183-s	3122	N/A	N/A
RF Cable	Harbour	SHWCB-3000-N	N/A	May 13, 2022	May 12, 2023
DFS waveform Generator software	Keysight	N7607C V2.0.0.0	N/A	N/A	N/A
DFS data Analyzer software	Tonscend	JS1120-2	N/A	N/A	N/A
AP(Master)	ZTE	ZXHN F670	N/A	N/A	N/A

FCC ID of AP(Master):**Q78-ZXHNF670E**

Any report having not been signed by authorized approver, or having been altered without authorization, or having not been stamped by the "Dedicated Testing/Inspection Stamp" is deemed to be invalid. Copying or excerpting portion of, or altering the content of the report is not permitted without the written authorization of AGC. The test results presented in the report apply only to the tested sample. Any objections to report issued by AGC should be submitted to AGC within 15days after the issuance of the test report. Further enquiry of validity or verification of the test report should be addressed to AGC by agc01@agccert.com.

6. DYNAMIC FREQUENCY SELECTION (DFS)

6.1. APPLICABILITY OF DFS REQUIREMENTS

Table 1: Applicability of DFS Requirements Prior to Use of a Channel

Requirement	Operational Mode		
	<input type="checkbox"/> Master	<input checked="" type="checkbox"/> Client Without Radar Detection	<input type="checkbox"/> Client With Radar Detection
Non-Occupancy Period	Yes	Not required	Yes
DFS Detection Threshold	Yes	Not required	Yes
Channel Availability Check Time	Yes	Not required	Not required
U-NII Detection Bandwidth	Yes	Not required	Yes

Table 2: Applicability of DFS requirements during normal operation

Requirement	Operational Mode	
	<input type="checkbox"/> Master Device or Client with Radar Detection	<input checked="" type="checkbox"/> Client Without Radar Detection
DFS Detection Threshold	Yes	Not required
Channel Closing Transmission Time	Yes	Yes
Channel Move Time	Yes	Yes
U-NII Detection Bandwidth	Yes	Not required

Additional requirements for devices with multiple bandwidth modes	<input type="checkbox"/> Master Device or Client with Radar Detection	<input checked="" type="checkbox"/> Client Without Radar Detection
U-NII Detection Bandwidth and Statistical Performance Check	All BW modes must be tested	Not required
Channel Move Time and Channel Closing Transmission Time	Test using widest BW mode available	Test using the widest BW mode available for the link
All other tests	Any single BW mode	Not required

Note: Frequencies selected for statistical performance check (Section 7.8.4) should include several frequencies within the radar detection bandwidth and frequencies near the edge of the radar detection bandwidth. For 802.11 devices it is suggested to select frequencies in each of the bonded 20 MHz channels and the channel center frequency.

6.2. TEST SET-UP

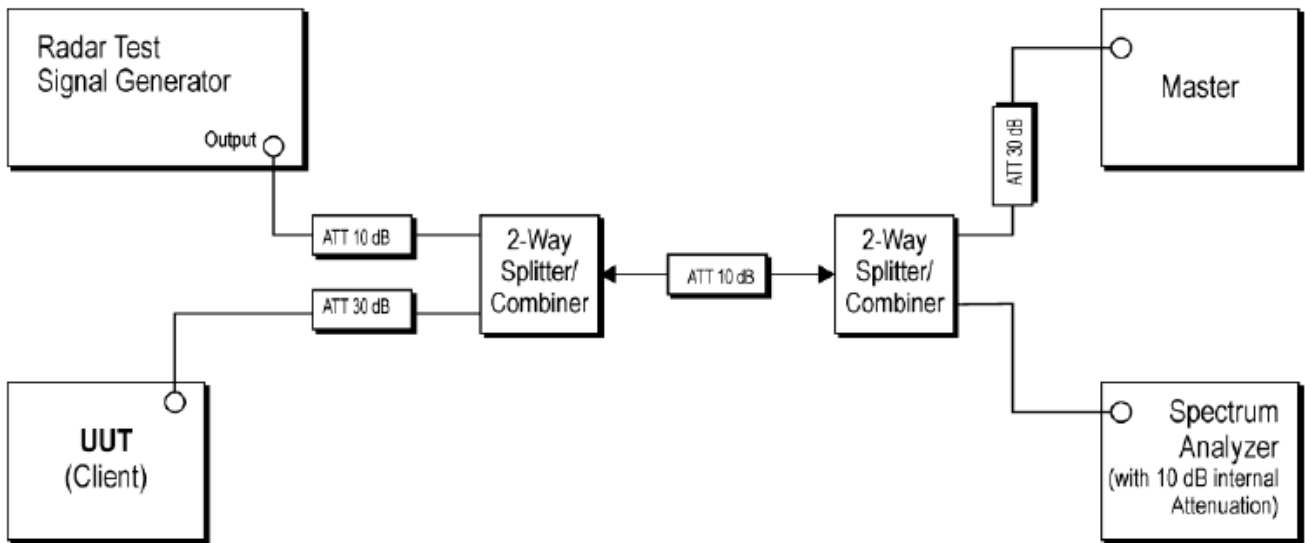

6.3. LIMITS

Table 3: DFS Detection Thresholds for Master Devices and Client Devices with Radar Detection

Maximum Transmit Power	Value (See Notes 1, 2, and 3)
EIRP \geq 200 milliwatt	-64 dBm
EIRP < 200 milliwatt and power spectral density < 10 dBm/MHz	-62 dBm
EIRP < 200 milliwatt that do not meet the power spectral density requirement	-64 dBm

Note 1: This is the level at the input of the receiver assuming a 0 dBi receive antenna.

Note 2: Throughout these test procedures an additional 1 dB has been added to the amplitude of the test transmission waveforms to account for variations in measurement equipment. This will ensure that the test signal is at or above the detection threshold level to trigger a DFS response.

Note3: EIRP is based on the highest antenna gain. For MIMO devices refer to KDB Publication 662911 D01.

Table 4: DFS Response Requirement Values

Parameter	Value
Non-occupancy period	Minimum 30 minutes
Channel Availability Check Time	60 seconds
Channel Move Time	10 seconds See Note 1.
Channel Closing Transmission Time	200 milliseconds + an aggregate of 60 milliseconds over remaining 10 second period. See Notes 1 and 2.
U-NII Detection Bandwidth	Minimum 100% of the U- NII 99% transmission power bandwidth. See Note 3.

Note 1: Channel Move Time and the Channel Closing Transmission Time should be performed with Radar Type 0. The measurement timing begins at the end of the Radar Type 0 burst.

Note 2: The Channel Closing Transmission Time is comprised of 200 milliseconds starting at the beginning of the Channel Move Time plus any additional intermittent control signals required to facilitate a Channel move (an aggregate of 60 milliseconds) during the remainder of the 10 second period. The aggregate duration of control signals will not count quiet periods in between transmissions.

Note 3: During the U-NII Detection Bandwidth detection test, radar type 0 should be used. For each frequency step the minimum percentage of detection is 90 percent. Measurements are performed with no data traffic.

6.4. RADAR TEST WAVEFORMS

Table 5 – Short Pulse Radar Test Waveforms

Radar Type	Pulse Width (μsec)	PRI (μsec)	Number of Pulses	Minimum Percentage of Successful Detection	Minimum Number of Trials
0	1	1428	18	See Note 1	See Note 1

6.5. TEST PROCEDURE

1. When a Client Device without Radar Detection is the UUT, the Master Device is the Radar Detection Device.
2. A spectrum analyzer is used to establish the test signal level for each radar type.
3. During this process, there are no transmissions by either the Master Device or Client Device.
4. The spectrum analyzer is switched to the zero span (time domain) mode at the frequency of the Radar Waveform generator. The peak detector function of the spectrum analyzer is utilized. The spectrum analyzer resolution bandwidth (RBW) and video bandwidth (VBW) are set to at least 3 MHz.
5. The measured channels are 5530MHz in 80MHz Bandwidth and 5290MHz in 80MHz Bandwidth. The Radar signal was the same as transmitted channels, and injected into the antenna port of AP(master) ,measured the DFS parameters. The master transmitted the test data to client, the transmitted duty cycle is 30.8%.

6.6. TEST RESULT

6.6.1 DFS DETECTION THRESHOLD

Calibration:

For a detection threshold level of -64dBm and the antenna gain is 5dBi, required detection threshold is -62dBm (= -64+2).

Note: Maximum Transmit Power is greater than 200 milliwatt in this report, so detection threshold level is -64dBm .

Radar Type 0

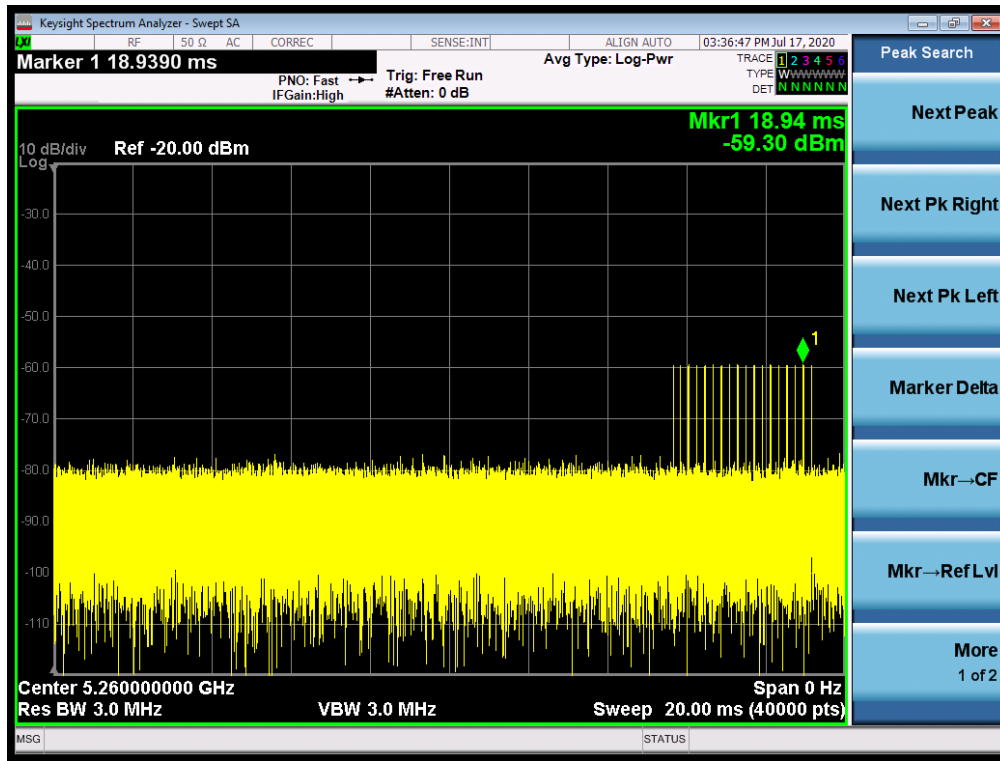

6.6.2 TEST RESULT

Channel Move Time and Channel Closing Transmission Time

Test Frequency	Requirement	Measurement Level	Limit
5260MHz	Channel Closing Transmission Time	0.041	≤0.26s
	Channel Move Time	1.311	≤10s
5500MHz	Channel Closing Transmission Time	0.009	≤0.26s
	Channel Move Time	1.069	≤10s
5290MHz	Channel Closing Transmission Time	0.008	≤0.26s
	Channel Move Time	1.028	≤10s
5530MHz	Channel Closing Transmission Time	0.020	≤0.26s
	Channel Move Time	1.190	≤10s

Any report having not been signed by authorized approver, or having been altered without authorization, or having not been stamped by the "Dedicated Testing/Inspection Stamp" is deemed to be invalid. Copying or excerpting portion of, or altering the content of the report is not permitted without the written authorization of AGC. The test results presented in the report apply only to the tested sample. Any objections to report issued by AGC should be submitted to AGC within 15days after the issuance of the test report. Further enquiry of validity or verification of the test report should be addressed to AGC by agc01@agccert.com.

Radar Type 0(20MHz/5260MHz)

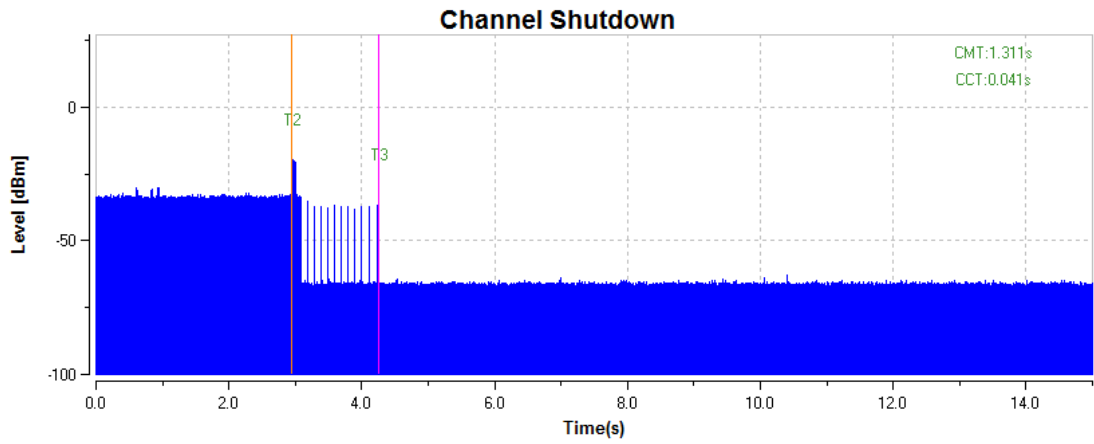

Non-occupancy Period-Elapse time 30minutes

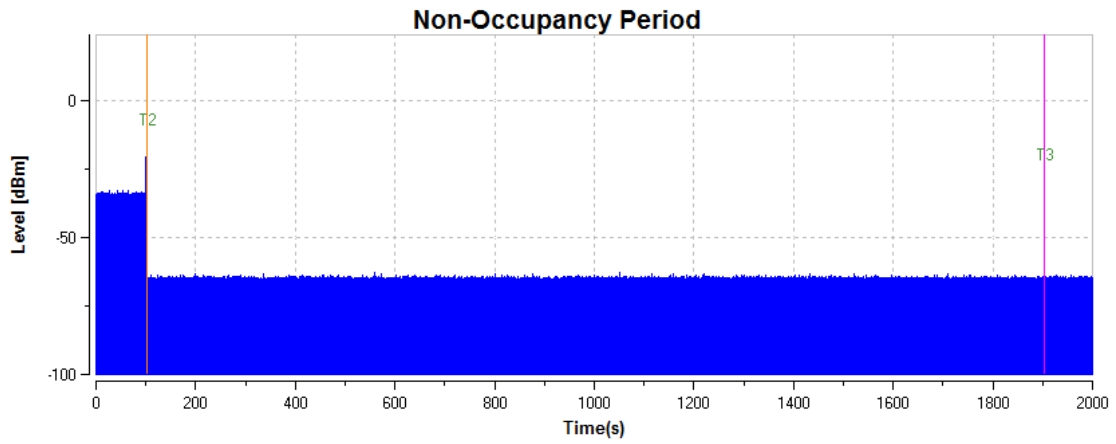

Any report having not been signed by authorized approver, or having been altered without authorization, or having not been stamped by the "Dedicated Testing/Inspection Stamp" is deemed to be invalid. Copying or excerpting portion of, or altering the content of the report is not permitted without the written authorization of AGC. The test results presented in the report apply only to the tested sample. Any objections to report issued by AGC should be submitted to AGC within 15days after the issuance of the test report. Further enquiry of validity or verification of the test report should be addressed to AGC by agc01@agccert.com.

Radar Type 0(20MHz/5500MHz)

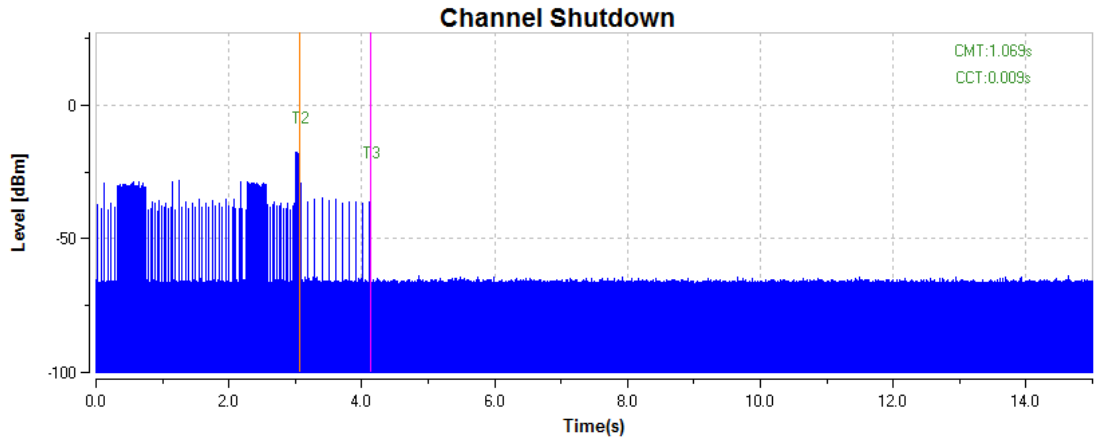

Non-occupancy Period-Elapse time 30minutes

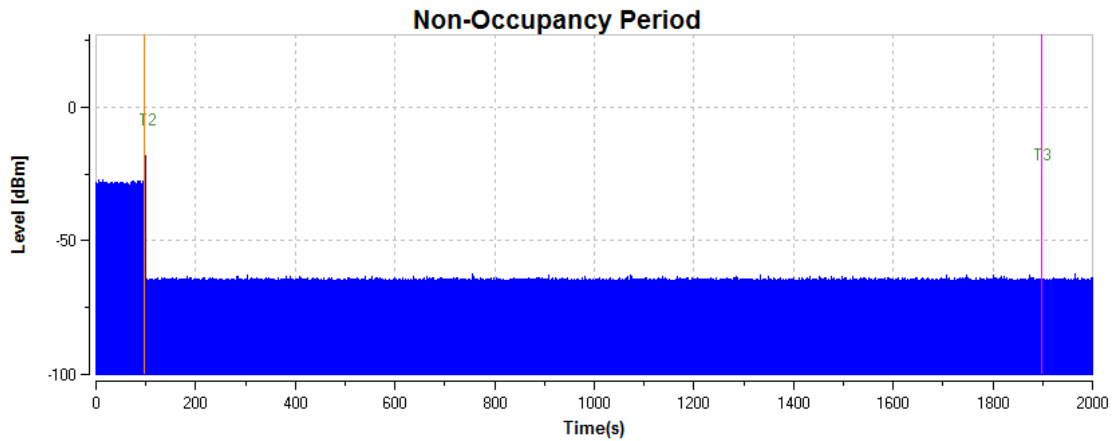

Any report having not been signed by authorized approver, or having been altered without authorization, or having not been stamped by the "Dedicated Testing/Inspection Stamp" is deemed to be invalid. Copying or excerpting portion of, or altering the content of the report is not permitted without the written authorization of AGC. The test results presented in the report apply only to the tested sample. Any objections to report issued by AGC should be submitted to AGC within 15days after the issuance of the test report. Further enquiry of validity or verification of the test report should be addressed to AGC by agc01@agccert.com.

Radar Type 0(80MHz/5290MHz)

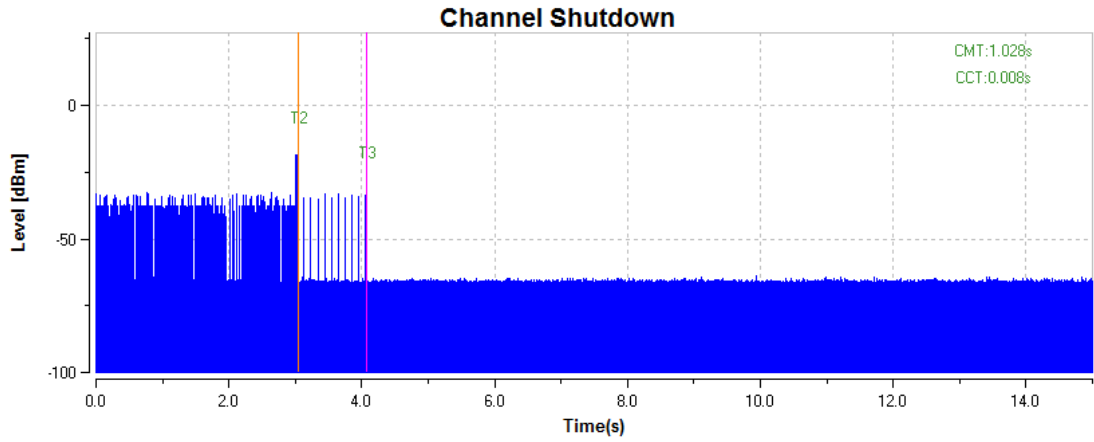

Non-occupancy Period-Elapse time 30minutes

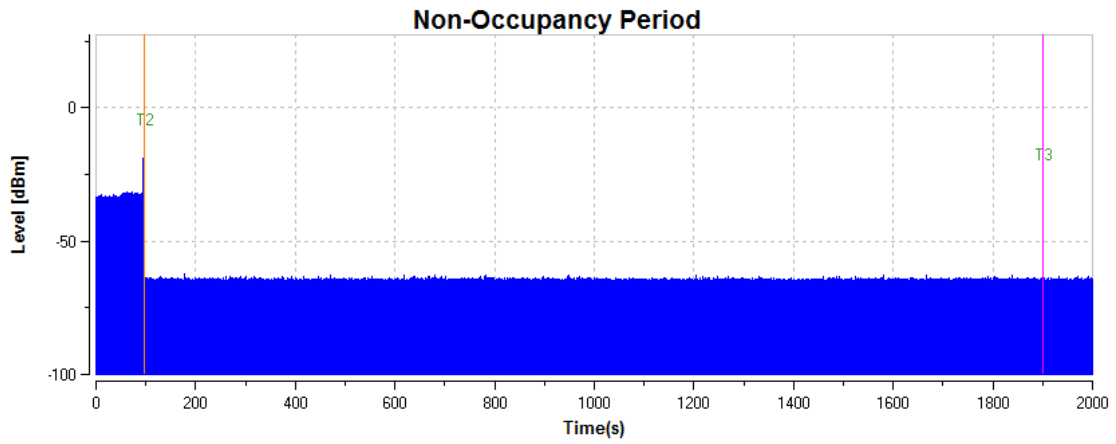

Any report having not been signed by authorized approver, or having been altered without authorization, or having not been stamped by the "Dedicated Testing/Inspection Stamp" is deemed to be invalid. Copying or excerpting portion of, or altering the content of the report is not permitted without the written authorization of AGC. The test results presented in the report apply only to the tested sample. Any objections to report issued by AGC should be submitted to AGC within 15days after the issuance of the test report. Further enquiry of validity or verification of the test report should be addressed to AGC by agc01@agccert.com.

Radar Type 0(80MHz/5530MHz)

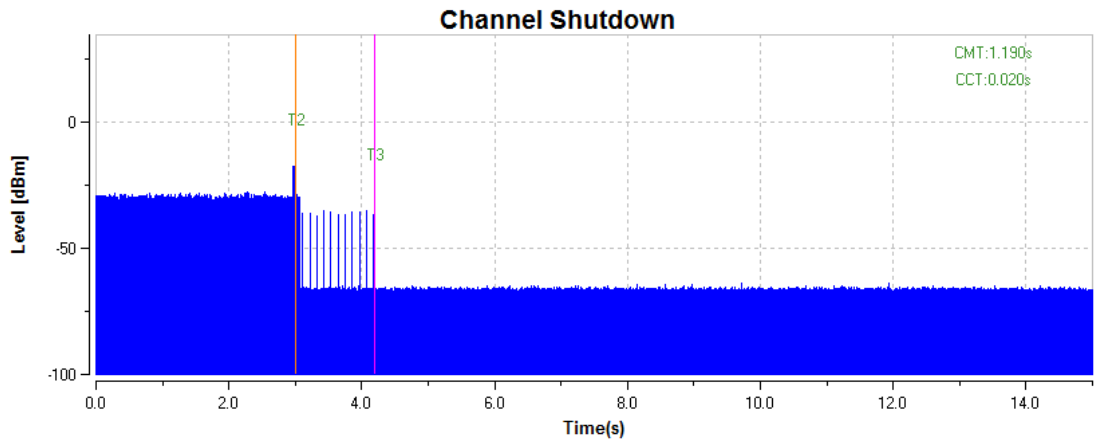

Non-occupancy Period-Elapse time 30minutes

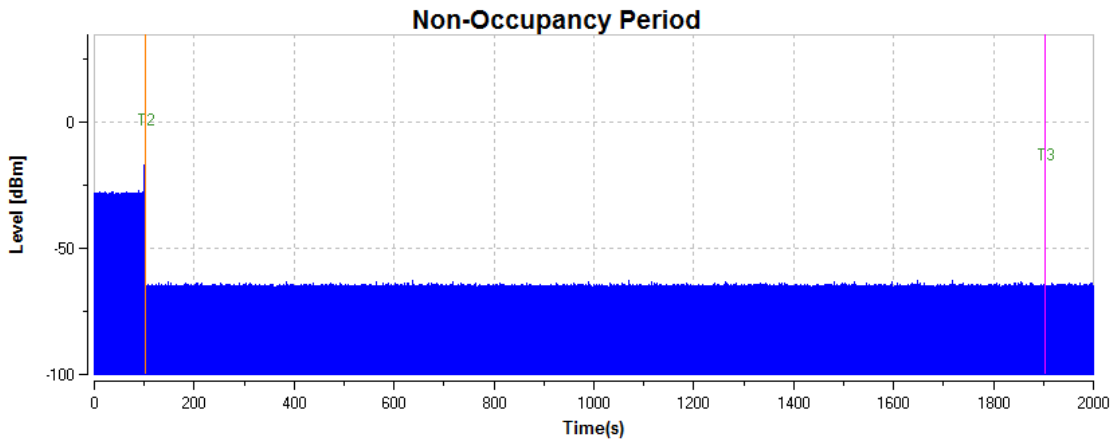

RESULT: PASS

Any report having not been signed by authorized approver, or having been altered without authorization, or having not been stamped by the "Dedicated Testing/Inspection Stamp" is deemed to be invalid. Copying or excerpting portion of, or altering the content of the report is not permitted without the written authorization of AGC. The test results presented in the report apply only to the tested sample. Any objections to report issued by AGC should be submitted to AGC within 15days after the issuance of the test report. Further enquiry of validity or verification of the test report should be addressed to AGC by agc01@agccert.com.

APPENDIX A: PHOTOGRAPHS OF TEST SETUP

Refer to the Report No.: AGC02762220807AP01

APPENDIX B: PHOTOGRAPHS OF EUT

Refer to the Report No.: AGC02762220807AP02

----END OF REPORT----

Any report having not been signed by authorized approver, or having been altered without authorization, or having not been stamped by the "Dedicated Testing/Inspection Stamp" is deemed to be invalid. Copying or excerpting portion of, or altering the content of the report is not permitted without the written authorization of AGC. The test results presented in the report apply only to the tested sample. Any objections to report issued by AGC should be submitted to AGC within 15days after the issuance of the test report. Further enquiry of validity or verification of the test report should be addressed to AGC by agc01@agccert.com.

Attestation of Global Compliance(Shenzhen)Co., Ltd

Attestation of Global Compliance(Shenzhen)Std & Tech Co., Ltd

Tel: +86-755 2523 4088 E-mail: agc@agccert.com Web: <http://www.agccert.com/>



Conditions of Issuance of Test Reports

1. All samples and goods are accepted by the Attestation of Global Compliance (Shenzhen) Co., Ltd. (the “Company”) solely for testing and reporting in accordance with the following terms and conditions. The company provides its services on the basis that such terms and conditions constitute express agreement between the company and any person, firm or company requesting its services (the “Clients”).
2. Any report issued by Company as a result of this application for testing services (the “Report”) shall be issued in confidence to the Clients and the Report will be strictly treated as such by the Company. It may not be reproduced either in its entirety or in part and it may not be used for advertising or other unauthorized purposes without the written consent of the Company. The Clients to whom the Report is issued may, however, show or send it, or a certified copy thereof prepared by the Company to its customer, supplier or other persons directly concerned. The Company will not, without the consent of the Clients, enter into any discussion or correspondence with any third party concerning the contents of the Report, unless required by the relevant governmental authorities, laws or court orders.
3. The Company shall not be called or be liable to be called to give evidence or testimony on the Report in a court of law without its prior written consent, unless required by the relevant governmental authorities, laws or court orders.
4. In the event of the improper use of the report as determined by the Company, the Company reserves the right to withdraw it, and to adopt any other additional remedies which may be appropriate.
5. Samples submitted for testing are accepted on the understanding that the Report issued cannot form the basis of, or be the instrument for, any legal action against the Company.
6. The Company will not be liable for or accept responsibility for any loss or damage however arising from the use of information contained in any of its Reports or in any communication whatsoever about its said tests or investigations.
7. Clients wishing to use the Report in court proceedings or arbitration shall inform the Company to that effect prior to submitting the sample for testing.
8. The Company is not responsible for recalling the electronic version of the original report when any revision is made to them. The Client assumes the responsibility to providing the revised version to any interested party who uses them.
9. Subject to the variable length of retention time for test data and report stored hereinto as otherwise specifically required by individual accreditation authorities, the Company will only keep the supporting test data and information of the test report for a period of six years. The data and information will be disposed of after the aforementioned retention period has elapsed. Under no circumstances shall we provide any data and information which has been disposed of after retention period. Under no circumstances shall we be liable for damage of any kind, including (but not limited to) compensatory damages, lost profits, lost data, or any form of special, incidental, indirect, consequential or punitive damages of any kind, whether based on breach of contract of warranty, tort (including negligence), product liability or otherwise, even if we are informed in advance of the possibility of such damages.

Any report having not been signed by authorized approver, or having been altered without authorization, or having not been stamped by the “Dedicated Testing/Inspection Stamp” is deemed to be invalid. Copying or excerpting portion of, or altering the content of the report is not permitted without the written authorization of AGC. The test results presented in the report apply only to the tested sample. Any objections to report issued by AGC should be submitted to AGC within 15days after the issuance of the test report. Further enquiry of validity or verification of the test report should be addressed to AGC by agc01@agccert.com.