

---

# SAR Test Report

---

Report No.: AGC02762220807FH01

**FCC ID** : 2AL26-K6

**APPLICATION PURPOSE** : Original Equipment

**PRODUCT DESIGNATION** : Body Worn Camera

**BRAND NAME** : Reveal Media

**MODEL NAME** : K6

**APPLICANT** : Reveal Media Limited

**DATE OF ISSUE** : Oct. 13,2022

**STANDARD(S)** : IEEE Std. 1528:2013  
FCC 47 CFR Part 2§2.1093  
IEEE Std C95.1™-2005

**REPORT VERSION** : V1.0

Attestation of Global Compliance(Shenzhen) Co., Ltd.



Any report having not been signed by authorized approver, or having been altered without authorization, or having not been stamped by the "Dedicated Testing/Inspection Stamp" is deemed to be invalid. Copying or excerpting portion of, or altering the content of the report is not permitted without the written authorization of AGC. The test results presented in the report apply only to the tested sample. Any objections to report issued by AGC should be submitted to AGC within 15days after the issuance of the test report. Further enquiry of validity or verification of the test report should be addressed to AGC by [agc01@agccert.com](mailto:agc01@agccert.com).

Attestation of Global Compliance(Shenzhen)Co., Ltd  
Attestation of Global Compliance(Shenzhen)Std & Tech Co., Ltd  
Tel: +86-755 2523 4088 E-mail: [agc@agccert.com](mailto:agc@agccert.com) Web: <http://www.agccert.com/>



**Report Revise Record**

Report Version	Revise Time	Issued Date	Valid Version	Notes
V1.0	/	Oct. 13,2022	Valid	Initial Release

Any report having not been signed by authorized approver, or having been altered without authorization, or having not been stamped by the "Dedicated Testing/Inspection Stamp" is deemed to be invalid. Copying or excerpting portion of, or altering the content of the report is not permitted without the written authorization of AGC. The test results presented in the report apply only to the tested sample. Any objections to report issued by AGC should be submitted to AGC within 15days after the issuance of the test report. Further enquiry of validity or verification of the test report should be addressed to AGC by [agc01@agccert.com](mailto:agc01@agccert.com).

Test Report	
Applicant Name	Reveal Media Limited
Applicant Address	Riverview House, 20 Old Bridge Street, Hampton Wick, KT1 4BU, UNITED KINGDOM
Manufacturer Name	Reveal Media Hong Kong Ltd.
Manufacturer Address	6/F.,Luk Kwok Centre,72 Gloucester Road, Wan Chai, Hong Kong
Factory Name	Reveal Media Hong Kong Ltd.
Factory Address	6/F.,Luk Kwok Centre,72 Gloucester Road, Wan Chai, Hong Kong
Product Designation	Body Worn Camera
Brand Name	Reveal Media
Model Name	K6
EUT Voltage	DC3.8V by battery
Applicable Standard	IEEE Std. 1528:2013 FCC 47 CFR Part 2§2.1093 IEEE Std C95.1™-2005
Date of receipt of test item	Aug. 17, 2022
Test Date	Sep. 20,2022 to Sep. 29,2022
Report Template	AGCRT-US-5G/SAR (2021-04-20)

Note: The results of testing in this report apply to the product/system which was tested only.



Prepared By

Jack Gui (Project Engineer)

Sep. 29,2022



Reviewed By

Calvin Liu (Reviewer)

Oct. 13,2022



Approved By

Max Zhang (Authorized Officer)

Oct. 13,2022

Any report having not been signed by authorized approver, or having been altered without authorization, or having not been stamped by the "Dedicated Testing/Inspection Stamp" is deemed to be invalid. Copying or excerpting portion of, or altering the content of the report is not permitted without the written authorization of AGC. The test results presented in the report apply only to the tested sample. Any objections to report issued by AGC should be submitted to AGC within 15days after the issuance of the test report. Further enquiry of validity or verification of the test report should be addressed to AGC by agc01@agccert.com.

Attestation of Global Compliance(Shenzhen)Co., Ltd

Attestation of Global Compliance(Shenzhen)Std & Tech Co., Ltd

Tel: +86-755 2523 4088 E-mail: agc@agccert.com Web: http://www.agccert.com/

## TABLE OF CONTENTS

<b>1. SUMMARY OF MAXIMUM SAR VALUE .....</b>	<b>5</b>
<b>2. GENERAL INFORMATION.....</b>	<b>6</b>
2.1. EUT DESCRIPTION.....	6
<b>3. SAR MEASUREMENT SYSTEM.....</b>	<b>7</b>
3.1. THE SATIMO SYSTEM USED FOR PERFORMING COMPLIANCE TESTS CONSISTS OF FOLLOWING ITEMS .....	7
3.2. COMOSAR E-FIELD PROBE .....	8
3.3. ROBOT.....	8
3.4. VIDEO POSITIONING SYSTEM .....	9
3.5. DEVICE HOLDER .....	9
3.6. SAM TWIN PHANTOM.....	10
<b>4. SAR MEASUREMENT PROCEDURE.....</b>	<b>11</b>
4.1. SPECIFIC ABSORPTION RATE (SAR).....	11
4.2. SAR MEASUREMENT PROCEDURE .....	12
4.3. RF EXPOSURE CONDITIONS .....	13
<b>5. TISSUE SIMULATING LIQUID.....</b>	<b>14</b>
5.1. THE COMPOSITION OF THE TISSUE SIMULATING LIQUID.....	14
5.2. TISSUE DIELECTRIC PARAMETERS FOR HEAD AND BODY PHANTOMS .....	14
5.3. TISSUE CALIBRATION RESULT .....	15
<b>6. SAR SYSTEM CHECK PROCEDURE .....</b>	<b>17</b>
6.1. SAR SYSTEM CHECK PROCEDURES .....	17
6.2. SAR SYSTEM CHECK.....	18
<b>7. EUT TEST POSITION.....</b>	<b>20</b>
7.1. BODY WORN POSITION .....	20
<b>8. SAR EXPOSURE LIMITS .....</b>	<b>21</b>
<b>9. TEST FACILITY .....</b>	<b>22</b>
<b>10. TEST EQUIPMENT LIST .....</b>	<b>23</b>
<b>11. MEASUREMENT UNCERTAINTY .....</b>	<b>24</b>
<b>12. CONDUCTED POWER MEASUREMENT.....</b>	<b>27</b>
<b>13. TEST RESULTS.....</b>	<b>31</b>
13.1. SAR TEST RESULTS SUMMARY.....	31
<b>APPENDIX A. SAR SYSTEM CHECK DATA .....</b>	<b>38</b>
<b>APPENDIX B. SAR MEASUREMENT DATA.....</b>	<b>48</b>
<b>APPENDIX C. TEST SETUP PHOTOGRAPHS.....</b>	<b>58</b>
<b>APPENDIX D. CALIBRATION DATA .....</b>	<b>62</b>

Any report having not been signed by authorized approver, or having been altered without authorization, or having not been stamped by the “Dedicated Testing/Inspection Stamp” is deemed to be invalid. Copying or excerpting portion of, or altering the content of the report is not permitted without the written authorization of AGC. The test results presented in the report apply only to the tested sample. Any objections to report issued by AGC should be submitted to AGC within 15days after the issuance of the test report. Further enquiry of validity or verification of the test report should be addressed to AGC by [agc01@agccert.com](mailto:agc01@agccert.com).

## 1. SUMMARY OF MAXIMUM SAR VALUE

The maximum results of Specific Absorption Rate (SAR) found during testing for EUT are as follows:

Frequency Band	Highest Reported 1g-SAR(W/kg)	SAR Test Limit (W/kg)
	Body-worn(with 0mm separation)	
2.4 GHz WIFI	0.320	1.6
5.2 GHz WIFI	0.667	
5.3 GHz WIFI	0.636	
5.6 GHz WIFI	0.638	
5.8 GHz WIFI	0.542	
<b>SAR Test Result</b>	<b>PASS</b>	

This device is compliance with Specific Absorption Rate (SAR) for general population/uncontrolled exposure limits (1.6W/kg) specified in IEEE Std. 1528:2013; FCC 47CFR § 2.1093; IEEE/ANSI C95.1:2005 and the following specific FCC Test Procedures:

- KDB 447498 D01 General RF Exposure Guidance v06
- KDB 865664 D01 SAR Measurement 100MHz to 6GHz v01r04
- KDB 248227 D01 802 11 Wi-Fi SAR v02r02

Any report having not been signed by authorized approver, or having been altered without authorization, or having not been stamped by the "Dedicated Testing/Inspection Stamp" is deemed to be invalid. Copying or excerpting portion of, or altering the content of the report is not permitted without the written authorization of AGC. The test results presented in the report apply only to the tested sample. Any objections to report issued by AGC should be submitted to AGC within 15days after the issuance of the test report. Further enquiry of validity or verification of the test report should be addressed to AGC by agc01@agccert.com.

## 2. GENERAL INFORMATION

### 2.1. EUT Description

General Information	
Product Designation	Body Worn Camera
Test Model	K6
Hardware Version	EP-VRM04MB-03
Software Version	V1.0
Device Category	Portable
RF Exposure Environment	Uncontrolled
Antenna Type	Internal
Bluetooth	
Operation Frequency	2402~2480MHz
Antenna Gain	-2.6dBi
Bluetooth Version	V4.2
Type of modulation	<b>BLE:</b> GFSK
EIRP	<b>BLE:</b> 3.980dBm
2.4GHz WIFI	
WIFI Specification	<input type="checkbox"/> 802.11a <input checked="" type="checkbox"/> 802.11b <input checked="" type="checkbox"/> 802.11g <input checked="" type="checkbox"/> 802.11n(20) <input checked="" type="checkbox"/> 802.11n(40)
Operation Frequency	2412~2472MHz
EIRP	11b: 14.80dBm,11g: 14.03dBm,11n(20): 13.80dBm,11n(40): 13.68dBm
Antenna Gain	1.15dBi
5GHz WIFI	
WIFI Specification	<input checked="" type="checkbox"/> 802.11a <input checked="" type="checkbox"/> 802.11n20 <input checked="" type="checkbox"/> 802.11ac20 <input checked="" type="checkbox"/> 802.11n40 <input checked="" type="checkbox"/> 802.11ac40 <input checked="" type="checkbox"/> 802.11ac80
Operation Frequency	5.2GHz: 5180MHz~5240MHz; 5.3GHz: 5260MHz~5320MHz; 5.6GHz: 5470MHz~5725MHz; 5.8GHz: 5745MHz~5825MHz
Modulation type	802.11a/n:64-QAM, 16-QAM, QPSK, BPSK 802.11ac:256-QAM, 64-QAM, 16-QAM, QPSK, BPSK
EIRP	5.2G WIFI: 12.81 dBm; 5.3G WIFI: 11.95dBm; 5.6G WIFI: 11.98 dBm; 5.8G WIFI: 11.21 dBm
Antenna Gain	1.82dBi
Battery	Brand name: N/A Model No. : IBR036GA Voltage and Capacitance: 3.8 V & 4500mAh

Note: 1.The sample used for testing is end product.

2. The test sample has no any deviation to the test method of standard mentioned in page 1.

Product	Type
	<input checked="" type="checkbox"/> Production unit <input type="checkbox"/> Identical Prototype

Any report having not been signed by authorized approver, or having been altered without authorization, or having not been stamped by the "Dedicated Testing/Inspection Stamp" is deemed to be invalid. Copying or excerpting portion of, or altering the content of the report is not permitted without the written authorization of AGC. The test results presented in the report apply only to the tested sample. Any objections to report issued by AGC should be submitted to AGC within 15days after the issuance of the test report. Further enquiry of validity or verification of the test report should be addressed to AGC by agc01@agccert.com.

Attestation of Global Compliance(Shenzhen)Co., Ltd

Attestation of Global Compliance(Shenzhen)Std & Tech Co., Ltd

Tel: +86-755 2523 4088 E-mail: agc@agccert.com Web: http://www.agccert.com/

### 3. SAR MEASUREMENT SYSTEM

#### 3.1. The SATIMO system used for performing compliance tests consists of following items

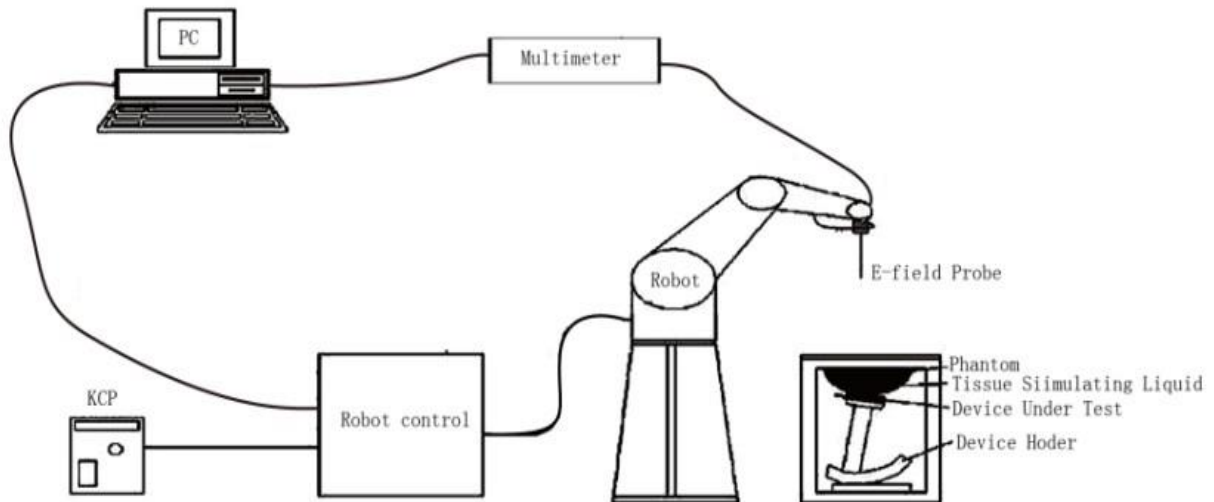

The COMOSAR system for performing compliance tests consists of the following items:

- The PC. It controls most of the bench devices and stores measurement data. A computer running WinXP and the Opensar software.
- The E-Field probe. The probe is a 3-axis system made of 3 distinct dipoles. Each dipole returns a voltage in function of the ambient electric field.
- The Keithley multimeter measures each probe dipole voltages.
- The SAM phantom simulates a human head. The measurement of the electric field is made inside the phantom.
- The liquids simulate the dielectric properties of the human head tissues.
- The network emulator controls the mobile phone under test.
- The validation dipoles are used to measure a reference SAR. They are used to periodically check the bench to make sure that there is no drift of the system characteristics over time.
- The phantom, the device holder and other accessories according to the targeted measurement.

### 3.2. COMOSAR E-Field Probe

The SAR measurement is conducted with the dosimetric probe manufactured by SATIMO. The probe is specially designed and calibrated for use in liquid with high permittivity. The dosimetric probe has special calibration in liquid at different frequency. SATIMO conducts the probe calibration in compliance with international and national standards (e.g. IEEE1528 etc.) Under ISO17025. The calibration data are in Appendix D.

#### Isotropic E-Field Probe Specification

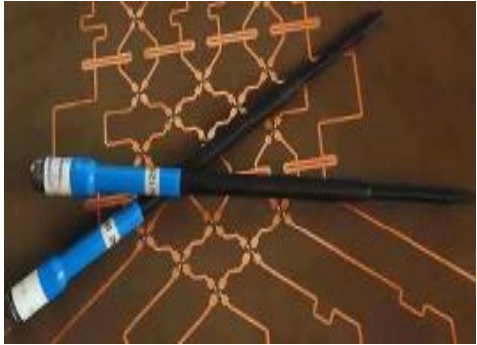
<b>Model</b>	SSE2	
<b>Manufacture</b>	MVG	
<b>Identification No.</b>	SN 13/22 EPGO368	
<b>Frequency</b>	0.15GHz-6GHz Linearity:±0.09dB(0.15GHz-6GHz)	
<b>Dynamic Range</b>	0.01W/kg-100W/kg Linearity:±0.09dB	
<b>Dimensions</b>	Overall length:330mm Length of individual dipoles:2mm Maximum external diameter:8mm Probe Tip external diameter:2.5mm Distance between dipoles/ probe extremity:1mm	
<b>Application</b>	High precision dosimetric measurements in any exposure scenario (e.g., very strong gradient fields). Only probe which enables compliance testing for frequencies up to 6 GHz with precision of better 30%.	

### 3.3. Robot

<p>The COMOSAR system uses the KUKA robot from SATIMO SA (France). For the 6-axis controller COMOSAR system, the KUKA robot controller version from SATIMO is used. The XL robot series have many features that are important for our application:</p> <ul style="list-style-type: none"> <li><input type="checkbox"/> High precision (repeatability 0.02 mm)</li> <li><input type="checkbox"/> High reliability (industrial design)</li> <li><input type="checkbox"/> Jerk-free straight movements</li> <li><input type="checkbox"/> Low ELF interference (the closed metallic construction shields against motor control fields)</li> <li><input type="checkbox"/> 6-axis controller</li> </ul>	
---	---

Any report having not been signed by authorized approver, or having been altered without authorization, or having not been stamped by the "Dedicated Testing/Inspection Stamp" is deemed to be invalid. Copying or excerpting portion of, or altering the content of the report is not permitted without the written authorization of AGC. The test results presented in the report apply only to the tested sample. Any objections to report issued by AGC should be submitted to AGC within 15 days after the issuance of the test report. Further enquiry of validity or verification of the test report should be addressed to AGC by agc01@agccert.com.



### 3.4. Video Positioning System

The video positioning system is used in OpenSAR to check the probe. Which is composed of a camera, LED, mirror and mechanical parts. The camera is piloted by the main computer with firewire link. During the process, the actual position of the probe tip with respect to the robot arm is measured, as well as the probe length and the horizontal probe offset. The software then corrects all movements, such that the robot coordinates are valid for the probe tip. The repeatability of this process is better than 0.1 mm. If a position has been taught with an aligned probe, the same position will be reached with another aligned probe within 0.1 mm, even if the other probe has different dimensions. During probe rotations, the probe tip will keep its actual position.

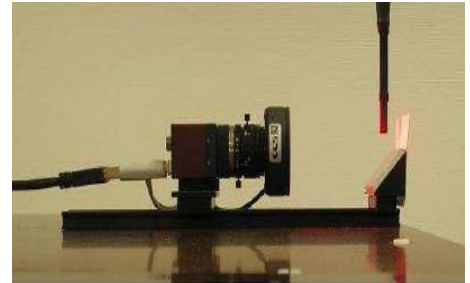

### 3.5. Device Holder

The COMOSAR device holder is designed to cope with different positions given in the standard. It has two scales for the device rotation (with respect to the body axis) and the device inclination (with respect to the line between the ear reference points). The rotation center for both scales is the ear reference point (EPR). Thus the device needs no repositioning when changing the angles. The COMOSAR device holder has been made out of low-loss POM material having the following dielectric parameters: relative permittivity  $\epsilon_r = 3$  and loss tangent  $\delta = 0.02$ . The amount of dielectric material has been reduced in the closest vicinity of the device, since measurements have suggested that the influence of the clamp on the test results could thus be lowered.

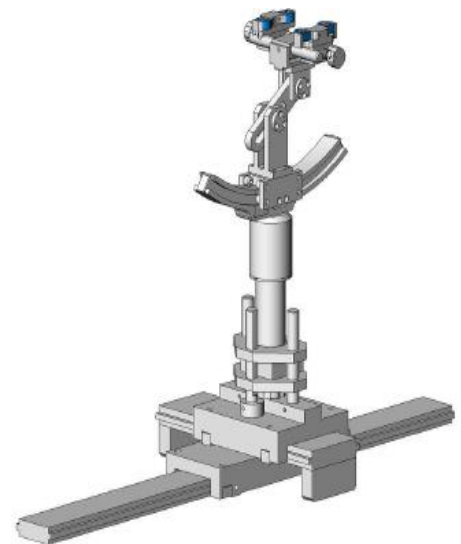

### 3.6. SAM Twin Phantom

The SAM twin phantom is a fiberglass shell phantom with 2mm shell thickness (except the ear region where shell thickness increases to 6mm). It has three measurement areas:

- Left head
- Right head
- Flat phantom



The bottom plate contains three pair of bolts for locking the device holder. The device holder positions are adjusted to the standard measurement positions in the three sections. A white cover is provided to tap the phantom during off-periods to prevent water evaporation and changes in the liquid parameters. On the phantom top, three reference markers are provided to identify the phantom position with respect to the robot.

## 4. SAR MEASUREMENT PROCEDURE

### 4.1. Specific Absorption Rate (SAR)

SAR is related to the rate at which energy is absorbed per unit mass in object exposed to a radio field. The SAR distribution in a biological body is complicated and is usually carried out by experimental techniques or numerical modeling. The standard recommends limits for two tiers of groups, occupational/controlled and occupational/uncontrolled, based on a person's awareness and ability to exercise control over his or her exposure. In general, occupational/controlled exposure limits are higher than the limits for general population/uncontrolled.

The SAR definition is the time derivative (rate) of the incremental energy (dW) absorbed by (dissipated in) an incremental mass (dm) contained in a volume element(dv) of given mass density (ρ). The equation description is as below:

$$SAR = \frac{d}{dt} \left( \frac{dW}{dm} \right) = \frac{d}{dt} \left( \frac{dW}{\rho dV} \right)$$

SAR is expressed in units of Watts per kilogram (W/kg)

SAR can be obtained using either of the following equations:

$$SAR = \frac{\sigma E^2}{\rho}$$

$$SAR = c_h \left. \frac{dT}{dt} \right|_{t=0}$$

Where

SAR	is the specific absorption rate in watts per kilogram;
E	is the r.m.s. value of the electric field strength in the tissue in volts per meter;
σ	is the conductivity of the tissue in siemens per metre;
ρ	is the density of the tissue in kilograms per cubic metre;
c <sub>h</sub>	is the heat capacity of the tissue in joules per kilogram and Kelvin;
$\left. \frac{dT}{dt} \right _{t=0}$	is the initial time derivative of temperature in the tissue in kelvins per second

## 4.2. SAR Measurement Procedure

### Step 1: Power Reference Measurement

The Power Reference Measurement and Power Drift Measurement are for monitoring the power drift of the device under test in the batch process. The minimum distance of probe sensors to surface is 2.7mm This distance cannot be smaller than the distance of sensor calibration points to probe tip as defined in the probe properties,

### Step 2: Area Scan

The Area Scan is used as a fast scan in two dimensions to find the area of high field values, before doing a fine measurement around the hot spot. The sophisticated interpolation routines implemented in SATIMO software can find the maximum locations even in relatively coarse grids. When an Area Scan has measured all reachable points, it computes the field maximal found in the scanned area, within a range of the global maximum. The range (in db) is specified in the standards for compliance testing. For example, a 2db range is required in EN 50360 and IEC62209 standards, whereby 3db is a requirement when compliance is assessed in accordance with the ARIB standard (Japan) If one Zoom Scan follows the Area Scan, then only the absolute maximum will be taken as reference. For cases where multiple maximum are detected, the number of Zoom Scan has to be increased accordingly.

measure the SAR distribution within the phantom (area scan procedure). The SAR distribution is scanned along the inside surface of one side of the phantom head, at least for an area larger than the projection of the handset and antenna. The spatial grid step shall be less than 20 mm. The resolution accuracy can also be tested using the reference functions of 7.2.4. If surface scanning is used, then the distance between the geometrical centre of the probe dipoles and the inner surface of the phantom shall be 8,0 mm or less ( $\pm 1,0$  mm). At all measurement points, the angle of the probe with respect to the line normal to the surface is recommended but not required to be less than 30°.

### Step 3: Zoom Scan

Zoom Scan are used to assess the peak spatial SAR value within a cubic average volume containing 1g and 10g of simulated tissue. The Zoom Scan measures points (refer to table below) within a cube whose base faces are centered on the maxima found in a preceding area scan job within the same procedure. When the measurement is done, the Zoom Scan evaluates the averaged SAR for 1g and 10g and displays these values next to the job's label.

measure SAR with a grid step of 8 mm or less in a volume with a minimum size of 30 mm by 30 mm and 30 mm in depth (zoom scan procedure). The grid step in the vertical direction shall be 5 mm or less (see C.3.3). Separate grids shall be centred on each of the local SAR maxima found in step c).

### Step 4: Power Drift Measurement

The Power Drift Measurement measures the field at the same location as the most recent power reference measurement within the same procedure, and with the same settings. The Power Drift Measurement gives the field difference in dB from the reading conducted within the same settings. This allows a user to monitor the power drift of the device under test within a batch process. The measurement procedure is the same as Step 1.

### 4.3. RF Exposure Conditions

Test Configuration and setting:

The device is a Body Worn Camera which support 2.4GHz & 5G Wifi, Bluetooth;

For SAR testing, the EUT is configured with the WLAN continuous TX tool through qualcomm software.

Due the BT power is less than exemption limit, SAR is not required.

#### Antenna Location: (the back view)

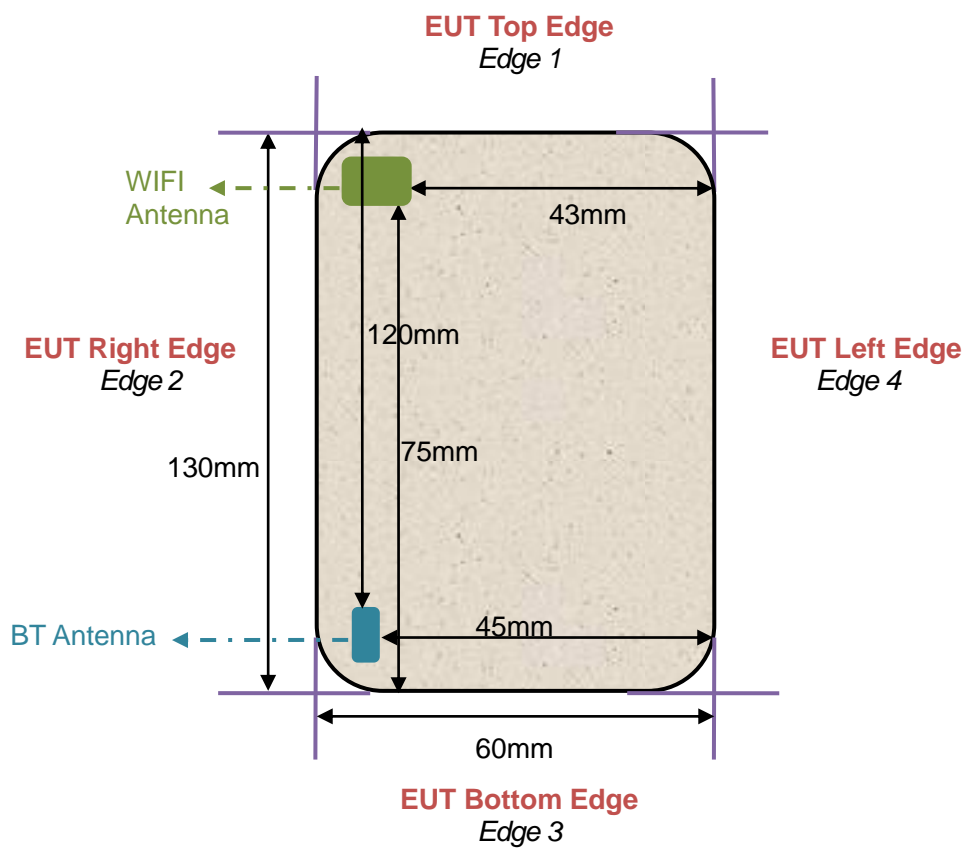

Any report having not been signed by authorized approver, or having been altered without authorization, or having not been stamped by the "Dedicated Testing/Inspection Stamp" is deemed to be invalid. Copying or excerpting portion of, or altering the content of the report is not permitted without the written authorization of AGC. The test results presented in the report apply only to the tested sample. Any objections to report issued by AGC should be submitted to AGC within 15days after the issuance of the test report. Further enquiry of validity or verification of the test report should be addressed to AGC by agc01@agccert.com.

Attestation of Global Compliance(Shenzhen)Co., Ltd

Attestation of Global Compliance(Shenzhen)Std & Tech Co., Ltd

Tel: +86-755 2523 4088 E-mail: agc@agccert.com Web: http://www.agccert.com/

## 5. TISSUE SIMULATING LIQUID

For SAR measurement of the field distribution inside the phantom, the phantom must be filled with homogeneous tissue simulating liquid to a depth of at least 15cm. For head SAR testing the liquid height from the ear reference point (ERP) of the phantom to the liquid top surface is larger than 15cm For body SAR testing, the liquid height from the center of the flat phantom to the liquid top surface is larger than 15cm. The nominal dielectric values of the tissue simulating liquids in the phantom and the tolerance of 5% are listed in 5.2

### 5.1. The composition of the tissue simulating liquid

Ingredient (% Weight) Frequency (MHz)	Water	NaCl	Polysorbate 20	DGBE	1,2- Propanediol	Triton X-100	Diethylen glycol monohex ylether
2450 Head	71.88	0.16	0.0	7.99	0.0	19.97	0.0
2450 Body	70	1	0.0	9	0.0	20	0.0
5000 Head	65.52	0.0	0.0	0.0	0.0	17.24	17.24
5000 Body	80	0.0	0.0	10	0.0	10	0.0

### 5.2. Tissue Dielectric Parameters for Head and Body Phantoms

The head tissue dielectric parameters recommended by the IEEE 1528 have been incorporated in the following table. These head parameters are derived from planar layer models simulating the highest expected SAR for the dielectric properties and tissue thickness variations in a human head. Other head and body tissue parameters that have not been specified in IEEE 1528 are derived from the tissue dielectric parameters computed from the 4-Cole-Cole equations described in Reference [12] and extrapolated according to the head parameters specified in IEEE 1528.

Target Frequency (MHz)	head		body	
	$\epsilon_r$	$\sigma$ (S/m)	$\epsilon_r$	$\sigma$ (S/m)
300	45.3	0.87	45.3	0.87
450	43.5	0.87	43.5	0.87
835	41.5	0.90	41.5	0.90
900	41.5	0.97	41.5	0.97
1450	40.5	1.20	40.5	1.20
1800 – 2000	40.0	1.40	40.0	1.40
<b>2450</b>	<b>39.2</b>	<b>1.80</b>	<b>52.7</b>	<b>1.95</b>
3000	38.5	2.40	38.5	2.40
<b>5200</b>	<b>36.0</b>	<b>4.66</b>	<b>49.0</b>	<b>5.30</b>
<b>5300</b>	<b>35.9</b>	<b>4.76</b>	<b>48.9</b>	<b>5.42</b>
<b>5600</b>	<b>35.5</b>	<b>5.07</b>	<b>48.5</b>	<b>5.77</b>
<b>5800</b>	<b>35.3</b>	<b>5.27</b>	<b>48.2</b>	<b>6.00</b>

( $\epsilon_r$  = relative permittivity,  $\sigma$  = conductivity and  $\rho = 1000 \text{ kg/m}^3$ )

### 5.3. Tissue Calibration Result

The dielectric parameters of the liquids were verified prior to the SAR evaluation using SATIMO Dielectric Probe Kit and R&S Network Analyzer ZVL6.

Tissue Stimulant Measurement for 2450MHz					
Head	Fr. (MHz)	Dielectric Parameters ( $\pm 5\%$ )		Tissue Temp [ $^{\circ}$ C]	Test time
		$\epsilon_r$	$\delta$ [s/m]		
			39.2(37.24-41.16)	1.80(1.71-1.89)	
	2437	39.22	1.72	21.8	Sep. 29,2022
	2450	38.62	1.75		

Tissue Stimulant Measurement for 5200MHz					
Head	Fr. (MHz)	Dielectric Parameters ( $\pm 5\%$ )		Tissue Temp [ $^{\circ}$ C]	Test time
		$\epsilon_r$	$\delta$ [s/m]		
			36(34.2-37.8)	4.66(4.43-4.89)	
	5200	36.28	4.52	21.2	Sep. 20,2022

Tissue Stimulant Measurement for 5300MHz					
Head	Fr. (MHz)	Dielectric Parameters ( $\pm 5\%$ )		Tissue Temp [ $^{\circ}$ C]	Test time
		$\epsilon_r$	$\delta$ [s/m]		
			35.9(34.105-37.695)	4.76(4.522-4.998)	
	5300	36.52	4.89	21.2	Sep. 24,2022

Tissue Stimulant Measurement for 5600MHz					
Head	Fr. (MHz)	Dielectric Parameters ( $\pm 5\%$ )		Tissue Temp [ $^{\circ}$ C]	Test time
		$\epsilon_r$	$\delta$ [s/m]		
			35.5(33.725-37.275)	5.07(4.8165-5.3235)	
	5600	36.61	5.16	21.4	Sep. 25,2022

Any report having not been signed by authorized approver, or having been altered without authorization, or having not been stamped by the "Dedicated Testing/Inspection Stamp" is deemed to be invalid. Copying or excerpting portion of, or altering the content of the report is not permitted without the written authorization of AGC. The test results presented in the report apply only to the tested sample. Any objections to report issued by AGC should be submitted to AGC within 15days after the issuance of the test report. Further enquiry of validity or verification of the test report should be addressed to AGC by agc01@agccert.com.

Tissue Stimulant Measurement for 5800MHz					
Head	Fr. (MHz)	Dielectric Parameters ( $\pm 5\%$ )		Tissue Temp [ $^{\circ}\text{C}$ ]	Test time
		$\epsilon_r$ 35.3(33.535-37.065)	$\delta$ [s/m] 5.27(5.0065-5.5335)		
	5785	36.34	5.27	21.6	Sep. 22,2022
5800	35.62	5.32			

Any report having not been signed by authorized approver, or having been altered without authorization, or having not been stamped by the "Dedicated Testing/Inspection Stamp" is deemed to be invalid. Copying or excerpting portion of, or altering the content of the report is not permitted without the written authorization of AGC. The test results presented in the report apply only to the tested sample. Any objections to report issued by AGC should be submitted to AGC within 15days after the issuance of the test report. Further enquiry of validity or verification of the test report should be addressed to AGC by agc01@agccert.com.



## 6. SAR SYSTEM CHECK PROCEDURE

### 6.1. SAR System Check Procedures

SAR system check is required to confirm measurement accuracy, according to the tissue dielectric media, probe calibration points and other system operating parameters required for measuring the SAR of a test device. The system verification must be performed for each frequency band and within the valid range of each probe calibration point required for testing the device. The same SAR probe(s) and tissue-equivalent media combinations used with each specific SAR system for system verification must be used for device testing. When multiple probe calibration points are required to cover substantially large transmission bands, independent system verifications are required for each probe calibration point. A system verification must be performed before each series of SAR measurements using the same probe calibration point and tissue-equivalent medium. Additional system verification should be considered according to the conditions of the tissue-equivalent medium and measured tissue dielectric parameters, typically every three to four days when the liquid parameters are remeasured or sooner when marginal liquid parameters are used at the beginning of a series of measurements.

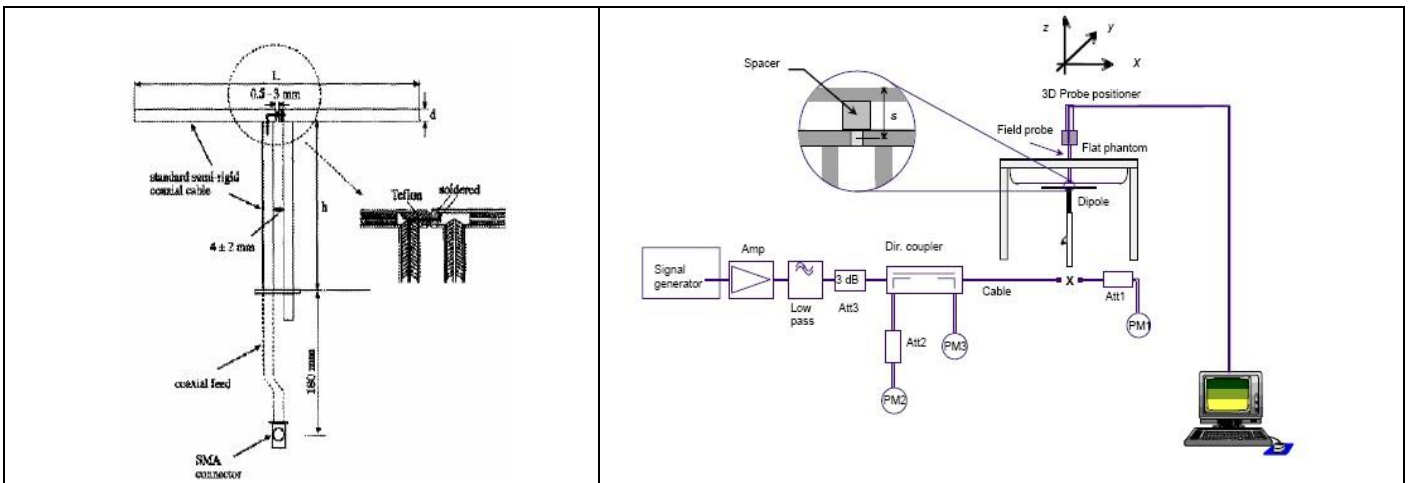

Each SATIMO system is equipped with one or more system check kits. These units, together with the predefined measurement procedures within the SATIMO software, enable the user to conduct the system check and system validation. System kit includes a dipole, and dipole device holder.

The system check verifies that the system operates within its specifications. It's performed daily or before every SAR measurement. The system check uses normal SAR measurement in the flat section of the phantom with a matched dipole at a specified distance. The system check setup is shown as below.

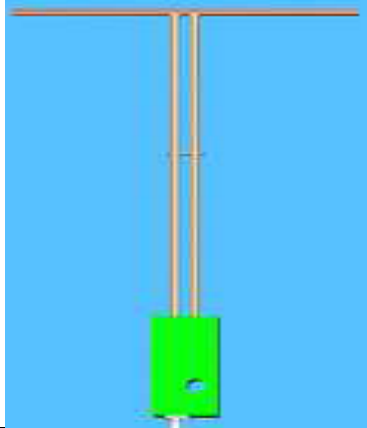

Any report having not been signed by authorized approver, or having been altered without authorization, or having not been stamped by the "Dedicated Testing/Inspection Stamp" is deemed to be invalid. Copying or excerpting portion of, or altering the content of the report is not permitted without the written authorization of AGC. The test results presented in the report apply only to the tested sample. Any objections to report issued by AGC should be submitted to AGC within 15 days after the issuance of the test report. Further enquiry of validity or verification of the test report should be addressed to AGC by [agc01@agccert.com](mailto:agc01@agccert.com).

**6.2. SAR System Check**  
**6.2.1. Dipoles**

	<p>The dipoles are based on the IEEE-1528 standard, and are complied with mechanical and electrical specifications in line with the requirements of IEEE. the table below provides details for the mechanical and electrical Specifications for the dipoles.</p>
	<p>The dipole is based on the IEEE-1528 standard, and is complied with mechanical and electrical specifications in line with the requirements of IEEE. The table below provides details for the mechanical and electrical specifications for the wave guide.</p>

Frequency	L (mm)	h (mm)	d (mm)
2450MHz	51.5	30.4	3.6
5000MHz	20.6	40.3	3.6

Any report having not been signed by authorized approver, or having been altered without authorization, or having not been stamped by the "Dedicated Testing/Inspection Stamp" is deemed to be invalid. Copying or excerpting portion of, or altering the content of the report is not permitted without the written authorization of AGC. The test results presented in the report apply only to the tested sample. Any objections to report issued by AGC should be submitted to AGC within 15days after the issuance of the test report. Further enquiry of validity or verification of the test report should be addressed to AGC by agc01@agccert.com.

### 6.2.2. System Check Result

System Performance Check at 2450MHz & 5200-5800MHz for Head								
Validation Kit: SN 29/15 DIP 2G450-393 & SN 17/22 DIP 5G000-671								
Frequency [MHz]	Target Value(W/kg)		Reference Result ( $\pm 10\%$ )		Normalized to 1W(W/kg)		Tissue Temp. [°C]	Test time
	1g	10g	1g	10g	1g	10g		
2450	54.32	24.25	48.888-59.752	21.825-26.675	49.70	23.50	21.8	Sep. 29,2022
5200	73.43	21.83	66.087-80.773	19.647-24.013	74.40	21.40	21.2	Sep. 20,2022
5200	73.43	21.83	66.087-80.773	19.647-24.013	77.58	22.21	21.2	Sep. 24,2022
5600	78.20	24.12	70.380-86.02	21.708-26.532	82.55	23.48	21.4	Sep. 25,2022
5800	75.69	22.44	68.121-83.259	20.196-24.684	78.29	22.46	21.6	Sep. 22,2022

Note:

(1) We use a CW signal of 18dBm and 10dBm for system check, and then all SAR values are normalized to 1W forward power. The result must be within  $\pm 10\%$  of target value.

## 7. EUT TEST POSITION

This EUT was tested in **Body back, Body front and 4 edges.**

### 7.1. Body Worn Position

- (1) To position the EUT parallel to the phantom surface.
- (2) To adjust the EUT parallel to the flat phantom.
- (3) To adjust the distance between the EUT surface and the flat phantom to **0mm**.

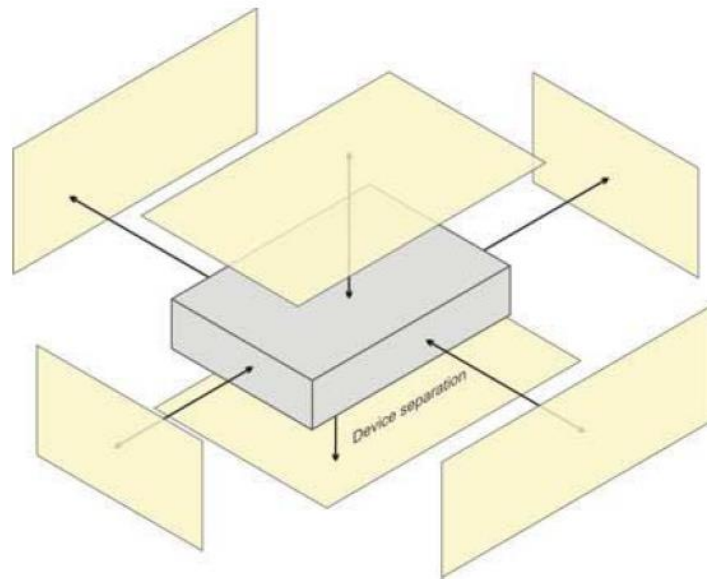

Any report having not been signed by authorized approver, or having been altered without authorization, or having not been stamped by the "Dedicated Testing/Inspection Stamp" is deemed to be invalid. Copying or excerpting portion of, or altering the content of the report is not permitted without the written authorization of AGC. The test results presented in the report apply only to the tested sample. Any objections to report issued by AGC should be submitted to AGC within 15days after the issuance of the test report. Further enquiry of validity or verification of the test report should be addressed to AGC by [agc01@agccert.com](mailto:agc01@agccert.com).

## 8. SAR EXPOSURE LIMITS

### Limits for General Population/Uncontrolled Exposure (W/kg)

Type Exposure	Uncontrolled Environment Limit (W/kg)
Spatial Peak SAR (1 g cube tissue for brain or body)	1.60
Spatial Average SAR (Whole body)	0.08
Spatial Peak SAR (Limbs)	4.0

Any report having not been signed by authorized approver, or having been altered without authorization, or having not been stamped by the "Dedicated Testing/Inspection Stamp" is deemed to be invalid. Copying or excerpting portion of, or altering the content of the report is not permitted without the written authorization of AGC. The test results presented in the report apply only to the tested sample. Any objections to report issued by AGC should be submitted to AGC within 15days after the issuance of the test report. Further enquiry of validity or verification of the test report should be addressed to AGC by [agc01@agccert.com](mailto:agc01@agccert.com).

## 9. TEST FACILITY

<b>Test Site</b>	Attestation of Global Compliance (Shenzhen) Co., Ltd
<b>Location</b>	1-2/F, Building 19, Junfeng Industrial Park, Chongqing Road, Heping Community, Fuhai Street, Bao'an District, Shenzhen, Guangdong, China
<b>Designation Number</b>	CN1259
<b>FCC Test Firm Registration Number</b>	975832
<b>A2LA Cert. No.</b>	5054.02
<b>Description</b>	Attestation of Global Compliance(Shenzhen) Co., Ltd is accredited by A2LA

Any report having not been signed by authorized approver, or having been altered without authorization, or having not been stamped by the "Dedicated Testing/Inspection Stamp" is deemed to be invalid. Copying or excerpting portion of, or altering the content of the report is not permitted without the written authorization of AGC. The test results presented in the report apply only to the tested sample. Any objections to report issued by AGC should be submitted to AGC within 15days after the issuance of the test report. Further enquiry of validity or verification of the test report should be addressed to AGC by [agc01@agccert.com](mailto:agc01@agccert.com).

## 10. TEST EQUIPMENT LIST

Equipment description	Manufacturer/ Model	Identification No.	Software version	Current calibration date	Next calibration date
SAR Probe	MVG	SN 13/22 EPGO368	N/A	Apr. 13,2022	Apr. 12,2023
Phantom	SATIMO	SN_4511_SAM90	N/A	Validated. No cal required.	Validated. No cal required.
Liquid	SATIMO	N/A	N/A	Validated. No cal required.	Validated. No cal required.
Multimeter	Keithley 2000	1350784	N/A	Aug. 06,2022	Aug. 05,2023
SAR Software	SATIMO-OpenSAR	N/A	OpenSAR V4_02_32	N/A	N/A
Dipole	SATIMO SID2450	SN 29/15 DIP 2G450-393	N/A	Apr. 28,2022	Apr. 27,2025
Dipole	SID5000	SN 17/22 DIP 5G000-671	N/A	Apr. 28,2022	Apr. 27, 2025
Signal Generator	Agilent-E4438C	US41461365	V5.03	Aug. 03,2022	Aug. 02,2023
Vector Analyzer	Agilent / E4440A	MY44303916	N/A	Mar. 28,2022	Mar. 27,2023
Network Analyzer	Rhode & Schwarz ZVL6	SN101443	3.2	Oct. 28,2021	Oct. 27,2022
Attenuator	Warison /WATT-6SR1211	S/N:WRJ34AYM2F1	N/A	June 08,2022	June 07,2023
Attenuator	Mini-circuits / VAT-10+	31405	N/A	June 08,2022	June 07,2023
Amplifier	EM30180	SN060552	N/A	June 09,2022	June 08,2023
Directional Couple	Werlatone/ C5571-10	SN99463	N/A	Mar. 10,2022	Mar. 09,2024
Directional Couple	Werlatone/ C6026-10	SN99482	N/A	Mar. 10,2022	Mar. 09,2024
Power Sensor	NRP-Z21	1137.6000.02	N/A	Sep. 06,2022	Sep. 05,2023
Power Sensor	NRP-Z23	100323	N/A	Feb. 16,2022	Feb. 15,2023
Power Viewer	R&S	V2.3.1.0	N/A	N/A	N/A
Calibration standard parts for network sub - port	R&S/ ZV-Z132	N/A	V2.3.1.0	Dec. 07, 2021	Dec. 06, 2022

Note: Per KDB 865664 Dipole SAR Validation, AGC Lab has adopted 3 years calibration intervals. On annual basis, every measurement dipole has been evaluated and is in compliance with the following criteria:

1. There is no physical damage on the dipole;
2. System validation with specific dipole is within 10% of calibrated value;
3. Return-loss is within 20% of calibrated measurement;
4. Impedance is within 5Ω of calibrated measurement.

## 11. MEASUREMENT UNCERTAINTY

SATIMO Uncertainty- SN 13/22 EPGO368									
Measurement uncertainty for DUT averaged over 1 gram / 10 gram.									
Uncertainty Component	Sec.	Tol (+-%)	Prob. Dist.	Div.	Ci (1g)	Ci (10g)	1g Ui (+-%)	10g Ui (+-%)	vi
<b>Measurement System</b>									
Probe calibration	E.2.1	7.000	N	1	1	1	7.000	7.000	∞
Axial Isotropy	E.2.2	0.175	R	$\sqrt{3}$	$\sqrt{0.5}$	$\sqrt{0.5}$	0.071	0.071	∞
Hemispherical Isotropy	E.2.2	0.175	R	$\sqrt{3}$	$\sqrt{0.5}$	$\sqrt{0.5}$	0.071	0.071	∞
Boundary effect	E.2.3	1.000	R	$\sqrt{3}$	1	1	0.577	0.577	∞
Linearity	E.2.4	0.990	R	$\sqrt{3}$	1	1	0.572	0.572	∞
System detection limits	E.2.4	1.000	R	$\sqrt{3}$	1	1	0.577	0.577	∞
Modulation response	E.2.5	3.000	R	$\sqrt{3}$	1	1	1.732	1.732	∞
Readout Electronics	E.2.6	0.021	N	1	1	1	0.021	0.021	∞
Response Time	E.2.7	0.000	R	$\sqrt{3}$	1	1	0.000	0.000	∞
Integration Time	E.2.8	1.400	R	$\sqrt{3}$	1	1	0.808	0.808	∞
RF ambient conditions-Noise	E.6.1	3.000	R	$\sqrt{3}$	1	1	1.732	1.732	∞
RF ambient conditions-reflections	E.6.1	3.000	R	$\sqrt{3}$	1	1	1.732	1.732	∞
Probe positioner mechanical tolerance	E.6.2	1.400	R	$\sqrt{3}$	1	1	0.808	0.808	∞
Probe positioning with respect to phantom shell	E.6.3	1.400	R	$\sqrt{3}$	1	1	0.808	0.808	∞
Extrapolation, interpolation, and integrations algorithms for max. SAR evaluation	E.5	2.300	R	$\sqrt{3}$	1	1	1.328	1.328	∞
<b>Test sample Related</b>									
Test sample positioning	E.4.2	2.6	N	1	1	1	2.600	2.600	∞
Device holder uncertainty	E.4.1	3	N	1	1	1	3.000	3.000	∞
Output power variation—SAR drift measurement	E.2.9	5	R	$\sqrt{3}$	1	1	2.887	2.887	∞
SAR scaling	E.6.5	5	R	$\sqrt{3}$	1	1	2.887	2.887	∞
<b>Phantom and tissue parameters</b>									
Phantom shell uncertainty—shape, thickness, and permittivity	E.3.1	4	R	$\sqrt{3}$	1	1	2.309	2.309	∞
Uncertainty in SAR correction for deviations in permittivity and conductivity	E.3.2	1.9	N	1	1	0.84	1.900	1.596	∞
Liquid conductivity measurement	E.3.3	4	R	$\sqrt{3}$	0.78	0.71	3.120	2.840	∞
Liquid permittivity measurement	E.3.3	5	N	1	0.78	0.71	1.150	1.300	M
Liquid conductivity—temperature uncertainty	E.3.4	2.5	R	$\sqrt{3}$	0.23	0.26	1.126	1.025	∞
Liquid permittivity—temperature uncertainty	E.3.4	2.5	N	1	0.23	0.26	0.332	0.375	M
Combined Standard Uncertainty			RSS				10.529	10.344	
Expanded Uncertainty (95% Confidence interval)			K=2				21.058	20.688	

Any report having not been signed by authorized approver, or having been altered without authorization, or having not been stamped by the "Dedicated Testing/Inspection Stamp" is deemed to be invalid. Copying or excerpting portion of, or altering the content of the report is not permitted without the written authorization of AGC. The test results presented in the report apply only to the tested sample. Any objections to report issued by AGC should be submitted to AGC within 15days after the issuance of the test report. Further enquiry of validity or verification of the test report should be addressed to AGC by agc01@agccert.com.



SATIMO Uncertainty- SN 13/22 EPGO368									
System Validation uncertainty for DUT averaged over 1 gram / 10 gram.									
Uncertainty Component	Sec.	Tol (+-%)	Prob. Dist.	Div.	Ci (1g)	Ci (10g)	1g Ui (+-%)	10g Ui (+-%)	vi
<b>Measurement System</b>									
Probe calibration	E.2.1	7.000	N	1	1	1	7.000	7.000	∞
Axial Isotropy	E.2.2	0.175	R	$\sqrt{3}$	1	1	0.101	0.101	∞
Hemispherical Isotropy	E.2.2	0.175	R	$\sqrt{3}$	0	0	0.000	0.000	∞
Boundary effect	E.2.3	1.000	R	$\sqrt{3}$	1	1	0.577	0.577	∞
Linearity	E.2.4	0.990	R	$\sqrt{3}$	1	1	0.572	0.572	∞
System detection limits	E.2.4	1.0	R	$\sqrt{3}$	1	1	0.58	0.58	∞
Modulation response	E.2.5	3.0	R	$\sqrt{3}$	0	0	0.00	0.00	∞
Readout Electronics	E.2.6	0.021	N	1	1	1	0.021	0.021	∞
Response Time	E.2.7	0.0	R	$\sqrt{3}$	0	0	0.00	0.00	∞
Integration Time	E.2.8	1.4	R	$\sqrt{3}$	0	0	0.00	0.00	∞
RF ambient conditions-Noise	E.6.1	3.0	R	$\sqrt{3}$	1	1	1.73	1.73	∞
RF ambient conditions-reflections	E.6.1	3.0	R	$\sqrt{3}$	1	1	1.73	1.73	∞
Probe positioner mechanical tolerance	E.6.2	1.4	R	$\sqrt{3}$	1	1	0.81	0.81	∞
Probe positioning with respect to phantom shell	E.6.3	1.4	R	$\sqrt{3}$	1	1	0.81	0.81	∞
Extrapolation, interpolation, and integrations algorithms for max. SAR evaluation	E.5	2.3	R	$\sqrt{3}$	1	1	1.33	1.33	∞
<b>System validation source</b>									
Deviation of experimental dipole from numerical dipole	E.6.4	5.0	N	1	1	1	5.00	5.00	∞
Input power and SAR drift measurement	8,6.6.4	5.0	R	$\sqrt{3}$	1	1	2.89	2.89	∞
Dipole axis to liquid distance	8,E.6.6	2.0	R	$\sqrt{3}$	1	1	1.15	1.15	∞
<b>Phantom and set-up</b>									
Phantom shell uncertainty—shape, thickness, and permittivity	E.3.1	4.0	R	$\sqrt{3}$	1	1	2.31	2.31	∞
Uncertainty in SAR correction for deviations in permittivity and conductivity	E.3.2	1.9	N	1	1	0.84	1.90	1.60	∞
Liquid conductivity (temperature uncertainty)	E.3.3	2.5	R	$\sqrt{3}$	0.78	0.71	1.13	1.02	∞
Liquid conductivity (measured)	E.3.3	4	N	1	0.78	0.71	3.12	2.84	M
Liquid permittivity (temperature uncertainty)	E.3.4	2.5	R	$\sqrt{3}$	0.23	0.26	0.33	0.38	∞
Liquid permittivity (measured)	E.3.4	5	N	1	0.23	0.26	1.15	1.30	M
Combined Standard Uncertainty			RSS				10.462	10.276	
Expanded Uncertainty (95% Confidence interval)			K=2				20.924	20.551	

Any report having not been signed by authorized approver, or having been altered without authorization, or having not been stamped by the “Dedicated Testing/Inspection Stamp” is deemed to be invalid. Copying or excerpting portion of, or altering the content of the report is not permitted without the written authorization of AGC. The test results presented in the report apply only to the tested sample. Any objections to report issued by AGC should be submitted to AGC within 15days after the issuance of the test report. Further enquiry of validity or verification of the test report should be addressed to AGC by agc01@agccert.com.

SATIMO Uncertainty- SN 13/22 EPGO368									
System Check uncertainty for DUT averaged over 1 gram / 10 gram.									
Uncertainty Component	Sec.	Tol (+-%)	Prob. Dist.	Div.	Ci (1g)	Ci (10g)	1g Ui (+-%)	10g Ui (+-%)	vi
<b>Measurement System</b>									
Probe calibration drift	E.2.1.3	0.500	N	1	1	1	0.50	0.50	∞
Axial Isotropy	E.2.2	0.175	R	$\sqrt{3}$	0	0	0.00	0.00	∞
Hemispherical Isotropy	E.2.2	0.175	R	$\sqrt{3}$	0	0	0.00	0.00	∞
Boundary effect	E.2.3	1.000	R	$\sqrt{3}$	0	0	0.00	0.00	∞
Linearity	E.2.4	0.990	R	$\sqrt{3}$	0	0	0.00	0.00	∞
System detection limits	E.2.4	1.0	R	$\sqrt{3}$	0	0	0.00	0.00	∞
Modulation response	E.2.5	3.0	R	$\sqrt{3}$	0	0	0.00	0.00	∞
Readout Electronics	E.2.6	0.021	N	1	0	0	0.00	0.00	∞
Response Time	E.2.7	0	R	$\sqrt{3}$	0	0	0.00	0.00	∞
Integration Time	E.2.8	1.4	R	$\sqrt{3}$	0	0	0.00	0.00	∞
RF ambient conditions-Noise	E.6.1	3.0	R	$\sqrt{3}$	0	0	0.00	0.00	∞
RF ambient conditions-reflections	E.6.1	3.0	R	$\sqrt{3}$	0	0	0.00	0.00	∞
Probe positioner mechanical tolerance	E.6.2	1.4	R	$\sqrt{3}$	1	1	0.81	0.81	∞
Probe positioning with respect to phantom shell	E.6.3	1.4	R	$\sqrt{3}$	1	1	0.81	0.81	∞
Extrapolation, interpolation, and integrations algorithms for max. SAR evaluation	E.5	2.3	R	$\sqrt{3}$	0	0	0.00	0.00	∞
<b>System check source (dipole)</b>									
Deviation of experimental dipoles	E.6.4	2.0	N	1	1	1	2.00	2.00	∞
Input power and SAR drift measurement	8,6.6.4	5.0	R	$\sqrt{3}$	1	1	2.89	2.89	∞
Dipole axis to liquid distance	8,E.6.6	2.0	R	$\sqrt{3}$	1	1	1.15	1.15	∞
<b>Phantom and tissue parameters</b>									
Phantom shell uncertainty—shape, thickness, and permittivity	E.3.1	4	R	$\sqrt{3}$	1	1	2.31	2.31	∞
Uncertainty in SAR correction for deviations in permittivity and conductivity	E.3.2	1.9	N	1	1	0.84	1.90	1.60	∞
Liquid conductivity measurement	E.3.3	4	R	$\sqrt{3}$	0.78	0.71	3.12	2.84	∞
Liquid permittivity measurement	E.3.3	5	N	1	0.78	0.71	1.15	1.30	M
Liquid conductivity—temperature uncertainty	E.3.4	2.5	R	$\sqrt{3}$	0.23	0.26	1.13	1.02	∞
Liquid permittivity—temperature uncertainty	E.3.4	2.5	N	1	0.23	0.26	0.33	0.38	M
Combined Standard Uncertainty			RSS				5.562	5.203	
Expanded Uncertainty (95% Confidence interval)			K=2				11.124	10.406	

Any report having not been signed by authorized approver, or having been altered without authorization, or having not been stamped by the “Dedicated Testing/Inspection Stamp” is deemed to be invalid. Copying or excerpting portion of, or altering the content of the report is not permitted without the written authorization of AGC. The test results presented in the report apply only to the tested sample. Any objections to report issued by AGC should be submitted to AGC within 15days after the issuance of the test report. Further enquiry of validity or verification of the test report should be addressed to AGC by agc01@agccert.com.

## 12. CONDUCTED POWER MEASUREMENT

### 2.4GHz WIFI

Mode	Data Rate (Mbps)	Channel	Frequency(MHz)	EIRP (dBm)
802.11b	1	1	2412	<b>14.80</b>
		6	2437	14.42
		11	2462	14.13
802.11g	6	1	2412	14.03
		6	2437	13.53
		11	2462	13.20
802.11n HT20	6.5	1	2412	13.80
		6	2437	13.38
		11	2462	12.94
802.11n HT40	13.5	1	2412	13.68
		6	2437	13.07
		11	2462	12.89

### Bluetooth\_BLE

Modulation	Channel	Frequency(MHz)	Peak Power (dBm)
GFSK	0	2402	<b>3.980</b>
	19	2440	3.613
	39	2480	3.631

Any report having not been signed by authorized approver, or having been altered without authorization, or having not been stamped by the "Dedicated Testing/Inspection Stamp" is deemed to be invalid. Copying or excerpting portion of, or altering the content of the report is not permitted without the written authorization of AGC. The test results presented in the report apply only to the tested sample. Any objections to report issued by AGC should be submitted to AGC within 15days after the issuance of the test report. Further enquiry of validity or verification of the test report should be addressed to AGC by agc01@agccert.com.

5GHz WIFI

Mode	channel	Frequency	Power(dBm)							
			Data Rate(bps)							
			6M	9M	12M	18M	24M	36M	48M	54M
802.11a	36	5180	<b>12.81</b>	12.77	12.64	12.58	12.56	12.55	12.39	12.32
	40	5200	12.32	12.21	12.18	12.03	11.84	11.82	11.65	11.61
	44	5220	12.06	11.87	11.87	11.87	11.70	11.65	11.57	11.42
	48	5240	12.09	12.03	11.88	11.78	11.67	11.47	11.34	11.31
	52	5260	<b>11.95</b>	11.92	11.77	11.58	11.47	11.42	11.34	11.27
	56	5280	11.32	11.14	11.10	10.95	10.78	10.67	10.56	10.54
	60	5300	11.55	11.50	11.47	11.34	11.30	11.20	11.06	10.87
	64	5320	11.51	11.40	11.32	11.31	11.15	11.13	11.01	10.97
	100	5500	<b>11.98</b>	11.91	11.82	11.75	11.56	11.55	11.45	11.38
	104	5520	11.78	11.64	11.59	11.53	11.38	11.27	11.20	11.11
	108	5540	11.67	11.59	11.39	11.26	11.11	11.03	10.96	10.94
	112	5560	11.50	11.33	11.13	11.09	10.92	10.91	10.73	10.66
	116	5580	11.46	11.38	11.21	11.08	10.89	10.76	10.72	10.71
	120	5600	11.52	11.38	11.21	11.09	11.07	10.93	10.84	10.64
	124	5620	11.42	11.36	11.31	11.17	11.15	10.96	10.88	10.70
	128	5640	11.36	11.22	11.22	11.13	11.12	11.08	11.00	10.81
	132	5660	11.40	11.30	11.24	11.14	11.09	10.96	10.87	10.86
	136	5680	11.36	11.17	10.98	10.81	10.69	10.53	10.38	10.24
	140	5700	11.39	11.34	11.20	11.10	10.91	10.72	10.62	10.52
149	5745	<b>11.21</b>	11.13	11.09	10.94	10.92	10.86	10.82	10.72	
157	5785	11.08	11.02	10.82	10.74	10.73	10.60	10.52	10.37	
165	5825	10.95	10.83	10.69	10.57	10.45	10.38	10.19	10.14	

Any report having not been signed by authorized approver, or having been altered without authorization, or having not been stamped by the "Dedicated Testing/Inspection Stamp" is deemed to be invalid. Copying or excerpting portion of, or altering the content of the report is not permitted without the written authorization of AGC. The test results presented in the report apply only to the tested sample. Any objections to report issued by AGC should be submitted to AGC within 15days after the issuance of the test report. Further enquiry of validity or verification of the test report should be addressed to AGC by agc01@agccert.com.

Mode	channel	Frequency	Power(dBm)							
			Data Rate(bps)							
			MCS0	MCS1	MCS2	MCS3	MCS4	MCS5	MCS6	MCS7
802.11n (20)	36	5180	12.54	12.41	12.39	12.29	12.24	12.18	12.00	11.94
	40	5200	12.16	12.12	12.00	11.84	11.65	11.59	11.51	11.44
	44	5220	12.10	12.02	12.01	11.84	11.76	11.57	11.51	11.35
	48	5240	11.87	11.75	11.60	11.42	11.22	11.09	10.94	10.84
	52	5260	11.58	11.49	11.38	11.26	11.10	11.06	11.03	11.02
	56	5280	11.43	11.29	11.24	11.17	11.15	10.96	10.93	10.75
	60	5300	11.22	11.03	10.89	10.79	10.70	10.64	10.47	10.42
	64	5320	11.17	11.04	10.93	10.83	10.65	10.59	10.53	10.51
	100	5500	11.75	11.69	11.59	11.49	11.40	11.39	11.30	11.24
	104	5520	11.61	11.47	11.43	11.35	11.23	11.22	11.13	11.00
	108	5540	11.35	11.28	11.19	10.99	10.98	10.94	10.77	10.72
	112	5560	11.46	11.40	11.31	11.26	11.10	10.90	10.87	10.69
	116	5580	11.30	11.24	11.05	10.87	10.82	10.66	10.53	10.37
	120	5600	11.27	11.11	10.95	10.81	10.70	10.52	10.35	10.33
	124	5620	11.20	11.19	11.16	11.09	10.97	10.89	10.83	10.74
	128	5640	11.13	10.95	10.92	10.79	10.60	10.52	10.32	10.19
	132	5660	10.92	10.86	10.71	10.68	10.62	10.44	10.33	10.18
136	5680	10.86	10.82	10.65	10.61	10.44	10.32	10.16	10.01	
140	5700	10.90	10.73	10.66	10.55	10.42	10.35	10.24	10.20	
149	5745	10.97	10.96	10.88	10.71	10.65	10.46	10.32	10.20	
157	5785	10.66	10.48	10.45	10.30	10.14	9.96	9.91	9.77	
165	5825	10.59	10.46	10.27	10.08	10.06	9.98	9.97	9.79	
			MCS0	MCS1	MCS2	MCS3	MCS4	MCS5	MCS6	MCS7
802.11n (40)	38	5190	12.48	12.41	12.31	12.28	12.09	12.00	11.93	11.88
	46	5230	11.44	11.36	11.25	11.05	10.87	10.85	10.68	10.60
	54	5270	11.46	11.40	11.26	11.09	10.94	10.79	10.78	10.66
	62	5310	11.54	11.38	11.35	11.25	11.08	10.95	10.93	10.91
	102	5510	11.53	11.38	11.28	11.27	11.25	11.07	10.98	10.84
	110	5550	11.42	11.34	11.30	11.11	10.94	10.88	10.78	10.65
	118	5590	11.17	11.11	10.92	10.73	10.67	10.65	10.62	10.61
	126	5630	11.06	11.06	11.01	10.95	10.80	10.67	10.51	10.45
	134	5670	11.02	10.86	10.72	10.57	10.41	10.22	10.12	10.06
	151	5755	10.43	10.25	10.12	9.99	9.97	9.84	9.73	9.68
159	5795	10.14	10.10	9.95	9.94	9.78	9.71	9.69	9.57	

Any report having not been signed by authorized approver, or having been altered without authorization, or having not been stamped by the "Dedicated Testing/Inspection Stamp" is deemed to be invalid. Copying or excerpting portion of, or altering the content of the report is not permitted without the written authorization of AGC. The test results presented in the report apply only to the tested sample. Any objections to report issued by AGC should be submitted to AGC within 15days after the issuance of the test report. Further enquiry of validity or verification of the test report should be addressed to AGC by agc01@agccert.com.

Mode	channel	Frequency	Power(dBm)							
			Data Rate(bps)							
			MCS0	MCS1	MCS2	MCS3	MCS4	MCS5	MCS6	MCS7
802.11ac (20)	36	5180	11.80	11.63	11.58	11.53	11.34	11.19	11.14	11.03
	40	5200	11.50	11.34	11.31	11.27	11.23	11.19	11.19	11.09
	44	5220	11.42	11.39	11.21	11.06	10.87	10.81	10.74	10.60
	48	5240	11.12	11.03	10.92	10.84	10.75	10.64	10.54	10.46
	52	5260	11.20	11.15	11.00	10.85	10.82	10.66	10.55	10.47
	56	5280	11.13	10.98	10.91	10.90	10.82	10.78	10.72	10.64
	60	5300	10.98	10.86	10.70	10.52	10.51	10.35	10.35	10.29
	64	5320	10.87	10.79	10.67	10.57	10.43	10.34	10.28	10.24
	100	5500	11.14	11.12	11.11	10.93	10.77	10.64	10.53	10.42
	104	5520	11.08	10.97	10.82	10.73	10.71	10.70	10.67	10.59
	108	5540	10.92	10.85	10.78	10.68	10.62	10.61	10.53	10.52
	112	5560	10.82	10.71	10.63	10.54	10.43	10.34	10.34	10.33
	116	5580	10.79	10.60	10.48	10.31	10.18	9.99	9.79	9.65
	120	5600	10.87	10.81	10.78	10.61	10.55	10.54	10.36	10.31
	124	5620	10.76	10.75	10.73	10.54	10.41	10.21	10.06	9.99
	128	5640	10.67	10.53	10.47	10.43	10.41	10.35	10.33	10.25
	132	5660	10.62	10.53	10.41	10.23	10.12	10.12	10.02	9.97
	136	5680	10.51	10.38	10.33	10.24	10.15	10.14	10.07	9.98
140	5700	10.49	10.36	10.27	10.17	10.02	9.88	9.68	9.67	
149	5745	10.15	9.96	9.76	9.73	9.57	9.45	9.39	9.27	
157	5785	10.11	10.07	10.04	9.85	9.84	9.78	9.59	9.54	
165	5825	9.97	9.79	9.69	9.57	9.51	9.40	9.23	9.10	
			MCS0	MCS1	MCS2	MCS3	MCS4	MCS5	MCS6	MCS7
802.11ac (40)	38	5190	11.41	11.40	11.36	11.34	11.32	11.15	10.96	10.92
	46	5230	10.95	10.87	10.77	10.69	10.59	10.50	10.43	10.37
	54	5270	10.60	10.57	10.48	10.35	10.22	10.13	10.06	9.87
	62	5310	10.70	10.55	10.41	10.41	10.32	10.15	10.09	9.92
	102	5510	10.34	10.26	10.25	10.07	9.95	9.76	9.73	9.68
	110	5550	10.26	10.16	9.97	9.83	9.81	9.68	9.62	9.52
	118	5590	9.94	9.90	9.76	9.57	9.55	9.44	9.37	9.35
	126	5630	9.86	9.77	9.69	9.53	9.36	9.32	9.25	9.09
	134	5670	9.78	9.58	9.48	9.40	9.32	9.27	9.21	9.01
	151	5755	9.88	9.69	9.50	9.37	9.29	9.15	8.95	8.87
159	5795	9.78	9.75	9.67	9.67	9.55	9.54	9.41	9.39	
			MCS0	MCS1	MCS2	MCS3	MCS4	MCS5	MCS6	MCS7
802.11ac (80)	42	5210	10.84	10.67	10.60	10.55	10.47	10.36	10.33	10.22
	58	5290	10.67	10.61	10.43	10.40	10.35	10.15	9.97	9.91
	106	5530	9.76	9.67	9.48	9.44	9.36	9.33	9.24	9.08
	122	5610	9.65	9.54	9.47	9.34	9.25	9.24	9.12	8.98
	138	5690	9.60	9.42	9.29	9.13	8.96	8.86	8.73	8.64
155	5775	9.74	9.56	9.49	9.40	9.29	9.19	9.11	9.00	

Any report having not been signed by authorized approver, or having been altered without authorization, or having not been stamped by the "Dedicated Testing/Inspection Stamp" is deemed to be invalid. Copying or excerpting portion of, or altering the content of the report is not permitted without the written authorization of AGC. The test results presented in the report apply only to the tested sample. Any objections to report issued by AGC should be submitted to AGC within 15days after the issuance of the test report. Further enquiry of validity or verification of the test report should be addressed to AGC by agc01@agccert.com.

## 13. TEST RESULTS

### 13.1. SAR Test Results Summary

#### 13.1.1. Test position and configuration

1. The EUT is a Body Worn Camera.
2. Lab. use the head liquid with a separation of 0mm at flat phantom to test.
3. For SAR testing, the device was controlled by software to test at reference fixed frequency points.

#### 13.1.2. Operation Mode

1. Per KDB 447498 D01 v06 ,for each exposure position, if the highest 1-g SAR is  $\leq 0.8$  W/kg, testing for low and high channel is optional.
2. Per KDB 865664 D01 v01r04,for each frequency band, if the measured SAR is  $\geq 0.8$ W/kg, testing for repeated SAR measurement is required , that the highest measured SAR is only to be tested. When the SAR results are near the limit, the following procedures are required for each device to verify these types of SAR measurement related variation concerns by repeating the highest measured SAR configuration in each frequency band.
  - (1) When the original highest measured SAR is  $\geq 0.8$ W/kg, repeat that measurement once.
  - (2) Perform a second repeated measurement only if the ratio of largest to smallest SAR for the original and first repeated measurements is  $>1.20$  or when the original or repeated measurement is  $\geq 1.45$  W/kg.
  - (3) Perform a third repeated measurement only if the original, first and second repeated measurement is  $\geq 1.5$  W/kg and ratio of largest to smallest SAR for the original, first and second measurement is  $\geq 1.20$ .
3. Per KDB 248227 D01 v02r02 Chapter 5.2.2,when SAR measurement is required for 2.4GHz 802.11g/n OFDM configurations, the measurement and test reducing procedures for OFDM are applied. SAR is not required for the following 2.4 GHz OFDM conditions.
  - (1) When KDB Publication 447498 D01 SAR test exclusion applies to the OFDM configuration.
  - (2) When the highest reported SAR for DSSS is adjusted by the ratio of OFDM to DSSS specified maximum output power and the adjusted SAR is  $\leq 1.2$  W/kg,
4. Per KDB 248227 D01 v02r02 Chapter 5.3.4, SAR measurement requirements for the remaining 802.11 transmission mode configurations that have not been tested in the initial test configuration are determined separately for each standalone and aggregated frequency band, in each exposure condition, according to the maximum output power specified for production units. The initial test position procedure is applied to next to the ear, UMPC mini-tablet and hotspot mode configurations. When the same maximum output power is specified for multiple transmission modes, the procedures in 5.3.2 are applied to determine the test configuration. Additional power measurements may be required to determine if SAR measurements are required for subsequent highest output power channels in a subsequent test configuration. The subsequent test configuration and SAR measurement procedures are described in the following.
  - (1) When SAR test exclusion provisions of KDB Publication 447498 D01 are applicable and SAR measurement is not required for the initial test configuration, SAR is also not required for the next highest maximum output power transmission mode subsequent test configuration(s) in that frequency band or aggregated band and exposure configuration.
  - (2) When the highest reported SAR for the initial test configuration (when applicable, include subsequent highest output channels), according to the initial test position or fixed exposure position requirements, is adjusted by the ratio of the subsequent test configuration to initial test configuration specified

Any report having not been signed by authorized approver, or having been altered without authorization, or having not been stamped by the "Dedicated Testing/Inspection Stamp" is deemed to be invalid. Copying or excerpting portion of, or altering the content of the report is not permitted without the written authorization of AGC. The test results presented in the report apply only to the tested sample. Any objections to report issued by AGC should be submitted to AGC within 15days after the issuance of the test report. Further enquiry of validity or verification of the test report should be addressed to AGC by [agc01@agccert.com](mailto:agc01@agccert.com).

maximum output power and the adjusted SAR is  $\leq 1.2$  W/kg, SAR is not required for that subsequent test configuration.

- (3) When the specified maximum output power is same for both UNII 1 and UNII 2A, begin SAR measurements in UNII 2A with the channel with the highest measured output power. If the report SAR for UNII 2A is  $< 1.2$  W/kg, SAR is not required for UNII 1; otherwise treat the remaining bands separately and test them independently for SAR.
- (4) When the specified maximum output power different between UNII 1 and UNII 2A, begin SAR with the band that has the higher specified maximum output. If the highest reported SAR for the band with the highest specified power is  $\leq 1.2$  W/kg, testing for the band with the lower specified output power is not required; otherwise test is remaining separately for SAR;
5. Maximum Scaling SAR in order to calculate the Maximum SAR values to test under the standard Peak Power, Calculation method is as follows:  
Maximum Scaling SAR = tested SAR (Max.)  $\times$  [maximum turn-up power (mw)/ maximum measurement output power(mw) ]



### 13.1.3. SAR Test Results Summary

SAR MEASUREMENT									
Depth of Liquid (cm):>15					Relative Humidity (%): 57.1				
Product: Body Worn Camera									
Test Mode: 2.4GHz 802.11b									
Position	Mode	Ch.	Fr. (MHz)	Power Drift (<math>\pm 5\%</math>)	SAR (1g) (W/kg)	Max. Tune-up Power (dBm)	Meas. output Power (dBm)	Scaled SAR (W/kg)	Limit W/kg
Body back	DTS	6	2437	-0.18	0.251	15.00	14.42	0.287	1.6
Body front	DTS	6	2437	-0.47	0.222	15.00	14.42	0.254	1.6
Edge 1 (Top)	DTS	6	2437	0.61	0.080	15.00	14.42	0.091	1.6
Edge 2 (Right)	DTS	6	2437	-0.97	<b>0.280</b>	15.00	14.42	<b>0.320</b>	1.6
Edge 3 (Bottom)	DTS	6	2437	-0.94	0.021	15.00	14.42	0.024	1.6
Edge 4 (Left)	DTS	6	2437	0.82	0.186	15.00	14.42	0.213	1.6

Note:

- When the 1-g SAR is  $\leq 0.8$ W/kg, testing for low and high channel is optional.
- The test separation of all above table(body part) is 0mm.
- Plots are only shown for the bold marked worst case SAR results.

Any report having not been signed by authorized approver, or having been altered without authorization, or having not been stamped by the "Dedicated Testing/Inspection Stamp" is deemed to be invalid. Copying or excerpting portion of, or altering the content of the report is not permitted without the written authorization of AGC. The test results presented in the report apply only to the tested sample. Any objections to report issued by AGC should be submitted to AGC within 15days after the issuance of the test report. Further enquiry of validity or verification of the test report should be addressed to AGC by agc01@agccert.com.

SAR MEASUREMENT								
Depth of Liquid (cm):>15				Relative Humidity (%): 48.6				
Product: Body Worn Camera								
Test Mode: 5.2GHz 802.11a								
Position	Ch.	Fr. (MHz)	Power Drift (<±5%)	SAR (1g) (W/kg)	Max. Tune-up Power (dBm)	Meas. output Power (dBm)	Scaled SAR (W/kg)	Limit (W/kg)
Body back	40	5200	-0.28	0.550	13.00	12.32	0.643	1.6
Body front	40	5200	-0.70	0.426	13.00	12.32	0.498	1.6
Edge 1 (Top)	40	5200	0.18	0.183	13.00	12.32	0.214	1.6
Edge 2 (Right)	40	5200	-0.64	<b>0.570</b>	13.00	12.32	<b>0.667</b>	1.6
Edge 3 (Bottom)	40	5200	0.60	0.028	13.00	12.32	0.033	1.6
Edge 4 (Left)	40	5200	0.59	0.027	13.00	12.32	0.032	1.6

Note:

- When the 1-g SAR is ≤ 0.8W/kg, testing for low and high channel is optional.
- The test separation of all above table(body part) is 0mm.
- Plots are only shown for the bold marked worst case SAR results

Any report having not been signed by authorized approver, or having been altered without authorization, or having not been stamped by the “Dedicated Testing/Inspection Stamp” is deemed to be invalid. Copying or excerpting portion of, or altering the content of the report is not permitted without the written authorization of AGC. The test results presented in the report apply only to the tested sample. Any objections to report issued by AGC should be submitted to AGC within 15days after the issuance of the test report. Further enquiry of validity or verification of the test report should be addressed to AGC by agc01@agccert.com.

SAR MEASUREMENT								
Depth of Liquid (cm):>15					Relative Humidity (%): 56.3			
Product: Body Worn Camera								
Test Mode: 5.3GHz 802.11a								
Position	Ch.	Fr. (MHz)	Power Drift (<math>\pm 5\%</math>)	SAR (1g) (W/kg)	Max. Tune-up Power (dBm)	Meas. output Power (dBm)	Scaled SAR (W/kg)	Limit (W/kg)
Body back	60	5300	0.73	0.354	12.00	11.55	0.393	1.6
Body front	60	5300	0.32	0.366	12.00	11.55	0.406	1.6
Edge 1 (Top)	60	5300	-0.01	0.199	12.00	11.55	0.221	1.6
Edge 2 (Right)	60	5300	-0.82	<b>0.573</b>	12.00	11.55	<b>0.636</b>	1.6
Edge 3 (Bottom)	60	5300	-0.43	0.037	12.00	11.55	0.041	1.6
Edge 4 (Left)	60	5300	0.38	0.034	12.00	11.55	0.038	1.6

Note:

- When the 1-g SAR is  $\leq 0.8$ W/kg, testing for low and high channel is optional.
- The test separation of all above table(body part) is 0mm.
- Plots are only shown for the bold marked worst case SAR results

Any report having not been signed by authorized approver, or having been altered without authorization, or having not been stamped by the "Dedicated Testing/Inspection Stamp" is deemed to be invalid. Copying or excerpting portion of, or altering the content of the report is not permitted without the written authorization of AGC. The test results presented in the report apply only to the tested sample. Any objections to report issued by AGC should be submitted to AGC within 15days after the issuance of the test report. Further enquiry of validity or verification of the test report should be addressed to AGC by agc01@agccert.com.

SAR MEASUREMENT								
Depth of Liquid (cm):>15					Relative Humidity (%): 53.9			
Product: Body Worn Camera								
Test Mode: 5.6GHz 802.11a								
Position	Ch.	Fr. (MHz)	Power Drift (<±5%)	SAR (1g) (W/kg)	Max. Tune-up Power (dBm)	Meas. output Power (dBm)	Scaled SAR (W/kg)	Limit (W/kg)
Body back	120	5600	-0.53	0.343	12.00	11.52	0.383	1.6
Body front	120	5600	0.99	0.300	12.00	11.52	0.335	1.6
Edge 1 (Top)	120	5600	-0.12	0.180	12.00	11.52	0.201	1.6
Edge 2 (Right)	120	5600	-0.24	<b>0.571</b>	12.00	11.52	<b>0.638</b>	1.6
Edge 3 (Bottom)	120	5600	-0.31	0.039	12.00	11.52	0.044	1.6
Edge 4 (Left)	120	5600	0.02	0.038	12.00	11.52	0.042	1.6

Note:

- When the 1-g SAR is  $\leq 0.8W/kg$ , testing for low and high channel is optional.
- The test separation of all above table(body part) is 0mm.
- Plots are only shown for the bold marked worst case SAR results

Any report having not been signed by authorized approver, or having been altered without authorization, or having not been stamped by the "Dedicated Testing/Inspection Stamp" is deemed to be invalid. Copying or excerpting portion of, or altering the content of the report is not permitted without the written authorization of AGC. The test results presented in the report apply only to the tested sample. Any objections to report issued by AGC should be submitted to AGC within 15days after the issuance of the test report. Further enquiry of validity or verification of the test report should be addressed to AGC by agc01@agccert.com.

SAR MEASUREMENT								
Depth of Liquid (cm):>15					Relative Humidity (%): 56.4			
Product: Body Worn Camera								
Test Mode: 5.8GHz 802.11a								
Position	Ch.	Fr. (MHz)	Power Drift (<±5%)	SAR (1g) (W/kg)	Max. Tune-up Power (dBm)	Meas. output Power (dBm)	Scaled SAR (W/kg)	Limit (W/kg)
Body Back	157	5785	-0.78	0.379	11.50	11.08	0.417	1.6
Body Front	157	5785	0.82	0.372	11.50	11.08	0.410	1.6
Edge 1 (Top)	157	5785	-0.32	0.188	11.50	11.08	0.207	1.6
Edge 2 (Right)	157	5785	0.40	<b>0.492</b>	11.50	11.08	<b>0.542</b>	1.6
Edge 3 (Bottom)	157	5785	-0.70	0.047	11.50	11.08	0.052	1.6
Edge 4 (Left)	157	5785	0.80	0.029	11.50	11.08	0.032	1.6

Note:

- When the 1-g SAR is  $\leq 0.8W/kg$ , testing for low and high channel is optional.
- The test separation of all above table(body part) is 0mm.
- Plots are only shown for the bold marked worst case SAR results

Any report having not been signed by authorized approver, or having been altered without authorization, or having not been stamped by the "Dedicated Testing/Inspection Stamp" is deemed to be invalid. Copying or excerpting portion of, or altering the content of the report is not permitted without the written authorization of AGC. The test results presented in the report apply only to the tested sample. Any objections to report issued by AGC should be submitted to AGC within 15days after the issuance of the test report. Further enquiry of validity or verification of the test report should be addressed to AGC by agc01@agccert.com.

Attestation of Global Compliance(Shenzhen)Co., Ltd

Attestation of Global Compliance(Shenzhen)Std & Tech Co., Ltd

Tel: +86-755 2523 4088 E-mail: agc@agccert.com Web: http://www.agccert.com/

## APPENDIX A. SAR SYSTEM CHECK DATA

Test Laboratory: AGC Lab

Date: Sep. 29,2022

System Check Head 2450 MHz

DUT: Dipole 2450 MHz Type: SID 2450

Communication System: CW; Communication System Band: D2450 (2450.0 MHz); Duty Cycle: 1:1; Conv.F=1.99

Frequency: 2450 MHz; Medium parameters used:  $f = 2450$  MHz;  $\sigma = 1.75$  mho/m;  $\epsilon_r = 38.62$ ;  $\rho = 1000$  kg/m<sup>3</sup> ;

Phantom section: Flat Section; Input Power=18dBm

Ambient temperature (°C): 22.1, Liquid temperature (°C): 21.8

SATIMO Configuration:

- Probe: SSE2; Calibrated: Apr. 13, 2022; Serial No.: SN 13/22 EPGO368
- Sensor-Surface: 4mm (Mechanical Surface Detection)
- Phantom: SAM twin phantom
- Measurement SW: OpenSAR V4\_02\_32

Configuration/System Check 2450 MHz Head/Area Scan: Measurement grid: dx=8mm, dy=8mm

Configuration/System Check 2450 MHz Head/Zoom Scan: Measurement grid: dx=5mm,dy=5mm, dz=5mm

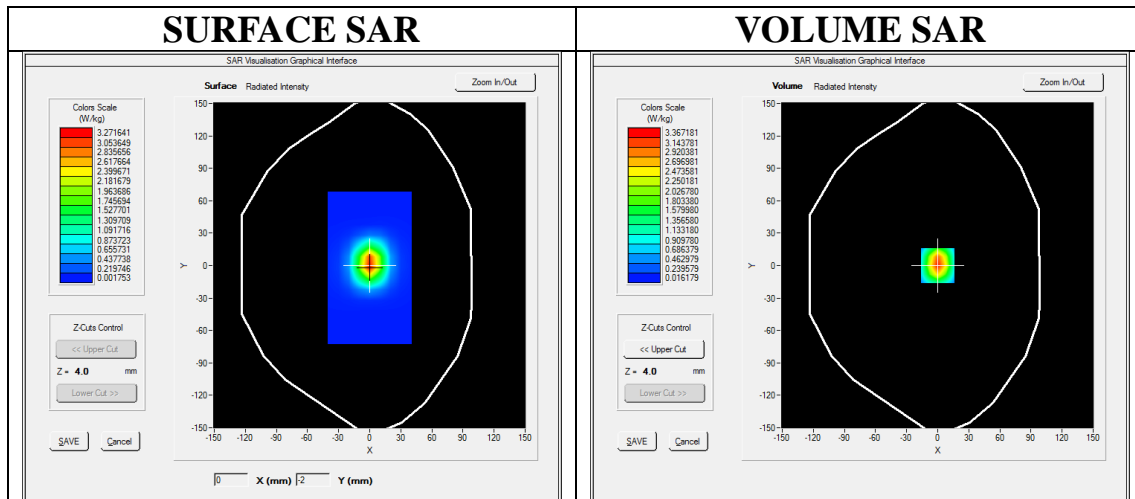

**Maximum location: X=0.00, Y=0.00**

**SAR Peak: 5.96 W/kg**

<b>SAR 10g (W/Kg)</b>	1.482697
<b>SAR 1g (W/Kg)</b>	3.136035

Any report having not been signed by authorized approver, or having been altered without authorization, or having not been stamped by the "Dedicated Testing/Inspection Stamp" is deemed to be invalid. Copying or excerpting portion of, or altering the content of the report is not permitted without the written authorization of AGC. The test results presented in the report apply only to the tested sample. Any objections to report issued by AGC should be submitted to AGC within 15days after the issuance of the test report. Further enquiry of validity or verification of the test report should be addressed to AGC by agc01@agccert.com.

Attestation of Global Compliance(Shenzhen)Co., Ltd

Attestation of Global Compliance(Shenzhen)Std & Tech Co., Ltd

Tel: +86-755 2523 4088 E-mail: agc@agccert.com Web: http://www.agccert.com/

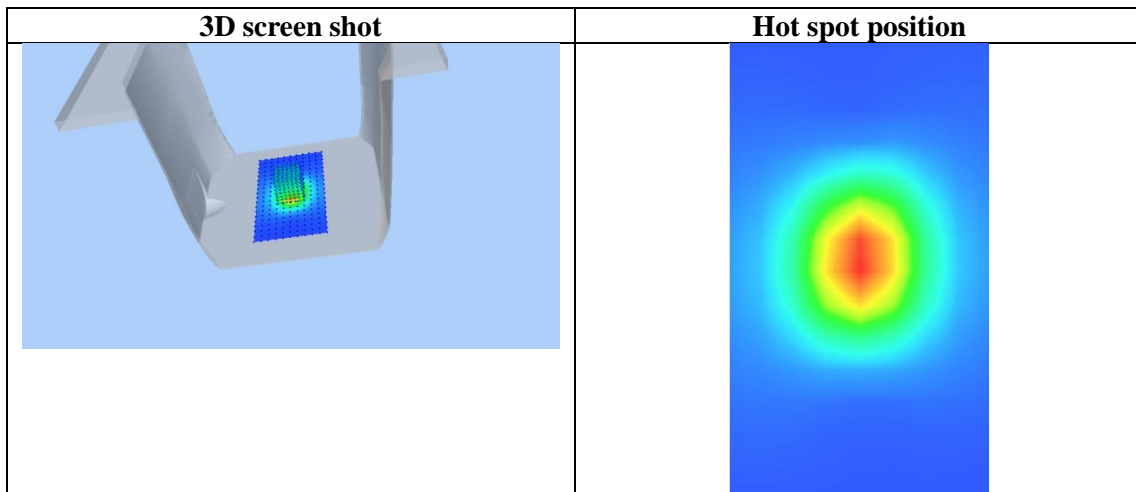
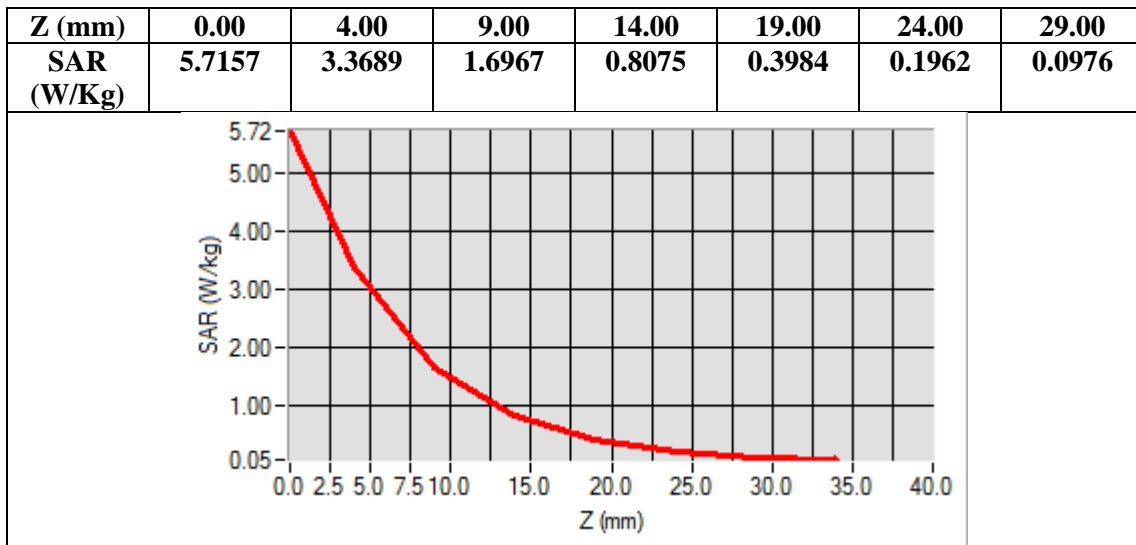

Any report having not been signed by authorized approver, or having been altered without authorization, or having not been stamped by the "Dedicated Testing/Inspection Stamp" is deemed to be invalid. Copying or excerpting portion of, or altering the content of the report is not permitted without the written authorization of AGC. The test results presented in the report apply only to the tested sample. Any objections to report issued by AGC should be submitted to AGC within 15days after the issuance of the test report. Further enquiry of validity or verification of the test report should be addressed to AGC by agc01@agccert.com.

**Test Laboratory: AGC Lab**  
**System Check Head 5200 MHz**  
**DUT: Dipole 5000MHz Type: SID5000**

**Date: Sep. 20,2022**

Communication System: CW; Communication System Band: D5000 (5000.0 MHz); Duty Cycle: 1:1; Conv.F=1.28  
Frequency: 5200 MHz; Medium parameters used:  $f = 5200$  MHz;  $\sigma = 4.52$  mho/m;  $\epsilon_r = 36.28$ ;  $\rho = 1000$  kg/m<sup>3</sup> ;  
Phantom section: Flat Section; Input Power=10dBm  
Ambient temperature (°C): 21.6, Liquid temperature (°C): 21.2

SATIMO Configuration:

- Probe: SSE2; Calibrated: Apr. 13, 2022; Serial No.: SN 13/22 EPGO368
- Sensor-Surface: 4mm (Mechanical Surface Detection)
- Phantom: SAM twin phantom
- Measurement SW: OpenSAR V4\_02\_35

**Configuration/System Check 5200 MHz Head/Area Scan:** Measurement grid: dx=8mm, dy=8mm

**Configuration/System Check 5200 MHz Head/Zoom Scan:** Measurement grid: dx=4mm,dy=4mm, dz=2mm

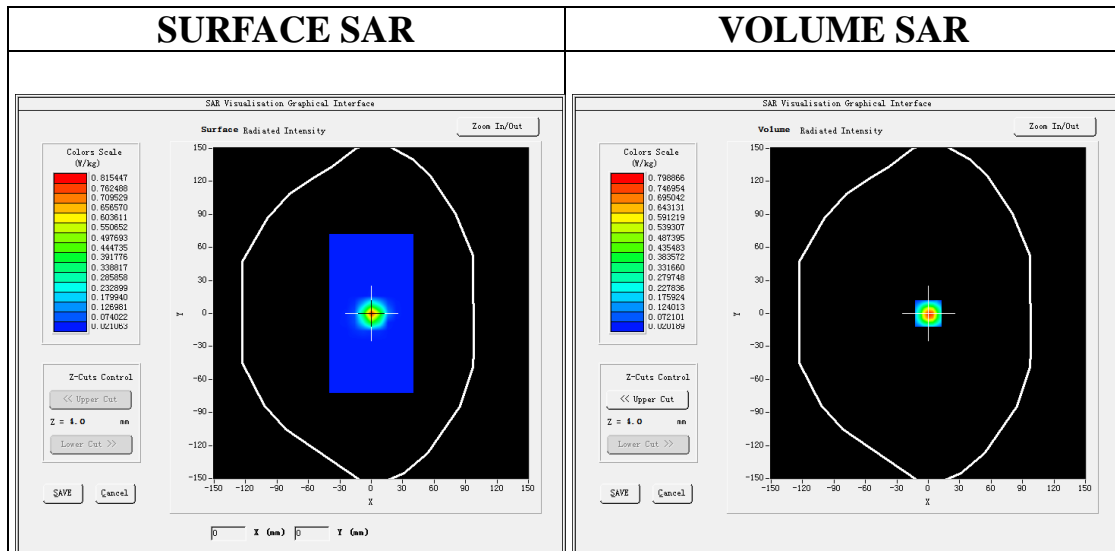

**Maximum location: X=0.00, Y=0.00**

**SAR Peak: 2.25 W/kg**

<b>SAR 10g (W/Kg)</b>	0.214046
<b>SAR 1g (W/Kg)</b>	0.744030

Any report having not been signed by authorized approver, or having been altered without authorization, or having not been stamped by the "Dedicated Testing/Inspection Stamp" is deemed to be invalid. Copying or excerpting portion of, or altering the content of the report is not permitted without the written authorization of AGC. The test results presented in the report apply only to the tested sample. Any objections to report issued by AGC should be submitted to AGC within 15days after the issuance of the test report. Further enquiry of validity or verification of the test report should be addressed to AGC by agc01@agccert.com.



Z (mm)	0.00	4.00	6.00	8.00	10.00	12.00	14.00	16.00	18.00	20.00	22.00	24.00
SAR (W/Kg)	2.2600	0.7989	0.4029	0.1819	0.0841	0.0360	0.0274	0.0212	0.0234	0.0234	0.0234	0.0234

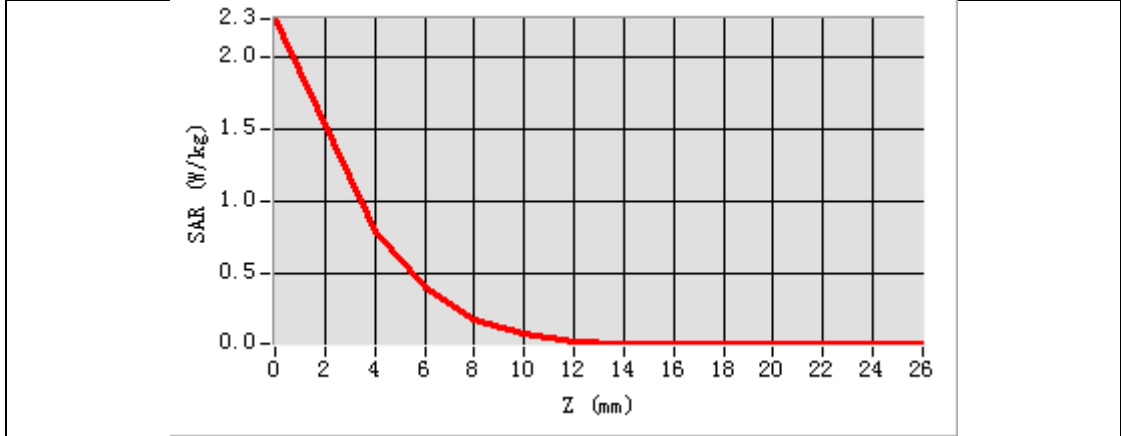

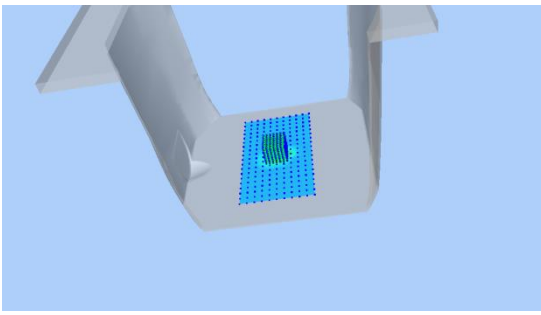
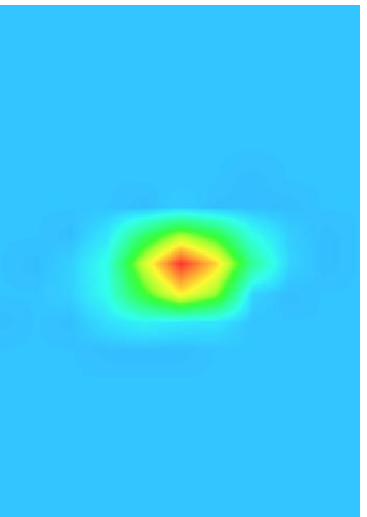
3D screen shot	Hot spot position
	

Any report having not been signed by authorized approver, or having been altered without authorization, or having not been stamped by the "Dedicated Testing/Inspection Stamp" is deemed to be invalid. Copying or excerpting portion of, or altering the content of the report is not permitted without the written authorization of AGC. The test results presented in the report apply only to the tested sample. Any objections to report issued by AGC should be submitted to AGC within 15days after the issuance of the test report. Further enquiry of validity or verification of the test report should be addressed to AGC by agc01@agccert.com.

**Test Laboratory: AGC Lab**  
**System Check Head 5300 MHz**  
**DUT: Dipole 5000MHz Type: SID5000**

**Date: Sep. 24,2022**

Communication System: CW; Communication System Band: D5000 (5000.0 MHz); Duty Cycle: 1:1; Conv.F=1.28  
Frequency: 5300 MHz; Medium parameters used:  $f = 5300$  MHz;  $\sigma = 4.89$  mho/m;  $\epsilon_r = 36.52$ ;  $\rho = 1000$  kg/m<sup>3</sup> ;  
Phantom section: Flat Section; Input Power=10dBm  
Ambient temperature (°C): 21.4, Liquid temperature (°C): 21.2

SATIMO Configuration:

- Probe: SSE2; Calibrated: Apr. 13, 2022; Serial No.: SN 13/22 EPGO368
- Sensor-Surface: 4mm (Mechanical Surface Detection)
- Phantom: SAM twin phantom
- Measurement SW: OpenSAR V4\_02\_35

**Configuration/System Check 5300 MHz Head/Area Scan:** Measurement grid: dx=8mm, dy=8mm

**Configuration/System Check 5300 MHz Head/Zoom Scan:** Measurement grid: dx=4mm,dy=4mm, dz=2mm

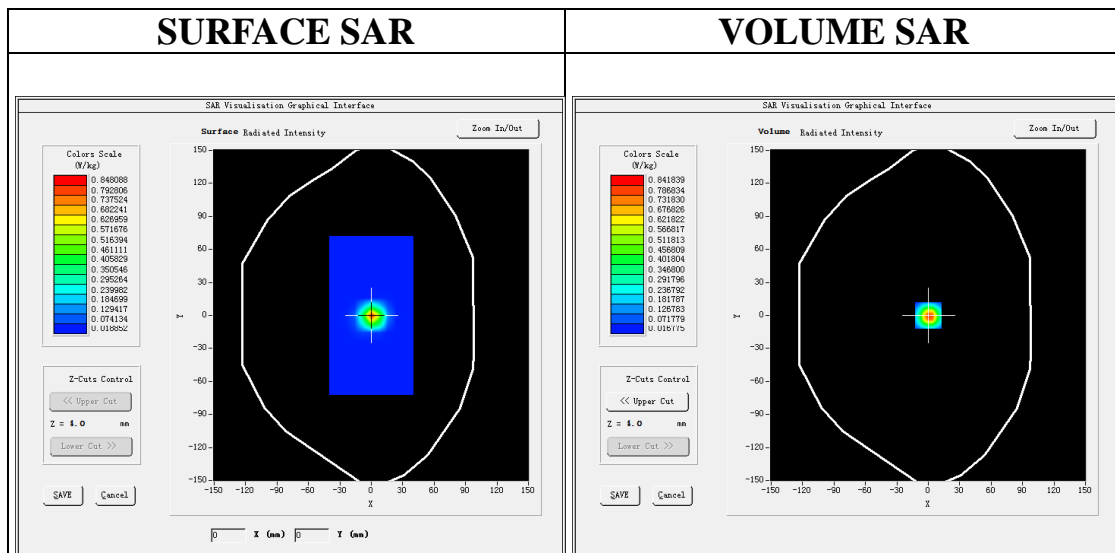

**Maximum location: X=0.00, Y=0.00**

**SAR Peak: 2.33 W/kg**

<b>SAR 10g (W/Kg)</b>	0.222174
<b>SAR 1g (W/Kg)</b>	0.775814

Any report having not been signed by authorized approver, or having been altered without authorization, or having not been stamped by the "Dedicated Testing/Inspection Stamp" is deemed to be invalid. Copying or excerpting portion of, or altering the content of the report is not permitted without the written authorization of AGC. The test results presented in the report apply only to the tested sample. Any objections to report issued by AGC should be submitted to AGC within 15days after the issuance of the test report. Further enquiry of validity or verification of the test report should be addressed to AGC by agc01@agccert.com.

Attestation of Global Compliance(Shenzhen)Co., Ltd

Attestation of Global Compliance(Shenzhen)Std & Tech Co., Ltd

Tel: +86-755 2523 4088 E-mail: agc@agccert.com Web: http://www.agccert.com/

Z (mm)	0.00	4.00	6.00	8.00	10.00	12.00	14.00	16.00	18.00	20.00	22.00	24.00
SAR (W/Kg)	2.3683	0.8418	0.4230	0.1957	0.0877	0.0329	0.0246	0.0192	0.0210	0.0210	0.0210	0.0210

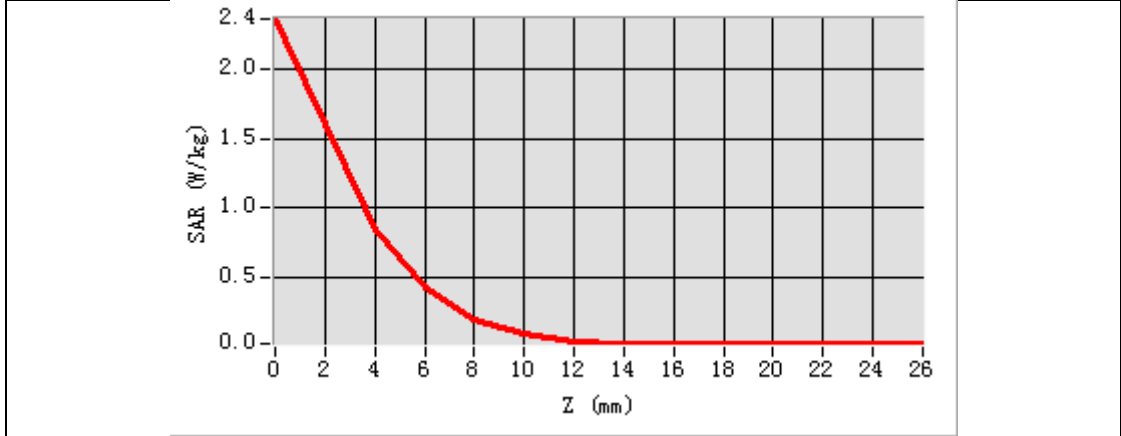

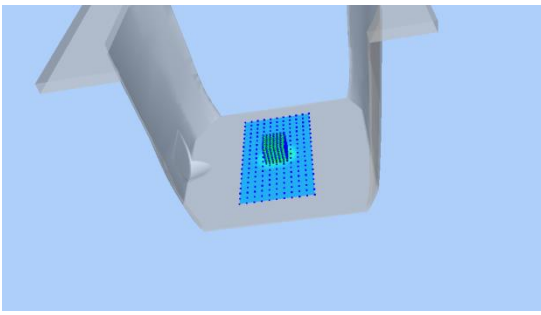
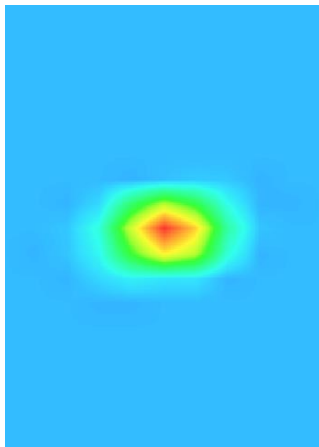
3D screen shot	Hot spot position
	

Any report having not been signed by authorized approver, or having been altered without authorization, or having not been stamped by the “Dedicated Testing/Inspection Stamp” is deemed to be invalid. Copying or excerpting portion of, or altering the content of the report is not permitted without the written authorization of AGC. The test results presented in the report apply only to the tested sample. Any objections to report issued by AGC should be submitted to AGC within 15days after the issuance of the test report. Further enquiry of validity or verification of the test report should be addressed to AGC by agc01@agccert.com.

**Test Laboratory: AGC Lab**  
**System Check Head 5600 MHz**  
**DUT: Dipole 5000MHz Type: SID5000**

**Date: Sep. 25,2022**

Communication System: CW; Communication System Band: D5000 (5000.0 MHz); Duty Cycle: 1:1; Conv.F=1.52  
Frequency: 5600 MHz; Medium parameters used:  $f = 5600$  MHz;  $\sigma = 5.16$  mho/m;  $\epsilon_r = 36.61$ ;  $\rho = 1000$  kg/m<sup>3</sup> ;  
Phantom section: Flat Section; Input Power=10dBm  
Ambient temperature (°C): 21.6, Liquid temperature (°C): 21.4

SATIMO Configuration:

- Probe: SSE2; Calibrated: Apr. 13, 2022; Serial No.: SN 13/22 EPGO368
- Sensor-Surface: 4mm (Mechanical Surface Detection)
- Phantom: SAM twin phantom
- Measurement SW: OpenSAR V4\_02\_35

**Configuration/System Check 5600 MHz Head/Area Scan:** Measurement grid: dx=8mm, dy=8mm

**Configuration/System Check 5600 MHz Head/Zoom Scan:** Measurement grid: dx=4mm,dy=4mm, dz=2mm

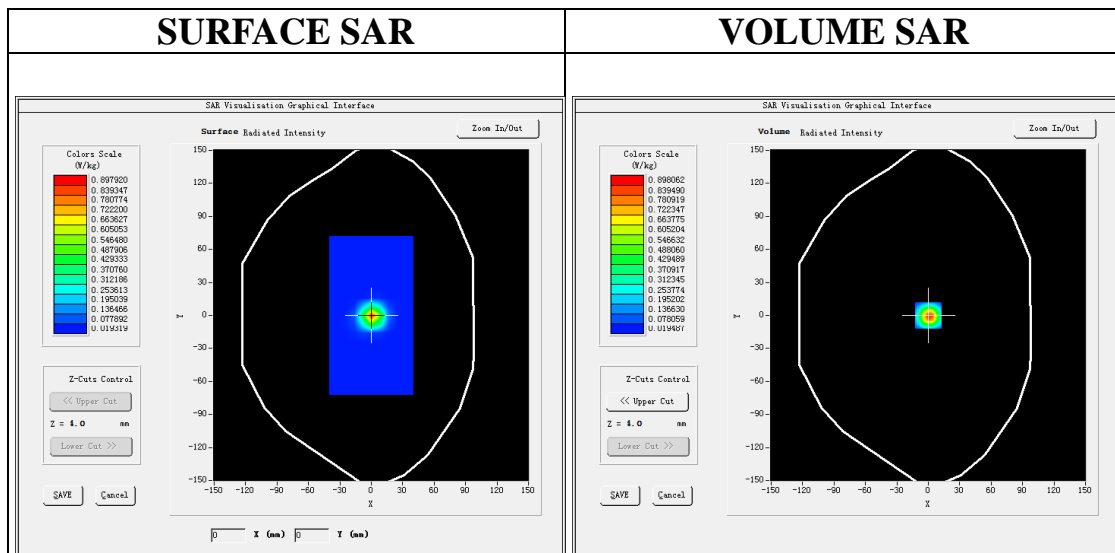

**Maximum location: X=0.00, Y=0.00**

**SAR Peak: 2.50 W/kg**

<b>SAR 10g (W/Kg)</b>	0.234755
<b>SAR 1g (W/Kg)</b>	0.825455

Any report having not been signed by authorized approver, or having been altered without authorization, or having not been stamped by the "Dedicated Testing/Inspection Stamp" is deemed to be invalid. Copying or excerpting portion of, or altering the content of the report is not permitted without the written authorization of AGC. The test results presented in the report apply only to the tested sample. Any objections to report issued by AGC should be submitted to AGC within 15days after the issuance of the test report. Further enquiry of validity or verification of the test report should be addressed to AGC by agc01@agccert.com.

Z (mm)	0.00	4.00	6.00	8.00	10.00	12.00	14.00	16.00	18.00	20.00	22.00	24.00
SAR (W/Kg)	2.5142	0.8981	0.4512	0.2124	0.0948	0.0367	0.0254	0.0196	0.0215	0.0215	0.0215	0.0215

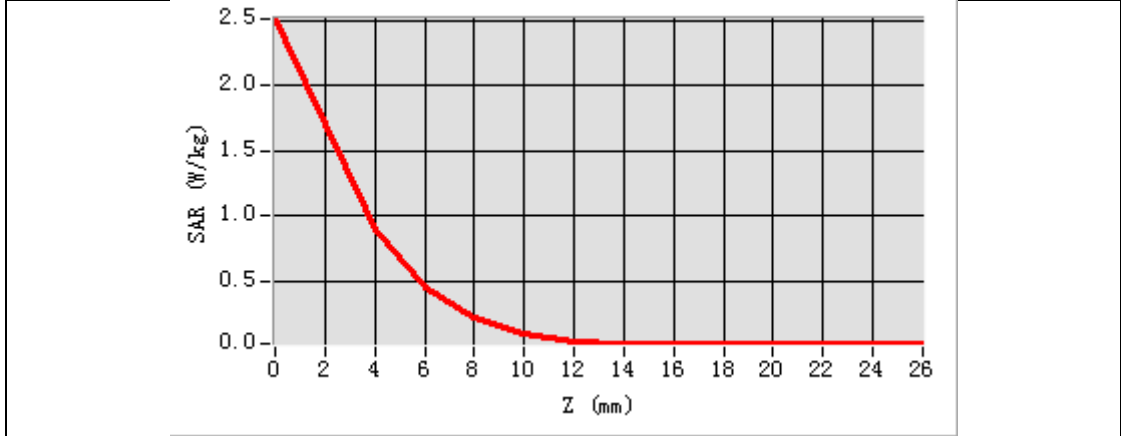

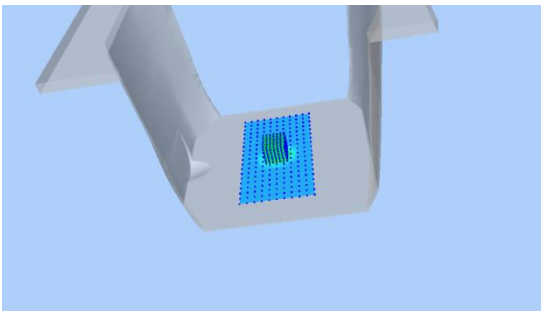
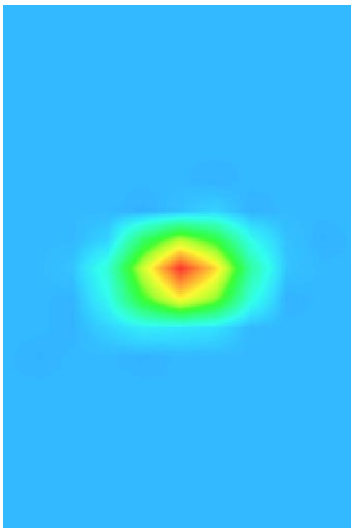
3D screen shot	Hot spot position
	

Any report having not been signed by authorized approver, or having been altered without authorization, or having not been stamped by the "Dedicated Testing/Inspection Stamp" is deemed to be invalid. Copying or excerpting portion of, or altering the content of the report is not permitted without the written authorization of AGC. The test results presented in the report apply only to the tested sample. Any objections to report issued by AGC should be submitted to AGC within 15days after the issuance of the test report. Further enquiry of validity or verification of the test report should be addressed to AGC by agc01@agccert.com.

**Test Laboratory: AGC Lab**  
**System Check Head 5800 MHz**  
**DUT: Dipole 5000MHz Type: SID5000**

**Date: Sep. 22,2022**

Communication System: CW; Communication System Band: D5000 (5000.0 MHz); Duty Cycle: 1:1; Conv.F=1.42  
Frequency: 5800 MHz; Medium parameters used:  $f = 5800$  MHz;  $\sigma = 5.32$  mho/m;  $\epsilon_r = 35.62$ ;  $\rho = 1000$  kg/m<sup>3</sup> ;  
Phantom section: Flat Section; Input Power=10dBm  
Ambient temperature (°C): 21.9, Liquid temperature (°C): 21.6

SATIMO Configuration:

- Probe: SSE2; Calibrated: Apr. 13, 2022; Serial No.: SN 13/22 EPG0368
- Sensor-Surface: 4mm (Mechanical Surface Detection)
- Phantom: SAM twin phantom
- Measurement SW: OpenSAR V4\_02\_35

**Configuration/System Check 5800 MHz Head/Area Scan:** Measurement grid: dx=8mm, dy=8mm

**Configuration/System Check 5800 MHz Head/Zoom Scan:** Measurement grid: dx=4mm,dy=4mm, dz=2mm

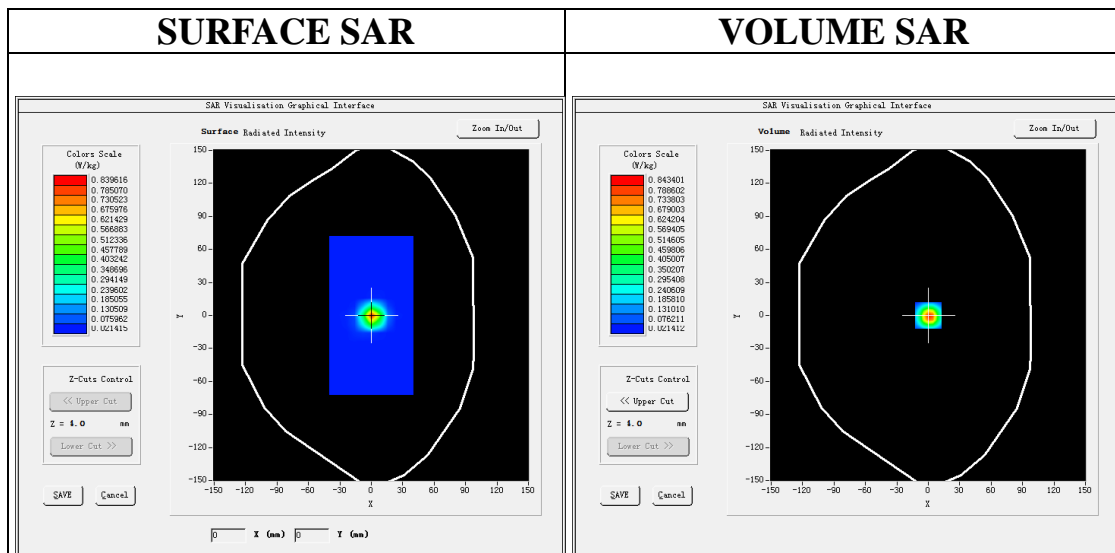

**Maximum location: X=0.00, Y=0.00**

**SAR Peak: 2.36 W/kg**

<b>SAR 10g (W/Kg)</b>	0.224583
<b>SAR 1g (W/Kg)</b>	0.782869

Any report having not been signed by authorized approver, or having been altered without authorization, or having not been stamped by the "Dedicated Testing/Inspection Stamp" is deemed to be invalid. Copying or excerpting portion of, or altering the content of the report is not permitted without the written authorization of AGC. The test results presented in the report apply only to the tested sample. Any objections to report issued by AGC should be submitted to AGC within 15days after the issuance of the test report. Further enquiry of validity or verification of the test report should be addressed to AGC by agc01@agccert.com.

Z (mm)	0.00	4.00	6.00	8.00	10.00	12.00	14.00	16.00	18.00	20.00	22.00	24.00
SAR (W/Kg)	2.3819	0.8434	0.4190	0.1929	0.0890	0.0383	0.0218	0.0218	0.0239	0.0239	0.0239	0.0239

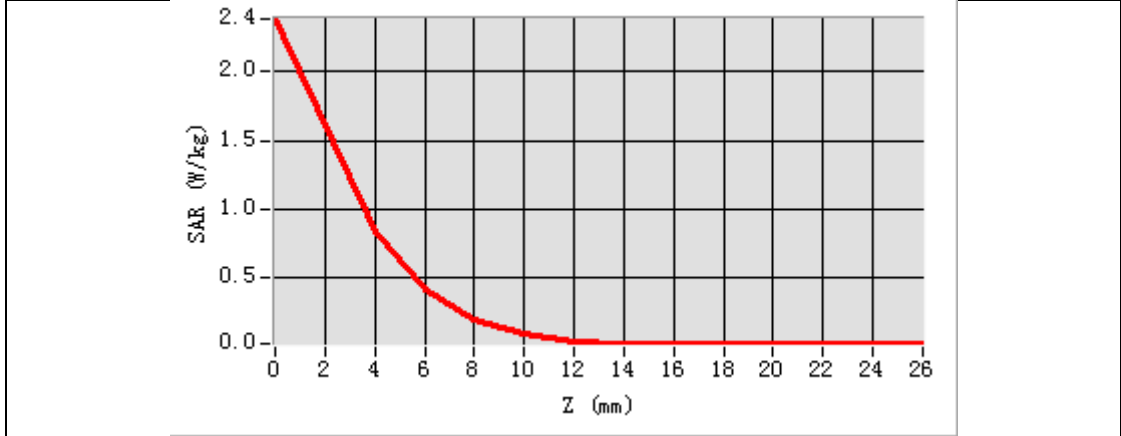

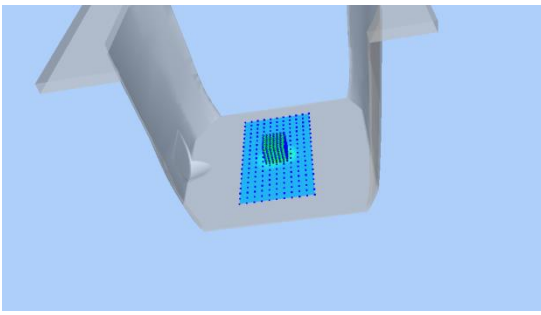
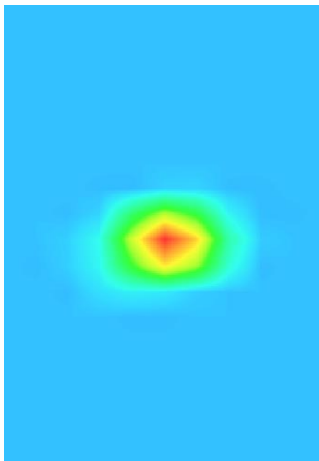
3D screen shot	Hot spot position
	

Any report having not been signed by authorized approver, or having been altered without authorization, or having not been stamped by the "Dedicated Testing/Inspection Stamp" is deemed to be invalid. Copying or excerpting portion of, or altering the content of the report is not permitted without the written authorization of AGC. The test results presented in the report apply only to the tested sample. Any objections to report issued by AGC should be submitted to AGC within 15days after the issuance of the test report. Further enquiry of validity or verification of the test report should be addressed to AGC by agc01@agccert.com.

## APPENDIX B. SAR MEASUREMENT DATA

2.4GHz 802.11b

Test Laboratory: AGC Lab

802.11b Mid- Edge2

DUT: Body Worn Camera; Type: K6

Date: Sep. 29,2022

Communication System: Wi-Fi; Communication System Band: 802.11b; Duty Cycle: 1:1; Conv.F=1.99;  
Frequency: 2437 MHz; Medium parameters used:  $f = 2450$  MHz;  $\sigma = 1.72$  mho/m;  $\epsilon_r = 39.22$ ;  $\rho = 1000$  kg/m<sup>3</sup> ;  
Phantom section: Flat Section  
Ambient temperature (°C):22.1, Liquid temperature (°C): 21.8

SATIMO Configuration:

- Probe: SSE2; Calibrated: Apr. 13, 2022; Serial No.: SN 13/22 EPGO368
- Sensor-Surface: 4mm (Mechanical Surface Detection)
- Phantom: SAM twin phantom
- Measurement SW: OpenSAR V4\_02\_32

Configuration/802.11b Mid- Edge2 /Area Scan: Measurement grid: dx=8mm, dy=8mm

Configuration/802.11b Mid- Edge2 /Zoom Scan: Measurement grid: dx=5mm,dy=5mm, dz=5mm;

Area Scan	surf_sam_plan.txt, h= 5.00 mm
ZoomScan	7x7x7,dx=5mm dy=5mm dz=5mm
Phantom	SAM twin phantom
Device Position	Edge2
Band	2450MHz
Channels	Middle
Signal	Crest factor: 1.0

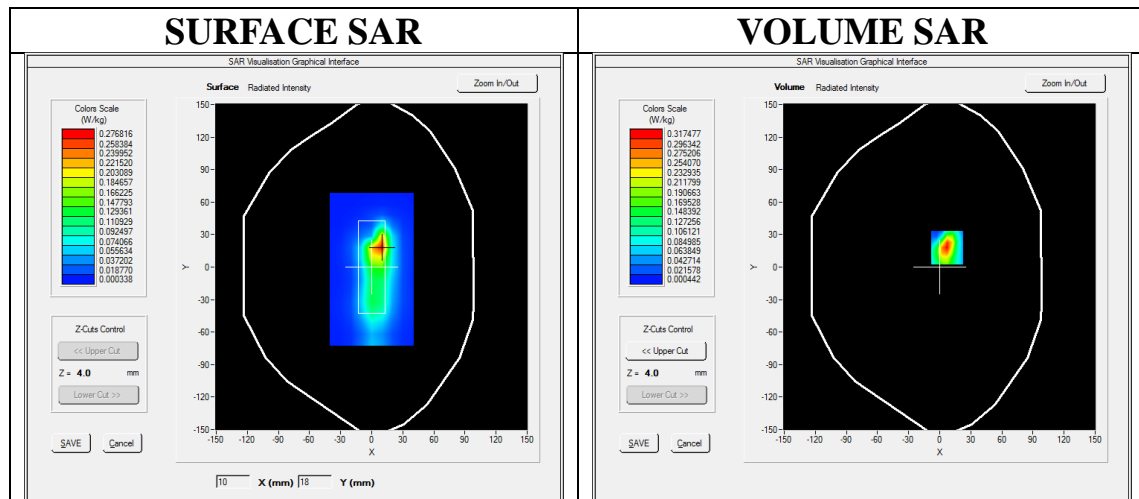

**Maximum location: X=7.00, Y=18.00**  
**SAR Peak: 0.58 W/kg**

<b>SAR 10g (W/Kg)</b>	0.111564
<b>SAR 1g (W/Kg)</b>	0.279849

Any report having not been signed by authorized approver, or having been altered without authorization, or having not been stamped by the "Dedicated Testing/Inspection Stamp" is deemed to be invalid. Copying or excerpting portion of, or altering the content of the report is not permitted without the written authorization of AGC. The test results presented in the report apply only to the tested sample. Any objections to report issued by AGC should be submitted to AGC within 15days after the issuance of the test report. Further enquiry of validity or verification of the test report should be addressed to AGC by agc01@agccert.com.

Attestation of Global Compliance(Shenzhen)Co., Ltd

Attestation of Global Compliance(Shenzhen)Std & Tech Co., Ltd

Tel: +86-755 2523 4088 E-mail: agc@agccert.com Web: http://www.agccert.com/



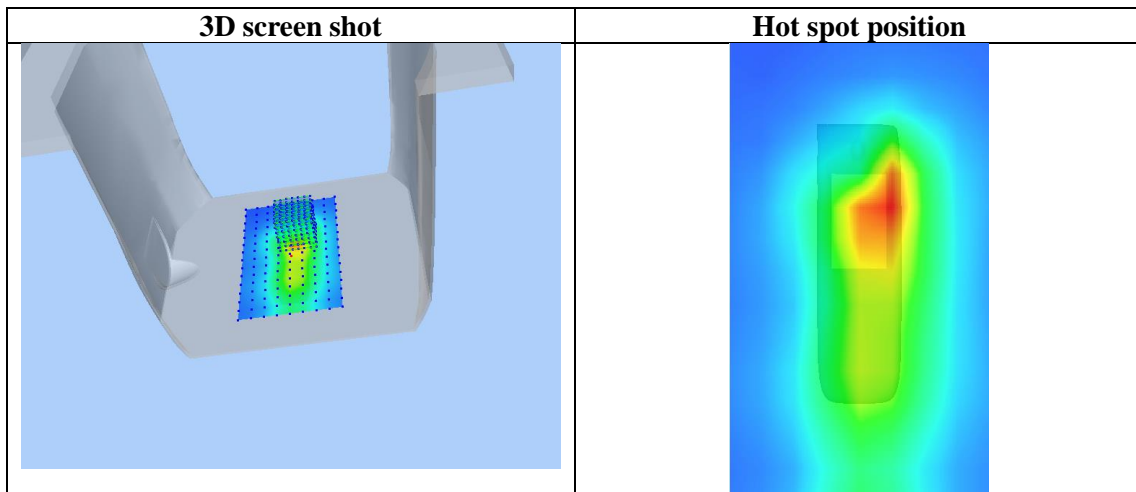
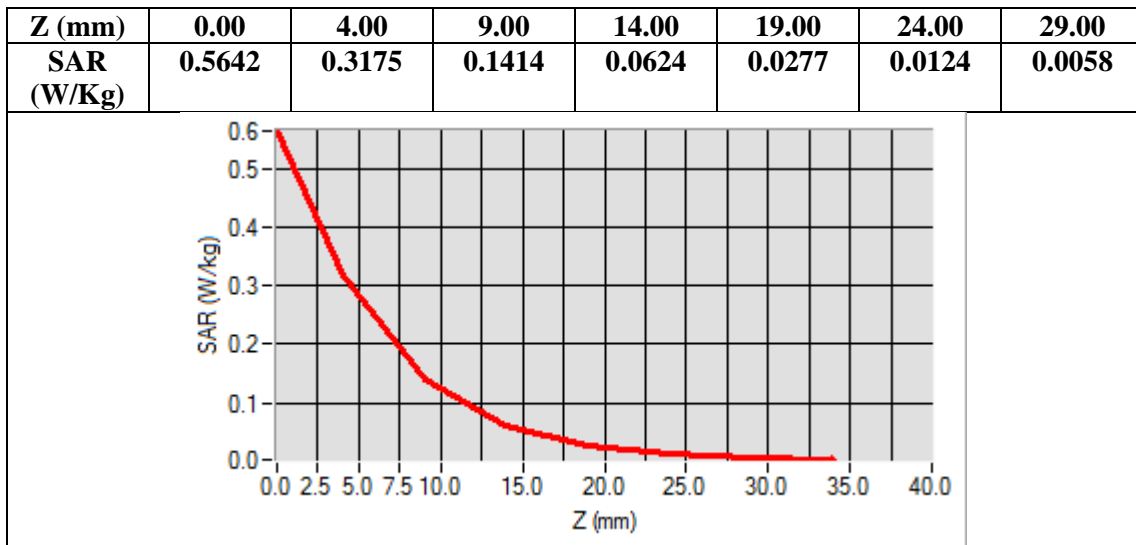

Any report having not been signed by authorized approver, or having been altered without authorization, or having not been stamped by the "Dedicated Testing/Inspection Stamp" is deemed to be invalid. Copying or excerpting portion of, or altering the content of the report is not permitted without the written authorization of AGC. The test results presented in the report apply only to the tested sample. Any objections to report issued by AGC should be submitted to AGC within 15days after the issuance of the test report. Further enquiry of validity or verification of the test report should be addressed to AGC by [agc01@agccert.com](mailto:agc01@agccert.com).

**5.2GHz 802.11a**

Test Laboratory: AGC Lab

802.11a CH40-Edge2

DUT: Body Worn Camera; Type: K6

Date: Sep. 20,2022

Communication System: Wi-Fi; Communication System Band: 802.11a; Duty Cycle: 1:1; Conv.F=1.28;  
Frequency: 5200MHz; Medium parameters used:  $f = 5200 \text{ MHz}$ ;  $\sigma = 4.60 \text{ mho/m}$ ;  $\epsilon_r = 35.69$ ;  $\rho = 1000 \text{ kg/m}^3$  ;  
Phantom section: Flat Section  
Ambient temperature ( $^{\circ}\text{C}$ ): 21.6, Liquid temperature ( $^{\circ}\text{C}$ ): 21.2

SATIMO Configuration:

- Probe: SSE2; Calibrated: Apr. 13, 2022; Serial No.: SN 13/22 EPGO368
- Sensor-Surface: 4mm (Mechanical Surface Detection)
- Phantom: SAM twin phantom
- Measurement SW: OpenSAR V4\_02\_35

Configuration/802.11a CH40- Edge2 /Area Scan: Measurement grid: dx=8mm, dy=8mm

Configuration/802.11a CH40- Edge2 /Zoom Scan: Measurement grid: dx=4mm,dy=4mm, dz=2mm

<b>Area Scan</b>	sam_direct_droit2_surf8mm.txt
<b>ZoomScan</b>	7x7x12 dx=4mm dy=4mm dz=2mm
<b>Phantom</b>	Validation plane
<b>Device Position</b>	Edge2
<b>Band</b>	5200MHz
<b>Channels</b>	CH40
<b>Signal</b>	Crest factor: 1.0

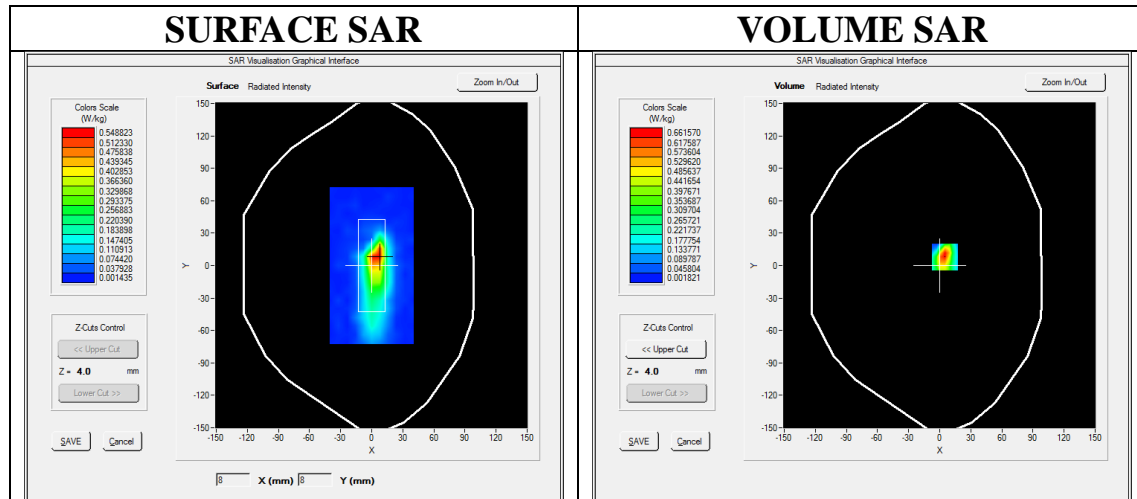

**Maximum location: X=5.00, Y=8.00**

**SAR Peak: 1.30 W/kg**

<b>SAR 10g (W/Kg)</b>	0.214949
<b>SAR 1g (W/Kg)</b>	0.569717

Any report having not been signed by authorized approver, or having been altered without authorization, or having not been stamped by the "Dedicated Testing/Inspection Stamp" is deemed to be invalid. Copying or excerpting portion of, or altering the content of the report is not permitted without the written authorization of AGC. The test results presented in the report apply only to the tested sample. Any objections to report issued by AGC should be submitted to AGC within 15days after the issuance of the test report. Further enquiry of validity or verification of the test report should be addressed to AGC by agc01@agccert.com.

Attestation of Global Compliance(Shenzhen)Co., Ltd

Attestation of Global Compliance(Shenzhen)Std & Tech Co., Ltd

Tel: +86-755 2523 4088 E-mail: agc@agccert.com Web: http://www.agccert.com/

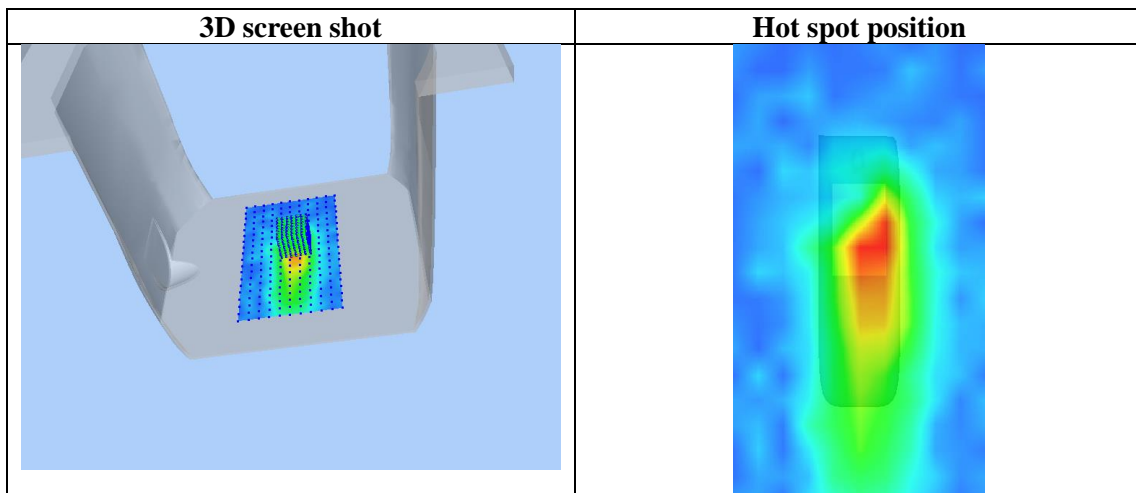
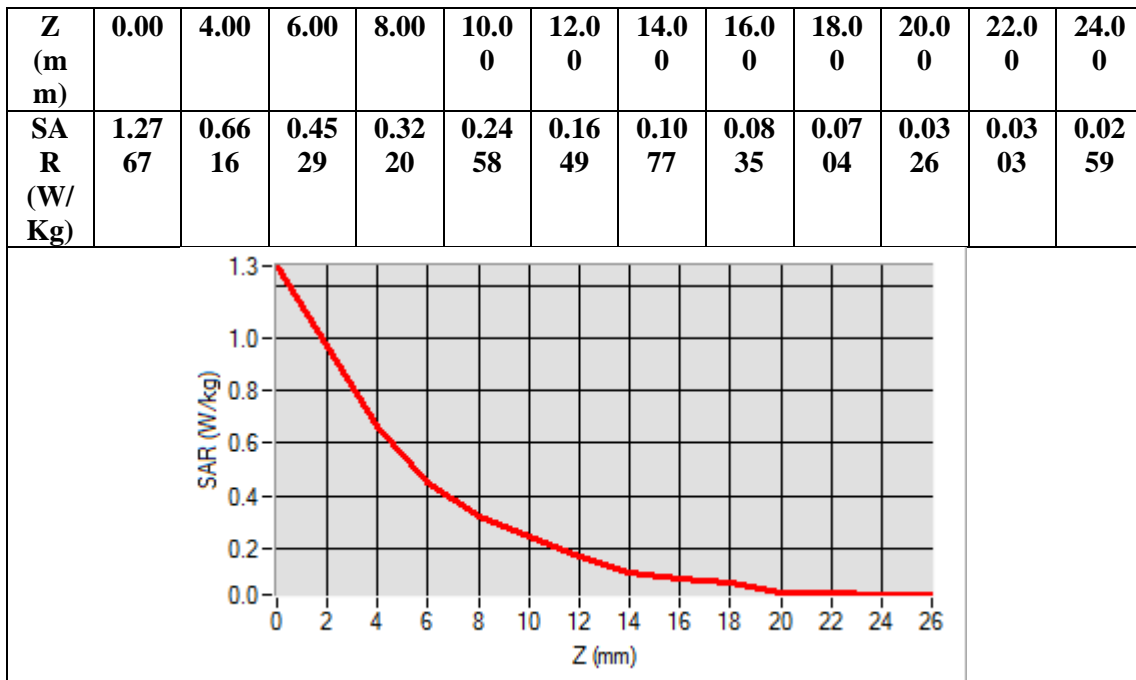

Any report having not been signed by authorized approver, or having been altered without authorization, or having not been stamped by the “Dedicated Testing/Inspection Stamp” is deemed to be invalid. Copying or excerpting portion of, or altering the content of the report is not permitted without the written authorization of AGC. The test results presented in the report apply only to the tested sample. Any objections to report issued by AGC should be submitted to AGC within 15days after the issuance of the test report. Further enquiry of validity or verification of the test report should be addressed to AGC by agc01@agccert.com.

**5.3GHz 802.11a**

Test Laboratory: AGC Lab

802.11a CH60-Edge2

DUT: Body Worn Camera; Type: K6

Date: Sep. 24,2022

Communication System: Wi-Fi; Communication System Band: 802.11a; Duty Cycle: 1:1; Conv.F=1.28;  
Frequency: 5300MHz; Medium parameters used:  $f = 5300$  MHz;  $\sigma = 4.91$ mho/m;  $\epsilon_r = 35.76$ ;  $\rho = 1000$  kg/m<sup>3</sup> ;  
Phantom section: Flat Section  
Ambient temperature (°C): 21.4, Liquid temperature (°C): 21.2

SATIMO Configuration:

- Probe: SSE2; Calibrated: Apr. 13, 2022; Serial No.: SN 13/22 EPGO368
- Sensor-Surface: 4mm (Mechanical Surface Detection)
- Phantom: SAM twin phantom
- Measurement SW: OpenSAR V4\_02\_35

Configuration/802.11a CH60- Edge2 /Area Scan: Measurement grid: dx=8mm, dy=8mm

Configuration/802.11a CH60- Edge2 /Zoom Scan: Measurement grid: dx=4mm,dy=4mm, dz=2mm

<b>Area Scan</b>	sam_direct_droit2_surf8mm.txt
<b>ZoomScan</b>	7x7x12 dx=4mm dy=4mm dz=2mm
<b>Phantom</b>	Validation plane
<b>Device Position</b>	Edge2
<b>Band</b>	5300MHz
<b>Channels</b>	CH60
<b>Signal</b>	Crest factor: 1.0

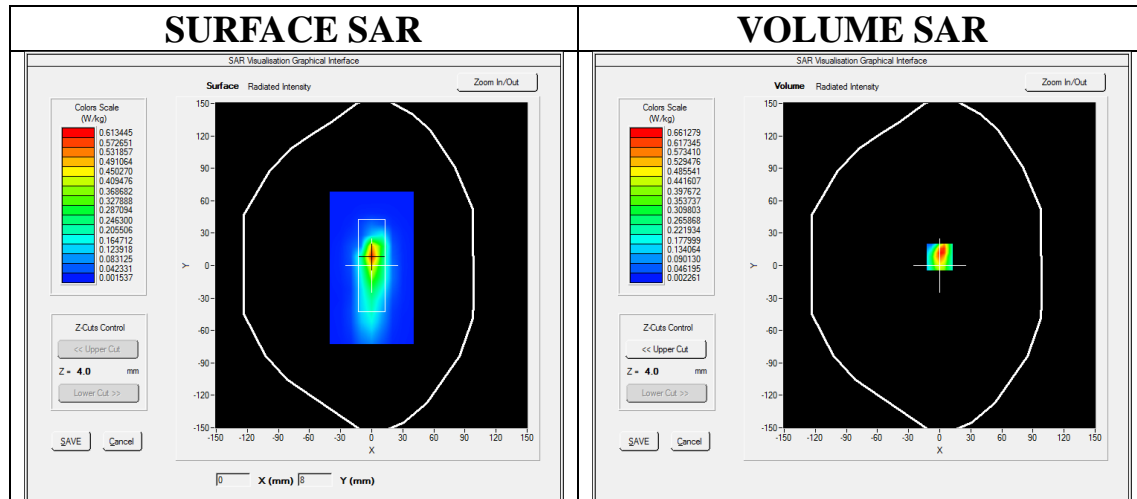

**Maximum location: X=0.00, Y=8.00**

**SAR Peak: 1.36 W/kg**

<b>SAR 10g (W/Kg)</b>	0.229178
<b>SAR 1g (W/Kg)</b>	0.573452

Any report having not been signed by authorized approver, or having been altered without authorization, or having not been stamped by the "Dedicated Testing/Inspection Stamp" is deemed to be invalid. Copying or excerpting portion of, or altering the content of the report is not permitted without the written authorization of AGC. The test results presented in the report apply only to the tested sample. Any objections to report issued by AGC should be submitted to AGC within 15days after the issuance of the test report. Further enquiry of validity or verification of the test report should be addressed to AGC by agc01@agccert.com.

Attestation of Global Compliance(Shenzhen)Co., Ltd

Attestation of Global Compliance(Shenzhen)Std & Tech Co., Ltd

Tel: +86-755 2523 4088 E-mail: agc@agccert.com Web: http://www.agccert.com/

<b>Z (m m)</b>	<b>0.00</b>	<b>4.00</b>	<b>6.00</b>	<b>8.00</b>	<b>10.0 0</b>	<b>12.0 0</b>	<b>14.0 0</b>	<b>16.0 0</b>	<b>18.0 0</b>	<b>20.0 0</b>	<b>22.0 0</b>	<b>24.0 0</b>
<b>SAR (W/ Kg)</b>	<b>1.36 16</b>	<b>0.66 13</b>	<b>0.40 23</b>	<b>0.31 95</b>	<b>0.23 04</b>	<b>0.15 87</b>	<b>0.12 41</b>	<b>0.07 82</b>	<b>0.06 77</b>	<b>0.03 88</b>	<b>0.03 72</b>	<b>0.01 99</b>

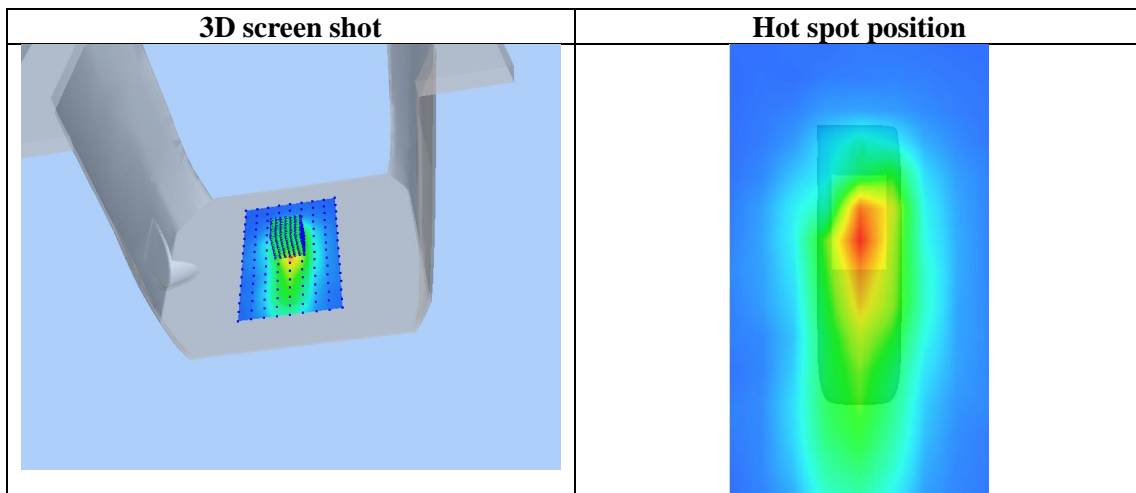
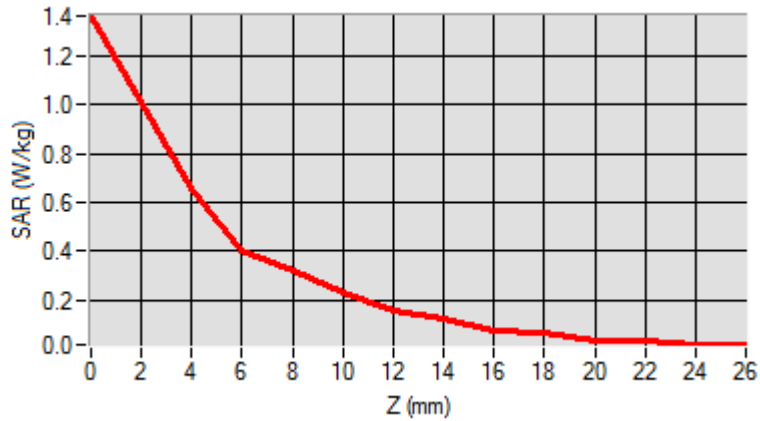

Any report having not been signed by authorized approver, or having been altered without authorization, or having not been stamped by the "Dedicated Testing/Inspection Stamp" is deemed to be invalid. Copying or excerpting portion of, or altering the content of the report is not permitted without the written authorization of AGC. The test results presented in the report apply only to the tested sample. Any objections to report issued by AGC should be submitted to AGC within 15days after the issuance of the test report. Further enquiry of validity or verification of the test report should be addressed to AGC by agc01@agccert.com.

**5.6GHz 802.11a**

Test Laboratory: AGC Lab

802.11a CH120-Edge2

DUT: Body Worn Camera; Type: K6

Date: Sep. 25,2022

Communication System: Wi-Fi; Communication System Band: 802.11a; Duty Cycle: 1:1; Conv.F=2.51;  
Frequency: 5600MHz; Medium parameters used:  $f = 5600$  MHz;  $\sigma = 5.19$  mho/m;  $\epsilon_r = 35.68$ ;  $\rho = 1000$  kg/m<sup>3</sup> ;  
Phantom section: Flat Section  
Ambient temperature (°C): 21.6, Liquid temperature (°C): 21.4

SATIMO Configuration:

- Probe: SSE2; Calibrated: Apr. 13, 2022; Serial No.: SN 13/22 EPGO368
- Sensor-Surface: 4mm (Mechanical Surface Detection)
- Phantom: SAM twin phantom
- Measurement SW: OpenSAR V4\_02\_35

Configuration/802.11a CH120- Edge2 /Area Scan: Measurement grid: dx=8mm, dy=8mm

Configuration/802.11a CH120- Edge2 /Zoom Scan: Measurement grid: dx=4mm,dy=4mm, dz=2mm

<b>Area Scan</b>	sam_direct_droit2_surf8mm.txt
<b>ZoomScan</b>	7x7x12 dx=4mm dy=4mm dz=2mm
<b>Phantom</b>	Validation plane
<b>Device Position</b>	Edge2
<b>Band</b>	5600MHz
<b>Channels</b>	CH120
<b>Signal</b>	Crest factor: 1.0

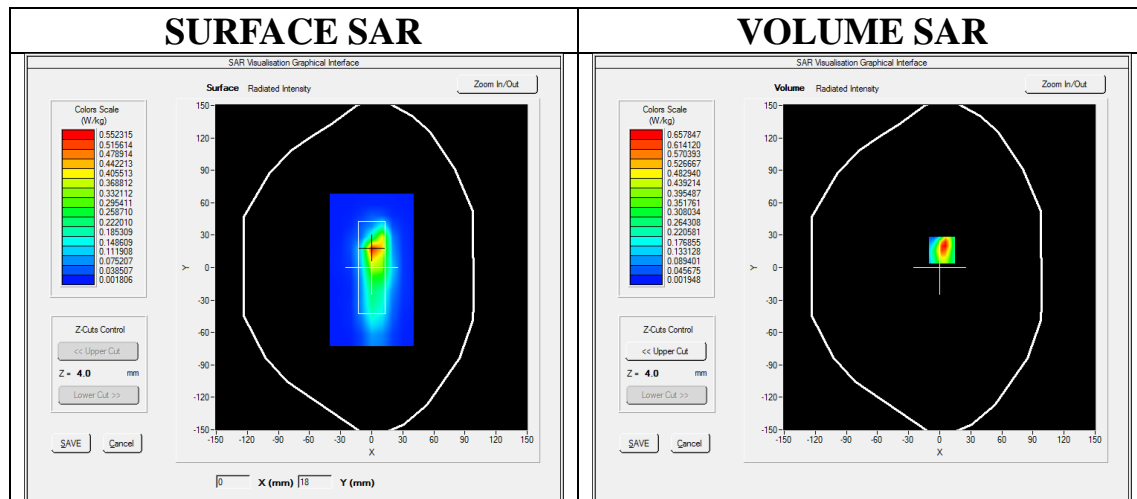

**Maximum location: X=2.00, Y=16.00**

**SAR Peak: 1.37 W/kg**

<b>SAR 10g (W/Kg)</b>	0.226359
<b>SAR 1g (W/Kg)</b>	0.570963

Any report having not been signed by authorized approver, or having been altered without authorization, or having not been stamped by the "Dedicated Testing/Inspection Stamp" is deemed to be invalid. Copying or excerpting portion of, or altering the content of the report is not permitted without the written authorization of AGC. The test results presented in the report apply only to the tested sample. Any objections to report issued by AGC should be submitted to AGC within 15days after the issuance of the test report. Further enquiry of validity or verification of the test report should be addressed to AGC by agc01@agccert.com.

Attestation of Global Compliance(Shenzhen)Co., Ltd

Attestation of Global Compliance(Shenzhen)Std & Tech Co., Ltd

Tel: +86-755 2523 4088 E-mail: agc@agccert.com Web: http://www.agccert.com/

<b>Z (m m)</b>	<b>0.00</b>	<b>4.00</b>	<b>6.00</b>	<b>8.00</b>	<b>10.00</b>	<b>12.00</b>	<b>14.00</b>	<b>16.00</b>	<b>18.00</b>	<b>20.00</b>	<b>22.00</b>	<b>24.00</b>
<b>SAR (W/Kg)</b>	<b>1.4488</b>	<b>0.6578</b>	<b>0.3174</b>	<b>0.3300</b>	<b>0.1883</b>	<b>0.1664</b>	<b>0.1030</b>	<b>0.0809</b>	<b>0.0552</b>	<b>0.0409</b>	<b>0.0299</b>	<b>0.0214</b>

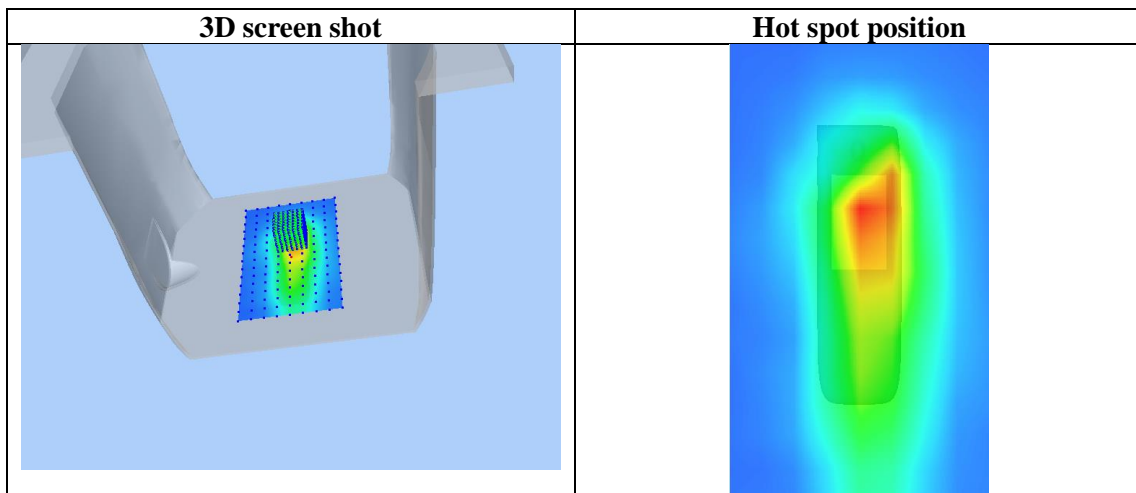
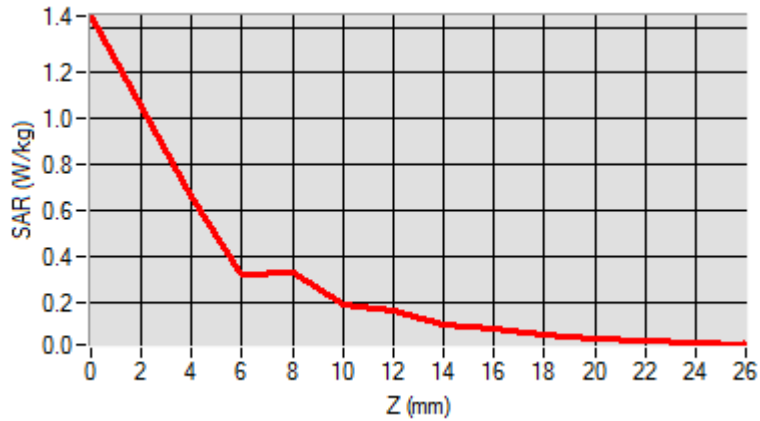

Any report having not been signed by authorized approver, or having been altered without authorization, or having not been stamped by the "Dedicated Testing/Inspection Stamp" is deemed to be invalid. Copying or excerpting portion of, or altering the content of the report is not permitted without the written authorization of AGC. The test results presented in the report apply only to the tested sample. Any objections to report issued by AGC should be submitted to AGC within 15days after the issuance of the test report. Further enquiry of validity or verification of the test report should be addressed to AGC by agc01@agccert.com.

**5.8GHz 802.11a**

Test Laboratory: AGC Lab

802.11a CH157-Edge2

DUT: Body Worn Camera; Type: K6

Date: Sep. 22,2022

Communication System: Wi-Fi; Communication System Band: 802.11a; Duty Cycle: 1:1; Conv.F=1.42;  
Frequency: 5785MHz; Medium parameters used:  $f = 5800$  MHz;  $\sigma = 5.36$  mho/m;  $\epsilon_r = 34.26$ ;  $\rho = 1000$  kg/m<sup>3</sup> ;  
Phantom section: Flat Section  
Ambient temperature (°C): 21.9, Liquid temperature (°C): 21.6

SATIMO Configuration:

- Probe: SSE2; Calibrated: Apr. 13, 2022; Serial No.: SN 13/22 EPGO368
- Sensor-Surface: 4mm (Mechanical Surface Detection)
- Phantom: SAM twin phantom
- Measurement SW: OpenSAR V4\_02\_35

Configuration/ 802.11a CH157- Edge2 /Area Scan: Measurement grid: dx=8mm, dy=8mm

Configuration/ 802.11a CH157- Edge2 /Zoom Scan: Measurement grid: dx=4mm,dy=4mm, dz=2mm

Area Scan	sam_direct_droit2_surf8mm.txt
ZoomScan	7x7x12 dx=4mm dy=4mm dz=2mm
Phantom	Validation plane
Device Position	Edge2
Band	5800MHz
Channels	CH157
Signal	Crest factor: 1.0

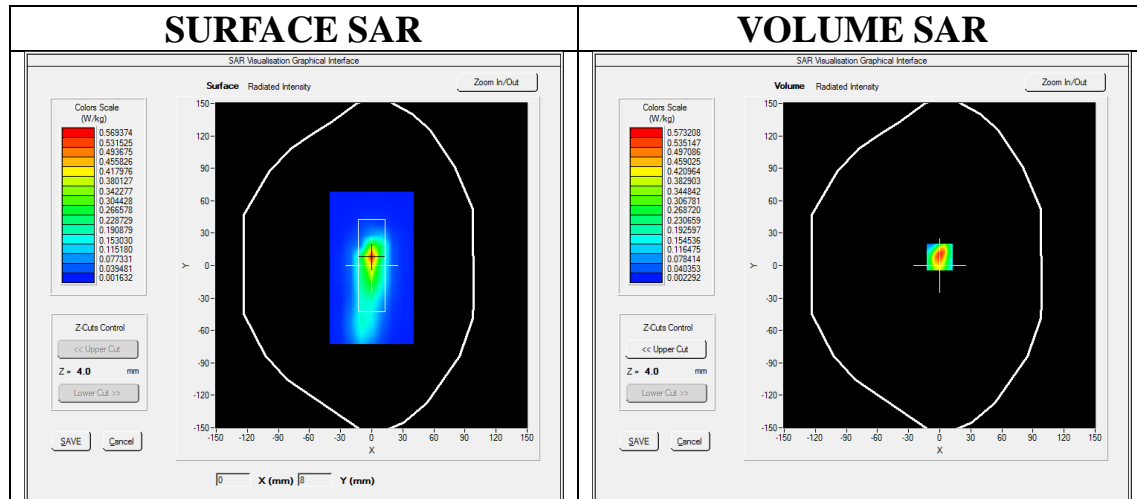

**Maximum location: X=0.00, Y=8.00**

**SAR Peak: 1.13 W/kg**

<b>SAR 10g (W/Kg)</b>	0.197535
<b>SAR 1g (W/Kg)</b>	0.491512

Any report having not been signed by authorized approver, or having been altered without authorization, or having not been stamped by the "Dedicated Testing/Inspection Stamp" is deemed to be invalid. Copying or excerpting portion of, or altering the content of the report is not permitted without the written authorization of AGC. The test results presented in the report apply only to the tested sample. Any objections to report issued by AGC should be submitted to AGC within 15days after the issuance of the test report. Further enquiry of validity or verification of the test report should be addressed to AGC by agc01@agccert.com.

Attestation of Global Compliance(Shenzhen)Co., Ltd

Attestation of Global Compliance(Shenzhen)Std & Tech Co., Ltd

Tel: +86-755 2523 4088 E-mail: agc@agccert.com Web: http://www.agccert.com/



<b>Z (m m)</b>	<b>0.00</b>	<b>4.00</b>	<b>6.00</b>	<b>8.00</b>	<b>10.0 0</b>	<b>12.0 0</b>	<b>14.0 0</b>	<b>16.0 0</b>	<b>18.0 0</b>	<b>20.0 0</b>	<b>22.0 0</b>	<b>24.0 0</b>
<b>SAR (W/ Kg)</b>	<b>1.16 40</b>	<b>0.57 32</b>	<b>0.37 19</b>	<b>0.26 94</b>	<b>0.20 80</b>	<b>0.13 16</b>	<b>0.11 11</b>	<b>0.06 52</b>	<b>0.05 73</b>	<b>0.03 20</b>	<b>0.02 97</b>	<b>0.01 63</b>

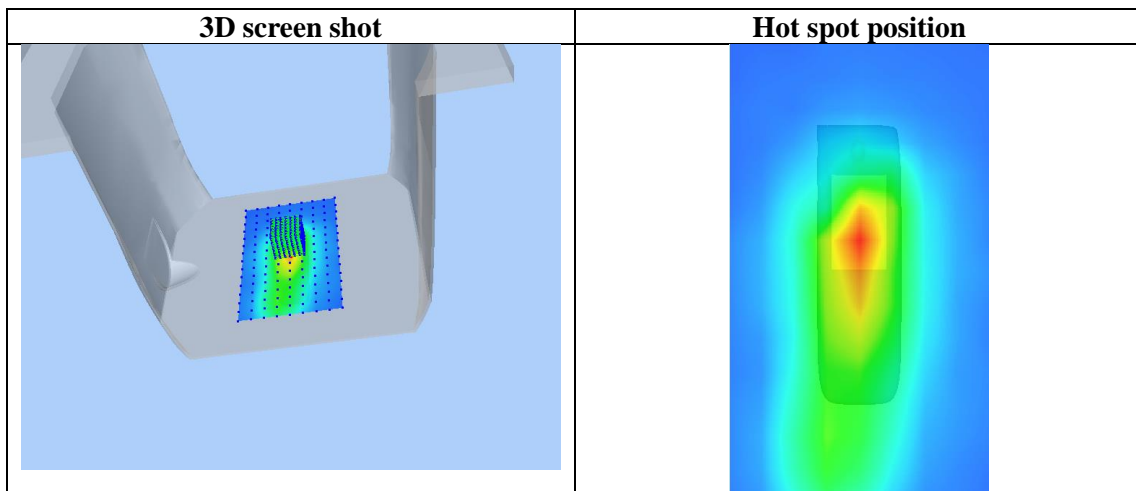
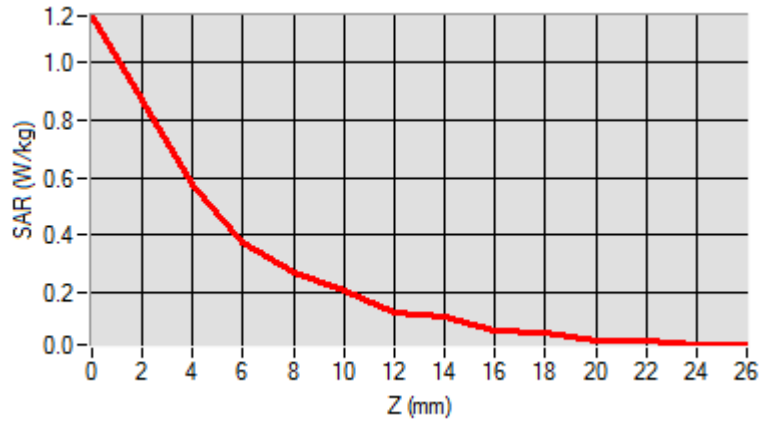

Any report having not been signed by authorized approver, or having been altered without authorization, or having not been stamped by the "Dedicated Testing/Inspection Stamp" is deemed to be invalid. Copying or excerpting portion of, or altering the content of the report is not permitted without the written authorization of AGC. The test results presented in the report apply only to the tested sample. Any objections to report issued by AGC should be submitted to AGC within 15days after the issuance of the test report. Further enquiry of validity or verification of the test report should be addressed to AGC by agc01@agccert.com.

**APPENDIX C. TEST SETUP PHOTOGRAPHS**

Body Back 0mm

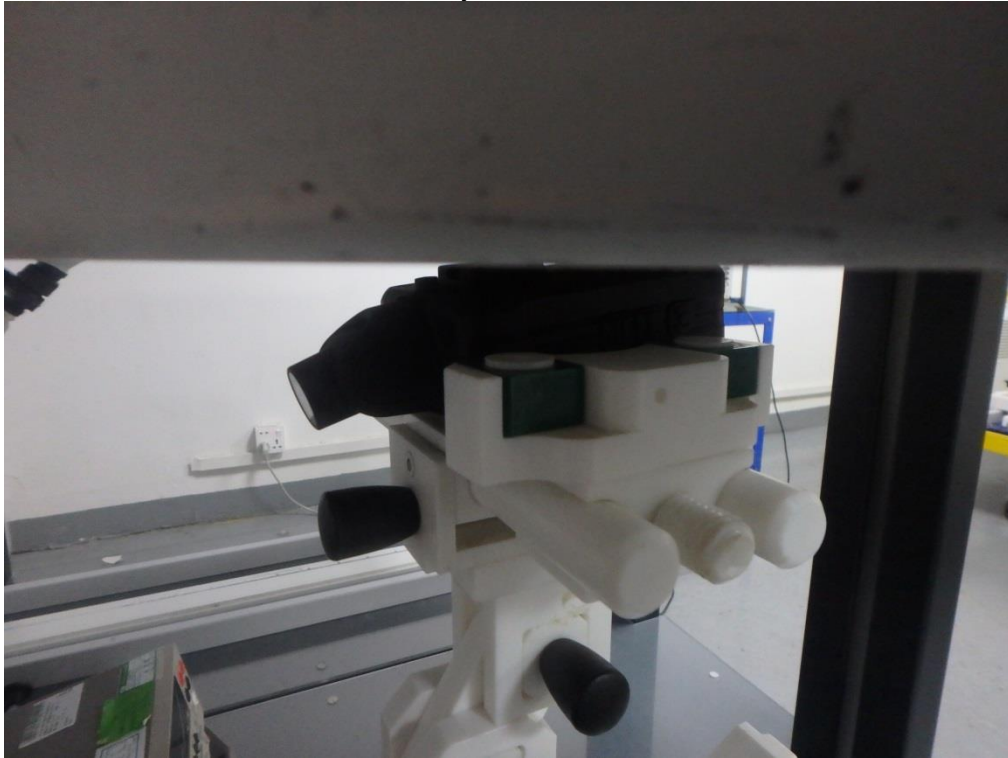

Body Front 0mm

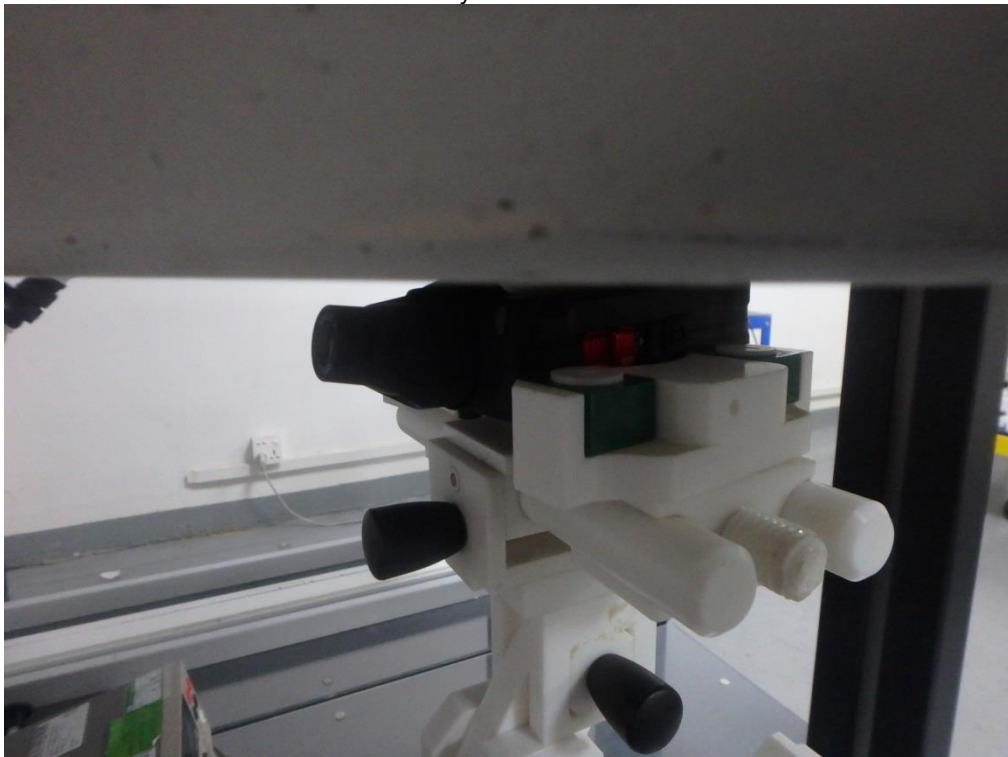

Any report having not been signed by authorized approver, or having been altered without authorization, or having not been stamped by the "Dedicated Testing/Inspection Stamp" is deemed to be invalid. Copying or excerpting portion of, or altering the content of the report is not permitted without the written authorization of AGC. The test results presented in the report apply only to the tested sample. Any objections to report issued by AGC should be submitted to AGC within 15days after the issuance of the test report. Further enquiry of validity or verification of the test report should be addressed to AGC by [agc01@agccert.com](mailto:agc01@agccert.com).

Attestation of Global Compliance(Shenzhen)Co., Ltd

Attestation of Global Compliance(Shenzhen)Std & Tech Co., Ltd

Tel: +86-755 2523 4088 E-mail: [agc@agccert.com](mailto:agc@agccert.com) Web: <http://www.agccert.com/>

Edge1 (Top) 0mm

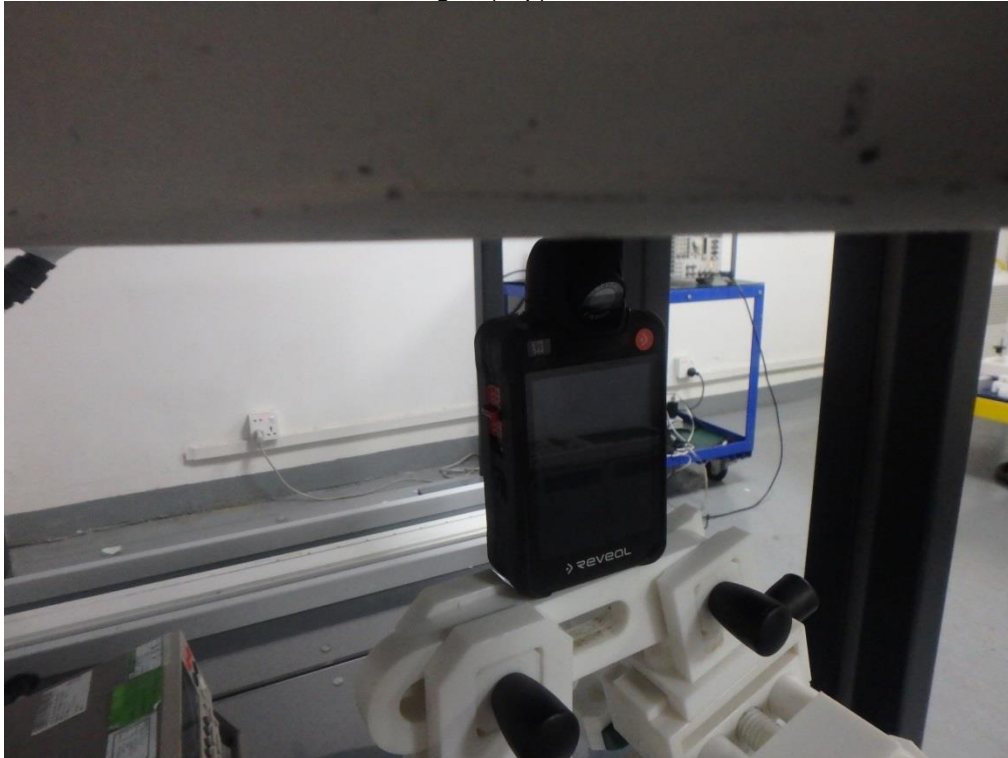

Edge2 (Right) 0mm

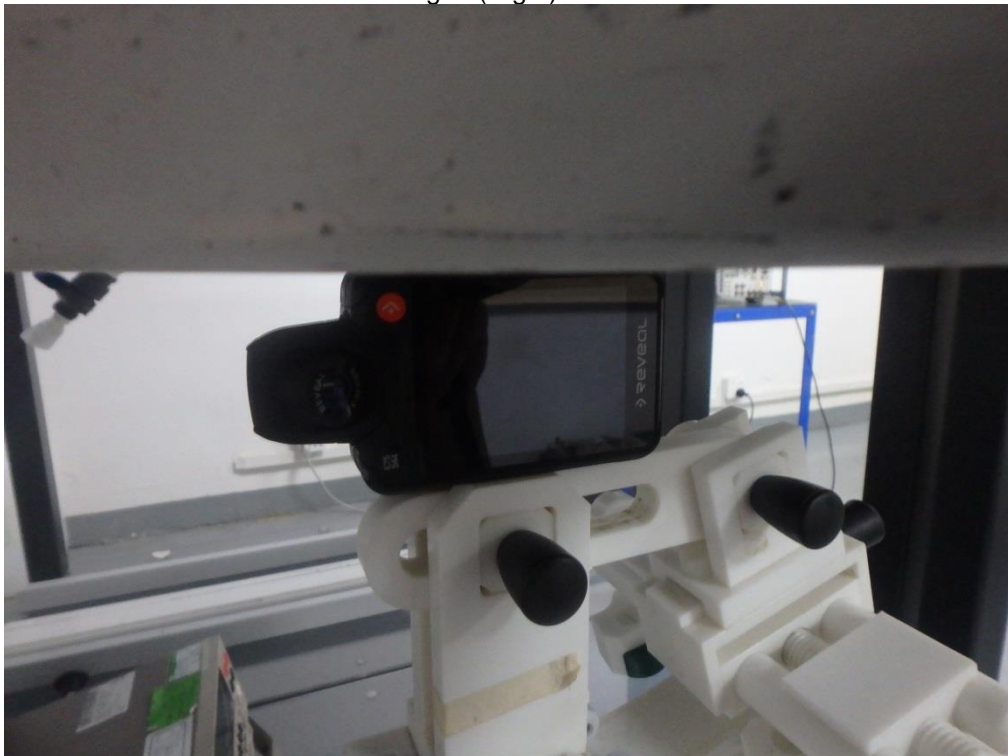

Any report having not been signed by authorized approver, or having been altered without authorization, or having not been stamped by the "Dedicated Testing/Inspection Stamp" is deemed to be invalid. Copying or excerpting portion of, or altering the content of the report is not permitted without the written authorization of AGC. The test results presented in the report apply only to the tested sample. Any objections to report issued by AGC should be submitted to AGC within 15days after the issuance of the test report. Further enquiry of validity or verification of the test report should be addressed to AGC by [agc01@agccert.com](mailto:agc01@agccert.com).

Attestation of Global Compliance(Shenzhen)Co., Ltd

Attestation of Global Compliance(Shenzhen)Std & Tech Co., Ltd

Tel: +86-755 2523 4088 E-mail: [agc@agccert.com](mailto:agc@agccert.com) Web: <http://www.agccert.com/>

Edge3 (Bottom) 0mm

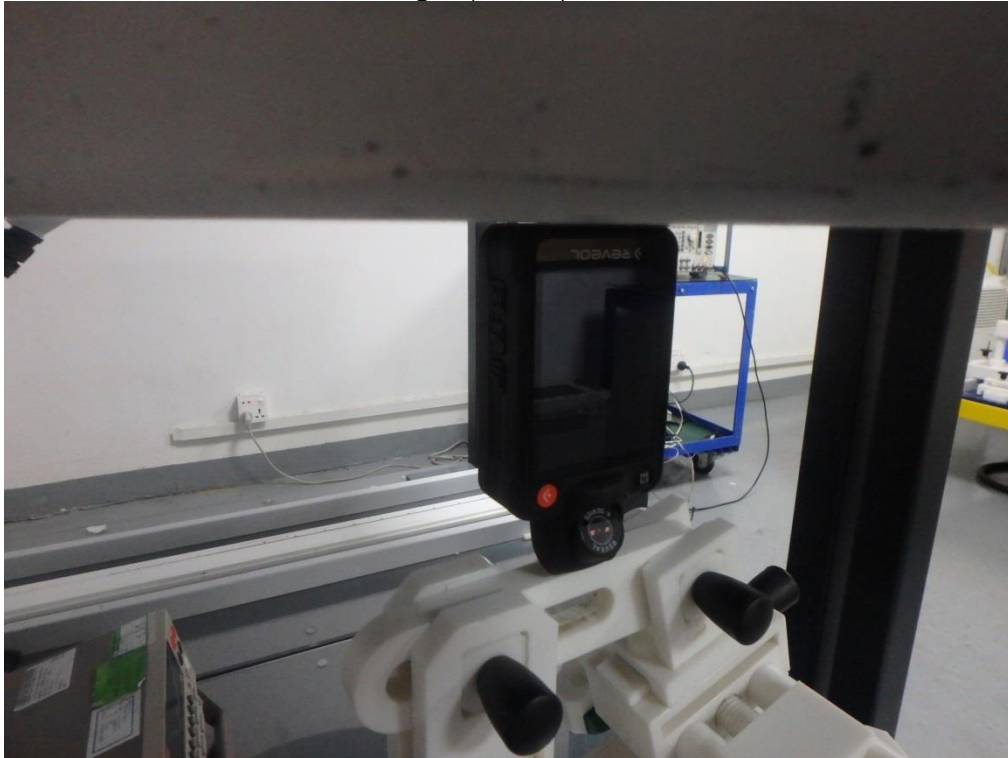

Edge4 (Left) 0mm



Any report having not been signed by authorized approver, or having been altered without authorization, or having not been stamped by the "Dedicated Testing/Inspection Stamp" is deemed to be invalid. Copying or excerpting portion of, or altering the content of the report is not permitted without the written authorization of AGC. The test results presented in the report apply only to the tested sample. Any objections to report issued by AGC should be submitted to AGC within 15days after the issuance of the test report. Further enquiry of validity or verification of the test report should be addressed to AGC by [agc01@agccert.com](mailto:agc01@agccert.com).

Attestation of Global Compliance(Shenzhen)Co., Ltd

Attestation of Global Compliance(Shenzhen)Std & Tech Co., Ltd

Tel: +86-755 2523 4088 E-mail: [agc@agccert.com](mailto:agc@agccert.com) Web: <http://www.agccert.com/>

### DEPTH OF THE LIQUID IN THE PHANTOM—ZOOM IN

Note : The position used in the measurement were according to IEEE Std. 1528:2013

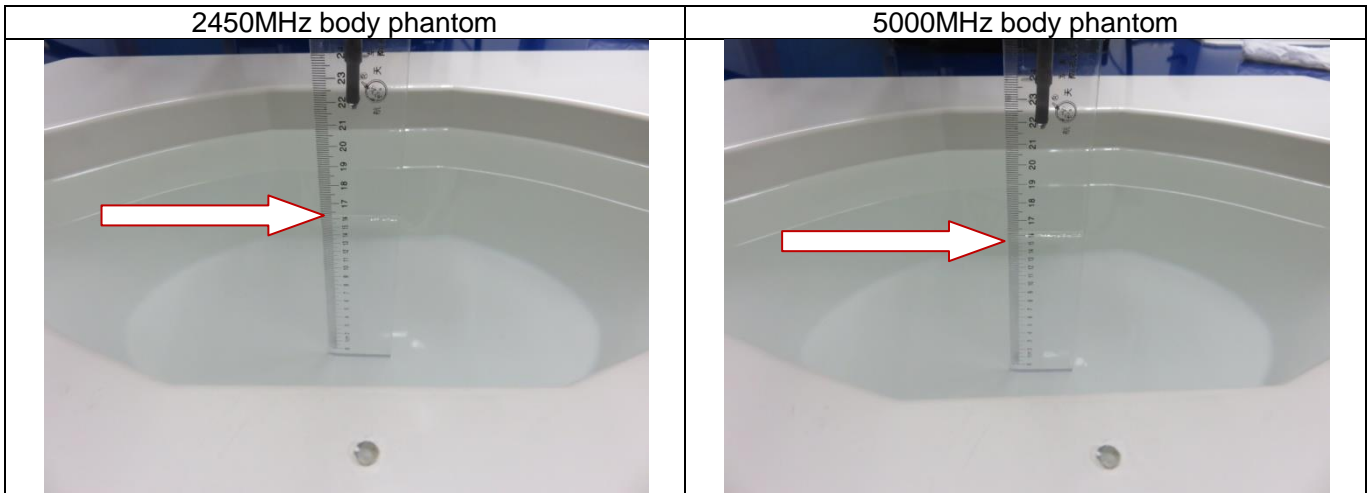

Any report having not been signed by authorized approver, or having been altered without authorization, or having not been stamped by the “Dedicated Testing/Inspection Stamp” is deemed to be invalid. Copying or excerpting portion of, or altering the content of the report is not permitted without the written authorization of AGC. The test results presented in the report apply only to the tested sample. Any objections to report issued by AGC should be submitted to AGC within 15days after the issuance of the test report. Further enquiry of validity or verification of the test report should be addressed to AGC by [agc01@agccert.com](mailto:agc01@agccert.com).

## APPENDIX D. CALIBRATION DATA

Refer to Attached files.

----END OF REPORT----

Any report having not been signed by authorized approver, or having been altered without authorization, or having not been stamped by the "Dedicated Testing/Inspection Stamp" is deemed to be invalid. Copying or excerpting portion of, or altering the content of the report is not permitted without the written authorization of AGC. The test results presented in the report apply only to the tested sample. Any objections to report issued by AGC should be submitted to AGC within 15days after the issuance of the test report. Further enquiry of validity or verification of the test report should be addressed to AGC by [agc01@agccert.com](mailto:agc01@agccert.com).

Attestation of Global Compliance(Shenzhen)Co., Ltd  
Attestation of Global Compliance(Shenzhen)Std & Tech Co., Ltd  
Tel: +86-755 2523 4088 E-mail: [agc@agccert.com](mailto:agc@agccert.com) Web: <http://www.agccert.com/>



## Conditions of Issuance of Test Reports

1. All samples and goods are accepted by the Attestation of Global Compliance (Shenzhen) Co., Ltd. (the “Company”) solely for testing and reporting in accordance with the following terms and conditions. The company provides its services on the basis that such terms and conditions constitute express agreement between the company and any person, firm or company requesting its services (the “Clients”).
2. Any report issued by Company as a result of this application for testing services (the “Report”) shall be issued in confidence to the Clients and the Report will be strictly treated as such by the Company. It may not be reproduced either in its entirety or in part and it may not be used for advertising or other unauthorized purposes without the written consent of the Company. The Clients to whom the Report is issued may, however, show or send it, or a certified copy thereof prepared by the Company to its customer, supplier or other persons directly concerned. The Company will not, without the consent of the Clients, enter into any discussion or correspondence with any third party concerning the contents of the Report, unless required by the relevant governmental authorities, laws or court orders.
3. The Company shall not be called or be liable to be called to give evidence or testimony on the Report in a court of law without its prior written consent, unless required by the relevant governmental authorities, laws or court orders.
4. In the event of the improper use of the report as determined by the Company, the Company reserves the right to withdraw it, and to adopt any other additional remedies which may be appropriate.
5. Samples submitted for testing are accepted on the understanding that the Report issued cannot form the basis of, or be the instrument for, any legal action against the Company.
6. The Company will not be liable for or accept responsibility for any loss or damage however arising from the use of information contained in any of its Reports or in any communication whatsoever about its said tests or investigations.
7. Clients wishing to use the Report in court proceedings or arbitration shall inform the Company to that effect prior to submitting the sample for testing.
8. The Company is not responsible for recalling the electronic version of the original report when any revision is made to them. The Client assumes the responsibility to providing the revised version to any interested party who uses them.
9. Subject to the variable length of retention time for test data and report stored hereinto as otherwise specifically required by individual accreditation authorities, the Company will only keep the supporting test data and information of the test report for a period of six years. The data and information will be disposed of after the aforementioned retention period has elapsed. Under no circumstances shall we provide any data and information which has been disposed of after retention period. Under no circumstances shall we be liable for damage of any kind, including (but not limited to) compensatory damages, lost profits, lost data, or any form of special, incidental, indirect, consequential or punitive damages of any kind, whether based on breach of contract of warranty, tort (including negligence), product liability or otherwise, even if we are informed in advance of the possibility of such damages.

Any report having not been signed by authorized approver, or having been altered without authorization, or having not been stamped by the “Dedicated Testing/Inspection Stamp” is deemed to be invalid. Copying or excerpting portion of, or altering the content of the report is not permitted without the written authorization of AGC. The test results presented in the report apply only to the tested sample. Any objections to report issued by AGC should be submitted to AGC within 15days after the issuance of the test report. Further enquiry of validity or verification of the test report should be addressed to AGC by [agc01@agccert.com](mailto:agc01@agccert.com).