



FCC RADIO TEST REPORT

Applicant : EasyIO Holdings Pte. Ltd.

Address : 101 Cecil Street #09-07, Tong Eng Building,
Singapore 069533

Equipment : Building Automation System

Model No. : FW-14

Trade Name : **EasyIO**[®]

FCC ID : 2AKZUFW14

I HEREBY CERTIFY THAT :

The sample was received on Apr. 27, 2017 and the testing was carried out on May 15, 2017 at CerpPASS Technology Corp. The test result refers exclusively to the test presented test model / sample. Without written approval of CerpPASS Technology Corp., the test report shall not be reproduced except in full.

Approved by:

Miro Chueh

EMC/RF B.U. Manager

Laboratory Accreditation:

CerpPASS Technology Corporation Test Laboratory

TAF LAB Code:	1439
----------------------	-------------

CerpPASS Technology(SuZhou) Co., Ltd.

NVLAP LAB Code:	200814-0
CNAS LAB Code:	L5515



CONTENTS

1. Summary of Test Procedure and Test Results	5
1.1 Applicable Standards.....	5
2. Test Configuration of Equipment under Test	6
2.1 Feature of Equipment under Test.....	6
2.2 Carrier Frequency of Channels.....	6
2.3 Test Mode and Test Software.....	7
2.4 Description of Test System.....	7
2.5 General Information of Test.....	8
2.6 Measurement Uncertainty.....	9
2.7 Duty cycle.....	10
3. Test Equipment and Ancillaries Used for Tests	11
4. Antenna Requirements	12
4.1 Standard Applicable.....	12
4.2 Antenna Construction and Directional Gain.....	12
5. Test of AC Power Line Conducted Emission	13
5.1 Test Limit.....	13
5.2 Test Procedures.....	13
5.3 Typical Test Setup.....	13
5.4 Test Result and Data.....	14
6. Test of Spurious Emission (Radiated)	16
6.1 Test Limit.....	16
6.2 Test Procedures.....	16
6.3 Typical Test Setup.....	17
6.4 Test Result and Data (9KHz ~ 30MHz).....	18
6.5 Test Result and Data (30MHz ~ 1GHz).....	18
6.6 Test Result and Data (1GHz ~ 25GHz).....	19
6.7 Restricted Bands of Operation.....	49
6.8 Restrict Band Emission Measurement Data.....	50
7. Test of Spurious Emission (Conducted)	60
7.1 Test Limit.....	60
7.2 Test Procedure.....	60
7.3 Test Setup Layout.....	60
7.4 Test Result and Data.....	61
8. 6dB Bandwidth Measurement Data	70
8.1 Test Limit.....	70
8.2 Test Procedures.....	70
8.3 Test Setup Layout.....	70
8.4 Test Result and Data.....	70
9. Maximum Peak Output Power	76
9.1 Test Limit.....	76
9.2 Test Procedures.....	76
9.3 Test Setup Layout.....	76
9.4 Test Result and Data.....	77
10.Power Spectral Density	78



10.1 Test Limit	78
10.2 Test Procedures	78
10.3 Test Setup Layout.....	78
10.4 Test Result and Data.....	79



1. Summary of Test Procedure and Test Results

1.1 Applicable Standards

ANSI C63.10: 2013

KDB 558074 D01 DTS Meas Guidance v03r05

FCC Rules and Regulations Part 15 Subpart C §15.247

FCC Rule	Description of Test	Result
FCC CFR Title 47 Part 15 Subpart C: Section 15.203/15.247 (b)	. Antenna Requirement	Pass
FCC CFR Title 47 Part 15 Subpart C: Section 15.207	. AC Power Line Conducted Emission	Pass
FCC CFR Title 47 Part 15 Subpart C: Section 15.205/15.209; Part2 section 2.1051, 2.1053, 2.1057	. Spurious Emission(Radiated)	Pass
FCC CFR Title 47 Part 15 Subpart C: Section 15.247(d); Part2 section 2.1051 and 2.1057	. Spurious Emission(Conducted)	Pass
FCC CFR Title 47 Part 15 Subpart C: Section 15.247(a)(2); Part2 section 2.1049	. 6dB Bandwidth	Pass
FCC CFR Title 47 Part 15 Subpart C: Section 15.247(b); Part2 section 2.1046	. Maximum Peak Output Power	Pass
FCC CFR Title 47 Part 15 Subpart C: Section 15.247(e)	. Power Spectral Density	Pass



2. Test Configuration of Equipment under Test

2.1 Feature of Equipment under Test

Equipment	Building Automation System
Model No.	FW-14
Spreading	802.11b: CCK, DQPSK, DBPSK 802.11g: 64 QAM, 16 QAM, QPSK, BPSK 802.11n: BPSK, QPSK, 16QAM, 64QAM
Frequency Range	802.11b/g/n(20MHz): 2412-2462MHz 802.11n(40MHz): 2422-2452MHz
Number of Channels	802.11b/g/n (20MHz):11 802.11n (40MHz): 7
Data Rate	802.11b: 1, 2, 5.5, 11Mbps 802.11g: 6, 9, 12, 18, 24, 36, 48, 54Mbps 802.11n: Up to 300Mbps
Antenna Type	Dipole Antenna 2dBi
Power Rating	24V AC/DC, 0.2A, 4.8W, 60Hz

2.2 Carrier Frequency of Channels

802.11b, 802.11g, 802.11n HT 20 (2412MHz~2462MHz)

Channel	Frequency(MHz)	Channel	Frequency(MHz)
*01	2412	07	2442
02	2417	08	2447
03	2422	09	2452
04	2427	10	2457
05	2432	*11	2462
*06	2437	---	---

802.11an HT40(2422-2452MHz)

Channel	Frequency(MHz)	Channel	Frequency(MHz)
---	---	07	2442
---	---	08	2447
*03	2422	*09	2452
04	2427	---	---
05	2432	---	---
*06	2437	---	---

Note: Channels remarked * are selected to perform test.



2.3 Test Mode and Test Software

- a. During testing, the interface cables and equipment positions were varied according to ANSI C63.4.
- b. The complete test system included Notebook, Mouse and EUT for the RF test.
- c. An executive program, "artgui.exe" which transmits and receives data through Wireless.
- d. The EUT had been tested under operating condition
After verification, all tests were carried out with the worst case test modes as shown below except radiated spurious emission below 1GHz and power line conducted emissions below 30MHz, which worst case was in normal link mode only.
EUT staying in continuous transmitting mode was programmed.
- e. Test modes:
 - Mode 1: IEEE 802.11b
 - Mode 2: IEEE 802.11g
 - Mode 3: IEEE 802.11n 20
 - Mode 4: IEEE 802.11n 40

2.4 Description of Test System

No	Device	Manufacturer	Model No.	Description
1	USB Mouse	DELL	OXN967	R41108
2	NB	SONY	PCG-71811P	R33021
3	Adapter	THAI LIN	TL60S-240-1041FL	N/A

Use Cable:

No.	Cable	Quantity	Description
A	RJ45 Cable	1	1.2m Shielding
B	USB Mouse Cable	1	1.8m Non Shielding
C	AC Cable	1	1.0m Non Shielding



2.5 General Information of Test

<input type="checkbox"/>	Test Site	CerpPASS Technology Corporation Test Laboratory Address: No.10, Ln. 2, Lianfu St., Luzhu Dist., Taoyuan City 33848, Taiwan (R.O.C.) Tel:+886-3-3226-888 Fax:+886-3-3226-881 Address: No.68-1, Shihbachongsi, Shihding Township, New Taipei City 223, Taiwan, R.O.C. Tel: +886-2-2663-8582
	FCC	TW1079, TW1061,390316, 228391, 641184
	IC	4934E-1, 4934E-2
	VCCI	T-2205 for Telecommunication Test C-4663 for Conducted emission test R-3428, R-4218 for Radiated emission test G-812, G-813 for radiated disturbance above 1GHz
<input checked="" type="checkbox"/>	Test Site	CerpPASS Technology (Suzhou) Co.,Ltd Address: No.66,Tangzhuang Road, Suzhou Industrial Park, Jiangsu 215006, China Tel: +86-512-6917-5888 Fax: +86-512-6917-5666
	FCC	916572, 331395
	IC	7290A-1, 7290A-2
	VCCI	T-343 for Telecommunication Test C-2919 for Conducted emission test R-2670 for Radiated emission test G-227 for radiated disturbance above 1GHz
Frequency Range Investigated:		Conducted: from 150kHz to 30 MHz Radiation: from 30 MHz to 25000MHz
Test Distance:		The test distance of radiated emission from antenna to EUT is 3 M.



2.6 Measurement Uncertainty

Measurement Item	Measurement Frequency	Polarization	Uncertainty
Conducted Emission	9 kHz ~ 30 MHz	LINE/NEUTRAL	± 2.71 dB
Radiated Emission	9 kHz ~ 30 MHz	Vertical	± 3.65 dB
		Horizontal	± 3.89 dB
Radiated Emission	30 MHz ~ 25GHz	Vertical	± 4.11 dB
		Horizontal	± 4.10 dB
Occupied Bandwidth	---	---	± 7500 Hz
Maximum Peak Output Power	---	---	± 1.4 dB
Power Spectral Density	---	---	± 2.2 dB



2.7 Duty cycle

Test Item	Duty cycle
Test Date	May 11, 2017

Mode	Frequency (MHz)	Measurement (%)
802.11b	2412	96.90
802.11g	2412	84.33
802.11n(20MHz)	2412	82.91
802.11n(40MHz)	2412	77.10

Transmit at channel 1 by 802.11b

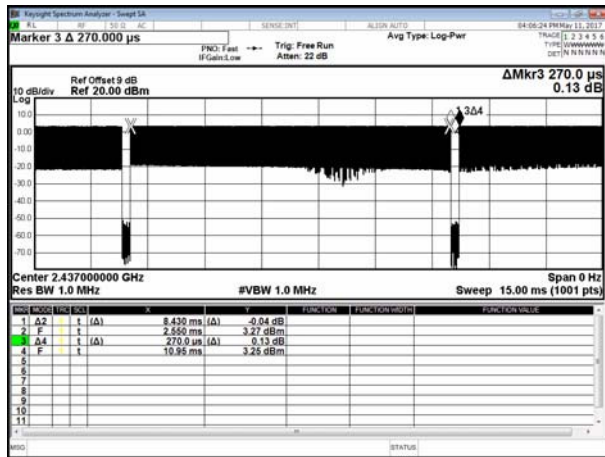

Transmit at channel 1 by 802.11g

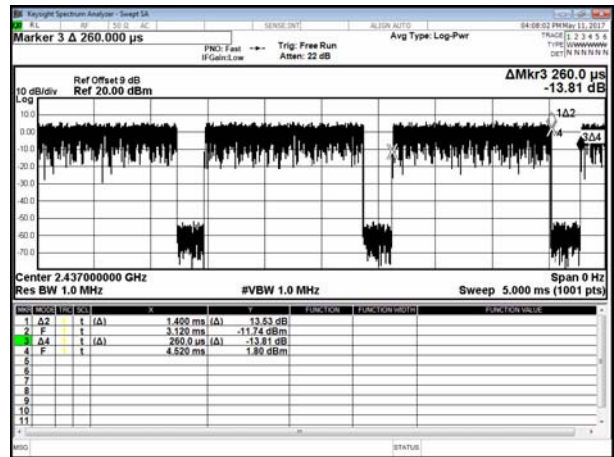

Transmit at channel 1 by 802.11n(20MHz)

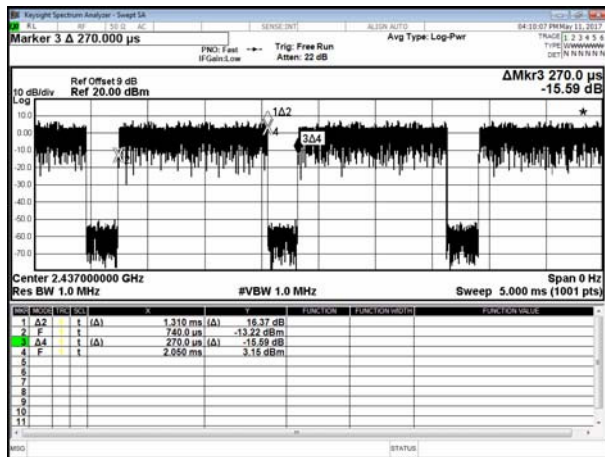

Transmit at channel 1 by 802.11n(20MHz)

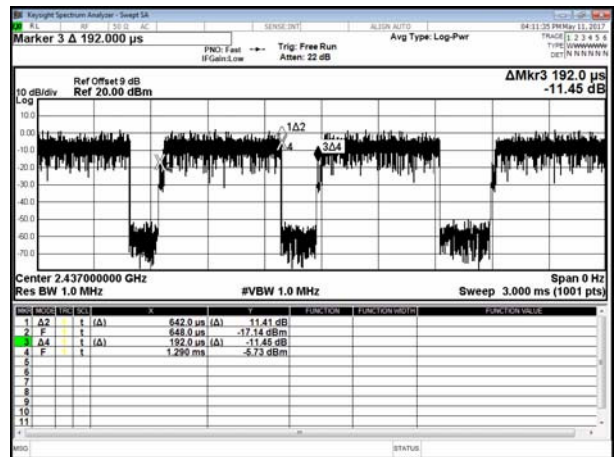



3. Test Equipment and Ancillaries Used for Tests

Instrument	Manufacturer	Model No.	Serial No.	Calibration Date	Valid Date
Test Receiver	R&S	ESCI	100564	2017.02.14	2018.02.13
LISN	SCHWARZBECK	NSLK 8127	8127748	2017.02.14	2018.02.13
LISN	SCHWARZBECK	NSLK 8127	8127749	2017.02.14	2018.02.13
Pulse Limiter with 10dB Attenuation	SCHWARZBECK	VTSD 9561-F	9561-F106	2017.02.14	2018.02.13
Temperature/ Humidity Meter	mingle	ETH529	N/A	2017.02.14	2018.02.13
AMPLIFIER	HP	8447F	3113A05915	2017.02.14	2018.02.13
Loop Antenna	R&S	HFH2-Z2	100150	2016.04.16	2017.04.15
BILOG Antenna	SCHAFFNER	CBL6112D	22241	2017.02.14	2018.02.13
Horn Antenna	Sunol	DRH-118	A072913	2016.10.12	2017.10.11
Broad-Band Horn Antenna	Schwarzbeck	BBHA9170	9170-347	2016.04.16	2017.04.15
Preamplifier	COM-POWER	PA-840	711885	2017.02.14	2018.02.13
Temp&Humidity&barometer	mingle	ETH529	N/A	2017.02.14	2018.02.13
Preamplifier	Field	AFS44-0010180 0-25- 10P-44	1579008	2016.09.30	2017.09.29
ESG VECTOR SIGNAL GENERATOR	Agilent	E4438C	MY4509258 2	2016.06.06	2017.06.05
MXG VECTOR SIGNAL GENERATOR	Agilent	N5182B	MY5305012 7	2016.06.06	2017.06.05
EXA Signal Analyzer	Agilent	N9020A	US46220290	2016.06.06	2017.06.05
Power sensor	e-channel	ERS-180T-24	TW5451026	2016.06.25	2017.06.24
Series Power Meter	ANRITSU	ML24958A	1224005	2017.02.14	2018.02.13



4. Antenna Requirements

4.1 Standard Applicable

For intentional device, according to FCC 47 CFR Section 15.203, an intentional radiator shall be designed to ensure that no antenna other than that furnished by the responsible party shall be used with the device.

And according to FCC 47 CFR Section 15.247 (b), if transmitting antennas of directional gain greater than 6dBi are used, the power shall be reduced by the amount in dB that the directional gain of the antenna exceeds 6dBi.

4.2 Antenna Construction and Directional Gain

No.	Antenna Type	Antenna Gain
1	Dipole Antenna	2dBi



5. Test of AC Power Line Conducted Emission

5.1 Test Limit

Conducted Emissions were measured from 150 kHz to 30 MHz with a bandwidth of 9 KHz on the 120 VAC power and return leads of the EUT according to the methods defined in ANSI C63.10-2013. The EUT was placed on a nonmetallic stand in a shielded room 0.8 meters above the ground plane as shown in section 6.2.2. The interface cables and equipment positioning were varied within limits of reasonable applications to determine the position produced maximum conducted emissions.

Frequency (MHz)	Quasi Peak (dB μ V)	Average (dB μ V)
0.15 – 0.5	66-56*	56-46*
0.5 – 5.0	56	46
5.0 – 30.0	60	50

*Decreases with the logarithm of the frequency.

5.2 Test Procedures

The EUT was setup according to ANSI C63.10, 2013 and tested according to DTS test procedure of Oct 2014 KDB558074 for compliance to FCC 47CFR 15.247 requirements. The EUT was placed on a platform of nominal size, 1 m by 1.5 m, raised 80 cm above the conducting ground plane. The vertical conducting plane was located 40 cm to the rear of the EUT. All other surfaces of EUT were at least 80 cm from any other grounded conducting surface. The EUT and simulators are connected to the main power through a line impedance stabilization network (LISN). The LISN provides a 50 ohm /50uH coupling impedance for the measuring equipment. The peripheral devices are also connected to the main power through a LISN. (Please refer to the block diagram of the test setup and photographs) Each current-carrying conductor of the EUT power cord, except the ground (safety) conductor, was individually connected through a LISN to the input power source. The excess length of the power cord between the EUT and the LISN receptacle were folded back and forth at the center of the lead to form a bundle not exceeding 40 cm in length. Conducted emissions were investigated over the frequency range from 0.15MHz to 30MHz using a receiver bandwidth of 9kHz.

5.3 Typical Test Setup

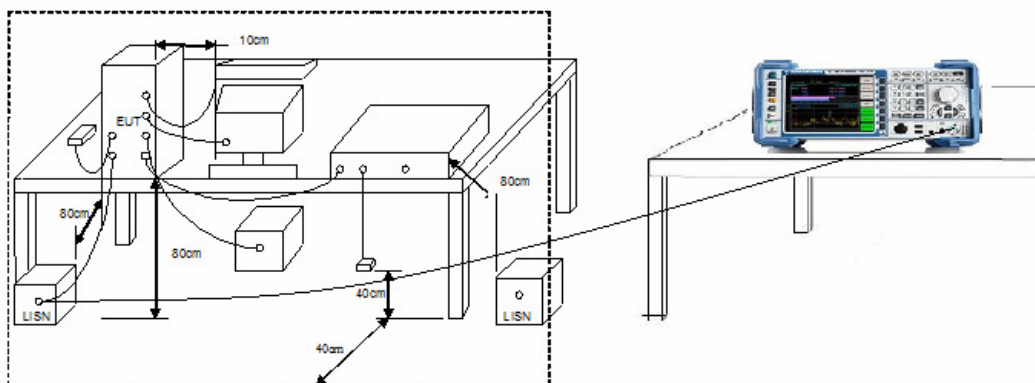



5.4 Test Result and Data

Test Mode :	Normal Link	Phase :	Line
Temperature :	20°C	Humidity:	51%
Pressur(mbar) :	1002	Date:	May 09, 2017

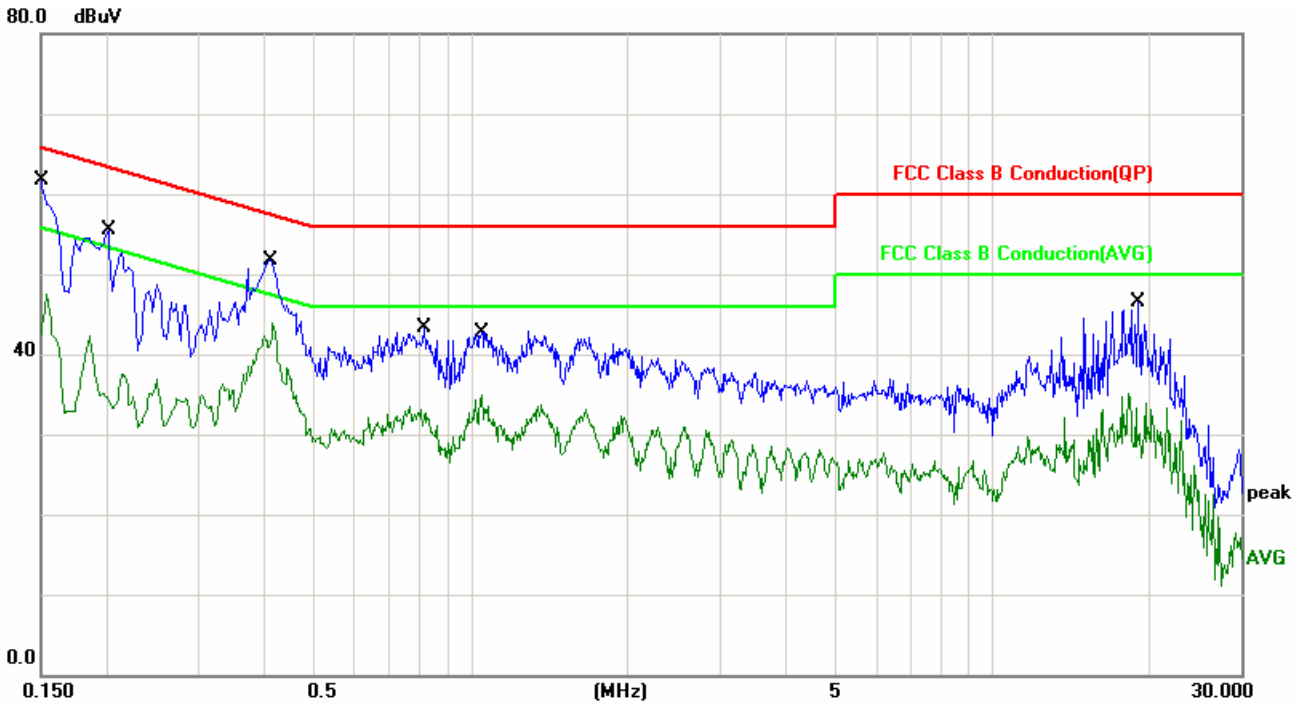

No.	Frequency (MHz)	Factor (dB)	Reading (dBuV)	Level (dBuV)	Limit (dBuV)	Margin (dB)	Detector
1	0.1500	10.06	46.79	56.85	65.99	-9.14	QP
2	0.1500	10.06	32.22	42.28	55.99	-13.71	AVG
3	0.2020	10.06	30.26	40.32	63.52	-23.20	QP
4	0.2020	10.06	21.62	31.68	53.52	-21.84	AVG
5	0.4140	9.94	39.66	49.60	57.57	-7.97	QP
6	0.4140	9.94	31.74	41.68	47.57	-5.89	AVG
7	0.8139	10.09	29.08	39.17	56.00	-16.83	QP
8	0.8139	10.09	22.01	32.10	46.00	-13.90	AVG
9	1.0500	10.18	29.59	39.77	56.00	-16.23	QP
10	1.0500	10.18	23.32	33.50	46.00	-12.50	AVG
11	19.0980	10.53	23.92	34.45	60.00	-25.55	QP
12	19.0980	10.53	19.26	29.79	50.00	-20.21	AVG

Note: Measurement Level = Reading Level + Correct Factor+ Attenuator



Test Mode :	Normal Link	Phase :	Neutral
Temperature :	20°C	Humidity :	51%
Pressur(mbar) :	1002	Date :	May 09, 2017

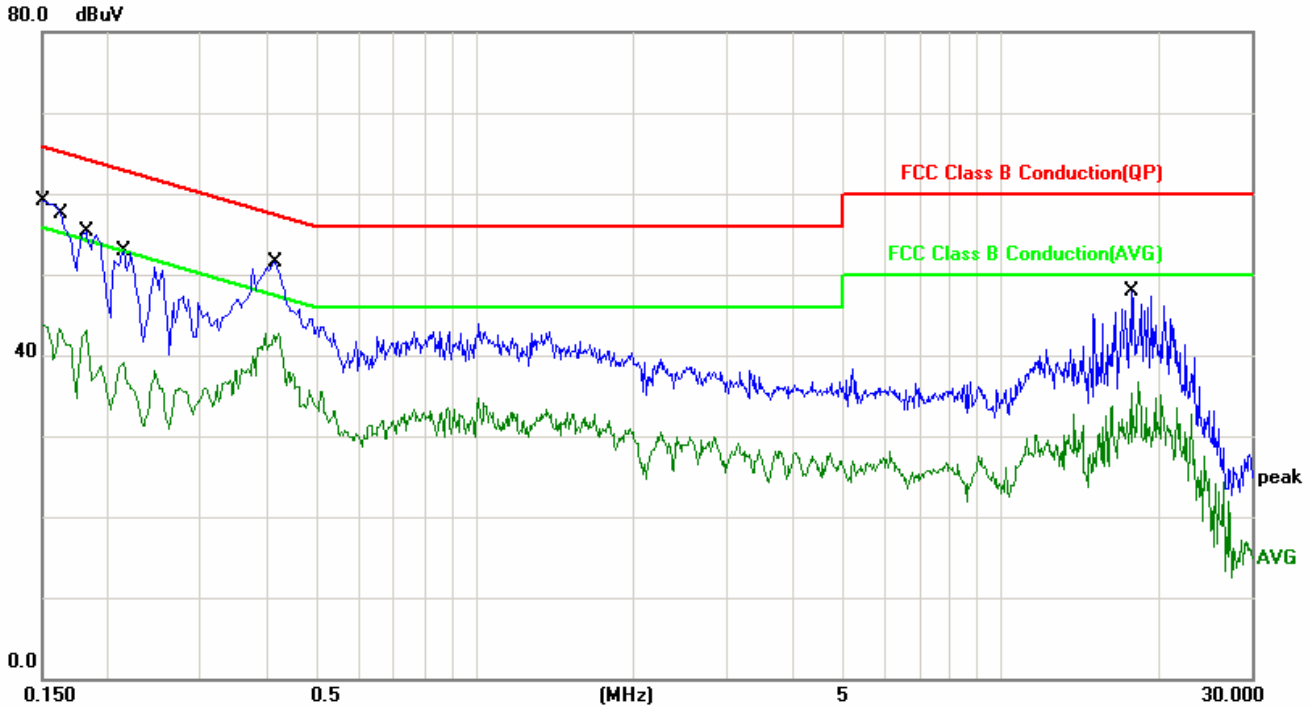

No.	Frequency (MHz)	Factor (dB)	Reading (dBuV)	Level (dBuV)	Limit (dBuV)	Margin (dB)	Detector
1	0.1500	10.06	47.26	57.32	65.99	-8.67	QP
2	0.1500	10.06	32.74	42.80	55.99	-13.19	AVG
3	0.1641	10.06	38.86	48.92	65.25	-16.33	QP
4	0.1641	10.06	24.93	34.99	55.25	-20.26	AVG
5	0.1819	10.06	42.25	52.31	64.39	-12.08	QP
6	0.1819	10.06	29.52	39.58	54.39	-14.81	AVG
7	0.2140	10.05	38.79	48.84	63.04	-14.20	QP
8	0.2140	10.05	26.82	36.87	53.04	-16.17	AVG
9	0.4180	9.94	39.57	49.51	57.49	-7.98	QP
10	0.4180	9.94	31.81	41.75	47.49	-5.74	AVG
11	17.8020	10.47	23.80	34.27	60.00	-25.73	QP
12	17.8020	10.47	17.70	28.17	50.00	-21.83	AVG

Note: Measurement Level = Reading Level + Correct Factor+ Attenuator



6. Test of Spurious Emission (Radiated)

6.1 Test Limit

In any 100kHz bandwidth outside the frequency band in which the spread spectrum or digitally modulated intentional radiator is operating, the radio frequency power that is produced by the intentional radiator shall be at least 20dB below that in the 100kHz bandwidth within the band that contains the highest level of the desired power, based on either an RF conducted or a radiated measurement. If the transmitter measurement is based on the maximum conducted output power, the attenuation required under this paragraph shall be 30dB instead of 20dB. In addition, radiated emissions which fall in section 15.205(a) the restricted bands must also comply with the radiated emission limit specified in section 15.209(a).

FREQUENCIES(MHz)	FIELD STRENGTH (microvolts/meter)	MEASUREMENT DISTANCE(meters)
0.009~0.490	2400/F(kHz)	300
0.490~1.705	24000/F(kHz)	30
1.705~30.0	30	30
30~88	100	3
88~216	150	3
216~960	200	3
Above 960	500	3

6.2 Test Procedures

- The EUT was placed on a rotatable table top 0.8 meter for frequency below 1GHz and 1.5meter for frequency above 1GHz above ground.
- The EUT was set 3 meters from the interference receiving antenna which was mounted on the top of a variable height antenna tower.
- The table was rotated 360 degrees to determine the position of the highest radiation.
- The antenna is a broadband antenna and its height is varied between one meter and four meters above ground to find the maximum value of the field strength both horizontal polarization and vertical polarization of the antenna are set to make the measurement.
- For each suspected emission the EUT was arranged to its worst case and then tune the antenna tower (from 1 M to 4 M) and turn table (from 0 degree to 360 degrees) to find the maximum reading.
- Set the test-receiver system to Peak or CISPR quasi-peak Detect Function and specified bandwidth with Maximum Hold Mode.
- If the emission level of the EUT in peak mode was 3 dB lower than the limit specified, then testing will be stopped and peak values of EUT will be reported, otherwise, the emissions which do not have 3 dB margin will be repeated one by one using the quasi-peak method and reported.
- For testing above 1GHz, the emission level of the EUT in peak mode was 20dB lower than AVG limit (that means the emission level in peak mode also complies with the limit in AVG mode), then testing will be stopped and peak values of EUT will be reported, otherwise, the emissions will be measured in AVG mode again and reported.

6.3 Typical Test Setup

Below 30MHz Test Setup

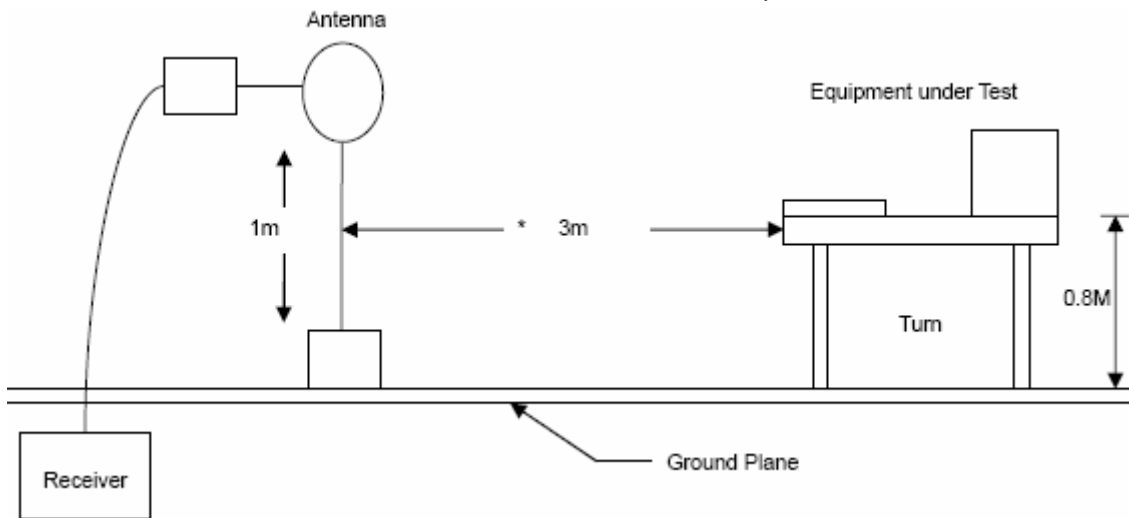

30M - 1GHz Test Setup

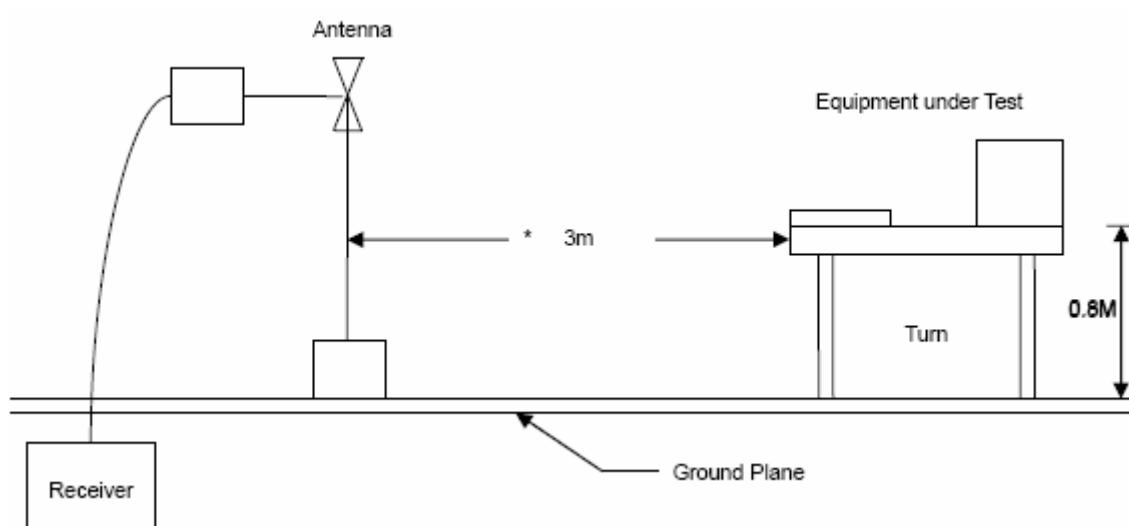

Above 1GHz Test Setup

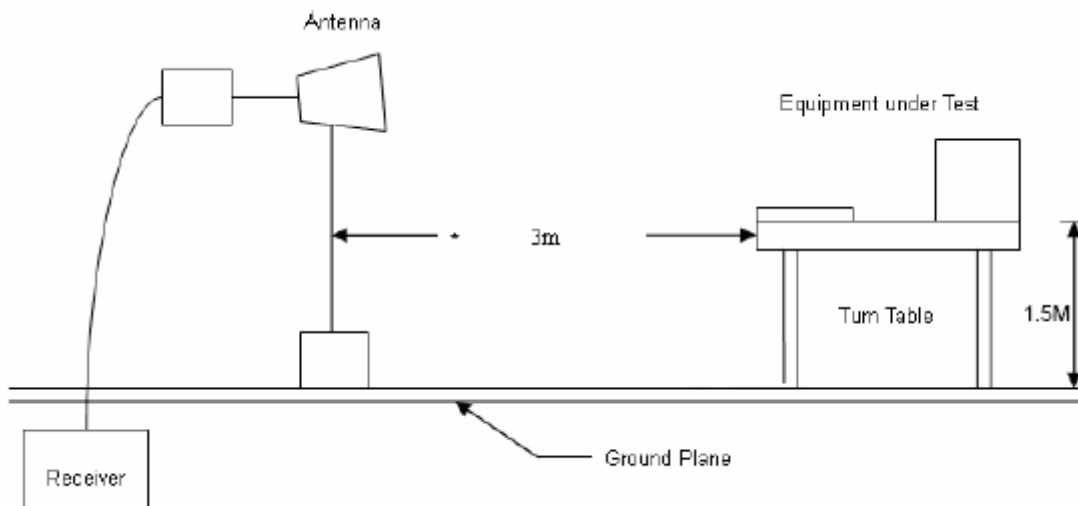

**6.4 Test Result and Data (9KHz ~ 30MHz)**

The 9kHz-30MHz spurious emission is under limit 20dB more.

6.5 Test Result and Data (30MHz ~ 1GHz)

Power	: AC 120V	Temperature	: 24 °C
Test Mode	: Normal Link	Humidity	: 54 %
Test date	: May 07, 2017	Atmospheric Pressure	: 1010 hpa

Frequency (MHz)	AntPol. H/V	Correct Factor (dB)	Reading level (dBuV)	Measure Level (dBuV/m)	Limit 3m (dBuV/m)	Safe Margin (dB)	Detector mode (PK/QP)
123.1200	H	-8.27	41.20	32.93	43.50	-10.57	QP
225.9399	H	-9.56	49.95	40.39	46.00	-5.61	QP
353.9800	H	-4.30	40.02	35.72	46.00	-10.28	QP
468.4399	H	-1.73	36.74	35.01	46.00	-10.99	QP
575.1399	H	-2.93	39.23	36.30	46.00	-9.70	QP
959.2599	H	3.20	35.10	38.30	46.00	-7.70	QP
43.5799	V	-11.77	45.56	33.79	40.00	-6.21	QP
71.7099	V	-14.83	48.30	33.47	40.00	-6.53	QP
153.1899	V	-11.36	44.28	32.92	43.50	-10.58	QP
228.8499	V	-9.55	43.56	34.01	46.00	-11.99	QP
346.2200	V	-4.26	38.06	33.80	46.00	-12.20	QP
959.2599	V	3.20	38.17	41.37	46.00	-4.63	QP

Note: Level = Reading + Factor

Margin = Level – Limit

Factor= Antenna Factor + Cable Loss - Amplifier Factor

**6.6 Test Result and Data (1GHz ~ 25GHz)**

Power	: AC 120V	Temperature	: 24 °C
Test Mode1	802.11b (2412MHz) Ant1	Humidity	: 54 %
Test date	: May 07, 2017	Atmospheric Pressure	: 1010 hpa

Frequency (MHz)	AntPol. H/V	Correct Factor (dB)	Reading level (dBuV)	Measure Level (dBuV/m)	Limit 3m (dBuV/m)	Safe Margin (dB)	Detector mode (PK/AV)
2785.000	H	-0.67	45.10	44.43	74.00	-29.57	peak
4442.500	H	7.37	36.50	43.87	74.00	-30.13	peak
4825.000	H	8.27	35.46	43.73	74.00	-30.27	peak
5377.500	H	8.92	34.74	43.66	74.00	-30.34	peak
6057.500	H	10.28	35.02	45.30	74.00	-28.70	peak
6822.500	H	11.50	37.64	49.14	74.00	-24.86	peak
2062.500	V	-4.46	44.64	40.18	74.00	-33.82	peak
3762.500	V	4.30	36.13	40.43	74.00	-33.57	peak
4442.500	V	7.37	35.94	43.31	74.00	-30.69	peak
4825.000	V	8.27	53.67	61.94	74.00	-12.06	peak
4825.000	V	8.27	43.21	51.48	54.00	-2.52	AVG
6397.500	V	10.42	36.66	47.08	74.00	-26.92	peak
7247.500	V	13.05	39.96	53.01	74.00	-20.99	peak

Note: Level = Reading + Factor

Margin = Level – Limit

Factor= Antenna Factor + Cable Loss - Amplifier Factor



Power	: AC 120V	Temperature	: 24 °C
Test Mode1	802.11b (2437MHz) Ant1	Humidity	: 54 %
Test date	: May 07, 2017	Atmospheric Pressure	: 1010 hpa

Frequency (MHz)	AntPol. H/V	Correct Factor (dB)	Reading level (dBuV)	Measure Level (dBuV/m)	Limit 3m (dBuV/m)	Safe Margin (dB)	Detector mode (PK/AV)
2742.500	H	-0.96	44.09	43.13	74.00	-30.87	peak
4187.500	H	6.07	36.41	42.48	74.00	-31.52	peak
5080.000	H	8.67	35.84	44.51	74.00	-29.49	peak
5590.000	H	9.24	36.59	45.83	74.00	-28.17	peak
6100.000	H	10.30	36.00	46.30	74.00	-27.70	peak
6695.000	H	11.09	36.63	47.72	74.00	-26.28	peak
2105.000	V	-4.28	47.73	43.45	74.00	-30.55	peak
3890.000	V	4.73	38.29	43.02	74.00	-30.98	peak
4910.000	V	8.43	54.19	62.62	74.00	-11.38	peak
4910.000	V	8.43	43.14	51.57	54.00	-2.43	AVG
5505.000	V	9.03	35.30	44.33	74.00	-29.67	peak
5972.500	V	10.19	35.69	45.88	74.00	-28.12	peak
6950.000	V	11.92	37.99	49.91	74.00	-24.09	peak

Note: Level = Reading + Factor

Margin = Level – Limit

Factor= Antenna Factor + Cable Loss - Amplifier Factor



Power	: AC 120V	Temperature	: 24 °C
Test Mode1	802.11b (2462MHz) Ant1	Humidity	: 54 %
Test date	: May 07, 2017	Atmospheric Pressure	: 1010 hpa

Frequency (MHz)	AntPol. H/V	Correct Factor (dB)	Reading level (dBuV)	Measure Level (dBuV/m)	Limit 3m (dBuV/m)	Safe Margin (dB)	Detector mode (PK/AV)
2742.500	H	-0.96	43.22	42.26	74.00	-31.74	peak
3720.000	H	4.15	35.25	39.40	74.00	-34.60	peak
4655.000	H	7.95	35.88	43.83	74.00	-30.17	peak
5335.000	H	8.88	35.64	44.52	74.00	-29.48	peak
6270.000	H	10.37	36.64	47.01	74.00	-26.99	peak
6865.000	H	11.64	36.49	48.13	74.00	-25.87	peak
2190.000	V	-3.91	47.87	43.96	74.00	-30.04	peak
4017.500	V	5.20	38.06	43.26	74.00	-30.74	peak
4952.500	V	8.51	54.78	63.29	74.00	-10.71	peak
4952.500	V	8.51	43.14	51.65	54.00	-2.35	AVG
6567.500	V	10.68	36.34	47.02	74.00	-26.98	peak
6737.500	V	11.23	39.24	50.47	74.00	-23.53	peak
7247.500	V	13.05	37.22	50.27	74.00	-23.73	peak

Note: Level = Reading + Factor

Margin = Level – Limit

Factor= Antenna Factor + Cable Loss - Amplifier Factor



Power	: AC 120V	Temperature	: 24 °C
Test Mode2	: 802.11g (2412MHz) Ant1	Humidity	: 54 %
Test date	: May 07, 2017	Atmospheric Pressure	: 1010 hpa

Frequency (MHz)	AntPol. H/V	Correct Factor (dB)	Reading level (dBuV)	Measure Level (dBuV/m)	Limit 3m (dBuV/m)	Safe Margin (dB)	Detector mode (PK/AV)
3890.000	H	4.73	37.57	42.30	74.00	-31.70	peak
4230.000	H	6.28	37.20	43.48	74.00	-30.52	peak
4867.500	H	8.35	37.38	45.73	74.00	-28.27	peak
5845.000	H	9.88	34.73	44.61	74.00	-29.39	peak
6397.500	H	10.42	36.47	46.89	74.00	-27.11	peak
6822.500	H	11.50	37.50	49.00	74.00	-25.00	peak
2190.000	V	-3.91	46.15	42.24	74.00	-31.76	peak
4697.500	V	8.03	37.00	45.03	74.00	-28.97	peak
4825.000	V	8.27	54.54	62.81	74.00	-11.19	peak
4825.000	V	8.27	41.33	49.60	54.00	-4.40	AVG
6312.500	V	10.38	36.40	46.78	74.00	-27.22	peak
6865.000	V	11.64	37.74	49.38	74.00	-24.62	peak
7247.500	V	13.05	44.08	57.13	74.00	-16.87	peak
7247.500	V	13.05	31.67	44.72	54.00	-9.28	AVG

Note: Level = Reading + Factor

Margin = Level – Limit

Factor= Antenna Factor + Cable Loss - Amplifier Factor



Power	: AC 120V	Temperature	: 24 °C
Test Mode2	: 802.11g (2437MHz) Ant1	Humidity	: 54 %
Test date	: May 07, 2017	Atmospheric Pressure	: 1010 hpa

Frequency (MHz)	AntPol. H/V	Correct Factor (dB)	Reading level (dBuV)	Measure Level (dBuV/m)	Limit 3m (dBuV/m)	Safe Margin (dB)	Detector mode (PK/AV)
2870.000	H	-0.10	45.08	44.98	74.00	-29.02	peak
4102.500	H	5.63	36.61	42.24	74.00	-31.76	peak
4825.000	H	8.27	35.33	43.60	74.00	-30.40	peak
5377.500	H	8.92	34.37	43.29	74.00	-30.71	peak
6015.000	H	10.27	34.50	44.77	74.00	-29.23	peak
6992.500	H	12.06	36.00	48.06	74.00	-25.94	peak
1892.500	V	-5.35	50.37	45.02	74.00	-28.98	peak
4187.500	V	6.07	39.93	46.00	74.00	-28.00	peak
4910.000	V	8.43	53.62	62.05	74.00	-11.95	peak
4910.000	V	8.43	41.34	49.77	54.00	-4.23	AVG
5760.000	V	9.66	35.58	45.24	74.00	-28.76	peak
6227.500	V	10.35	37.33	47.68	74.00	-26.32	peak
7332.500	V	13.38	45.21	58.59	74.00	-15.41	peak
7332.500	V	13.38	32.17	45.55	54.00	-8.45	AVG

Note: Level = Reading + Factor
Margin = Level – Limit
Factor= Antenna Factor + Cable Loss - Amplifier Factor



Power	: AC 120V	Temperature	: 24 °C
Test Mode2	802.11g (2462MHz) Ant1	Humidity	: 54 %
Test date	: May 07, 2017	Atmospheric Pressure	: 1010 hpa

Frequency (MHz)	AntPol. H/V	Correct Factor (dB)	Reading level (dBuV)	Measure Level (dBuV/m)	Limit 3m (dBuV/m)	Safe Margin (dB)	Detector mode (PK/AV)
2827.500	H	-0.39	44.31	43.92	74.00	-30.08	peak
3975.000	H	5.02	36.45	41.47	74.00	-32.53	peak
4442.500	H	7.37	36.09	43.46	74.00	-30.54	peak
5547.500	H	9.14	32.95	42.09	74.00	-31.91	peak
6397.500	H	10.42	35.89	46.31	74.00	-27.69	peak
7120.000	H	12.55	34.98	47.53	74.00	-26.47	peak
1892.500	V	-5.35	51.59	46.24	74.00	-27.76	peak
4272.500	V	6.50	35.81	42.31	74.00	-31.69	peak
4612.500	V	7.87	36.25	44.12	74.00	-29.88	peak
4952.500	V	8.51	53.35	61.86	74.00	-12.14	peak
4952.500	V	8.51	41.21	49.72	54.00	-4.28	AVG
6865.000	V	11.64	38.51	50.15	74.00	-23.85	peak
7417.500	V	13.71	42.74	56.45	74.00	-17.55	peak
7417.500	V	13.71	29.87	43.58	54.00	-10.42	AVG

Note: Level = Reading + Factor

Margin = Level – Limit

Factor= Antenna Factor + Cable Loss - Amplifier Factor



Power	: AC 120V	Temperature	: 24 °C
Test Mode3	802.11n HT20 (2412MHz) Ant1	Humidity	: 54 %
Test date	: May 07, 2017	Atmospheric Pressure	: 1010 hpa

Frequency (MHz)	AntPol. H/V	Correct Factor (dB)	Reading level (dBuV)	Measure Level (dBuV/m)	Limit 3m (dBuV/m)	Safe Margin (dB)	Detector mode (PK/AV)
3507.500	H	3.43	36.93	40.36	74.00	-33.64	peak
4145.000	H	5.85	35.38	41.23	74.00	-32.77	peak
4655.000	H	7.95	35.53	43.48	74.00	-30.52	peak
4952.500	H	8.51	34.97	43.48	74.00	-30.52	peak
5930.000	H	10.09	36.45	46.54	74.00	-27.46	peak
6907.500	H	11.78	36.08	47.86	74.00	-26.14	peak
2062.500	V	-4.46	47.45	42.99	74.00	-31.01	peak
4867.500	V	8.35	54.50	62.85	74.00	-11.15	peak
4867.500	V	8.35	41.12	49.47	54.00	-4.53	AVG
5845.000	V	9.88	35.01	44.89	74.00	-29.11	peak
6355.000	V	10.40	36.30	46.70	74.00	-27.30	peak
6822.500	V	11.50	37.13	48.63	74.00	-25.37	peak
7247.500	V	13.05	45.56	58.61	74.00	-15.39	peak
7247.500	V	13.05	31.64	44.69	54.00	-9.31	AVG

Note: Level = Reading + Factor

Margin = Level – Limit

Factor= Antenna Factor + Cable Loss - Amplifier Factor



Power	: AC 120V	Temperature	: 24 °C
Test Mode3	802.11n HT20 (2437MHz) Ant1	Humidity	: 54 %
Test date	: May 07, 2017	Atmospheric Pressure	: 1010 hpa

Frequency (MHz)	AntPol. H/V	Correct Factor (dB)	Reading level (dBuV)	Measure Level (dBuV/m)	Limit 3m (dBuV/m)	Safe Margin (dB)	Detector mode (PK/AV)
2742.500	H	-0.96	42.93	41.97	74.00	-32.03	peak
3592.500	H	3.72	36.37	40.09	74.00	-33.91	peak
4400.000	H	7.15	35.30	42.45	74.00	-31.55	peak
5505.000	H	9.03	35.95	44.98	74.00	-29.02	peak
6440.000	H	10.44	33.67	44.11	74.00	-29.89	peak
6907.500	H	11.78	35.92	47.70	74.00	-26.30	peak
2232.500	V	-3.73	45.59	41.86	74.00	-32.14	peak
3465.000	V	3.22	37.88	41.10	74.00	-32.90	peak
4655.000	V	7.95	35.90	43.85	74.00	-30.15	peak
4910.000	V	8.43	51.93	60.36	74.00	-13.64	peak
4910.000	V	8.43	38.12	46.55	54.00	-7.45	AVG
5930.000	V	10.09	36.36	46.45	74.00	-27.55	peak
6907.500	V	11.78	36.97	48.75	74.00	-25.25	peak

Note: Level = Reading + Factor

Margin = Level – Limit

Factor= Antenna Factor + Cable Loss - Amplifier Factor



Power	: AC 120V	Temperature	: 24 °C
Test Mode3	802.11n HT20 (2462MHz) Ant1	Humidity	: 54 %
Test date	: May 07, 2017	Atmospheric Pressure	: 1010 hpa

Frequency (MHz)	AntPol. H/V	Correct Factor (dB)	Reading level (dBuV)	Measure Level (dBuV/m)	Limit 3m (dBuV/m)	Safe Margin (dB)	Detector mode (PK/AV)
3380.000	H	2.77	35.92	38.69	74.00	-35.31	peak
4272.500	H	6.50	35.11	41.61	74.00	-32.39	peak
5165.000	H	8.74	34.49	43.23	74.00	-30.77	peak
5887.500	H	9.98	34.18	44.16	74.00	-29.84	peak
6482.500	H	10.45	35.64	46.09	74.00	-27.91	peak
7162.500	H	12.71	36.29	49.00	74.00	-25.00	peak
1595.000	V	-7.06	52.00	44.94	74.00	-29.06	peak
4485.000	V	7.58	35.52	43.10	74.00	-30.90	peak
4952.500	V	8.51	53.37	61.88	74.00	-12.12	peak
4952.500	V	8.51	40.32	48.83	54.00	-5.17	AVG
6312.500	V	10.38	35.67	46.05	74.00	-27.95	peak
7035.000	V	12.22	36.61	48.83	74.00	-25.17	peak
7417.500	V	13.71	43.70	57.41	74.00	-16.59	peak
7417.500	V	13.71	31.04	44.75	54.00	-9.25	AVG

Note: Level = Reading + Factor

Margin = Level – Limit

Factor= Antenna Factor + Cable Loss - Amplifier Factor



Power	: AC 120V	Temperature	: 24 °C
Test Mode4	802.11n HT40 (2422MHz) Ant1	Humidity	: 54 %
Test date	: May 07, 2017	Atmospheric Pressure	: 1010 hpa

Frequency (MHz)	AntPol. H/V	Correct Factor (dB)	Reading level (dBuV)	Measure Level (dBuV/m)	Limit 3m (dBuV/m)	Safe Margin (dB)	Detector mode (PK/AV)
2827.500	H	-0.39	43.50	43.11	74.00	-30.89	peak
4272.500	H	6.50	36.70	43.20	74.00	-30.80	peak
5165.000	H	8.74	34.11	42.85	74.00	-31.15	peak
5845.000	H	9.88	34.21	44.09	74.00	-29.91	peak
6567.500	H	10.68	35.14	45.82	74.00	-28.18	peak
6950.000	H	11.92	35.15	47.07	74.00	-26.93	peak
2062.500	V	-4.46	49.05	44.59	74.00	-29.41	peak
4272.500	V	6.50	37.68	44.18	74.00	-29.82	peak
4867.500	V	8.35	53.95	62.30	74.00	-11.70	peak
4867.500	V	8.35	40.52	48.87	54.00	-5.13	AVG
5547.500	V	9.14	36.14	45.28	74.00	-28.72	peak
6142.500	V	10.32	36.92	47.24	74.00	-26.76	peak
7290.000	V	13.21	45.83	59.04	74.00	-14.96	peak
7290.000	V	13.21	32.51	45.72	54.00	-8.28	AVG

Note: Level = Reading + Factor

Margin = Level – Limit

Factor= Antenna Factor + Cable Loss - Amplifier Factor



Power	: AC 120V	Temperature	: 24 °C
Test Mode4	802.11n HT40 (2437MHz) Ant1	Humidity	: 54 %
Test date	: May 07, 2017	Atmospheric Pressure	: 1010 hpa

Frequency (MHz)	AntPol. H/V	Correct Factor (dB)	Reading level (dBuV)	Measure Level (dBuV/m)	Limit 3m (dBuV/m)	Safe Margin (dB)	Detector mode (PK/AV)
2785.000	H	-0.67	43.59	42.92	74.00	-31.08	peak
3550.000	H	3.57	35.94	39.51	74.00	-34.49	peak
4272.500	H	6.50	34.60	41.10	74.00	-32.90	peak
5335.000	H	8.88	35.97	44.85	74.00	-29.15	peak
5972.500	H	10.19	35.68	45.87	74.00	-28.13	peak
6695.000	H	11.09	37.13	48.22	74.00	-25.78	peak
2870.000	V	-0.10	46.36	46.26	74.00	-27.74	peak
4357.500	V	6.93	36.65	43.58	74.00	-30.42	peak
4910.000	V	8.43	53.70	62.13	74.00	-11.87	peak
4910.000	V	8.43	41.12	49.55	54.00	-4.45	AVG
5590.000	V	9.24	36.31	45.55	74.00	-28.45	peak
6907.500	V	11.78	37.31	49.09	74.00	-24.91	peak
7332.500	V	13.38	43.60	56.98	74.00	-17.02	peak
7332.500	V	13.38	31.06	44.44	54.00	-9.56	AVG

Note: Level = Reading + Factor

Margin = Level – Limit

Factor= Antenna Factor + Cable Loss - Amplifier Factor



Power	: AC 120V	Temperature	: 24 °C
Test Mode4	802.11n HT40 (2452MHz) Ant1	Humidity	: 54 %
Test date	: May 07, 2017	Atmospheric Pressure	: 1010 hpa

Frequency (MHz)	AntPol. H/V	Correct Factor (dB)	Reading level (dBuV)	Measure Level (dBuV/m)	Limit 3m (dBuV/m)	Safe Margin (dB)	Detector mode (PK/AV)
2785.000	H	-0.67	43.52	42.85	74.00	-31.15	peak
3507.500	H	3.43	36.11	39.54	74.00	-34.46	peak
4655.000	H	7.95	35.51	43.46	74.00	-30.54	peak
5335.000	H	8.88	34.37	43.25	74.00	-30.75	peak
6270.000	H	10.37	35.22	45.59	74.00	-28.41	peak
7077.500	H	12.38	34.56	46.94	74.00	-27.06	peak
2700.000	V	-1.24	45.07	43.83	74.00	-30.17	peak
3975.000	V	5.02	34.91	39.93	74.00	-34.07	peak
4952.500	V	8.51	54.82	63.33	74.00	-10.67	peak
4952.500	V	8.51	41.37	49.88	54.00	-4.12	AVG
6185.000	V	10.33	34.78	45.11	74.00	-28.89	peak
6992.500	V	12.06	36.68	48.74	74.00	-25.26	peak
7375.000	V	13.54	44.78	58.32	74.00	-15.68	peak
7375.000	V	13.54	32.25	45.79	54.00	-8.21	AVG

Note: Level = Reading + Factor

Margin = Level – Limit

Factor= Antenna Factor + Cable Loss - Amplifier Factor



Power	: AC 120V	Temperature	: 24 °C
Test Mode5	802.11b (2412MHz) Ant2	Humidity	: 54 %
Test date	: May 07, 2017	Atmospheric Pressure	: 1010 hpa

Frequency (MHz)	AntPol. H/V	Correct Factor (dB)	Reading level (dBuV)	Measure Level (dBuV/m)	Limit 3m (dBuV/m)	Safe Margin (dB)	Detector mode (PK/AV)
2147.500	H	-4.10	43.94	39.84	74.00	-34.16	peak
3720.000	H	4.15	36.99	41.14	74.00	-32.86	peak
4867.500	H	8.35	34.66	43.01	74.00	-30.99	peak
5207.500	H	8.77	33.97	42.74	74.00	-31.26	peak
5972.500	H	10.19	34.71	44.90	74.00	-29.10	peak
6695.000	H	11.09	35.23	46.32	74.00	-27.68	peak
2147.500	V	-4.10	47.98	43.88	74.00	-30.12	peak
2955.000	V	0.47	45.87	46.34	74.00	-27.66	peak
4825.000	V	8.27	53.67	61.94	74.00	-12.06	peak
4825.000	V	8.27	42.36	50.63	54.00	-3.37	AVG
5420.000	V	8.95	36.00	44.95	74.00	-29.05	peak
6185.000	V	10.33	35.80	46.13	74.00	-27.87	peak
6780.000	V	11.37	38.52	49.89	74.00	-24.11	peak

Note: Level = Reading + Factor

Margin = Level – Limit

Factor= Antenna Factor + Cable Loss - Amplifier Factor



Power	: AC 120V	Temperature	: 24 °C
Test Mode5	802.11b (2437MHz) Ant2	Humidity	: 54 %
Test date	: May 07, 2017	Atmospheric Pressure	: 1010 hpa

Frequency (MHz)	AntPol. H/V	Correct Factor (dB)	Reading level (dBuV)	Measure Level (dBuV/m)	Limit 3m (dBuV/m)	Safe Margin (dB)	Detector mode (PK/AV)
2657.500	H	-1.52	42.71	41.19	74.00	-32.81	peak
4060.000	H	5.42	36.29	41.71	74.00	-32.29	peak
4952.500	H	8.51	35.39	43.90	74.00	-30.10	peak
5335.000	H	8.88	36.25	45.13	74.00	-28.87	peak
6397.500	H	10.42	35.25	45.67	74.00	-28.33	peak
6822.500	H	11.50	35.90	47.40	74.00	-26.60	peak
2275.000	V	-3.55	47.42	43.87	74.00	-30.13	peak
4442.500	V	7.37	35.96	43.33	74.00	-30.67	peak
4910.000	V	8.43	53.83	62.26	74.00	-11.74	peak
4910.000	V	8.43	40.21	48.64	54.00	-5.36	AVG
5845.000	V	9.88	35.70	45.58	74.00	-28.42	peak
6227.500	V	10.35	37.51	47.86	74.00	-26.14	peak
6865.000	V	11.64	37.44	49.08	74.00	-24.92	peak

Note: Level = Reading + Factor

Margin = Level – Limit

Factor= Antenna Factor + Cable Loss - Amplifier Factor



Power	: AC 120V	Temperature	: 24 °C
Test Mode5	802.11b (2462MHz) Ant2	Humidity	: 54 %
Test date	: May 07, 2017	Atmospheric Pressure	: 1010 hpa

Frequency (MHz)	AntPol. H/V	Correct Factor (dB)	Reading level (dBuV)	Measure Level (dBuV/m)	Limit 3m (dBuV/m)	Safe Margin (dB)	Detector mode (PK/AV)
2190.000	H	-3.91	43.61	39.70	74.00	-34.30	peak
3762.500	H	4.30	35.39	39.69	74.00	-34.31	peak
4442.500	H	7.37	35.25	42.62	74.00	-31.38	peak
5760.000	H	9.66	34.47	44.13	74.00	-29.87	peak
6270.000	H	10.37	37.63	48.00	74.00	-26.00	peak
6822.500	H	11.50	36.12	47.62	74.00	-26.38	peak
2020.000	V	-4.64	49.69	45.05	74.00	-28.95	peak
4145.000	V	5.85	35.47	41.32	74.00	-32.68	peak
4952.500	V	8.51	52.83	61.34	74.00	-12.66	peak
4952.500	V	8.51	39.45	47.96	54.00	-6.04	AVG
5717.500	V	9.56	35.68	45.24	74.00	-28.76	peak
6227.500	V	10.35	36.27	46.62	74.00	-27.38	peak
7077.500	V	12.38	37.07	49.45	74.00	-24.55	peak

Note: Level = Reading + Factor

Margin = Level – Limit

Factor= Antenna Factor + Cable Loss - Amplifier Factor



Power	: AC 120V	Temperature	: 24 °C
Test Mode	6 802.11g (2412MHz) Ant2	Humidity	: 54 %
Test date	: May 07, 2017	Atmospheric Pressure	: 1010 hpa

Frequency (MHz)	AntPol. H/V	Correct Factor (dB)	Reading level (dBuV)	Measure Level (dBuV/m)	Limit 3m (dBuV/m)	Safe Margin (dB)	Detector mode (PK/AV)
2062.500	H	-4.46	44.97	40.51	74.00	-33.49	peak
3677.500	H	4.01	37.20	41.21	74.00	-32.79	peak
4272.500	H	6.50	37.83	44.33	74.00	-29.67	peak
5675.000	H	9.45	34.94	44.39	74.00	-29.61	peak
6865.000	H	11.64	35.67	47.31	74.00	-26.69	peak
7375.000	H	13.54	34.47	48.01	74.00	-25.99	peak
2020.000	V	-4.64	49.82	45.18	74.00	-28.82	peak
4825.000	V	8.27	52.63	60.90	74.00	-13.10	peak
4825.000	V	8.27	39.87	48.14	54.00	-5.86	AVG
5037.500	V	8.63	37.11	45.74	74.00	-28.26	peak
5760.000	V	9.66	35.95	45.61	74.00	-28.39	peak
6270.000	V	10.37	36.40	46.77	74.00	-27.23	peak
6865.000	V	11.64	37.15	48.79	74.00	-25.21	peak

Note: Level = Reading + Factor

Margin = Level – Limit

Factor= Antenna Factor + Cable Loss - Amplifier Factor



Power	: AC 120V	Temperature	: 24 °C
Test Mode	6 802.11g (2437MHz) Ant2	Humidity	: 54 %
Test date	: May 07, 2017	Atmospheric Pressure	: 1010 hpa

Frequency (MHz)	AntPol. H/V	Correct Factor (dB)	Reading level (dBuV)	Measure Level (dBuV/m)	Limit 3m (dBuV/m)	Safe Margin (dB)	Detector mode (PK/AV)
2062.500	H	-4.46	46.93	42.47	74.00	-31.53	peak
4442.500	H	7.37	37.49	44.86	74.00	-29.14	peak
4910.000	H	8.43	37.09	45.52	74.00	-28.48	peak
5335.000	H	8.88	35.74	44.62	74.00	-29.38	peak
6270.000	H	10.37	36.45	46.82	74.00	-27.18	peak
6865.000	H	11.64	37.57	49.21	74.00	-24.79	peak
2062.500	V	-4.46	50.18	45.72	74.00	-28.28	peak
2700.000	V	-1.24	45.72	44.48	74.00	-29.52	peak
4272.500	V	6.50	38.72	45.22	74.00	-28.78	peak
4910.000	V	8.43	52.10	60.53	74.00	-13.47	peak
4910.000	V	8.43	39.74	48.17	54.00	-5.83	AVG
6015.000	V	10.27	35.44	45.71	74.00	-28.29	peak
7077.500	V	12.38	37.28	49.66	74.00	-24.34	peak

Note: Level = Reading + Factor

Margin = Level – Limit

Factor= Antenna Factor + Cable Loss - Amplifier Factor



Power	: AC 120V	Temperature	: 24 °C
Test Mode6	802.11g (2462MHz) Ant2	Humidity	: 54 %
Test date	: May 07, 2017	Atmospheric Pressure	: 1010 hpa

Frequency (MHz)	AntPol. H/V	Correct Factor (dB)	Reading level (dBuV)	Measure Level (dBuV/m)	Limit 3m (dBuV/m)	Safe Margin (dB)	Detector mode (PK/AV)
2317.500	H	-3.36	42.28	38.92	74.00	-35.08	peak
3932.500	H	4.88	34.38	39.26	74.00	-34.74	peak
4612.500	H	7.87	34.11	41.98	74.00	-32.02	peak
5335.000	H	8.88	31.62	40.50	74.00	-33.50	peak
6015.000	H	10.27	33.38	43.65	74.00	-30.35	peak
6482.500	H	10.45	33.39	43.84	74.00	-30.16	peak
2105.000	V	-4.28	45.62	41.34	74.00	-32.66	peak
4272.500	V	6.50	36.15	42.65	74.00	-31.35	peak
4952.500	V	8.51	53.03	61.54	74.00	-12.46	peak
4952.500	V	8.51	40.56	49.07	54.00	-4.93	AVG
5930.000	V	10.09	35.76	45.85	74.00	-28.15	peak
6865.000	V	11.64	37.83	49.47	74.00	-24.53	peak
7417.500	V	13.71	43.01	56.72	74.00	-17.28	peak
7417.500	V	13.71	30.42	44.13	54.00	-9.87	AVG

Note: Level = Reading + Factor

Margin = Level – Limit

Factor= Antenna Factor + Cable Loss - Amplifier Factor



Power	: AC 120V	Temperature	: 24 °C
Test Mode7	802.11n HT20 (2412MHz) Ant2	Humidity	: 54 %
Test date	: May 07, 2017	Atmospheric Pressure	: 1010 hpa

Frequency (MHz)	AntPol. H/V	Correct Factor (dB)	Reading level (dBuV)	Measure Level (dBuV/m)	Limit 3m (dBuV/m)	Safe Margin (dB)	Detector mode (PK/AV)
2147.500	H	-4.10	45.01	40.91	74.00	-33.09	peak
2700.000	H	-1.24	45.04	43.80	74.00	-30.20	peak
4017.500	H	5.20	37.07	42.27	74.00	-31.73	peak
4782.500	H	8.19	35.59	43.78	74.00	-30.22	peak
5802.500	H	9.77	34.75	44.52	74.00	-29.48	peak
6780.000	H	11.37	34.52	45.89	74.00	-28.11	peak
2062.500	V	-4.46	45.94	41.48	74.00	-32.52	peak
3592.500	V	3.72	35.29	39.01	74.00	-34.99	peak
4867.500	V	8.35	53.32	61.67	74.00	-12.33	peak
4867.500	V	8.35	40.57	48.92	54.00	-5.08	AVG
5547.500	V	9.14	35.62	44.76	74.00	-29.24	peak
6142.500	V	10.32	35.46	45.78	74.00	-28.22	peak
6865.000	V	11.64	37.71	49.35	74.00	-24.65	peak

Note: Level = Reading + Factor

Margin = Level – Limit

Factor= Antenna Factor + Cable Loss - Amplifier Factor



Power	: AC 120V	Temperature	: 24 °C
Test Mode7	802.11n HT20 (2437MHz) Ant2	Humidity	: 54 %
Test date	: May 07, 2017	Atmospheric Pressure	: 1010 hpa

Frequency (MHz)	AntPol. H/V	Correct Factor (dB)	Reading level (dBuV)	Measure Level (dBuV/m)	Limit 3m (dBuV/m)	Safe Margin (dB)	Detector mode (PK/AV)
2742.500	H	-0.96	43.20	42.24	74.00	-31.76	peak
4612.500	H	7.87	33.96	41.83	74.00	-32.17	peak
5080.000	H	8.67	34.12	42.79	74.00	-31.21	peak
5590.000	H	9.24	33.54	42.78	74.00	-31.22	peak
6312.500	H	10.38	34.59	44.97	74.00	-29.03	peak
6865.000	H	11.64	35.42	47.06	74.00	-26.94	peak
2190.000	V	-3.91	48.21	44.30	74.00	-29.70	peak
4400.000	V	7.15	36.40	43.55	74.00	-30.45	peak
4910.000	V	8.43	52.56	60.99	74.00	-13.01	peak
4910.000	V	8.43	40.03	48.46	54.00	-5.54	AVG
5760.000	V	9.66	36.14	45.80	74.00	-28.20	peak
6185.000	V	10.33	37.15	47.48	74.00	-26.52	peak
7332.500	V	13.38	39.73	53.11	74.00	-20.89	peak

Note: Level = Reading + Factor

Margin = Level – Limit

Factor= Antenna Factor + Cable Loss - Amplifier Factor



Power	: AC 120V	Temperature	: 24 °C
Test Mode7	802.11n HT20 (2462MHz) Ant2	Humidity	: 54 %
Test date	: May 07, 2017	Atmospheric Pressure	: 1010 hpa

Frequency (MHz)	AntPol. H/V	Correct Factor (dB)	Reading level (dBuV)	Measure Level (dBuV/m)	Limit 3m (dBuV/m)	Safe Margin (dB)	Detector mode (PK/AV)
2827.500	H	-0.39	44.87	44.48	74.00	-29.52	peak
4102.500	H	5.63	37.41	43.04	74.00	-30.96	peak
4570.000	H	7.79	36.21	44.00	74.00	-30.00	peak
5335.000	H	8.88	36.69	45.57	74.00	-28.43	peak
6057.500	H	10.28	36.64	46.92	74.00	-27.08	peak
6397.500	H	10.42	35.90	46.32	74.00	-27.68	peak
2020.000	V	-4.64	45.79	41.15	74.00	-32.85	peak
4442.500	V	7.37	36.02	43.39	74.00	-30.61	peak
4952.500	V	8.51	54.10	62.61	74.00	-11.39	peak
4952.500	V	8.51	41.67	50.18	54.00	-3.82	AVG
5845.000	V	9.88	34.99	44.87	74.00	-29.13	peak
6907.500	V	11.78	37.09	48.87	74.00	-25.13	peak
7417.500	V	13.71	41.41	55.12	74.00	-18.88	peak
7417.500	V	13.71	29.21	42.92	54.00	-11.08	AVG

Note: Level = Reading + Factor

Margin = Level – Limit

Factor= Antenna Factor + Cable Loss - Amplifier Factor



Power	: AC 120V	Temperature	: 24 °C
Test Mode8	802.11n HT40 (2422MHz) Ant2	Humidity	: 54 %
Test date	: May 07, 2017	Atmospheric Pressure	: 1010 hpa

Frequency (MHz)	AntPol. H/V	Correct Factor (dB)	Reading level (dBuV)	Measure Level (dBuV/m)	Limit 3m (dBuV/m)	Safe Margin (dB)	Detector mode (PK/AV)
2827.500	H	-0.39	44.56	44.17	74.00	-29.83	peak
3932.500	H	4.88	36.25	41.13	74.00	-32.87	peak
5037.500	H	8.63	35.28	43.91	74.00	-30.09	peak
5250.000	H	8.81	35.48	44.29	74.00	-29.71	peak
6227.500	H	10.35	35.21	45.56	74.00	-28.44	peak
6992.500	H	12.06	37.08	49.14	74.00	-24.86	peak
2020.000	V	-4.64	51.01	46.37	74.00	-27.63	peak
4102.500	V	5.63	35.71	41.34	74.00	-32.66	peak
4867.500	V	8.35	52.79	61.14	74.00	-12.86	peak
4867.500	V	8.35	39.88	48.23	54.00	-5.77	AVG
6185.000	V	10.33	35.89	46.22	74.00	-27.78	peak
6907.500	V	11.78	37.41	49.19	74.00	-24.81	peak
7290.000	V	13.21	43.73	56.94	74.00	-17.06	peak
7290.000	V	13.21	30.11	43.32	54.00	-10.68	AVG

Note: Level = Reading + Factor

Margin = Level – Limit

Factor= Antenna Factor + Cable Loss - Amplifier Factor



Power	: AC 120V	Temperature	: 24 °C
Test Mode8	802.11n HT40 (2437MHz) Ant2	Humidity	: 54 %
Test date	: May 07, 2017	Atmospheric Pressure	: 1010 hpa

Frequency (MHz)	AntPol. H/V	Correct Factor (dB)	Reading level (dBuV)	Measure Level (dBuV/m)	Limit 3m (dBuV/m)	Safe Margin (dB)	Detector mode (PK/AV)
2317.500	H	-3.36	42.78	39.42	74.00	-34.58	peak
3932.500	H	4.88	36.89	41.77	74.00	-32.23	peak
4187.500	H	6.07	34.64	40.71	74.00	-33.29	peak
5547.500	H	9.14	36.02	45.16	74.00	-28.84	peak
6057.500	H	10.28	33.45	43.73	74.00	-30.27	peak
6907.500	H	11.78	35.26	47.04	74.00	-26.96	peak
2190.000	V	-3.91	45.13	41.22	74.00	-32.78	peak
4442.500	V	7.37	36.53	43.90	74.00	-30.10	peak
4867.500	V	8.35	54.52	62.87	74.00	-11.13	peak
4867.500	V	8.35	42.10	50.45	54.00	-3.55	AVG
5462.500	V	8.99	36.34	45.33	74.00	-28.67	peak
6312.500	V	10.38	36.27	46.65	74.00	-27.35	peak
7332.500	V	13.38	45.17	58.55	74.00	-15.45	peak
7332.500	V	13.38	31.79	45.17	54.00	-8.83	AVG

Note: Level = Reading + Factor

Margin = Level – Limit

Factor= Antenna Factor + Cable Loss - Amplifier Factor



Power	: AC 120V	Temperature	: 24 °C
Test Mode8	802.11n HT40 (2452MHz) Ant2	Humidity	: 54 %
Test date	: May 07, 2017	Atmospheric Pressure	: 1010 hpa

Frequency (MHz)	AntPol. H/V	Correct Factor (dB)	Reading level (dBuV)	Measure Level (dBuV/m)	Limit 3m (dBuV/m)	Safe Margin (dB)	Detector mode (PK/AV)
2742.500	H	-0.96	41.61	40.65	74.00	-33.35	peak
3677.500	H	4.01	34.48	38.49	74.00	-35.51	peak
4825.000	H	8.27	35.63	43.90	74.00	-30.10	peak
5292.500	H	8.85	32.96	41.81	74.00	-32.19	peak
6057.500	H	10.28	32.87	43.15	74.00	-30.85	peak
7162.500	H	12.71	34.33	47.04	74.00	-26.96	peak
2742.500	V	-0.96	44.17	43.21	74.00	-30.79	peak
3762.500	V	4.30	35.06	39.36	74.00	-34.64	peak
4952.500	V	8.51	53.45	61.96	74.00	-12.04	peak
4952.500	V	8.51	40.79	49.30	54.00	-4.70	AVG
6015.000	V	10.27	35.09	45.36	74.00	-28.64	peak
6822.500	V	11.50	37.72	49.22	74.00	-24.78	peak
7375.000	V	13.54	44.09	57.63	74.00	-16.37	peak
7375.000	V	13.54	31.23	44.77	54.00	-9.23	AVG

Note: Level = Reading + Factor
Margin = Level – Limit
Factor= Antenna Factor + Cable Loss - Amplifier Factor



Power	: AC 120V	Temperature	: 24 °C
Test Mode9	802.11n HT20 (2412MHz) Ant1+2	Humidity	: 54 %
Test date	: May 07, 2017	Atmospheric Pressure	: 1010 hpa

Frequency (MHz)	AntPol. H/V	Correct Factor (dB)	Reading level (dBuV)	Measure Level (dBuV/m)	Limit 3m (dBuV/m)	Safe Margin (dB)	Detector mode (PK/AV)
2147.500	H	-4.10	44.30	40.20	74.00	-33.80	peak
4017.500	H	5.20	35.98	41.18	74.00	-32.82	peak
4740.000	H	8.11	36.11	44.22	74.00	-29.78	peak
5377.500	H	8.92	35.76	44.68	74.00	-29.32	peak
6312.500	H	10.38	34.49	44.87	74.00	-29.13	peak
6822.500	H	11.50	37.13	48.63	74.00	-25.37	peak
2785.000	V	-0.67	47.30	46.63	74.00	-27.37	peak
4825.000	V	8.27	55.45	63.72	74.00	-10.28	peak
4825.000	V	8.27	42.35	50.62	54.00	-3.38	AVG
5462.500	V	8.99	36.33	45.32	74.00	-28.68	peak
5972.500	V	10.19	36.31	46.50	74.00	-27.50	peak
6780.000	V	11.37	36.74	48.11	74.00	-25.89	peak
7247.500	V	13.05	45.74	58.79	74.00	-15.21	peak
7247.500	V	13.05	32.51	45.56	54.00	-8.44	AVG

Note: Level = Reading + Factor

Margin = Level – Limit

Factor= Antenna Factor + Cable Loss - Amplifier Factor



Power	: AC 120V	Temperature	: 24 °C
Test Mode9	802.11n HT20 (2437MHz) Ant1+2	Humidity	: 54 %
Test date	: May 07, 2017	Atmospheric Pressure	: 1010 hpa

Frequency (MHz)	AntPol. H/V	Correct Factor (dB)	Reading level (dBuV)	Measure Level (dBuV/m)	Limit 3m (dBuV/m)	Safe Margin (dB)	Detector mode (PK/AV)
1935.000	H	-5.10	44.96	39.86	74.00	-34.14	peak
4442.500	H	7.37	34.84	42.21	74.00	-31.79	peak
4782.500	H	8.19	35.69	43.88	74.00	-30.12	peak
5207.500	H	8.77	34.38	43.15	74.00	-30.85	peak
6440.000	H	10.44	33.99	44.43	74.00	-29.57	peak
7077.500	H	12.38	34.97	47.35	74.00	-26.65	peak
2062.500	V	-4.46	45.48	41.02	74.00	-32.98	peak
4230.000	V	6.28	36.82	43.10	74.00	-30.90	peak
4910.000	V	8.43	54.16	62.59	74.00	-11.41	peak
4910.000	V	8.43	41.97	50.40	54.00	-3.60	AVG
5632.500	V	9.35	36.38	45.73	74.00	-28.27	peak
6822.500	V	11.50	37.66	49.16	74.00	-24.84	peak
7332.500	V	13.38	43.32	56.70	74.00	-17.30	peak
7332.500	V	13.38	30.25	43.63	54.00	-10.37	AVG

Note: Level = Reading + Factor
Margin = Level – Limit
Factor= Antenna Factor + Cable Loss - Amplifier Factor



Power	: AC 120V	Temperature	: 24 °C
Test Mode9	802.11n HT20 (2462MHz) Ant1+2	Humidity	: 54 %
Test date	: May 07, 2017	Atmospheric Pressure	: 1010 hpa

Frequency (MHz)	AntPol. H/V	Correct Factor (dB)	Reading level (dBuV)	Measure Level (dBuV/m)	Limit 3m (dBuV/m)	Safe Margin (dB)	Detector mode (PK/AV)
2232.500	H	-3.73	43.28	39.55	74.00	-34.45	peak
4102.500	H	5.63	36.21	41.84	74.00	-32.16	peak
4655.000	H	7.95	35.15	43.10	74.00	-30.90	peak
5845.000	H	9.88	35.03	44.91	74.00	-29.09	peak
6270.000	H	10.37	34.73	45.10	74.00	-28.90	peak
6907.500	H	11.78	35.18	46.96	74.00	-27.04	peak
2190.000	V	-3.91	44.72	40.81	74.00	-33.19	peak
4315.000	V	6.72	34.86	41.58	74.00	-32.42	peak
4952.500	V	8.51	53.10	61.61	74.00	-12.39	peak
4952.500	V	8.51	41.26	49.77	54.00	-4.23	AVG
5972.500	V	10.19	35.47	45.66	74.00	-28.34	peak
6610.000	V	10.82	34.79	45.61	74.00	-28.39	peak
7417.500	V	13.71	43.21	56.92	74.00	-17.08	peak
7417.500	V	13.71	32.14	45.85	54.00	-8.15	AVG

Note: Level = Reading + Factor

Margin = Level – Limit

Factor= Antenna Factor + Cable Loss - Amplifier Factor



Power	: AC 120V	Temperature	: 24 °C
Test Mode10	802.11n HT40 (2422MHz) Ant1+2	Humidity	: 54 %
Test date	: May 07, 2017	Atmospheric Pressure	: 1010 hpa

Frequency (MHz)	AntPol. H/V	Correct Factor (dB)	Reading level (dBuV)	Measure Level (dBuV/m)	Limit 3m (dBuV/m)	Safe Margin (dB)	Detector mode (PK/AV)
2062.500	H	-4.46	45.25	40.79	74.00	-33.21	peak
2700.000	H	-1.24	43.87	42.63	74.00	-31.37	peak
4272.500	H	6.50	34.35	40.85	74.00	-33.15	peak
4995.000	H	8.59	34.64	43.23	74.00	-30.77	peak
6057.500	H	10.28	34.41	44.69	74.00	-29.31	peak
7290.000	H	13.21	36.67	49.88	74.00	-24.12	peak
2147.500	V	-4.10	46.83	42.73	74.00	-31.27	peak
4315.000	V	6.72	35.96	42.68	74.00	-31.32	peak
4867.500	V	8.35	56.26	64.61	74.00	-9.39	peak
4867.500	V	8.35	41.59	49.94	54.00	-4.06	AVG
5845.000	V	9.88	34.77	44.65	74.00	-29.35	peak
6440.000	V	10.44	35.88	46.32	74.00	-27.68	peak
7290.000	V	13.21	46.62	59.83	74.00	-14.17	peak
7290.000	V	13.21	32.16	45.37	54.00	-8.63	AVG

Note: Level = Reading + Factor

Margin = Level – Limit

Factor= Antenna Factor + Cable Loss - Amplifier Factor



Power	: AC 120V	Temperature	: 24 °C
Test Mode10	802.11n HT40 (2437MHz) Ant1+2	Humidity	: 54 %
Test date	: May 07, 2017	Atmospheric Pressure	: 1010 hpa

Frequency (MHz)	AntPol. H/V	Correct Factor (dB)	Reading level (dBuV)	Measure Level (dBuV/m)	Limit 3m (dBuV/m)	Safe Margin (dB)	Detector mode (PK/AV)
2190.000	H	-3.91	43.84	39.93	74.00	-34.07	peak
4230.000	H	6.28	35.67	41.95	74.00	-32.05	peak
4910.000	H	8.43	35.59	44.02	74.00	-29.98	peak
5717.500	H	9.56	33.44	43.00	74.00	-31.00	peak
6482.500	H	10.45	35.91	46.36	74.00	-27.64	peak
6950.000	H	11.92	36.29	48.21	74.00	-25.79	peak
1977.500	V	-4.86	44.92	40.06	74.00	-33.94	peak
3677.500	V	4.01	36.00	40.01	74.00	-33.99	peak
4910.000	V	8.43	55.06	63.49	74.00	-10.51	peak
4910.000	V	8.43	41.03	49.46	54.00	-4.54	AVG
5547.500	V	9.14	35.77	44.91	74.00	-29.09	peak
6865.000	V	11.64	37.12	48.76	74.00	-25.24	peak
7332.500	V	13.38	45.61	58.99	74.00	-15.01	peak
7332.500	V	13.38	31.26	44.64	54.00	-9.36	AVG

Note: Level = Reading + Factor

Margin = Level – Limit

Factor= Antenna Factor + Cable Loss - Amplifier Factor



Power	: AC 120V	Temperature	: 24 °C
Test Mode10	802.11n HT40 (2452MHz) Ant1+2	Humidity	: 54 %
Test date	: May 07, 2017	Atmospheric Pressure	: 1010 hpa

Frequency (MHz)	AntPol. H/V	Correct Factor (dB)	Reading level (dBuV)	Measure Level (dBuV/m)	Limit 3m (dBuV/m)	Safe Margin (dB)	Detector mode (PK/AV)
2147.500	H	-4.10	43.73	39.63	74.00	-34.37	peak
4612.500	H	7.87	33.23	41.10	74.00	-32.90	peak
5547.500	H	9.14	35.78	44.92	74.00	-29.08	peak
6440.000	H	10.44	35.10	45.54	74.00	-28.46	peak
6865.000	H	11.64	33.91	45.55	74.00	-28.45	peak
7077.500	H	12.38	34.85	47.23	74.00	-26.77	peak
2020.000	V	-4.64	49.66	45.02	74.00	-28.98	peak
4442.500	V	7.37	36.04	43.41	74.00	-30.59	peak
4910.000	V	8.43	55.38	63.81	74.00	-10.19	peak
4910.000	V	8.43	41.35	49.78	54.00	-4.22	AVG
6227.500	V	10.35	36.40	46.75	74.00	-27.25	peak
6907.500	V	11.78	37.93	49.71	74.00	-24.29	peak
7375.000	V	13.54	45.02	58.56	74.00	-15.44	peak
7375.000	V	13.54	30.56	44.10	54.00	-9.90	AVG

Note: Level = Reading + Factor

Margin = Level – Limit

Factor= Antenna Factor + Cable Loss - Amplifier Factor



6.7 Restricted Bands of Operation

Only spurious emissions are permitted in any of the frequency bands listed below:

MHz	MHz	MHz	GHz
0.09000 – 0.11000	16.42000 – 16.42300	399.9 – 410.0	4.500 – 5.250
0.49500 – 0.505**	16.69475 – 16.69525	608.0 – 614.0	5.350 – 5.460
2.17350 – 2.19050	16.80425 – 16.80475	960.0 – 1240.0	7.250 – 7.750
4.12500 – 4.12800	25.50000 – 25.67000	1300.0 – 1427.0	8.025 – 8.500
4.17725 – 4.17775	37.50000 – 38.25000	1435.0 – 1626.5	9.000 – 9.200
4.20725 – 4.20775	73.00000 – 74.60000	1645.5 – 1646.5	9.300 – 9.500
6.21500 – 6.21800	74.80000 – 75.20000	1660.0 – 1710.0	10.600 – 12.700
6.26775 – 6.26825	108.00000 – 121.94000	1718.8 – 1722.2	13.250 – 13.400
6.31175 – 6.31225	123.00000 – 138.00000	2200.0 – 2300.0	14.470 – 14.500
8.29100 – 8.29400	149.90000 – 150.05000	2310.0 – 2390.0	15.350 – 16.200
8.36200 – 8.36600	156.52475 – 156.52525	2483.5 – 2500.0	17.700 – 21.400
8.37625 – 8.38675	156.70000 – 156.90000	2655.0 – 2900.0	22.010 – 23.120
8.41425 – 8.41475	162.01250 – 167.17000	3260.0 – 3267.0	23.600 – 24.000
12.29000 – 12.29300	167.72000 – 173.20000	3332.0 – 3339.0	31.200 – 31.800
12.51975 – 12.52025	240.00000 – 285.00000	3345.8 – 3358.0	36.430 – 36.500
12.57675 – 12.57725	322.00000 – 335.40000	3600.0 – 4400.0	Above 38.6
13.36000 – 13.41000			

** : Until February 1, 1999, this restricted band shall be 0.490-0.510 MHz



6.8 Restrict Band Emission Measurement Data

Test Date: May 07, 2017

Temperature: 26°C

Atmospheric pressure: 1018 hPa

Humidity: 47%

Modulation Standard: 802.11b Ant1

Channel 1				Fundamental Frequency: 2412 MHz			
Frequency (MHz)	Factor (dB/m)	Reading (dBuV)	Level (dBuV/m)	Limit (dBuV/m)	Margin (dB)	Det.	Ant-Pol H/V
2390.000	-3.05	47.86	44.81	74.00	-29.19	peak	H
2390.000	-3.05	33.61	30.56	54.00	-23.44	AVG	H
2390.000	-3.05	49.35	46.30	74.00	-27.70	peak	V
2390.000	-3.05	35.26	32.21	54.00	-21.79	AVG	V
Channel 11				Fundamental Frequency: 2462 MHz			
2483.500	-2.65	47.56	44.91	74.00	-29.09	peak	H
2483.500	-2.65	32.67	30.02	54.00	-23.98	AVG	H
2483.500	-2.65	47.36	44.71	74.00	-29.29	peak	V
2483.540	-2.65	33.24	30.59	54.00	-23.41	AVG	V

Notes:

1. Result = Meter Reading + Factor
2. Factor = Antenna Factor + Cable Loss – Amplifier
3. The resolution bandwidth of test receiver/spectrum analyzer is 1MHz and video bandwidth is 3 MHz (detector peak mode) for Peak detection at frequency above 1GHz.
4. The resolution bandwidth of test receiver/spectrum analyzer is 1MHz and video bandwidth is 3 MHz (detector sample mode) for Average detection at frequency above 1GHz.



Test Date: May 07, 2017

Temperature: 26°C

Atmospheric pressure: 1018 hPa

Humidity: 47%

Modulation Standard: 802.11g Ant1

Channel 1				Fundamental Frequency: 2412 MHz			
Frequency (MHz)	Factor (dB/m)	Reading (dBuV)	Level (dBuV/m)	Limit (dBuV/m)	Margin (dB)	Det.	Ant-Pol H/V
2390.000	-3.05	48.63	45.58	74.00	-28.42	peak	H
2390.000	-3.05	36.22	33.17	54.00	-20.83	AVG	H
2390.000	-3.05	50.21	47.16	74.00	-26.84	peak	V
2390.000	-3.05	34.53	31.48	54.00	-22.52	AVG	V
Channel 11				Fundamental Frequency: 2462 MHz			
2483.500	-2.65	46.53	43.88	74.00	-30.12	peak	H
2483.500	-2.65	32.29	29.64	54.00	-24.36	AVG	H
2483.500	-2.65	47.98	45.33	74.00	-28.67	peak	V
2483.500	-2.65	33.24	30.59	54.00	-23.41	AVG	V

Notes:

1. Result = Meter Reading + Factor
2. Factor = Antenna Factor + Cable Loss – Amplifier
3. The resolution bandwidth of test receiver/spectrum analyzer is 1MHz and video bandwidth is 3 MHz (detector peak mode) for Peak detection at frequency above 1GHz.
4. The resolution bandwidth of test receiver/spectrum analyzer is 1MHz and video bandwidth is 3 MHz (detector sample mode) for Average detection at frequency above 1GHz.



Test Date: May 07, 2017

Temperature: 26°C

Atmospheric pressure: 1018 hPa

Humidity: 47%

Modulation Standard: 802.11n HT20 Ant1

Channel 1				Fundamental Frequency: 2412 MHz			
Frequency (MHz)	Factor (dB/m)	Reading (dBuV)	Level (dBuV/m)	Limit (dBuV/m)	Margin (dB)	Det.	Ant-Pol H/V
2390.000	-3.05	47.59	44.54	74.00	-29.46	peak	H
2390.000	-3.05	33.71	30.66	54.00	-23.34	AVG	H
2390.000	-3.05	52.33	49.28	74.00	-24.72	peak	V
2390.000	-3.05	38.61	35.56	54.00	-18.44	AVG	V
Channel 11				Fundamental Frequency: 2462 MHz			
2483.500	-2.65	46.85	44.20	74.00	-29.80	peak	H
2483.500	-2.65	32.16	29.51	54.00	-24.49	AVG	H
2483.500	-2.65	49.53	46.88	74.00	-27.12	peak	V
2483.500	-2.65	34.21	31.56	54.00	-22.44	AVG	V

Notes:

1. Result = Meter Reading + Factor
2. Factor = Antenna Factor + Cable Loss – Amplifier
3. The resolution bandwidth of test receiver/spectrum analyzer is 1MHz and video bandwidth is 3 MHz (detector peak mode) for Peak detection at frequency above 1GHz.
4. The resolution bandwidth of test receiver/spectrum analyzer is 1MHz and video bandwidth is 3 MHz (detector sample mode) for Average detection at frequency above 1GHz.



Test Date: May 07, 2017

Temperature: 26°C

Atmospheric pressure: 1018 hPa

Humidity: 47%

Modulation Standard: 802.11n HT40 Ant1

Channel 3				Fundamental Frequency: 2422 MHz			
Frequency (MHz)	Factor (dB/m)	Reading (dBuV)	Level (dBuV/m)	Limit (dBuV/m)	Margin (dB)	Det.	Ant-Pol H/V
2390.000	-3.05	48.32	45.27	74.00	-28.73	peak	H
2390.000	-3.05	34.26	31.21	54.00	-22.79	AVG	H
2390.000	-3.05	52.98	49.93	74.00	-24.07	peak	V
2390.000	-3.05	38.23	35.18	54.00	-18.82	AVG	V
Channel 9				Fundamental Frequency: 2452 MHz			
2483.500	-2.65	47.53	44.88	74.00	-29.12	peak	H
2483.500	-2.65	33.21	30.56	54.00	-23.44	AVG	H
2483.500	-2.65	54.26	51.61	74.00	-22.39	peak	V
2483.500	-2.65	38.16	35.51	54.00	-18.49	AVG	V

Notes:

1. Result = Meter Reading + Factor
2. Factor = Antenna Factor + Cable Loss – Amplifier
3. The resolution bandwidth of test receiver/spectrum analyzer is 1MHz and video bandwidth is 3 MHz (detector peak mode) for Peak detection at frequency above 1GHz.
4. The resolution bandwidth of test receiver/spectrum analyzer is 1MHz and video bandwidth is 3 MHz (detector sample mode) for Average detection at frequency above 1GHz.



Test Date: May 07, 2017

Temperature: 26°C

Atmospheric pressure: 1018 hPa

Humidity: 47%

Modulation Standard: 802.11b Ant2

Channel 1				Fundamental Frequency: 2412 MHz			
Frequency (MHz)	Factor (dB/m)	Reading (dBuV)	Level (dBuV/m)	Limit (dBuV/m)	Margin (dB)	Det.	Ant-Pol H/V
2390.000	-3.05	47.53	44.48	74.00	-29.52	peak	H
2390.000	-3.05	33.68	30.63	54.00	-23.37	AVG	H
2390.000	-3.05	52.36	49.31	74.00	-24.69	peak	V
2390.000	-3.05	37.27	34.22	54.00	-19.78	AVG	V
Channel 11				Fundamental Frequency: 2462 MHz			
2483.500	-2.65	47.32	44.67	74.00	-29.33	peak	H
2483.500	-2.65	33.26	30.61	54.00	-23.39	AVG	H
2483.500	-2.65	47.33	44.68	74.00	-29.32	peak	V
2483.500	-2.65	33.25	30.60	54.00	-23.40	AVG	V

Notes:

1. Result = Meter Reading + Factor
2. Factor = Antenna Factor + Cable Loss – Amplifier
3. The resolution bandwidth of test receiver/spectrum analyzer is 1MHz and video bandwidth is 3 MHz (detector peak mode) for Peak detection at frequency above 1GHz.
4. The resolution bandwidth of test receiver/spectrum analyzer is 1MHz and video bandwidth is 3 MHz (detector sample mode) for Average detection at frequency above 1GHz.



Test Date: May 07, 2017

Temperature: 26°C

Atmospheric pressure: 1018 hPa

Humidity: 47%

Modulation Standard: 802.11g Ant2

Channel 1				Fundamental Frequency: 2412 MHz			
Frequency (MHz)	Factor (dB/m)	Reading (dBuV)	Level (dBuV/m)	Limit (dBuV/m)	Margin (dB)	Det.	Ant-Pol H/V
2390.000	-3.05	48.36	45.31	74.00	-28.69	peak	H
2390.000	-3.05	33.78	30.73	54.00	-23.27	AVG	H
2390.000	-3.05	50.36	47.31	74.00	-26.69	peak	V
2390.000	-3.05	37.22	34.17	54.00	-19.83	AVG	V
Channel 11				Fundamental Frequency: 2462 MHz			
2483.500	-2.65	47.36	44.71	74.00	-29.29	peak	H
2483.500	-2.65	32.27	29.62	54.00	-24.38	AVG	H
2483.500	-2.65	49.35	46.70	74.00	-27.30	peak	V
2483.500	-2.65	34.26	31.61	54.00	-22.39	AVG	V

Notes:

1. Result = Meter Reading + Factor
2. Factor = Antenna Factor + Cable Loss – Amplifier
3. The resolution bandwidth of test receiver/spectrum analyzer is 1MHz and video bandwidth is 3 MHz (detector peak mode) for Peak detection at frequency above 1GHz.
4. The resolution bandwidth of test receiver/spectrum analyzer is 1MHz and video bandwidth is 3 MHz (detector sample mode) for Average detection at frequency above 1GHz.



Test Date: May 07, 2017

Temperature: 26°C

Atmospheric pressure: 1018 hPa

Humidity: 47%

Modulation Standard: 802.11n HT20 Ant2

Channel 1				Fundamental Frequency: 2412 MHz			
Frequency (MHz)	Factor (dB/m)	Reading (dBuV)	Level (dBuV/m)	Limit (dBuV/m)	Margin (dB)	Det.	Ant-Pol H/V
2390.000	-3.05	48.63	45.58	74.00	-28.42	peak	H
2390.000	-3.05	34.26	31.21	54.00	-22.79	AVG	H
2390.000	-3.05	50.32	47.27	74.00	-26.73	peak	V
2390.000	-3.05	35.36	32.31	54.00	-21.69	AVG	V
Channel 11				Fundamental Frequency: 2462 MHz			
2483.500	-2.65	47.23	44.58	74.00	-29.42	peak	H
2483.500	-2.65	33.42	30.77	54.00	-23.23	AVG	H
2483.500	-2.65	51.67	49.02	74.00	-24.98	peak	V
2483.500	-2.65	37.26	34.61	54.00	-19.39	AVG	V

Notes:

1. Result = Meter Reading + Factor
2. Factor = Antenna Factor + Cable Loss – Amplifier
3. The resolution bandwidth of test receiver/spectrum analyzer is 1MHz and video bandwidth is 3 MHz (detector peak mode) for Peak detection at frequency above 1GHz.
4. The resolution bandwidth of test receiver/spectrum analyzer is 1MHz and video bandwidth is 3 MHz (detector sample mode) for Average detection at frequency above 1GHz.



Test Date: May 07, 2017

Temperature: 26°C

Atmospheric pressure: 1018 hPa

Humidity: 47%

Modulation Standard: 802.11n HT40 Ant2

Channel 3				Fundamental Frequency: 2422 MHz			
Frequency (MHz)	Factor (dB/m)	Reading (dBuV)	Level (dBuV/m)	Limit (dBuV/m)	Margin (dB)	Det.	Ant-Pol H/V
2390.000	-3.05	47.69	44.64	74.00	-29.36	peak	H
2390.000	-3.05	34.21	31.16	54.00	-22.84	AVG	H
2390.000	-3.05	53.66	50.61	74.00	-23.39	peak	V
2390.000	-3.05	38.67	35.62	54.00	-18.38	AVG	V
Channel 9				Fundamental Frequency: 2452 MHz			
2483.500	-2.65	49.86	47.21	74.00	-26.79	peak	H
2483.500	-2.65	35.21	32.56	54.00	-21.44	AVG	H
2483.500	-2.65	62.15	59.50	74.00	-14.50	peak	V
2483.500	-2.65	46.33	43.68	54.00	-10.32	AVG	V

Notes:

1. Result = Meter Reading + Factor
2. Factor = Antenna Factor + Cable Loss – Amplifier
3. The resolution bandwidth of test receiver/spectrum analyzer is 1MHz and video bandwidth is 3 MHz (detector peak mode) for Peak detection at frequency above 1GHz.
4. The resolution bandwidth of test receiver/spectrum analyzer is 1MHz and video bandwidth is 3 MHz (detector sample mode) for Average detection at frequency above 1GHz.



Test Date: May 07, 2017

Temperature: 26°C

Atmospheric pressure: 1018 hPa

Humidity: 47%

Modulation Standard: 802.11n HT20 Ant1+2

Channel 1				Fundamental Frequency: 2412 MHz			
Frequency (MHz)	Factor (dB/m)	Reading (dBuV)	Level (dBuV/m)	Limit (dBuV/m)	Margin (dB)	Det.	Ant-Pol H/V
2390.000	-3.05	48.33	45.28	74.00	-28.72	peak	H
2390.000	-3.05	35.26	32.21	54.00	-21.79	AVG	H
2390.000	-3.05	51.62	48.57	74.00	-25.43	peak	V
2390.000	-3.05	36.57	33.52	54.00	-20.48	AVG	V
Channel 11				Fundamental Frequency: 2462 MHz			
2483.500	-2.65	47.24	44.59	74.00	-29.41	peak	H
2483.500	-2.65	33.52	30.87	54.00	-23.13	AVG	H
2483.500	-2.65	52.33	49.68	74.00	-24.32	peak	V
2483.500	-2.65	36.27	33.62	54.00	-20.38	AVG	V

Notes:

1. Result = Meter Reading + Factor
2. Factor = Antenna Factor + Cable Loss – Amplifier
3. The resolution bandwidth of test receiver/spectrum analyzer is 1MHz and video bandwidth is 3 MHz (detector peak mode) for Peak detection at frequency above 1GHz.
4. The resolution bandwidth of test receiver/spectrum analyzer is 1MHz and video bandwidth is 3 MHz (detector sample mode) for Average detection at frequency above 1GHz.



Test Date: May 07, 2017

Temperature: 26°C

Atmospheric pressure: 1018 hPa

Humidity: 47%

Modulation Standard: 802.11n HT40 Ant1+2

Channel 3				Fundamental Frequency: 2422 MHz			
Frequency (MHz)	Factor (dB/m)	Reading (dBuV)	Level (dBuV/m)	Limit (dBuV/m)	Margin (dB)	Det.	Ant-Pol H/V
2390.000	-3.05	47.96	44.91	74.00	-29.09	peak	H
2390.000	-3.05	34.21	31.16	54.00	-22.84	AVG	H
2390.000	-3.05	58.63	55.58	74.00	-18.42	peak	V
2390.000	-3.05	43.36	40.31	54.00	-13.69	AVG	V
Channel 9				Fundamental Frequency: 2452 MHz			
2483.500	-2.65	50.31	47.66	74.00	-26.34	peak	H
2483.500	-2.65	35.26	32.61	54.00	-21.39	AVG	H
2483.500	-2.65	62.53	59.88	74.00	-14.12	peak	V
2483.500	-2.65	47.43	44.78	54.00	-9.22	AVG	V

Notes:

1. Result = Meter Reading + Factor
2. Factor = Antenna Factor + Cable Loss – Amplifier
3. The resolution bandwidth of test receiver/spectrum analyzer is 1MHz and video bandwidth is 3 MHz (detector peak mode) for Peak detection at frequency above 1GHz.
4. The resolution bandwidth of test receiver/spectrum analyzer is 1MHz and video bandwidth is 3 MHz (detector sample mode) for Average detection at frequency above 1GHz.



7. Test of Spurious Emission (Conducted)

7.1 Test Limit

Below 30dB of the highest emission level of operating band (In 100 kHz Resolution Bandwidth)

7.2 Test Procedure

KDB 558074 D01v03r02 - Section 11.2 & Section 11.3

1. Reference level measurement

- (a) Set instrument center frequency to DTS channel center frequency
- (b) Set the span to ≥ 1.5 times the DTS bandwidth
- (c) Set the RBW = 100 kHz
- (d) Set the VBW $\geq 3 \times$ RBW
- (e) Detector = peak
- (f) Sweep time = auto couple
- (g) Trace mode = max hold
- (h) Allow trace to fully stabilize

2. Emission level measurement

- (a) Set the center frequency and span to encompass frequency range to be measured
- (b) RBW = 100kHz
- (c) VBW = 300kHz
- (d) Detector = Peak
- (e) Trace mode = max hold
- (f) Sweep time = auto couple
- (g) The trace was allowed to stabilize

7.3 Test Setup Layout

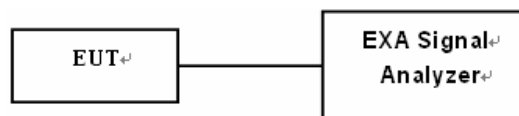



7.4 Test Result and Data

Test Date: May 07, 2017

Temperature: 24°C

Atmospheric pressure: 1014 hPa

Humidity: 47%

Antenna 1/ Antenna 2

Modulation Standard	Frequency (MHz)	Test Result
802.11b	2412	Pass
	2437	Pass
	2462	Pass
802.11g	2412	Pass
	2437	Pass
	2462	Pass
802.11n HT20	2412	Pass
	2437	Pass
	2462	Pass
802.11n HT40	2422	Pass
	2437	Pass
	2452	Pass

Note: Test plots refer to the following pages.



Antenna 1
Modulation Type: 802.11b
CH01

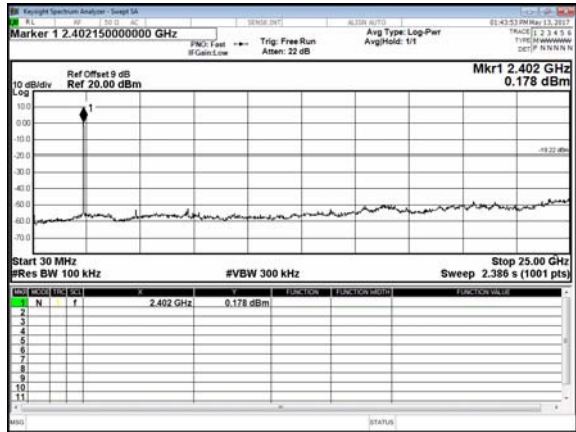
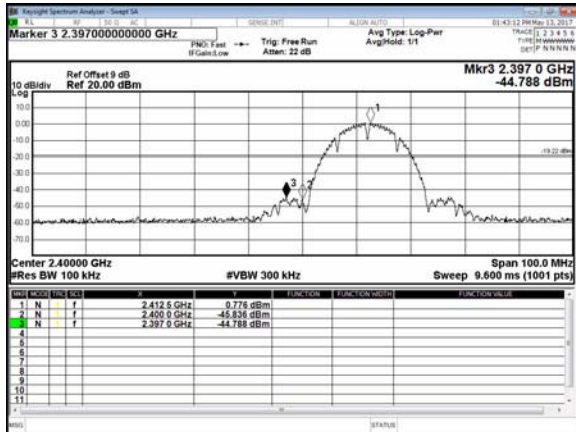

CH06

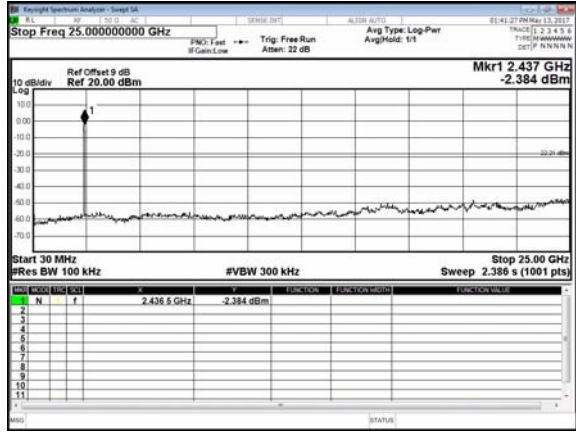
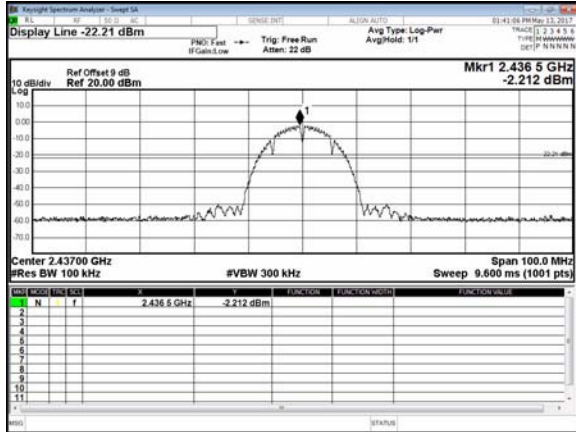

CH11

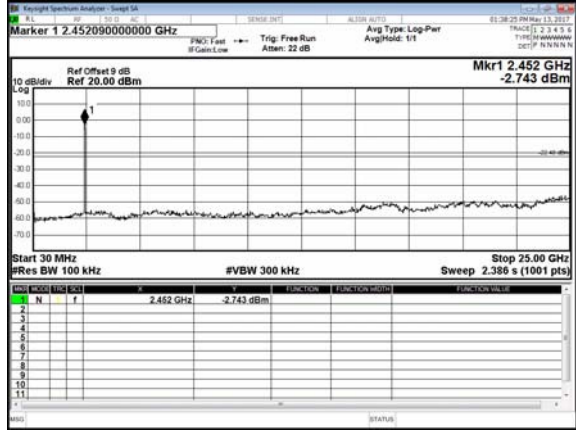
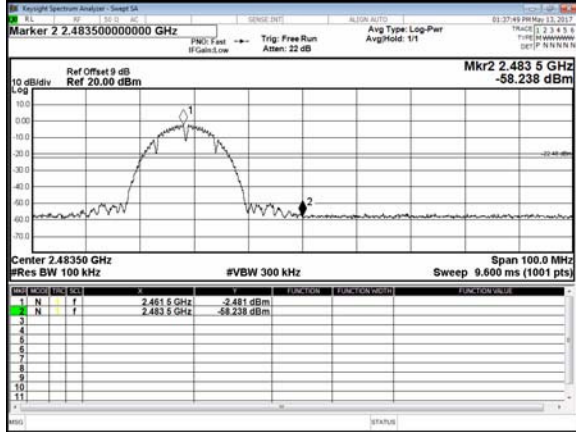



Modulation Type: 802.11g
CH01

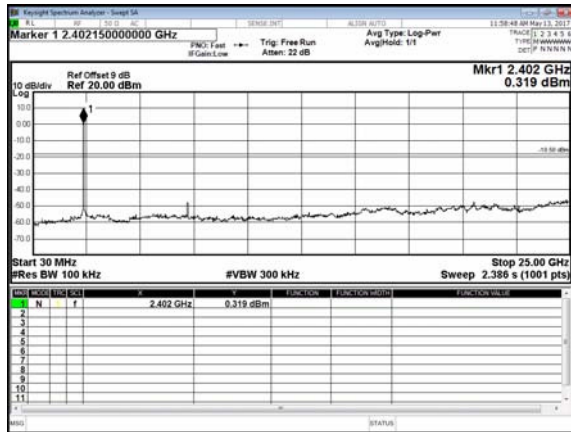
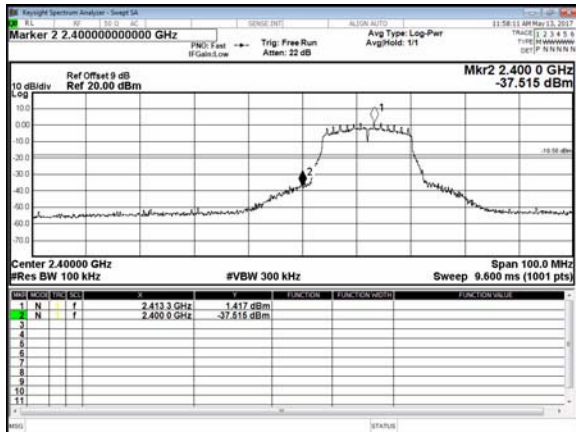

CH06

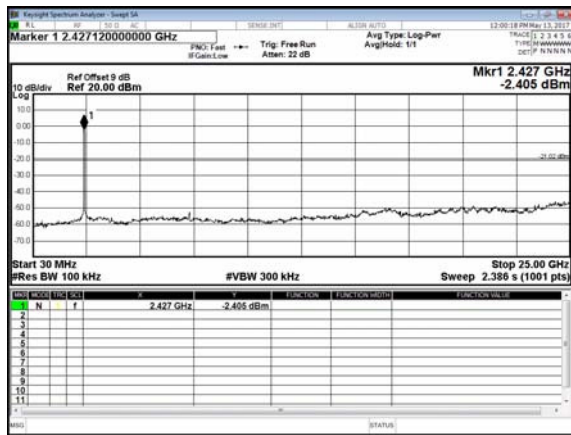
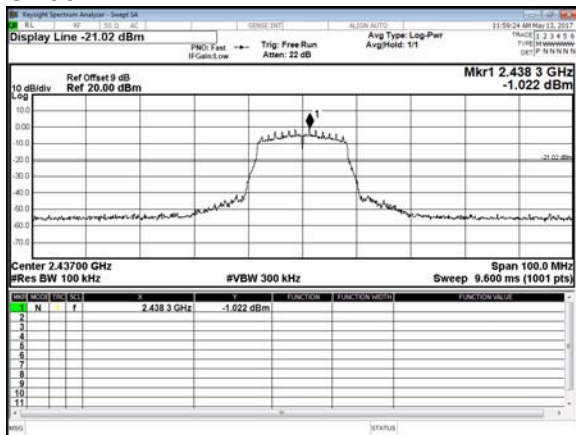

CH11

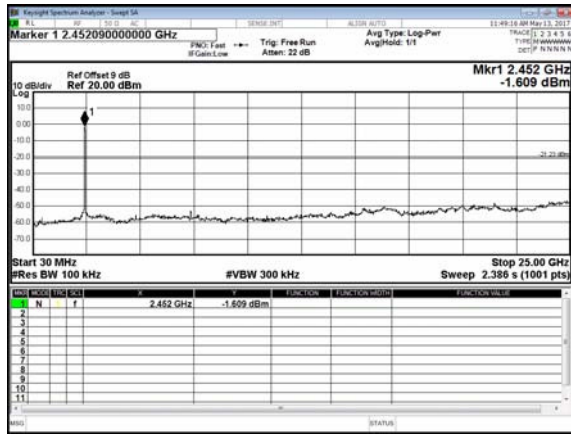
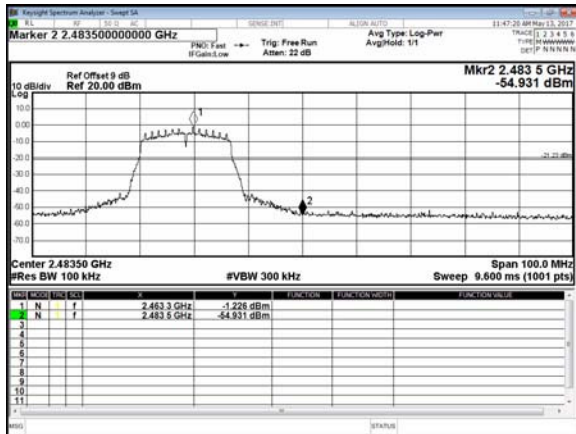



Modulation Type: 802.11n HT20
CH01

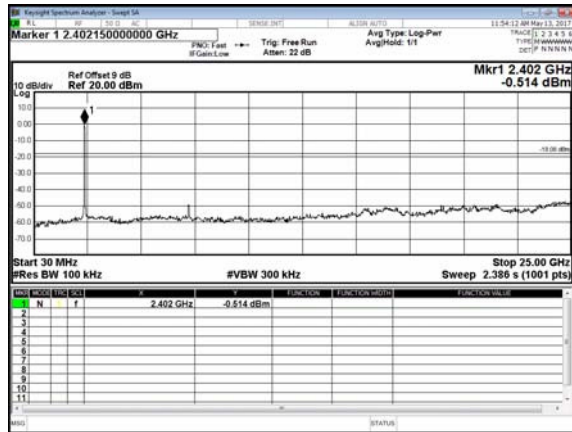
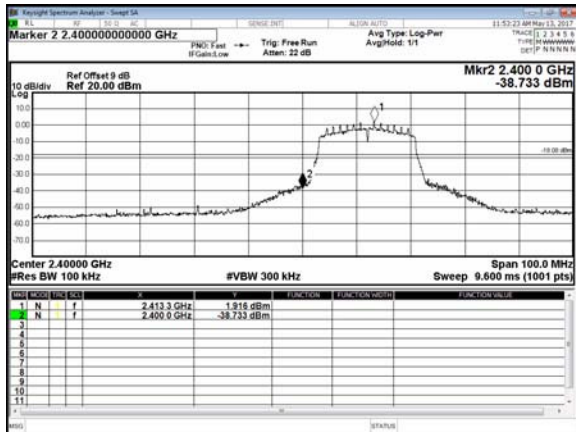

CH06

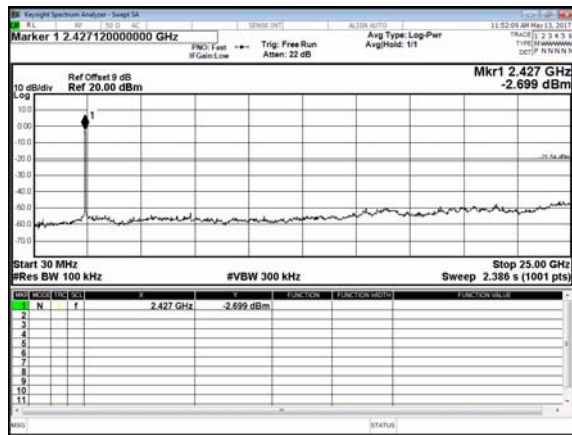
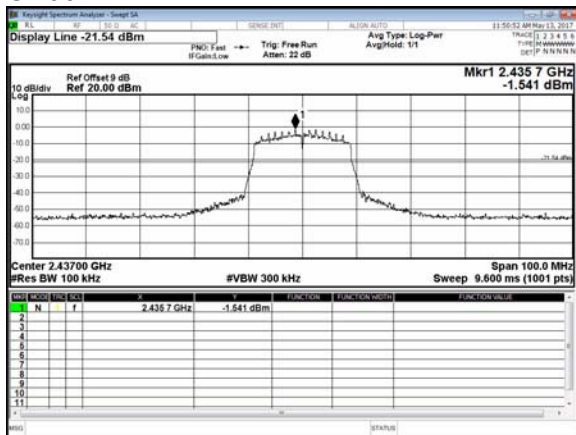

CH11

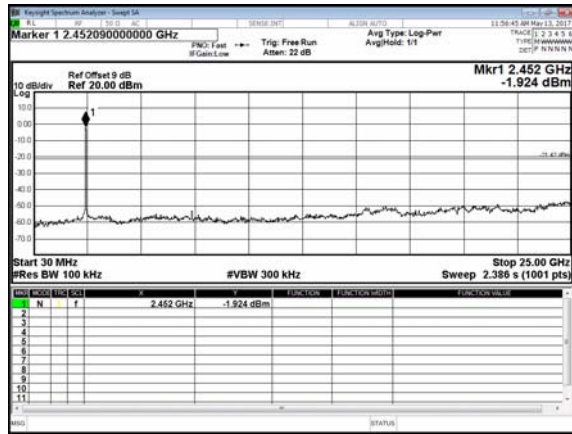
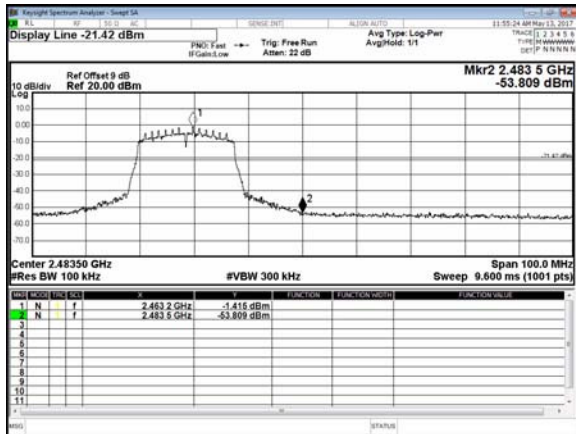



Modulation Type: 802.11n HT40
CH03

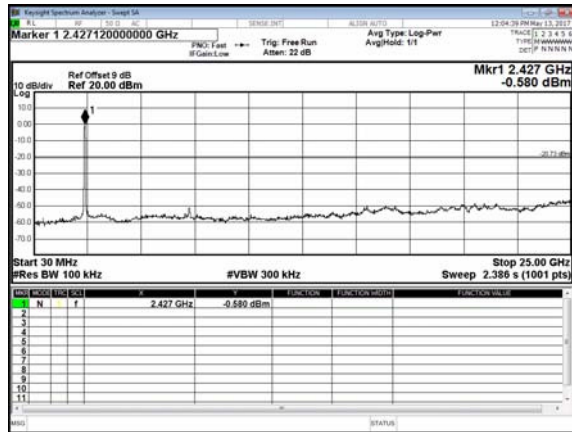
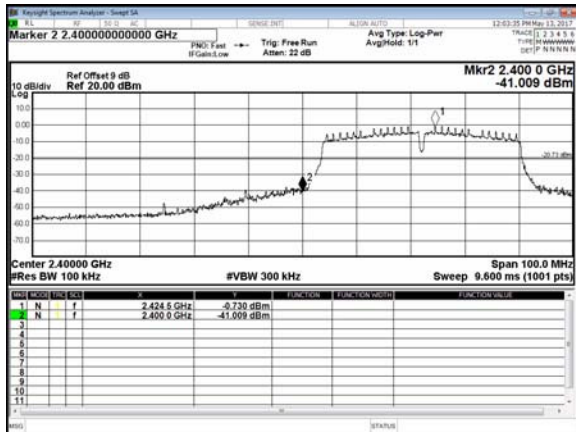

CH06

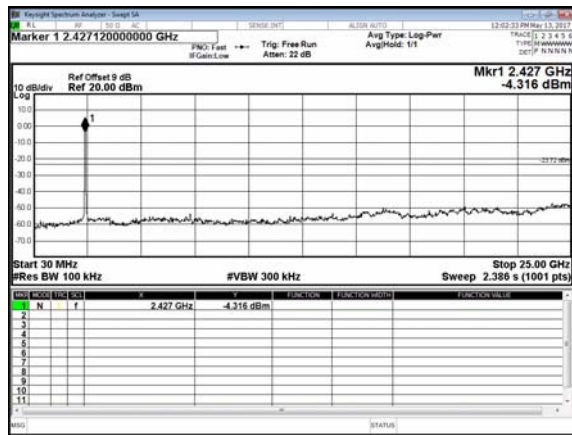
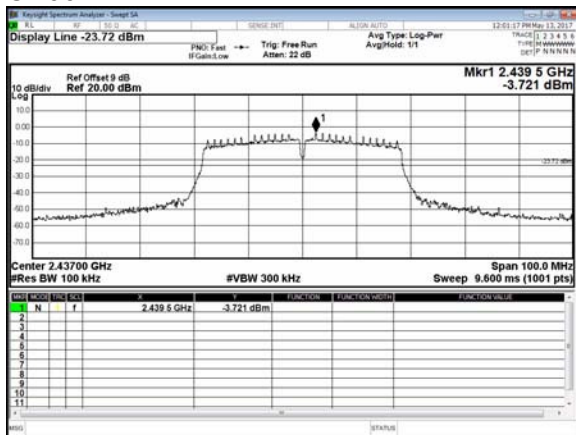

CH09

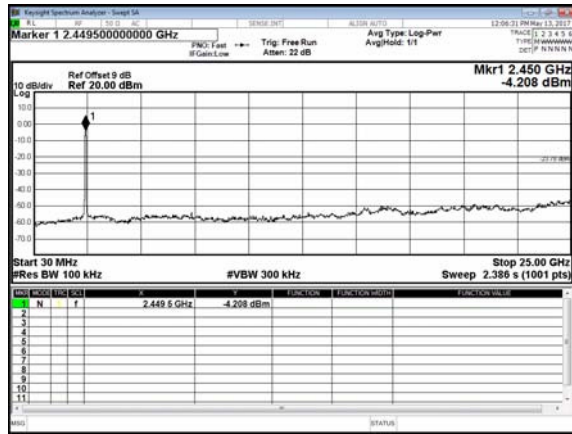
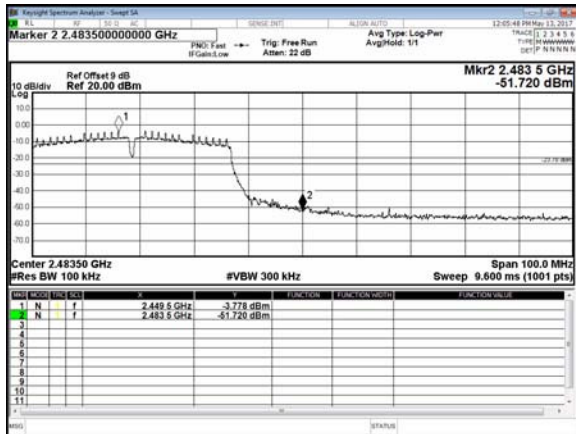



Antenna 2
Modulation Type: 802.11b
CH01

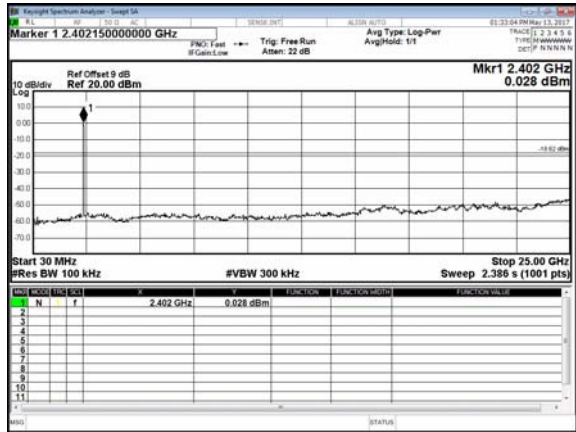
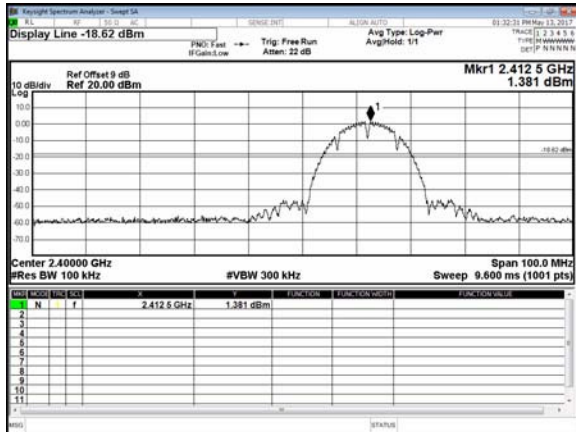

CH06

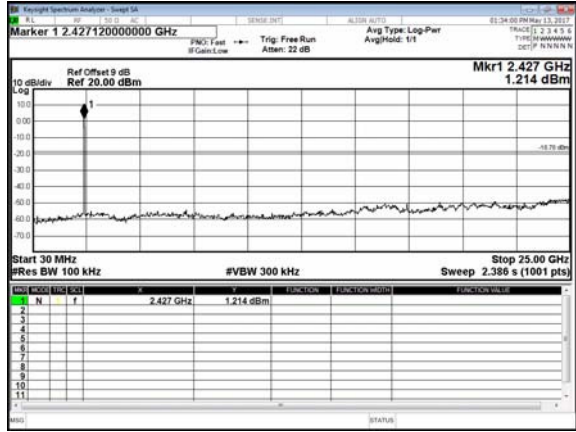
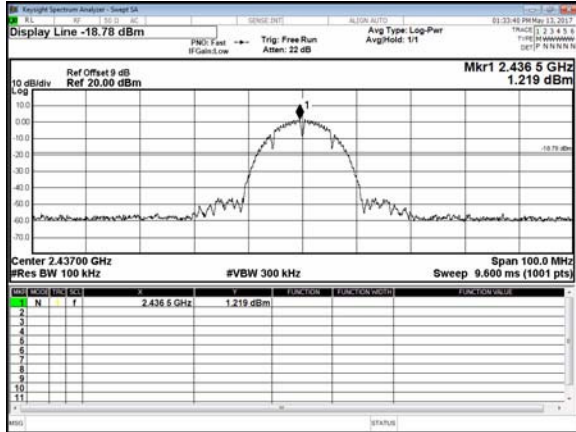

CH11

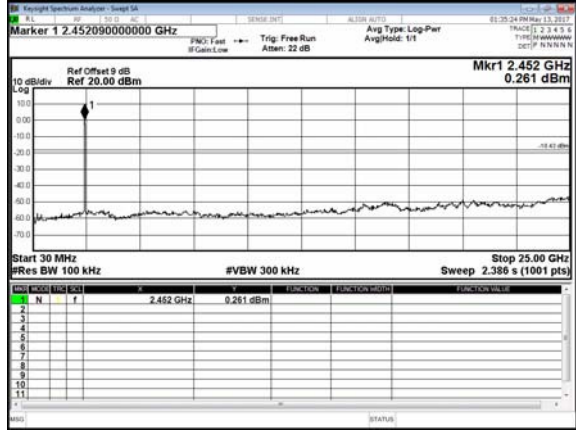
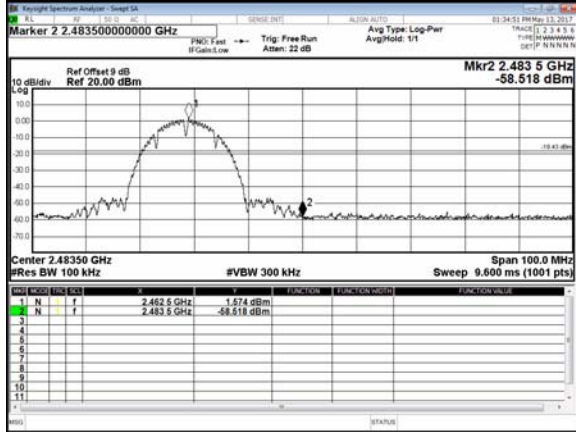



Modulation Type: 802.11g
CH01

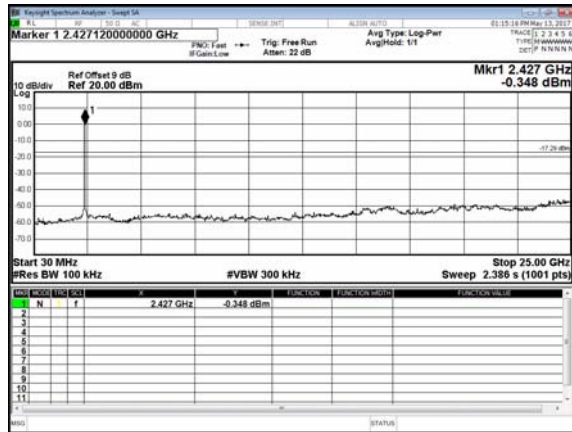
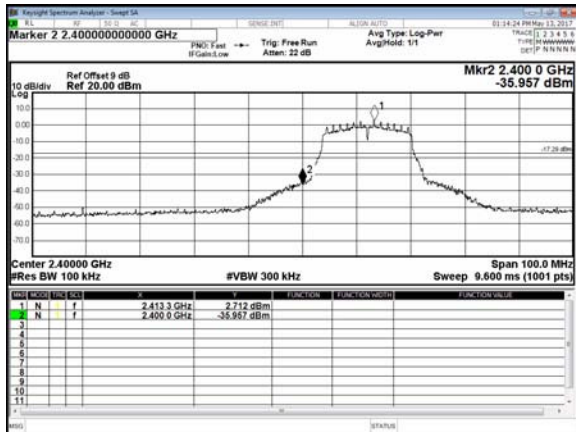

CH06

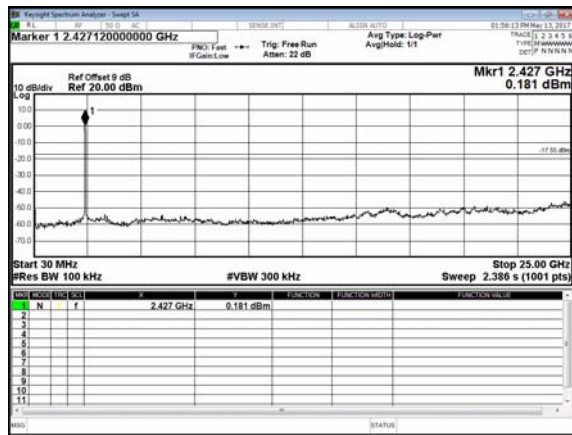
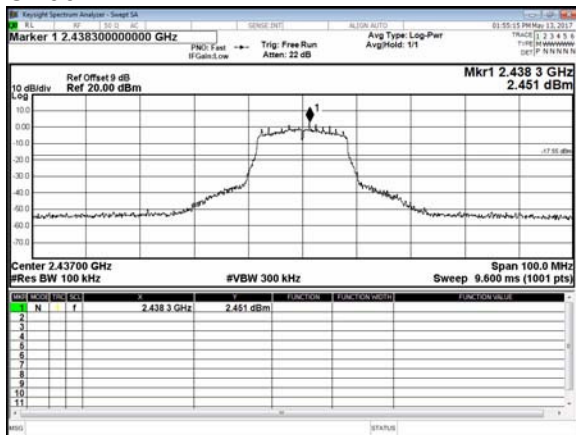

CH11

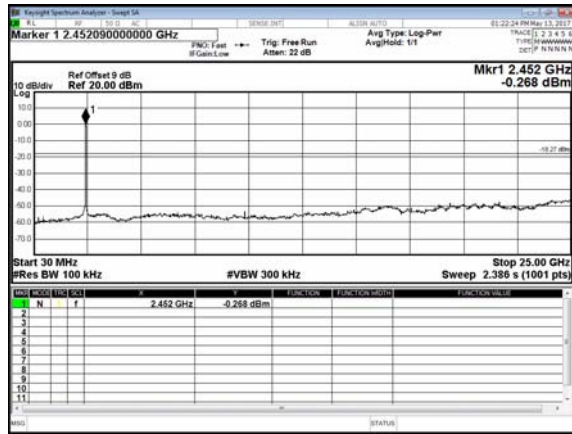
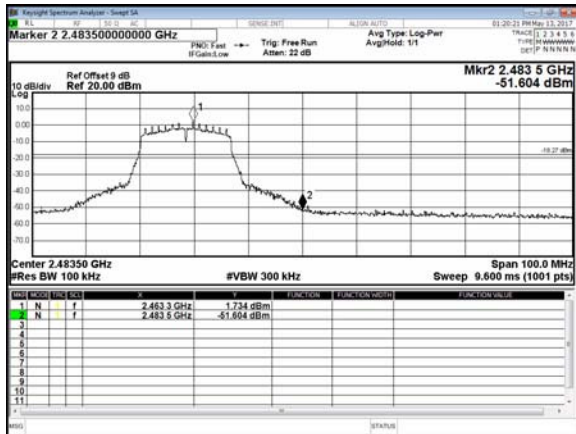



Modulation Type: 802.11n HT20
CH01

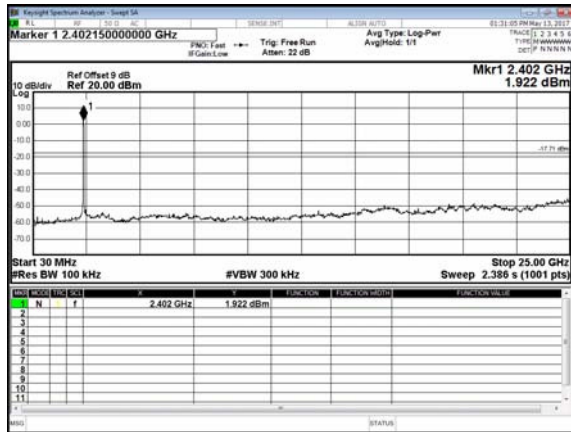
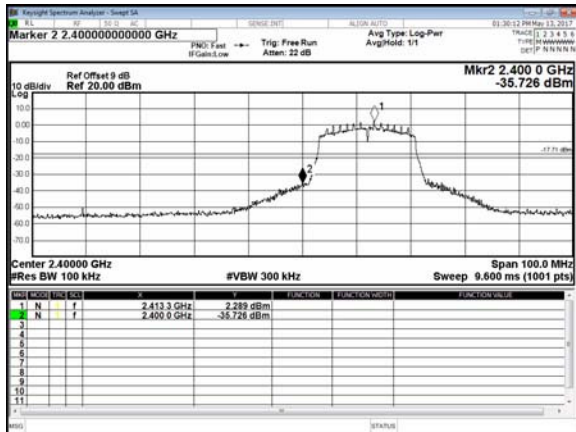

CH06

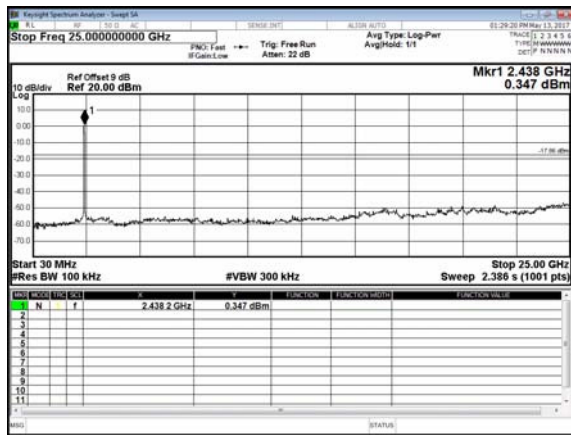
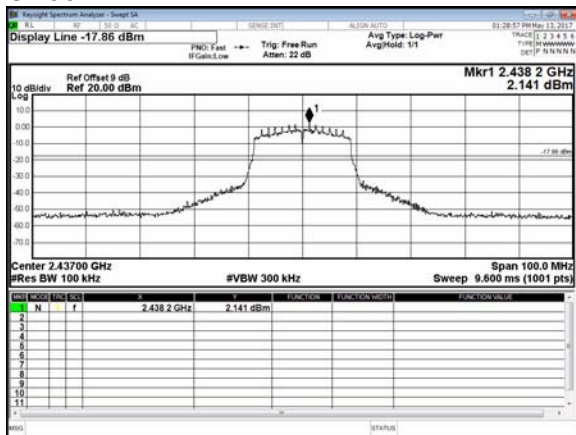

CH11

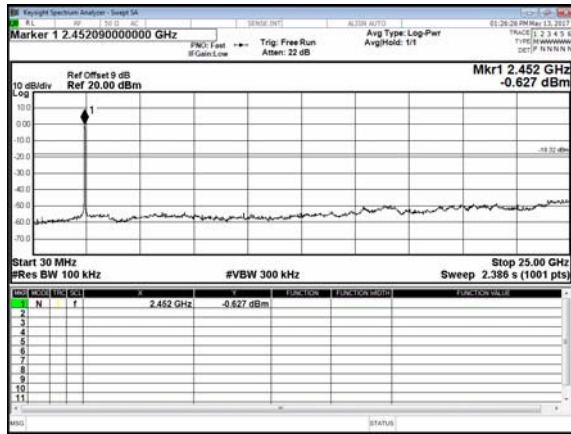
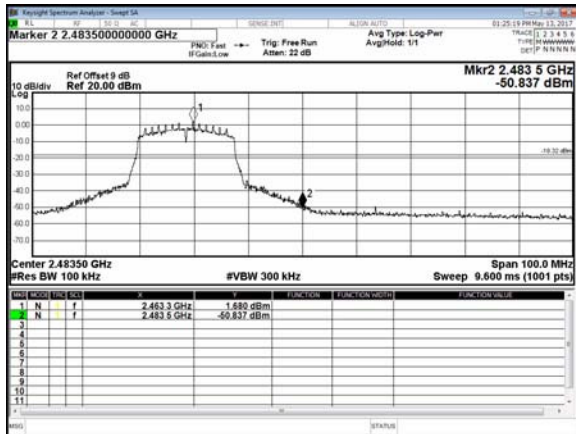



Modulation Type: 802.11n HT40
CH03

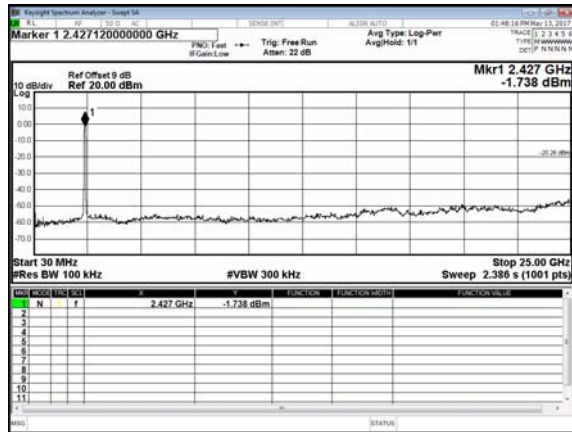
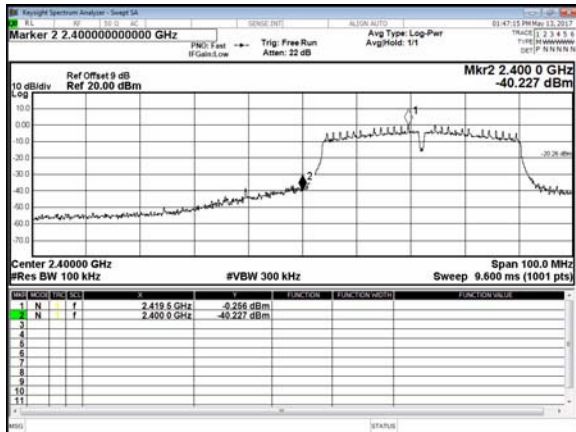

CH06

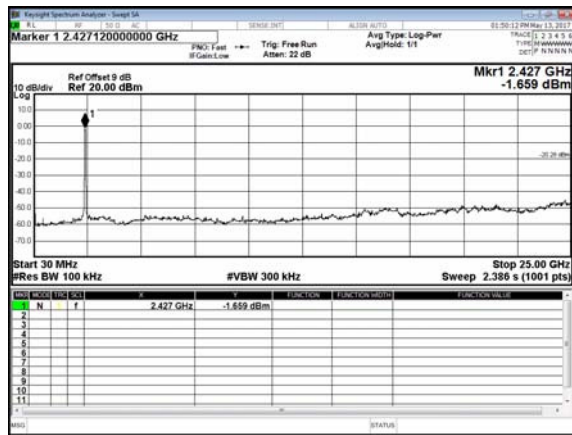
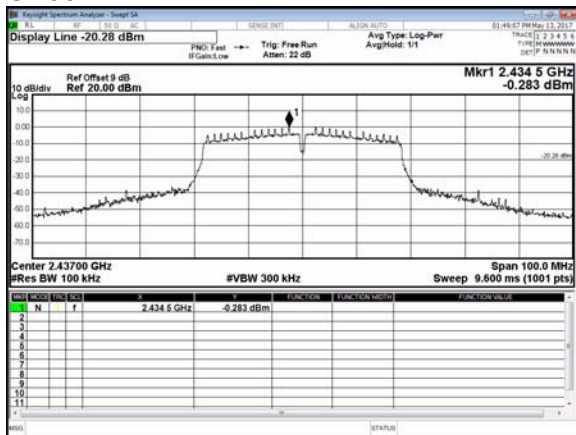

CH09

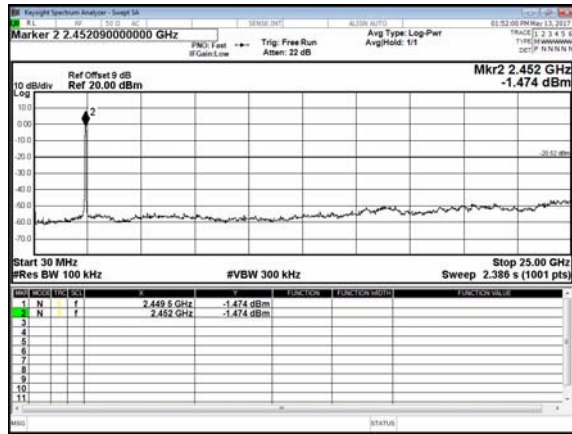
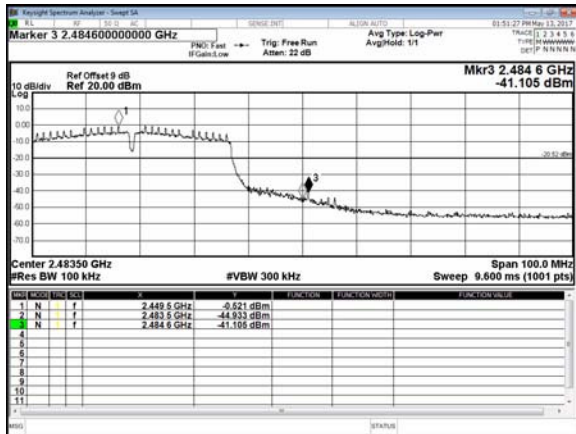



8. 6dB Bandwidth Measurement Data

8.1 Test Limit

The minimum of 6dB Bandwidth Measurement is 0.5 MHz.

8.2 Test Procedures

- a. The transmitter output was connected to the spectrum analyzer.
- b. Set RBW of spectrum analyzer to 100 KHz and VBW to 300 KHz.
- c. Set spectrum analyzer X dB to 6 dB.
- d. Set spectrum analyzer peak detector with maximum hold.

8.3 Test Setup Layout



8.4 Test Result and Data

Test Date: May 11, 2017

Temperature: 24°C

Atmospheric pressure: 1016 hPa

Humidity: 46%

Ant 1

Modulation Type	Channel	Frequency (MHz)	6dB Bandwidth (MHz)
IEEE 802.11b	01	2412	10.02
	06	2437	10.05
	11	2462	10.01
IEEE 802.11g	01	2412	15.12
	06	2437	15.17
	11	2462	15.15
IEEE 802.11n HT20	01	2412	15.15
	06	2437	15.14
	11	2462	15.15
IEEE 802.11n HT40	03	2422	35.12
	06	2437	35.13
	09	2452	35.13



Ant 2

Modulation Type	Channel	Frequency (MHz)	6dB Bandwidth (MHz)
IEEE 802.11b	01	2412	8.36
	06	2437	8.36
	11	2462	8.37
IEEE 802.11g	01	2412	15.16
	06	2437	15.16
	11	2462	15.16
IEEE 802.11n HT20	01	2412	15.15
	06	2437	15.15
	11	2462	15.16
IEEE 802.11n HT40	03	2422	35.11
	06	2437	35.12
	09	2452	35.13



Antenna 1
Modulation Type: 802.11b
CH01

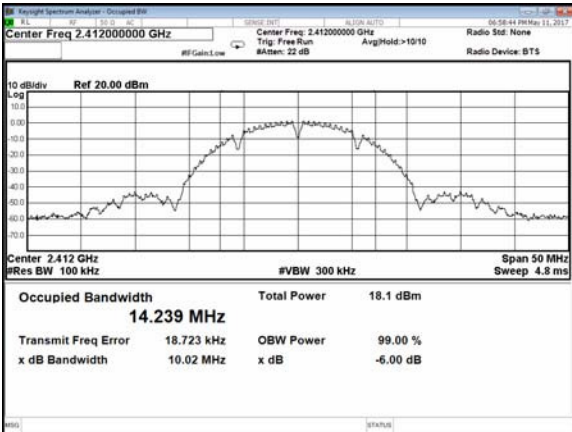

CH06

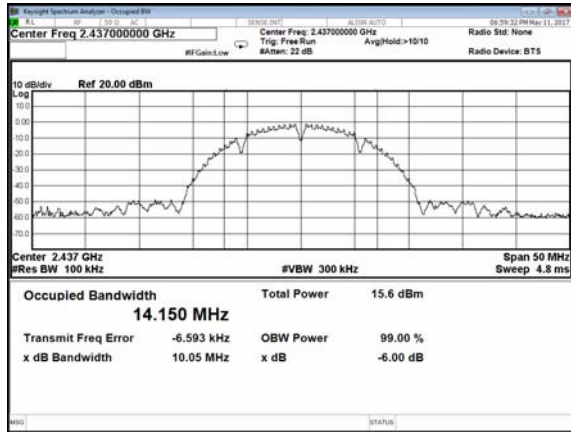

CH11

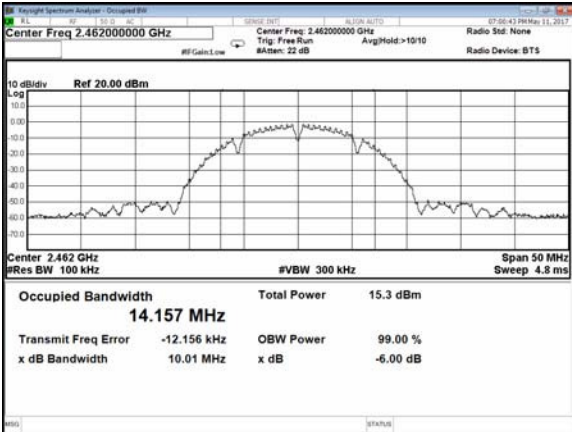

Modulation Type: 802.11g
CH01



CH06

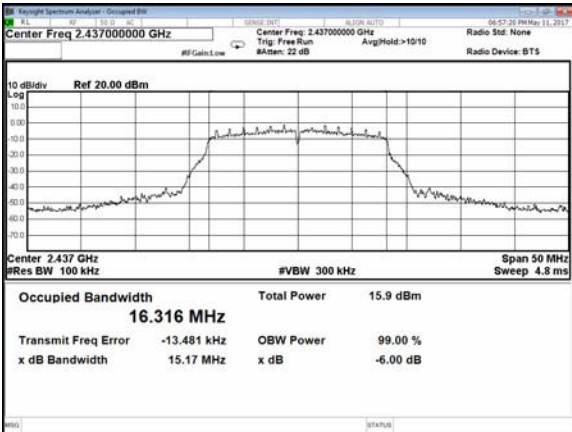

CH11

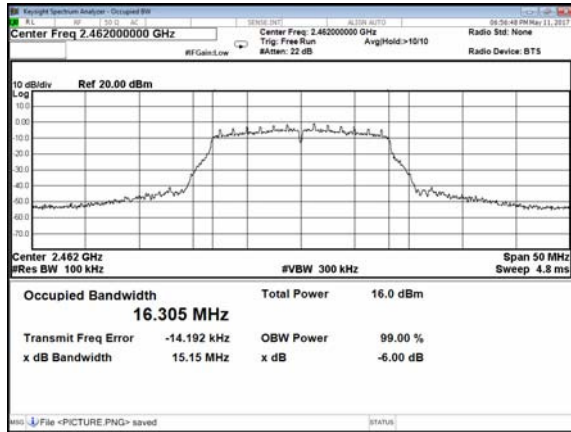



Modulation Type: 802.11n HT20
CH01

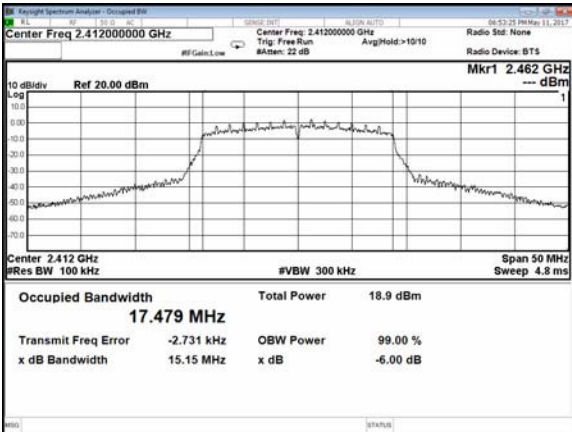

CH06

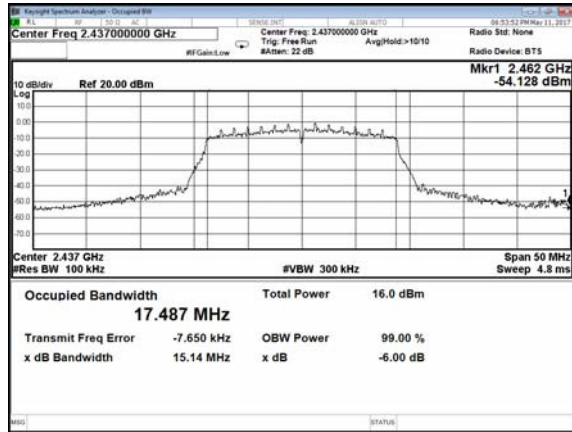

CH11

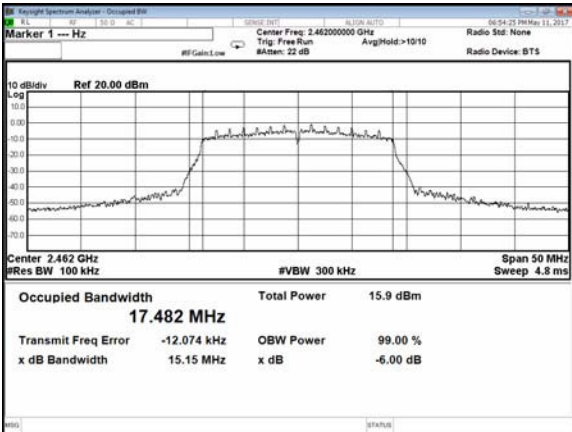

Modulation Type: 802.11n HT40
CH03

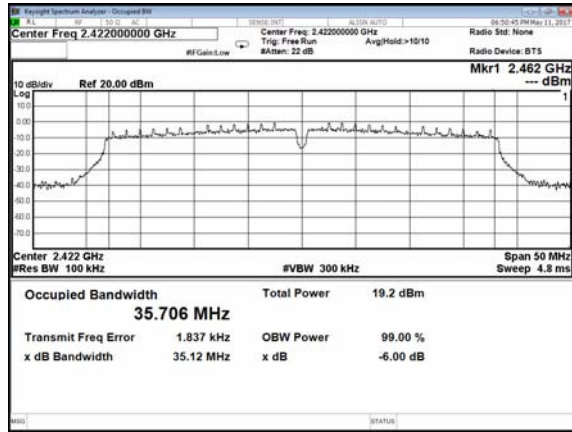

CH06

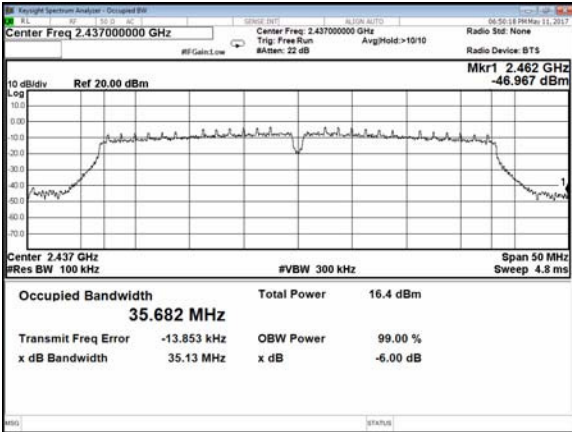

CH09

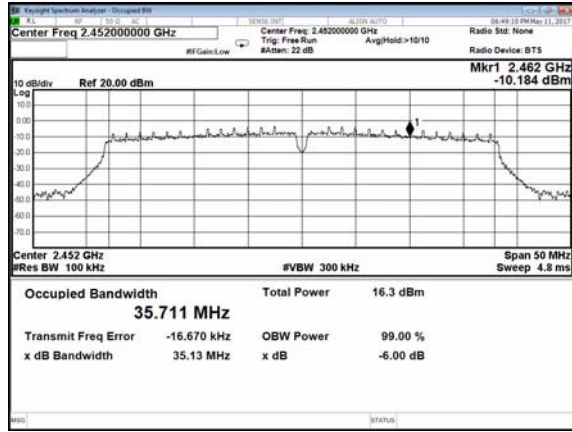



Antenna 2
Modulation Type: 802.11b
CH01

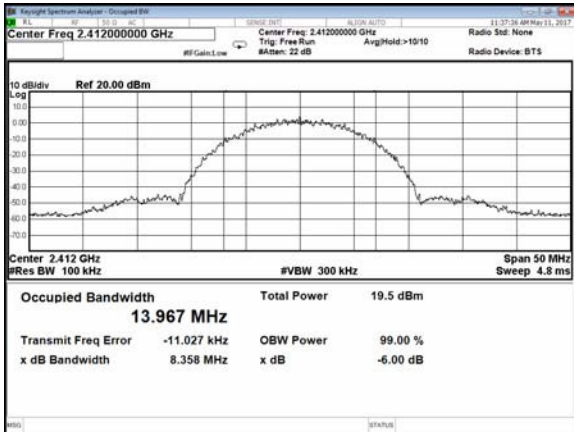

CH06

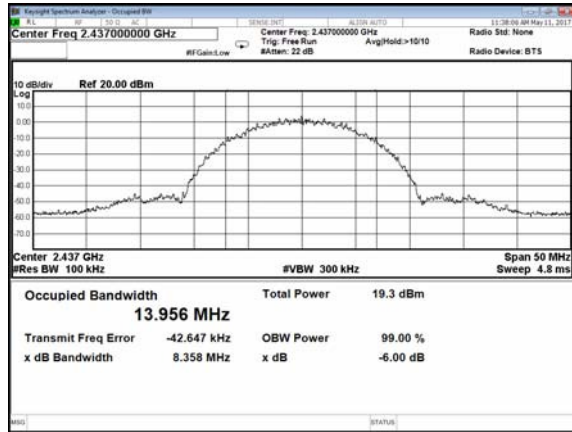

CH11

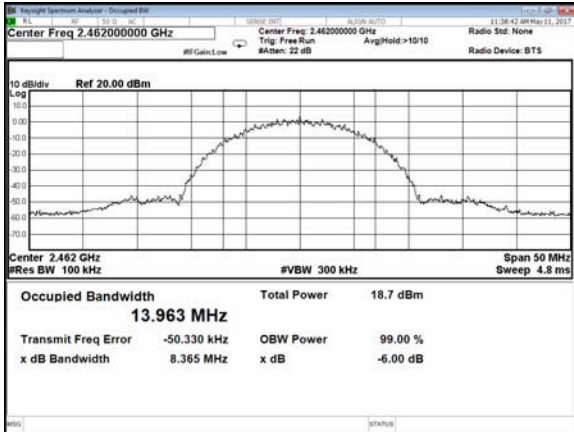

Modulation Type: 802.11g
CH01



CH06

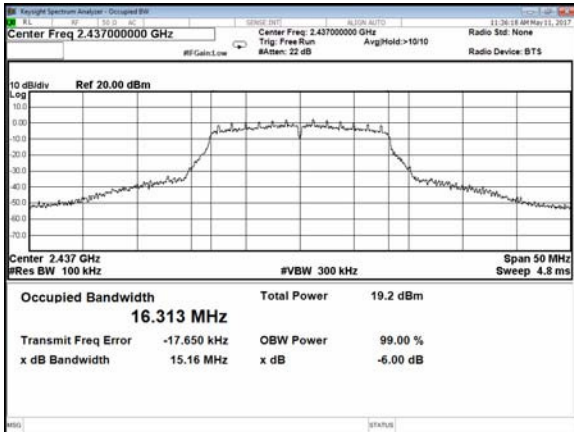

CH11





Modulation Type: 802.11n HT20
CH01

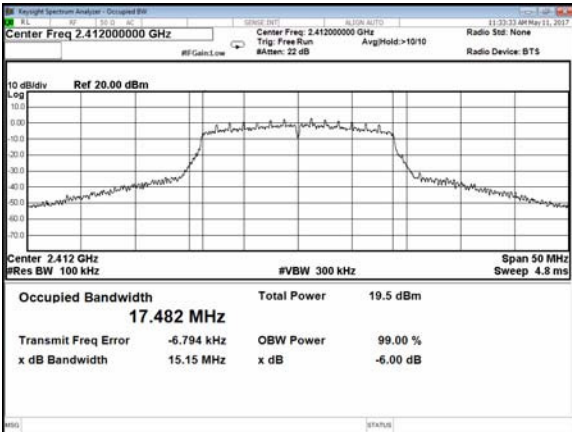

CH06

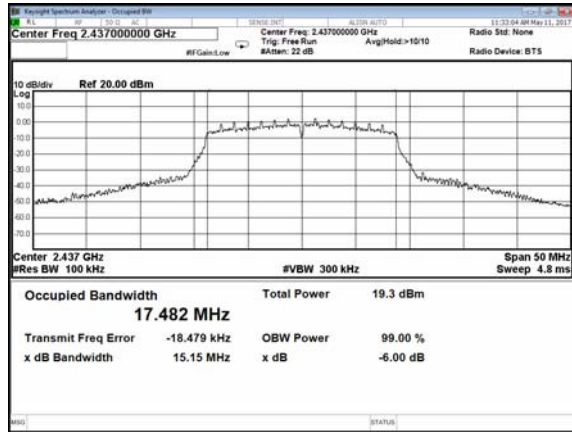

CH11

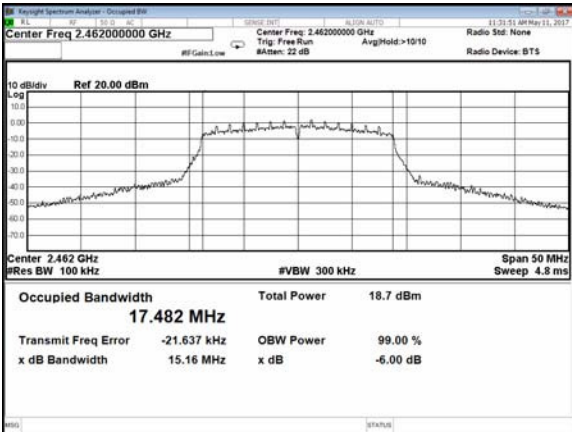

Modulation Type: 802.11n HT40
CH03

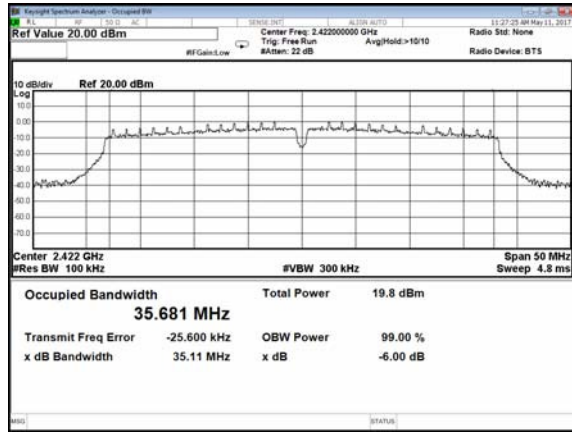

CH06

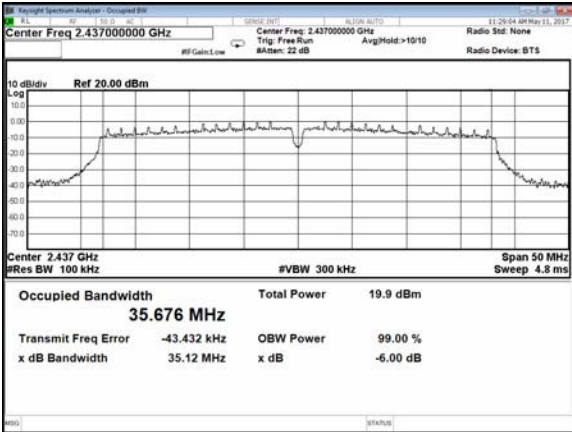

CH09

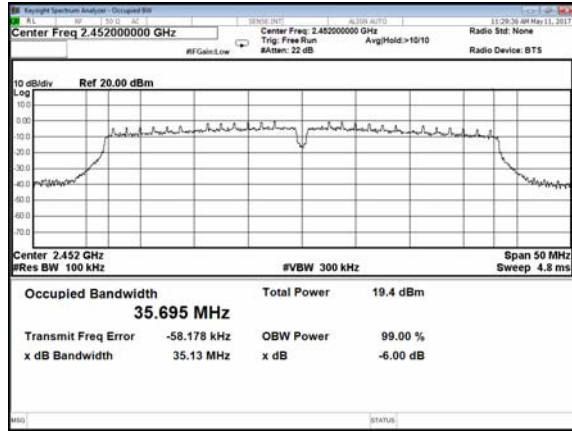



9. Maximum Peak Output Power

9.1 Test Limit

The Maximum Peak Output Power Measurement is 30dBm.

9.2 Test Procedures

Test procedure refers to KDB558074 D01v03r05, section 9.1.2 PKPM1 Peak power meter method.

The antenna port (RF output) of the EUT was connected to the input (RF input) of a power meter. Power was read directly from the meter and cable loss connection was added to the reading to obtain power at the EUT antenna terminal. The EUT Output Power was set to maximum to produce the worst case test result.

9.3 Test Setup Layout

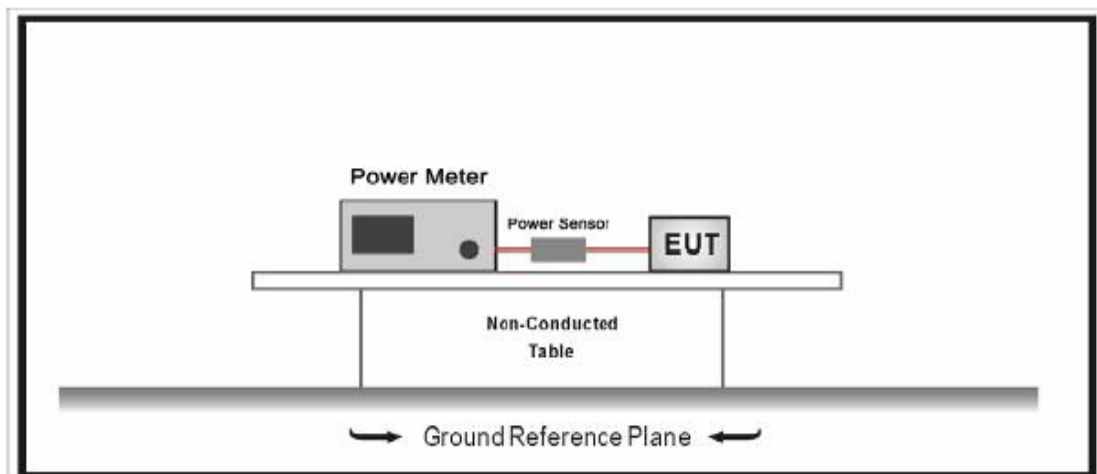



9.4 Test Result and Data

Test Date: May 07, 2017

Temperature: 24°C

Atmospheric pressure: 1016 hPa

Humidity: 46%

Chain 1

Modulation Type	Channel	Frequency (MHz)	Peak Power Output (dBm)	Peak Power Output (mW)
IEEE 802.11b	01	2412	18.84	76.560
	06	2437	16.52	44.875
	11	2462	16.31	42.756
IEEE 802.11g	01	2412	24.78	300.608
	06	2437	21.92	155.597
	11	2462	21.67	146.893
IEEE 802.11n HT20	01	2412	24.32	270.396
	06	2437	21.74	149.279
	11	2462	21.39	137.7209
IEEE 802.11n HT40	03	2422	24.96	313.329
	06	2437	22.12	162.930
	09	2452	22.03	159.588

Chain 2

Modulation Type	Channel	Frequency (MHz)	Peak Power Output (dBm)	Peak Power Output (mW)
IEEE 802.11b	01	2412	19.71	93.541
	06	2437	19.21	83.368
	11	2462	18.62	72.778
IEEE 802.11g	01	2412	25.19	330.370
	06	2437	25.77	377.572
	11	2462	24.62	289.734
IEEE 802.11n HT20	01	2412	25.21	331.894
	06	2437	24.89	308.319
	11	2462	24.36	272.898
IEEE 802.11n HT40	03	2422	25.59	362.243
	06	2437	25.42	348.337
	09	2452	25.24	334.195

Chain 1+2

Modulation Type	Frequency (MHz)	Peak Power (dBm) Chain 1	Peak Power (dBm) Chain 2	Antenna Gain	Peak Power (dBm) Chain 1+2	Peak Power Output (mW)
IEEE 802.11n HT20	2412	21.23	22.33	2.0	26.83	481.948
	2437	18.87	22.24	2.0	25.88	387.258
	2462	18.54	21.79	2.0	25.47	352.371
IEEE 802.11n HT40	2422	21.43	22.58	2.0	27.05	506.991
	2437	18.89	22.55	2.0	26.10	407.380
	2452	18.91	22.41	2.0	26.01	399.025



10. Power Spectral Density

10.1 Test Limit

The Maximum of Power Spectral Density Measurement is 8dBm.

10.2 Test Procedures

Test procedure refers to section 10.3 Method AVGPSD-1.

- a) Set instrument center frequency to DTS channel center frequency.
- b) Set span to at least 1.5 times the OBW.
- c) Set RBW to: $3 \text{ kHz} \leq \text{RBW} \leq 100 \text{ kHz}$.
- d) Set VBW $\geq 3 \times \text{RBW}$.
- e) Detector = power averaging (RMS) or sample detector (when RMS not available).
- f) Ensure that the number of measurement points in the sweep $\geq 2 \times \text{span}/\text{RBW}$.
- g) Sweep time = auto couple.
- h) Employ trace averaging (RMS) mode over a minimum of 100 traces.
- j) If measured value exceeds limit, reduce RBW (no less than 3 kHz) and repeat (note that this may require zooming in on the emission of interest and reducing the span in order to meet the minimum measurement point requirement as the RBW is reduced).

10.3 Test Setup Layout

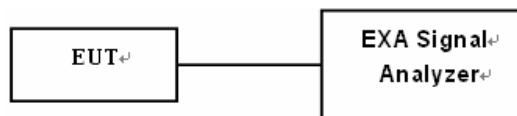



10.4 Test Result and Data

Test Date: May 07, 2017

Temperature: 24°C

Atmospheric pressure: 1014 hPa

Humidity: 47%

Modulation Type	Frequency (MHz)	Power Spectral Density (dBm)	
		Antenna 1	Antenna 2
IEEE 802.11b	2412	-13.094	-15.387
	2437	-14.402	-15.348
	2462	-15.889	-15.034
IEEE 802.11g	2412	-13.523	-15.168
	2437	-16.039	-14.964
	2462	-16.339	-15.274
IEEE 802.11n HT20	2412	-13.544	-14.273
	2437	-15.494	-13.996
	2462	-16.093	-15.828
IEEE 802.11n HT40	2422	-15.88	-17.671
	2437	-19.138	-17.041
	2452	-19.56	-16.965

Modulation Type	Frequency (MHz)	Power Spectral Density (dBm)			
		Antenna 1	Antenna 2	Antenna Gain	Total
IEEE 802.11n HT20	2412	-18.522	-18.671	2	-13.59
	2437	-18.696	-17.512	2	-13.05
	2462	-21.242	-19.33	2	-15.17
IEEE 802.11n HT40	2422	-20.529	-20.029	2	-15.26
	2437	-23.215	-19.588	2	-16.02
	2452	-23.664	-20.59	2	-16.85



Antenna 1
Modulation Type: 802.11b
CH01

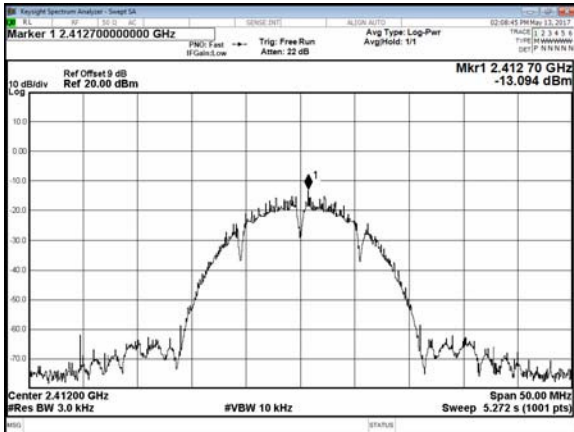

CH06



CH11

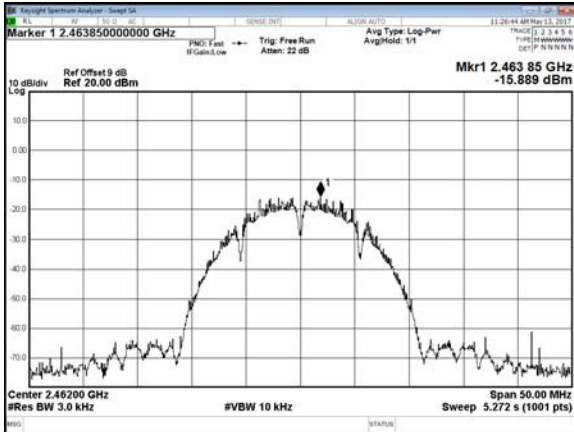

Modulation Type: 802.11g
CH01

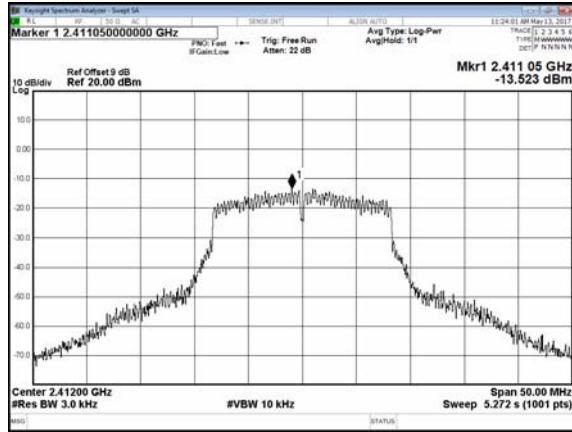

CH06

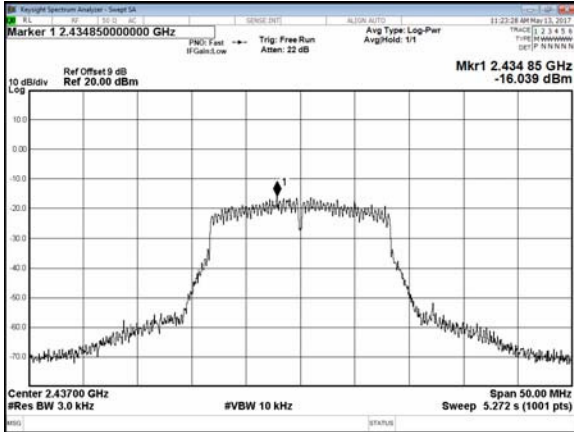

CH11





Modulation Type: 802.11n HT20
CH01

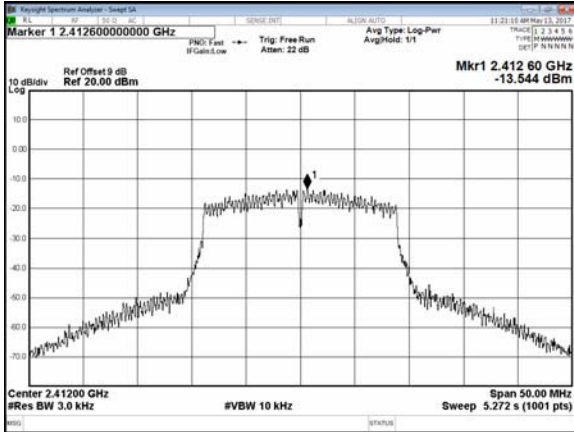

CH06

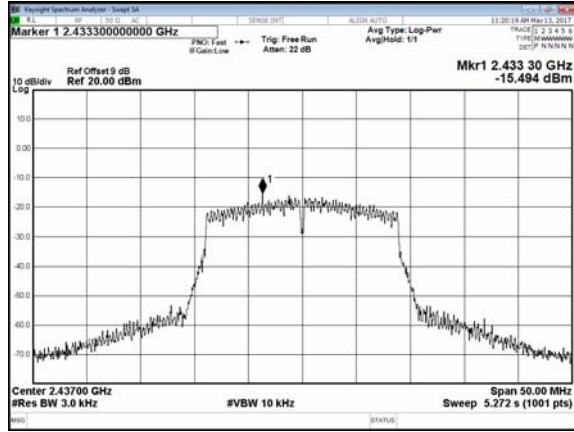

CH11

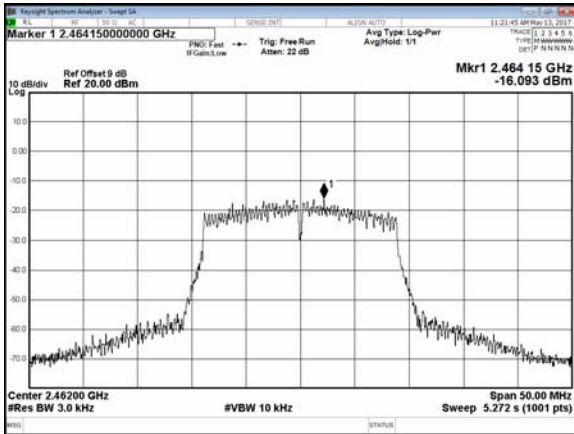

Modulation Type: 802.11n HT40
CH03

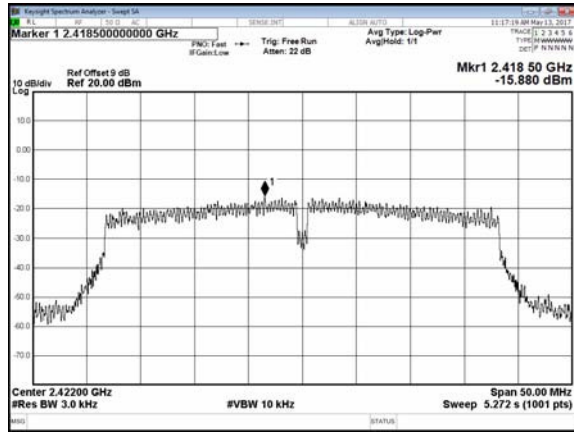

CH06

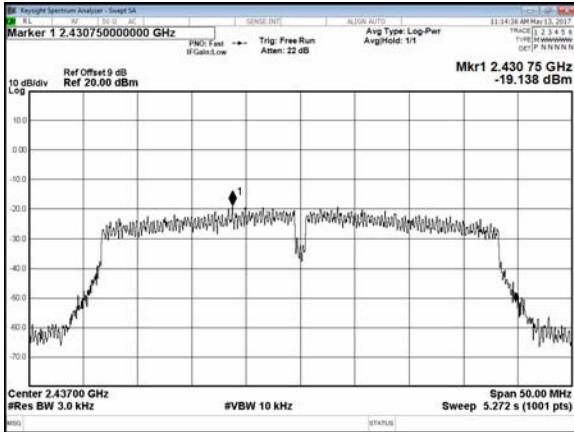

CH09

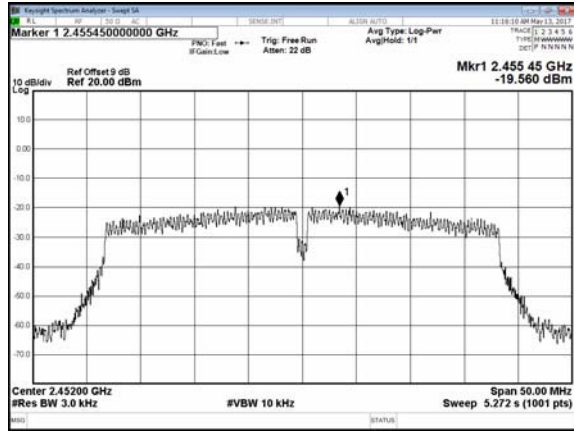



Antenna 2
Modulation Type: 802.11b
CH01

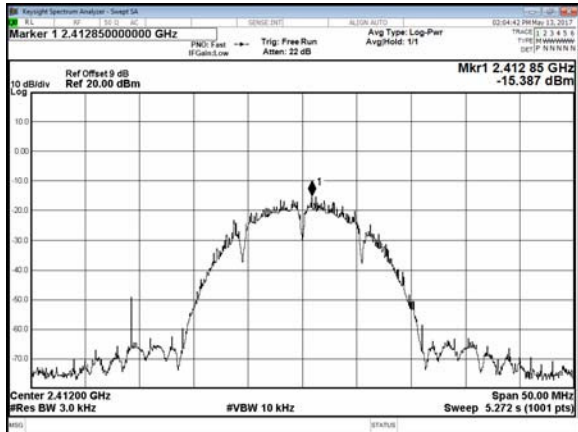

CH06

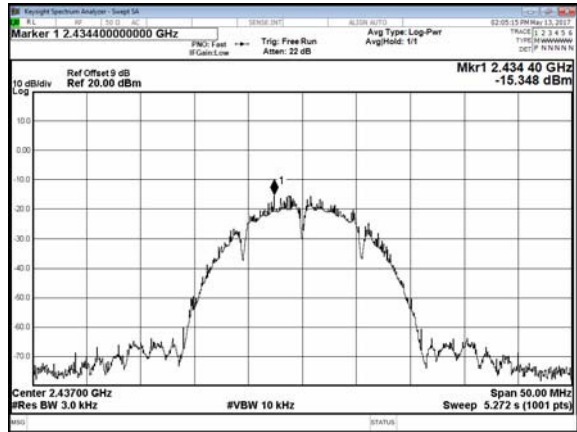

CH11

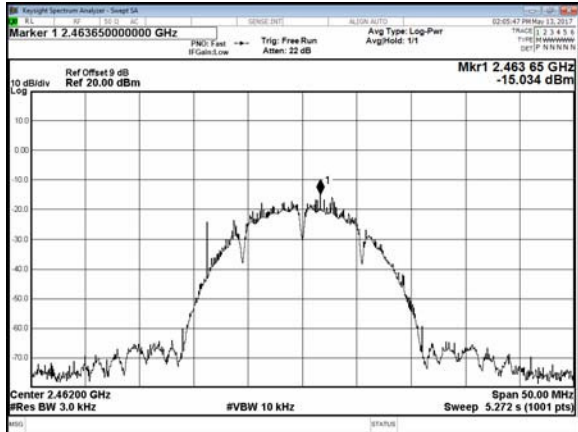

Modulation Type: 802.11g
CH01

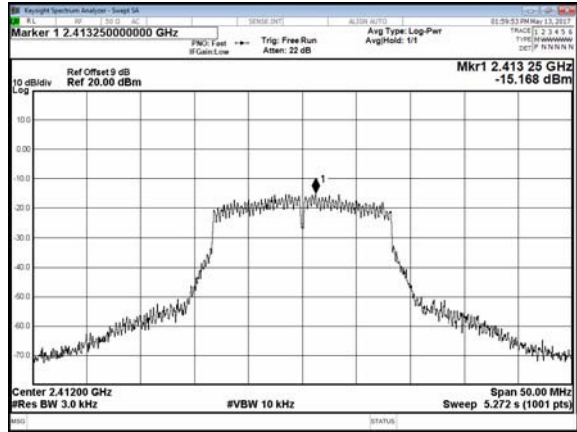

CH06

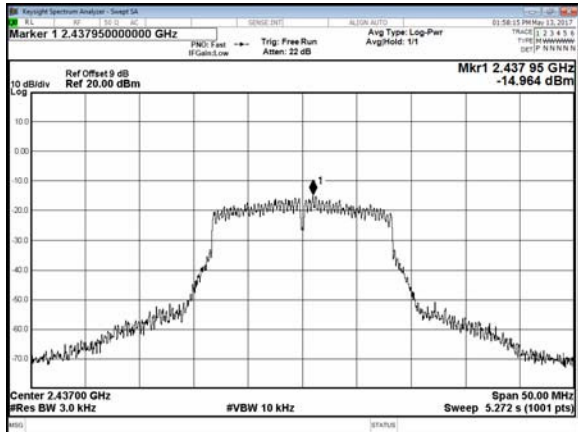

CH11

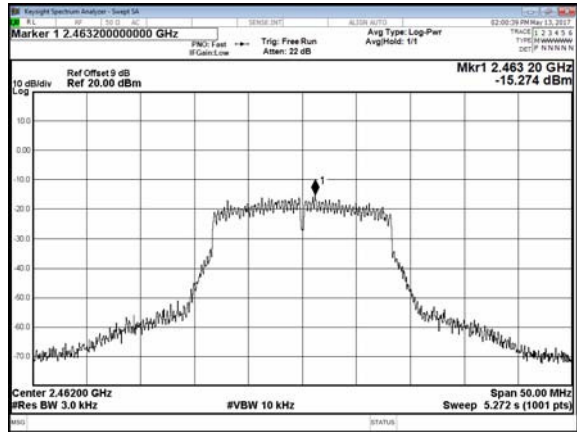



Modulation Type: 802.11n HT20
CH01

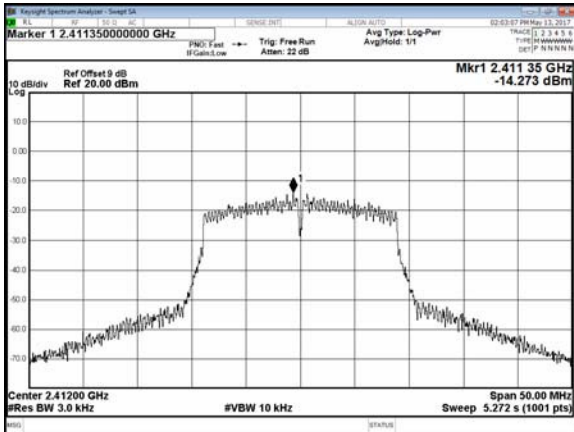

CH06

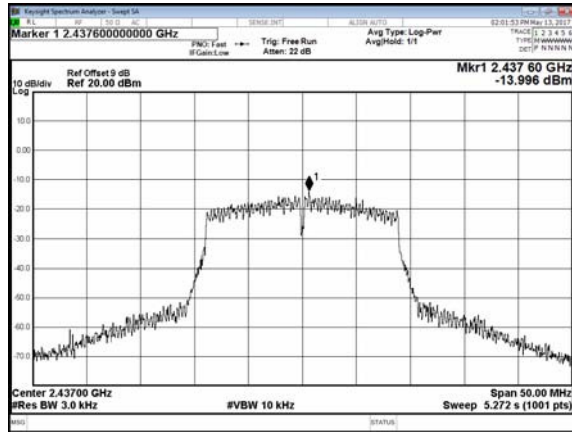

CH11

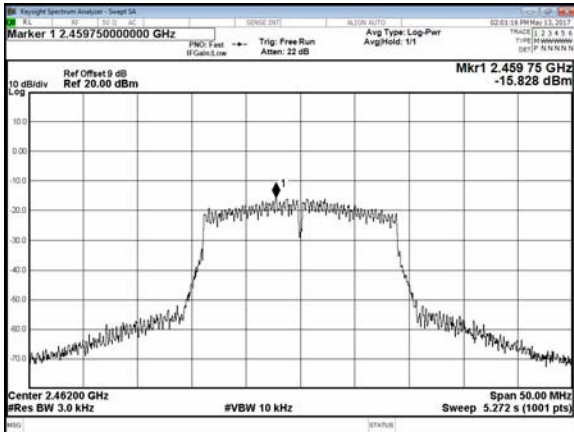

Modulation Type: 802.11n HT40
CH03

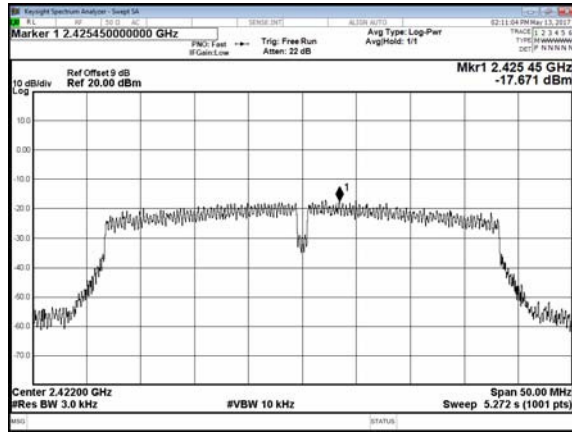

CH06

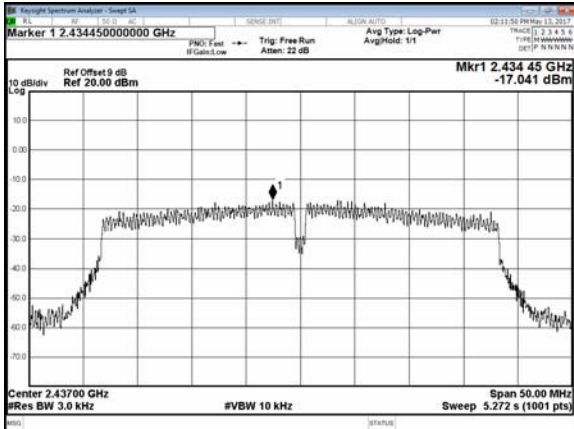

CH09

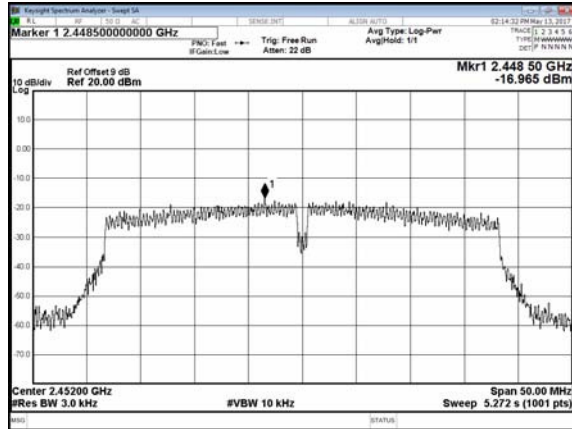



Antenna 1+2
Antenna 1
Modulation Type: 802.11n HT20
CH01

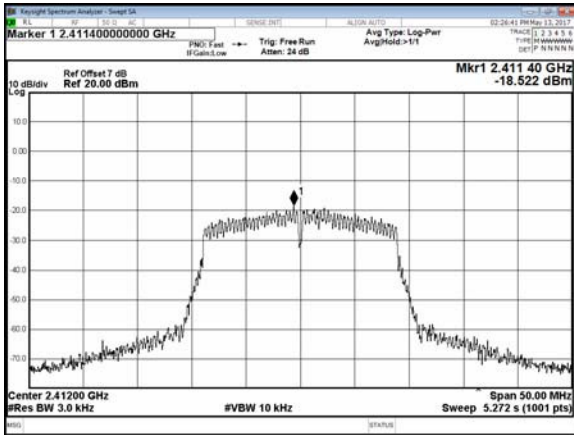

CH06

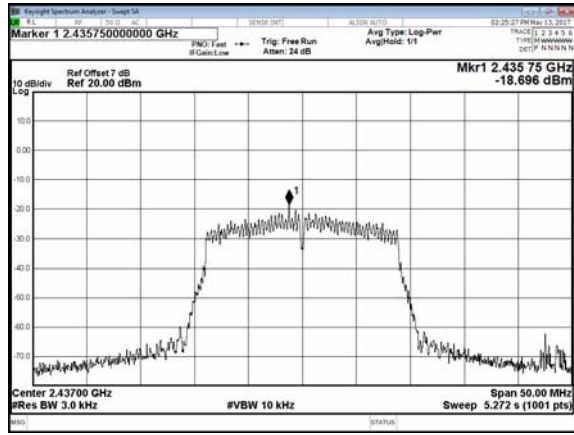

Modulation Type: 802.11n HT40
CH03

CH11

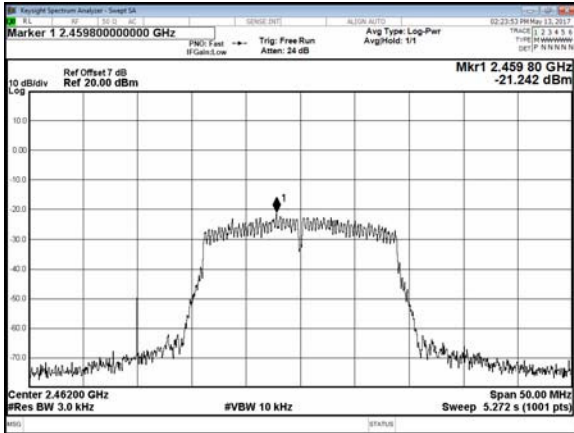

CH03

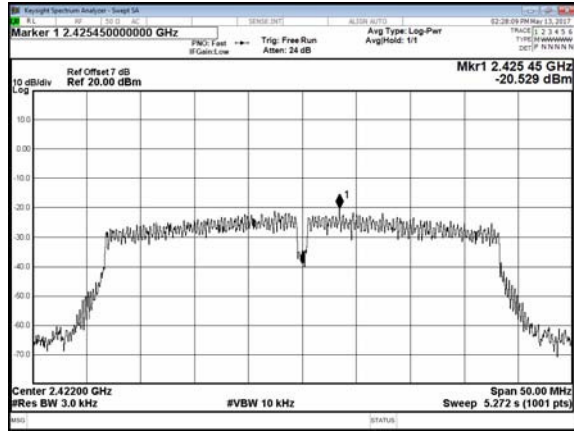

CH06

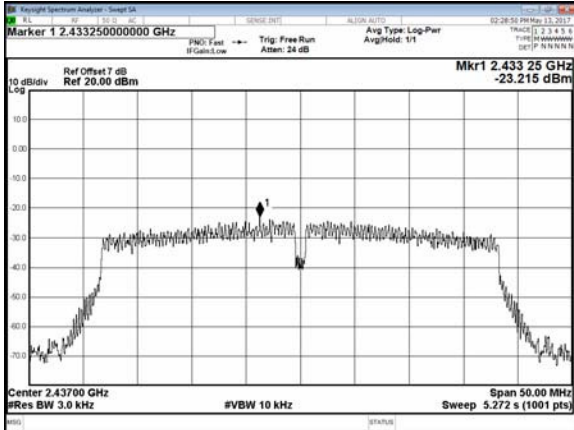

CH09

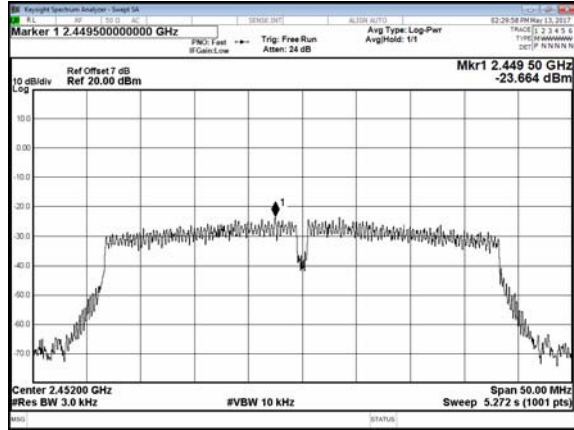



Antenna 2
Modulation Type: 802.11n HT20
CH01

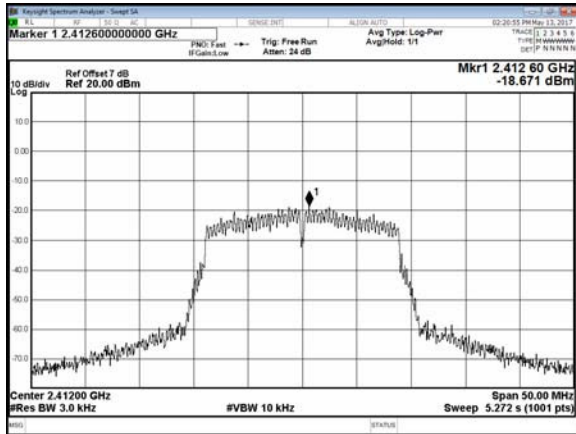

CH06

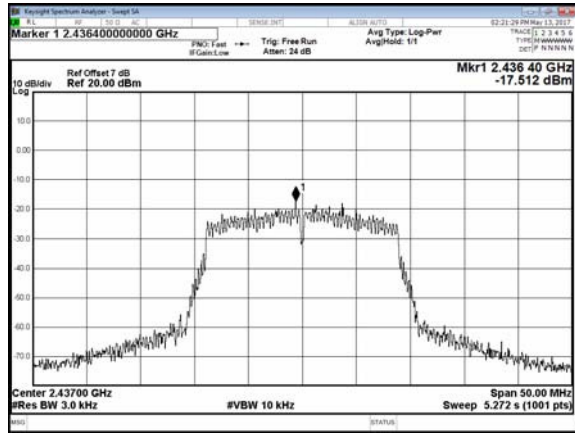

CH11

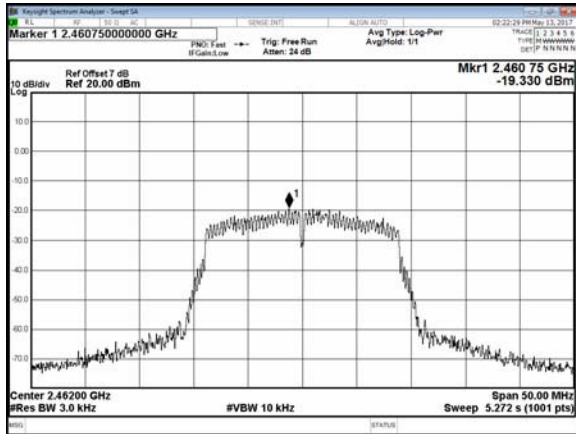

Modulation Type: 802.11n HT40
CH03

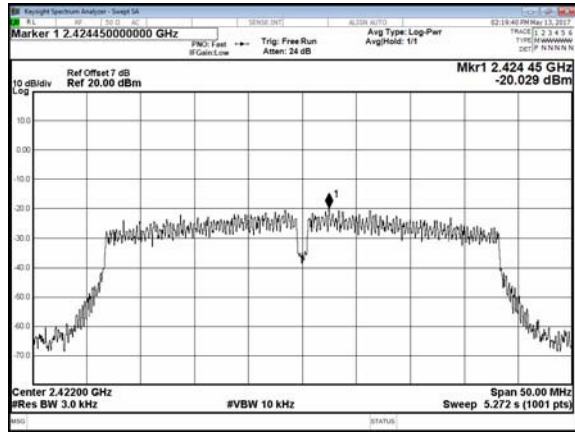

CH06

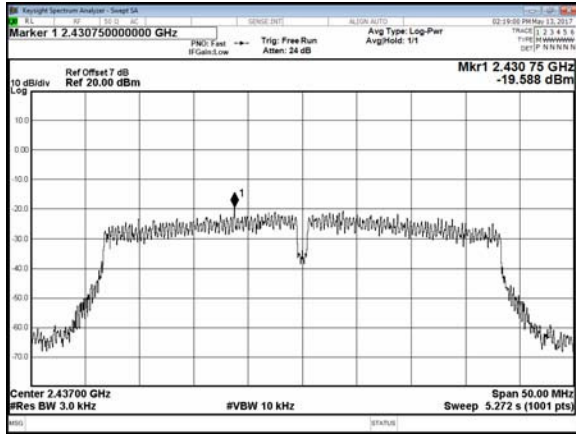

CH09

