SAR Test Report

Report No.: AGC08326170101FH01

FCC ID : 2AKZSM-1200S
APPLICATION PURPOSE : Original Equipment
PRODUCT DESIGNATION : Wireless USB Adapter
BRAND NAME : N/A
MODEL NAME : M-1200M
CLIENT : Shenzhen Xunman Technology Co., Ltd.
DATE OF ISSUE : Mar. 11,2017
STANDARD(S) : IEEE Std. 1528:2013
: FCC 47CFR § 2.1093
: IEEE/ANSI C95.1:2005
REPORT VERSION : V1.0

Attestation of Global Compliance (Shenzhen) Co., Ltd.



CAUTION:

This report shall not be reproduced except in full without the written permission of the test laboratory and shall not be quoted out of context.



Report Revise Record

Report Version	Revise Time	Issued Date	Valid Version	Notes
V1.0	/	Mar. 11,2017	Valid	Original Report

Test Report Certification

Applicant Name	:	Shenzhen Xunman Technology Co., Ltd.
Applicant Address	:	2/F., #3 Building, New Development Zone, Baishixia, Fuyong St., Baoan Dist., Shenzhen, China
Manufacturer Name	:	Shenzhen Xunman Technology Co., Ltd.
Manufacturer Address	:	2/F., #3 Building, New Development Zone, Baishixia, Fuyong St., Baoan Dist., Shenzhen, China
Product Designation	:	Wireless USB Adapter
Brand Name	:	N/A
Model Name	:	M-1200M
Different Description	:	N/A
EUT Voltage	:	DC5.0V
Applicable Standard	:	IEEE Std. 1528:2013 FCC 47CFR § 2.1093 IEEE/ANSI C95.1:2005
Test Date	:	Mar. 03,2017 to Mar. 06,2017
Performed Location	:	Attestation of Global Compliance(Shenzhen) Co., Ltd.
	:	2 F, Building 2, No.1-No.4, Chaxi Sanwei Technical Industrial Park, Gushu, Xixiang Street, Bao'an District, Shenzhen, China
Report Template	:	AGCRT-US-5G/SAR (2016-01-01)

Judy Xie

Tested By _____

Judy Xie(Xie Fan)

Mar. 06,2017

Angela Li

Checked By _____

Angela Li(Li Jiao)

Mar. 11,2017

Solger Zhang

Authorized By _____

Solger Zhang(Zhang Hongyi)

Mar. 11,2017

Authorized Officer

TABLE OF CONTENTS

1. SUMMARY OF MAXIMUM SAR VALUE	5
2. GENERAL INFORMATION.....	6
2.1. EUT DESCRIPTION.....	6
3. SAR MEASUREMENT SYSTEM.....	7
3.1. SATIMO SYSTEM DESCRIPTION	7
3.2. COMOSAR E-FIELD PROBE	8
3.3. ROBOT.....	9
3.4. VIDEO POSITIONING SYSTEM	9
3.5. DEVICE HOLDER	10
3.6. SAM TWIN PHANTOM.....	11
4. SAR MEASUREMENT PROCEDURE.....	12
4.1. SPECIFIC ABSORPTION RATE (SAR).....	12
4.2. SAR MEASUREMENT PROCEDURE	13
4.3. RF EXPOSURE CONDITIONS	15
5. TISSUE SIMULATING LIQUID	16
5.1. THE COMPOSITION OF THE TISSUE SIMULATING LIQUID(BY WEIGHT %)	16
5.2. TISSUE DIELECTRIC PARAMETERS FOR HEAD AND BODY PHANTOMS	16
5.3. TISSUE CALIBRATION RESULT	17
6. SAR SYSTEM CHECK&VALIDATION PROCEDURE	18
6.1. SAR SYSTEM CHECK PROCEDURES	18
6.2. SAR SYSTEM CHECK.....	19
7. EUT TEST POSITION	21
7.1. BODY PART POSITION	21
8. SAR EXPOSURE LIMITS	24
9. TEST EQUIPMENT LIST	25
10. MEASUREMENT UNCERTAINTY	26
11. CONDUCTED POWER MEASUREMENT.....	32
12. TEST RESULTS	34
12.1. OPERATION MODE.....	34
12.2. TEST RESULT	35
APPENDIX A. SAR SYSTEM CHECK DATA	38
APPENDIX B. SAR MEASUREMENT DATA.....	42
APPENDIX C. TEST SETUP PHOTOGRAPHS &EUT PHOTOGRAPHS.....	58
APPENDIX D. CALIBRATION DATA	58

1. SUMMARY OF MAXIMUM SAR VALUE

The maximum results of Specific Absorption Rate (SAR) found during testing for EUT are as follows:

Highest Reported SAR :

Exposure Antenna	Frequency Band(MHz)	Highest Reported 1g-SAR(W/Kg)
Antenna 0	2.4 GHz	0.415
	5.2 GHz	0.384
Antenna 1	2.4 GHz	0.758
	5.2 GHz	0.218
Antenna 0 + Antenna 1	5.2 GHz	0.577

This device is compliance with Specific Absorption Rate (SAR) for general population/uncontrolled exposure limits (1.6W/Kg) specified in IEEE Std. 1528:2013; FCC 47CFR § 2.1093; IEEE/ANSI C95.1:2005 and the following specific FCC Test Procedures:

and the following specific FCC Test Procedures:

- KDB 447498 D01 General RF Exposure Guidance v06
- KDB 447498 D02 SAR Procedures for Dongle Xmtr v02r01
- KDB 865664 D01 SAR measurement 100 MHz to 6 GHz v01r04
- KDB 248227 D01 802 11 Wi-Fi SAR v02r02

2. GENERAL INFORMATION

2.1. EUT Description

General Information	
Product Designation	Wireless USB Adapter
Test Model	M-1200M
Hardware Version	V1.0
Software Version	V1.0
Device Category	Portable
RF Exposure Environment	Uncontrolled
Antenna Type	External Antenna
2.4 GHz WIFI	
Operation Frequency	2.412 GHz~2.462GHz
Type of modulation	DSSS(DBPSK/DQPSK/CCK);OFDM(BPSK/QPSK/16-QAM/64-QAM)
Output Power	IEEE 802.11b:15.76dBm; IEEE 802.11g:12.42dBm; IEEE 802.11n(20):15.27dBm; IEEE 802.11n(40):12.09dBm
Antenna Gain	5.0dBi
5 GHz WIFI	
Operation Frequency	5150 GHz~5250GHz; 5725 GHz~5825GHz
Type of modulation	BPSK, QPSK, 16QAM, 64QAM, 128QAM, 256QAM,OFDM
Output Power	IEEE 802.11a(20):10.54Bm IEEE 802.11n(40):10.08dBm; IEEE802.11n(20):12.70Bm IEEE802.11ac(20):12.47dBm IEEE802.11ac(40):10.51Bm EEE802.11ac(80):8.28dBm
Antenna Gain	5.0dBi

Note: The sample used for testing is end product.

Product	Type
	<input checked="" type="checkbox"/> Production unit <input type="checkbox"/> Identical Prototype

3. SAR MEASUREMENT SYSTEM

3.1. SATIMO System Description

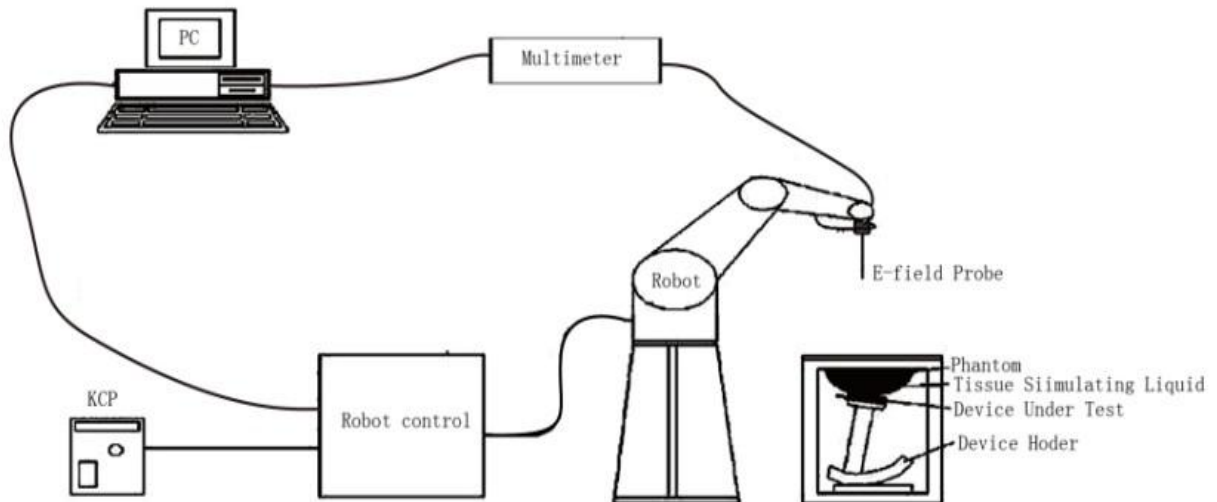

The COMOSAR system for performing compliance tests consists of the following items:

- The PC. It controls most of the bench devices and stores measurement data. A computer running WinXP and the Opensar software
- The E-Field probe. The probe is a 3-axis system made of 3 distinct dipoles. Each dipole returns a voltage in function of the ambient electric field.
- The Keithley multimeter measures each probe dipole voltages.
- The SAM phantom simulates a human head. The measurement of the electric field is made inside the phantom.
- The liquids simulate the dielectric properties of the human head tissues.
- The network emulator controls the mobile phone under test.
- The validation dipoles are used to measure a reference SAR. They are used to periodically check the bench to make sure that there is no drift of the system characteristics over time.
- The phantom, the device holder and other accessories according to the targeted measurement.

3.2. COMOSAR E-Field Probe

The SAR measurement is conducted with the dissymmetric probe manufactured by SATIMO. The probe is specially designed and calibrated for use in liquid with high permittivity. The dissymmetric probe has special calibration in liquid at different frequency. SATIMO conducts the probe calibration in compliance with international and national standards (e.g. IEEE 1528-2013 and relevant KDB files) Under ISO17025. The calibration data are in Appendix D.

Isotropic E-Field Probe Specification

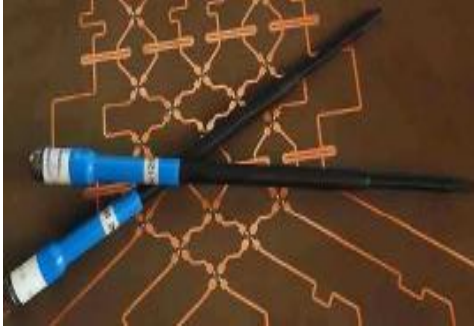
Model	SSE5	
Manufacture	MVG	
Identification No.	SN 14/16 EP307	
Frequency	0.7GHz-3GHz Linearity:±0.05dB(700MHz-3GHz)	
Dynamic Range	0.01W/Kg-100W/Kg Linearity:±0.05dB	
Dimensions	Overall length:330mm Length of individual dipoles:4.5mm Maximum external diameter:8mm Probe Tip external diameter:5mm Distance between dipoles/ probe extremity:2.7mm	
Application	High precision dosimetric measurements in any exposure scenario (e.g., very strong gradient fields). Only probe which enables compliance testing for frequencies up to 3 GHz with precision of better 30%.	

Model	SSE2	
Manufacture	MVG	
Identification No.	SN 08/16 EPGO282	
Frequency	0.7GHz-6GHz Linearity:±0.09dB(700MHz-6GHz)	
Dynamic Range	0.01W/Kg-100W/Kg Linearity:±0.09dB	
Dimensions	Overall length:330mm Length of individual dipoles:2mm Maximum external diameter:8mm Probe Tip external diameter:2.5mm Distance between dipoles/ probe extremity:1mm	
Application	High precision dosimetric measurements in any exposure scenario (e.g., very strong gradient fields). Only probe which enables compliance testing for frequencies up to 6 GHz with precision of better 30%.	

3.3. Robot

The COMOSAR system uses the KUKA robot from SATIMO SA (France). For the 6-axis controller COMOSAR system, the KUKA robot controller version from SATIMO is used.

The XL robot series have many features that are important for our application:

- High precision (repeatability 0.02 mm)
- High reliability (industrial design)
- Jerk-free straight movements
- Low ELF interference (the closed metallic construction shields against motor control fields)
- 6-axis controller



3.4. Video Positioning System

The video positioning system is used in OpenSAR to check the probe. Which is composed of a camera, LED, mirror and mechanical parts. The camera is piloted by the main computer with firewire link.

During the process, the actual position of the probe tip with respect to the robot arm is measured, as well as the probe length and the horizontal probe offset. The software then corrects all movements, such that the robot coordinates are valid for the probe tip.

The repeatability of this process is better than 0.1 mm. If a position has been taught with an aligned probe, the same position will be reached with another aligned probe within 0.1 mm, even if the other probe has different dimensions. During probe rotations, the probe tip will keep its actual position.

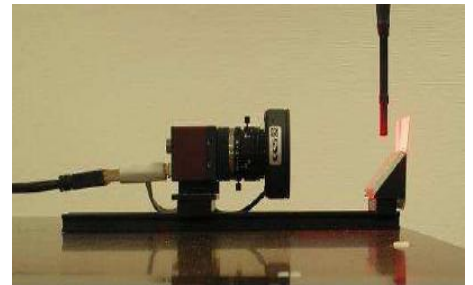

3.5. Device Holder

The COMOSAR device holder is designed to cope with different positions given in the standard. It has two scales for the device rotation (with respect to the body axis) and the device inclination (with respect to the line between the ear reference points). The rotation center for both scales is the ear reference point (EPR).

Thus the device needs no repositioning when changing the angles.

The COMOSAR device holder has been made out of low-loss POM material having the following dielectric parameters: relative permittivity

$\epsilon_r = 3$ and loss tangent $\delta = 0.02$. The amount of dielectric material has been reduced in the closest vicinity of the device, since measurements have suggested that the influence of the clamp on the test results could thus be lowered.

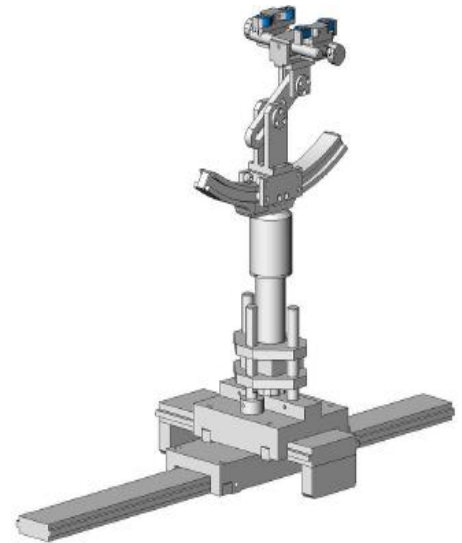

3.6. SAM Twin Phantom

The SAM twin phantom is a fiberglass shell phantom with 2mm shell thickness (except the ear region where shell thickness increases to 6mm). It has three measurement areas:

- Left head
- Right head
- Flat phantom



The bottom plate contains three pair of bolts for locking the device holder. The device holder positions are adjusted to the standard measurement positions in the three sections. A white cover is provided to tap the phantom during off-periods to prevent water evaporation and changes in the liquid parameters. On the phantom top, three reference markers are provided to identify the phantom position with respect to the robot.

4. SAR MEASUREMENT PROCEDURE

4.1. Specific Absorption Rate (SAR)

SAR is related to the rate at which energy is absorbed per unit mass in object exposed to a radio field. The SAR distribution in a biological body is complicated and is usually carried out by experimental techniques or numerical modeling. The standard recommends limits for two tiers of groups, occupational/controlled and occupational/uncontrolled, based on a person's awareness and ability to exercise control over his or her exposure. In general, occupational/controlled exposure limits are higher than the limits for general population/uncontrolled.

The SAR definition is the time derivative (rate) of the incremental energy (dW) absorbed by (dissipated in) an incremental mass (dm) contained in a volume element(dv) of given mass density (ρ). The equation description is as below:

$$SAR = \frac{d}{dt} \left(\frac{dW}{dm} \right) = \frac{d}{dt} \left(\frac{dW}{\rho dV} \right)$$

SAR is expressed in units of Watts per kilogram (W/Kg)

SAR can be obtained using either of the following equations:

$$SAR = \frac{\sigma E^2}{\rho}$$

$$SAR = c_h \left. \frac{dT}{dt} \right|_{t=0}$$

Where

SAR	is the specific absorption rate in watts per kilogram;
E	is the r.m.s. value of the electric field strength in the tissue in volts per meter;
σ	is the conductivity of the tissue in siemens per metre;
ρ	is the density of the tissue in kilograms per cubic metre;
c _h	is the heat capacity of the tissue in joules per kilogram and Kelvin;

$\left. \frac{dT}{dt} \right|_{t=0}$ is the initial time derivative of temperature in the tissue in kelvins per second

4.2. SAR Measurement Procedure

Step 1: Power Reference Measurement

The Power Reference Measurement and Power Drift Measurement are for monitoring the power drift of the device under test in the batch process. The minimum distance of probe sensors to surface is 2.7mm This distance cannot be smaller than the distance os sensor calibration points to probe tip as defined in the probe properties,

Step 2: Area Scan

The Area Scan is used as a fast scan in two dimensions to find the area of high field values, before doing a fine measurement around the hot spot. The sophisticated interpolation routines implemented in SATIMO software can find the maximum locations even in relatively coarse grids. When an Area Scan has measured all reachable points, it computes the field maximal found in the scanned area, within a range of the global maximum. The range (in db) is specified in the standards for compliance testing. For example, a 2db range is required in IEEE Standard 1528 and IEC62209 standards, whereby 3db is a requirement when compliance is assessed in accordance with the ARIB standard (Japan) If one Zoom Scan follows the Area Scan, then only the absolute maximum will be taken as reference. For cases where multiple maximum are detected, the number of Zoom Scan has to be increased accordingly.

Area Scan Parameters extracted from KDB 865664 D01 SAR Measurement 100MHz to 6GHz

	≤ 3 GHz	> 3 GHz
Maximum distance from closest measurement point (geometric center of probe sensors) to phantom surface	5 ± 1 mm	$\frac{1}{2} \cdot \delta \cdot \ln(2) \pm 0.5$ mm
Maximum probe angle from probe axis to phantom surface normal at the measurement location	30° ± 1°	20° ± 1°
Maximum area scan spatial resolution: Δx_{Area} , Δy_{Area}	≤ 2 GHz: ≤ 15 mm 2 – 3 GHz: ≤ 12 mm	3 – 4 GHz: ≤ 12 mm 4 – 6 GHz: ≤ 10 mm
	When the x or y dimension of the test device, in the measurement plane orientation, is smaller than the above, the measurement resolution must be ≤ the corresponding x or y dimension of the test device with at least one measurement point on the test device.	

Step 3: Zoom Scan

Zoom Scan are used to assess the peak spatial SAR value within a cubic average volume containing 1g abd 10g of simulated tissue. The Zoom Scan measures points(refer to table below) within a cube whose base faces are centered on the maxima found in a preceding area scan job within the same procedure. When the measurement is done, the Zoom Scan evaluates the averaged SAR for 1g and 10g and displays these values next to the job's label.

Zoom Scan Parameters extracted from KDB865664 d01 SAR Measurement 100MHz to 6GHz

Maximum zoom scan spatial resolution: Δx_{Zoom} , Δy_{Zoom}		≤ 2 GHz: ≤ 8 mm 2 – 3 GHz: ≤ 5 mm*	3 – 4 GHz: ≤ 5 mm* 4 – 6 GHz: ≤ 4 mm*
Maximum zoom scan spatial resolution, normal to phantom surface	uniform grid: $\Delta z_{Zoom}(n)$	≤ 5 mm	3 – 4 GHz: ≤ 4 mm 4 – 5 GHz: ≤ 3 mm 5 – 6 GHz: ≤ 2 mm
	graded grid	$\Delta z_{Zoom}(1)$: between 1 st two points closest to phantom surface	≤ 4 mm
		$\Delta z_{Zoom}(n>1)$: between subsequent points	$\leq 1.5 \cdot \Delta z_{Zoom}(n-1)$
Minimum zoom scan volume	x, y, z	≥ 30 mm	3 – 4 GHz: ≥ 28 mm 4 – 5 GHz: ≥ 25 mm 5 – 6 GHz: ≥ 22 mm
<p>Note: δ is the penetration depth of a plane-wave at normal incidence to the tissue medium; see draft standard IEEE P1528-2011 for details.</p> <p>* When zoom scan is required and the <i>reported</i> SAR from the <i>area scan based I-g SAR estimation</i> procedures of KDB 447498 is ≤ 1.4 W/kg, ≤ 8 mm, ≤ 7 mm and ≤ 5 mm zoom scan resolution may be applied, respectively, for 2 GHz to 3 GHz, 3 GHz to 4 GHz and 4 GHz to 6 GHz.</p>			

Step 4: Power Drift Measurement

The Power Drift Measurement measures the field at the same location as the most recent power reference measurement within the same procedure, and with the same settings. The Power Drift Measurement gives the field difference in dB from the reading conducted within the same settings. This allows a user to monitor the power drift of the device under test within a batch process. The measurement procedure is the same as Step 1.

4.3. RF Exposure Conditions

Test Configuration and setting:

For WLAN testing, the EUT is configured with the WLAN continuous TX tool through engineering command.

Antenna Location: (the top view)



5. TISSUE SIMULATING LIQUID

For SAR measurement of the field distribution inside the phantom, the phantom must be filled with homogeneous tissue simulating liquid to a depth of at least 15cm. For head SAR testing the liquid height from the ear reference point (ERP) of the phantom to the liquid top surface is larger than 15cm For body SAR testing, the liquid height from the center of the flat phantom to the liquid top surface is larger than 15cm. The nominal dielectric values of the tissue simulating liquids in the phantom and the tolerance of 5% are listed in 5.2

5.1. The composition of the tissue simulating liquid(by weight %)

Ingredient	2450MHz	5000MHz
(Weight)	Body (100%)	Body (100%)
Water	70%	80%
Salt	1%	0
DGBE	9%	10%
Triton X-100	20%	10%

5.2. Tissue Dielectric Parameters for Head and Body Phantoms

The head tissue dielectric parameters recommended by the IEEE 1528 have been incorporated in the following table. These head parameters are derived from planar layer models simulating the highest expected SAR for the dielectric properties and tissue thickness variations in a human head. Other head and body tissue parameters that have not been specified in IEEE 1528 are derived from the tissue dielectric parameters computed from the 4-Cole-Cole equations described in Reference [12] and extrapolated according to the head parameters specified in IEEE 1528.

Target Frequency (MHz)	head		body	
	ϵ_r	σ (S/m)	ϵ_r	σ (S/m)
300	45.3	0.87	58.2	0.92
450	43.5	0.87	56.7	0.94
835	41.5	0.90	55.2	0.97
900	41.5	0.97	55.0	1.05
915	41.5	1.01	55.0	1.06
1450	40.5	1.20	54.0	1.30
1610	40.3	1.29	53.8	1.40
1800–2000	40.0	1.40	53.3	1.52
2450	39.2	1.80	52.7	1.95
3000	38.5	2.40	52.0	2.73
5200	36.0	4.66	49.0	5.30
5600	35.5	5.07	48.5	5.77
5800	35.3	5.27	48.2	6.00

(ϵ_r = relative permittivity, σ = conductivity and $\rho = 1000$ kg/m³)

5.3. Tissue Calibration Result

The dielectric parameters of the liquids were verified prior to the SAR evaluation using SATIMO Dielectric Probe Kit and R&S Network Analyzer ZVL6.

Tissue Stimulant Measurement for 2450MHz					
Body	Fr. (MHz)	Dielectric Parameters ($\pm 5\%$)		Tissue Temp [$^{\circ}$ C]	Test time
		ϵ_r 52.7(50.065-55.335)	δ [s/m] 1.95(1.8525-2.0475)		
	2412	54.43	1.87	20.7	Mar. 06,2017
	2437	53.97	1.89		
	2450	53.12	1.90		
	2462	52.55	1.93		

Tissue Stimulant Measurement for 5800MHz					
Body	Fr. (MHz)	Dielectric Parameters ($\pm 5\%$)		Tissue Temp [$^{\circ}$ C]	Test time
		ϵ_r 49.0(44.1-53.9)	δ [s/m] 5.30(4.77-5.83)		
	5180	46.98	5.25	21.1	Mar. 03,2017
	5200	46.72	5.39		
	5240	46.01	5.53		

6. SAR SYSTEM CHECK&VALIDATION PROCEDURE

6.1. SAR System Check Procedures



SAR system check is required to confirm measurement accuracy, according to the tissue dielectric media, probe calibration points and other system operating parameters required for measuring the SAR of a test device. The system verification must be performed for each frequency band and within the valid range of each probe calibration point required for testing the device. The same SAR probe(s) and tissue-equivalent media combinations used with each specific SAR system for system verification must be used for device testing. When multiple probe calibration points are required to cover substantially large transmission bands, independent system verifications are required for each probe calibration point. A system verification must be performed before each series of SAR measurements using the same probe calibration point and tissue-equivalent medium. Additional system verification should be considered according to the conditions of the tissue-equivalent medium and measured tissue dielectric parameters, typically every three to four days when the liquid parameters are remeasured or sooner when marginal liquid parameters are used at the beginning of a series of measurements.

Each SATIMO system is equipped with one or more system check kits. These units, together with the predefined measurement procedures within the SATIMO software, enable the user to conduct the system check and system validation. System kit includes a dipole, and dipole device holder.

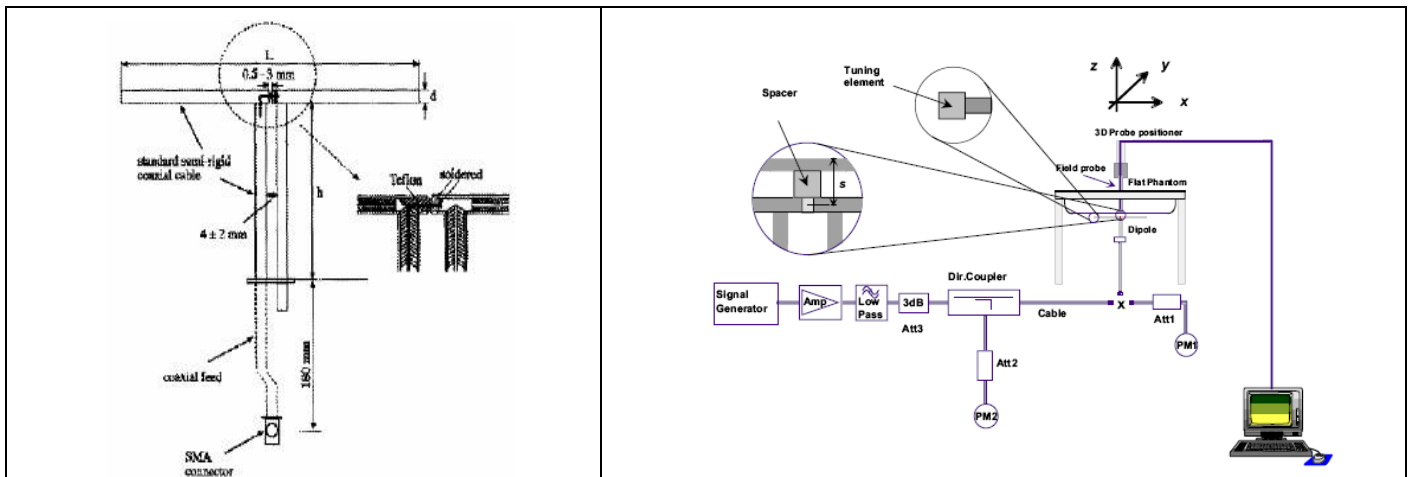
The system check verifies that the system operates within its specifications. It's performed daily or before every SAR measurement. The system check uses normal SAR measurement in the flat section of the phantom with a matched dipole at a specified distance. The system check setup is shown as below.

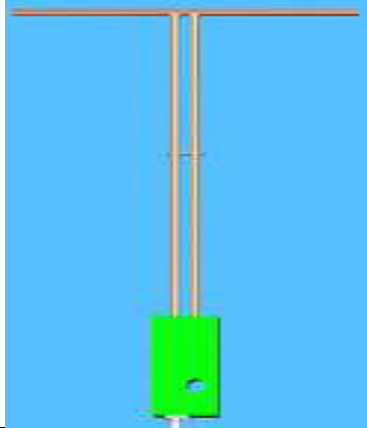

6.2. SAR System Check
6.2.1. Dipoles

	<p>The dipoles used is based on the IEEE-1528 standard, and is complied with mechanical and electrical specifications in line with the requirements of IEEE. the table below provides details for the mechanical and electrical Specifications for the dipoles.</p>
	<p>The wave guide is based on the IEEE-1528 standard, and is complied with mechanical and electrical specifications in line with the requirements of IEEE. the table below provides details for the mechanical and electrical Specifications for the dipoles.</p>

Frequency	L (mm)	h (mm)	d (mm)
2450MHz	51.5	30.4	3.6

Frequency	L (mm)	W (mm)	L _f (mm)	W _f (mm)
5000MHz	40.39	20.19	81.03	61.98

6.2.2. System Check Result

System Performance Check at 2450MHz & 5200MHz								
Validation Kit: SN 29/15DIP 2G450-393& SN 15/15 WGA 36								
Freq. [MHz]	Target Value(W/Kg)		Reference Result ($\pm 10\%$)		Normalized to 1 W (W/Kg)		Tissue Temp. [°C]	Test time
	1g	10g	1g	10g	1g	10g		
2450 Body	49.92	23.16	44.928-54.912	20.844-25.476	51.297	22.937	20.7	Mar. 06,2017
5200 Body	158.49	56.44	142.641-174.339	50.7-62.084	171.254	56.156	21.1	Mar. 03,2017

7. EUT TEST POSITION

This EUT was tested in **the bottom and the end of the dongle (opposite from the USB connector) with two antennas at roughly 90 degrees separately.**

7.1. Body Part Position

- (1) To position the EUT parallel to the phantom surface.
- (2) To adjust the EUT parallel to the flat phantom.
- (3) To adjust the distance between the EUT surface at the flat phantom to **5mm** while used in Bottom and **10mm** while used in the end of the dongle (opposite from the USB connector) with body liquid.

And a PAG procedure is request; The Response(No.: 626812) on 02/28/2017 is :







FCC response on 02/28/2017

Because of the unique shape and characteristics of this USB dongle, the normal SAR test procedures detailed in KDB 447498 DO2 will need to be amended in this instance. Typical use of this dongle inserted in a USB laptop port would entail the two antennas at roughly 90 degrees. Two SAR test positions for this device are appropriate with this typical use:



- 1] 5 mm separation from the flat phantom for the bottom of the dongle
- 2] 10 mm separation from the flat phantom for the end of the dongle (opposite from the USB connector)

Test each antenna individually using these two SAR test positions and then follow the simultaneous transmission evaluation procedures in KDB 648474 to sum the individual SAR values and/or use peak location separation ratios to determine if simultaneous transmission exclusion applies.



Antenna position relative to EUT-antenna 0

EUT Bottom		
Mode A (Horizontal with antenna 0°)	Mode B (Horizontal with antenna 90°)	Mode C (Perpendicular to the bottom surface, and downward rotate 90°)
		
EUT end of the dongle---edge 2		
Mode A (Horizontal with antenna 0°)	Mode B (Horizontal with antenna 90°)	Mode C (Horizontal with antenna 180°)
		

Antenna position relative to EUT-antenna 1

EUT Bottom		
Mode A (Horizontal with antenna 0°)	Mode B (Horizontal with antenna 90°)	Mode C (Perpendicular to the bottom surface, and downward rotate 90°)
		

EUT end of the dongle---edge 2

Mode A (Horizontal with antenna 0°)	Mode B (Horizontal with antenna 90°)	Mode C (Horizontal with antenna 180°)
		

8. SAR EXPOSURE LIMITS

SAR assessments have been made in line with the requirements of IEEE-1528, and comply with ANSI/IEEE C95.1-1992 “Uncontrolled Environments” limits. These limits apply to a location which is deemed as “Uncontrolled Environment” which can be described as a situation where the general public may be exposed to an RF source with no prior knowledge or control over their exposure.

Limits for General Population/Uncontrolled Exposure (W/kg)

Type Exposure	Uncontrolled Environment Limit (W/kg)
Spatial Peak SAR (1g cube tissue for brain or body)	1.60
Spatial Average SAR (Whole body)	0.08
Spatial Peak SAR (Limbs)	4.0

9. TEST EQUIPMENT LIST

Equipment description	Manufacturer/ Model	Identification No.	Current calibration date	Next calibration date
SAR Probe	MVG	SN 08/16 EPGO282	07/05/2016	07/04/2017
SAR Probe	MVG	SN 14/16 EP307	07/05/2016	07/04/2017
TISSUE Probe	SATIMO	SN 23/16 OCPG 75	07/05/2016	07/04/2017
Phantom	SATIMO	SN_4511_SAM90	Validated. No cal required.	Validated. No cal required.
Liquid	SATIMO	-	Validated. No cal required.	Validated. No cal required.
Dipole	SATIMO SID2450	SN29/15 DIP 2G450-393	07/05/2016	07/04/2019
Dipole	SWG5500	SN 15/15 WGA 36	07/05/2016	07/04/2019
Signal Generator	Agilent-E4438C	US41461365	02/27/2017	02/26/2018
Vector Analyzer	Agilent / E4440A	US40420298	07/02/2016	07/01/2017
Network Analyzer	Rhode & Schwarz ZVL6	SN100132	02/27/2017	02/26/2018
Attenuator	Warison /WATT-6SR1211	N/A	N/A	N/A
Attenuator	Mini-circuits / VAT-10+	N/A	N/A	N/A
Amplifier	EM30180	SN060552	03/04/2016	03/03/2017
Directional Couple	Werlatone/ C6026-10	SN99482	07/02/2016	07/01/2017
Power Sensor	NRP-Z21	1137.6000.02	10/10/2016	10/09/2017
Power Sensor	NRP-Z23	US38261498	02/27/2017	02/26/2018
Power Viewer	R&S	V2.3.1.0	N/A	N/A

Note: Per KDB 865664 Dipole SAR Validation, AGC Lab has adopted 3 years calibration intervals. On annual basis, every measurement dipole has been evaluated and is in compliance with the following criteria:

1. There is no physical damage on the dipole;
2. System validation with specific dipole is within 10% of calibrated value;
3. Return-loss is within 20% of calibrated measurement;
4. Impedance is within 5Ω of calibrated measurement.

10. MEASUREMENT UNCERTAINTY

SATIMO Uncertainty-SN 14/16 EP307									
Measurement uncertainty for DUT averaged over 1 gram / 10 gram.(Head)									
Uncertainty Component	Sec.	Tol (+- %)	Prob. Dist.	Div.	Ci (1g)	Ci (10g)	1g Ui (+-%)	10g Ui (+-%)	Vi
Measurement System									
Probe calibration	E.2.1	5.831	N	1	1	1	5.83	5.83	∞
Probe Modulation	E.2.5	3.0	R	$\sqrt{3}$	1	1	1.73	1.73	∞
Axial Isotropy	E.2.2	0.6	R	$\sqrt{3}$	1	1	0.36	0.35	∞
Hemispherical Isotropy	E.2.2	0.7	R	$\sqrt{3}$	1	1	0.40	0.40	∞
Boundary effect	E.2.3	1.0	R	$\sqrt{3}$	1	1	0.58	0.58	∞
Linearity	E.2.4	1.2	R	$\sqrt{3}$	1	1	0.69	0.69	∞
System detection limits	E.2.4	0.7	R	$\sqrt{3}$	1	1	0.40	0.40	∞
Readout Electronics	E.2.6	0.02	N	1	1	1	0.02	0.02	∞
Response Time	E.2.7	3.0	R	$\sqrt{3}$	1	1	1.73	1.73	∞
Integration Time	E.2.8	2.0	R	$\sqrt{3}$	1	1	1.15	1.15	∞
RF Ambient Noise	E.6.1	3.0	R	$\sqrt{3}$	1	1	1.73	1.73	∞
RF Ambient Reflection	E.6.1	3.0	R	$\sqrt{3}$	1	1	1.73	1.73	∞
Probe Positioner	E.6.2	2.0	R	$\sqrt{3}$	1	1	1.15	1.15	∞
Probe Positioning	E.6.3	0.05	R	$\sqrt{3}$	1	1	0.03	0.03	∞
Post-processing	E.5	5.0	R	$\sqrt{3}$	1	1	2.89	2.89	∞
Test sample Related									
Device Positioning	E.4.2	3.6	N	1	1	1	3.60	3.60	∞
Device Holder	E.4.1	2.9	N	1	1	1	2.90	2.90	∞
Measurement SAR Drift	E.2.9	5	R	$\sqrt{3}$	1	1	2.89	2.89	∞
Power Scaling	E.6.5	0	R	$\sqrt{3}$	1	1	0.00	0.00	∞
Phantom and set-up									
Phantom Uncertainty	E.3.1	0.05	R	$\sqrt{3}$	1	1	0.03	0.03	∞
Uncertainty in SAR correction for deviations in permittivity and conductivity	E.3.2	1.9	N	1	1	0.84	1.90	1.60	∞
Liquid Conductivity(Meas.)	E.3.3	5	N	1	0.78	0.71	3.90	3.55	M
Liquid Permittivity(Meas.)	E.3.3	5	N	1	0.23	0.26	1.15	1.30	M
Liquid Conductivity-temperature uncertainty	E.3.4	5	R	$\sqrt{3}$	0.78	0.71	2.25	2.05	∞
Liquid Permittivity-temperature uncertainty	E.3.4	5	R	$\sqrt{3}$	0.23	0.26	0.66	0.75	∞
Combined Standard Uncertainty			RSS				10.20	9.919	∞
Expanded Uncertainty (95% Confidence interval)			k				20.40	19.838	

SATIMO Uncertainty-SN 14/16 EP307									
System validation uncertainty for Dipole averaged over 1 gram / 10 gram. (Head)									
Uncertainty Component	Sec.	Tol (+-%)	Prob. Dist.	Div.	Ci (1g)	Ci (10g)	1g Ui (+-%)	10g Ui (+-%)	Vi
Measurement System									
Probe calibration	E.2.1	5.831	N	1	1	1	5.83	5.83	∞
Probe Modulation	E.2.5	3.0	R	$\sqrt{3}$	1	1	1.73	1.73	∞
Axial Isotropy	E.2.2	0.6	R	$\sqrt{3}$	1	1	1.44	1.44	∞
Hemispherical Isotropy	E.2.2	0.7	R	$\sqrt{3}$	1	1	0.40	0.40	∞
Boundary effect	E.2.3	1.0	R	$\sqrt{3}$	1	1	0.58	0.58	∞
Linearity	E.2.4	1.2	R	$\sqrt{3}$	1	1	0.69	0.69	∞
System detection limits	E.2.4	0.7	R	$\sqrt{3}$	1	1	0.40	0.40	∞
Readout Electronics	E.2.6	0.02	N	1	1	1	0.02	0.02	∞
Response Time	E.2.7	3.0	R	$\sqrt{3}$	1	1	1.73	1.73	∞
Integration Time	E.2.8	2.0	R	$\sqrt{3}$	1	1	1.15	1.15	∞
RF Ambient Noise	E.6.1	3.0	R	$\sqrt{3}$	1	1	1.73	1.73	∞
RF Ambient Reflection	E.6.1	3.0	R	$\sqrt{3}$	1	1	1.73	1.73	∞
Probe Positioner	E.6.1	2.0	R	$\sqrt{3}$	1	1	1.15	1.15	∞
Probe Positioning	E.6.2	0.05	R	$\sqrt{3}$	1	1	0.03	0.03	∞
Post-processing	E.6.3	5.0	R	$\sqrt{3}$	1	1	2.89	2.89	∞
System validation source (dipole)									
Deviation of exp. dipole	E6.4	5	R	1	1	1	5.00	5.00	∞
Dipole Axis to Liquid Dist.	8,E.6.6	4.7	R	$\sqrt{3}$	1	1	2.71	2.71	∞
Input power & SAR drift	8,6.6.4	1	R	$\sqrt{3}$	1	1	0.58	0.58	∞
Phantom and set-up									
Phantom Uncertainty	E.3.1	0.05	R	$\sqrt{3}$	1	1	0.03	0.03	∞
Uncertainty in SAR correction for deviations in permittivity and conductivity	E.3.2	1.9	N	1	1	0.84	1.90	1.60	∞
Liquid Conductivity(Meas.)	E.3.3	5	N	1	0.78	0.71	3.90	3.55	M
Liquid Permittivity(Meas.)	E.3.3	5	N	1	0.23	0.26	1.15	1.30	M
Liquid Conductivity-temperature uncertainty	E.3.4	5	R	$\sqrt{3}$	0.78	0.71	2.25	2.05	∞
Liquid Permittivity-temperature uncertainty	E.3.4	5	R	$\sqrt{3}$	0.23	0.26	0.66	0.75	∞
Combined Standard Uncertainty			RSS				10.34	10.069	∞
Expanded Uncertainty (95% Confidence interval)			k				20.69	20.137	

SATIMO Uncertainty-SN 14/16 EP307									
System Check uncertainty for Dipole averaged over 1 gram / 10 gram.(Head)									
Uncertainty Component	Sec.	Tol (+- %)	Prob. Dist.	Div.	Ci (1g)	Ci (10g)	1g Ui (+-%)	10g Ui (+-%)	Vi
Measurement System									
Modulation response	E.2.5	3.0	R	$\sqrt{3}$	0	0	0.00	0.00	∞
Boundary effect	E.2.3	1.0	R	$\sqrt{3}$	0	0	0.00	0.00	∞
System detection limits	E.2.4	0.7	R	$\sqrt{3}$	0	0	0.00	0.00	∞
Readout Electronics	E.2.6	0.02	N	1	0	0	0.00	0.00	∞
Response Time	E.2.7	3.0	R	$\sqrt{3}$	0	0	0.00	0.00	∞
Integration Time	E.2.8	2.0	R	$\sqrt{3}$	0	0	0.00	0.00	∞
RF Ambient Noise	E.6.1	3.0	R	$\sqrt{3}$	0	0	0.00	0.00	∞
RF Ambient Reflection	E.6.1	3.0	R	$\sqrt{3}$	0	0	0.00	0.00	∞
Probe Positioner	E.6.1	2.0	R	$\sqrt{3}$	1	1	1.15	1.15	∞
Probe Positioning	E.6.2	0.05	R	$\sqrt{3}$	1	1	0.03	0.03	∞
Post-processing	E.6.3	5.0	R	$\sqrt{3}$	0	0	0.00	0.00	∞
Field source									
Deviation of exp. dipole	E6.4	5	R	1	1	1	5.00	5.00	∞
Dipole Axis to Liquid Dist.	8,E.6.6	4.7	R	$\sqrt{3}$	1	1	2.71	2.71	∞
Input power & SAR drift	8,6.6.4	1	R	$\sqrt{3}$	1	1	0.58	0.58	∞
Phantom and set-up									
Phantom Uncertainty	E.3.1	0.05	R	$\sqrt{3}$	1	1	0.03	0.03	∞
Uncertainty in SAR correction for deviations in permittivity and conductivity	E.3.2	1.9	N	1	1	0.84	1.90	1.60	∞
Liquid Conductivity(Meas.)	E.3.3	5	N	1	0.78	0.71	3.90	3.55	M
Liquid Permittivity(Meas.)	E.3.3	5	N	1	0.23	0.26	1.15	1.30	M
Liquid Conductivity-temperature uncertainty	E.3.4	5	R	$\sqrt{3}$	0.78	0.71	2.25	2.05	∞
Liquid Permittivity-temperature uncertainty	E.3.4	5	R	$\sqrt{3}$	0.23	0.26	0.66	0.75	∞
Combined Standard Uncertainty			RSS				7.076	6.667	∞
Expanded Uncertainty (95% Confidence interval)			k				14.152	13.334	

SATIMO Uncertainty									
Measurement uncertainty for DUT averaged over 1 gram / 10 gram.									
Uncertainty Component	Sec.	Tol (+-%)	Prob. Dist.	Div.	Ci (1g)	Ci (10g)	1g Ui (+-%)	10g Ui (+-%)	Vi
Measurement System									
Probe calibration	E.2.1	5.831	N	1	1	1	5.83	5.83	∞
Probe Modulation	E.2.5	3.0	R	$\sqrt{3}$	1	1	1.73	1.73	∞
Axial Isotropy	E.2.2	0.6	R	$\sqrt{3}$	1	1	0.35	0.35	∞
Hemispherical Isotropy	E.2.2	0.9	R	$\sqrt{3}$	1	1	0.52	0.52	∞
Boundary effect	E.2.3	1.0	R	$\sqrt{3}$	1	1	0.58	0.58	∞
Linearity	E.2.4	1.95	R	$\sqrt{3}$	1	1	1.13	1.13	∞
System detection limits	E.2.4	0.9	R	$\sqrt{3}$	1	1	0.52	0.52	∞
Readout Electronics	E.2.6	0.02	N	1	1	1	0.02	0.02	∞
Response Time	E.2.7	3.0	R	$\sqrt{3}$	1	1	1.73	1.73	∞
Integration Time	E.2.8	2.0	R	$\sqrt{3}$	1	1	1.15	1.15	∞
RF Ambient Noise	E.6.1	3.0	R	$\sqrt{3}$	1	1	1.73	1.73	∞
RF Ambient Reflection	E.6.1	3.0	R	$\sqrt{3}$	1	1	1.73	1.73	∞
Probe Positioner	E.6.2	2.0	R	$\sqrt{3}$	1	1	1.15	1.15	∞
Probe Positioning	E.6.3	0.05	R	$\sqrt{3}$	1	1	0.03	0.03	∞
Post-processing	E.5	5.0	R	$\sqrt{3}$	1	1	2.89	2.89	∞
Test sample Related									
Device Positioning	E.4.2	5	R	1	1	1	5.00	5.00	∞
Device Holder	E.4.1	4.7	R	$\sqrt{3}$	1	1	2.71	2.71	∞
Measurement SAR Drift	E.2.9	1	R	$\sqrt{3}$	1	1	0.58	0.58	∞
Phantom and set-up									
Phantom Uncertainty	E.3.1	0.05	R	$\sqrt{3}$	1	1	0.03	0.03	∞
Uncertainty in SAR correction for deviations in permittivity and conductivity	E.3.2	1.9	N	1	1	0.84	1.90	1.60	∞
Liquid Conductivity(Meas.)	E.3.3	5	N	1	0.78	0.71	3.90	3.55	M
Liquid Permittivity(Meas.)	E.3.3	5	N	1	0.23	0.26	1.15	1.30	M
Liquid Conductivity-temperature uncertainty	E.3.4	5	R	$\sqrt{3}$	0.78	0.71	2.25	2.05	∞
Liquid Permittivity-temperature uncertainty	E.3.4	5	R	$\sqrt{3}$	0.23	0.26	0.66	0.75	∞
Combined Standard Uncertainty			RSS				11.08	10.822	∞
Expanded Uncertainty (95% Confidence interval)			k				22.16	21.643	

SATIMO Uncertainty									
System validation uncertainty for Dipole averaged over 1 gram / 10 gram.									
Uncertainty Component	Sec.	Tol (+-%)	Prob. Dist.	Div.	Ci (1g)	Ci (10g)	1g Ui (+-%)	10g Ui (+-%)	Vi
Measurement System									
Probe calibration	E.2.1	5.831	N	1	1	1	5.83	5.83	∞
Probe Modulation	E.2.5	3.0	R	$\sqrt{3}$	1	1	1.73	1.73	∞
Axial Isotropy	E.2.2	0.6	R	$\sqrt{3}$	1	1	1.44	1.44	∞
Hemispherical Isotropy	E.2.2	0.7	R	$\sqrt{3}$	1	1	2.31	2.31	∞
Boundary effect	E.2.3	1.0	R	$\sqrt{3}$	1	1	0.58	0.58	∞
Linearity	E.2.4	1.2	R	$\sqrt{3}$	1	1	0.69	0.69	∞
System detection limits	E.2.4	0.7	R	$\sqrt{3}$	1	1	0.40	0.40	∞
Readout Electronics	E.2.6	0.02	N	1	1	1	0.02	0.02	∞
Response Time	E.2.7	3.0	R	$\sqrt{3}$	1	1	1.73	1.73	∞
Integration Time	E.2.8	2.0	R	$\sqrt{3}$	1	1	1.15	1.15	∞
RF Ambient Noise	E.6.1	3.0	R	$\sqrt{3}$	1	1	1.73	1.73	∞
RF Ambient Reflection	E.6.1	3.0	R	$\sqrt{3}$	1	1	1.73	1.73	∞
Probe Positioner	E.6.1	2.0	R	$\sqrt{3}$	1	1	1.15	1.15	∞
Probe Positioning	E.6.2	0.05	R	$\sqrt{3}$	1	1	0.03	0.03	∞
Post-processing	E.6.3	5.0	R	$\sqrt{3}$	1	1	2.89	2.89	∞
System validation source (dipole)									
Deviation of exp. dipole	E6.4	5	R	1	1	1	5.00	5.00	∞
Dipole Axis to Liquid Dist.	8,E.6.6	4.7	R	$\sqrt{3}$	1	1	2.71	2.71	∞
Input power & SAR drift	8,6.6.4	1	R	$\sqrt{3}$	1	1	0.58	0.58	∞
Phantom and set-up									
Phantom Uncertainty	E.3.1	0.05	R	$\sqrt{3}$	1	1	0.03	0.03	∞
Uncertainty in SAR correction for deviations in permittivity and conductivity	E.3.2	1.9	N	1	1	0.84	1.90	1.60	∞
Liquid Conductivity(Meas.)	E.3.3	5	N	1	0.78	0.71	3.90	3.55	M
Liquid Permittivity(Meas.)	E.3.3	5	N	1	0.23	0.26	1.15	1.30	M
Liquid Conductivity-temperature uncertainty	E.3.4	5	R	$\sqrt{3}$	0.78	0.71	2.25	2.05	∞
Liquid Permittivity-temperature uncertainty	E.3.4	5	R	$\sqrt{3}$	0.23	0.26	0.66	0.75	∞
Combined Standard Uncertainty			RSS				10.34	10.069	∞
Expanded Uncertainty (95% Confidence interval)			k				20.69	20.137	

SATIMO Uncertainty									
System Check uncertainty for Dipole averaged over 1 gram / 10 gram.									
Uncertainty Component	Sec.	Tol (+- %)	Prob. Dist.	Div.	Ci (1g)	Ci (10g)	1g Ui (+-%)	10g Ui (+-%)	Vi
Measurement System									
Modulation response	E.2.5	3.0	R	$\sqrt{3}$	0	0	0.00	0.00	∞
Boundary effect	E.2.3	1.0	R	$\sqrt{3}$	0	0	0.00	0.00	∞
System detection limits	E.2.4	0.7	R	$\sqrt{3}$	0	0	0.00	0.00	∞
Readout Electronics	E.2.6	0.02	N	1	0	0	0.00	0.00	∞
Response Time	E.2.7	3.0	R	$\sqrt{3}$	0	0	0.00	0.00	∞
Integration Time	E.2.8	2.0	R	$\sqrt{3}$	0	0	0.00	0.00	∞
RF Ambient Noise	E.6.1	3.0	R	$\sqrt{3}$	0	0	0.00	0.00	∞
RF Ambient Reflection	E.6.1	3.0	R	$\sqrt{3}$	0	0	0.00	0.00	∞
Probe Positioner	E.6.1	2.0	R	$\sqrt{3}$	1	1	1.15	1.15	∞
Probe Positioning	E.6.2	0.05	R	$\sqrt{3}$	1	1	0.03	0.03	∞
Post-processing	E.6.3	5.0	R	$\sqrt{3}$	0	0	0.00	0.00	∞
Field source									
Deviation of exp. dipole	E6.4	5	R	1	1	1	5.00	5.00	∞
Dipole Axis to Liquid Dist.	8,E.6.6	4.7	R	$\sqrt{3}$	1	1	2.71	2.71	∞
Input power & SAR drift	8,6.6.4	1	R	$\sqrt{3}$	1	1	0.58	0.58	∞
Phantom and set-up									
Phantom Uncertainty	E.3.1	0.05	R	$\sqrt{3}$	1	1	0.03	0.03	∞
Uncertainty in SAR correction for deviations in permittivity and conductivity	E.3.2	1.9	N	1	1	0.84	1.90	1.60	∞
Liquid Conductivity(Meas.)	E.3.3	5	N	1	0.78	0.71	3.90	3.55	M
Liquid Permittivity(Meas.)	E.3.3	5	N	1	0.23	0.26	1.15	1.30	M
Liquid Conductivity-temperature uncertainty	E.3.4	5	R	$\sqrt{3}$	0.78	0.71	2.25	2.05	∞
Liquid Permittivity-temperature uncertainty	E.3.4	5	R	$\sqrt{3}$	0.23	0.26	0.66	0.75	∞
Combined Standard Uncertainty			RSS				7.076	6.667	∞
Expanded Uncertainty (95% Confidence interval)			k				14.152	13.334	

11. CONDUCTED POWER MEASUREMENT

2.4GHz WIFI

Mode	Data Rate (Mbps)	Channel	Frequency (MHz)	Average Power Chain 0 (dBm)	Average Power Chain 1 (dBm)	Average Power Total (dBm)
802.11b	1	01	2412	15.42	15.03	--
		06	2437	15.76	15.24	--
		11	2462	15.61	15.18	--
802.11g	6	01	2412	11.88	11.37	--
		06	2437	12.42	11.79	--
		11	2462	12.18	11.64	--
802.11n(20)	6.5	01	2412	11.77	11.35	14.58
		06	2437	12.35	11.95	15.16
		11	2462	12.46	12.06	15.27
802.11n(40)	13.5	03	2422	8.45	8.11	11.29
		06	2437	8.84	8.37	11.62
		09	2452	9.24	8.91	12.09

5G WIFI

Mode	Channel	Frequency (MHz)	Avg. Burst Power (dBm)		
			Antenna 0	Antenna 1	Total
802.11a20	36	5180	10.35	9.86	--
	40	5200	10.22	9.41	--
	48	5240	10.54	9.99	--
	149	5745	8.23	7.95	--
	157	5785	8.03	7.10	--
	165	5825	8.86	8.25	--
802.11N20	36	5180	9.75	9.62	12.70
	40	5200	9.14	8.46	12.03
	48	5240	9.35	8.89	12.14
	149	5745	8.64	8.47	11.57
	157	5785	8.52	8.01	11.41
	165	5825	8.94	8.42	11.70
802.11N40	38	5190	7.14	6.94	10.05
	46	5230	7.28	6.85	10.08
	151	5755	6.31	5.95	9.14
	159	5795	6.25	5.98	9.13
802.11ac20	36	5180	9.68	9.22	12.47
	40	5200	8.15	8.06	11.36
	48	5240	8.88	8.37	11.64
	149	5745	8.76	8.55	11.67
	155	5775	8.54	8.26	11.13
	165	5825	8.69	8.51	11.61
802.11ac40	38	5190	7.75	7.24	10.51
	46	5230	7.61	7.15	10.40
	151	5755	6.42	6.11	9.28
	159	5795	6.32	5.88	9.12
802.11ac80	42	5210	5.42	5.12	8.28
	155	5775	4.62	4.09	7.37

12. TEST RESULTS

12.1. Operation Mode

1. Per KDB 447498 D01 v06 ,for each exposure position, if the highest 1-g SAR is ≤ 0.8 W/kg, testing for low and high channel is optional.
2. Per KDB 865664 D01 v01r04,for each frequency band, if the measured SAR is ≥ 0.8 W/Kg, testing for repeated SAR measurement is required , that the highest measured SAR is only to be tested. When the SAR results are near the limit, the following procedures are required for each device to verify these types of SAR measurement related variation concerns by repeating the highest measured SAR configuration in each frequency band.
 - (1) When the original highest measured SAR is ≥ 0.8 W/Kg, repeat that measurement once.
 - (2) Perform a second repeated measurement only if the ratio of largest to smallest SAR for the original and first repeated measurements is > 1.20 or when the original or repeated measurement is ≥ 1.45 W/Kg.
 - (3) Perform a third repeated measurement only if the original, first and second repeated measurement is ≥ 1.5 W/Kg and ratio of largest to smallest SAR for the original, first and second measurement is ≥ 1.20 .
3. Maximum Scaling SAR in order to calculate the Maximum SAR values to test under the standard Peak Power, Calculation method is as follows:
Maximum Scaling SAR =tested SAR (Max.) \times [maximum turn-up power (mw)/ maximum measurement output power(mw)]
4. Per KDB 248227 D01 v02r02 Chapter 5.2.2,when SAR measurement is required for 2.4GHz 802.11g/n OFDM configurations, the measurement and test reducing procedures for OFDM are applied. SAR is not required for the following 2.4 GHz OFDM conditions.
 - (1) When KDB Publication 447498 D01 SAR test exclusion applies to the OFDM configuration.
 - (2) When the highest reported SAR for DSSS is adjusted by the ratio of OFDM to DSSS specified maximum output power and the adjusted SAR is ≤ 1.2 W/Kg,
5. Per KDB 248227 D01 v02r02 Chapter 5.3.4, SAR measurement requirements for the remaining 802.11 transmission mode configurations that have not been tested in the initial test configuration are determined separately for each standalone and aggregated frequency band, in each exposure condition, according to the maximum output power specified for production units. The initial test position procedure is applied to next to the ear, UMPC mini-tablet and hotspot mode configurations. When the same maximum output power is specified for multiple transmission modes, the procedures in 5.3.2 are applied to determine the test configuration. Additional power measurements may be required to determine if SAR measurements are required for subsequent highest output power channels in a subsequent test configuration. The subsequent test configuration and SAR measurement procedures are described in the following.
 - (1) When SAR test exclusion provisions of KDB Publication 447498 D01 are applicable and SAR measurement is not required for the initial test configuration, SAR is also not required for the next highest maximum output power transmission mode subsequent test configuration(s) in that frequency band or aggregated band and exposure configuration.
 - (2) When the highest reported SAR for the initial test configuration (when applicable, include subsequent highest output channels), according to the initial test position or fixed exposure position requirements, is adjusted by the ratio of the subsequent test configuration to initial test configuration specified maximum output power and the adjusted SAR is ≤ 1.2 W/kg, SAR is not required for that subsequent test configuration.

12.2. Test Result

SAR MEASUREMENT-Antenna 0								
Depth of Liquid (cm):>15								
Product: Wireless USB Adapter				Test Model: M-1200M				
Position	Ch.	Fr. (MHz)	Power Drift (<±5%)	SAR (1g) (W/kg)	Max. Tune -up Power (dBm)	Meas. output Power (dBm)	Scaled SAR (W/Kg)	Limit W/kg
2.4GHz WIFI-802.11b								
Bottom- Mode A	06	2437	-0.32	0.359	16.00	15.76	0.379	1.6
Bottom- Mode B	06	2437	1.22	0.393	16.00	15.76	0.415	1.6
Bottom- Mode C	06	2437	0.02	0.383	16.00	15.76	0.405	1.6
Edge 2- Mode A	06	2437	0.23	0.165	16.00	15.76	0.174	1.6
Edge 2- Mode B	06	2437	-0.33	0.159	16.00	15.76	0.168	1.6
Edge 2- Mode C	06	2437	-1.28	0.162	16.00	15.76	0.171	1.6
5.2 GHz WIFI-802.11A20								
Bottom- Mode A	48	5240	-1.22	0.069	11.00	10.54	0.077	1.6
Bottom- Mode B	48	5240	0.36	0.064	11.00	10.54	0.071	1.6
Bottom- Mode C	48	5240	0.85	0.059	11.00	10.54	0.066	1.6
Edge 2- Mode A	48	5240	-0.65	0.009	11.00	10.54	0.010	1.6
Edge 2- Mode B	48	5240	0.14	0.009	11.00	10.54	0.010	1.6
Edge 2- Mode C	48	5240	-0.25	0.016	11.00	10.54	0.018	1.6
5.2 GHz WIFI-802.11AC20								
Bottom- Mode A	36	5180	-0.20	0.357	10.00	9.68	0.384	1.6
Bottom- Mode B	36	5180	1.96	0.265	10.00	9.68	0.285	1.6
Bottom- Mode C	36	5180	0.37	0.256	10.00	9.68	0.276	1.6
Edge 2- Mode A	36	5180	-1.58	0.025	10.00	9.68	0.027	1.6
Edge 2- Mode B	36	5180	-0.20	0.028	10.00	9.68	0.030	1.6
Edge 2- Mode C	36	5180	0.23	0.012	10.00	9.68	0.013	1.6
5.2 GHz WIFI-802.11N20								
Bottom- Mode A	36	5180	0.32	0.231	10.00	9.75	0.245	1.6
Bottom- Mode B	36	5180	-1.22	0.110	10.00	9.75	0.117	1.6
Bottom- Mode C	36	5180	-0.02	0.114	10.00	9.75	0.121	1.6
Edge 2- Mode A	36	5180	0.23	0.141	10.00	9.75	0.149	1.6
Edge 2- Mode B	36	5180	0.32	0.122	10.00	9.75	0.129	1.6
Edge 2- Mode C	36	5180	-1.25	0.180	10.00	9.75	0.191	1.6
Note:								
1. The above "bottom-mode A/B/C" means : the EUT bottom face parallel with phantom,and then rotate antenna with 0°/90°/ downward 90°,see section 7.								
2. The above "Edge 2-mode A/B/C" means : the EUT bottom face parallel with phantom,and then rotate antenna with 0°/90°/ 180°,see section 7.								
3. When the 1-g Reported SAR is ≤ 0.8 W/kg, testing for low and high channel is optional. Refer to KDB 447498 D01.								
4. Per KDB248227, SAR is not required for 802.11n HT20/HT40 channels when the maximum average output power is less than 1/4 dB higher than that measured on the corresponding 802.11a/b channels.								

SAR MEASUREMENT-Antenna 1								
Depth of Liquid (cm):>15								
Product: Wireless USB Adapter				Test Model: M-1200M				
Position	Ch.	Fr. (MHz)	Power Drift (<±5%)	SAR (1g) (W/kg)	Max. Tune -up Power (dBm)	Meas. output Power (dBm)	Scaled SAR (W/Kg)	Limit W/kg
2.4GHz WIFI-802.11b								
Bottom- Mode A	06	2437	-0.23	0.636	16.00	15.24	0.758	1.6
Bottom- Mode B	06	2437	1.02	0.589	16.00	15.24	0.702	1.6
Bottom- Mode C	06	2437	0.23	0.592	16.00	15.24	0.705	1.6
Edge 2- Mode A	06	2437	-0.20	0.294	16.00	15.24	0.350	1.6
Edge 2- Mode B	06	2437	-0.32	0.167	16.00	15.24	0.199	1.6
Edge 2- Mode C	06	2437	1.63	0.218	16.00	15.24	0.260	1.6
5.2 GHz WIFI-802.11A20								
Bottom- Mode A	48	5240	-0.48	0.049	11.00	9.99	0.062	1.6
Bottom- Mode B	48	5240	-0.26	0.030	11.00	9.99	0.038	1.6
Bottom- Mode C	48	5240	0.32	0.070	11.00	9.99	0.088	1.6
Edge 2- Mode A	48	5240	0.02	0.036	11.00	9.99	0.045	1.6
Edge 2- Mode B	48	5240	-0.32	0.043	11.00	9.99	0.054	1.6
Edge 2- Mode C	48	5240	1.20	0.042	11.00	9.99	0.053	1.6
5.2 GHz WIFI-802.11AC20								
Bottom- Mode A	36	5180	0.23	0.161	10.00	9.22	0.193	1.6
Bottom- Mode B	36	5180	-0.32	0.172	10.00	9.22	0.206	1.6
Bottom- Mode C	36	5180	1.20	0.182	10.00	9.22	0.218	1.6
Edge 2- Mode A	36	5180	0.05	0.009	10.00	9.22	0.011	1.6
Edge 2- Mode B	36	5180	-0.23	0.013	10.00	9.22	0.016	1.6
Edge 2- Mode C	36	5180	0.32	0.009	10.00	9.22	0.011	1.6
5.2 GHz WIFI-802.11N20								
Bottom- Mode A	36	5180	0.02	0.113	10.00	9.62	0.123	1.6
Bottom- Mode B	36	5180	-0.12	0.096	10.00	9.62	0.105	1.6
Bottom- Mode C	36	5180	1.20	0.095	10.00	9.62	0.104	1.6
Edge 2- Mode A	36	5180	-0.02	0.136	10.00	9.62	0.148	1.6
Edge 2- Mode B	36	5180	-0.32	0.154	10.00	9.62	0.168	1.6
Edge 2- Mode C	36	5180	0.20	0.114	10.00	9.62	0.124	1.6
Note:								
1. The above "bottom-mode A/B/C" means : the EUT bottom face parallel with phantom,and then rotate antenna with 0°/90°/ downward 90°,see section 7.								
2. The above "Edge 2-mode A/B/C" means : the EUT bottom face parallel with phantom,and then rotate antenna with 0°/90°/ 180°,see section 7.								
3. When the 1-g Reported SAR is ≤ 0.8 W/kg, testing for low and high channel is optional. Refer to KDB 447498 D01.								
4. Per KDB248227, SAR is not required for 802.11n HT20/HT40 channels when the maximum average output power is less than 1/4 dB higher than that measured on the corresponding 802.11a/b channels.								

Simultaneous Multi-band Transmission Evaluation:

NO	Simultaneous state	Portable Handset		
		Head	Body-worn	Hotspot
1	WLAN 5.0GHz Antenna 0 (data) + WLAN 5.0GHz Antenna 1 (data)	-	Yes	-

Frequency	Test Position	Simultaneous Transmission Scenario		Σ1g SAR (W/Kg)	SPLSR (Yes/No)
		Antenna 0	Antenna 1		
5.2 GHz WIFI-802.11A20	Bottom- Mode A	0.077	0.062	0.139	No
	Bottom- Mode B	0.071	0.038	0.109	No
	Bottom- Mode C	0.066	0.088	0.154	No
	Edge 2- Mode A	0.010	0.045	0.055	No
	Edge 2- Mode B	0.010	0.054	0.064	No
	Edge 2- Mode C	0.018	0.053	0.071	No
5.2 GHz WIFI-802.11AC20	Bottom- Mode A	0.384	0.193	0.577	No
	Bottom- Mode B	0.285	0.206	0.491	No
	Bottom- Mode C	0.276	0.218	0.494	No
	Edge 2- Mode A	0.027	0.011	0.038	No
	Edge 2- Mode B	0.030	0.016	0.046	No
	Edge 2- Mode C	0.013	0.011	0.024	No
5.2 GHz WIFI-802.11N20	Bottom- Mode A	0.245	0.123	0.368	No
	Bottom- Mode B	0.117	0.105	0.222	No
	Bottom- Mode C	0.121	0.104	0.225	No
	Edge 2- Mode A	0.149	0.148	0.297	No
	Edge 2- Mode B	0.129	0.168	0.297	No
	Edge 2- Mode C	0.191	0.124	0.315	No

Note:

- According to KDB 447498 D01 General RF Exposure Guidance, when the simultaneous transmission SAR is less than 1.6 W/Kg, SPLSR assessment is not required.
- SPLSR mean is “The SAR to Peak Location Separation Ratio “

APPENDIX A. SAR SYSTEM CHECK DATA

Test Laboratory: AGC Lab

Date: Mar. 06,2017

System Check Body 2450 MHz

DUT: Dipole 2450 MHz Type: SID 2450

Communication System CW; Communication System Band: D2450 (2450.0 MHz); Duty Cycle: 1:1; Conv.F=5.19

Frequency: 2450 MHz; Medium parameters used: $f = 2450$ MHz; $\sigma = 1.90$ mho/m; $\epsilon_r = 53.12$; $\rho = 1000$ kg/m³ ;

Phantom section: Flat Section; Input Power=18dBm

Ambient temperature (°C):21.9, Liquid temperature (°C): 20.7, Relative Humidity (%):55.1

SATIMO Configuration

- Probe: SSE5; Calibrated: 07/05/2016; Serial No.: SN 14/16 EP307
- Sensor-Surface: 4mm (Mechanical Surface Detection)
- Phantom: SAM twin phantom
- Measurement SW: OpenSAR V4_02_35

Configuration/System Check 2450MHz Body/Area Scan: Measurement grid: dx=8mm, dy=8mm

Configuration/System Check 2450MHz Body/Zoom Scan: Measurement grid: dx=5mm,dy=5mm, dz=5mm

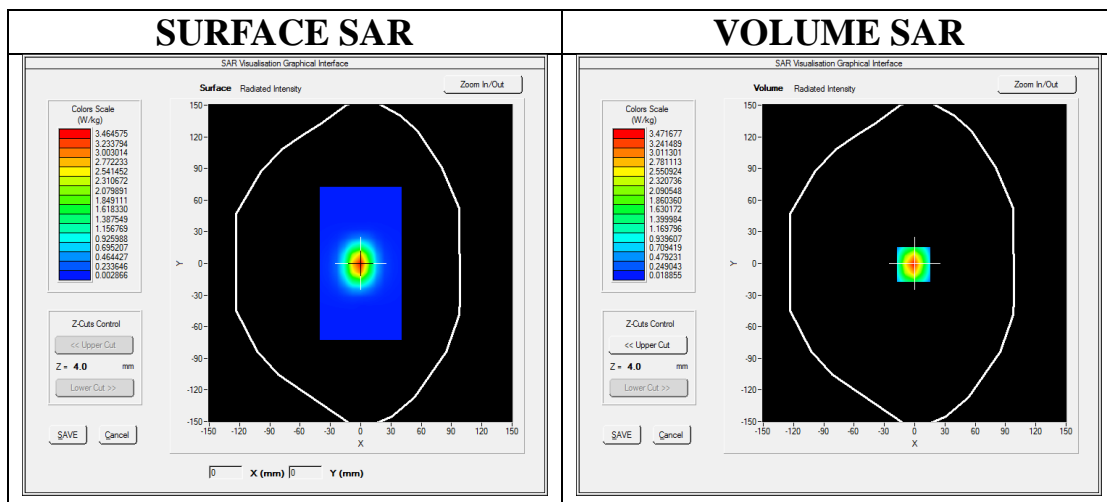

Maximum location: X=-1.00, Y=-1.00
SAR Peak: 5.90 W/kg

SAR 10g (W/Kg)	1.447205
SAR 1g (W/Kg)	3.236619

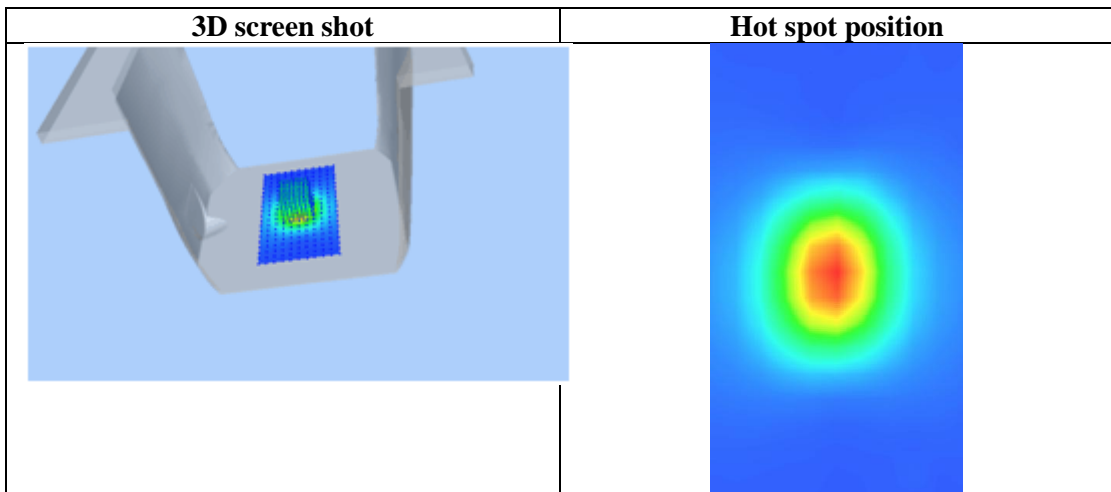
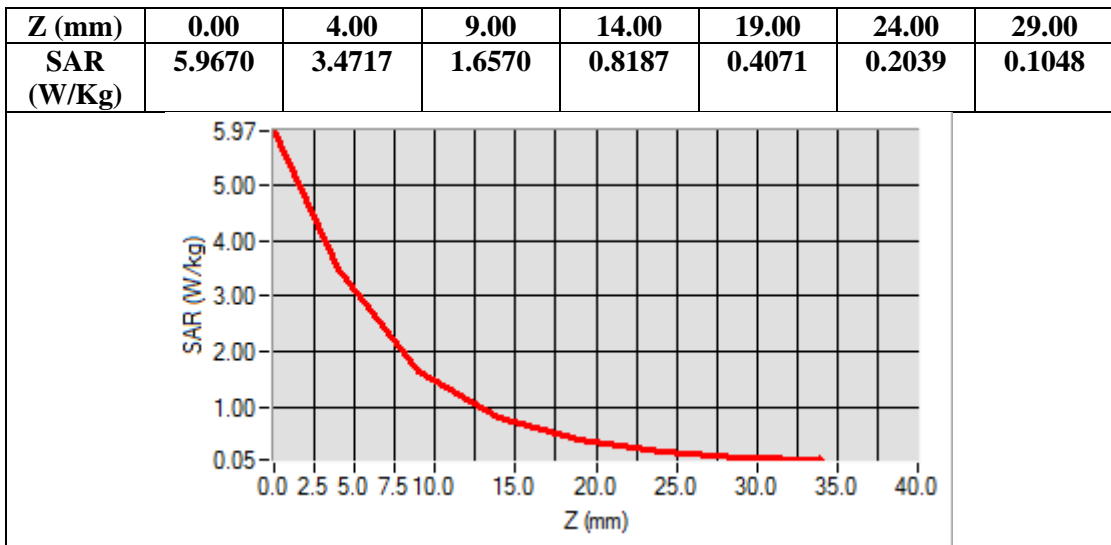

Test Laboratory: AGC Lab
System Check Body 5200 MHz
DUT: Dipole 5000MHz Type: SWG5500

Date: Mar. 03,2017

Communication System: CW; Communication System Band: D5000 (5000.0 MHz);Duty Cycle: 1:1; Conv.F=2.36
Frequency: 5200 MHz; Medium parameters used: $f = 5200$ MHz; $\sigma = 5.39$ mho/m; $\epsilon_r = 46.72$; $\rho = 1000$ kg/m³ ;
Phantom section: Flat Section; Input Power=15dBm
Ambient temperature (°C):22.3, Liquid temperature (°C): 21.1, Relative Humidity (%):54.6

SATIMO Configuration:

- Probe: SSE2; Calibrated: 07/05/2016; Serial No.: SN 08/16 EPGO282
- Sensor-Surface: 4mm (Mechanical Surface Detection)
- Phantom: SAM twin phantom
- Measurement SW: OpenSAR V4_02_35

Configuration/System Check 5200MHz Body/Area Scan: Measurement grid: dx=8mm, dy=8mm

Configuration/System Check 5200MHz Body/Zoom Scan: Measurement grid: dx=4mm,dy=4mm, dz=2mm

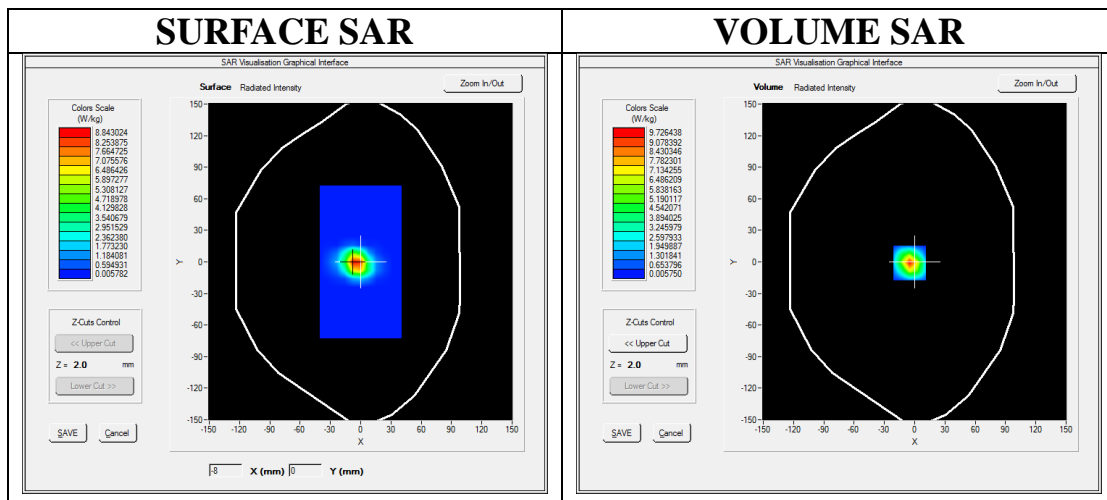

Maximum location: X=-5.00, Y=-1.00
SAR Peak: 15.73 W/kg

SAR 10g (W/Kg)	1.775795
SAR 1g (W/Kg)	5.415528

Z (mm)	0.00	2.00	7.00	12.00	17.00	22.00	27.00
SAR (W/Kg)	15.1097	9.7264	2.1194	0.3794	0.0314	0.0070	0.0070

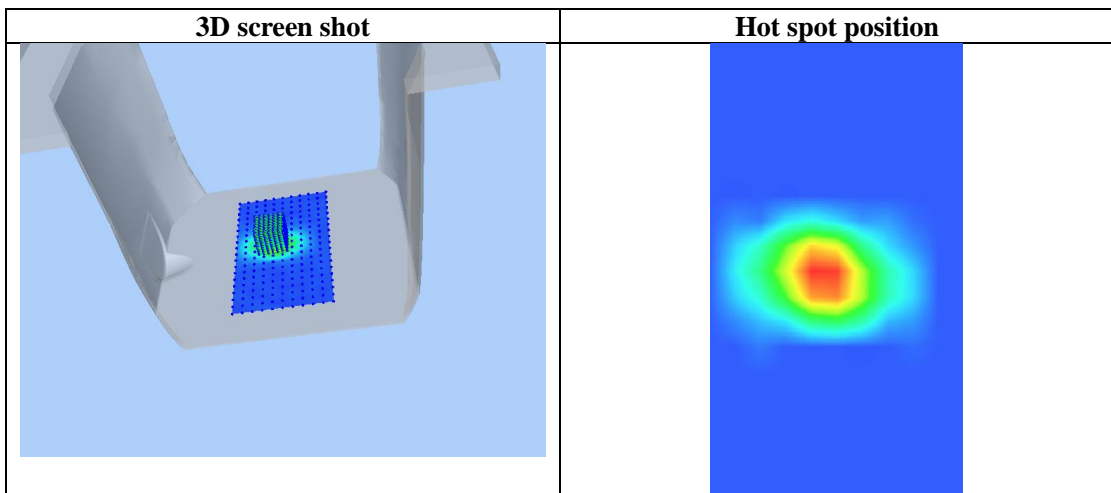
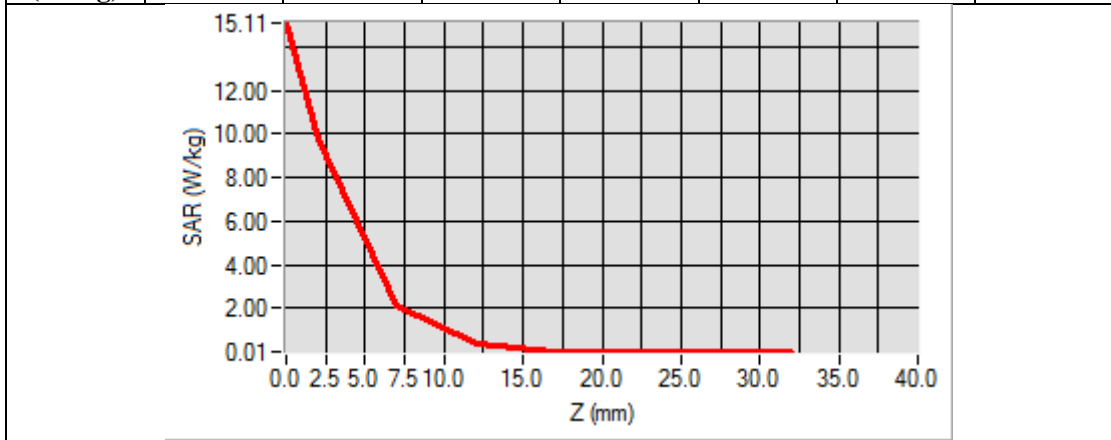

APPENDIX B. SAR MEASUREMENT DATA

Antenna 0

Test Laboratory: AGC Lab

Date: Mar. 06,2017

2.4G- 802.11b Mid-Body- Bottom - Mode B

DUT: Wireless USB Adapter; M-1200M

Communication System: Wi-Fi; Communication System Band: 802.11b; Duty Cycle: 1:1; Conv.F=5.19;
Frequency: 2437 MHz; Medium parameters used: $f = 2450$ MHz; $\sigma = 1.89$ mho/m; $\epsilon_r = 53.97$; $\rho = 1000$ kg/m³ ;
Phantom section: Flat Section

Ambient temperature (°C):21.9, Liquid temperature (°C): 20.7

SATIMO Configuration:

- Probe: SSE5; Calibrated: 07/05/2016; Serial No.: SN 14/16 EP307
- Sensor-Surface: 4mm (Mechanical Surface Detection)
- Phantom: SAM twin phantom
- Measurement SW: OpenSAR V4_02_35

Configuration/802.11b Mid- Body- Bottom - Mode B /Area Scan: Measurement grid: dx=10mm, dy=10mm

Configuration/802.11b Mid- Body- Bottom - Mode B /Zoom Scan: Measurement grid: dx=5mm,dy=5mm, dz=5mm;

Area Scan	sam_direct_droit2_surf10mm.txt
ZoomScan	7x7x7,dx=5mm dy=5mm dz=5mm
Phantom	Validation plane
Device Position	Body- Bottom - Mode B
Band	2450MHz
Channels	Middle
Signal	Crest factor: 1.0

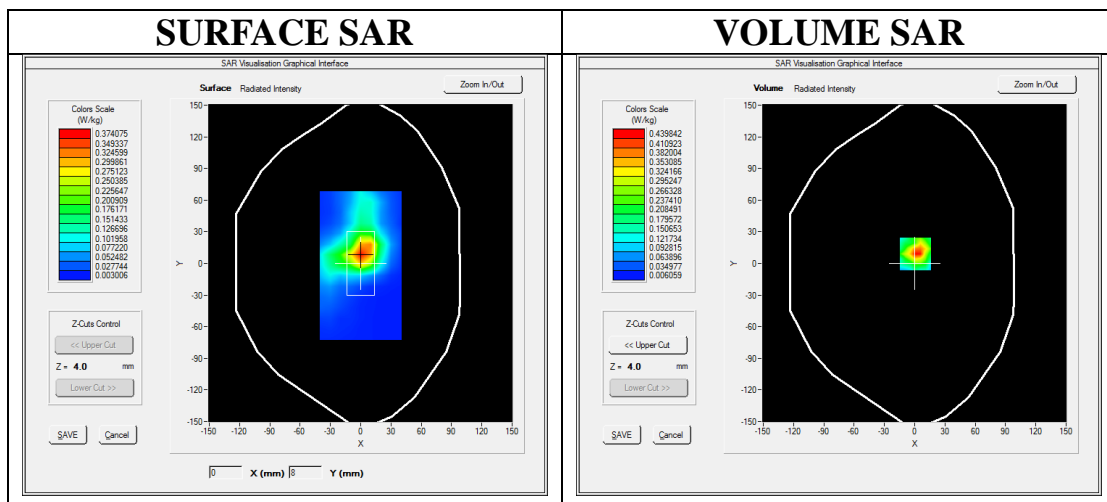

Maximum location: X=1.00, Y=9.00

SAR Peak: 0.78 W/kg

SAR 10g (W/Kg)	0.181483
SAR 1g (W/Kg)	0.393332

Z (mm)	0.00	4.00	9.00	14.00	19.00	24.00	29.00
SAR (W/Kg)	0.7355	0.4398	0.2226	0.1160	0.0636	0.0353	0.0192

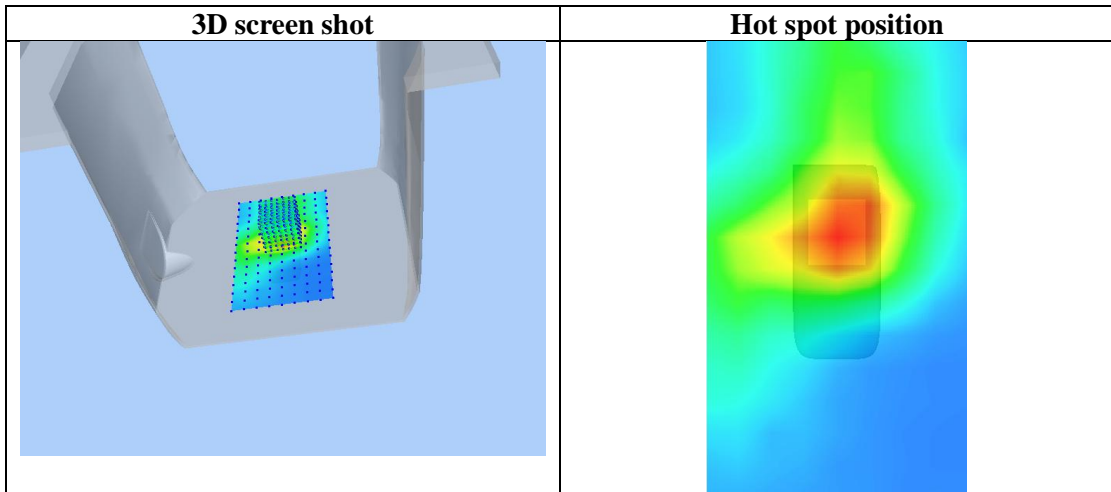
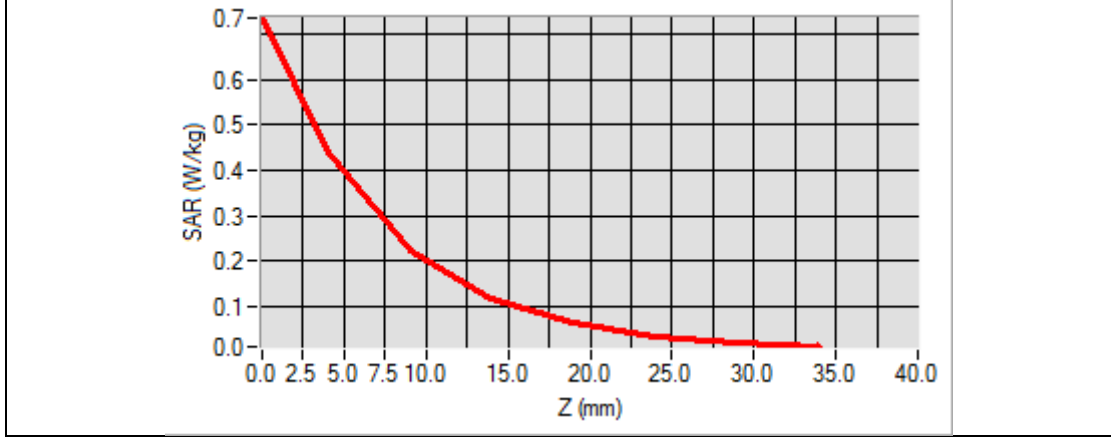

Test Laboratory: AGC Lab
5.2G -802.11a20 High- Body- Bottom - Mode A
DUT: Wireless USB Adapter; M-1200M

Date: Mar. 03,2017

Communication System: Wi-Fi; Communication System Band: 802.11a20; Duty Cycle: 1:1; Conv.F=2.36;
Frequency: 5240MHz; Medium parameters used: $f = 5200$ MHz; $\sigma = 5.53$ mho/m; $\epsilon_r = 46.01$; $\rho = 1000$ kg/m³ ;
Phantom section: Flat Section
Ambient temperature (°C):22.3, Liquid temperature (°C): 21.1

SATIMO Configuration:

- Probe: SSE2; Calibrated: 07/05/2016; Serial No.: SN 08/16 EPGO282
- Sensor-Surface: 4mm (Mechanical Surface Detection)
- Phantom: SAM twin phantom
- Measurement SW: OpenSAR V4_02_35

Configuration/802.11a20 High - Body- Bottom - Mode A /Area Scan: Measurement grid: dx=10mm, dy=10mm
Configuration/802.11a20 High - Body- Bottom - Mode A /Zoom Scan: Measurement grid: dx=4mm,dy=4mm, dz=2mm

Area Scan	sam_direct_droit2_surf10mm.txt
ZoomScan	8x8x13 dx=4mm dy=4mm dz=2mm
Phantom	Validation plane
Device Position	Body Bottom - Mode A
Band	5200MHz
Channels	High
Signal	Crest factor: 1.0

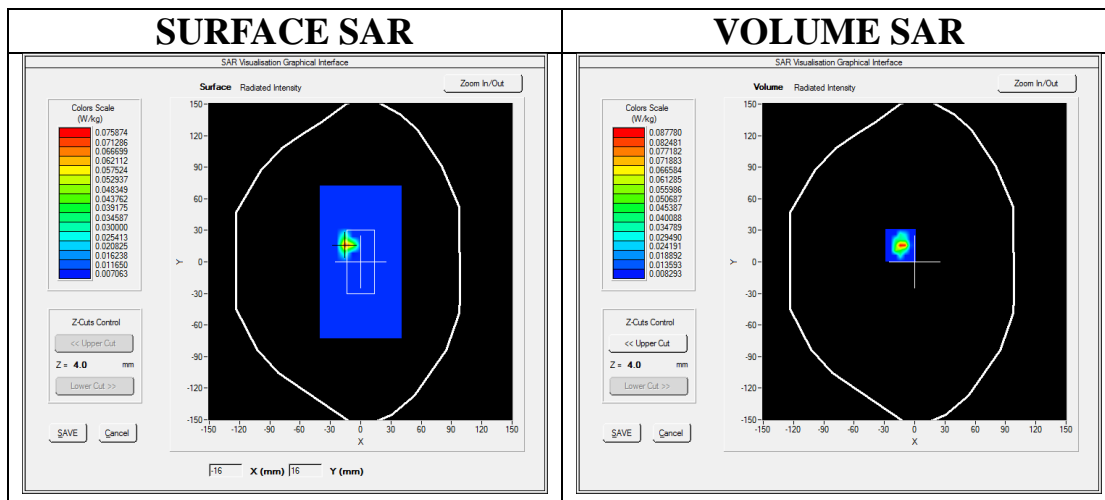

Maximum location: X=-14.00, Y=16.00
SAR Peak: 0.25 W/kg

SAR 10g (W/Kg)	0.020117
SAR 1g (W/Kg)	0.068566

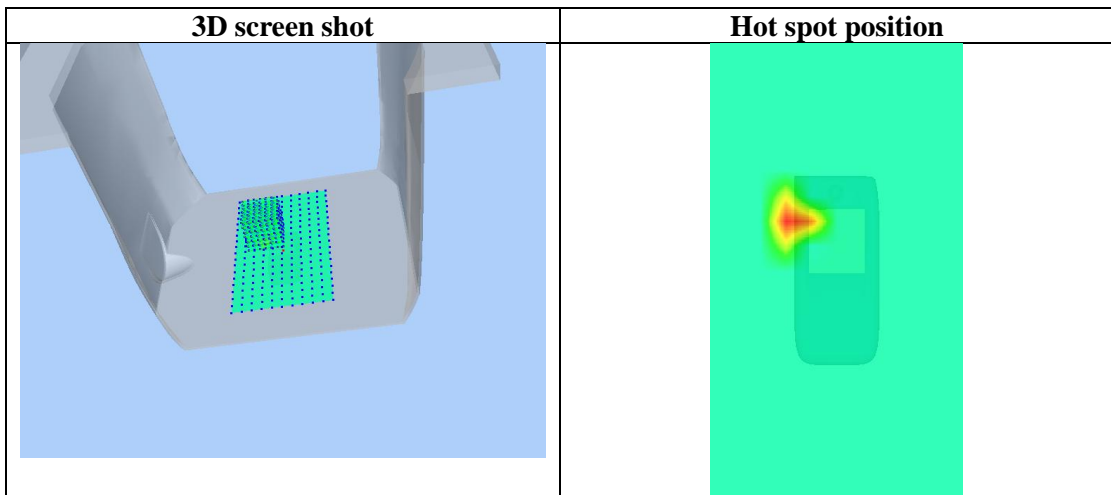
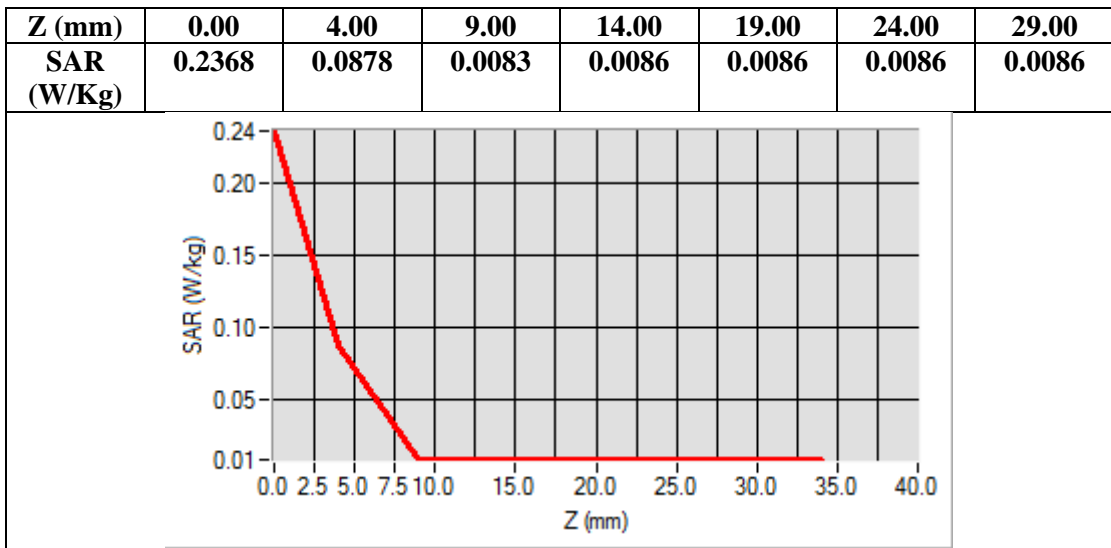

Test Laboratory: AGC Lab
5.2G -802.11ac20 Low-Body- Bottom - Mode A
DUT: Wireless USB Adapter; M-1200M

Date: Mar. 03,2017

Communication System: Wi-Fi; Communication System Band: 802.11ac20; Duty Cycle: 1:1; Conv.F=2.36;
Frequency: 5180MHz; Medium parameters used: $f = 5200$ MHz; $\sigma = 5.25$ mho/m; $\epsilon_r = 46.98$; $\rho = 1000$ kg/m³ ;
Phantom section: Flat Section
Ambient temperature (°C):22.3, Liquid temperature (°C): 21.1

SATIMO Configuration:

- Probe: SSE2; Calibrated: 07/05/2016; Serial No.: SN 08/16 EPGO282
- Sensor-Surface: 4mm (Mechanical Surface Detection)
- Phantom: SAM twin phantom
- Measurement SW: OpenSAR V4_02_35

Configuration/802.11ac20 Low - Body- Bottom - Mode A /Area Scan: Measurement grid: dx=10mm, dy=10mm
Configuration/802.11ac20 Low - Body- Bottom - Mode A /Zoom Scan: Measurement grid: dx=4mm,dy=4mm, dz=2mm

Area Scan	sam_direct_droit2_surf10mm.txt
ZoomScan	8x8x13 dx=4mm dy=4mm dz=2mm
Phantom	Validation plane
Device Position	Body Bottom - Mode A
Band	5200MHz
Channels	Low
Signal	Crest factor: 1.0

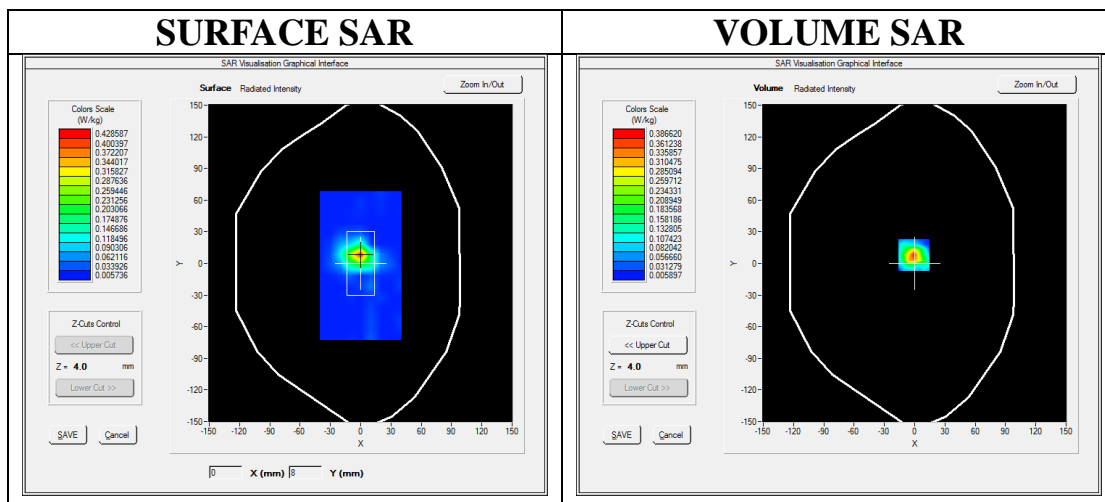

Maximum location: X=-1.00, Y=8.00
SAR Peak: 0.99 W/kg

SAR 10g (W/Kg)	0.107338
SAR 1g (W/Kg)	0.356694

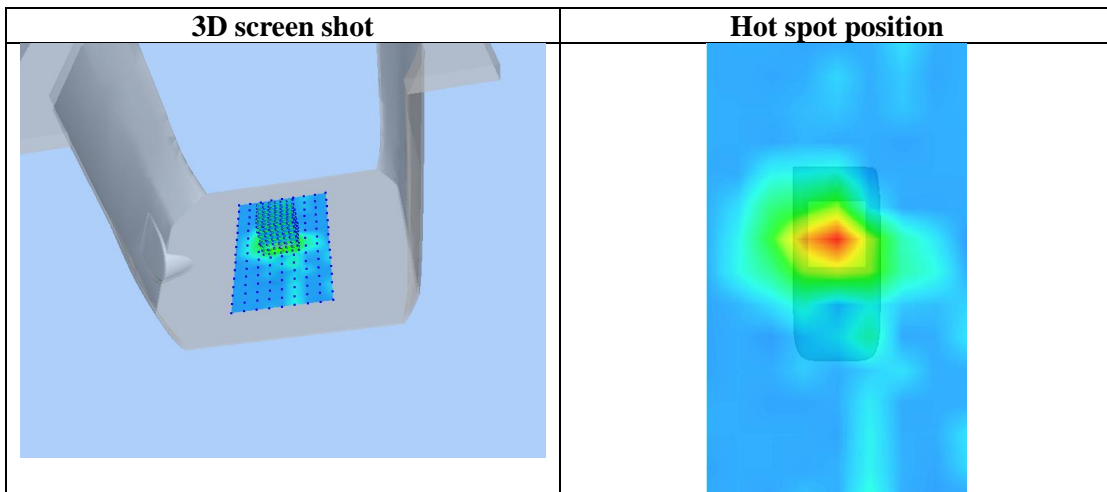
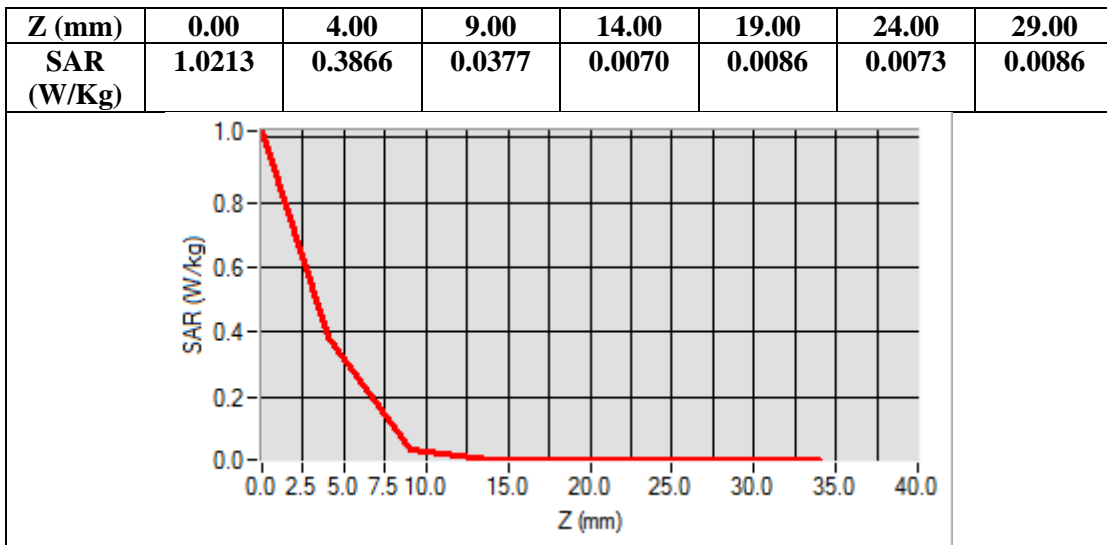

Test Laboratory: AGC Lab
5.2G -802.11N20 Low-Body- Bottom - Mode A
DUT: Wireless USB Adapter; M-1200M

Date: Mar. 03,2017

Communication System: Wi-Fi; Communication System Band: 802.11N20; Duty Cycle: 1:1; Conv.F=2.36;
Frequency: 5180MHz; Medium parameters used: $f = 5200$ MHz; $\sigma = 5.25$ mho/m; $\epsilon_r = 46.98$; $\rho = 1000$ kg/m³ ;
Phantom section: Flat Section
Ambient temperature (°C):22.3, Liquid temperature (°C): 21.1

SATIMO Configuration:

- Probe: SSE2; Calibrated: 07/05/2016; Serial No.: SN 08/16 EPGO282
- Sensor-Surface: 4mm (Mechanical Surface Detection)
- Phantom: SAM twin phantom
- Measurement SW: OpenSAR V4_02_35

Configuration/802.11N20 Low - Body- Bottom - Mode A /Area Scan: Measurement grid: dx=10mm, dy=10mm
Configuration/802.11N20 Low - Body- Bottom - Mode A /Zoom Scan: Measurement grid: dx=4mm,dy=4mm, dz=2mm

Area Scan	sam_direct_droit2_surf10mm.txt
ZoomScan	8x8x13 dx=4mm dy=4mm dz=2mm
Phantom	Validation plane
Device Position	Body Bottom - Mode A
Band	5200MHz
Channels	Low
Signal	Crest factor: 1.0

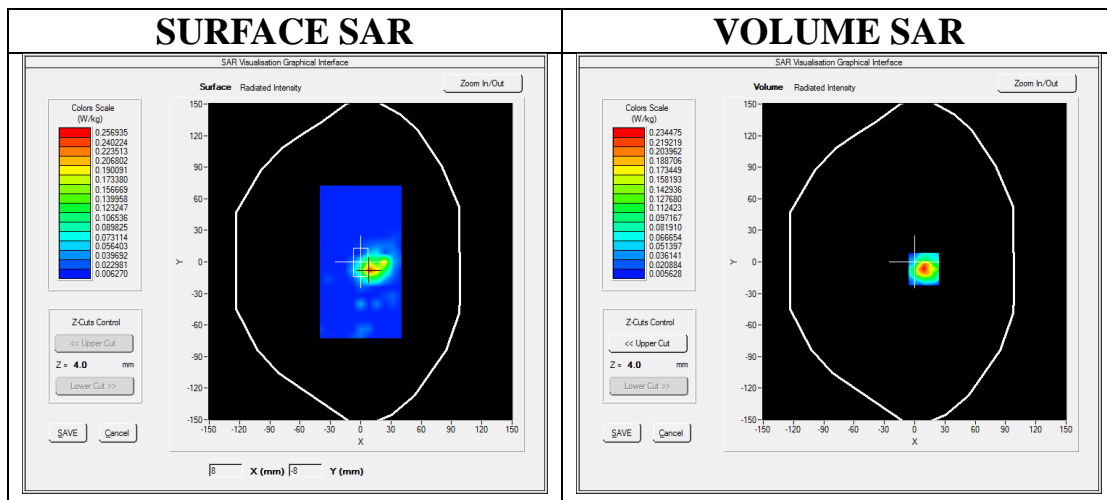

Maximum location: X=9.00, Y=-7.00
SAR Peak: 0.63 W/kg

SAR 10g (W/Kg)	0.070578
SAR 1g (W/Kg)	0.230867

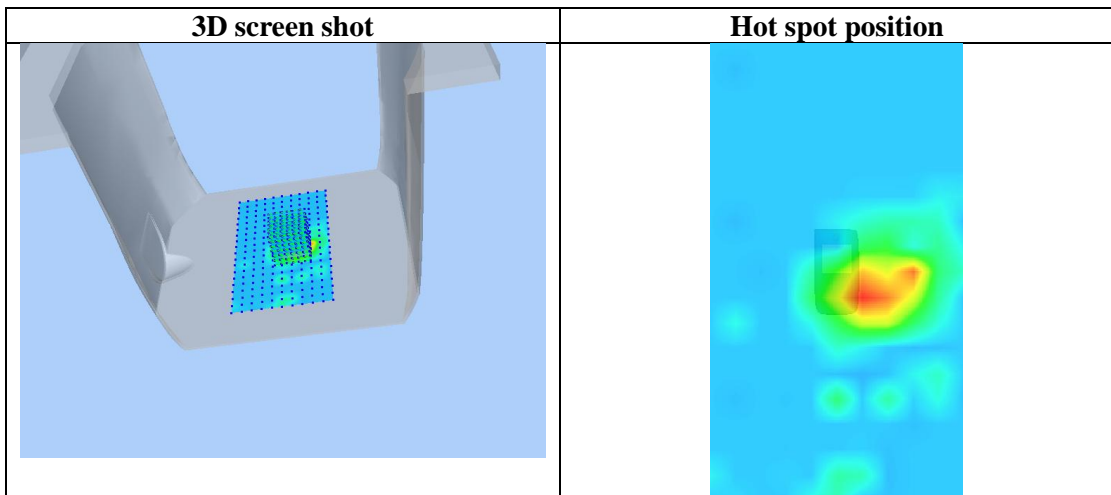
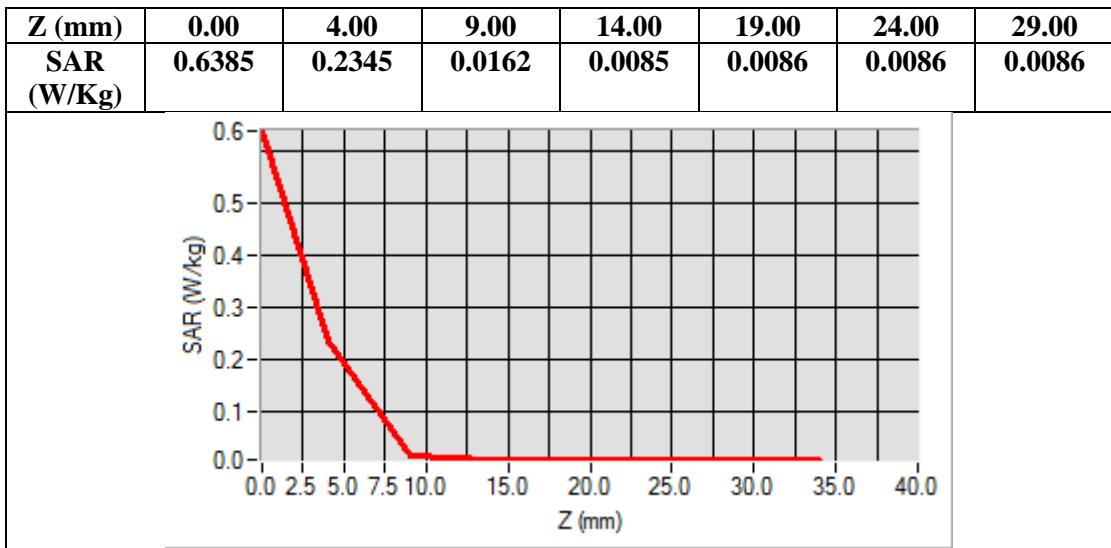

Antenna 1

Test Laboratory: AGC Lab
2.4G- 802.11b Mid-Body- Bottom - Mode A
DUT: Wireless USB Adapter; M-1200M

Date: Mar. 06,2017

Communication System: Wi-Fi; Communication System Band: 802.11b; Duty Cycle: 1:1; Conv.F=5.19;
Frequency: 2437 MHz; Medium parameters used: $f = 2450$ MHz; $\sigma = 1.89$ mho/m; $\epsilon_r = 53.97$; $\rho = 1000$ kg/m³ ;
Phantom section: Flat Section
Ambient temperature (°C):21.9, Liquid temperature (°C): 20.7

SATIMO Configuration:

- Probe: SSE5; Calibrated: 07/05/2016; Serial No.: SN 14/16 EP307
- Sensor-Surface: 4mm (Mechanical Surface Detection)
- Phantom: SAM twin phantom
- Measurement SW: OpenSAR V4_02_35

Configuration/802.11b Mid- Body- Bottom - Mode A /Area Scan: Measurement grid: dx=10mm, dy=10mm
Configuration/802.11b Mid- Body- Bottom - Mode A /Zoom Scan: Measurement grid: dx=5mm,dy=5mm, dz=5mm;

Area Scan	sam_direct_droit2_surf10mm.txt
ZoomScan	7x7x7,dx=5mm dy=5mm dz=5mm
Phantom	Validation plane
Device Position	Body- Bottom - Mode A
Band	2450MHz
Channels	Middle
Signal	Crest factor: 1.0

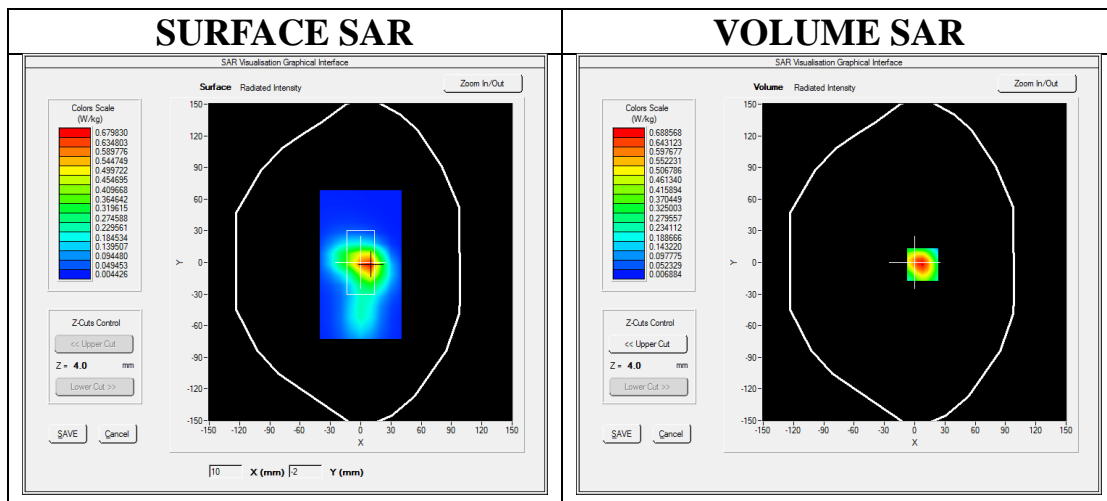

Maximum location: X=8.00, Y=-2.00
SAR Peak: 1.11 W/kg

SAR 10g (W/Kg)	0.322005
SAR 1g (W/Kg)	0.636029

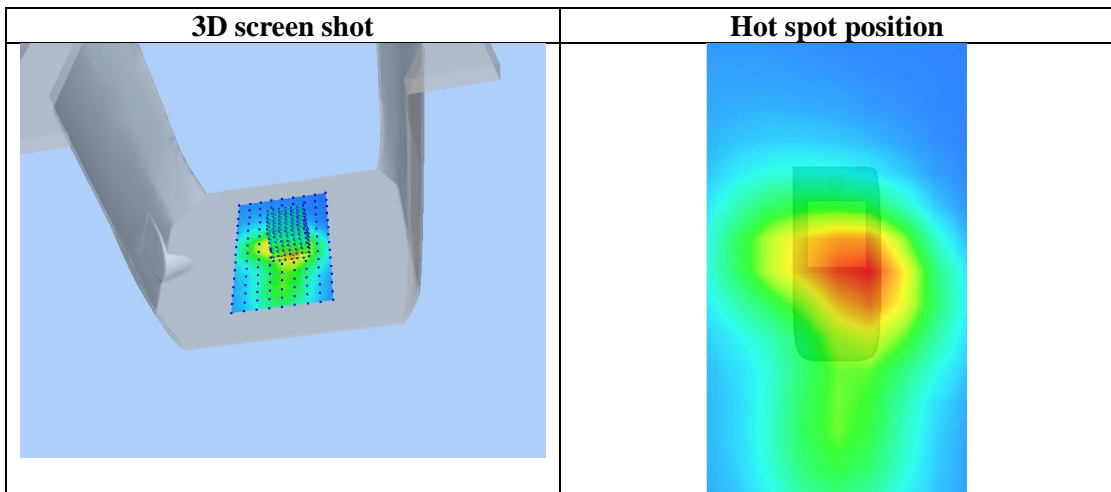
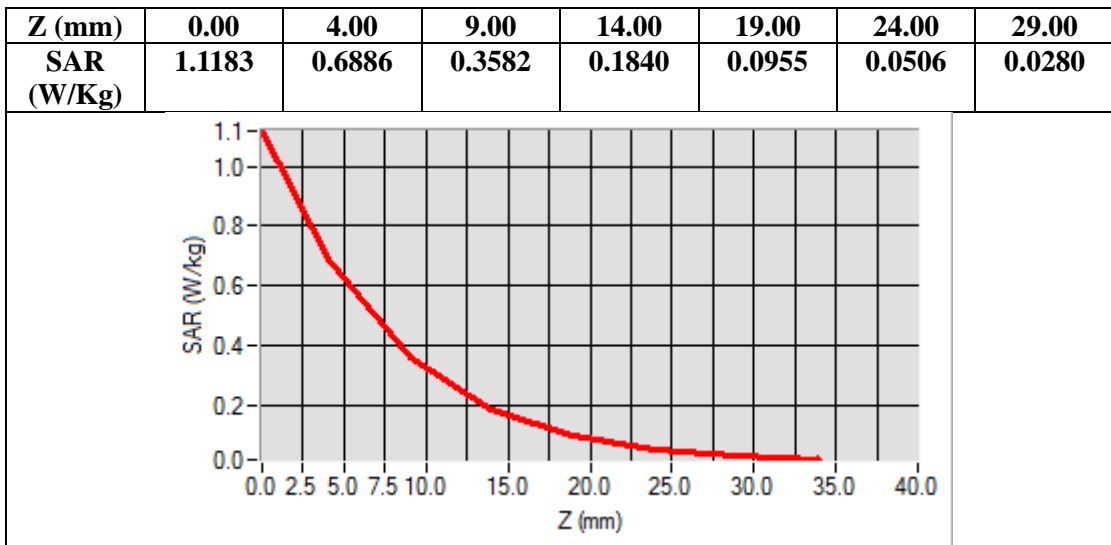

Test Laboratory: AGC Lab
5.2G -802.11a20 High- Body- Bottom - Mode C
DUT: Wireless USB Adapter; M-1200M

Date: Mar. 03,2017

Communication System: Wi-Fi; Communication System Band: 802.11a20; Duty Cycle: 1:1; Conv.F=2.36;
Frequency: 5240MHz; Medium parameters used: $f = 5200$ MHz; $\sigma = 5.53$ mho/m; $\epsilon_r = 46.01$; $\rho = 1000$ kg/m³ ;
Phantom section: Flat Section
Ambient temperature (°C):22.3, Liquid temperature (°C): 21.1

SATIMO Configuration:

- Probe: SSE2; Calibrated: 07/05/2016; Serial No.: SN 08/16 EPGO282
- Sensor-Surface: 4mm (Mechanical Surface Detection)
- Phantom: SAM twin phantom
- Measurement SW: OpenSAR V4_02_35

Configuration/802.11a20 High - Body- Bottom - Mode C /Area Scan: Measurement grid: dx=10mm, dy=10mm
Configuration/802.11a20 High - Body- Bottom - Mode C /Zoom Scan: Measurement grid: dx=4mm,dy=4mm, dz=2mm

Area Scan	sam_direct_droit2_surf10mm.txt
ZoomScan	8x8x13 dx=4mm dy=4mm dz=2mm
Phantom	Validation plane
Device Position	Body Bottom - Mode C
Band	5200MHz
Channels	High
Signal	Crest factor: 1.0

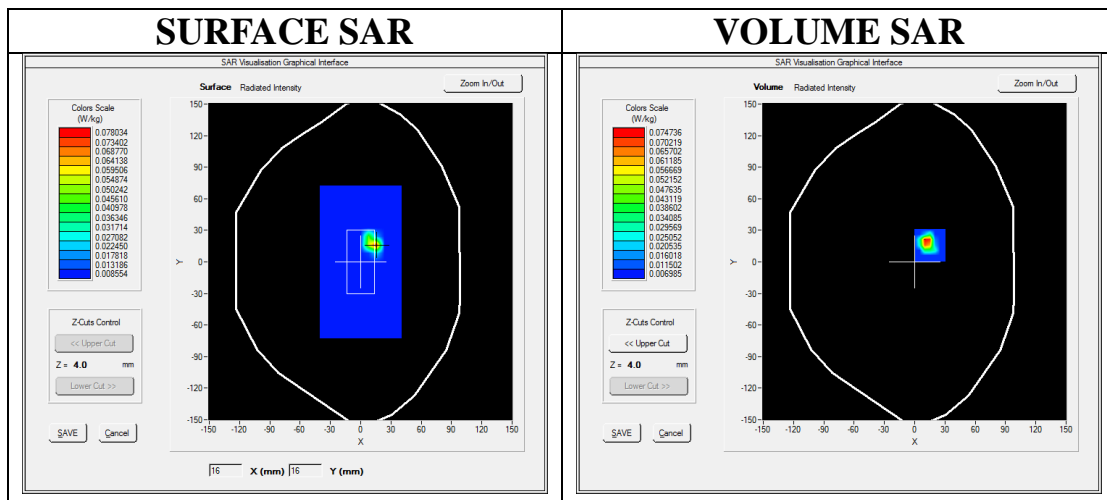

Maximum location: X=15.00, Y=16.00

SAR Peak: 0.22 W/kg

SAR 10g (W/Kg)	0.018969
SAR 1g (W/Kg)	0.069562

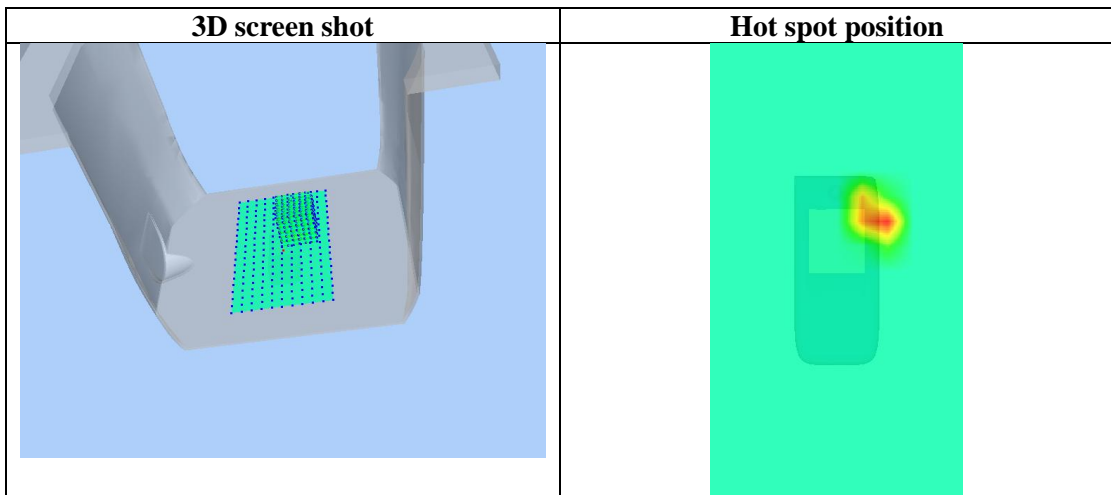
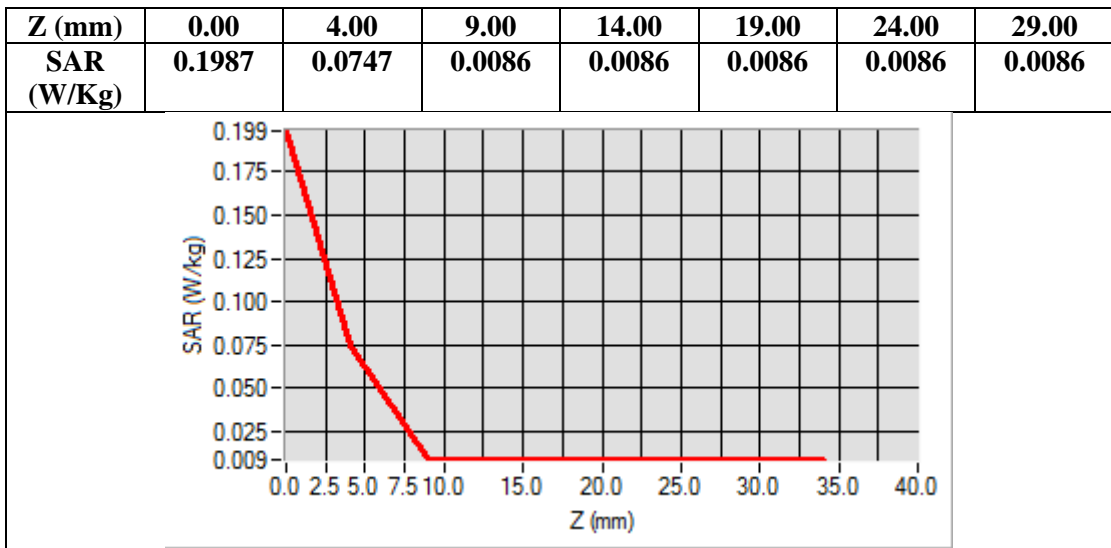

Test Laboratory: AGC Lab
5.2G -802.11ac20 Low-Body- Bottom - Mode C
DUT: Wireless USB Adapter; M-1200M

Date: Mar. 03,2017

Communication System: Wi-Fi; Communication System Band: 802.11ac20; Duty Cycle: 1:1; Conv.F=2.36;
Frequency: 5180MHz; Medium parameters used: $f = 5200$ MHz; $\sigma = 5.25$ mho/m; $\epsilon_r = 46.98$; $\rho = 1000$ kg/m³ ;
Phantom section: Flat Section
Ambient temperature (°C):22.3, Liquid temperature (°C): 21.1

SATIMO Configuration:

- Probe: SSE2; Calibrated: 07/05/2016; Serial No.: SN 08/16 EPGO282
- Sensor-Surface: 4mm (Mechanical Surface Detection)
- Phantom: SAM twin phantom
- Measurement SW: OpenSAR V4_02_35

Configuration/802.11ac20 Low - Body- Bottom - Mode C /Area Scan: Measurement grid: dx=10mm, dy=10mm
Configuration/802.11ac20 Low - Body- Bottom - Mode C /Zoom Scan: Measurement grid: dx=4mm,dy=4mm, dz=2mm

Area Scan	sam_direct_droit2_surf10mm.txt
ZoomScan	8x8x13 dx=4mm dy=4mm dz=2mm
Phantom	Validation plane
Device Position	Body Bottom - Mode C
Band	5200MHz
Channels	Low
Signal	Crest factor: 1.0

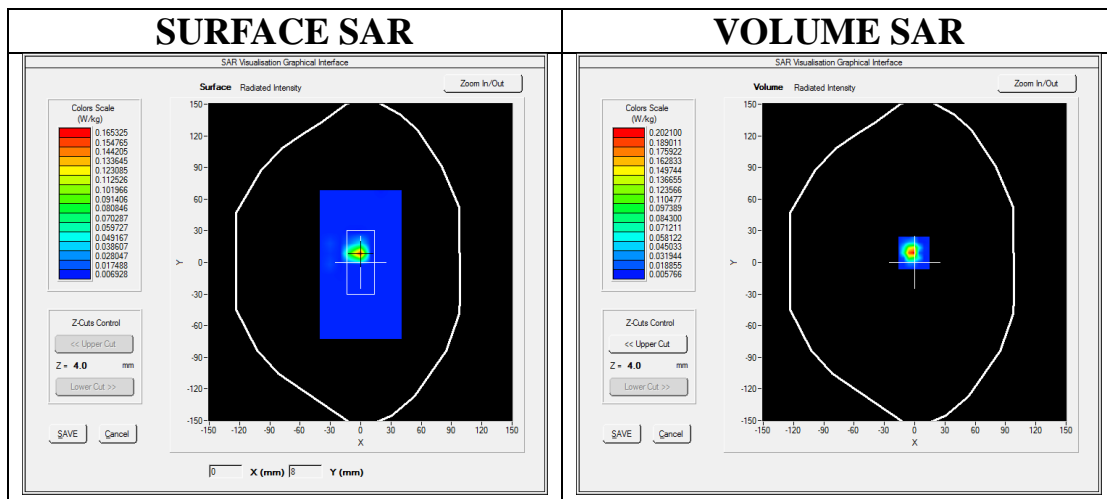

Maximum location: X=-1.00, Y=9.00
SAR Peak: 0.60 W/kg

SAR 10g (W/Kg)	0.038689
SAR 1g (W/Kg)	0.181646

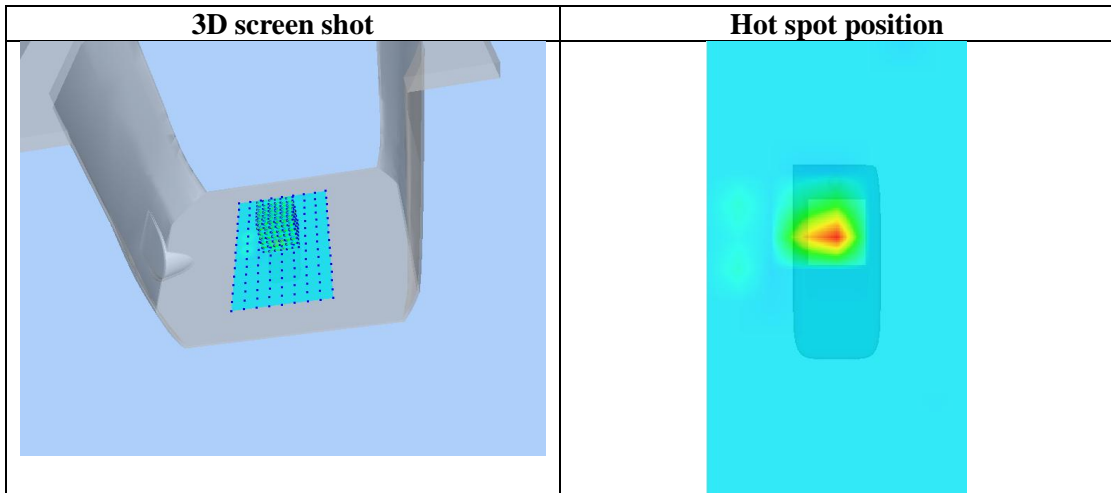
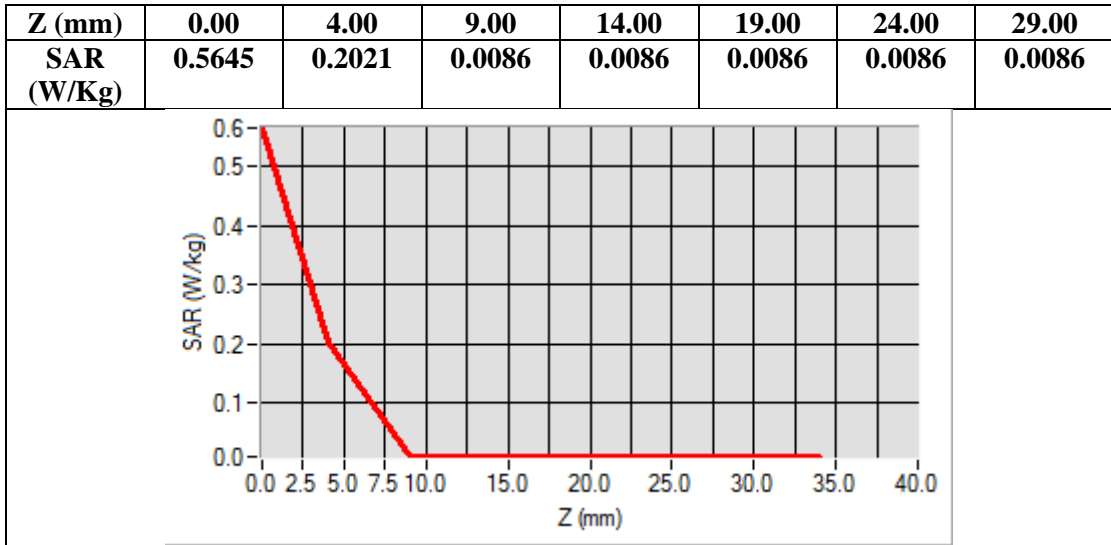

Test Laboratory: AGC Lab
5.2G -802.11N20 Low- Edge 2- Mode B
DUT: Wireless USB Adapter; M-1200M

Date: Mar. 03,2017

Communication System: Wi-Fi; Communication System Band: 802.11N20; Duty Cycle: 1:1; Conv.F=2.36;
Frequency: 5180MHz; Medium parameters used: $f = 5200$ MHz; $\sigma = 5.25$ mho/m; $\epsilon_r = 46.98$; $\rho = 1000$ kg/m³ ;
Phantom section: Flat Section
Ambient temperature (°C):22.3, Liquid temperature (°C): 21.1

SATIMO Configuration:

- Probe: SSE2; Calibrated: 07/05/2016; Serial No.: SN 08/16 EPGO282
- Sensor-Surface: 4mm (Mechanical Surface Detection)
- Phantom: SAM twin phantom
- Measurement SW: OpenSAR V4_02_35

Configuration/802.11N20 Low - Edge 2- Mode B /Area Scan: Measurement grid: dx=10mm, dy=10mm
Configuration/802.11N20 Low - Edge 2- Mode B /Zoom Scan: Measurement grid: dx=4mm,dy=4mm, dz=2mm

Area Scan	sam_direct_droit2_surf10mm.txt
ZoomScan	8x8x13 dx=4mm dy=4mm dz=2mm
Phantom	Validation plane
Device Position	Edge 2- Mode B
Band	5200MHz
Channels	Low
Signal	Crest factor: 1.0

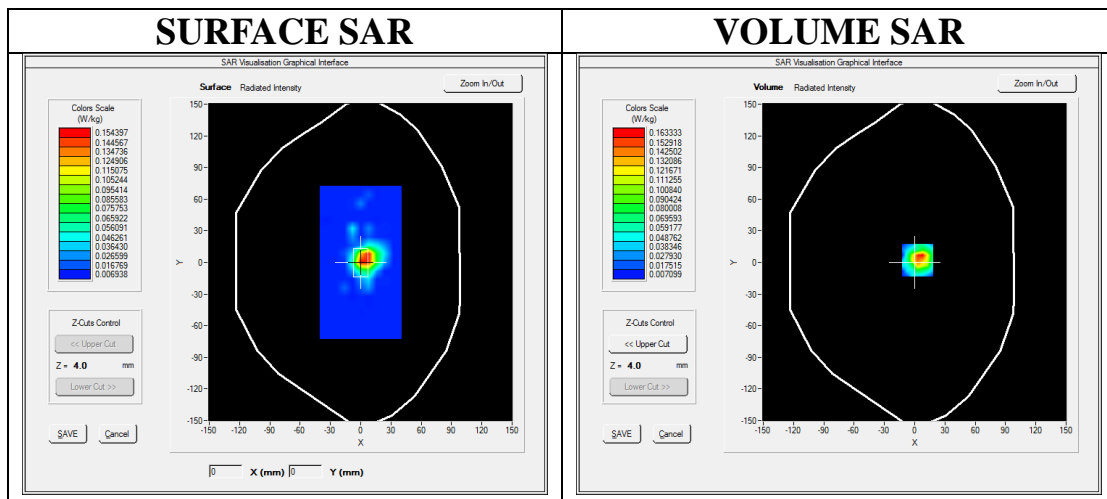

Maximum location: X=3.00, Y=2.00

SAR Peak: 0.44 W/kg

SAR 10g (W/Kg)	0.050592
SAR 1g (W/Kg)	0.154241

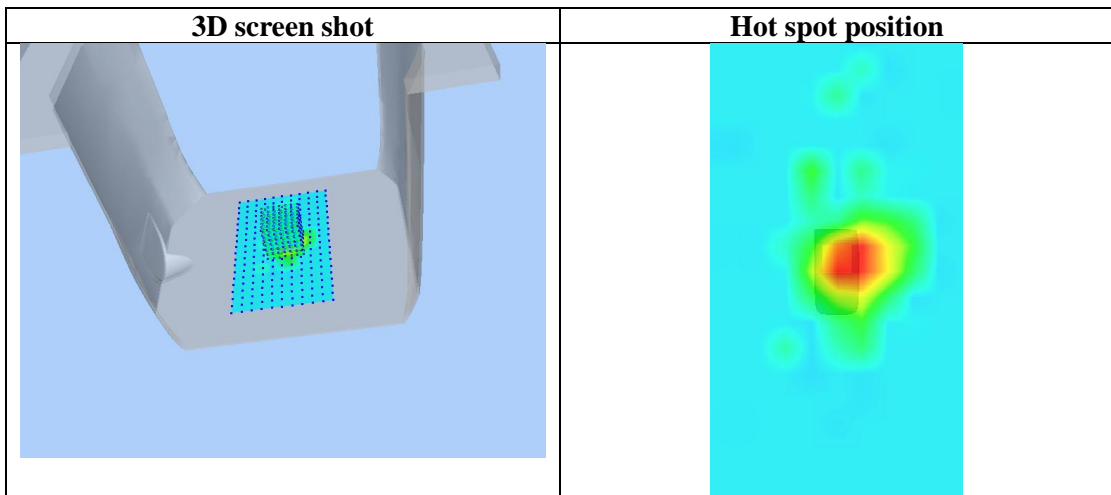
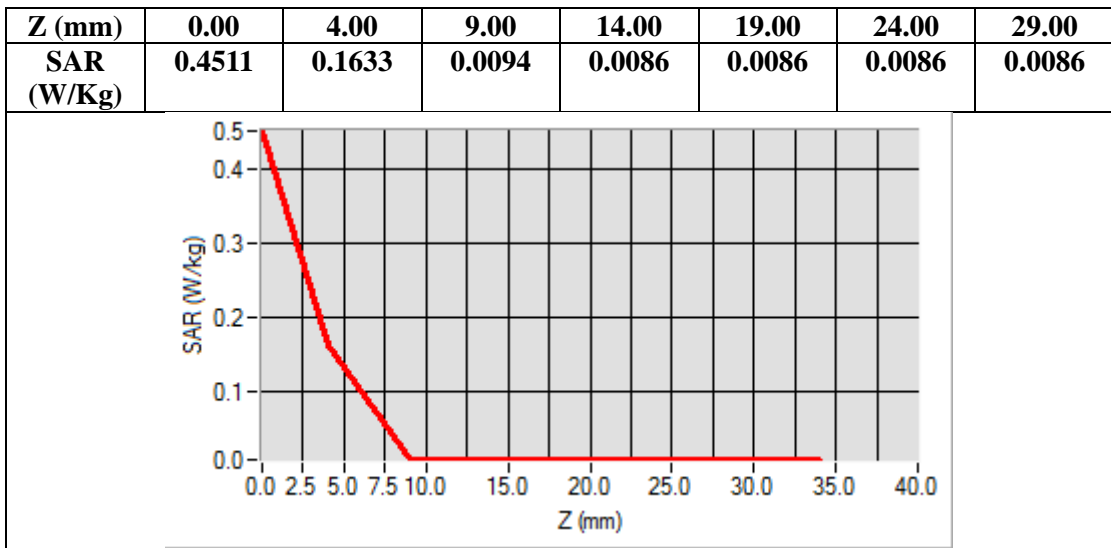

APPENDIX C. TEST SETUP PHOTOGRAPHS & EUT PHOTOGRAPHS

Refer to Attached files.

APPENDIX D. CALIBRATION DATA

Refer to Attached files.