



FCC TEST REPORT

FCC ID: 2AKXB-W4001100

Report Number : **ZKT-230817L6446E**

Date of Test Aug. 15, 2023 to Aug. 18, 2023

Date of issue : Aug. 23, 2023

Total number of pages 64

Test Result : PASS

Testing Laboratory : **Shenzhen ZKT Technology Co., Ltd.**

Address : 1/F, No. 101, Building B, No. 6, Tangwei Community Industrial Avenue, Fuhai Street, Bao'an District, Shenzhen, China

Applicant's name : **Woan Technology (Shenzhen) Co., Ltd.**

Address : Room 1101, Qiancheng Commercial Center, No. 5 Haicheng Road, Mabu Community, Xixiang Sub-district, Bao'an District, Shenzhen, Guangdong, P.R.China, 518100

Manufacturer's name : **Woan Technology (Shenzhen) Co., Ltd.**

Address : Room 1101, Qiancheng Commercial Center, No. 5 Haicheng Road, Mabu Community, Xixiang Sub-district, Bao'an District, Shenzhen, Guangdong, P.R.China, 518100

Test specification:

Standard : FCC CFR Title 47 Part 15 Subpart C Section 15.247
ANSI C63.10:2013

Test procedure : /

Non-standard test method : N/A

Test Report Form No. : TRF-EL-110_V0

Test Report Form(s) Originator : ZKT Testing

Master TRF : Dated: 2020-01-06

This device described above has been tested by ZKT, and the test results show that the equipment under test (EUT) is in compliance with the FCC requirements. And it is applicable only to the tested sample identified in the report.

This report shall not be reproduced except in full, without the written approval of ZKT, this document may be altered or revised by ZKT, personal only, and shall be noted in the revision of the document.

Product name : **SwitchBot Pan/Tilt Cam 3K**

Trademark : SwitchBot

Model/Type reference : W4001100

Ratings : Input: DC 5V, 2A



Testing procedure and testing location:

Testing Laboratory.....: **Shenzhen ZKT Technology Co., Ltd.**

Address.....: 1/F, No. 101, Building B, No. 6, Tangwei Community
Industrial Avenue, Fuhai Street, Bao'an District,
Shenzhen, China

Tested by (name + signature).....: **Jim.Liu**

Reviewer (name + signature).....: **Jackson.Fang**

Approved (name + signature).....: **Lake Xie**



Table of Contents

	Page
1. VERSION	5
2. SUMMARY OF TEST RESULTS	6
2.1 TEST FACILITY	7
2.2 MEASUREMENT UNCERTAINTY	7
3. GENERAL INFORMATION	8
3.1 GENERAL DESCRIPTION OF EUT	8
3.2 DESCRIPTION OF TEST MODES	9
3.3 BLOCK DIGRAM SHOWING THE CONFIGURATION OF SYSTEM TESTED	9
3.4 DESCRIPTION OF SUPPORT UNITS(CONDUCTED MODE)	9
3.5EQUIPMENTS LIST FOR ALL TEST ITEMS	10
4. EMC EMISSION TEST	12
4.1 CONDUCTED EMISSION MEASUREMENT	12
4.1.1 POWER LINE CONDUCTED EMISSION LIMITS	12
4.1.2 TEST PROCEDURE	12
4.1.3 DEVIATION FROM TEST STANDARD	12
4.1.4 TEST SETUP	13
4.1.5 EUT OPERATING CONDITIONS	13
4.2 RADIATED EMISSION MEASUREMENT	16
4.2.1 RADIATED EMISSION LIMITS	16
4.2.2 TEST PROCEDURE	17
4.2.3 DEVIATION FROM TEST STANDARD	17
4.2.4 TEST SETUP	17
4.2.5 EUT OPERATING CONDITIONS	18
4.2.6 TEST RESULTS	18
5.RADIATED BAND EMISSIONMEASUREMENT	24
5.1 TEST REQUIREMENT:	24
5.2 TEST PROCEDURE	24
5.3 DEVIATION FROM TEST STANDARD	25
5.4 TEST SETUP	25
5.5 EUT OPERATING CONDITIONS	25
5.6 TEST RESULT	25
6.POWER SPECTRAL DENSITY TEST	29
6.1 APPLIED PROCEDURES / LIMIT	29
6.2 TEST PROCEDURE	29
6.3 DEVIATION FROM STANDARD	29
6.4 TEST SETUP	29
6.5 EUT OPERATION CONDITIONS	29



6.6 TEST RESULT	30
7. CHANNEL BANDWIDTH & 99% OCCUPY BANDWIDTH	35
7.1 APPLIED PROCEDURES / LIMIT	35
7.2 TEST PROCEDURE	35
7.3 DEVIATION FROM STANDARD	35
7.4 TEST SETUP	35
7.5 EUT OPERATION CONDITIONS	35
7.6 TEST RESULT	36
8. PEAK OUTPUT POWER TEST	46
8.1 APPLIED PROCEDURES/LIMIT	46
8.2 TEST PROCEDURE	46
8.3 DEVIATION FROM STANDARD	46
8.4 TEST SETUP	46
8.5 EUT OPERATION CONDITIONS	46
8.6 TEST RESULT	47
9. CONDUCTED BAND EDGE AND SPURIOUS EMISSION	48
9.1 APPLICABLE STANDARD	48
9.2 TEST PROCEDURE	48
9.3 DEVIATION FROM STANDARD	48
9.4 TEST SETUP	48
9.5 EUT OPERATION CONDITIONS	48
9.6 TEST RESULTS	48
10. ANTENNA REQUIREMENT	63
11. TEST SETUP PHOTO	64
12. EUT CONSTRUCTIONAL DETAILS	64



1. VERSION

Report No.	Version	Description	Approved
ZKT-230817L6446E	Rev.01	Initial issue of report	Aug. 23, 2023



2. SUMMARY OF TEST RESULTS

Test procedures according to the technical standards:

FCC Part15 (15.247) , Subpart C			
Standard Section	Test Item	Result	Remark
FCC part 15.203/15.247 (c)	Antenna requirement	PASS	
FCC part 15.207	AC Power Line Conducted Emission	PASS	
FCC part 15.247 (b)(3)	Conducted Peak Output Power	PASS	
FCC part 15.247 (a)(2)	Channel Bandwidth & 99% OCB	PASS	
FCC part 15.247 (e)	Power Spectral Density	PASS	
FCC part 15.247(d)	Band Edge	PASS	
FCC part 15.205/15.209	Spurious Emission	PASS	

NOTE:

(1)" N/A" denotes test is not applicable in this Test Report



2.1 TEST FACILITY

Shenzhen ZKT Technology Co., Ltd.
Add.: 1/F, No. 101, Building B, No. 6, Tangwei Community Industrial Avenue, Fuhai Street, Bao'an District, Shenzhen, China

FCC Test Firm Registration Number: 692225
Designation Number: CN1299
IC Registered No.: 27033
CAB identifier: CN0110

2.2 MEASUREMENT UNCERTAINTY

The reported uncertainty of measurement $y \pm U$ · where expanded uncertainty U is based on a standard uncertainty multiplied by a coverage factor of $k=2$ · providing a level of confidence of approximately 95 % .

No.	Item	Uncertainty
1	3m chamber Radiated spurious emission(9KHz-30MHz)	U=4.5dB
2	3m chamber Radiated spurious emission(30MHz-1GHz)	U=4.8dB
3	3m chamber Radiated spurious emission(1GHz-6GHz)	U=4.9dB
4	3m chamber Radiated spurious emission(6GHz-40GHz)	U=5.0dB
5	Conducted disturbance	U=3.2dB
6	RF Band Edge	U=1.68dB
7	RF power conducted	U=1.86dB
8	RF conducted Spurious Emission	U=2.2dB
9	RF Occupied Bandwidth	U=1.8KHz
10	RF Power Spectral Density	U=1.75dB
11	humidity uncertainty	U=5.3%
12	Temperature uncertainty	U=0.59°C



3. GENERAL INFORMATION

3.1 GENERAL DESCRIPTION OF EUT

Product Name:	SwitchBot Pan/Tilt Cam 3K
Model No.:	W4001100
Serial No.:	W4001101, W4001102, W4001103, W4001104, W4001105
Model Different.:	All models are same with electrical parameters and internal circuit structure, but only differ in model name. (this information provided by the customer)
Hardware Version:	V5.3
Software Version:	V2.0.3.25
Sample ID	ZKT-230817L6446E-01
Sample(s) Status:	Engineer sample
Channel numbers:	802.11b/802.11g /802.11n(HT20):11
Channel separation:	5MHz
Modulation technology:	802.11b: Direct Sequence Spread Spectrum(DSSS) 802.11g/802.11n(HT20): Orthogonal Frequency Division Multiplexing(OFDM)
Worst Case:	802.11n(HT20)
Antenna Type and Antenna gain:	802.11b/g/n: Monopole Antenna Antenna gain: 2.34dBi
Power supply:	AC 120V, 60Hz/AC 240V, 60Hz
Switching power adapter:	AC 100-240V, 50/60Hz, 2A

Operation Frequency each of channel							
Channel	Frequency	Chann el	Frequency	Chann el	Frequency	Chann el	Frequency
1	2412MHz	4	2427MHz	7	2442MHz	10	2457MHz
2	2417MHz	5	2432MHz	8	2447MHz	11	2462MHz
3	2422MHz	6	2437MHz	9	2452MHz	X	

Note:

In section 15.31(m), regards to the operating frequency range over 10 MHz, the Lowest frequency, the middle frequency, and the highest frequency of channel were selected to perform the test, and the selected channel see below:

Test channel	Frequency (MHz)	
	802.11b/802.11g/802.11n(HT20)	/
Lowest channel	2412MHz	/
Middle channel	2437MHz	/
Highest channel	2462MHz	/



3.2 DESCRIPTION OF TEST MODES

Transmitting mode	Keep the EUT in continuously transmitting mode
Remark: During the test, the duty cycle >98%, the test voltage was tuned from 85% to 115% of the nominal rated supply voltage, and found that the worst case was under the nominal rated supply condition. So the report just shows that condition's data.	

We have verified the construction and function in typical operation. All the test modes were carried out with the EUT in transmitting operation, which was shown in this test report and defined as follows:				
Pre-scan all kind of data rate in lowest channel, and found the follow list which it was worst case.				
Mode	802.11b	802.11g	802.11n(HT20)	802.11n(HT40)
Data rate	1Mbps	6Mbps	6.5Mbps	13Mbps

Test Software	ESPTest Tool
Power level setup	<17dBm

3.3 BLOCK DIGRAM SHOWING THE CONFIGURATION OF SYSTEM TESTED

Conducted Emission

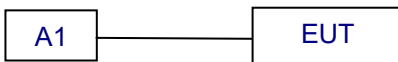

Radiated Emission

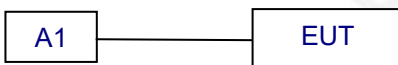

Conducted Spurious

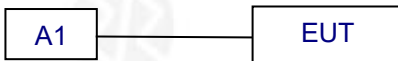

3.4 DESCRIPTION OF SUPPORT UNITS(CONDUCTED MODE)

The EUT has been tested as an independent unit together with other necessary accessories or support units. The following support units or accessories were used to form a representative test configuration during the tests.

Item	Equipment	Mfr/Brand	Model/Type No.	Series No.	Note
E-1	SwitchBot Pan/Tilt Cam 3K	SwitchBot	W4001100	N/A	EUT
A-1	AC/DC ADAPTER	SHENZHEN KEYU POWER SUPPLY TECHNOLOGY CO.,LTD.	KA12C-0502000US	N/A	Auxiliary

Item	Shielded Type	Ferrite Core	Length	Note

Note:

- (1) The support equipment was authorized by Declaration of Confirmation.
- (2) For detachable type I/O cable should be specified the length in cm in 『Length』 column.



3.5EQUIPMENTS LIST FOR ALL TEST ITEMS

Conduction Test equipment

Item	Kind of Equipment	Manufacturer	Type No.	Serial No.	Firmware Version	Last calibration	Calibrated until
1	LISN	R&S	ENV216	101471	N/A	Oct. 21, 2022	Oct. 20, 2023
2	LISN	CYBERTEK	EM5040A	E1850400149	N/A	Oct. 21, 2022	Oct. 20, 2023
3	Test Cable	N/A	C-01	N/A	N/A	Oct. 21, 2022	Oct. 20, 2023
4	Test Cable	N/A	C-02	N/A	N/A	Oct. 21, 2022	Oct. 20, 2023
5	Test Cable	N/A	C-03	N/A	N/A	Oct. 21, 2022	Oct. 20, 2023
6	EMI Test Receiver	R&S	ESC13	101393	4.42 SP3	Oct. 28, 2022	Oct. 27, 2023
7	Triple-Loop Antenna	N/A	RF300	N/A	N/A	Oct. 28, 2022	Oct. 27, 2023
8	Absorbing Clamp	DZ	ZN23201	15034	N/A	Oct. 31, 2022	Oct. 30, 2023
9	EMC Software	Frad	EZ-EMC	Ver.EMC-CO N 3A1.1	N/A	\	\

Radiation Test equipment

Item	Equipment	Manufacturer	Type No.	Serial No.	Firmware Version	Last calibration	Calibrated until
1	Spectrum Analyzer	KEYSIGHT	9020A	MY55370835	A.17.05	Oct. 28, 2022	Oct. 27, 2023
	(9kHz-26.5GHz)						
2	Spectrum Analyzer (10kHz-39.9GHz)	R&S	FSV40-N	100363	1.71 SP2	Oct. 28, 2022	Oct. 27, 2023
3	EMI Test Receiver	R&S	ESC17	101169	4.32	Oct. 28, 2022	Oct. 27, 2023
	(9kHz-7GHz)						
4	Bilog Antenna	Schwarzbeck	VULB9168	N/A	N/A	Nov. 02, 2022	Nov. 01, 2023
	(30MHz-1500MHz)						
5	Horn Antenna	Agilent	AH-118	071145	N/A	Nov. 01, 2022	Oct. 31, 2023
	(1GHz-18GHz)						
6	Horn Antenna (15GHz-40GHz)	A.H.System	SAS-574	588	N/A	Oct. 28, 2022	Oct. 27, 2023
7	Loop Antenna	TESEQ	HLA6121	58357	N/A	Nov. 01, 2022	Oct. 31, 2023
8	Amplifier	EM Electronics	EM330 Amplifier	060747	N/A	Nov. 15, 2022	Nov. 14, 2023
	(30-1000MHz)						
9	Amplifier (1GHz-26.5GHz)	Agilent	8449B	3008A00315	N/A	Oct. 28, 2022	Oct. 27, 2023
10	Amplifier (500MHz-40GHz)	Quanjuda	DLE-161	097	N/A	Oct. 28, 2022	Oct. 27, 2023
11	Test Cable	N/A	R-01	N/A	N/A	Oct. 28, 2022	Oct. 27, 2023
12	Test Cable	N/A	R-02	N/A	N/A	Oct. 28, 2022	Oct. 27, 2023



13	Test Cable	N/A	R-03	N/A	N/A	Oct. 28, 2022	Oct. 27, 2023
14	Test Cable	N/A	RF-01	N/A	N/A	Oct. 28, 2022	Oct. 27, 2023
15	Test Cable	N/A	RF-02	N/A	N/A	Oct. 28, 2022	Oct. 27, 2023
16	Test Cable	N/A	RF-03	N/A	N/A	Oct. 28, 2022	Oct. 27, 2023
17	ESG Signal Generator	Agilent	E4421B	N/A	B.03.84	Oct. 21, 2022	Oct. 20, 2023
18	Signal Generator	Agilent	N5182A	N/A	A.01.87	Oct. 21, 2022	Oct. 20, 2023
19	Magnetic Field Probe Tester	Narda	ELT-400	0-0344	N/A	Nov. 15, 2022	Nov. 14, 2023
20	Wideband Radio Communication Test	R&S	CMW500	106504	V 3.7.22	Oct. 28, 2022	Oct. 27, 2023
21	MWRF Power Meter Test system	MW	MW100-RF CB	N/A	N/A	Oct. 21, 2022	Oct. 20, 2023
22	D.C. Power Supply	LongWei	TPR-6405D	N/A	N/A	\	\
23	EMC Software	Frad	EZ-EMC	Ver.EMC-CO N 3A1.1	N/A	\	\
24	RF Software	MW	MTS8310	V2.0.0.0	N/A	\	\
25	Turntable	MF	MF-7802BS	N/A	N/A	\	\
26	Antenna tower	MF	MF-7802BS	N/A	N/A	\	\



4. EMC EMISSION TEST

4.1 CONDUCTED EMISSION MEASUREMENT

Test Requirement:	FCC Part15 C Section 15.207
Test Method:	ANSI C63.10:2013
Test Frequency Range:	150KHz to 30MHz
Receiver setup:	RBW=9KHz, VBW=30KHz, Sweep time=auto

4.1.1 POWER LINE CONDUCTED EMISSION Limits

FREQUENCY (MHz)	Limit (dBuV)		Standard
	Quasi-peak	Average	
0.15 -0.5	66 - 56 *	56 - 46 *	FCC
0.50 -5.0	56.00	46.00	FCC
5.0 -30.0	60.00	50.00	FCC

Note:

(1) *Decreases with the logarithm of the frequency.

4.1.2 TEST PROCEDURE

- The EUT was placed 0.1 meters from the horizontal ground plane with EUT being connected to the power mains through a line impedance stabilization network (LISN). All other support equipments powered from additional LISN(s). The LISN provide 50 Ohm/ 50uH of coupling impedance for the measuring instrument.
- Interconnecting cables that hang closer than 40 cm to the ground plane shall be folded back and forth in the center forming a bundle 30 to 40 cm long.
- I/O cables that are not connected to a peripheral shall be bundled in the center. The end of the cable may be terminated, if required, using the correct terminating impedance. The overall length shall not exceed 1 m.
- LISN at least 80 cm from nearest part of EUT chassis.
- For the actual test configuration, please refer to the related Item –EUT Test Photos.

4.1.3 DEVIATION FROM TEST STANDARD

No deviation



4.1.4 TEST SETUP

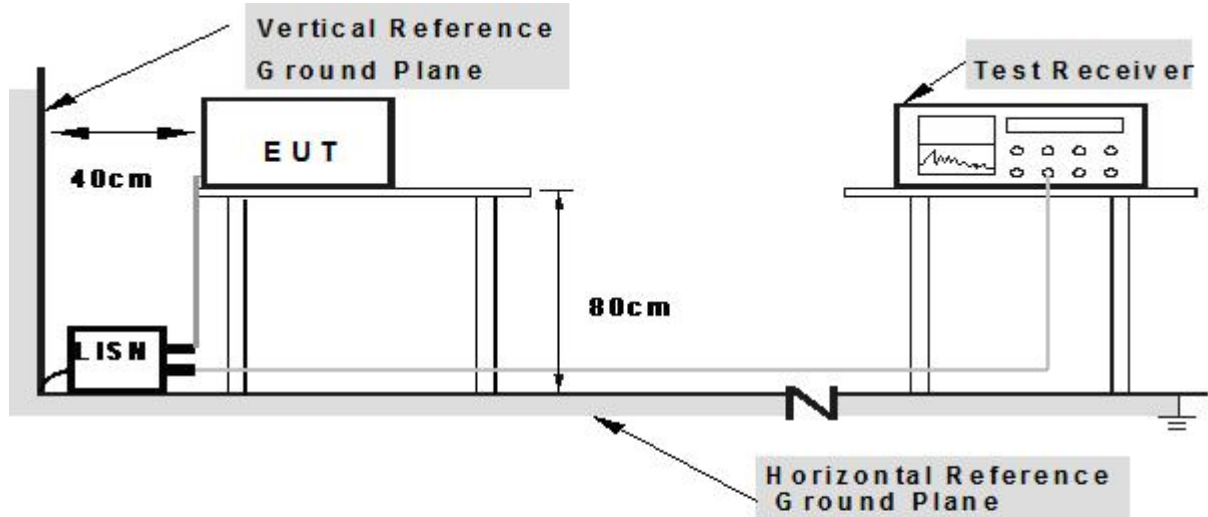

Note: 1. Support units were connected to second LISN.

2. Both of LISNs (AMN) are 80 cm from EUT and at least 80 cm from other units and other metal planes

4.1.5 EUT OPERATING CONDITIONS

The EUT was configured for testing in a typical fashion (as a customer would normally use it). The EUT has been programmed to continuously transmit during test. This operating condition was tested and used to collect the included data.

We pretest AC 120V and AC 240V, the worst voltage was AC 120V and the data recording in the report.



4.1.6 Test Result

Temperature:	24°C	Relative Humidity:	56%
Pressure:	101 kPa	Polarization:	L
Test Voltage:	AC 120V/60Hz		

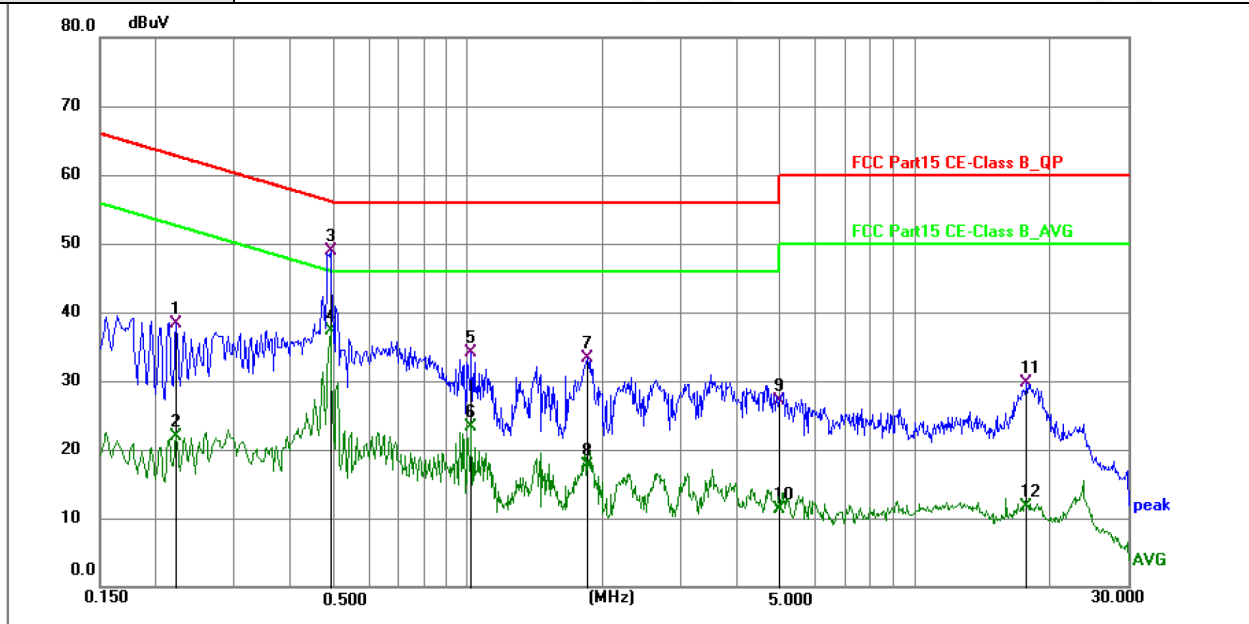

No.	Frequency (MHz)	Reading (dBuV)	Factor (dB)	Level (dBuV)	Limit (dBuV)	Margin (dB)	Detector	P/F	Remark
1	0.2220	28.45	9.92	38.37	62.74	-24.37	QP	P	
2	0.2220	11.92	9.92	21.84	52.74	-30.90	AVG	P	
3 *	0.4920	39.02	9.97	48.99	56.13	-7.14	QP	P	
4	0.4920	27.28	9.97	37.25	46.13	-8.88	AVG	P	
5	1.0182	24.01	10.01	34.02	56.00	-21.98	QP	P	
6	1.0182	13.25	10.01	23.26	46.00	-22.74	AVG	P	
7	1.8510	23.37	9.99	33.36	56.00	-22.64	QP	P	
8	1.8510	7.67	9.99	17.66	46.00	-28.34	AVG	P	
9	4.9740	17.20	10.00	27.20	56.00	-28.80	QP	P	
10	4.9740	1.39	10.00	11.39	46.00	-34.61	AVG	P	
11	17.8125	19.69	10.08	29.77	60.00	-30.23	QP	P	
12	17.8125	1.72	10.08	11.80	50.00	-38.20	AVG	P	

Level = Reading + Factor Margin = Level - Limit



Temperature:	24°C	Relative Humidity:	56%
Pressure:	101 kPa	Polarization:	N
Test Voltage:	AC 120V/60Hz		

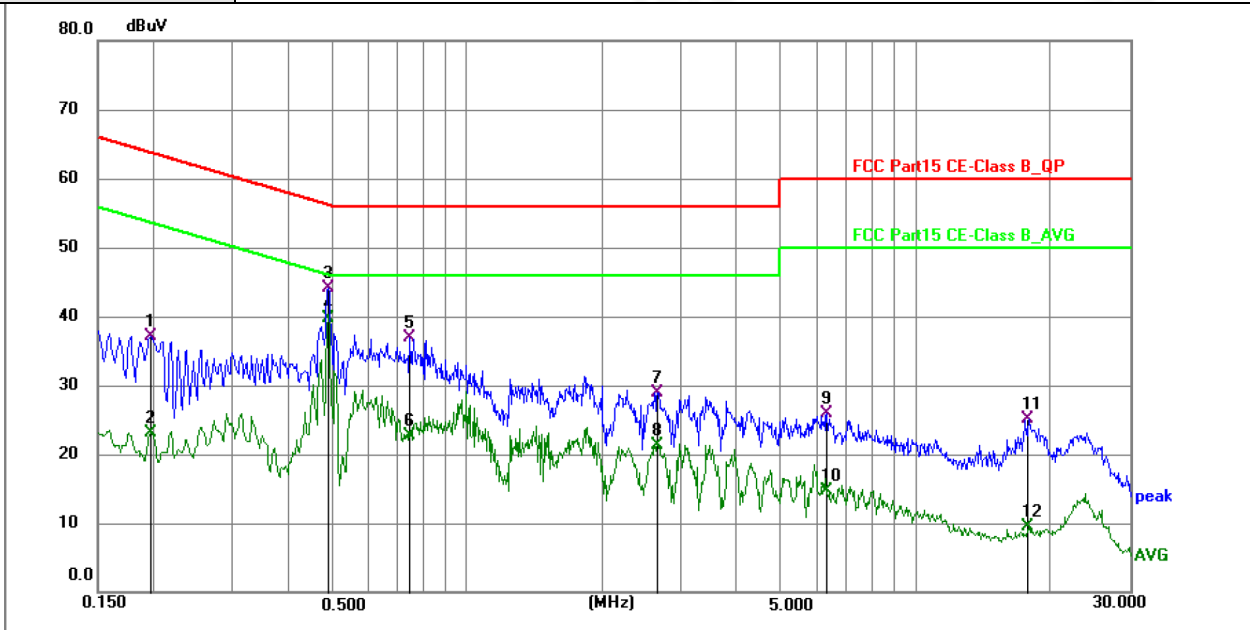

No.	Frequency (MHz)	Reading (dBuV)	Factor (dB)	Level (dBuV)	Limit (dBuV)	Margin (dB)	Detector	P/F	Remark
1	0.1965	27.16	9.94	37.10	63.76	-26.66	QP	P	
2	0.1965	13.08	9.94	23.02	53.76	-30.74	AVG	P	
3	0.4873	34.18	10.00	44.18	56.21	-12.03	QP	P	
4 *	0.4873	29.73	10.00	39.73	46.21	-6.48	AVG	P	
5	0.7440	26.90	10.01	36.91	56.00	-19.09	QP	P	
6	0.7440	12.76	10.01	22.77	46.00	-23.23	AVG	P	
7	2.6520	18.88	10.02	28.90	56.00	-27.10	QP	P	
8	2.6520	11.31	10.02	21.33	46.00	-24.67	AVG	P	
9	6.3330	15.87	10.03	25.90	60.00	-34.10	QP	P	
10	6.3330	4.70	10.03	14.73	50.00	-35.27	AVG	P	
11	17.8931	15.03	10.09	25.12	60.00	-34.88	QP	P	
12	17.8931	-0.64	10.09	9.45	50.00	-40.55	AVG	P	

Level = Reading + Factor Margin = Level - Limit



4.2 RADIATED EMISSION MEASUREMENT

Test Requirement:	FCC Part15 C Section 15.209				
Test Method:	ANSI C63.10:2013				
Test Frequency Range:	9kHz to 25GHz				
Test site:	Measurement Distance: 3m				
Receiver setup:	Frequency	Detector	RBW	VBW	Value
	9KHz-150KHz	Quasi-peak	200Hz	600Hz	Quasi-peak
	150KHz-30MHz	Quasi-peak	9KHz	30KHz	Quasi-peak
	30MHz-1GHz	Quasi-peak	100KHz	300KHz	Quasi-peak
	Above 1GHz	Peak	1MHz	3MHz	Peak
		Peak	1MHz	10Hz	Average

4.2.1 RADIATED EMISSION LIMITS

Frequencies (MHz)	Field Strength (micovolts/meter)	Measurement Distance (meters)
0.009~0.490	2400/F(KHz)	300
0.490~1.705	24000/F(KHz)	30
1.705~30.0	30	30
30~88	100	3
88~216	150	3
216~960	200	3
Above 960	500	3

LIMITS OF RADIATED EMISSION MEASUREMENT

FREQUENCY (MHz)	Limit (dBuV/m) (at 3M)	
	PEAK	AVERAGE
Above 1000	74	54

Notes:

- (1) The limit for radiated test was performed according to FCC PART 15C.
- (2) The tighter limit applies at the band edges.
- (3) Emission level (dBuV/m)=20log Emission level (uV/m).



4.2.2 TEST PROCEDURE

Below 1GHz test procedure as below:

- a. The EUT was placed on the top of a rotating table 0.1 meters above the ground at a 3 meter semi-anechoic chamber. The table was rotated 360 degrees to determine the position of the highest radiation.
- b. The EUT was set 3 meters away from the interference-receiving antenna, which was mounted on the top of a variable-height antenna tower.
- c. The antenna height is varied from one meter to four meters above the ground to determine the maximum value of the field strength. Both horizontal and vertical polarizations of the antenna are set to make the measurement.
- d. For each suspected emission, the EUT was arranged to its worst case and then the antenna was tuned to heights from 1 meter to 4 meters (for the test frequency of below 30MHz, the antenna was tuned to heights 1 meter) and the rotatable table was turned from 0 degrees to 360 degrees to find the maximum reading.
- e. The test-receiver system was set to Peak Detect Function and Specified Bandwidth with Maximum Hold Mode.
- f. If the emission level of the EUT in peak mode was 10dB lower than the limit specified, then testing could be stopped and the peak values of the EUT would be reported. Otherwise the emissions that did not have 10dB margin would be re-tested one by one using peak, quasi-peak or average method as specified and then reported in a data sheet.

Above 1GHz test procedure as below:

- g. Different from above is the test site, change from Semi-Anechoic Chamber to fully Anechoic Chamber and change from table 0.8 meter to 1.5 meter (Above 18GHz the distance is 1 meter and table is 1.5 meter).
- h. Test the EUT in the lowest channel, the middle channel, the Highest channel

Note:

Both horizontal and vertical antenna polarities were tested and performed pretest to three orthogonal axis. The worst case emissions were reported

4.2.3 DEVIATION FROM TEST STANDARD

No deviation

4.2.4 TEST SETUP

(A) Radiated Emission Test-Up Frequency Below 30MHz

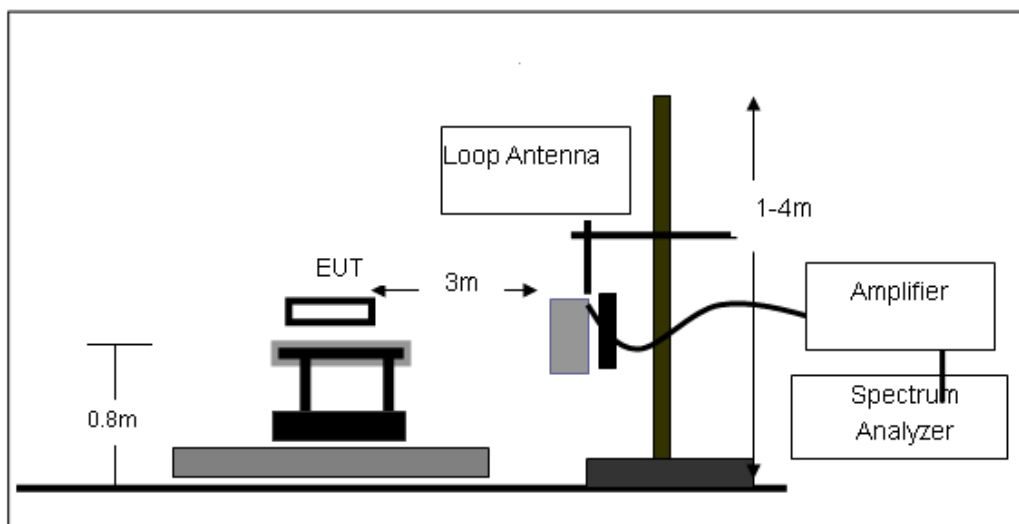



(B) Radiated Emission Test-Up Frequency 30MHz~1GHz

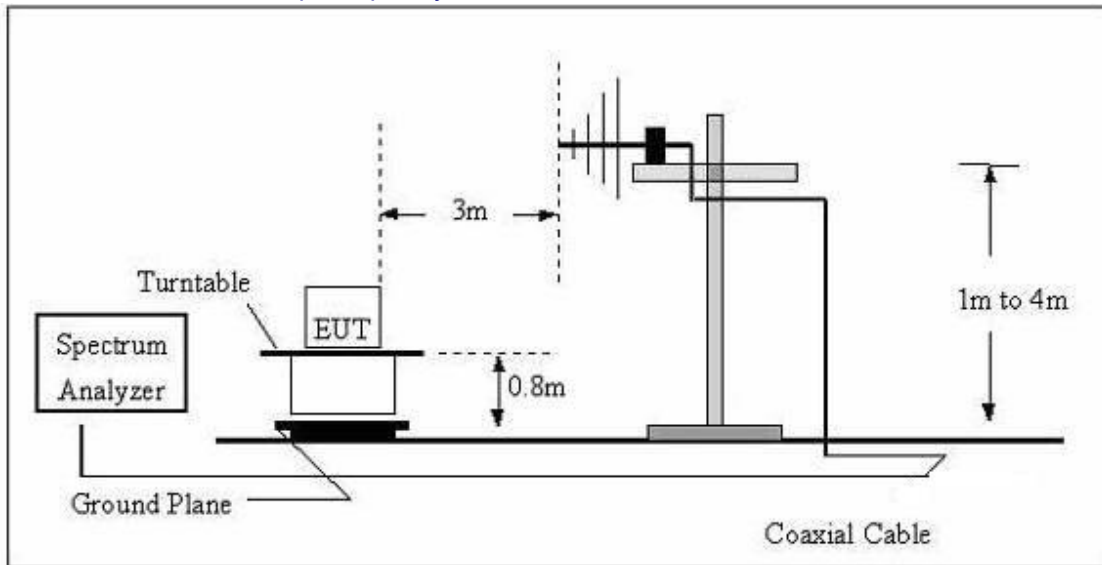

(C) Radiated Emission Test-Up Frequency Above 1GHz

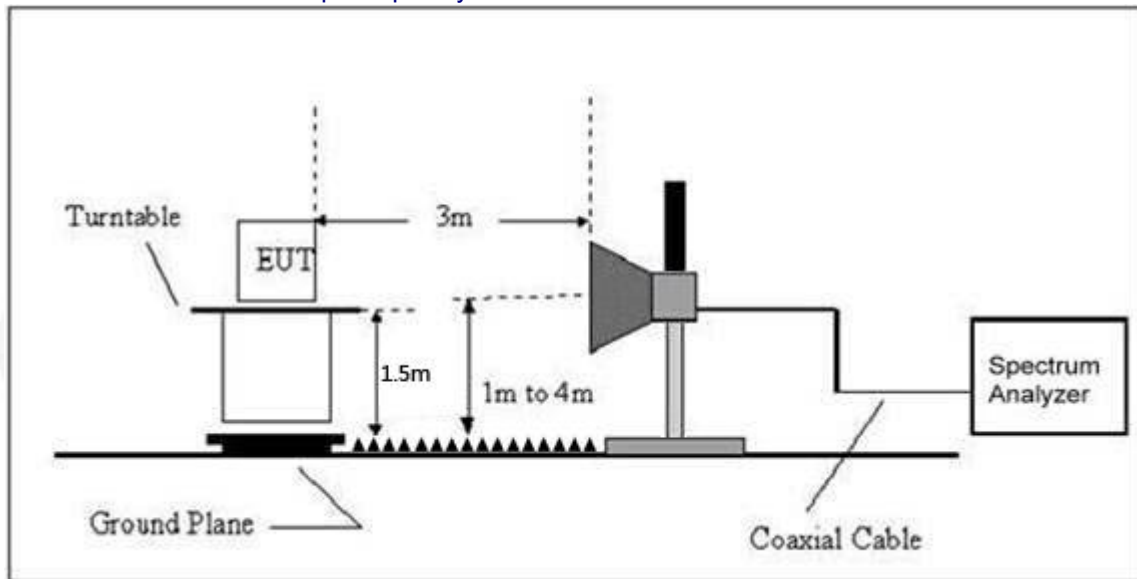

4.2.5 EUT OPERATING CONDITIONS

The EUT tested system was configured as the statements of 2.4 Unless otherwise a special operating condition is specified in the follows during the testing.

4.2.6 TEST RESULTS

Between 9KHz – 30MHz

The emission from 9 kHz to 30MHz was pre-tested and found the result was 20dB lower than the limit, and according to 15.31(o), the test result no need to reported.



Between 30MHz – 1GHz

Temperature:	26°C	Relative Humidity:	58%
Pressure:	101 kPa	Polarization:	Horizontal
Test Voltage:	AC 120V, 60Hz	Test Mode	Working

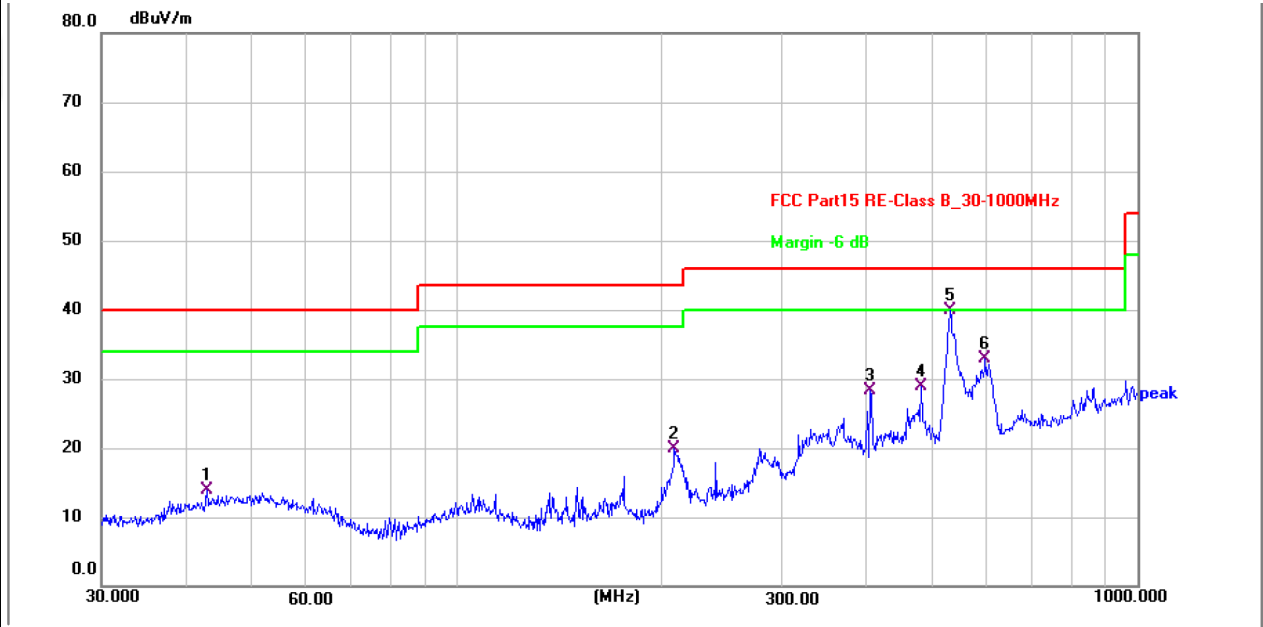

No.	Frequency (MHz)	Reading (dBuV)	Factor (dB/m)	Level (dBuV/m)	Limit (dBuV/m)	Margin (dB)	Detector	P/F
1	42.8998	28.00	-14.12	13.88	40.00	-26.12	QP	P
2	208.5803	34.23	-14.38	19.85	43.50	-23.65	QP	P
3	404.6665	37.92	-9.66	28.26	46.00	-17.74	QP	P
4	480.5276	37.44	-8.60	28.84	46.00	-17.16	QP	P
5 *	530.1014	47.43	-7.62	39.81	46.00	-6.19	QP	P
6	597.2234	38.83	-5.87	32.96	46.00	-13.04	QP	P



Temperature:	26°C	Relative Humidity:	58%
Pressure:	101kPa	Polarization:	Vertical
Test Voltage:	AC 120V, 60Hz	Test Mode	Working

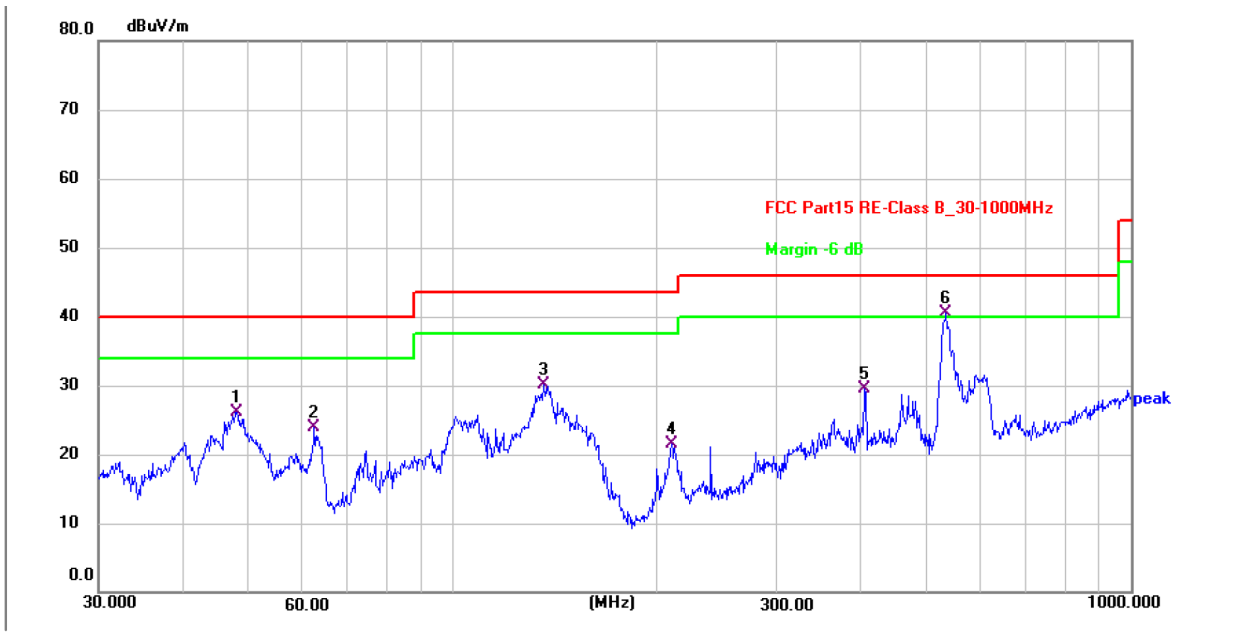

No.	Frequency (MHz)	Reading (dBuV)	Factor (dB/m)	Level (dBuV/m)	Limit (dBuV/m)	Margin (dB)	Detector	P/F
1	47.9940	39.79	-13.67	26.12	40.00	-13.88	QP	P
2	62.4314	39.25	-15.36	23.89	40.00	-16.11	QP	P
3	135.9822	47.44	-17.41	30.03	43.50	-13.47	QP	P
4	210.0482	35.77	-14.36	21.41	43.50	-22.09	QP	P
5	404.6665	39.23	-9.66	29.57	46.00	-16.43	QP	P
6 *	533.8321	47.85	-7.42	40.43	46.00	-5.57	QP	P

Remarks:

1. Level = Reading + Factor Margin = Level - Limit
2. The emission levels of other frequencies are very lower than the limit and not show in test report.
3. The test data shows only the worst case 802.11n(HT20) CH01.

**Test Results (Above 1000MHz)**

Test Mode: 802.11n(HT20) Mode					Test channel: Lowest			
Peak Value								
Frequency (MHz)	Read Level (dBuV)	Antenna Factor (dB/m)	Cable Loss (dB)	Preamp Factor (dB)	Level (dBuV/m)	Limit (dBuV/m)	Over Limit (dB)	Pol.
4824.00	40.50	34.13	6.61	34.09	47.15	74.00	-26.85	V
7236.00	34.35	37.14	7.74	34.51	44.72	74.00	-29.28	V
9648.00	32.81	39.35	9.26	34.80	46.62	74.00	-27.38	V
12060.00	*					74.00		V
14472.00	*					74.00		V
16884.00	*					74.00		V
4824.00	39.14	34.13	6.61	34.09	45.79	74.00	-28.21	H
7236.00	34.08	37.14	7.74	34.51	44.45	74.00	-29.55	H
9648.00	32.38	39.35	9.26	34.80	46.19	74.00	-27.81	H
12060.00	*					74.00		H
14472.00	*					74.00		H
16884.00	*					74.00		H
Average Value								
Frequency (MHz)	Read Level (dBuV)	Antenna Factor (dB/m)	Cable Loss (dB)	Preamp Factor (dB)	Level (dBuV/m)	Limit (dBuV/m)	Over Limit (dB)	Pol.
4824.00	29.57	34.13	6.61	34.09	36.22	54.00	-17.78	V
7236.00	23.21	37.14	7.74	34.51	33.58	54.00	-20.42	V
9648.00	23.15	39.35	9.26	34.80	36.96	54.00	-17.04	V
12060.00	*					54.00		V
14472.00	*					54.00		V
16884.00	*					54.00		V
4824.00	28.67	34.13	6.61	34.09	35.32	54.00	-18.68	H
7236.00	22.66	37.14	7.74	34.51	33.03	54.00	-20.97	H
9648.00	22.12	39.35	9.26	34.80	35.93	54.00	-18.07	H
12060.00	*					54.00		H
14472.00	*					54.00		H
16884.00	*					54.00		H

**Test Results (Above 1000MHz)**

Test Mode: 802.11n(HT20) Mode					Test channel: Middle			
Peak Value								
Frequency (MHz)	Read Level (dBuV)	Antenna Factor (dB/m)	Cable Loss (dB)	Preamp Factor (dB)	Level (dBuV/m)	Limit (dBuV/m)	Over Limit (dB)	Pol.
4874.00	39.52	34.35	6.67	34.09	46.45	74.00	-27.55	V
7311.00	34.40	37.21	7.77	34.53	44.85	74.00	-29.15	V
9748.00	33.81	39.45	9.33	34.80	47.79	74.00	-26.21	V
12185.00	*					74.00		V
14622.00	*					74.00		V
17059.00	*					74.00		V
4874.00	39.98	34.35	6.67	34.09	46.91	74.00	-27.09	H
7311.00	33.03	37.21	7.77	34.53	43.48	74.00	-30.52	H
9748.00	33.69	39.45	9.33	34.80	47.67	74.00	-26.33	H
12185.00	*					74.00		H
14622.00	*					74.00		H
17059.00	*					74.00		H
Average Value								
Frequency (MHz)	Read Level (dBuV)	Antenna Factor (dB/m)	Cable Loss (dB)	Preamp Factor (dB)	Level (dBuV/m)	Limit (dBuV/m)	Over Limit (dB)	Pol.
4874.00	30.36	34.35	6.67	34.09	37.29	54.00	-16.71	V
7311.00	22.71	37.21	7.77	34.53	33.16	54.00	-20.84	V
9748.00	23.06	39.45	9.33	34.80	37.04	54.00	-16.96	V
12185.00	*					54.00		V
14622.00	*					54.00		V
17059.00	*					54.00		V
4874.00	30.08	34.35	6.67	34.09	37.01	54.00	-16.99	H
7311.00	22.11	37.21	7.77	34.53	32.56	54.00	-21.44	H
9748.00	23.41	39.45	9.33	34.80	37.39	54.00	-16.61	H
12185.00	*					54.00		H
14622.00	*					54.00		H
17059.00	*					54.00		H



Test Results (Above 1000MHz)

Test Mode: 802.11n(HT20) Mode					Test channel: Highest			
Peak Value								
Frequency (MHz)	Read Level (dBUV)	Antenna Factor (dB/m)	Cable Loss (dB)	Preamp Factor (dB)	Level (dBUV/m)	Limit (dBUV/m)	Over Limit (dB)	Pol.
4924.00	45.18	34.57	6.74	34.09	52.40	74.00	-21.60	V
7386.00	35.15	37.29	7.80	34.55	45.69	74.00	-28.31	V
9848.00	37.16	39.55	9.41	34.81	51.31	74.00	-22.69	V
12310.00	*					74.00		V
14772.00	*					74.00		V
17234.00	*					74.00		V
4924.00	44.44	34.57	6.74	34.09	51.66	74.00	-22.34	H
7386.00	34.03	37.29	7.80	34.55	44.57	74.00	-29.43	H
9848.00	33.32	39.55	9.41	34.81	47.47	74.00	-26.53	H
12310.00	*					74.00		H
14772.00	*					74.00		H
17234.00	*					74.00		H
Average Value								
Frequency (MHz)	Read Level (dBUV)	Antenna Factor (dB/m)	Cable Loss (dB)	Preamp Factor (dB)	Level (dBUV/m)	Limit (dBUV/m)	Over Limit (dB)	Pol.
4924.00	36.07	34.57	6.74	34.09	43.29	54.00	-10.71	V
7386.00	25.06	37.29	7.80	34.55	35.60	54.00	-18.40	V
9848.00	25.66	39.55	9.41	34.81	39.81	54.00	-14.19	V
12310.00	*					54.00		V
14772.00	*					54.00		V
17234.00	*					54.00		V
4924.00	34.79	34.57	6.74	34.09	42.01	54.00	-11.99	H
7386.00	23.42	37.29	7.80	34.55	33.96	54.00	-20.04	H
9848.00	22.58	39.55	9.41	34.81	36.73	54.00	-17.27	H
12310.00	*					54.00		H
14772.00	*					54.00		H
17234.00	*					54.00		H

Remark:

1. During the test, pre-scan the 802.11b,g,n(HT20) mode, and found the 802.11n(HT20) mode is worse case , the report only record this mode.
2. Level =Receiver Read level + Antenna Factor + Cable Loss – Preamplifier Factor
3. “*”, means this data is the too weak instrument of signal is unable to test.



5. RADIATED BAND EMISSION MEASUREMENT

5.1 TEST REQUIREMENT:

Test Requirement:	FCC Part15 C Section 15.209 and 15.205				
Test Method:	ANSI C63.10: 2013				
Test Frequency Range:	All of the restrict bands were tested, only the worst band's (2310MHz to 2500MHz) data was showed.				
Test site:	Measurement Distance: 3m				
Receiver setup:	Frequency	Detector	RBW	VBW	Value
	Above 1GHz	Peak	1MHz	3MHz	Peak
		Average	1MHz	3MHz	Average

LIMITS OF RADIATED EMISSION MEASUREMENT (Above 1000MHz)

FREQUENCY (MHz)	Class B (dBuV/m) (at 3M)	
	PEAK	AVERAGE
Above 1000	74	54

Notes:

- (1) The limit for radiated test was performed according to FCC PART 15C.
- (2) The tighter limit applies at the band edges.
- (3) Emission level (dBuV/m)=20log Emission level (uV/m).

5.2 TEST PROCEDURE

Above 1GHz test procedure as below:

- a. 1. The EUT was placed on the top of a rotating table 1.5 meters above the ground at a 3 meter camber. The table was rotated 360 degrees to determine the position of the highest radiation.
- b. The EUT was set 3 meters away from the interference-receiving antenna, which was mounted on the top of a variable-height antenna tower.
- c. The antenna height is varied from one meter to four meters above the ground to determine the maximum value of the field strength. Both horizontal and vertical polarizations of the antenna are set to make the measurement.
- d. For each suspected emission, the EUT was arranged to its worst case and then the antenna was tuned to heights from 1 meter to 4 meters and the rota table was turned from 0 degrees to 360 degrees to find the maximum reading.
- e. The test-receiver system was set to Peak Detect Function and Specified Bandwidth with Maximum Hold Mode.
- f. If the emission level of the EUT in peak mode was 10dB lower than the limit specified, then testing could bestopped and the peak values of the EUT would be reported. Otherwise the emissions that did not have 10dBmargin would be re-tested one by one using peak, quasi-peak or average method as specified and then reportedin a data sheet.
- g. Test the EUT in the lowest channel,the Highest channel

Note:



Both horizontal and vertical antenna polarities were tested and performed pretest to three orthogonal axis. The worst case emissions were reported

5.3 DEVIATION FROM TEST STANDARD

No deviation

5.4 TEST SETUP

Radiated Emission Test-Up Frequency Above 1GHz

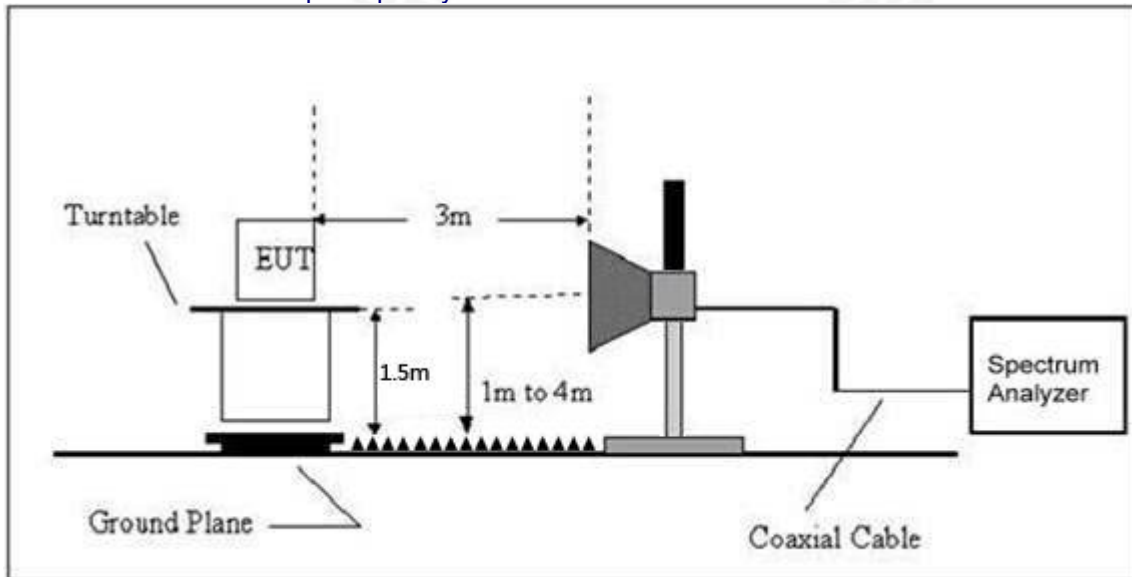

5.5 EUT OPERATING CONDITIONS

The EUT tested system was configured as the statements of 2.3 Unless otherwise a special operating condition is specified in the follows during the testing.

5.6 TEST RESULT

**Radiated Band Edge:**

Test Mode: 802.11b Mode					Test channel: Lowest			
Peak Value								
Frequency (MHz)	Read Level (dBuV)	Antenna Factor (dB/m)	Cable Loss (dB)	Preamp Factor (dB)	Level (dBuV/m)	Limit (dBuV/m)	Over Limit (dB)	Pol.
2390.00	52.49	29.15	3.41	34.01	51.04	74.00	-22.96	H
2400.00	61.79	29.16	3.43	34.01	60.37	74.00	-13.63	H
2390.00	54.24	29.15	3.41	34.01	52.79	74.00	-21.21	V
2400.00	63.82	29.16	3.43	34.01	62.40	74.00	-11.60	V
Average Value								
Frequency (MHz)	Read Level (dBuV)	Antenna Factor (dB/m)	Cable Loss (dB)	Preamp Factor (dB)	Level (dBuV/m)	Limit (dBuV/m)	Over Limit (dB)	Pol.
2390.00	39.01	29.15	3.41	34.01	37.56	54.00	-16.44	H
2400.00	47.40	29.16	3.43	34.01	45.98	54.00	-8.02	H
2390.00	40.90	29.15	3.41	34.01	39.45	54.00	-14.55	V
2400.00	48.59	29.16	3.43	34.01	47.17	54.00	-6.83	V

Test Mode: 802.11b Mode					Test channel: Highest			
Peak Value								
Frequency (MHz)	Read Level (dBuV)	Antenna Factor (dB/m)	Cable Loss (dB)	Preamp Factor (dB)	Level (dBuV/m)	Limit (dBuV/m)	Over Limit (dB)	Pol.
2483.50	53.52	29.28	3.53	34.03	52.30	74.00	-21.70	H
2500.00	49.07	29.30	3.56	34.03	47.90	74.00	-26.10	H
2483.50	55.95	29.28	3.53	34.03	54.73	74.00	-19.27	V
2500.00	51.74	29.30	3.56	34.03	50.57	74.00	-23.43	V
Average Value								
Frequency (MHz)	Read Level (dBuV)	Antenna Factor (dB/m)	Cable Loss (dB)	Preamp Factor (dB)	Level (dBuV/m)	Limit (dBuV/m)	Over Limit (dB)	Pol.
2483.50	39.50	29.28	3.53	34.03	38.28	54.00	-15.72	H
2500.00	35.45	29.30	3.56	34.03	34.28	54.00	-19.72	H
2483.50	41.53	29.28	3.53	34.03	40.31	54.00	-13.69	V
2500.00	37.36	29.30	3.56	34.03	36.19	54.00	-17.81	V

Remark:

1. Level =Receiver Read level + Antenna Factor + Cable Loss – Preamplifier Factor

**Radiated Band Edge:**

Test Mode: 802.11g Mode					Test channel: Lowest			
Peak Value								
Frequency (MHz)	Read Level (dBuV)	Antenna Factor (dB/m)	Cable Loss (dB)	Preamp Factor (dB)	Level (dBuV/m)	Limit (dBuV/m)	Over Limit (dB)	Pol.
2390.00	51.48	27.53	5.47	33.92	50.56	74.00	-23.44	H
2400.00	60.43	27.55	5.49	29.93	63.54	74.00	-10.46	H
2390.00	53.15	27.53	5.47	33.92	52.23	74.00	-21.77	V
2400.00	62.19	27.55	5.49	29.93	65.30	74.00	-8.70	V
Average Value								
Frequency (MHz)	Read Level (dBuV)	Antenna Factor (dB/m)	Cable Loss (dB)	Preamp Factor (dB)	Level (dBuV/m)	Limit (dBuV/m)	Over Limit (dB)	Pol.
2390.00	38.29	27.53	5.47	33.92	37.37	54.00	-16.63	H
2400.00	46.57	27.55	5.49	29.93	49.68	54.00	-4.32	H
2390.00	40.10	27.53	5.47	33.92	39.18	54.00	-14.82	V
2400.00	47.68	27.55	5.49	29.93	50.79	54.00	-3.21	V

Test Mode: 802.11g Mode					Test channel: Highest			
Peak Value								
Frequency (MHz)	Read Level (dBuV)	Antenna Factor (dB/m)	Cable Loss (dB)	Preamp Factor (dB)	Level (dBuV/m)	Limit (dBuV/m)	Over Limit (dB)	Pol.
2483.50	52.06	29.28	3.53	34.03	50.84	74.00	-23.16	H
2500.00	47.94	29.30	3.56	34.03	46.77	74.00	-27.23	H
2483.50	54.29	29.28	3.53	34.03	53.07	74.00	-20.93	V
2500.00	50.42	29.30	3.56	34.03	49.25	74.00	-24.75	V
Average Value								
Frequency (MHz)	Read Level (dBuV)	Antenna Factor (dB/m)	Cable Loss (dB)	Preamp Factor (dB)	Level (dBuV/m)	Limit (dBuV/m)	Over Limit (dB)	Pol.
2483.50	38.63	29.28	3.53	34.03	37.41	54.00	-16.59	H
2500.00	34.76	29.30	3.56	34.03	33.59	54.00	-20.41	H
2483.50	40.56	29.28	3.53	34.03	39.34	54.00	-14.66	V
2500.00	36.64	29.30	3.56	34.03	35.47	54.00	-18.53	V

Remark:

1. Level =Receiver Read level + Antenna Factor + Cable Loss – Preamplifier Factor

**Radiated Band Edge:**

Test Mode: 802.11n(HT20) Mode					Test channel: Lowest			
Peak Value								
Frequency (MHz)	Read Level (dBuV)	Antenna Factor (dB/m)	Cable Loss (dB)	Preamp Factor (dB)	Level (dBuV/m)	Limit (dBuV/m)	Over Limit (dB)	Pol.
2390.00	51.02	27.53	5.47	33.92	50.10	74.00	-23.90	H
2400.00	59.82	27.55	5.49	29.93	62.93	74.00	-11.07	H
2390.00	52.66	27.53	5.47	33.92	51.74	74.00	-22.26	V
2400.00	61.45	27.55	5.49	29.93	64.56	74.00	-9.44	V
Average Value								
Frequency (MHz)	Read Level (dBuV)	Antenna Factor (dB/m)	Cable Loss (dB)	Preamp Factor (dB)	Level (dBuV/m)	Limit (dBuV/m)	Over Limit (dB)	Pol.
2390.00	37.96	27.53	5.47	33.92	37.04	54.00	-16.96	H
2400.00	46.19	27.55	5.49	29.93	49.30	54.00	-4.70	H
2390.00	39.73	27.53	5.47	33.92	38.81	54.00	-15.19	V
2400.00	47.27	27.55	5.49	29.93	50.38	54.00	-3.62	V

Test Mode: 802.11n(HT20) Mode					Test channel: Highest			
Peak Value								
Frequency (MHz)	Read Level (dBuV)	Antenna Factor (dB/m)	Cable Loss (dB)	Preamp Factor (dB)	Level (dBuV/m)	Limit (dBuV/m)	Over Limit (dB)	Pol.
2483.50	51.41	29.28	3.53	34.03	50.19	74.00	-23.81	H
2500.00	47.44	29.30	3.56	34.03	46.27	74.00	-27.73	H
2483.50	53.54	29.28	3.53	34.03	52.32	74.00	-21.68	V
2500.00	49.83	29.30	3.56	34.03	48.66	74.00	-25.34	V
Average Value								
Frequency (MHz)	Read Level (dBuV)	Antenna Factor (dB/m)	Cable Loss (dB)	Preamp Factor (dB)	Level (dBuV/m)	Limit (dBuV/m)	Over Limit (dB)	Pol.
2483.50	38.23	29.28	3.53	34.03	37.01	54.00	-16.99	H
2500.00	34.46	29.30	3.56	34.03	33.29	54.00	-20.71	H
2483.50	40.12	29.28	3.53	34.03	38.90	54.00	-15.10	V
2500.00	36.31	29.30	3.56	34.03	35.14	54.00	-18.86	V

Remark:

1. Level =Receiver Read level + Antenna Factor + Cable Loss – Preamplifier Factor



6. POWER SPECTRAL DENSITY TEST

Test Requirement:	FCC Part15 C Section 15.247 (e)
Test Method:	ANSI C63.10:2013 and KDB558074 D01DTS Meas Guidancev05r02

6.1 APPLIED PROCEDURES / LIMIT

FCC Part15 (15.247) , Subpart C				
Section	Test Item	Limit	Frequency Range (MHz)	Result
15.247	Power Spectral Density	8dBm/3kHz	2400-2483.5	PASS

6.2 TEST PROCEDURE

1. Set analyzer center frequency to DTS channel center frequency.
2. Set the span to 1.5 times the DTS bandwidth.
3. Set the RBW to: $3 \text{ kHz} \leq \text{RBW} \leq 100 \text{ kHz}$.
4. Set the VBW $\geq 3 \times \text{RBW}$.
5. Detector = peak.
6. Sweep time = auto couple.
7. Trace mode = max hold.
8. Allow trace to fully stabilize.
9. Use the peak marker function to determine the maximum amplitude level within the RBW.
10. If measured value exceeds limit, reduce RBW (no less than 3 kHz) and repeat.

6.3 DEVIATION FROM STANDARD

No deviation.

6.4 TEST SETUP



6.5 EUT OPERATION CONDITIONS

The EUT tested system was configured as the statements of 2.1 Unless otherwise a special operating condition is specified in the follows during the testing.



6.6 TEST RESULT

Temperature:	26°C	Relative Humidity:	54%
Pressure:	101kPa	Test Voltage :	AC 120, 60Hz
Test Mode :	TX Mode		

Mode	TX Type	Frequency (MHz)	Maximum PSD (dBm/3kHz)		Verdict
			ANT1	Limit	
802.11b	SISO	2412	-4.64	<=8	Pass
		2437	-3.42	<=8	Pass
		2462	-3.85	<=8	Pass
802.11g	SISO	2412	-9.47	<=8	Pass
		2437	-9.39	<=8	Pass
		2462	-8.51	<=8	Pass
802.11n (HT20)	SISO	2412	-10.13	<=8	Pass
		2437	-9.37	<=8	Pass
		2462	-9.33	<=8	Pass

Test Graph

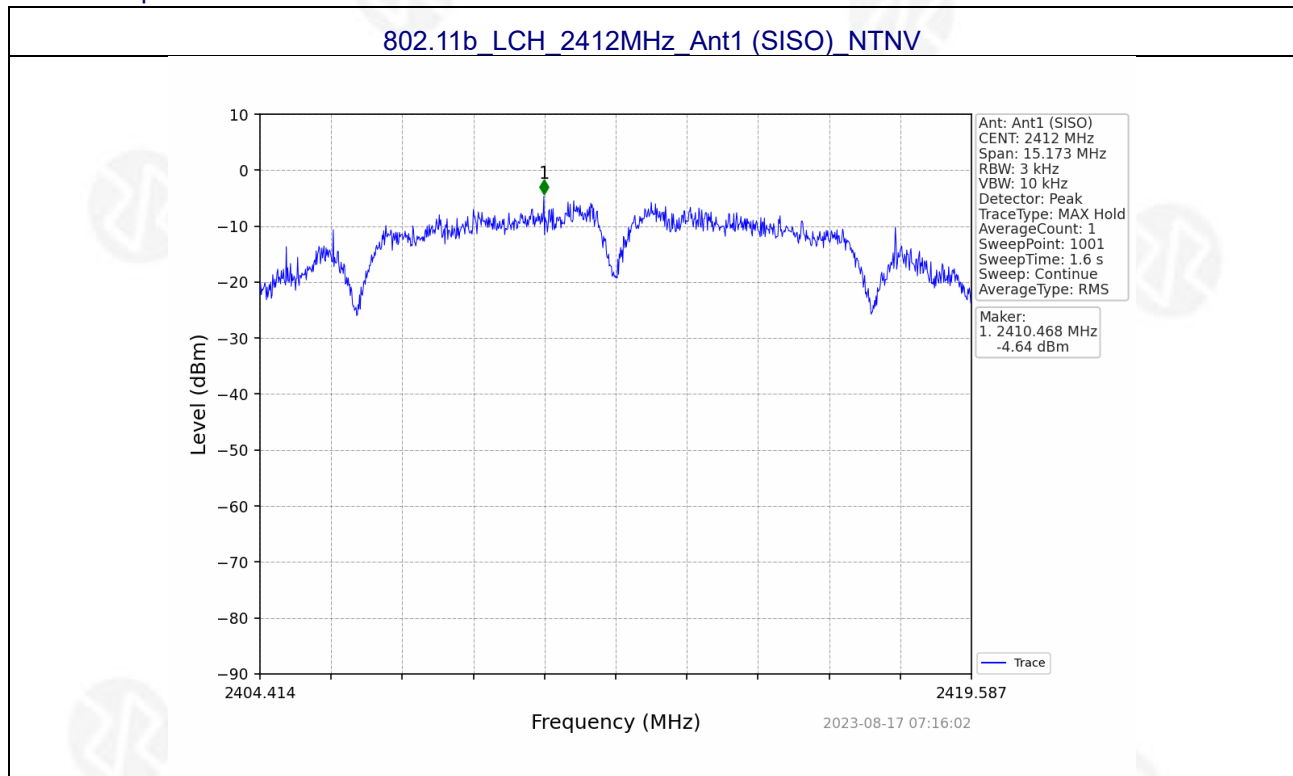



802.11b_MCH_2437MHz_Ant1 (SISO)_NTNV

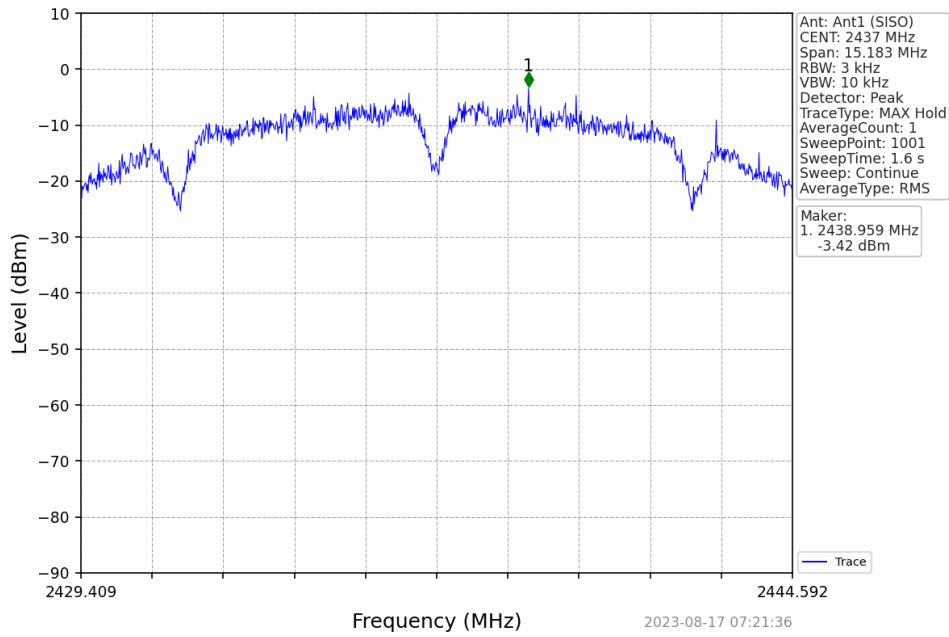

802.11b_HCH_2462MHz_Ant1 (SISO)_NTNV

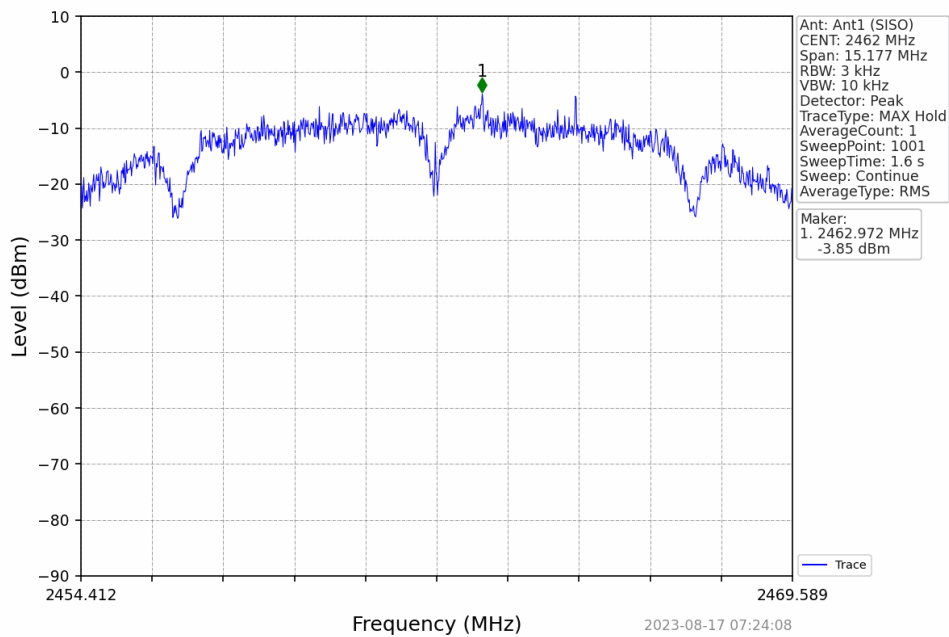



802.11g_LCH_2412MHz_Ant1 (SISO)_NTNV

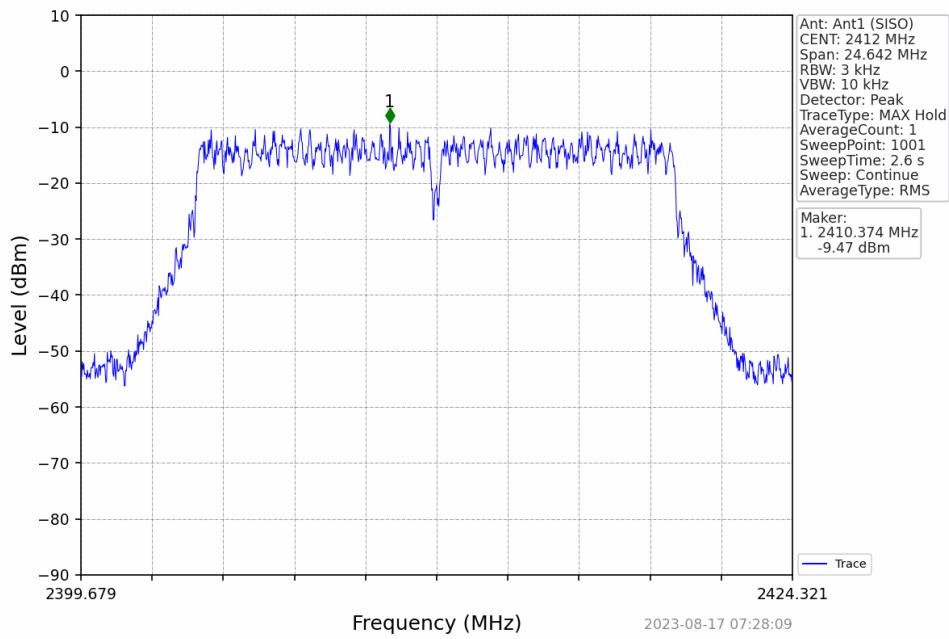

802.11g_MCH_2437MHz_Ant1 (SISO)_NTNV

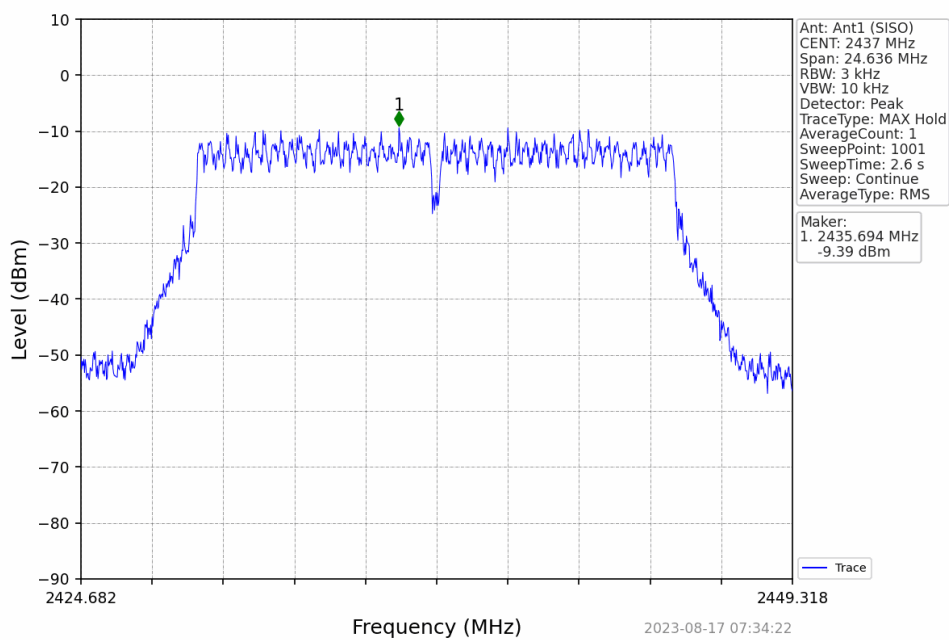



802.11g_HCH_2462MHz_Ant1 (SISO)_NTNV

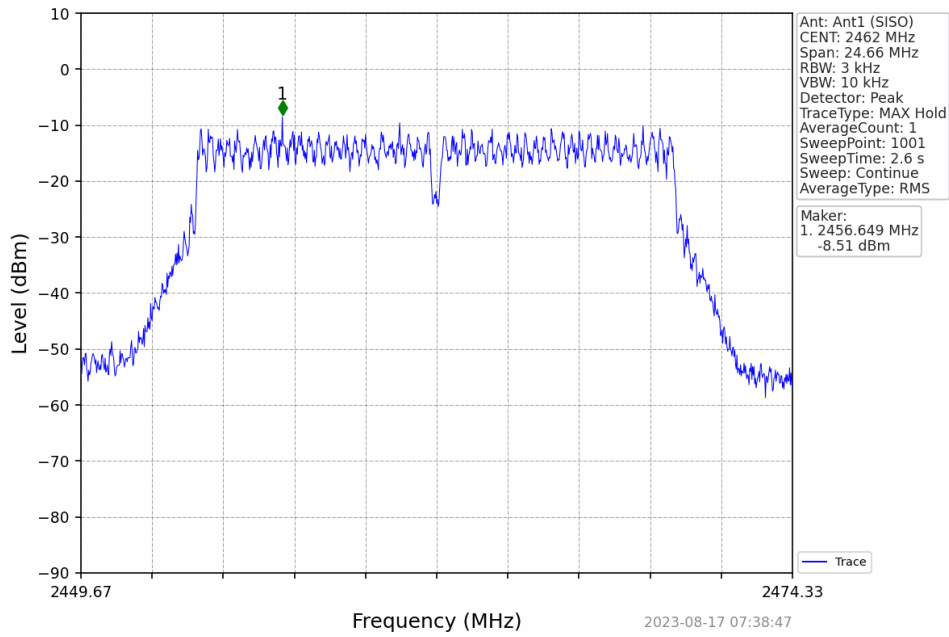

802.11n(HT20)_LCH_2412MHz_Ant1 (SISO)_NTNV

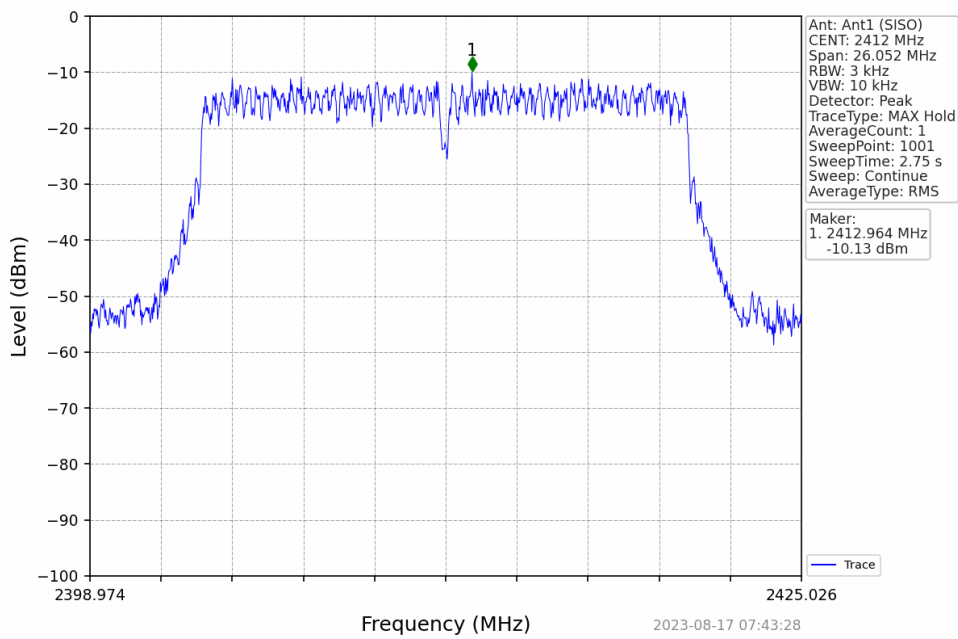



802.11n(HT20)_MCH_2437MHz_Ant1 (SISO)_NTNV

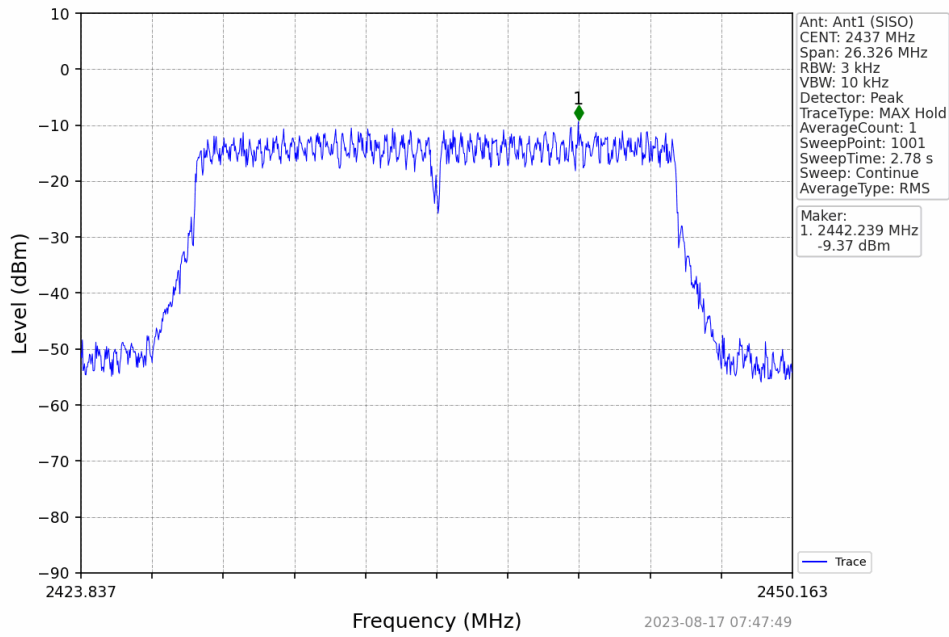

802.11n(HT20)_HCH_2462MHz_Ant1 (SISO)_NTNV

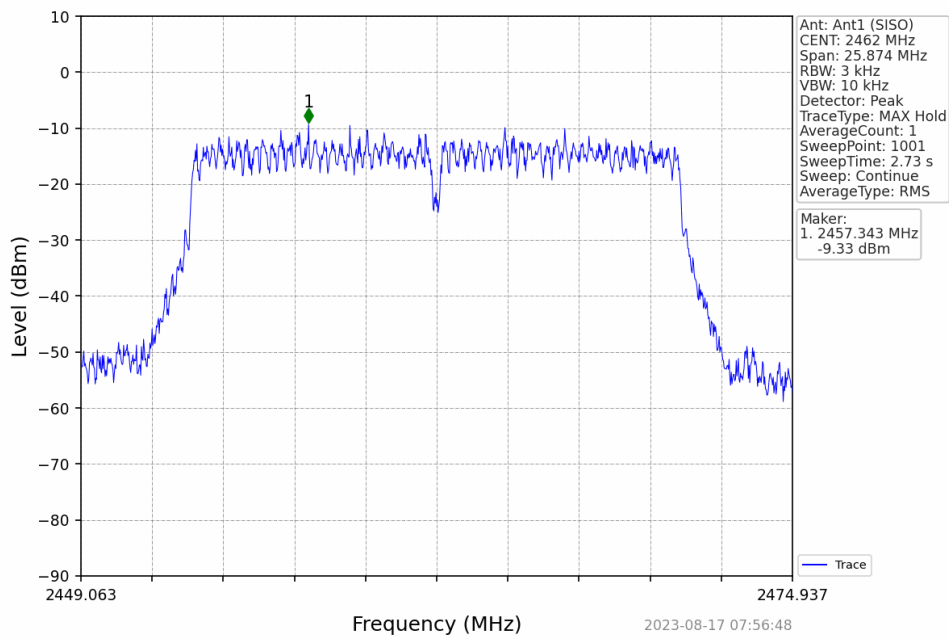



7. CHANNEL BANDWIDTH & 99% OCCUPY BANDWIDTH

Test Requirement:	FCC Part15 C Section 15.247 (a)(2)
Test Method:	ANSI C63.10:2013 and KDB558074 D01DTS Meas Guidancev05r02

7.1 APPLIED PROCEDURES / LIMIT

FCC Part15 (15.247) , Subpart C				
Section	Test Item	Limit	Frequency Range (MHz)	Result
15.247(a)(2)	Bandwidth	$\geq 500\text{KHz}$ (6dB bandwidth)	2400-2483.5	PASS

7.2 TEST PROCEDURE

1. Set RBW = 100 kHz.
2. Set the video bandwidth (VBW) $\geq 3 \times$ RBW.
3. Detector = Peak.
4. Trace mode = max hold.
5. Sweep = auto couple.
6. Allow the trace to stabilize.
7. Measure the maximum width of the emission that is constrained by the frequencies associated with the two outermost amplitude points (upper and lower frequencies) that are attenuated by 6 dB relative to the maximum level measured in the fundamental emission.

7.3 DEVIATION FROM STANDARD

No deviation.

7.4 TEST SETUP

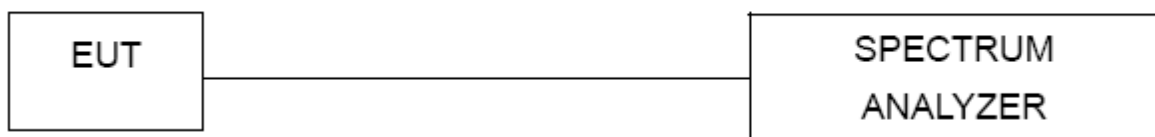

7.5 EUT OPERATION CONDITIONS

The EUT tested system was configured as the statements of 2.4 Unless otherwise a special operating condition is specified in the follows during the testing.



7.6 TEST RESULT

Temperature:	26°C	Relative Humidity:	54%
Pressure:	101kPa	Test Voltage :	AC 120, 60Hz
Test Mode :	TX Mode		

Mode	TX Type	Frequency (MHz)	ANT	99% Occupied Bandwidth (MHz)		Verdict
				Result		
802.11b	SISO	2412	1	14.951		Pass
		2437	1	14.956		Pass
		2462	1	14.959		Pass
802.11g	SISO	2412	1	17.362		Pass
		2437	1	17.424		Pass
		2462	1	17.387		Pass
802.11n (HT20)	SISO	2412	1	18.017		Pass
		2437	1	18.080		Pass
		2462	1	18.013		Pass

Mode	TX Type	Frequency (MHz)	ANT	6dB Bandwidth (MHz)		Verdict
				Result	Limit	
802.11b	SISO	2412	1	10.115	>=0.5	Pass
		2437	1	10.122	>=0.5	Pass
		2462	1	10.118	>=0.5	Pass
802.11g	SISO	2412	1	16.428	>=0.5	Pass
		2437	1	16.424	>=0.5	Pass
		2462	1	16.440	>=0.5	Pass
802.11n (HT20)	SISO	2412	1	17.368	>=0.5	Pass
		2437	1	17.551	>=0.5	Pass
		2462	1	17.249	>=0.5	Pass



Test Graph
99% Occupied Bandwidth

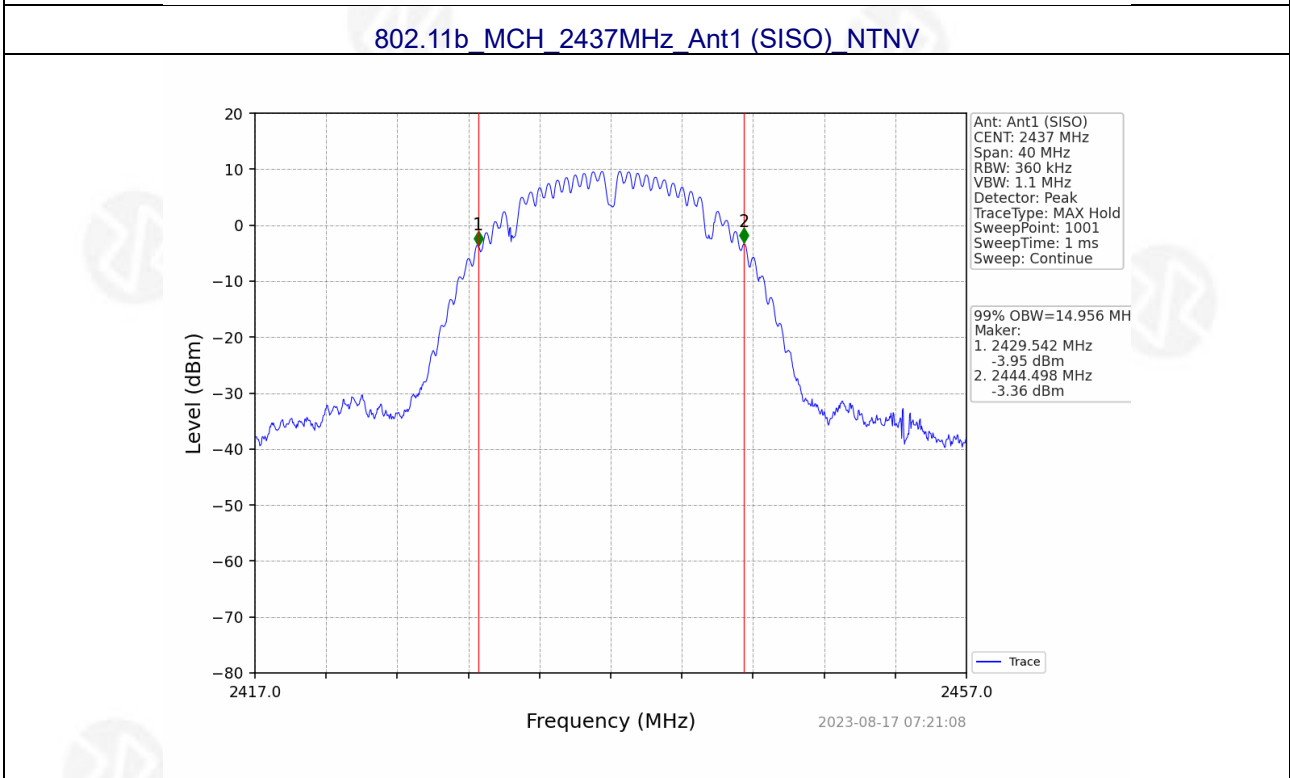
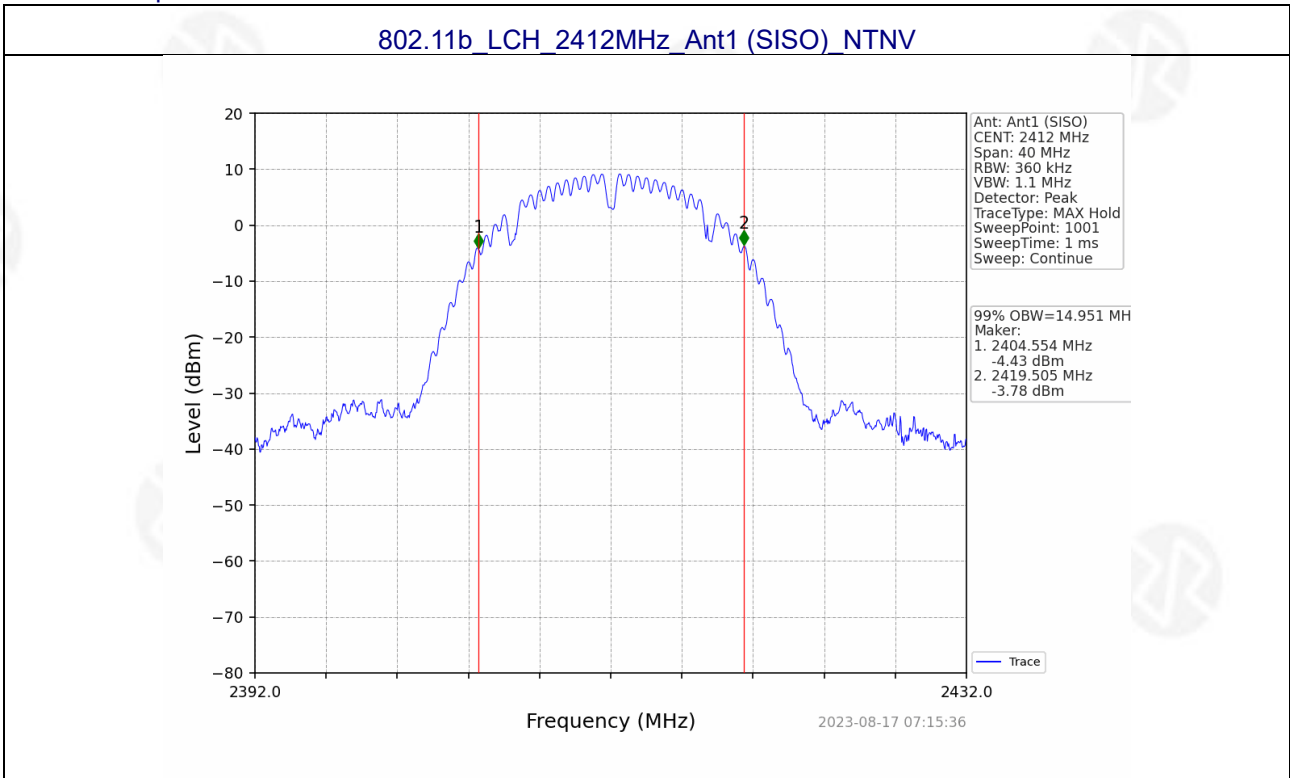



802.11b HCH 2462MHz Ant1 (SISO) NTVN

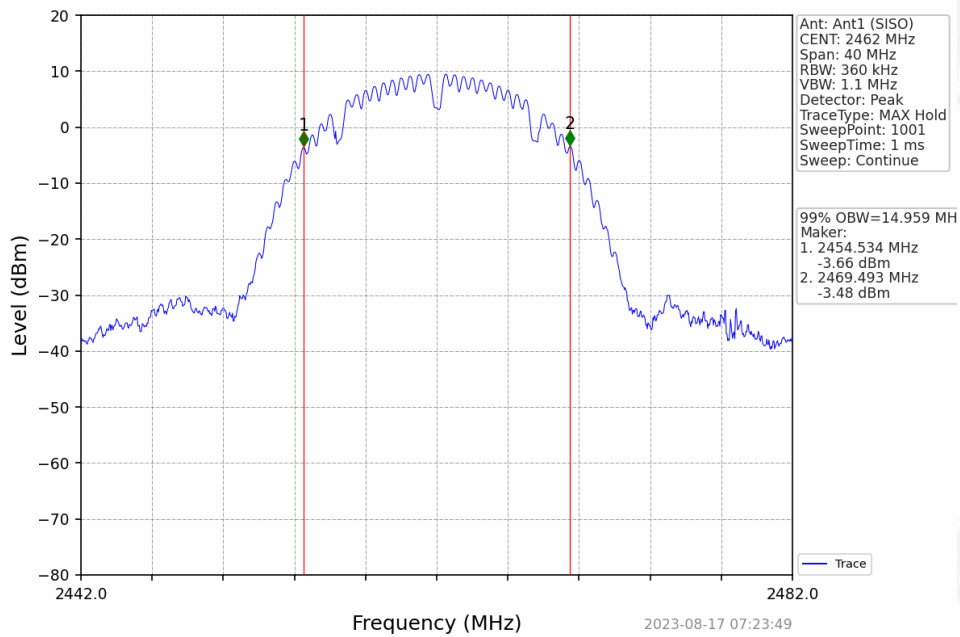

802.11g LCH 2412MHz Ant1 (SISO) NTVN

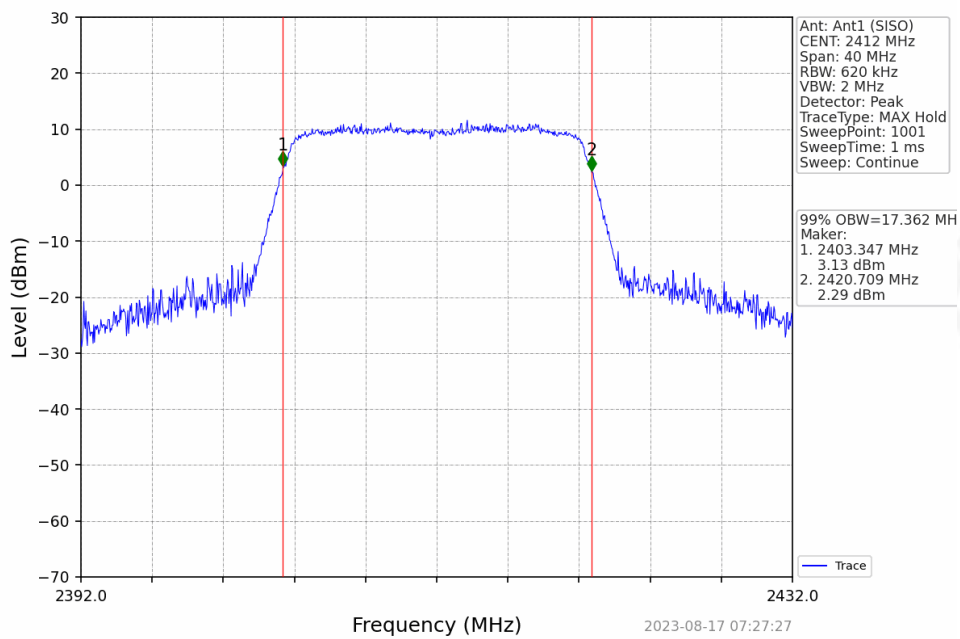



802.11g MCH 2437MHz Ant1 (SISO) NTN

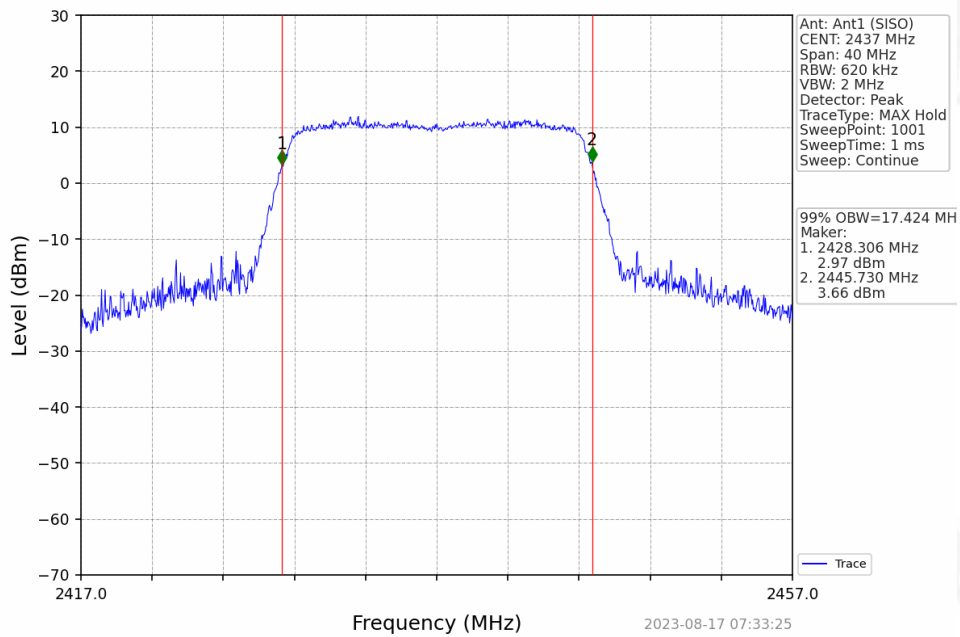

802.11g HCH 2462MHz Ant1 (SISO) NTN

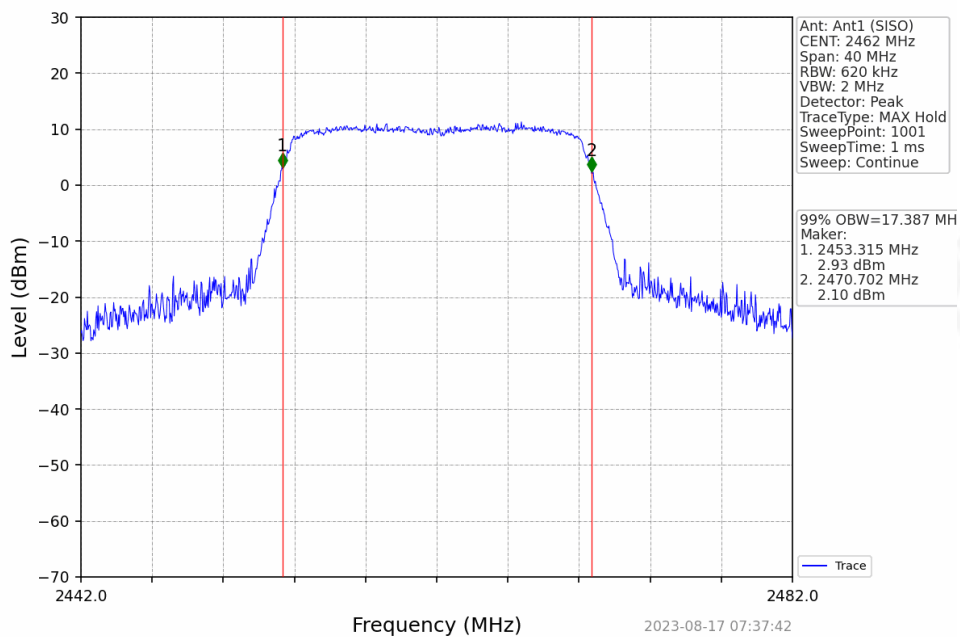



802.11n(HT20) LCH 2412MHz Ant1 (SISO) NTN

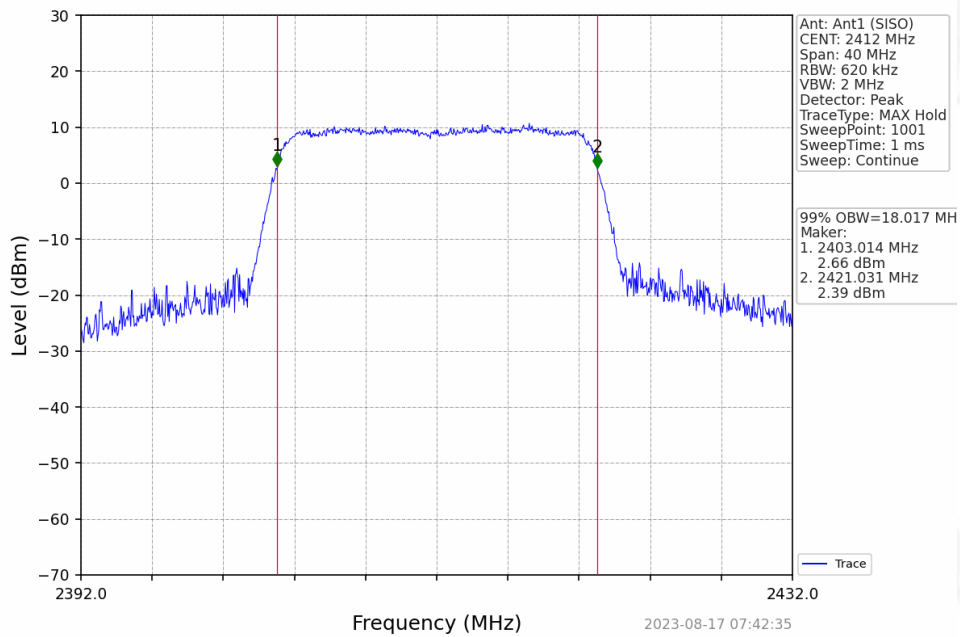

802.11n(HT20) MCH 2437MHz Ant1 (SISO) NTN

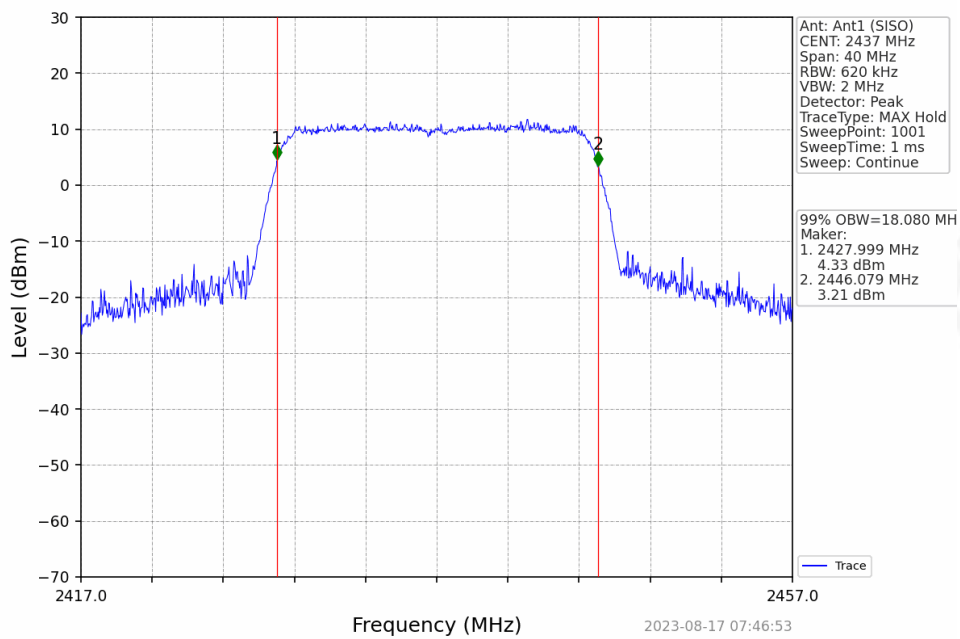

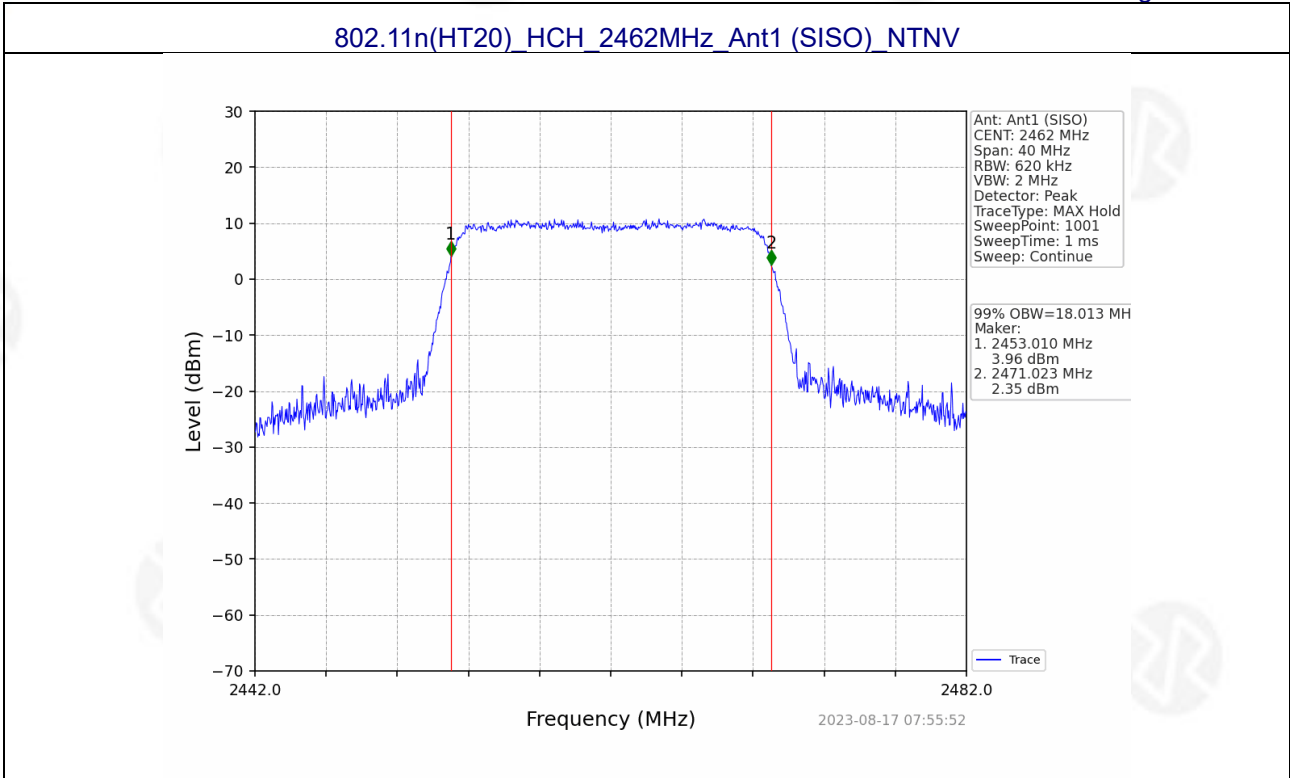

6dB Bandwidth

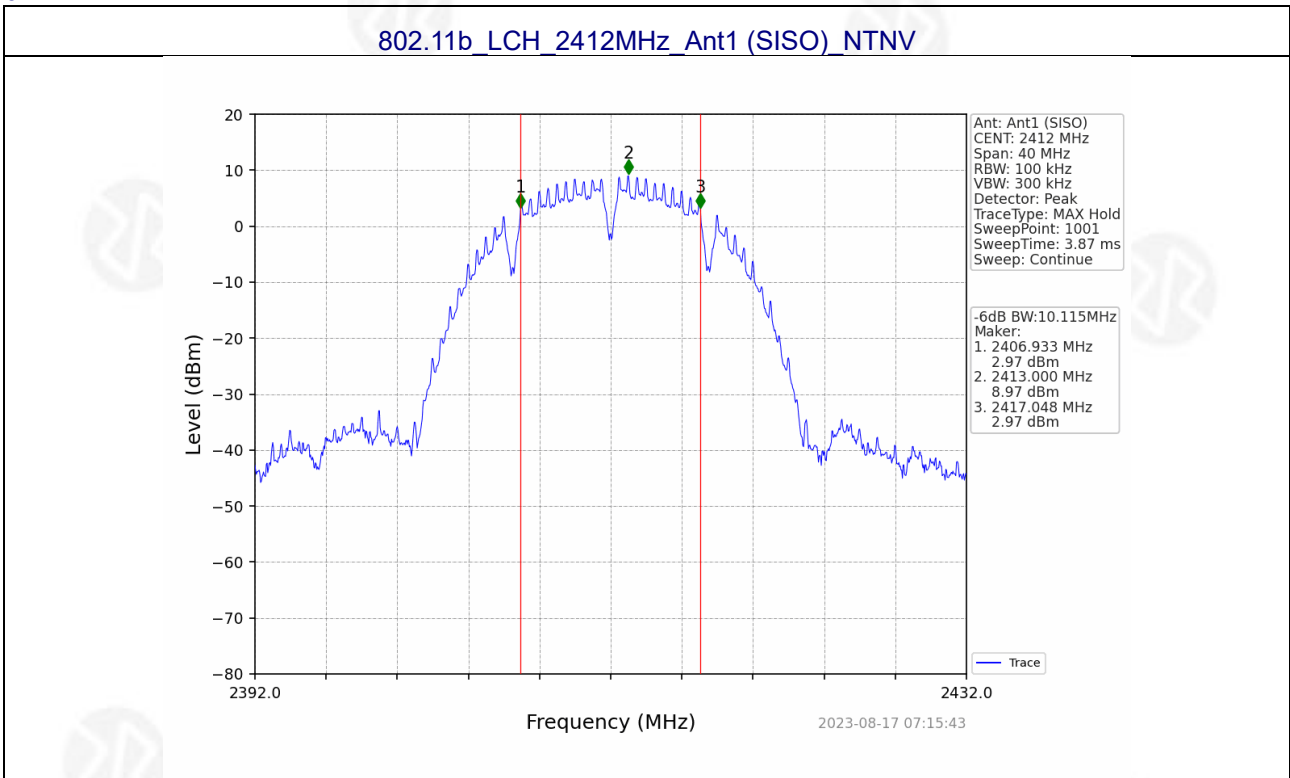



802.11b_MCH_2437MHz_Ant1 (SISO)_NTNV

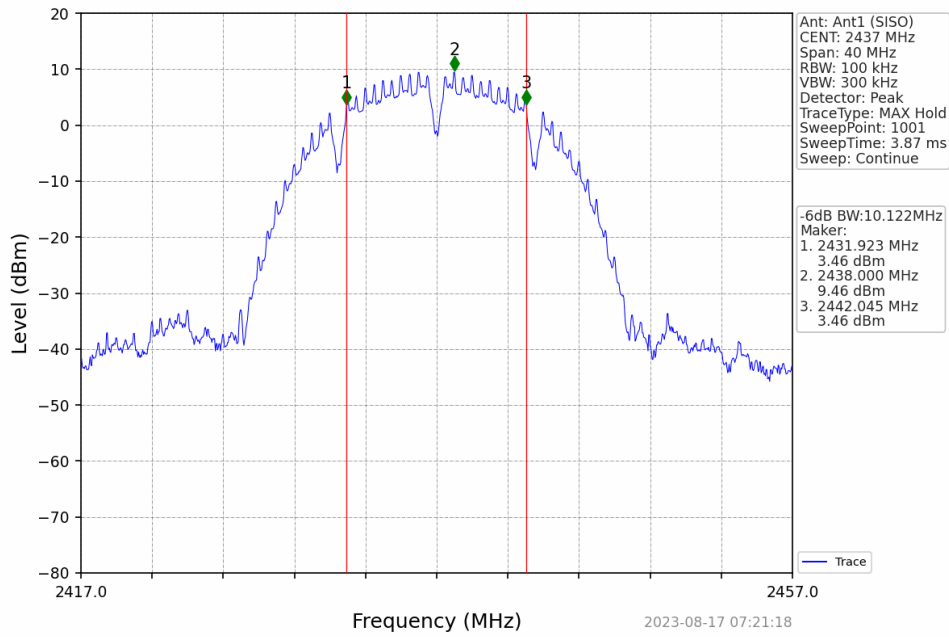

802.11b_HCH_2462MHz_Ant1 (SISO)_NTNV

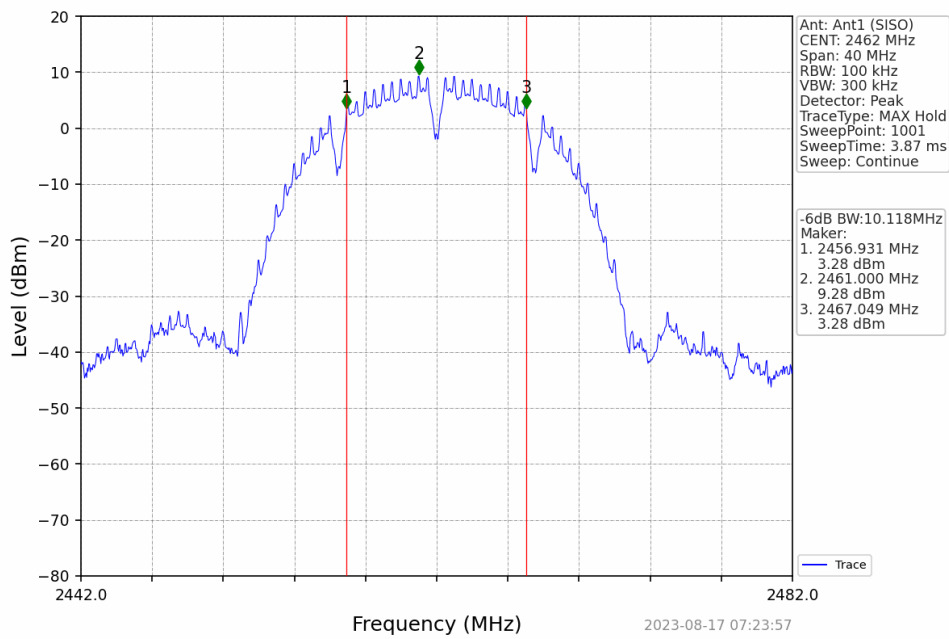

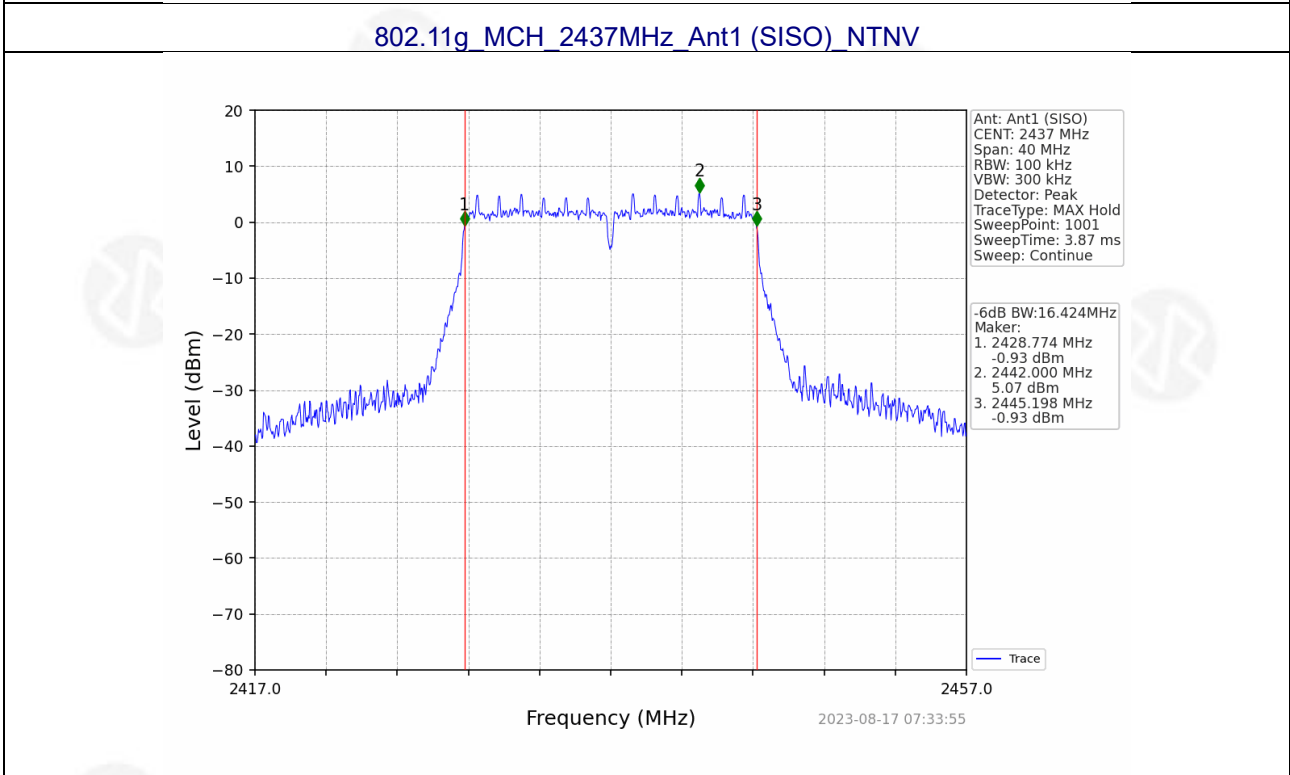
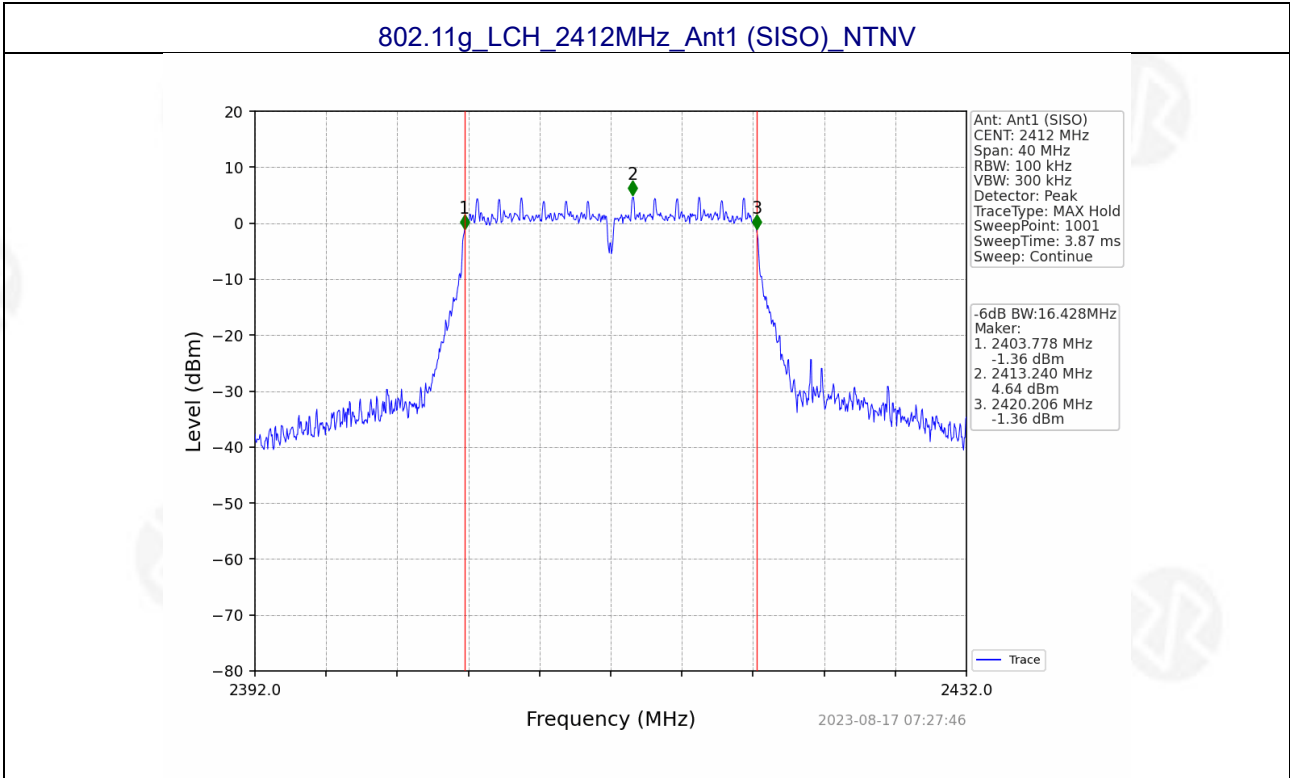

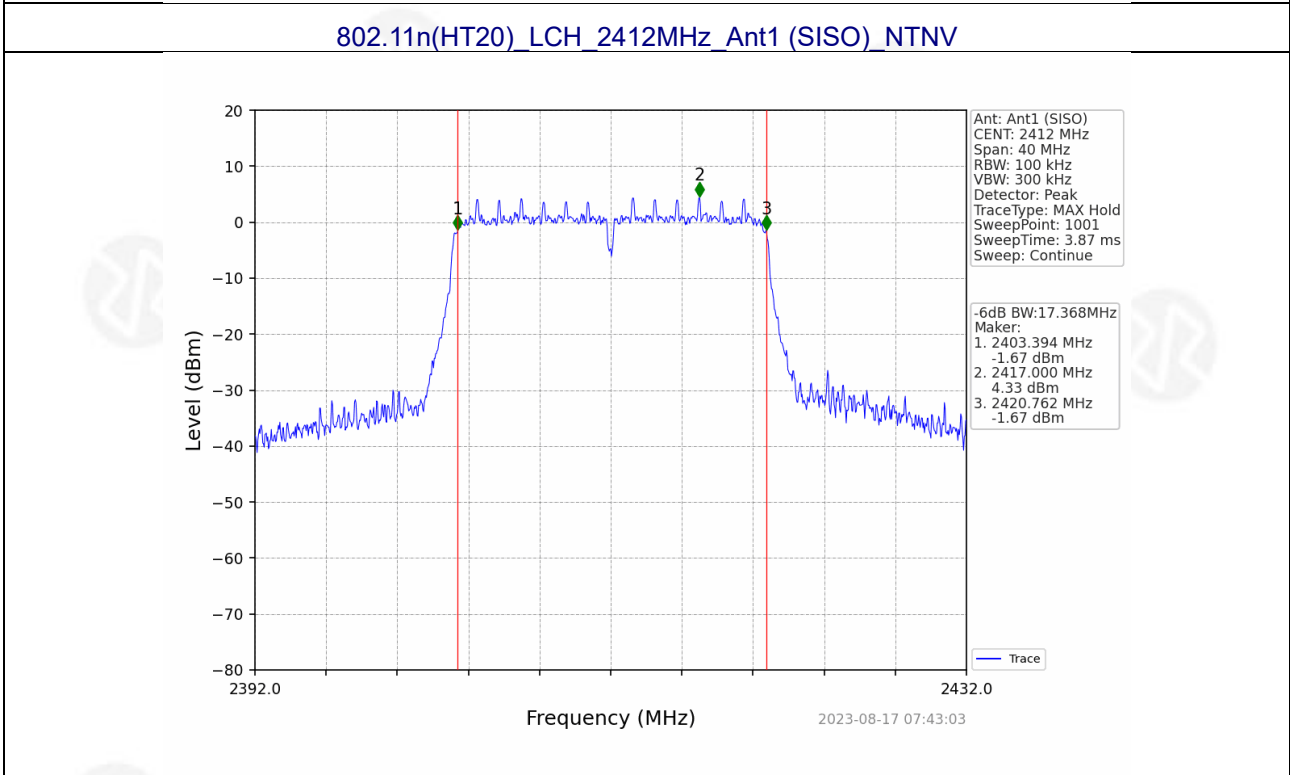
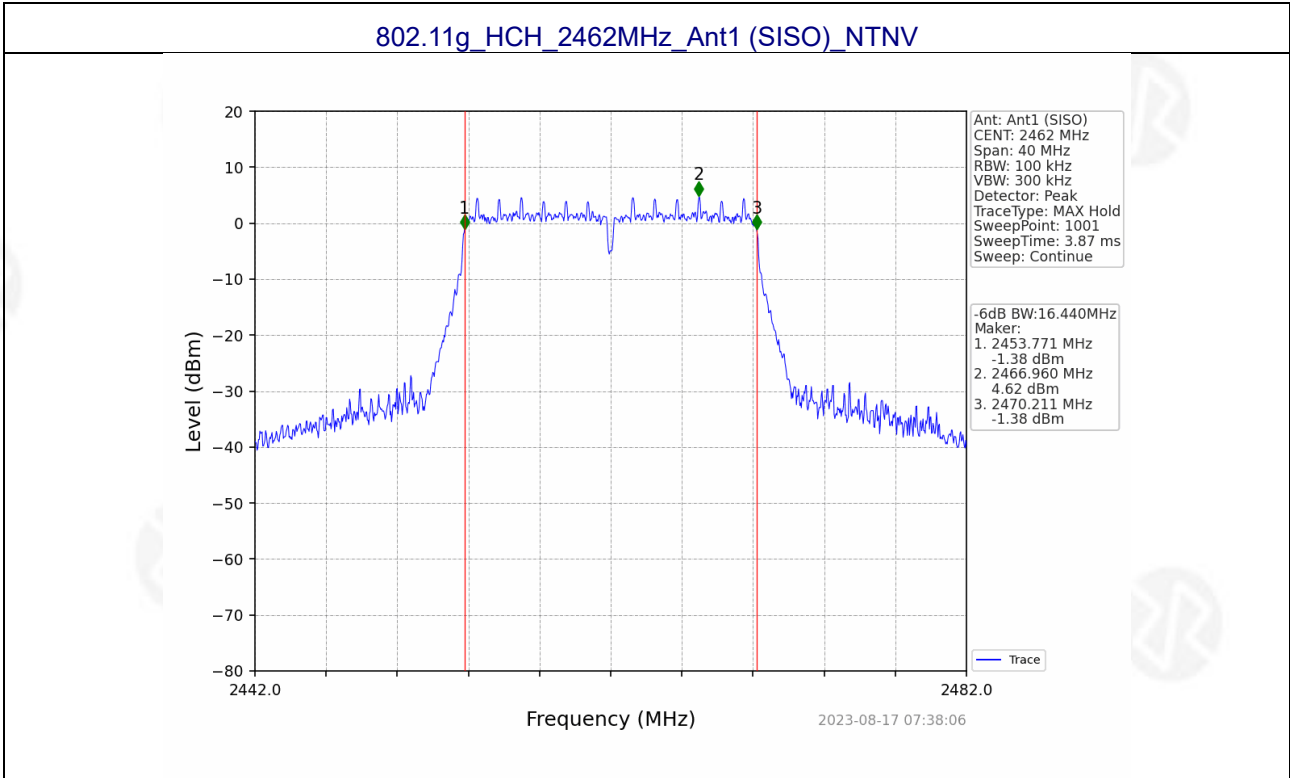



802.11n(HT20)_MCH_2437MHz_Ant1 (SISO)_NTNV

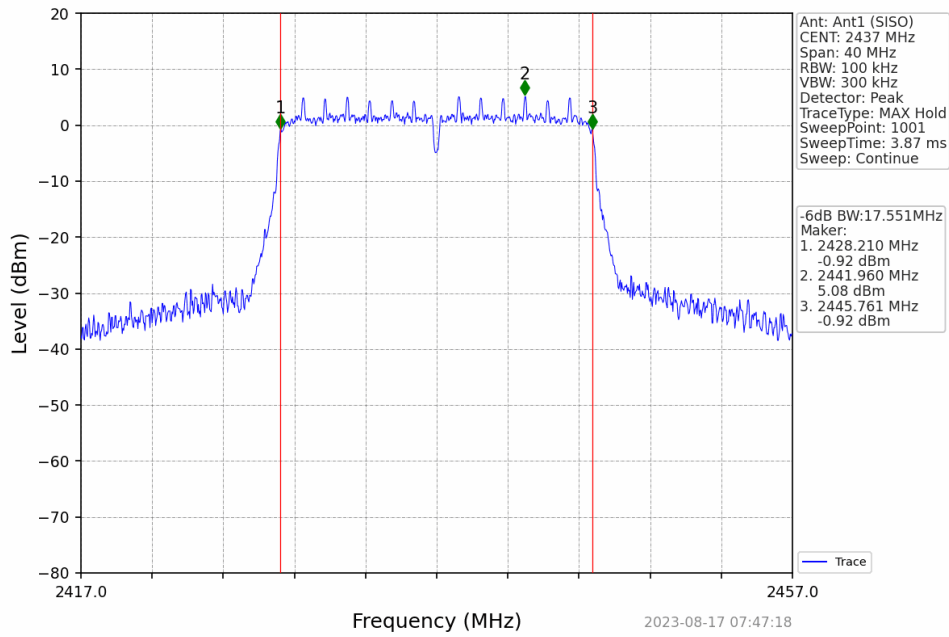

802.11n(HT20)_HCH_2462MHz_Ant1 (SISO)_NTNV

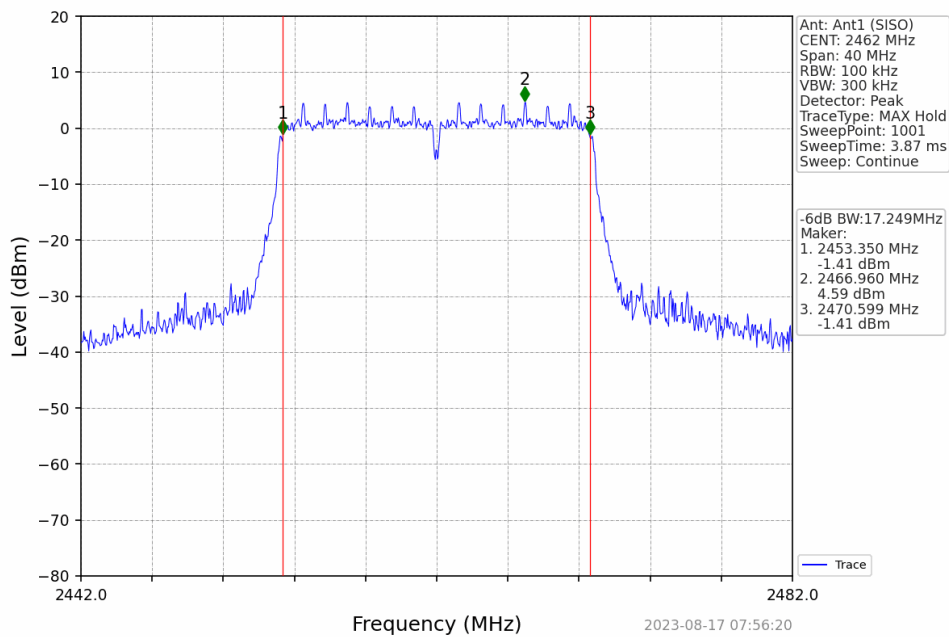



8. PEAK OUTPUT POWER TEST

Test Requirement:	FCC Part15 C Section 15.247 (b)(3)
Test Method:	ANSI C63.10:2013 and KDB558074 D01DTS Meas Guidancev05r02

8.1 APPLIED PROCEDURES/LIMIT

FCC Part15 (15.247) , Subpart C				
Section	Test Item	Limit	Frequency Range (MHz)	Result
15.247(b)(3)	Peak Output Power	1 watt or 30dBm	2400-2483.5	PASS

8.2 TEST PROCEDURE

- a. The EUT was directly connected to the Power meter

8.3 DEVIATION FROM STANDARD

No deviation.

8.4 TEST SETUP



8.5 EUT OPERATION CONDITIONS

The EUT tested system was configured as the statements of 2.4 Unless otherwise a special operating condition is specified in the follows during the testing.



8.6 TEST RESULT

Temperature:	26℃	Relative Humidity:	54%
Pressure:	101kPa	Test Voltage :	AC 120, 60Hz

Mode	TX Type	Frequency (MHz)	Maximum Peak Conducted Output Power (dBm)		Verdict
			ANT1	Limit	
802.11b	SISO	2412	20.38	<=30	Pass
		2437	20.84	<=30	Pass
		2462	20.69	<=30	Pass
802.11g	SISO	2412	23.82	<=30	Pass
		2437	24.28	<=30	Pass
		2462	23.96	<=30	Pass
802.11n (HT20)	SISO	2412	23.53	<=30	Pass
		2437	24.31	<=30	Pass
		2462	23.80	<=30	Pass



9. CONDUCTED BAND EDGE AND SPURIOUS EMISSION

Test Requirement:	FCC Part15 C Section 15.247 (d)
Test Method:	ANSI C63.10:2013 and KDB558074 D01DTS Meas Guidancev05r02

9.1 APPLICABLE STANDARD

in any 100 kHz bandwidth outside the frequency bands in which the spread spectrum intentional radiator is operating, the radio frequency power that is produced by the intentional radiator shall be at least 20dB below that in the 100kHz bandwidth within the band that contains the highest level of the desired power, In addition, radiated emissions which fall in the restricted bands, as defined in§15.205(a), must also comply with the radiated emission limits specified in15.209(a).

9.2 TEST PROCEDURE

Using the following spectrum analyzer setting:

- A) Set the RBW = 100KHz.
- B) Set the VBW = 300KHz.
- C) Sweep time = auto couple.
- D) Detector function = peak.
- E) Trace mode = max hold.
- F) Allow trace to fully stabilize.

9.3 DEVIATION FROM STANDARD

No deviation.

9.4 TEST SETUP

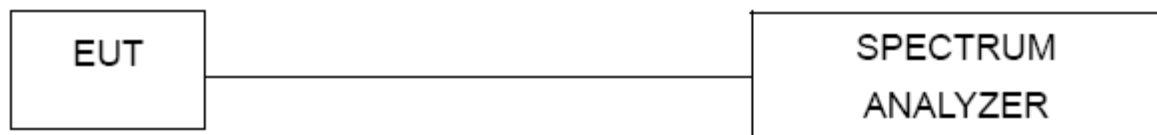

9.5 EUT OPERATION CONDITIONS

The EUT tested system was configured as the statements of 2.4 Unless otherwise a special operating condition is specified in the follows during the testing.

9.6 TEST RESULTS



Temperature:	26°C	Relative Humidity:	54%
Pressure:	101kPa	Test Voltage :	AC 120, 60Hz

Mode	TX Type	Frequency (MHz)	ANT	Level of Reference (dBm)
802.11b	SISO	2412	1	8.97
		2437	1	9.43
		2462	1	9.39
802.11g	SISO	2412	1	4.13
		2437	1	5.02
		2462	1	4.56
802.11n (HT20)	SISO	2412	1	4.39
		2437	1	5.10
		2462	1	4.57

Note1: Refer to FCC Part 15.247 (d) and ANSI C63.10-2013, the channel contains the maximum PSD level was used to establish the reference level.



Test Graph

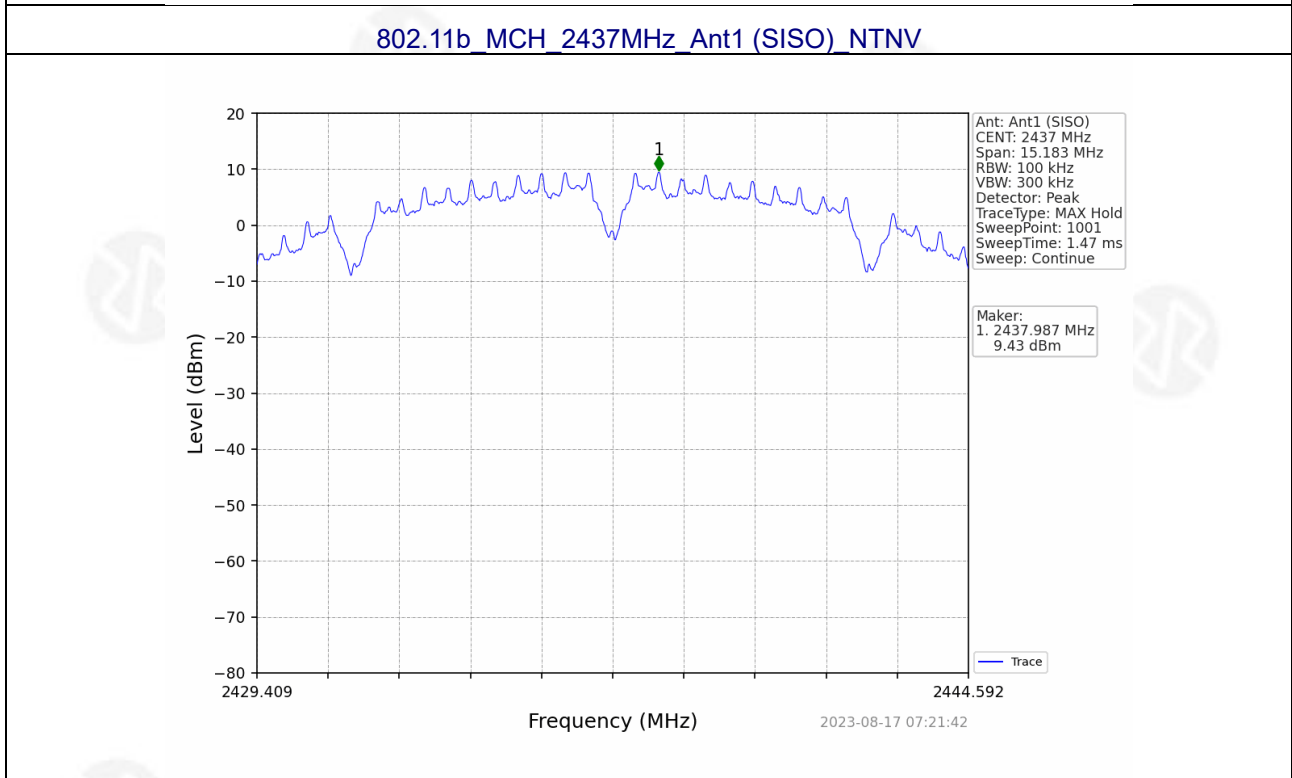
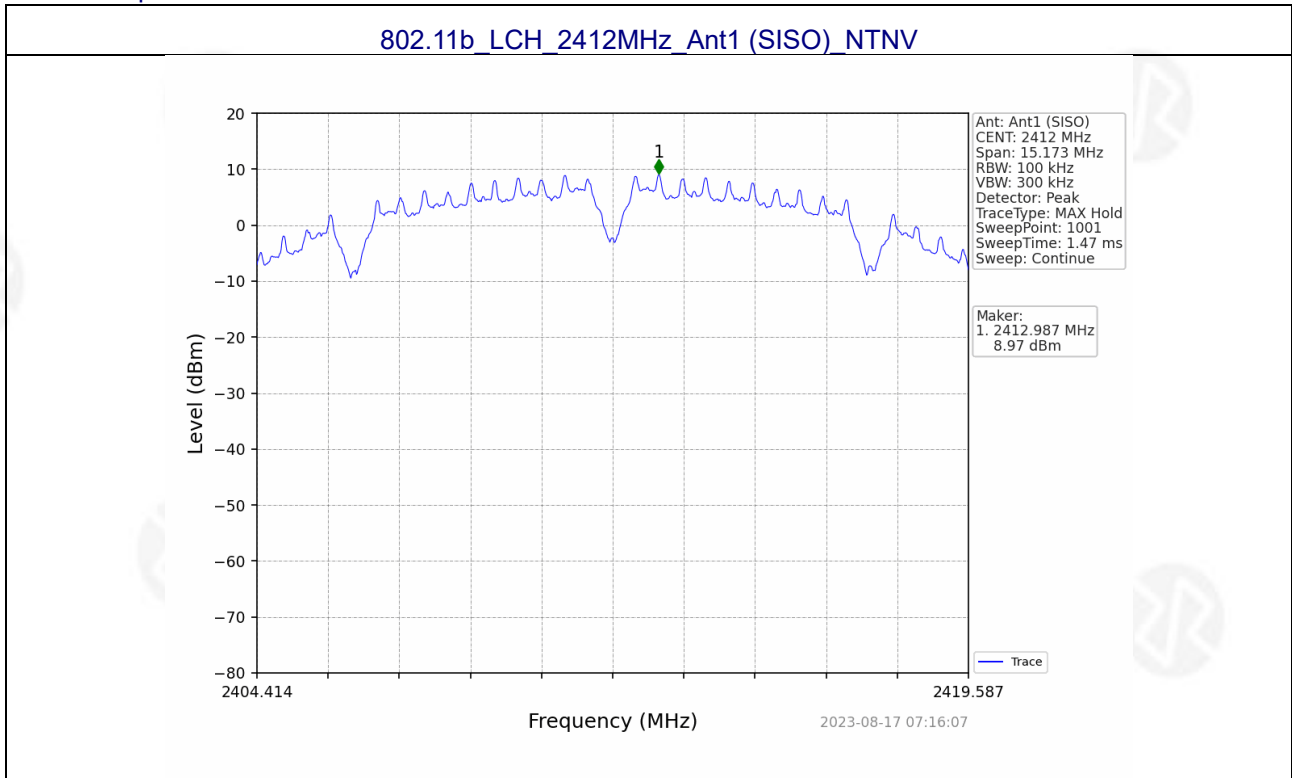



802.11b HCH 2462MHz Ant1 (SISO) NTV

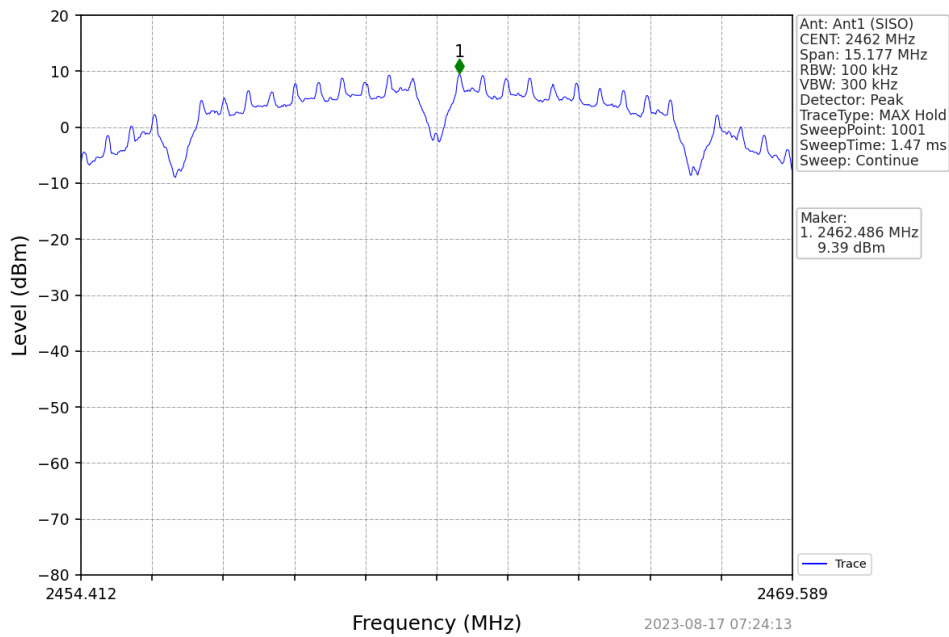

802.11g LCH 2412MHz Ant1 (SISO) NTV

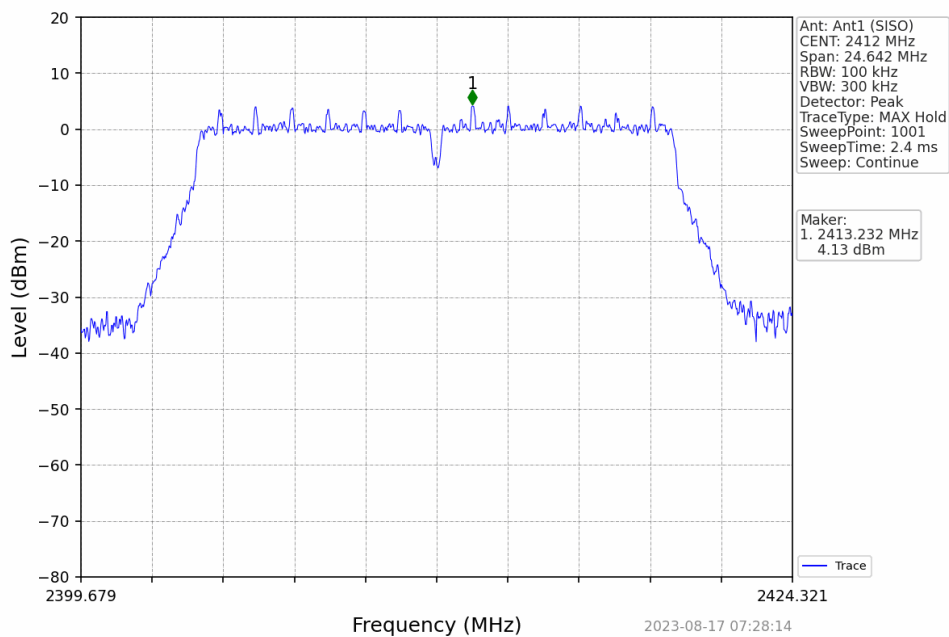



802.11g MCH 2437MHz Ant1 (SISO) NTN

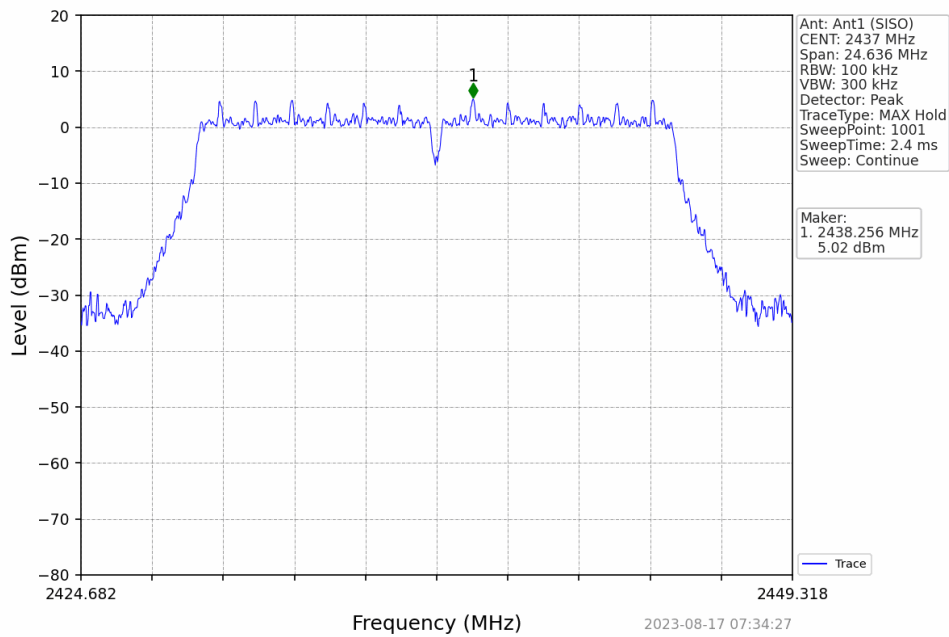

802.11g HCH 2462MHz Ant1 (SISO) NTN

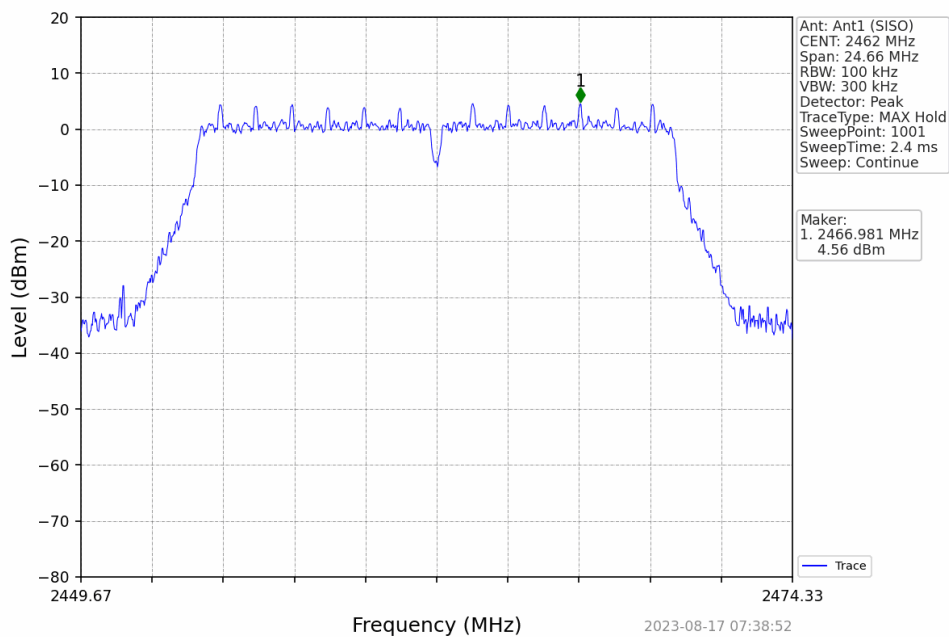



802.11n(HT20) LCH 2412MHz Ant1 (SISO) NTN

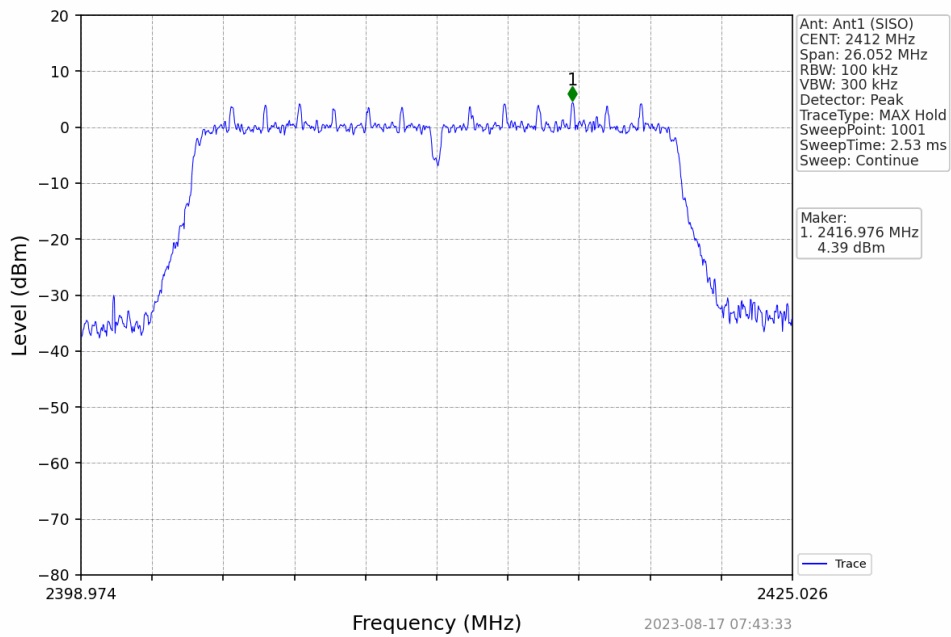

802.11n(HT20) MCH 2437MHz Ant1 (SISO) NTN

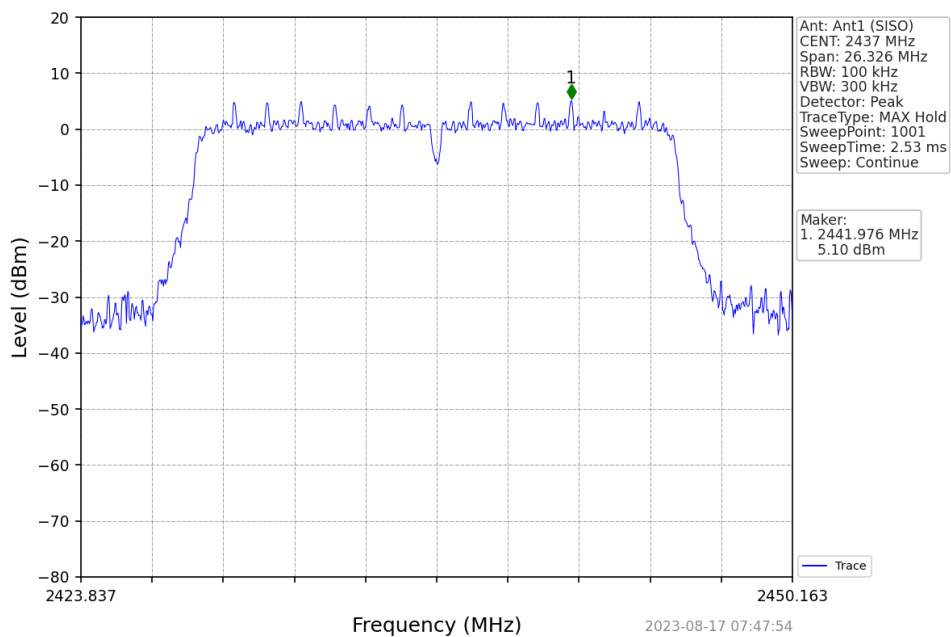

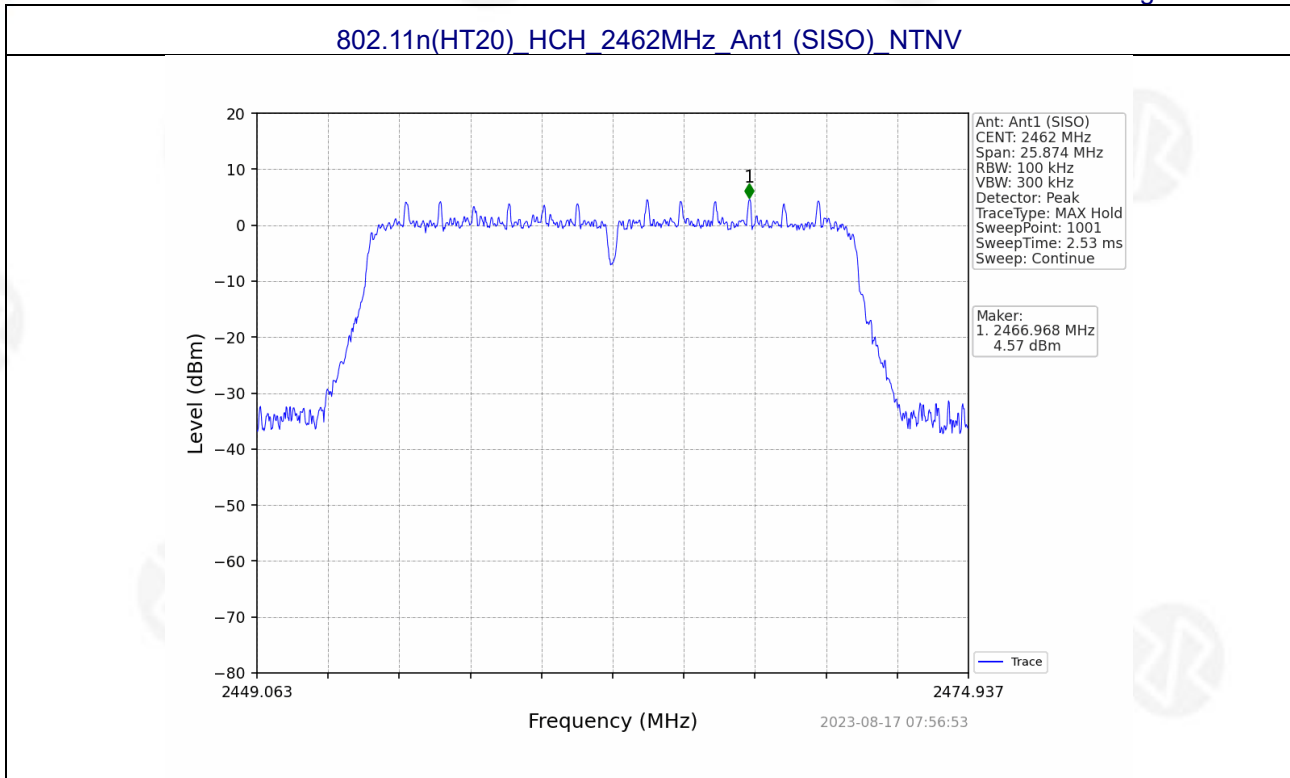

Conducted Spurious Emission

Mode	TX Type	Frequency (MHz)	ANT	Level of Reference (dBm)	Limit (dBm)	Verdict
802.11b	SISO	2412	1	5.15	-14.85	Pass
		2437	1	5.15	-14.85	Pass
		2462	1	5.15	-14.85	Pass
802.11g	SISO	2412	1	2.31	-17.69	Pass
		2437	1	2.31	-17.69	Pass
		2462	1	2.31	-17.69	Pass
802.11n (HT20)	SISO	2412	1	2.23	-17.77	Pass
		2437	1	2.23	-17.77	Pass
		2462	1	2.23	-17.77	Pass

Note1: Refer to FCC Part 15.247 (d) and ANSI C63.10-2013, the channel contains the maximum PSD level was used to establish the reference level.



Test Graph

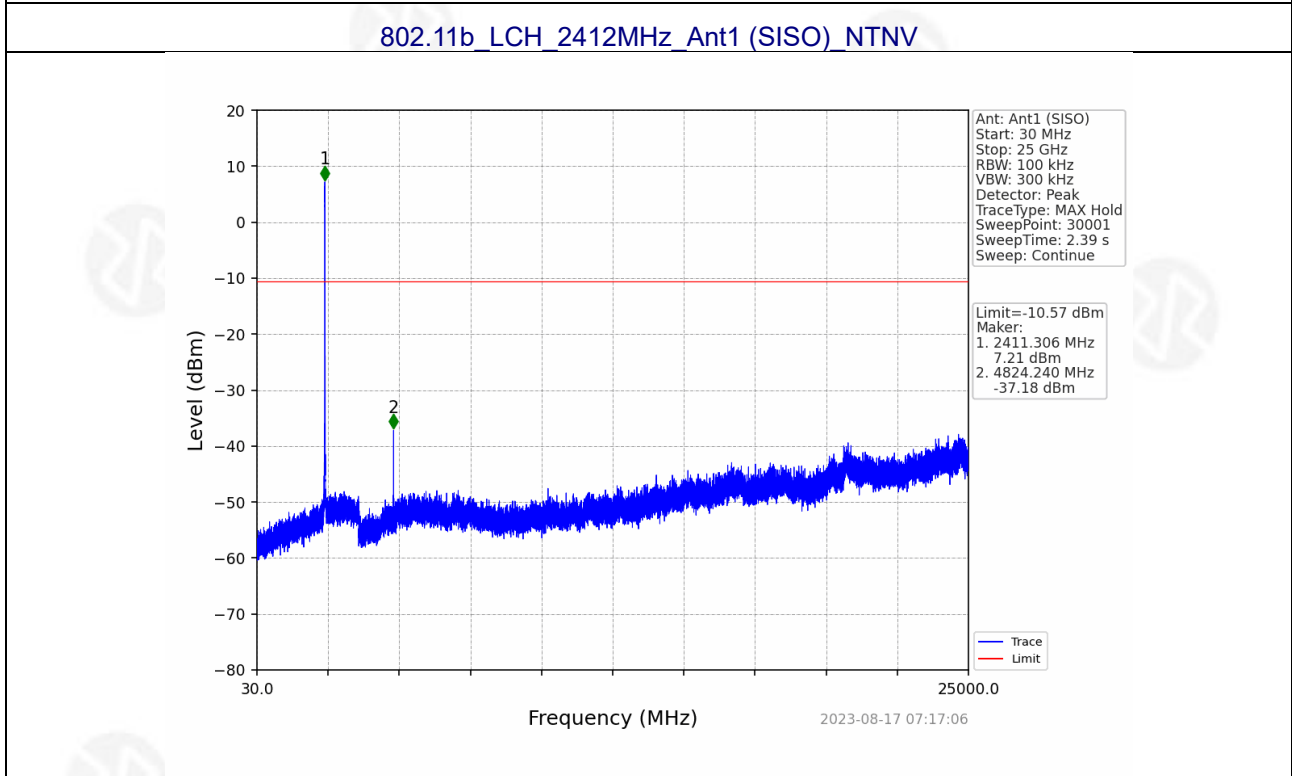
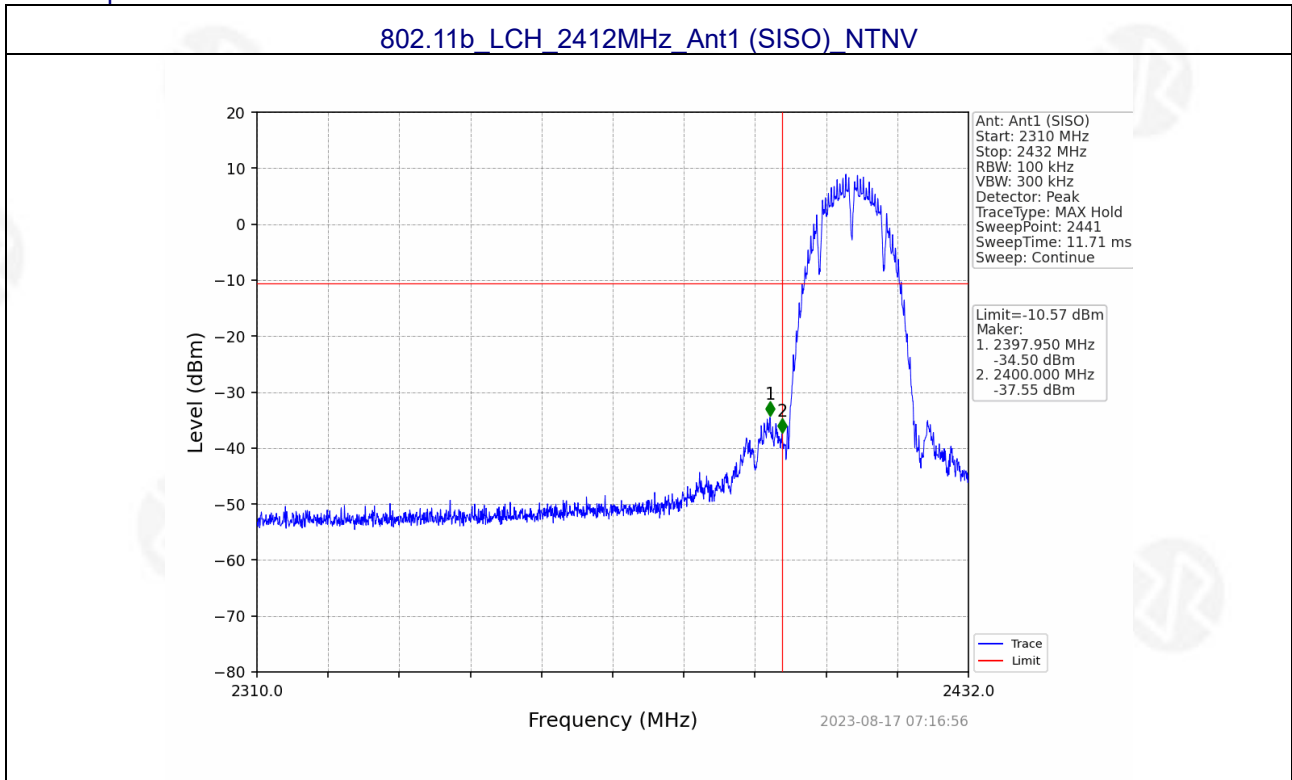



802.11b MCH 2437MHz Ant1 (SISO) NTN

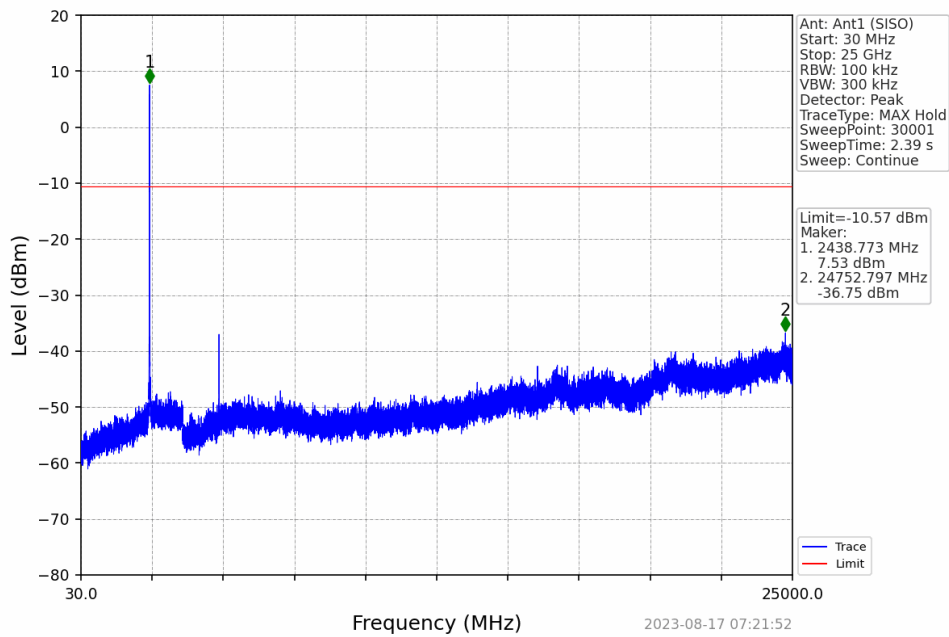

802.11b HCH 2462MHz Ant1 (SISO) NTN

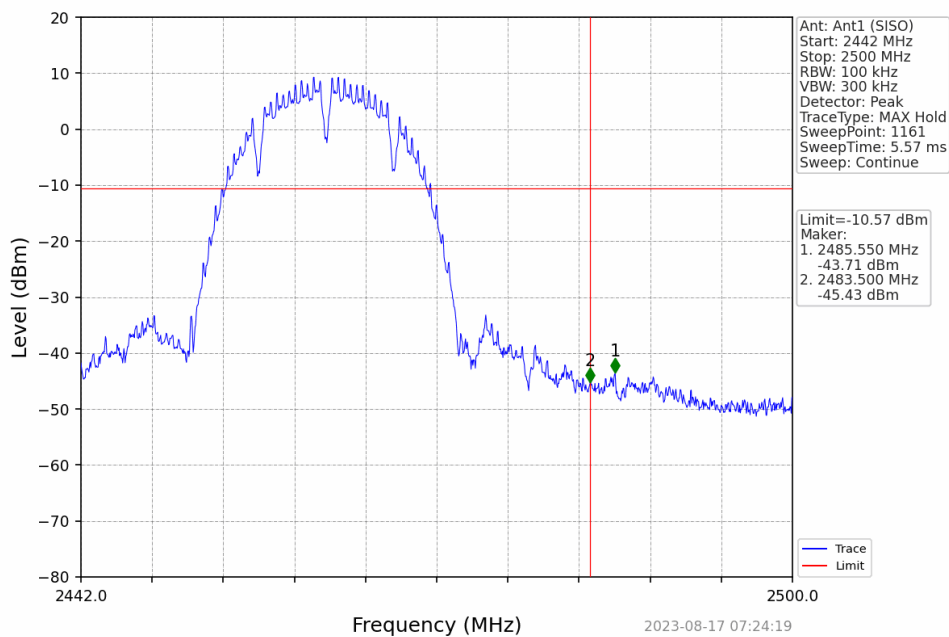



802.11b HCH 2462MHz Ant1 (SISO) NTVN

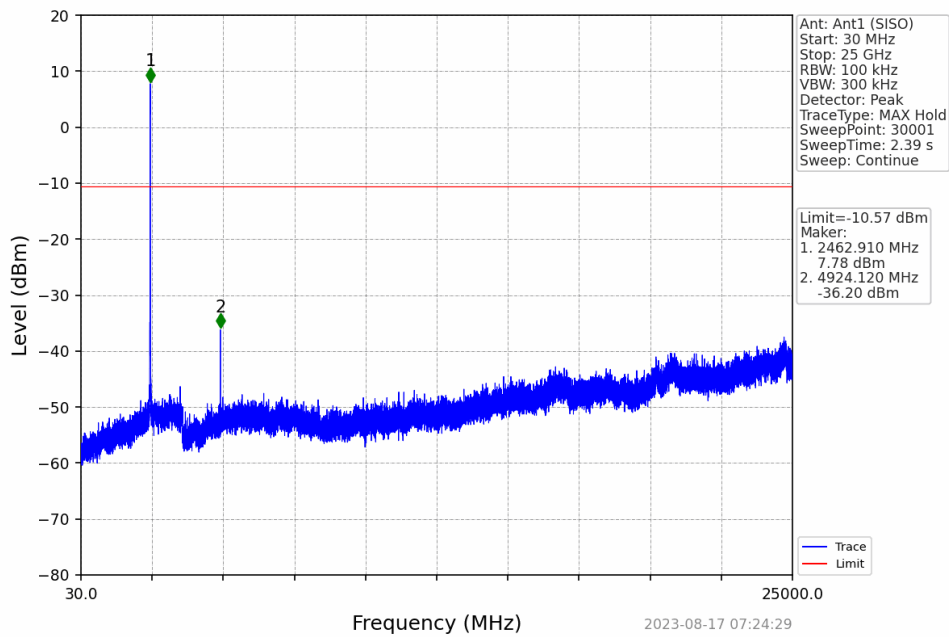

802.11g LCH 2412MHz Ant1 (SISO) NTVN

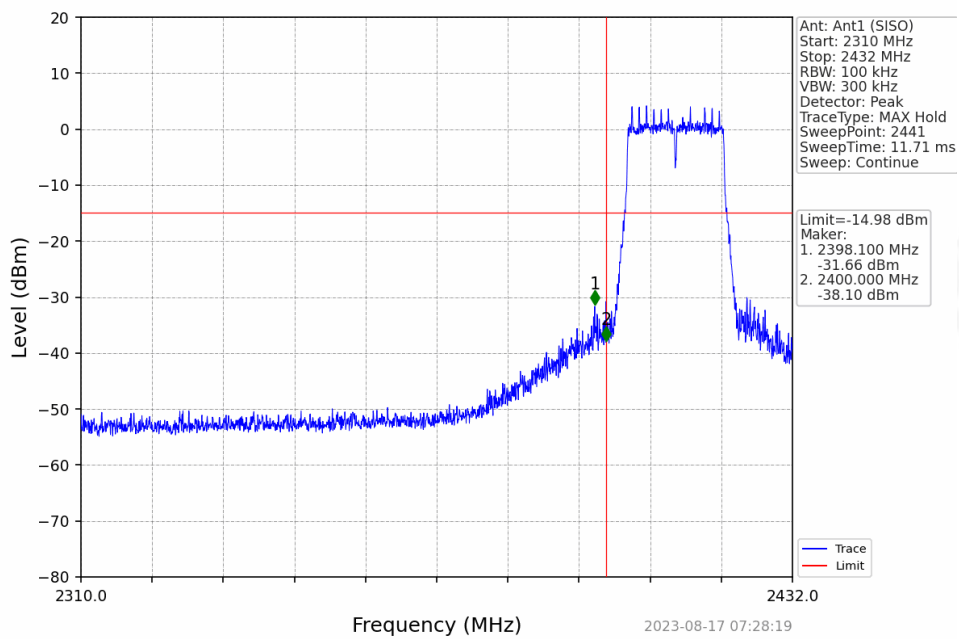



802.11g LCH 2412MHz Ant1 (SISO) NTV

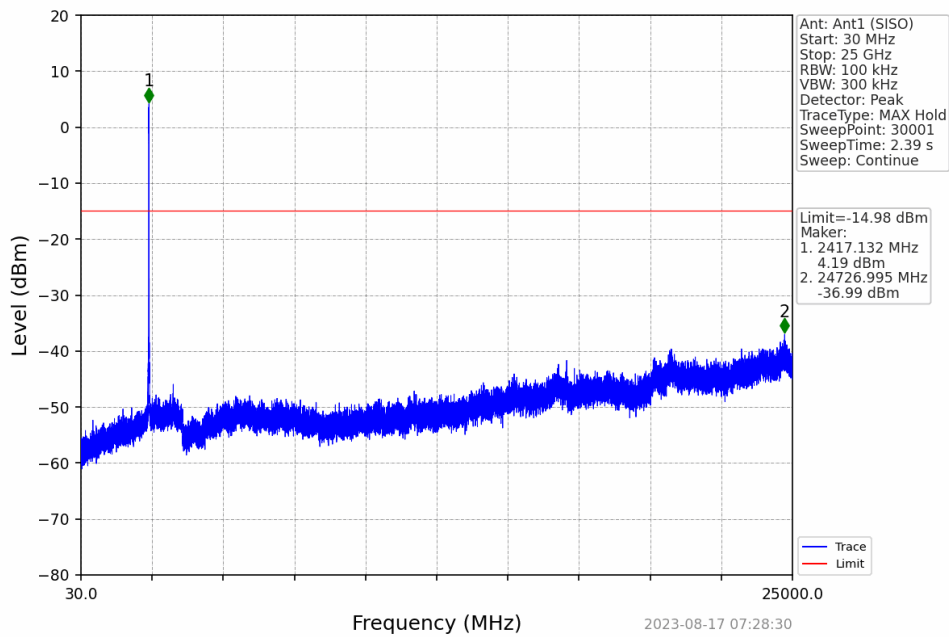

802.11g MCH 2437MHz Ant1 (SISO) NTV

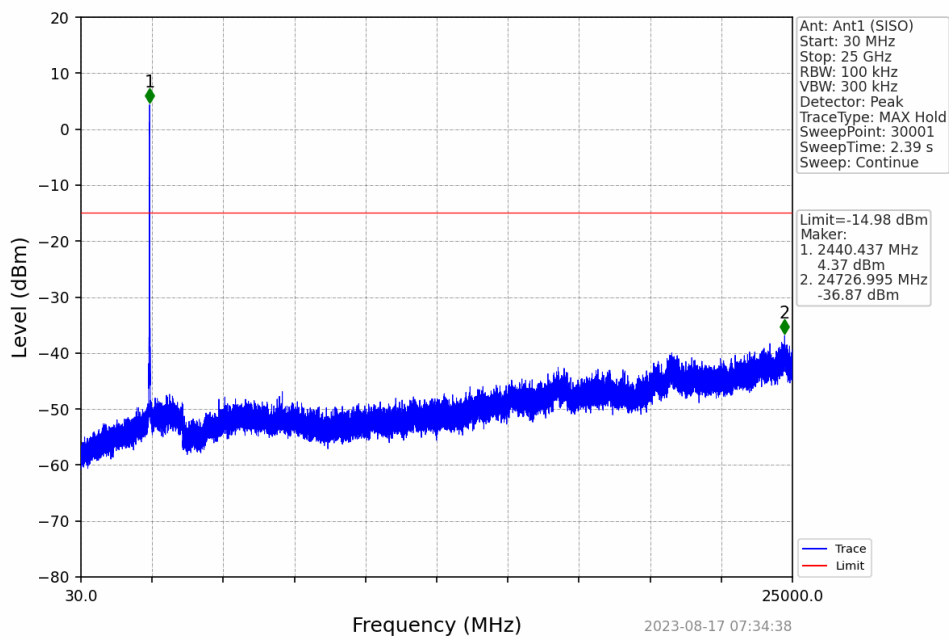



802.11g_HCH_2462MHz_Ant1 (SISO)_NTNV

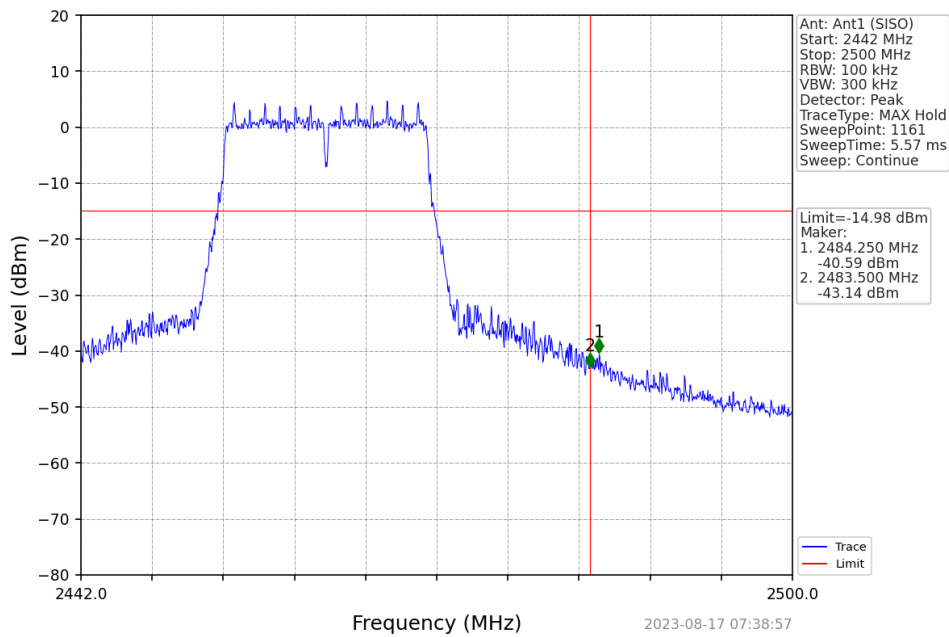

802.11g_HCH_2462MHz_Ant1 (SISO)_NTNV

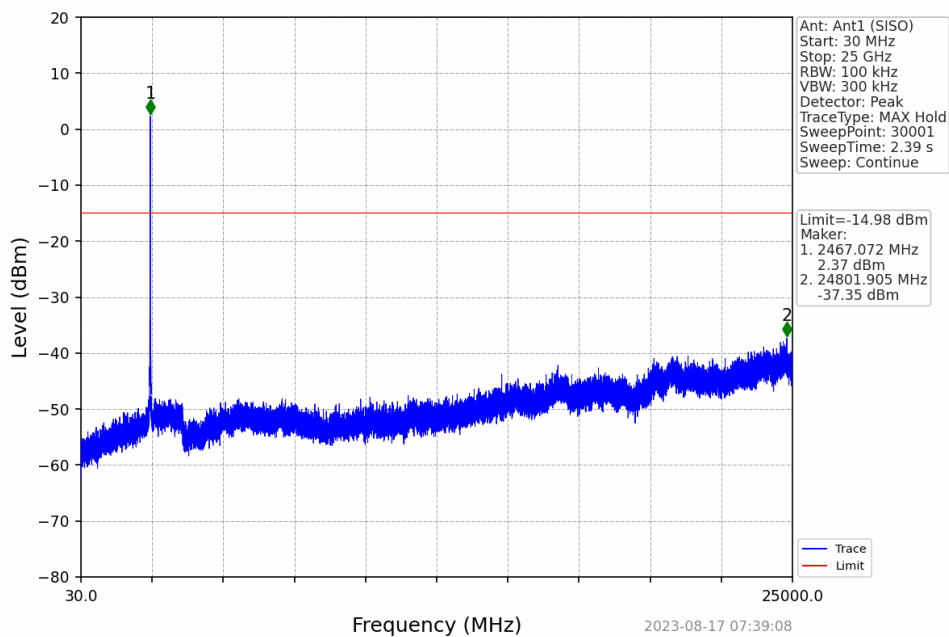



802.11n(HT20)_LCH_2412MHz_Ant1 (SISO) NTN

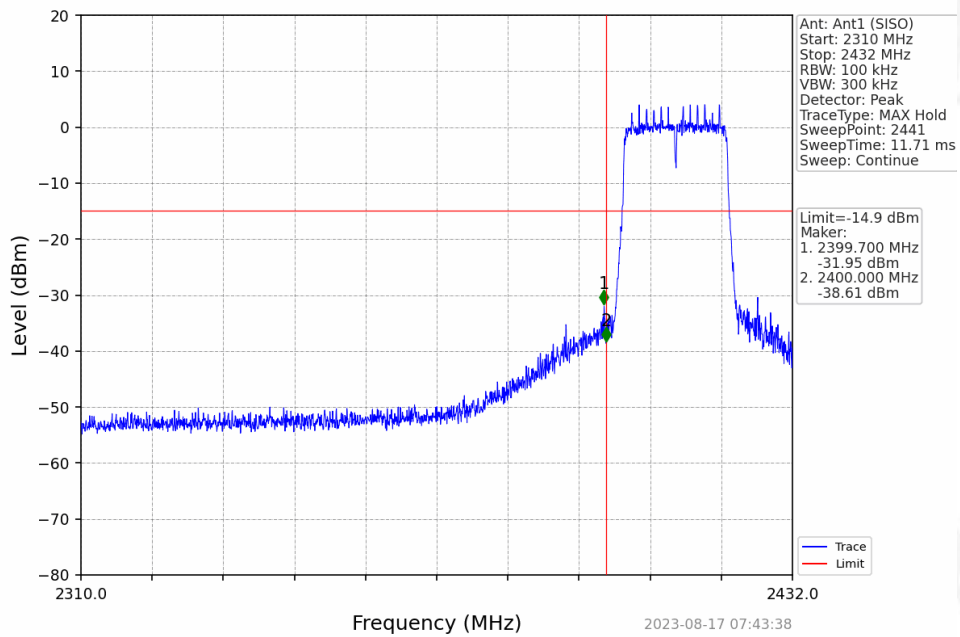

802.11n(HT20)_LCH_2412MHz_Ant1 (SISO) NTN

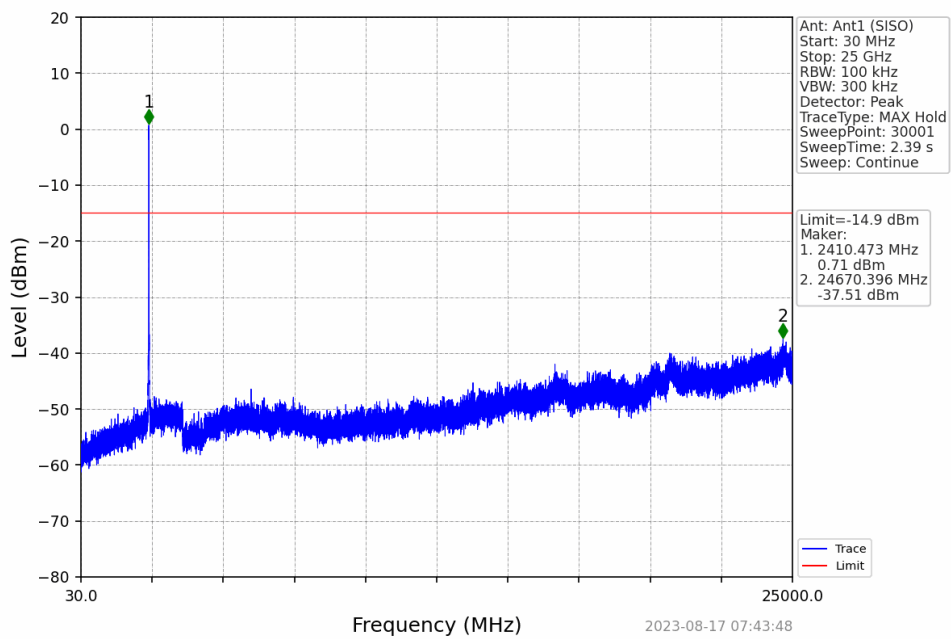



802.11n(HT20) MCH 2437MHz Ant1 (SISO) NTN

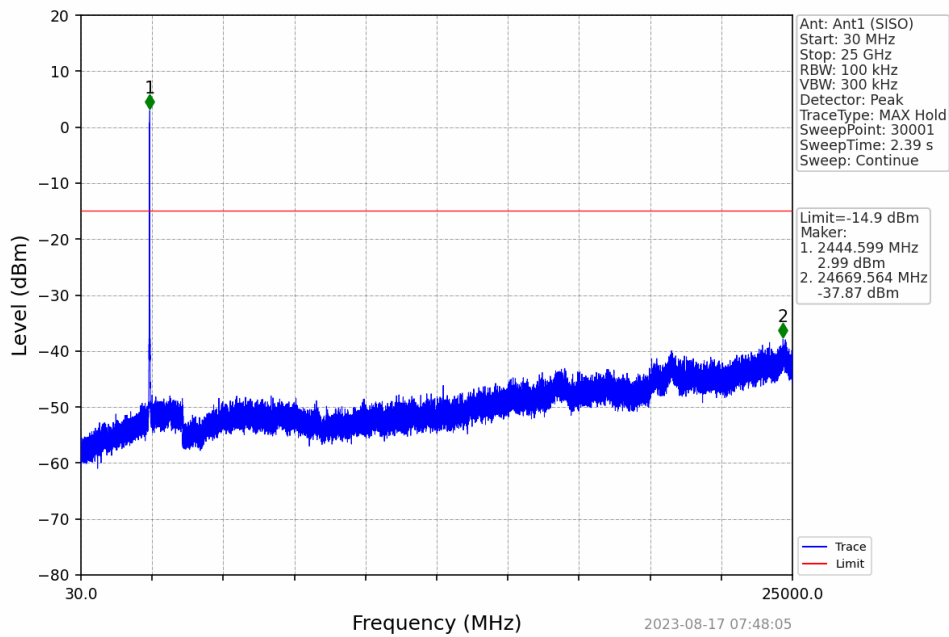

802.11n(HT20) HCH 2462MHz Ant1 (SISO) NTN

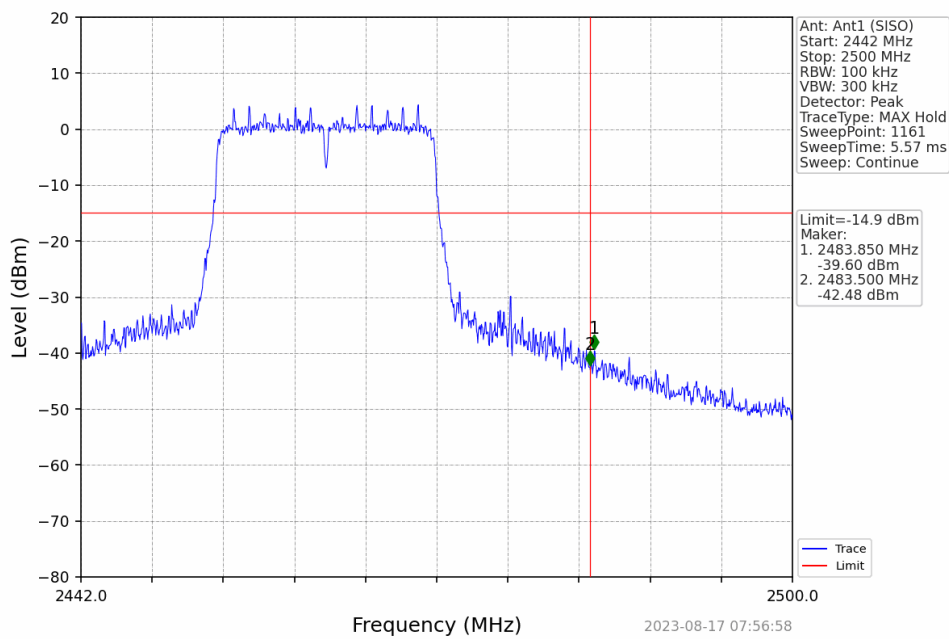

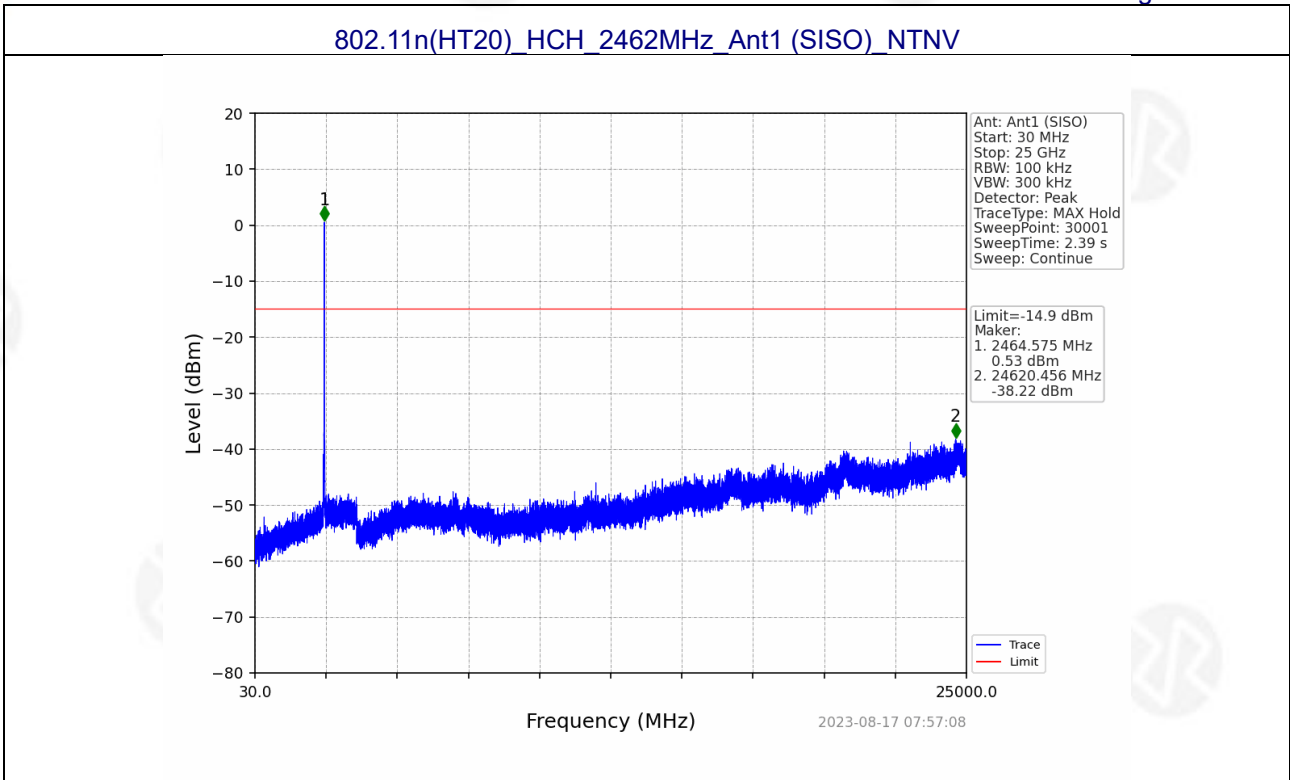



10. ANTENNA REQUIREMENT

Standard requirement:	FCC Part15 C Section 15.203 /247(c)
<p>15.203 requirement: An intentional radiator shall be designed to ensure that no antenna other than that furnished by the responsible party shall be used with the device. The use of a permanently attached antenna or of an antenna that uses a unique coupling to the intentional radiator, the manufacturer may design the unit so that a broken antenna can be replaced by the user, but the use of a standard antenna jack or electrical connector is prohibited.</p> <p>15.247(c) (1)(i) requirement: (i) Systems operating in the 2400-2483.5 MHz band that is used exclusively for fixed. Point-to-point operations may employ transmitting antennas with directional gain greater than 6dBi provided the maximum conducted output power of the intentional radiator is reduced by 1 dB for every 3 dB that the directional gain of the antenna exceeds 6dBi. A transmitter can only be sold or operated with antennas with which it was approved.</p>	
EUT Antenna:	
The antenna is Monopole Antenna, the best case gain of the antenna is 2.34dBi, reference to the appendix II for details	



11. TEST SETUP PHOTO

Reference to the appendix I for details.

12. EUT CONSTRUCTIONAL DETAILS

Reference to the appendix II for details.

***** END OF REPORT *****