



MEASUREMENT REPORT (Class II Change)

FCC PART 15.247 WLAN 802.11b/g/n

FCC ID: 2AKWYXBP301
APPLICANT: Dynascan Technology Corp.
Application Type: Certification
Product: Digital Transmission System
Model No.: XBP301
FCC Classification: (DTS) Digital Transmission System
FCC Rule Part(s): Part 15.247
Test Procedure(s): ANSI C63.10-2013
Received Date: January 3 ,2022
Test Date: January 5~18 ,2022

Tested By : *Peter Syu*
(Peter Syu)
Reviewed By : *Paddy Chen*
(Paddy Chen)
Approved By : *Chenz Ker*
(Chenz Ker)



The test results only relate to the tested samples.

This equipment has been shown to be capable of compliance with the applicable technical standards as indicated in the measurement report and was tested in accordance with the measurement procedures specified in ANSI C63.10. Test results reported herein relate only to the item(s) tested.

The test report shall not be reproduced except in full without the written approval of MRT Technology (Taiwan) Co., Ltd.

Revision History

Report No.	Version	Description	Issue Date	Note
2201TW5402-U1	1.0	Original Report	2022-02-09	

CONTENTS

Description	Page
§2.1033 General Information	5
1. INTRODUCTION	6
1.1. Scope.....	6
1.2. MRT Test Location.....	6
2. PRODUCT INFORMATION	7
2.1. Equipment Description	7
2.2. Working Frequencies for this Report	8
2.3. Test Mode.....	10
2.4. Test Software	10
2.5. Test Configuration.....	11
2.6. EMI Suppression Device(s)/Modifications	11
2.7. Labeling Requirements	11
3. DESCRIPTION of TEST	12
3.1. Evaluation Procedure	12
3.2. AC Line Conducted Emissions	12
3.3. Radiated Emissions	13
4. ANTENNA REQUIREMENTS.....	14
5. TEST EQUIPMENT CALIBRATION DATE.....	15
6. MEASUREMENT UNCERTAINTY.....	16
7. TEST RESULT	17
7.1. Summary.....	17
7.2. 6dB Bandwidth Measurement	18
7.2.1. Test Limit.....	18
7.2.2. Test Procedure used	18
7.2.3. Test Setting	18
7.2.4. Test Setup	18
7.2.5. Test Result	19
7.3. Output Power Measurement.....	20
7.3.1. Test Limit.....	20
7.3.2. Test Procedure Used.....	20
7.3.3. Test Setting	20
7.3.4. Test Setup	20
7.3.5. Test Result of Output Power	21
7.4. Power Spectral Density Measurement	25
7.4.1. Test Limit.....	25
7.4.2. Test Procedure Used.....	25
7.4.3. Test Setting	25
7.4.4. Test Setup	25
7.4.5. Test Result	26
7.5. Out-of-Band Spurious Emissions Emissions Measurement.....	27

7.5.1.	Test Limit	27
7.5.2.	Test Procedure Used	27
7.5.3.	Test Settintg	27
7.5.4.	Test Setup	27
7.5.5.	Test Result	28
7.6.	Radiated Spurious Emission Measurement.....	29
7.6.1.	Test Limit	29
7.6.2.	Test Procedure Used	29
7.6.3.	Test Setting	29
7.6.4.	Test Setup	31
7.6.5.	Test Result	33
7.7.	Radiated Restricted Band Edge Measurement.....	59
7.7.1.	Test Limit	59
7.7.2.	Test Procedure Used	59
7.7.3.	Test Setting	59
7.7.4.	Test Setup	61
7.7.5.	Test Result	62
7.8.	AC Conducted Emissions Measurement	94
7.8.1.	Test Limit	94
7.8.2.	Test Setup	94
7.8.3.	Test Result	95
8.	CONCLUSION	99

§2.1033 General Information

Applicant	Dynascan Technology Corp.
Applicant Address	6F,No.88, Wenmao Rd., Guishan Dist., Taoyuan City 333001,Taiwan
Manufacturer	Dynascan Technology Corp.
Manufacturer Address	6F,No.88, Wenmao Rd., Guishan Dist., Taoyuan City 333001,Taiwan
Test Site	MRT Technology (Taiwan) Co., Ltd
Test Site Address	No. 38, Fuxing Second Rd., Guishan Dist., Taoyuan City 333, Taiwan (R.O.C)
MRT FCC Registration No.	291082
FCC Rule Part(s)	Part 15.247
Test Device Serial No.	#1 <input type="checkbox"/> Production <input checked="" type="checkbox"/> Pre-Production <input type="checkbox"/> Engineering

Test Facility / Accreditations

1. MRT facility is a FCC registered (Reg. No. 291082) test facility with the site description report on file and is designated by the FCC as an Accredited Test Firm.
2. MRT facility is an ISED registered (MRT Reg. No. 21723) test laboratory with the site description on file at Industry Canada.
3. MRT Lab is accredited to ISO 17025 by the Taiwan Accreditation Foundation (TAF Cert. No. 3261) in EMC, Telecommunications and Radio testing for FCC (Designation Number: TW3261), Industry Taiwan, EU and TELEC Rules.

1. INTRODUCTION

1.1. Scope

Measurement and determination of electromagnetic emissions (EMC) of radio frequency devices including intentional and/or unintentional radiators for compliance with the technical rules and regulations of the Federal Communications Commission and the Industry Canada Certification and Engineering Bureau.

1.2. MRT Test Location

The map below shows the location of the MRT LABORATORY, its proximity to the Taoyuan City. These measurement tests were conducted at the MRT Technology (Taiwan) Co., Ltd. Facility located at No.38, Fuxing 2nd Rd., Guishan Dist., Taoyuan City 33377, Taiwan (R.O.C).

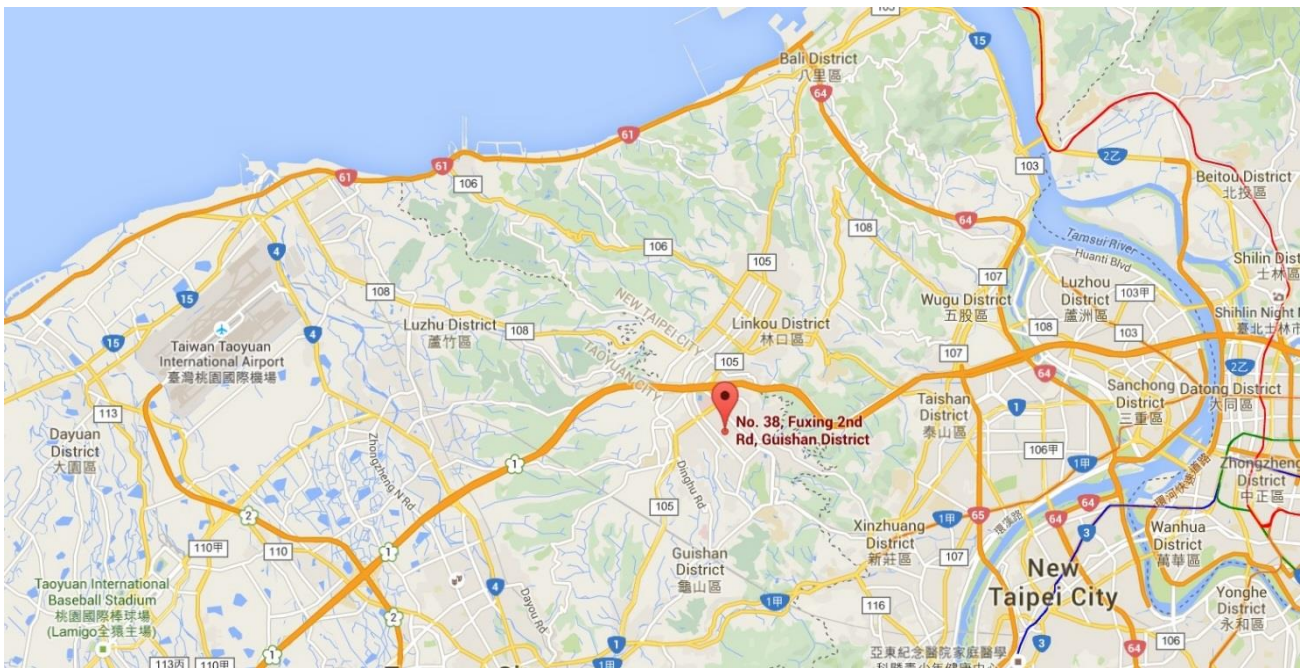

2. PRODUCT INFORMATION

2.1. Equipment Description

Product Name	Digital Transmission System
Model No.	XBP301
Supports Radios Spec.	WLAN: 2.4G: 802.11b/g/n-20/n-40
Wi-Fi Specification	802.11b/g/n (2TX / 2RX)
Frequency Range	<u>2.4GHz:</u> For 802.11b/g/n-HT20: 2412 ~ 2462 MHz For 802.1n-HT40: 2422 ~ 2452 MHz
2.4GHz Maximum Output Power	802.11b: 23.13dBm 802.11g: 20.63dBm 802.11n-20M: 20.69dBm 802.11n-40M: 20.61dBm
Type of Modulation	802.11b: DSSS, DBPSK, DQPSK, CCK 802.11g/n: OFDM, BPSK, QPSK, 16QAM, 64QAM

Note:

1. This case is to add Host (Product Name: Display, Model No.: 64425), so the FCC C2PC (Conducted Output Power, Spurious Emission & Band Edge, AC Conducted Emissions) is executed.
2. FCC Original Report Grant Date: 06/11/2020, FCC ID: 2AKWYXBP301.

2.2. Working Frequencies for this Report

802.11b/g/n-HT20

Channel	Frequency	Channel	Frequency	Channel	Frequency
01	2412 MHz	02	2417 MHz	03	2422 MHz
04	2427 MHz	05	2432 MHz	06	2437 MHz
07	2442 MHz	08	2447 MHz	09	2452 MHz
10	2457 MHz	11	2462 MHz	--	--

802.11n-HT40

Channel	Frequency	Channel	Frequency	Channel	Frequency
03	2422 MHz	04	2427 MHz	05	2432 MHz
06	2437 MHz	07	2442 MHz	08	2447 MHz
09	2452 MHz	--	--	--	--

Duty Cycle

Test Mode	Duty Cycle
802.11b	99%
802.11g	94%
802.11 n-HT20	94%
802.11 n-HT40	87%



2.3. Test Mode

Test Mode	Mode 1: Transmit by 802.11b
	Mode 2: Transmit by 802.11g
	Mode 3: Transmit by 802.11n-20M
	Mode 4: Transmit by 802.11n-40M

Note :

1. Regarding to the operation frequency, the lowest, middle and highest frequency are selected to perform the test.
2. For radiated emission test on 30M~1G, the test results shown in the 802.11n-20 represent the worst-case emissions.

2.4. Test Software

The test utility software used during testing was “REALTEK WLAN Test”.

2.5. Test Configuration

This device was tested per the guidance of ANSI C63.10-2013. ANSI C63.10-2013 was used to reference the appropriate EUT setup for radiated spurious emissions testing and AC line conducted testing.

2.6. EMI Suppression Device(s)/Modifications

No EMI suppression device(s) were added and/or no modifications were made during testing.

2.7. Labeling Requirements

Per 2.1074 & 15.19; Docket 95-19

The label shall be permanently affixed at a conspicuous location on the device; instruction manual or pamphlet supplied to the user and be readily visible to the purchaser at the time of purchase. However, when the device is so small wherein placement of the label with specified statement is not practical, only the FCC ID must be displayed on the device per Section 15.19(a)(5). Please see attachment for FCC ID label and label location.

3. DESCRIPTION of TEST

3.1. Evaluation Procedure

The measurement procedures described in the American National Standard for Testing Unlicensed Wireless Devices (ANSI C63.10-2013), and the guidance provided in KDB 558074 D01v05 were used in the measurement of the device.

Deviation from measurement procedure.....None

3.2. AC Line Conducted Emissions

The line-conducted facility is located inside an 9'x4'x3' shielded enclosure. A 1m x 2m wooden table 80cm high is placed 40cm away from the vertical wall and 80cm away from the sidewall of the shielded room. Two 10kHz-30MHz, 50Ω/50uH Line-Impedance Stabilization Networks (LISNs) are bonded to the shielded room floor. Power to the LISNs is filtered by external high-current high-insertion loss power line filters. These filters attenuate ambient signal noise from entering the measurement lines. These filters are also bonded to the shielded enclosure.

The EUT is powered from one LISN and the support equipment is powered from the second LISN. All interconnecting cables more than 1 meter were shortened to a 1 meter length by non-inductive bundling (serpentine fashion) and draped over the back edge of the test table. All cables were at least 40cm above the horizontal reference ground-plane. Power cables for support equipment were routed down to the second LISN while ensuring that that cables were not draped over the second LISN.

Sufficient time for the EUT, support equipment, and test equipment was allowed in order for them to warm up to their normal operating condition. The RF output of the LISN was connected to the receiver and exploratory measurements were made to determine the frequencies producing the maximum emission from the EUT. The receiver was scanned from 150kHz to 30MHz. The detector function was set to peak mode for exploratory measurements while the bandwidth of the analyzer was set to 9kHz. The EUT, support equipment, and interconnecting cables were arranged and manipulated to maximize each emission. Each emission was also maximized by varying: power lines, the mode of operation or data exchange speed, or support equipment which determined the worst-case emission. Once the worst case emissions have been identified, the one EUT cable configuration/arrangement and mode of operation that produced these emissions are used for final measurements on the same test site. The analyzer is set to CISPR quasi-peak and average detectors with a 9kHz resolution bandwidth for final measurements.

An extension cord was used to connect to a single LISN which powered by EUT. The extension cord was calibrated with LISN, the impedance and insertion loss are compliance with the requirements as stated in ANSI C63.10-2013.

Line conducted emissions test results are shown in Section 7.8.

3.3. Radiated Emissions

The radiated test facilities consisted of an indoor 3 meter semi-anechoic chamber used for final measurements and exploratory measurements, when necessary. The measurement area is contained within the semi-anechoic chamber which is shielded from any ambient interference. For measurements above 1GHz absorbers are arranged on the floor between the turn table and the antenna mast in such a way so as to maximize the reduction of reflections. For measurements below 1GHz, the absorbers are removed. A MF Model 210SS turntable is used for radiated measurement. It is a continuously rotatable, remote controlled, metallic turntable and 2 meters (6.56 ft.) in diameter. The turn table is flush with the raised floor of the chamber in order to maintain its function as a ground plane. An 80cm high PVC support structure is placed on top of the turntable. For all measurements, the spectrum was scanned through all EUT azimuths and from 1 to 4 meter receive antenna height using a broadband antenna from 30MHz up to the upper frequency shown in 15.33(b)(1) depending on the highest frequency generated or used in the device or on which the device operates or tunes. For frequencies above 1GHz, linearly polarized double ridge horn antennas were used. For frequencies below 30MHz, a calibrated loop antenna was used. When exploratory measurements were necessary, they were performed at 1 meter test distance inside the semi-anechoic chamber using broadband antennas, broadband amplifiers, and spectrum analyzers to determine the frequencies and modes producing the maximum emissions. Sufficient time for the EUT, support equipment, and test equipment was allowed in order for them to warm up to their normal operating condition. The test set-up for frequencies below 1GHz was placed on top of the 0.8 meter high, 1 x 1.5 meter table; and test set-up for frequencies 1-40GHz was placed on top of the 1.5 meter high, 1 x 1.5 meter table. The EUT, support equipment, and interconnecting cables were arranged and manipulated to maximize each emission. Appropriate precaution was taken to ensure that all emissions from the EUT were maximized and investigated. The system configuration, clock speed, mode of operation or video resolution, if applicable, turntable azimuth, and receive antenna height was noted for each frequency found.

Final measurements were made in the semi-anechoic chamber using calibrated, linearly polarized broadband and horn antennas. The test setup was configured to the setup that produced the worst case emissions. The spectrum analyzer was set to investigate all frequencies required for testing to compare the highest radiated disturbances with respect to the specified limits. The turntable containing the EUT was rotated through 360 degrees and the height of the receive antenna was varied 1 to 4 meters and stopped at the azimuth and height producing the maximum emission. Each emission was maximized by changing the orientation of the EUT through three orthogonal planes and changing the polarity of the receive antenna, which produced the worst-case emissions. According to 3dB Beam-Width of horn antenna, the horn antenna should be always directed to the EUT when rising height.

Radiated emissions test results are shown in Section 7.6 & 7.7 .

4. ANTENNA REQUIREMENTS

Excerpt from §15.203 of the FCC Rules/Regulations:

“An intentional radiator antenna shall be designed to ensure that no antenna other than that furnished by the responsible party can be used with the device. The use of a permanently attached antenna or of an antenna that uses a unique coupling to the intentional radiator shall be considered sufficient to comply with the provisions of this section.”

- The antenna of the **Display**, is permanently attached.
- There are no provisions for connection to an external antenna.

Conclusion:

The EUT unit complies with the requirement of §15.203.

Antenna List

No.	Manufacturer	Part No.	Antenna Type	Peak Gain
1	Walsin Technology Corporation	RFMTA34071AIMAB301	PIFA	0.87dBi
2	Walsin Technology Corporation	RFMTA34071AIMAB302	PIFA	-0.29dBi

5. TEST EQUIPMENT CALIBRATION DATE

Conducted Emissions – SR2

Instrument	Manufacturer	Type No.	Asset No.	Cali. Interval	Cali. Due Date
Two-Line V-Network	R&S	ENV216	MRTTWA00019	1 year	2022/3/23
Cable	Rosnol	N1C50-RG400- B1C50-500CM	MRTTWE00013	1 year	2022/6/20
EMI Test Receiver	R&S	ESR3	MRTTWA00009	1 year	2022/3/24

Radiated Emissions – AC2

Instrument	Manufacturer	Type No.	Asset No.	Cali. Interval	Cali. Due Date
Broadband TRILOG Antenna	SCHWARZBECK	VULB 9162	MRTTWA00001	1 year	2022/10/4
EMI Test Receiver	R&S	ESR3	MRTTWA00009	1 year	2022/3/24
Active Loop Antenna	Schwarzbeck	FMZB 1519B	MRTTWA00002	1 year	2022/5/6
Broadband Horn antenna	SCHWARZBECK	BBHA 9120D	MRTTWA00003	1 year	2022/4/21
Breitband Hornantenna	Schwarzbeck	BBHA 9170	MRTTWA00004	1 year	2022/4/28
Broadband Amplifier	Schwarzbeck	BBV 9721	MRTTWA00006	1 year	2022/4/26
Broadband Preamplifier	SCHWARZBECK	BBV 9718	MRTTWA00005	1 year	2022/4/21
Cable	HUBERSUHNER	SF106	MRTTWE00010	1 year	2022/6/16
Cable	Rosnol	K1K50-UP0264- K1K50-4M	MRTTWE00012	1 year	2022/6/20

Conducted Test Equipment –SR5

Instrument	Manufacturer	Type No.	Asset No.	Cali. Interval	Cali. Due Date
EXA Signal Analyzer	KEYSIGHT	N9010A	MRTTWA00012	1 year	2022/10/18
EXA Signal Analyzer	KEYSIGHT	N9010B	MRTTWA00074	1 year	2022/7/19
USB Wideband Power Sensor	KEYSIGHT	U2021XA	MRTTWA00015	1 year	2022/3/24

Test Software

Software	Version	Function
e3	9.160520a	EMI Test Software
EMI	V3	EMI Test Software

6. MEASUREMENT UNCERTAINTY

Where relevant, the following test uncertainty levels have been estimated for tests performed on the EUT as specified in CISPR 16-4-2. This uncertainty represents an expanded uncertainty expressed at approximately the 95% confidence level using a coverage factor of $k = 2$.

Conducted Emission- Power Line
Measuring Uncertainty for a Level of Confidence of 95% ($U=2Uc(y)$): 0.15MHz~30MHz: $\pm 2.53\text{dB}$
Conducted Power
Measuring Uncertainty for a Level of Confidence of 95% ($U=2Uc(y)$): $\pm 0.84\text{dB}$
Radiated Spurious Emission
Measuring Uncertainty for a Level of Confidence of 95% ($U=2Uc(y)$): 9kHz~30MHz: $\pm 3.92\text{dB}$ 30MHz~1GHz: $\pm 4.25\text{dB}$ 1GHz~18GHz: $\pm 4.40\text{dB}$ 18GHz~40GHz: $\pm 4.45\text{dB}$

7. TEST RESULT

7.1. Summary

Product Name: 55" Monitor
FCC Classification: (DTS) Digital Transmission System
Data Rate(s) Tested: 1Mbps ~ 11Mbps (b); 6Mbps ~ 54Mbps (g);
6.5/7.2Mbps ~ 130/144.4Mbps (n-20M);
13.5/15Mbps ~ 270/300Mbps (n-40M)

FCC Part Section(s)	Test Description	Test Limit	Test Condition	Test Result	Reference
15.247(a)(2)	6dB Bandwidth	$\geq 500\text{kHz}$	Conducted	N/A	Section 7.2
15.247(b)(3)	Output Power	$\leq 30.00\text{dBm}$		Pass	Section 7.3
15.247(e)	Power Spectral Density	$\leq 8.00\text{dBm}/3\text{kHz}$		N/A	Section 7.4
15.247(d)	Out-of-Band Emissions	Conducted $\geq 20\text{dBc}$		N/A	Section 7.5
15.205 15.209	Spurious Emission	< FCC 15.209 limits	Radiated	Pass	Section 7.6
15.205 15.209	Band Edge Measurement	$\cong 74\text{dBuV}/\text{m}(\text{Peak})$ $\cong 54\text{dBuV}/\text{m}(\text{Average})$		Pass	Section 7.7
15.207	AC Conducted Emissions 150kHz - 30MHz	< FCC 15.207 limits	Line Conducted	Pass	Section 7.8

Notes:

- Determining compliance is based on the test results met the regulation limits or requirements declared by clients, and the test results don't take into account the value of measurement uncertainty.
- All modes of operation and data rates were investigated. For radiated emission test, every axis (X, Y, Z) was also verified. The test results shown in the following sections represent the worst case emissions.
- The analyzer plots shown in this section were all taken with a correction table loaded into the analyzer. The correction table was used to account for the losses of the cables and attenuators used as part of the system to connect the EUT to the analyzer at all frequencies of interest.
- All antenna port conducted emissions testing was performed on a test bench with the antenna port of the EUT connected to the spectrum analyzer through calibrated cables and attenuators.

7.2. 6dB Bandwidth Measurement

7.2.1. Test Limit

The minimum 6dB bandwidth shall be at least 500 kHz.

7.2.2. Test Procedure used

KDB 558074 D01v05- Section 8.2 Option 2

7.2.3. Test Setting

1. The Spectrum's automatic bandwidth measurement capability was used to perform the 6dB bandwidth measurement. The "X" dB bandwidth parameter was set to $X = 6$. The bandwidth measurement was not influenced by any intermediate power nulls in the fundamental emission.
2. Set RBW = 100 kHz
3. VBW $\geq 3 \times$ RBW
4. Detector = Peak
5. Trace mode = max hold
6. Sweep = auto couple
7. Allow the trace was allowed to stabilize

7.2.4. Test Setup

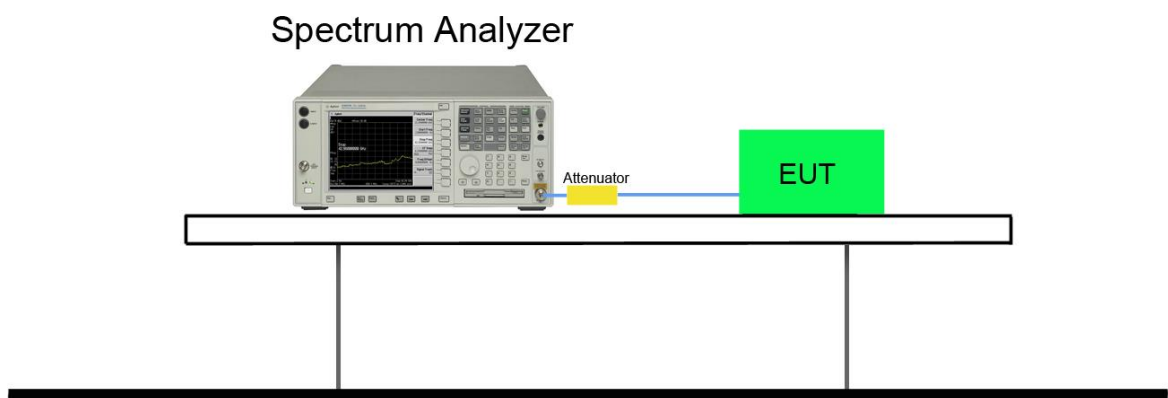

7.2.5. Test Result

Note: Reference Original Report Grant Date: 06/11/2020, FCC ID: 2AKWYXBP301.

7.3. Output Power Measurement

7.3.1. Test Limit

The maximum out power shall be less 1 Watt (30dBm).

7.3.2. Test Procedure Used

KDB 558074 D01v05 - Section 9.1.2 & 9.2.3.2

7.3.3. Test Setting

Peak Power Measurement

The maximum peak conducted output power may be measured using a broadband peak RF power meter. The power meter shall have a video bandwidth that is greater than or equal to the DTS bandwidth and shall utilize a fast-responding diode detector.

Average Power Measurement

Average power measurements were performed only when the EUT was transmitting at its maximum power control level using a broadband power meter with a pulse sensor. The power meter implemented triggering and gating capabilities which were set up such that power measurements were recorded only during the ON time of the transmitter. The trace was averaged over 100 traces to obtain the final measured average power.

7.3.4. Test Setup

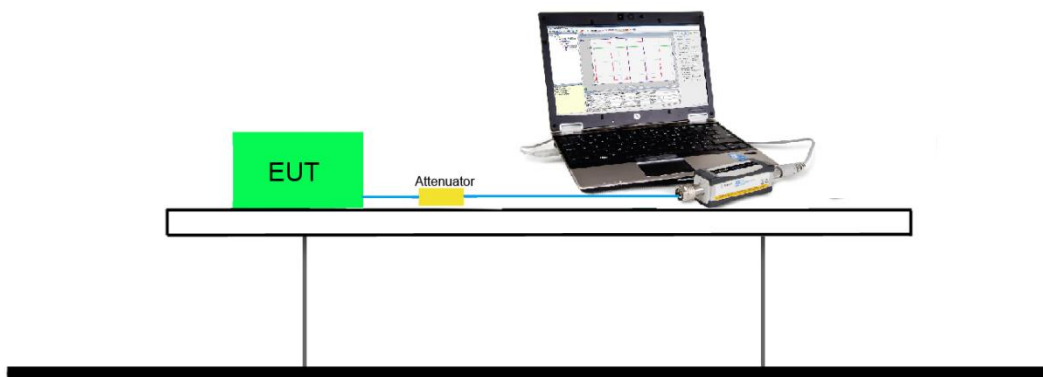

7.3.5. Test Result of Output Power

2.4GHz 802.11b RF Output Power (dBm)_ Antenna 0						
Channel No.	Frequency (MHz)	Average Power For different Data Rate (Mbps)				Required Limit
		1	2	5.5	11	
01	2412	19.59	--	--	--	1Watt= 30 dBm
06	2437	19.49	--	--	--	1Watt= 30 dBm
11	2462	19.27	--	--	--	1Watt= 30 dBm
2.4GHz 802.11b RF Output Power (dBm) Antenna 1						
Channel No.	Frequency (MHz)	Average Power For different Data Rate (Mbps)				Required Limit
		1	2	5.5	11	
01	2412	20.60	--	--	--	1Watt= 30 dBm
06	2437	20.37	--	--	--	1Watt= 30 dBm
11	2462	20.63	--	--	--	1Watt= 30 dBm
2.4GHz 802.11b RF Output Power (dBm)_ Antenna 0+1						
Channel No.	Frequency (MHz)	Average Power For different Data Rate (Mbps)				Required Limit
		1	2	5.5	11	
01	2412	23.13	--	--	--	1Watt= 30 dBm
06	2437	22.96	--	--	--	1Watt= 30 dBm
11	2462	23.01	--	--	--	1Watt= 30 dBm

Note: Output power = Reading value on power meter + duty cycle factor + cable loss ◦

2.4GHz 802.11g RF Output Power (dBm)_ Antenna 0										
Channel No.	Frequency (MHz)	Average Power For different Data Rate (Mbps)								Required Limit
		6	9	12	18	24	36	48	54	
01	2412	16.20	--	--	--	--	--	--	--	1Watt= 30 dBm
06	2437	17.19	--	--	--	--	--	--	--	1Watt= 30 dBm
11	2462	17.08	--	--	--	--	--	--	--	1Watt= 30 dBm
2.4GHz 802.11g RF Output Power (dBm)_ Antenna 1										
Channel No.	Frequency (MHz)	Average Power For different Data Rate (Mbps)								Required Limit
		6	9	12	18	24	36	48	54	
01	2412	16.78	--	--	--	--	--	--	--	1Watt= 30 dBm
06	2437	18.01	--	--	--	--	--	--	--	1Watt= 30 dBm
11	2462	17.98	--	--	--	--	--	--	--	1Watt= 30 dBm
2.4GHz 802.11g RF Output Power (dBm)_ Antenna 0+1										
Channel No.	Frequency (MHz)	Average Power For different Data Rate (Mbps)								Required Limit
		6	9	12	18	24	36	48	54	
01	2412	19.51	--	--	--	--	--	--	--	1Watt= 30 dBm
06	2437	20.63	--	--	--	--	--	--	--	1Watt= 30 dBm
11	2462	20.56	--	--	--	--	--	--	--	1Watt= 30 dBm

Note: Output power = Reading value on power meter + duty cycle factor + cable loss °

2.4GHz 802.11n-20M RF Output Power (dBm)_ Antenna 0										
Channel No.	Frequency (MHz)	Average Power For different Data Rate (Mbps)								Required Limit
		MCS0	MCS1	MCS2	MCS3	MCS4	MCS5	MCS6	MCS7	
01	2412	16.19	--	--	--	--	--	--	--	1Watt= 30 dBm
06	2437	17.33	--	--	--	--	--	--	--	1Watt= 30 dBm
11	2462	16.27	--	--	--	--	--	--	--	1Watt= 30 dBm
2.4GHz 802.11n-20M RF Output Power (dBm)_ Antenna 1										
Channel No.	Frequency (MHz)	Average Power For different Data Rate (Mbps)								Required Limit
		MCS0	MCS1	MCS2	MCS3	MCS4	MCS5	MCS6	MCS7	
01	2412	16.75	--	--	--	--	--	--	--	1Watt= 30 dBm
06	2437	18.01	--	--	--	--	--	--	--	1Watt= 30 dBm
11	2462	17.20	--	--	--	--	--	--	--	1Watt= 30 dBm
2.4GHz 802.11n-20M RF Output Power (dBm)_ Antenna 0+1										
Channel No.	Frequency (MHz)	Average Power For different Data Rate (Mbps)								Required Limit
		MCS0	MCS1	MCS2	MCS3	MCS4	MCS5	MCS6	MCS7	
01	2412	19.49	--	--	--	--	--	--	--	1Watt= 30 dBm
06	2437	20.69	--	--	--	--	--	--	--	1Watt= 30 dBm
11	2462	19.77	--	--	--	--	--	--	--	1Watt= 30 dBm

Note: Output power =Reading value on power meter + duty cycle factor + cable loss ◦

2.4GHz 802.11n-40M RF Output Power (dBm)_ Antenna 0										
Channel No.	Frequency (MHz)	Average Power For different Data Rate (Mbps)								Required Limit
		MCS0	MCS1	MCS2	MCS3	MCS4	MCS5	MCS6	MCS7	
03	2422	15.08	--	--	--	--	--	--	--	1Watt= 30 dBm
06	2437	17.14	--	--	--	--	--	--	--	1Watt= 30 dBm
09	2452	15.53	--	--	--	--	--	--	--	1Watt= 30 dBm
2.4GHz 802.11n-40M RF Output Power (dBm)_ Antenna 1										
Channel No.	Frequency (MHz)	Average Power For different Data Rate (Mbps)								Required Limit
		MCS0	MCS1	MCS2	MCS3	MCS4	MCS5	MCS6	MCS7	
03	2422	14.85	--	--	--	--	--	--	--	1Watt= 30 dBm
06	2437	18.02	--	--	--	--	--	--	--	1Watt= 30 dBm
09	2452	16.20	--	--	--	--	--	--	--	1Watt= 30 dBm
2.4GHz 802.11n-40M RF Output Power (dBm)_ Antenna 0+1										
Channel No.	Frequency (MHz)	Average Power For different Data Rate (Mbps)								Required Limit
		MCS0	MCS1	MCS2	MCS3	MCS4	MCS5	MCS6	MCS7	
03	2422	17.98	--	--	--	--	--	--	--	1Watt= 30 dBm
06	2437	20.61	--	--	--	--	--	--	--	1Watt= 30 dBm
09	2452	18.89	--	--	--	--	--	--	--	1Watt= 30 dBm

Note: Output power =Reading value on power meter + duty cycle factor + cable loss ◦

7.4. Power Spectral Density Measurement

7.4.1. Test Limit

The maximum permissible power spectral density is 8dBm in any 3 kHz band.

7.4.2. Test Procedure Used

KDB 558074 D01v05 - Section 10.2 Method PKPSD

7.4.3. Test Setting

This procedure shall be used if maximum peak conducted output power was used to demonstrate compliance, and is optional if the maximum conducted (average) output power was used to demonstrate compliance.

- a) Set analyzer center frequency to DTS channel center frequency.
- b) Set the span to 1.5 times the DTS bandwidth.
- c) Set the RBW to: 3 kHz.
- d) Set the VBW $\geq 3 \times$ RBW.
- e) Detector = peak.
- f) Sweep time = auto couple.
- g) Trace mode = max hold.
- h) Allow trace to fully stabilize.
- i) Use the peak marker function to determine the maximum amplitude level within the RBW.

7.4.4. Test Setup

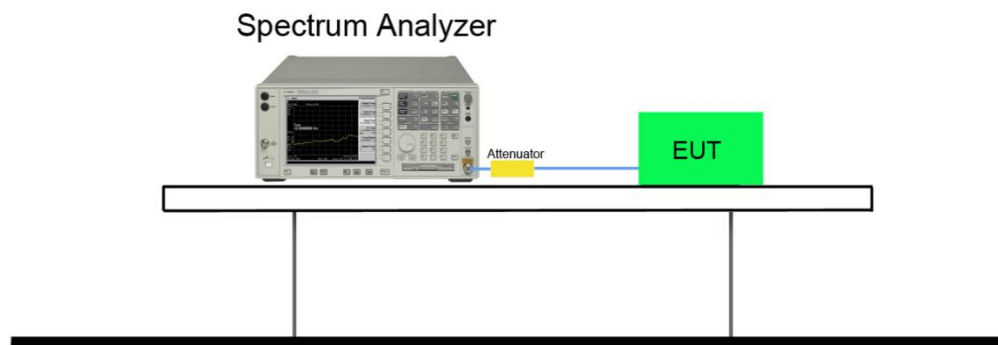

7.4.5. Test Result

Note: Reference Original Report Grant Date: 06/11/2020, FCC ID: 2AKWYXBP301.

7.5. Out-of-Band Spurious Emissions Emissions Measurement

7.5.1. Test Limit

In any 100 kHz bandwidth outside the frequency band in which the spread spectrum or digitally modulated intentional radiator is operating, the radio frequency power that is produced by the intentional radiator shall be at least 20 dB below that in the 100 kHz bandwidth within the band that contains the highest level of the desired power, based on RF conducted measurement, provided the transmitter demonstrates compliance with the peak conducted power limits.

7.5.2. Test Procedure Used

KDB 558074 D01v05- Section 11.1 & 11.2

7.5.3. Test Setting

- (a) Set instrument center frequency to DTS channel center frequency
- (b) Set the span to ≥ 1.5 times the DTS bandwidth
- (c) Set the RBW = 100 kHz
- (d) Set the VBW $\geq 3 \times$ RBW
- (e) Detector = peak
- (f) Sweep time = auto couple
- (g) Trace mode = max hold
- (h) Allow trace to fully stabilize

7.5.4. Test Setup

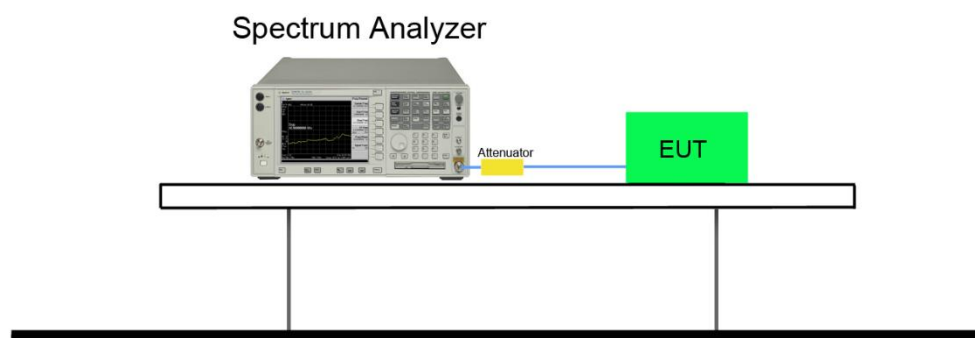

7.5.5. Test Result

Note: Reference Original Report Grant Date: 06/11/2020, FCC ID: 2AKWYXBP301.

7.6. Radiated Spurious Emission Measurement

7.6.1. Test Limit

All out of band emissions appearing in a restricted band as specified in Section 15.205 of the Title 47 CFR must not exceed the limits shown in Table per Section 15.209.

FCC Part 15 Subpart C Paragraph 15.209		
Frequency [MHz]	Field Strength [V/m]	Measured Distance [Meters]
0.009 - 0.490	2400/F (kHz)	300
0.490 - 1.705	24000/F (kHz)	30
1.705 - 30	30	30
30 - 88	100	3
88 - 216	150	3
216 - 960	200	3
Above 960	500	3

7.6.2. Test Procedure Used

KDB 558074 D01v05- Section 12.2.3 (quasi-peak measurements)

KDB 558074 D01v05- Section 12.2.4 (peak power measurements)

KDB 558074 D01v05- Section 12.2.5 (average power measurements)

7.6.3. Test Setting

Peak Field Strength Measurements

1. Analyzer center frequency was set to the frequency of the radiated spurious emission of interest
2. RBW = as specified in Table 1
3. VBW = 3MHz
4. Detector = peak
5. Sweep time = auto couple

6. Trace mode = max hold

7. Trace was allowed to stabilize

Table 1 - RBW as a function of frequency

Frequency	RBW
9 ~ 150 kHz	200 ~ 300 Hz
0.15 ~ 30 MHz	9 ~ 10 kHz
30 ~ 1000 MHz	100 ~ 120 kHz
> 1000 MHz	1 MHz

Average Field Strength Measurements

1. Analyzer center frequency was set to the frequency of the radiated spurious emission of interest

2. RBW = 1MHz

3. VBW \geq 1/T

4. De As an alternative, the instrument may be set to linear detector mode. Ensure that video filtering is applied in linear voltage domain (rather than in a log or dB domain). Some instruments require linear display mode in order to accomplish this. Others have a setting for Average-VBW Type, which can be set to "Voltage" regardless of the display mode

5. Detector = Peak

6. Sweep time = auto

7. Trace mode = max hold

8. Allow max hold to run for at least 50 times (1/duty cycle) traces

7.6.4. Test Setup

9kHz ~ 30MHz Test Setup:

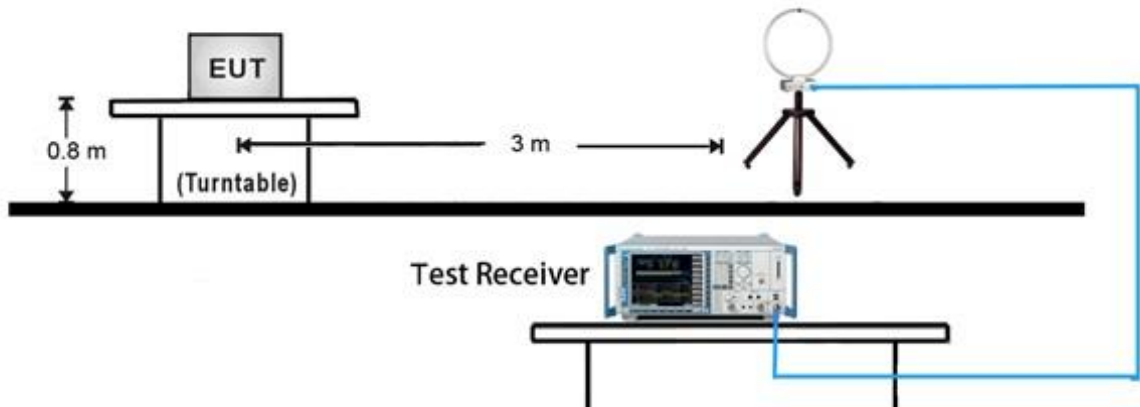

30MHz ~ 1GHz Test Setup:

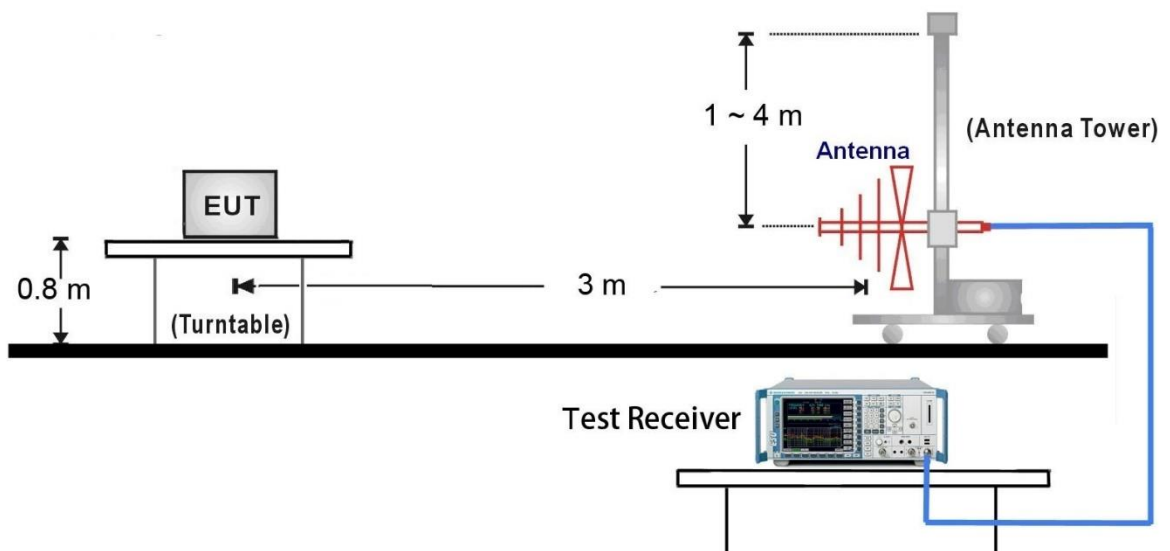

1GHz ~ 18GHz Test Setup:

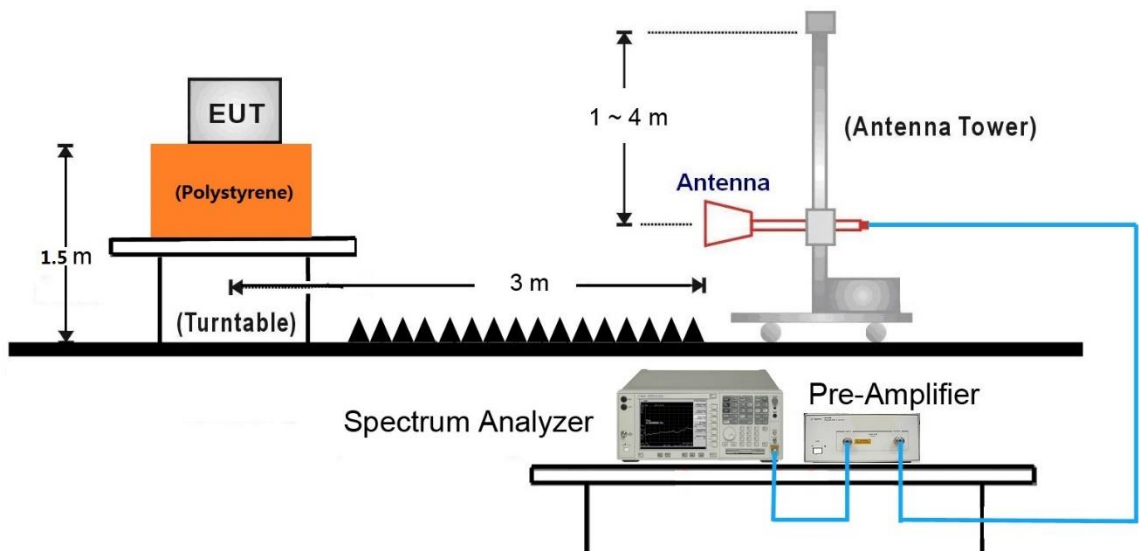

18GHz ~25GHz Test Setup:

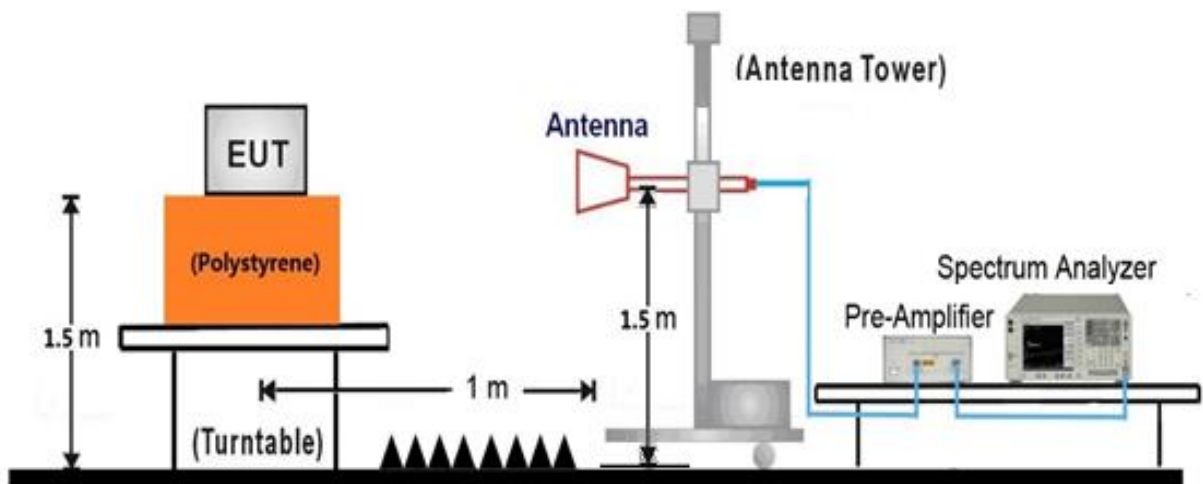

7.6.5. Test Result

EUT	Display	Date of Test	2022-01-07
Factor	VULB 9162	Temp. / Humidity	21.7°C /60%
Polarity	Horizontal	Site / Test Engineer	AC2 / Owen
Test Mode	802.11n-20MHz_TX_CH6 ANT 0+1	Test Voltage	AC 120V/60Hz

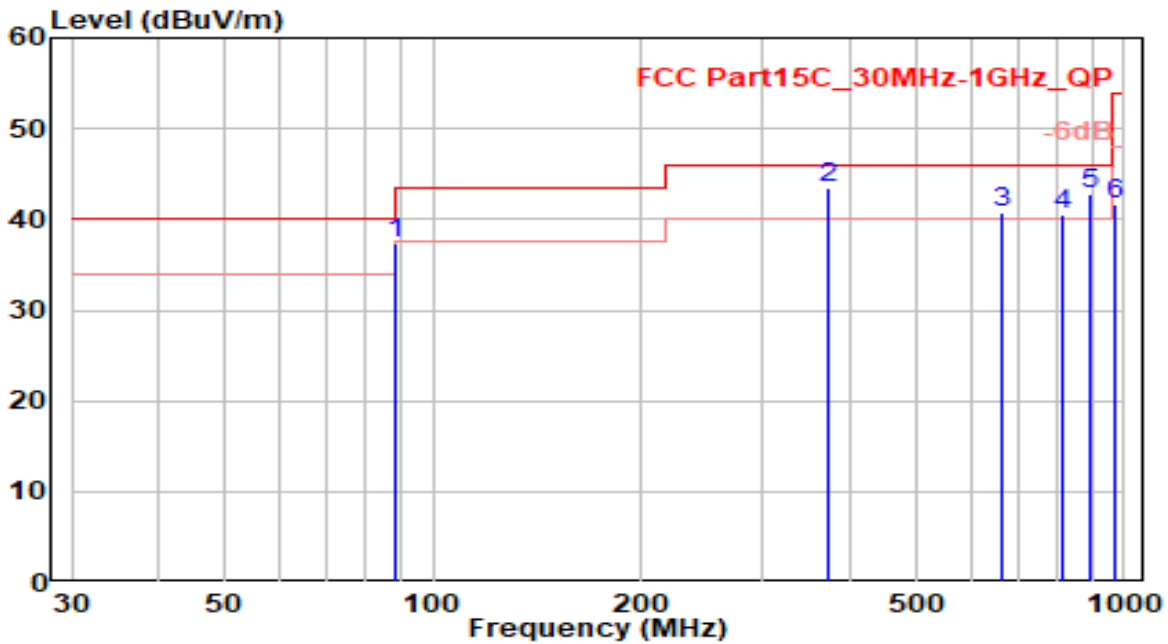

No	Frequency (MHz)	Reading (dBUV)	C.F (dB/m)	Measurement (dBUV/m)	Margin (dB)	Limit (dBUV/m)	Height (cm)	Angle (deg)	Remark (QP/PK/AV)
1	88.200	20.62	16.64	37.26	-6.24	43.50	150	330	QP
2	* 371.440	20.40	23.07	43.47	-2.53	46.00	200	310	QP
3	668.260	12.60	28.05	40.65	-5.35	46.00	150	270	QP
4	816.670	10.61	29.84	40.45	-5.55	46.00	150	290	QP
5	891.360	11.60	31.11	42.71	-3.29	46.00	150	240	QP
6	966.050	10.19	31.40	41.59	-12.41	54.00	100	310	QP

Note:

- "*", means this data is the worst emission level.
- C.F (Correction Factor) = Antenna Factor (dB)+ Cable Loss (dB).
- Measurement (dBUV/m) = Reading(dBUV) + C.F (Correction Factor).
- The emission levels of other frequencies are very lower than the limit and not show in test report.
- The amplitude of Radiated emissions (the test frequency range: 9kHz ~ 30MHz), is that proximity to ambient noise, which also are attenuated more than 20 dB below the permissible value. Therefore, the data is not presented in the report.

EUT	Display	Date of Test	2022-01-07
Factor	VULB 9162	Temp. / Humidity	21.7°C /60%
Polarity	Vertical	Site / Test Engineer	AC2 / Owen
Test Mode	802.11n-20MHz_TX_CH6 ANT 0+1	Test Voltage	AC 120V/60Hz

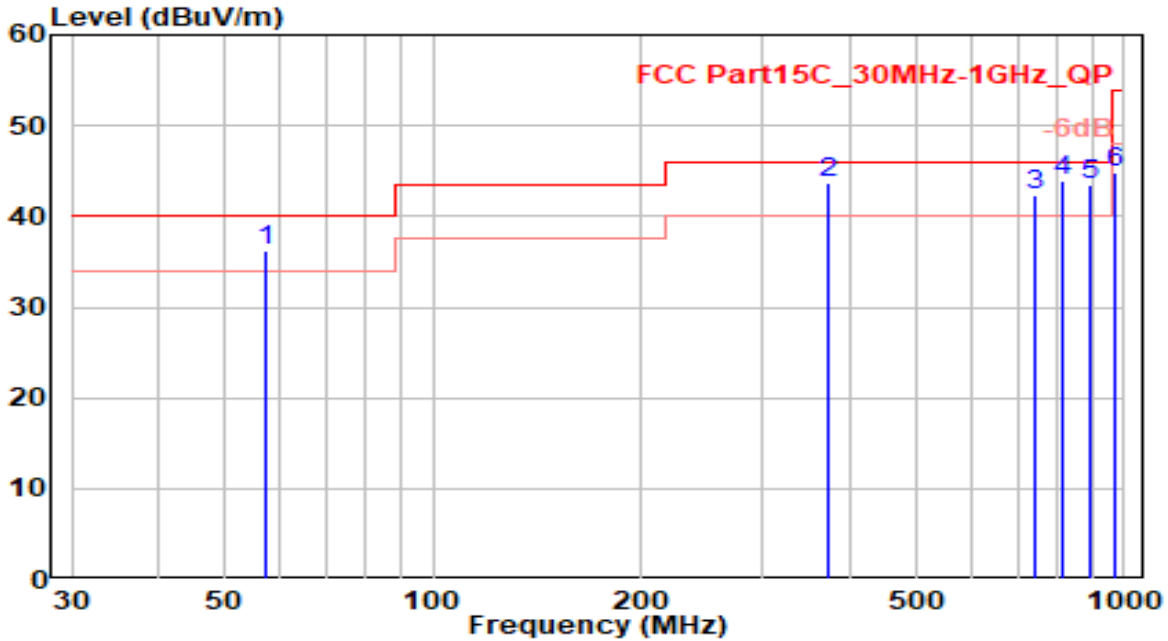

No	Frequency (MHz)	Reading (dBuV)	C.F (dB/m)	Measurement (dBuV/m)	Margin (dB)	Limit (dBuV/m)	Height (cm)	Angle (deg)	Remark (QP/PK/AV)
1	57.160	16.10	20.12	36.22	-3.78	40.00	100	95	QP
2	371.440	20.70	23.07	43.77	-2.23	46.00	135	335	QP
3	742.950	13.23	29.12	42.35	-3.65	46.00	100	0	QP
4	* 816.670	14.10	29.84	43.94	-2.06	46.00	150	360	QP
5	891.360	12.36	31.11	43.47	-2.53	46.00	150	190	QP
6	966.050	13.41	31.40	44.81	-9.19	54.00	110	360	QP

Note:

- "*" means this data is the worst emission level.
- C.F (Correction Factor) = Antenna Factor (dB)+ Cable Loss (dB).
- Measurement (dBuV/m) = Reading(dBuV) + C.F (Correction Factor).
- The emission levels of other frequencies are very lower than the limit and not show in test report.
- The amplitude of Radiated emissions (the test frequency range: 9kHz ~ 30MHz), is that proximity to ambient noise, which also are attenuated more than 20 dB below the permissible value. Therefore, the data is not presented in the report.

EUT	Display	Date of Test	2022-01-05
Factor	DRH18-E & BBHA 9170	Temp. / Humidity	22°C /58%
Polarity	Horizontal	Site / Test Engineer	AC2 / Owen
Test Mode	802.11b_TX_CH1_Ant 0+1	Test Voltage	AC 120V/60Hz

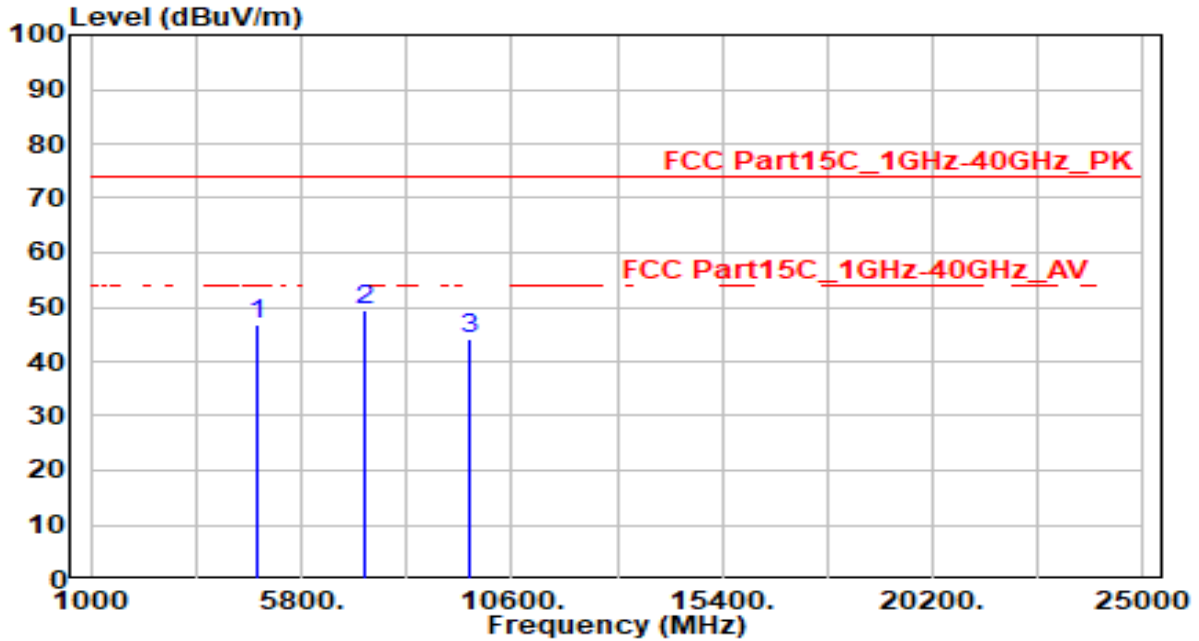

No	Frequency (MHz)	Reading (dBuV)	C.F (dB/m)	Measurement (dBuV/m)	Margin (dB)	Limit (dBuV/m)	Height (cm)	Angle (deg)	Remark (QP/PK/AV)
1	4824.000	46.68	-0.02	46.66	-27.34	74.00	200	295	Peak
2	* 7236.000	44.28	5.01	49.29	-24.71	74.00	200	305	Peak
3	9648.000	39.61	4.69	44.30	-29.70	74.00	100	75	Peak

Note:

1. " *", means this data is the worst emission level.
2. C.F (Correction Factor) = Antenna Factor (dB)+ Cable Loss (dB) – Preamplifier(dB).
3. Measurement (dBuV/m) = Reading(dBuV) + C.F (Correction Factor).
4. The emission levels of other frequencies are very lower than the limit and not show in test report.

EUT	Display	Date of Test	2022-01-05
Factor	DRH18-E & BBHA 9170	Temp. / Humidity	22°C /58%
Polarity	Vertical	Site / Test Engineer	AC2 / Owen
Test Mode	802.11b_TX_CH1_Ant 0+1	Test Voltage	AC 120V/60Hz

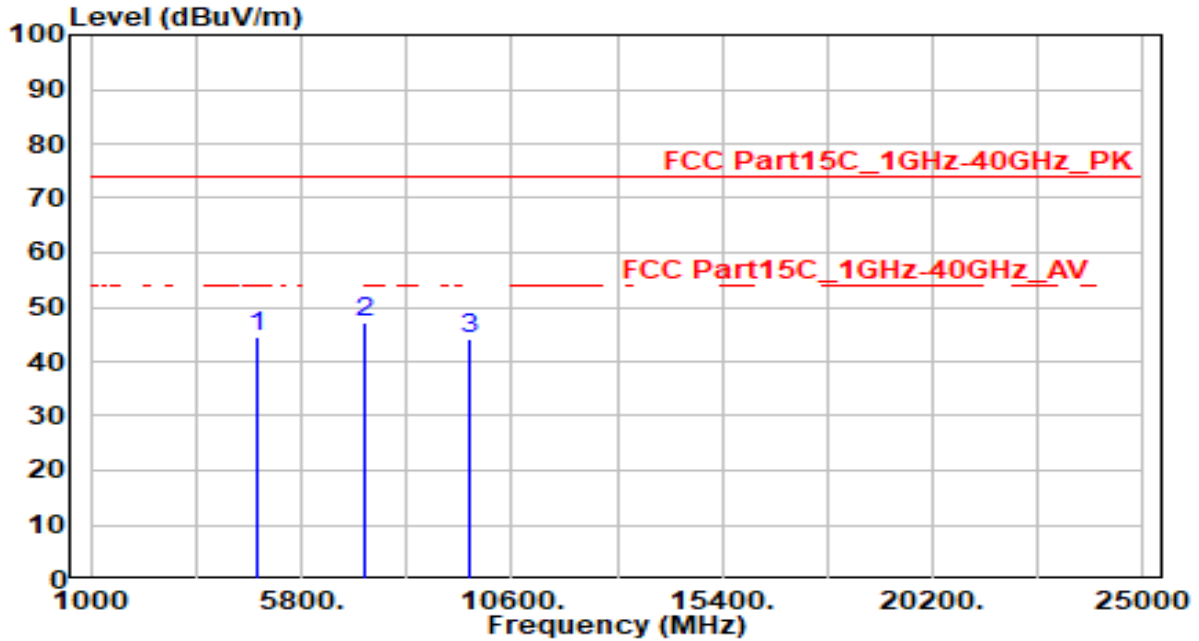

No	Frequency (MHz)	Reading (dBuV)	C.F (dB/m)	Measurement (dBuV/m)	Margin (dB)	Limit (dBuV/m)	Height (cm)	Angle (deg)	Remark (QP/PK/AV)
1	4824.000	44.47	-0.02	44.45	-29.55	74.00	195	360	Peak
2	* 7236.000	42.28	5.01	47.29	-26.71	74.00	200	5	Peak
3	9648.000	39.52	4.69	44.21	-29.79	74.00	100	50	Peak

Note:

1. " *", means this data is the worst emission level.
2. C.F (Correction Factor) = Antenna Factor (dB)+ Cable Loss (dB) – Preamplifier(dB).
3. Measurement (dBuV/m) = Reading(dBuV) + C.F (Correction Factor).
4. The emission levels of other frequencies are very lower than the limit and not show in test report.

EUT	Display	Date of Test	2022-01-05
Factor	DRH18-E & BBHA 9170	Temp. / Humidity	22°C /58%
Polarity	Horizontal	Site / Test Engineer	AC2 / Owen
Test Mode	802.11b_TX_CH6_Ant 0+1	Test Voltage	AC 120V/60Hz

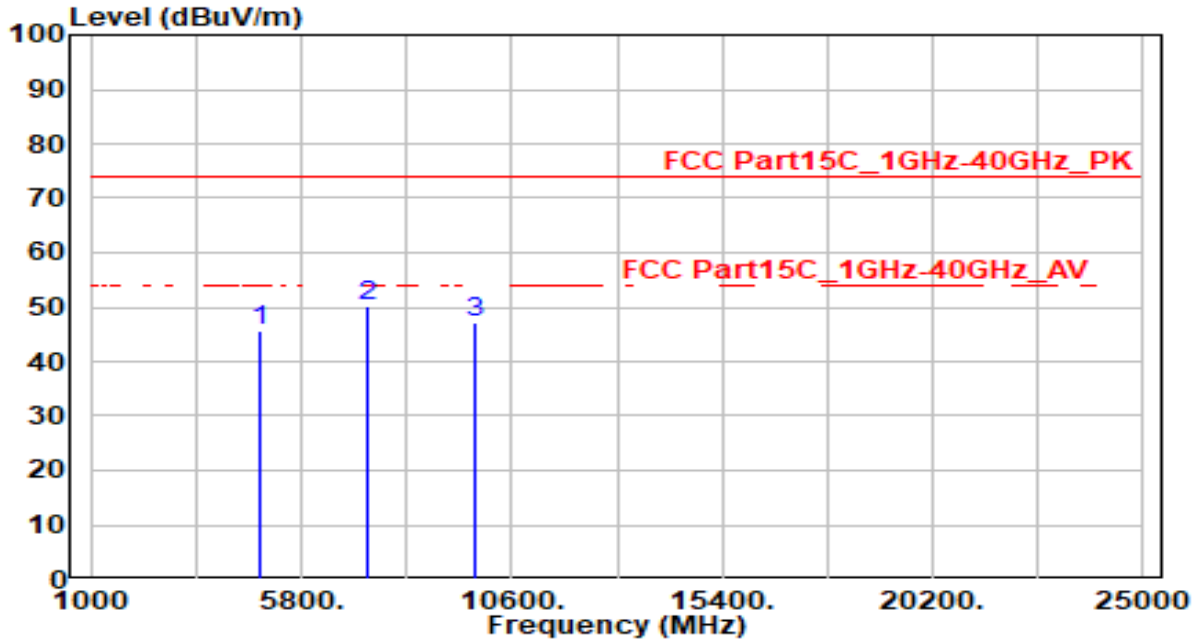

No	Frequency (MHz)	Reading (dBuV)	C.F (dB/m)	Measurement (dBuV/m)	Margin (dB)	Limit (dBuV/m)	Height (cm)	Angle (deg)	Remark (QP/PK/AV)
1	4874.000	45.73	0.08	45.81	-28.19	74.00	100	295	Peak
2	* 7311.000	45.03	5.09	50.12	-23.88	74.00	100	310	Peak
3	9748.000	42.55	4.73	47.28	-26.72	74.00	100	60	Peak

Note:

1. " *", means this data is the worst emission level.
2. C.F (Correction Factor) = Antenna Factor (dB)+ Cable Loss (dB) – Preamplifier(dB).
3. Measurement (dBuV/m) = Reading(dBuV) + C.F (Correction Factor).
4. The emission levels of other frequencies are very lower than the limit and not show in test report.

EUT	Display	Date of Test	2022-01-05
Factor	DRH18-E & BBHA 9170	Temp. / Humidity	22°C /58%
Polarity	Vertical	Site / Test Engineer	AC2 / Owen
Test Mode	802.11b_TX_CH6_Ant 0+1	Test Voltage	AC 120V/60Hz

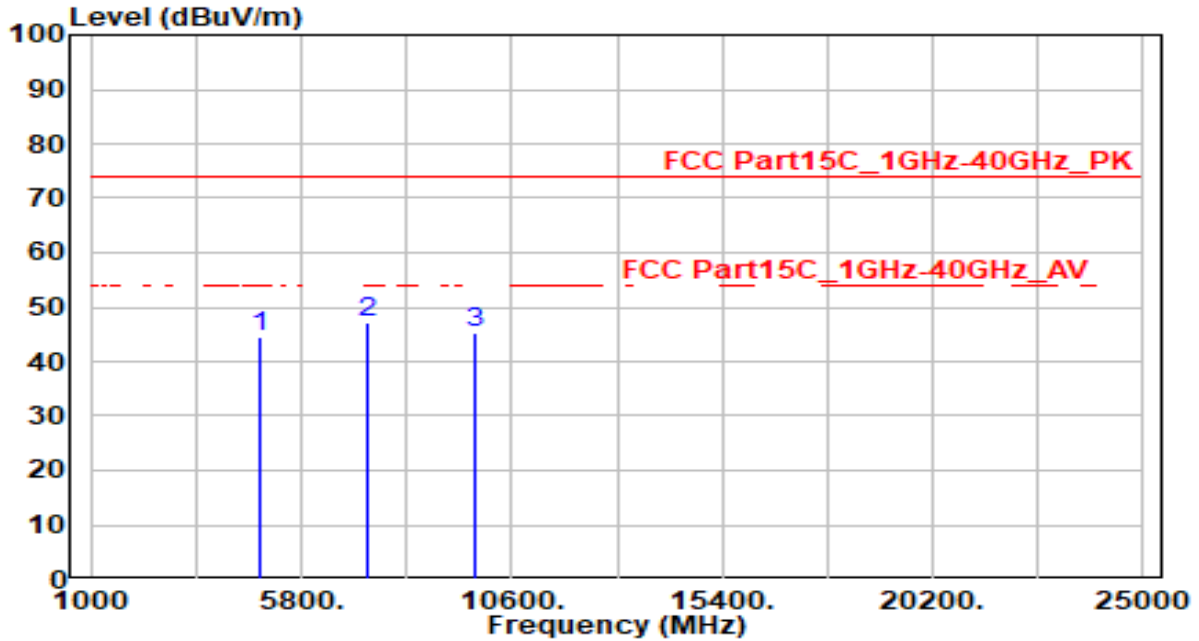

No	Frequency (MHz)	Reading (dBuV)	C.F (dB/m)	Measurement (dBuV/m)	Margin (dB)	Limit (dBuV/m)	Height (cm)	Angle (deg)	Remark (QP/PK/AV)
1	4874.000	44.36	0.08	44.44	-29.56	74.00	200	360	Peak
2	* 7311.000	42.12	5.09	47.21	-26.79	74.00	200	0	Peak
3	9748.000	40.43	4.73	45.16	-28.84	74.00	100	360	Peak

Note:

1. " *", means this data is the worst emission level.
2. C.F (Correction Factor) = Antenna Factor (dB)+ Cable Loss (dB) – Preamplifier(dB).
3. Measurement (dBuV/m) = Reading(dBuV) + C.F (Correction Factor).
4. The emission levels of other frequencies are very lower than the limit and not show in test report.

EUT	Display	Date of Test	2022-01-05
Factor	DRH18-E & BBHA 9170	Temp. / Humidity	22°C /58%
Polarity	Horizontal	Site / Test Engineer	AC2 / Owen
Test Mode	802.11b_TX_CH11_Ant 0+1	Test Voltage	AC 120V/60Hz

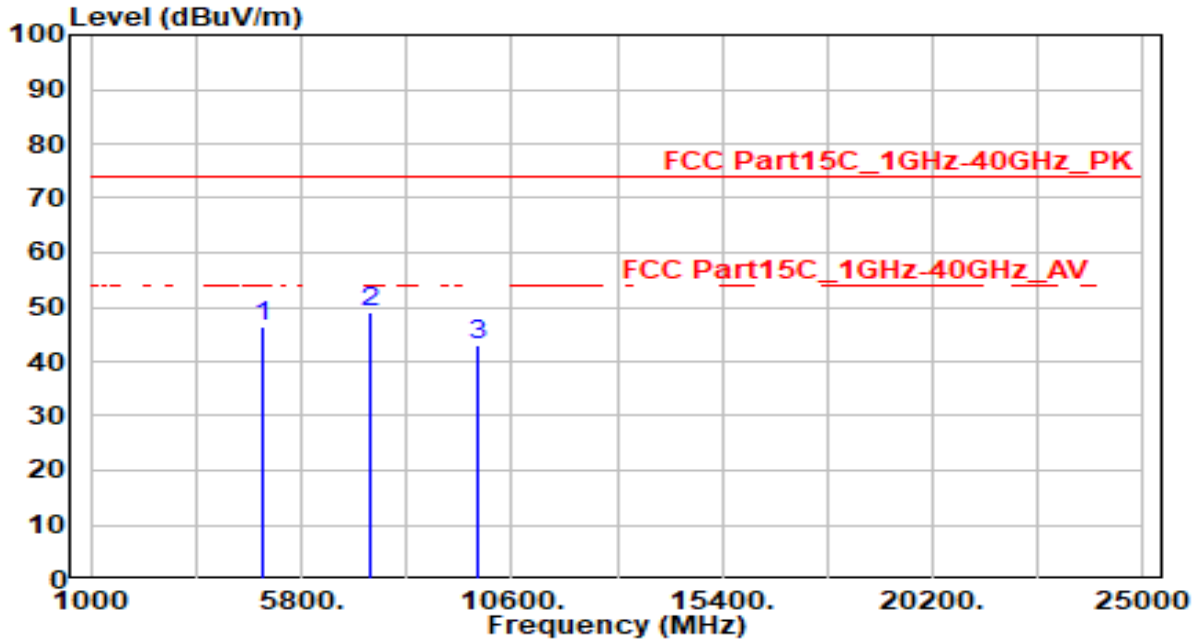

No	Frequency (MHz)	Reading (dBuV)	C.F (dB/m)	Measurement (dBuV/m)	Margin (dB)	Limit (dBuV/m)	Height (cm)	Angle (deg)	Remark (QP/PK/AV)
1	4924.000	46.25	0.19	46.45	-27.55	74.00	200	285	Peak
2	* 7386.000	44.02	5.16	49.18	-24.82	74.00	100	310	Peak
3	9848.000	38.09	4.75	42.84	-31.16	74.00	100	360	Peak

Note:

1. " *", means this data is the worst emission level.
2. C.F (Correction Factor) = Antenna Factor (dB)+ Cable Loss (dB) – Preamplifier(dB).
3. Measurement (dBuV/m) = Reading(dBuV) + C.F (Correction Factor).
4. The emission levels of other frequencies are very lower than the limit and not show in test report.

EUT	Display	Date of Test	2022-01-05
Factor	DRH18-E & BBHA 9170	Temp. / Humidity	22°C /58%
Polarity	Vertical	Site / Test Engineer	AC2 / Owen
Test Mode	802.11b_TX_CH11_Ant 0+1	Test Voltage	AC 120V/60Hz

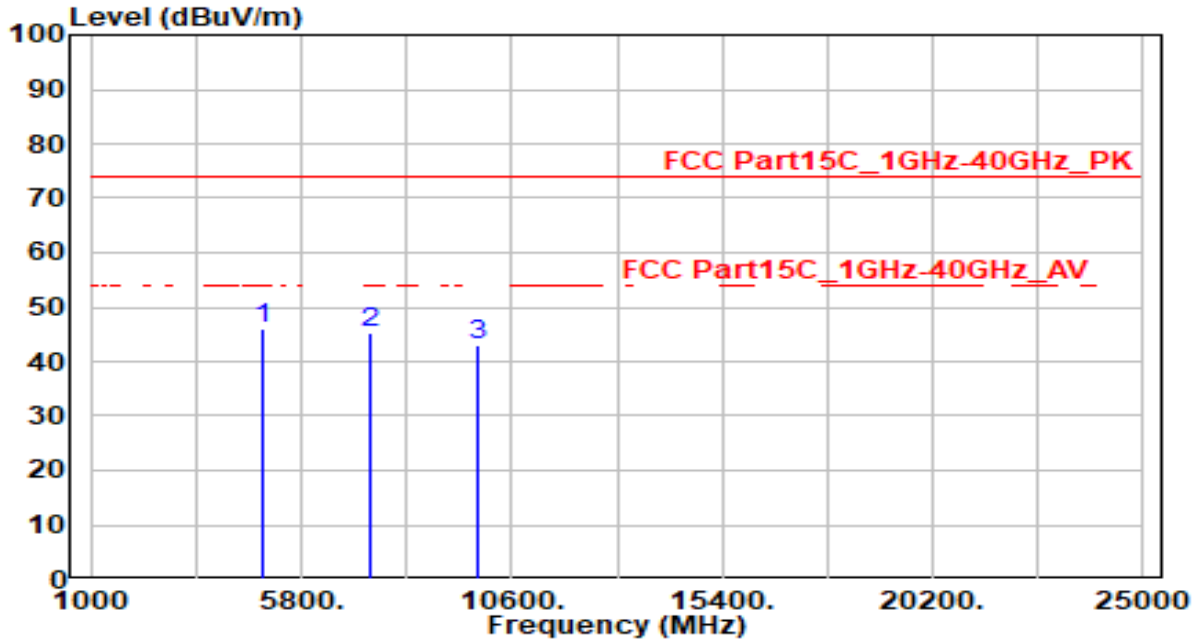

No	Frequency (MHz)	Reading (dBuV)	C.F (dB/m)	Measurement (dBuV/m)	Margin (dB)	Limit (dBuV/m)	Height (cm)	Angle (deg)	Remark (QP/PK/AV)
1	* 4924.000	45.77	0.19	45.96	-28.04	74.00	200	20	Peak
2	7386.000	40.28	5.16	45.44	-28.56	74.00	200	30	Peak
3	9848.000	38.13	4.75	42.87	-31.13	74.00	200	215	Peak

Note:

1. " *", means this data is the worst emission level.
2. C.F (Correction Factor) = Antenna Factor (dB)+ Cable Loss (dB) – Preamplifier(dB).
3. Measurement (dBuV/m) = Reading(dBuV) + C.F (Correction Factor).
4. The emission levels of other frequencies are very lower than the limit and not show in test report.

EUT	Display	Date of Test	2022-01-05
Factor	DRH18-E & BBHA 9170	Temp. / Humidity	22°C /58%
Polarity	Horizontal	Site / Test Engineer	AC2 / Owen
Test Mode	802.11g_TX_CH1_Ant 0+1	Test Voltage	AC 120V/60Hz

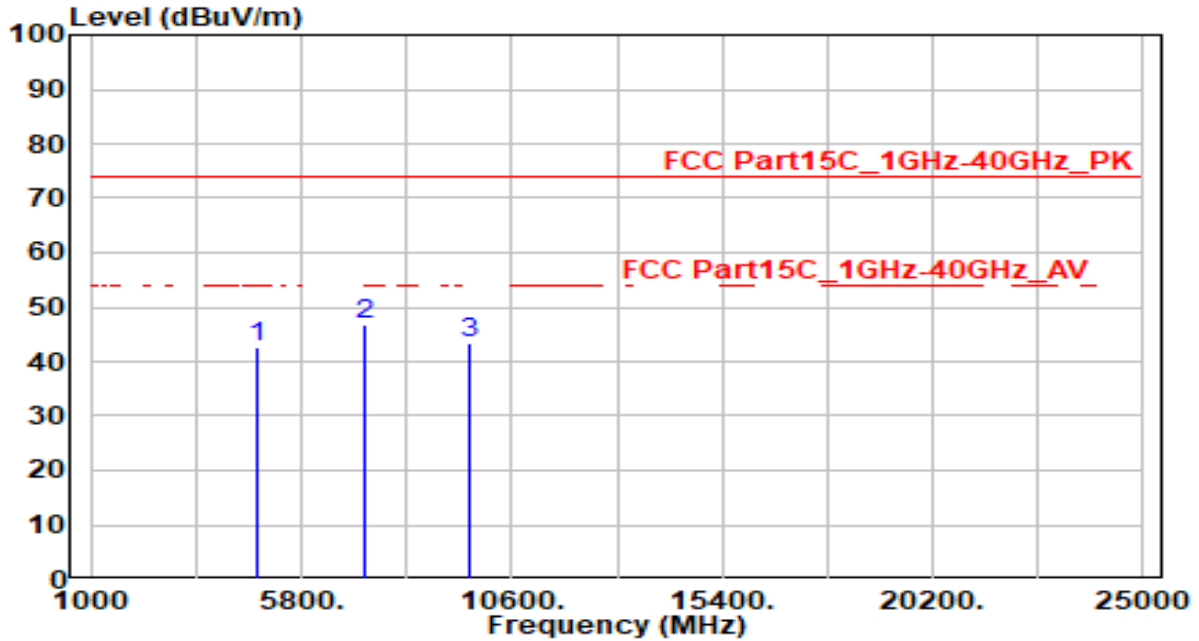

No	Frequency (MHz)	Reading (dBuV)	C.F (dB/m)	Measurement (dBuV/m)	Margin (dB)	Limit (dBuV/m)	Height (cm)	Angle (deg)	Remark (QP/PK/AV)
1	4824.000	42.54	-0.02	42.51	-31.49	74.00	200	275	Peak
2	* 7236.000	41.76	5.01	46.77	-27.23	74.00	200	275	Peak
3	9648.000	38.58	4.69	43.26	-30.74	74.00	100	165	Peak

Note:

1. " *", means this data is the worst emission level.
2. C.F (Correction Factor) = Antenna Factor (dB)+ Cable Loss (dB) – Preamplifier(dB).
3. Measurement (dBuV/m) = Reading(dBuV) + C.F (Correction Factor).
4. The emission levels of other frequencies are very lower than the limit and not show in test report.

EUT	Display	Date of Test	2022-01-05
Factor	DRH18-E & BBHA 9170	Temp. / Humidity	22°C /58%
Polarity	Vertical	Site / Test Engineer	AC2 / Owen
Test Mode	802.11g_TX_CH1_Ant 0+1	Test Voltage	AC 120V/60Hz

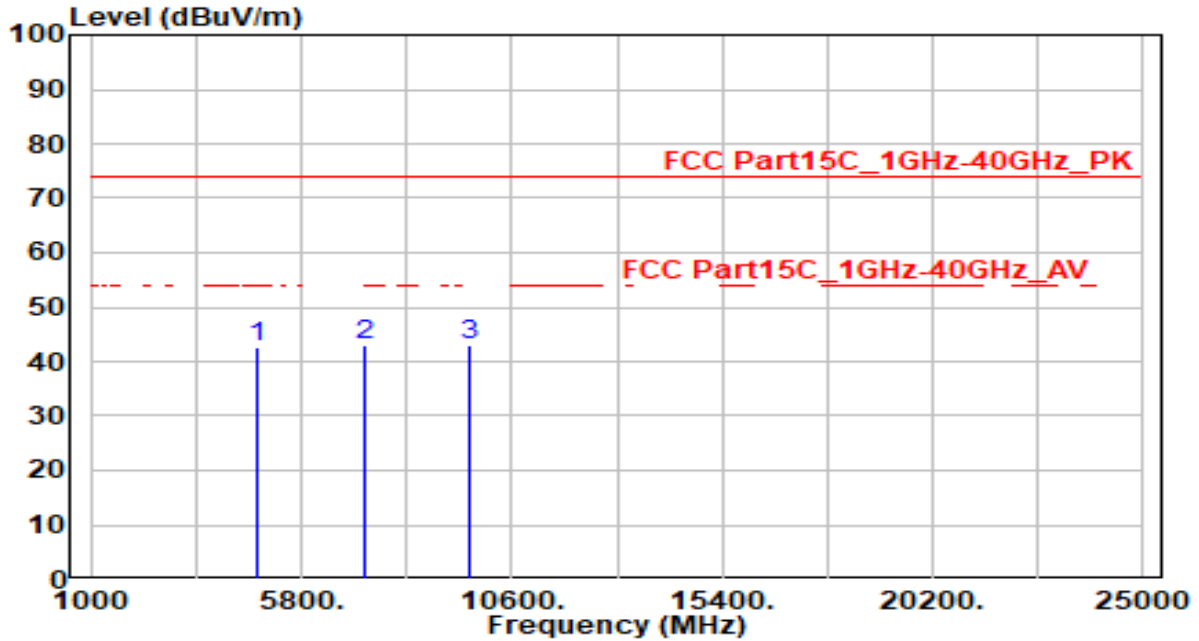

No	Frequency (MHz)	Reading (dBuV)	C.F (dB/m)	Measurement (dBuV/m)	Margin (dB)	Limit (dBuV/m)	Height (cm)	Angle (deg)	Remark (QP/PK/AV)
1	4824.000	42.51	-0.02	42.48	-31.52	74.00	200	360	Peak
2	* 7236.000	38.13	5.01	43.14	-30.86	74.00	100	325	Peak
3	9648.000	38.17	4.69	42.86	-31.14	74.00	100	360	Peak

Note:

1. " *", means this data is the worst emission level.
2. C.F (Correction Factor) = Antenna Factor (dB)+ Cable Loss (dB) – Preamplifier(dB).
3. Measurement (dBuV/m) = Reading(dBuV) + C.F (Correction Factor).
4. The emission levels of other frequencies are very lower than the limit and not show in test report.

EUT	Display	Date of Test	2022-01-05
Factor	DRH18-E & BBHA 9170	Temp. / Humidity	22°C /58%
Polarity	Horizontal	Site / Test Engineer	AC2 / Owen
Test Mode	802.11g_TX_CH6_Ant 0+1	Test Voltage	AC 120V/60Hz

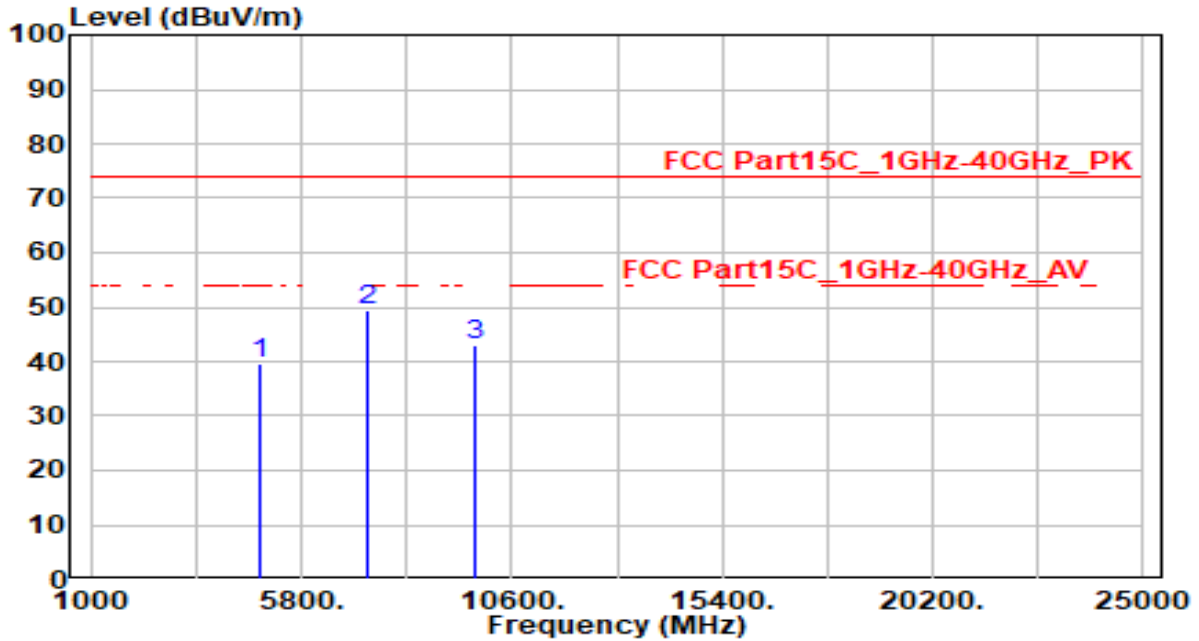

No	Frequency (MHz)	Reading (dBuV)	C.F (dB/m)	Measurement (dBuV/m)	Margin (dB)	Limit (dBuV/m)	Height (cm)	Angle (deg)	Remark (QP/PK/AV)
1	4874.000	39.48	0.08	39.57	-34.43	74.00	100	290	Peak
2	* 7311.000	44.42	5.09	49.51	-24.49	74.00	200	330	Peak
3	9748.000	38.40	4.73	43.12	-30.88	74.00	200	0	Peak

Note:

1. " *", means this data is the worst emission level.
2. C.F (Correction Factor) = Antenna Factor (dB)+ Cable Loss (dB) – Preamplifier(dB).
3. Measurement (dBuV/m) = Reading(dBuV) + C.F (Correction Factor).
4. The emission levels of other frequencies are very lower than the limit and not show in test report.

EUT	Display	Date of Test	2022-01-05
Factor	DRH18-E & BBHA 9170	Temp. / Humidity	22°C /58%
Polarity	Vertical	Site / Test Engineer	AC2 / Owen
Test Mode	802.11g_TX_CH6_Ant 0+1	Test Voltage	AC 120V/60Hz

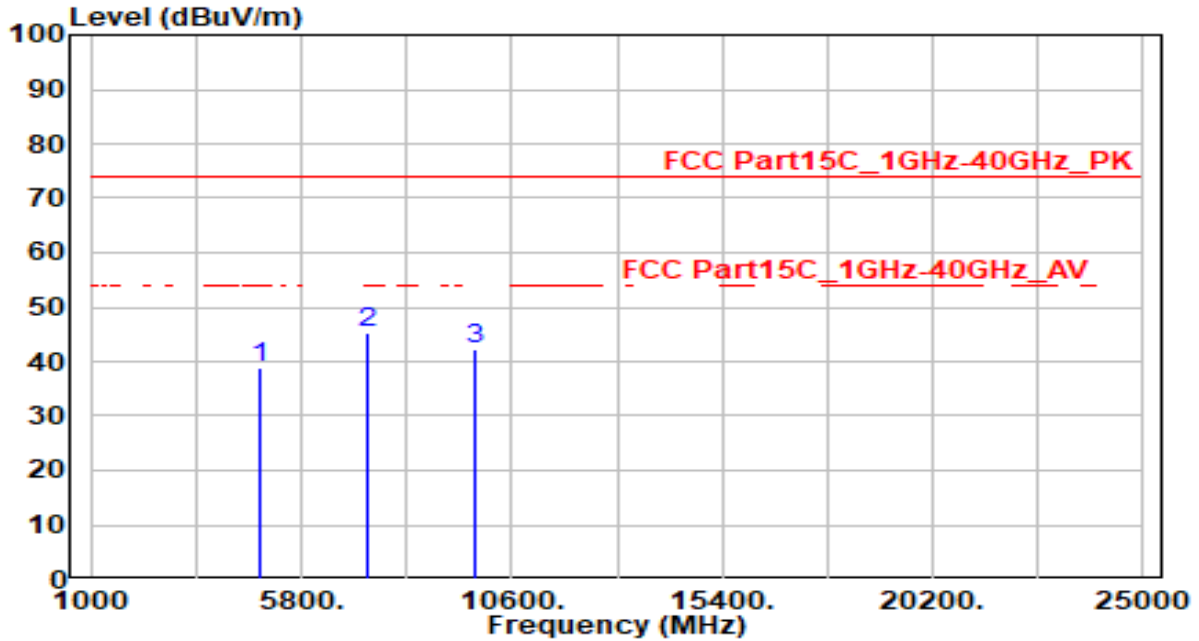

No	Frequency (MHz)	Reading (dBuV)	C.F (dB/m)	Measurement (dBuV/m)	Margin (dB)	Limit (dBuV/m)	Height (cm)	Angle (deg)	Remark (QP/PK/AV)
1	4874.000	38.82	0.08	38.90	-35.10	74.00	100	350	Peak
2	* 7311.000	40.36	5.09	45.45	-28.55	74.00	200	5	Peak
3	9748.000	37.37	4.73	42.10	-31.90	74.00	100	355	Peak

Note:

1. " *", means this data is the worst emission level.
2. C.F (Correction Factor) = Antenna Factor (dB)+ Cable Loss (dB) – Preamplifier(dB).
3. Measurement (dBuV/m) = Reading(dBuV) + C.F (Correction Factor).
4. The emission levels of other frequencies are very lower than the limit and not show in test report.

EUT	Display	Date of Test	2022-01-05
Factor	DRH18-E & BBHA 9170	Temp. / Humidity	22°C /58%
Polarity	Horizontal	Site / Test Engineer	AC2 / Owen
Test Mode	802.11g_TX_CH11_Ant 0+1	Test Voltage	AC 120V/60Hz

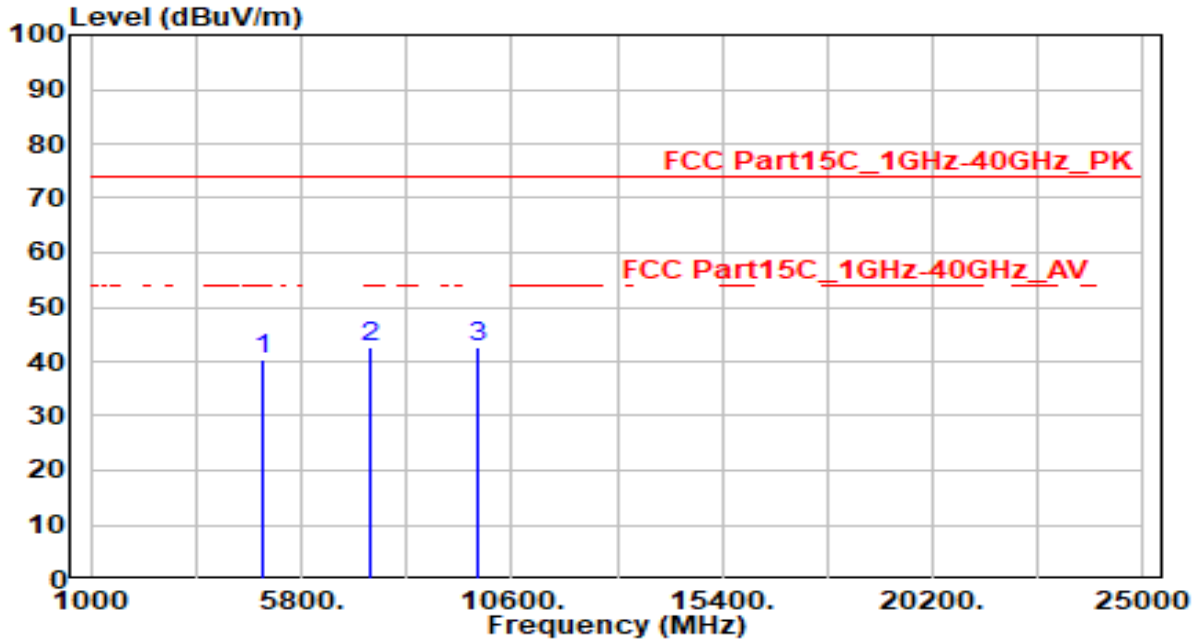

No	Frequency (MHz)	Reading (dBuV)	C.F (dB/m)	Measurement (dBuV/m)	Margin (dB)	Limit (dBuV/m)	Height (cm)	Angle (deg)	Remark (QP/PK/AV)
1	4924.000	40.29	0.19	40.48	-33.52	74.00	100	285	Peak
2	7386.000	37.40	5.16	42.56	-31.44	74.00	100	295	Peak
3	* 9848.000	37.86	4.75	42.61	-31.39	74.00	100	165	Peak

Note:

1. " *", means this data is the worst emission level.
2. C.F (Correction Factor) = Antenna Factor (dB)+ Cable Loss (dB) – Preamplifier(dB).
3. Measurement (dBuV/m) = Reading(dBuV) + C.F (Correction Factor).
4. The emission levels of other frequencies are very lower than the limit and not show in test report.

EUT	Display	Date of Test	2022-01-05
Factor	DRH18-E & BBHA 9170	Temp. / Humidity	22°C /58%
Polarity	Vertical	Site / Test Engineer	AC2 / Owen
Test Mode	802.11g_TX_CH11_Ant 0+1	Test Voltage	AC 120V/60Hz

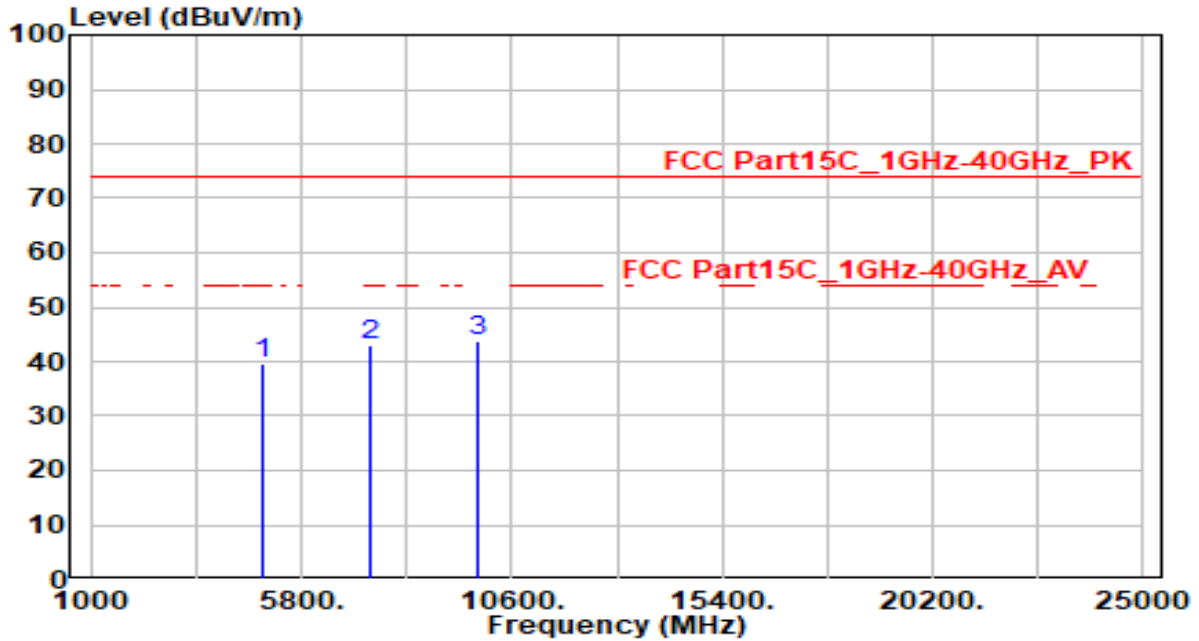

No	Frequency (MHz)	Reading (dBuV)	C.F (dB/m)	Measurement (dBuV/m)	Margin (dB)	Limit (dBuV/m)	Height (cm)	Angle (deg)	Remark (QP/PK/AV)
1	4924.000	39.54	0.19	39.73	-34.27	74.00	170	360	Peak
2	7386.000	37.85	5.16	43.01	-30.99	74.00	200	280	Peak
3	* 9848.000	39.08	4.75	43.83	-30.17	74.00	100	200	Peak

Note:

1. " *", means this data is the worst emission level.
2. C.F (Correction Factor) = Antenna Factor (dB)+ Cable Loss (dB) – Preamplifier(dB).
3. Measurement (dBuV/m) = Reading(dBuV) + C.F (Correction Factor).
4. The emission levels of other frequencies are very lower than the limit and not show in test report.

EUT	Display	Date of Test	2022-01-05
Factor	DRH18-E & BBHA 9170	Temp. / Humidity	22°C /58%
Polarity	Horizontal	Site / Test Engineer	AC2 / Owen
Test Mode	802.11n-20MHz_TX_CH1_Ant 0+1	Test Voltage	AC 120V/60Hz

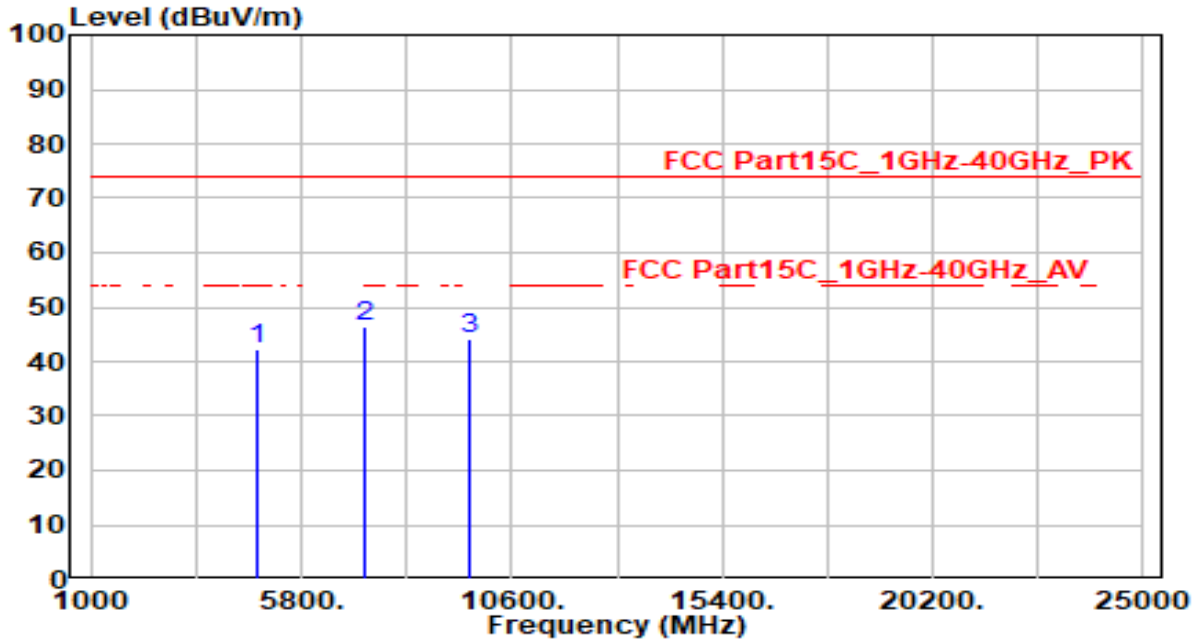

No	Frequency (MHz)	Reading (dBuV)	C.F (dB/m)	Measurement (dBuV/m)	Margin (dB)	Limit (dBuV/m)	Height (cm)	Angle (deg)	Remark (QP/PK/AV)
1	4824.000	42.20	-0.02	42.18	-31.82	74.00	200	280	Peak
2	* 7236.000	41.51	5.01	46.53	-27.47	74.00	200	285	Peak
3	9648.000	39.59	4.69	44.27	-29.73	74.00	200	35	Peak

Note:

1. " *", means this data is the worst emission level.
2. C.F (Correction Factor) = Antenna Factor (dB)+ Cable Loss (dB) – Preamplifier(dB).
3. Measurement (dBuV/m) = Reading(dBuV) + C.F (Correction Factor).
4. The emission levels of other frequencies are very lower than the limit and not show in test report.

EUT	Display	Date of Test	2022-01-05
Factor	DRH18-E & BBHA 9170	Temp. / Humidity	22°C /58%
Polarity	Vertical	Site / Test Engineer	AC2 / Owen
Test Mode	802.11n-20MHz_TX_CH1_Ant 0+1	Test Voltage	AC 120V/60Hz

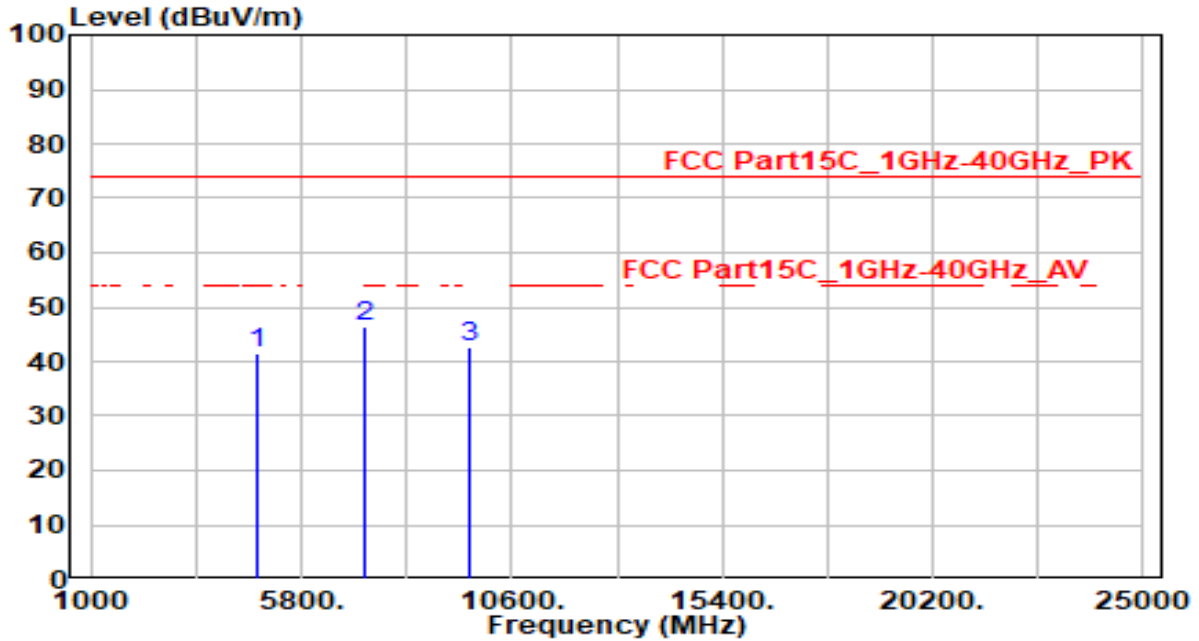

No	Frequency (MHz)	Reading (dBuV)	C.F (dB/m)	Measurement (dBuV/m)	Margin (dB)	Limit (dBuV/m)	Height (cm)	Angle (deg)	Remark (QP/PK/AV)
1	4824.000	41.42	-0.02	41.40	-32.60	74.00	145	360	Peak
2	* 7236.000	41.26	5.01	46.27	-27.73	74.00	225	0	Peak
3	9648.000	38.07	4.69	42.76	-31.24	74.00	105	360	Peak

Note:

1. " *", means this data is the worst emission level.
2. C.F (Correction Factor) = Antenna Factor (dB)+ Cable Loss (dB) – Preamplifier(dB).
3. Measurement (dBuV/m) = Reading(dBuV) + C.F (Correction Factor).
4. The emission levels of other frequencies are very lower than the limit and not show in test report.

EUT	Display	Date of Test	2022-01-05
Factor	DRH18-E & BBHA 9170	Temp. / Humidity	22°C /58%
Polarity	Horizontal	Site / Test Engineer	AC2 / Owen
Test Mode	802.11n-20MHz_TX_CH6_Ant 0+1	Test Voltage	AC 120V/60Hz

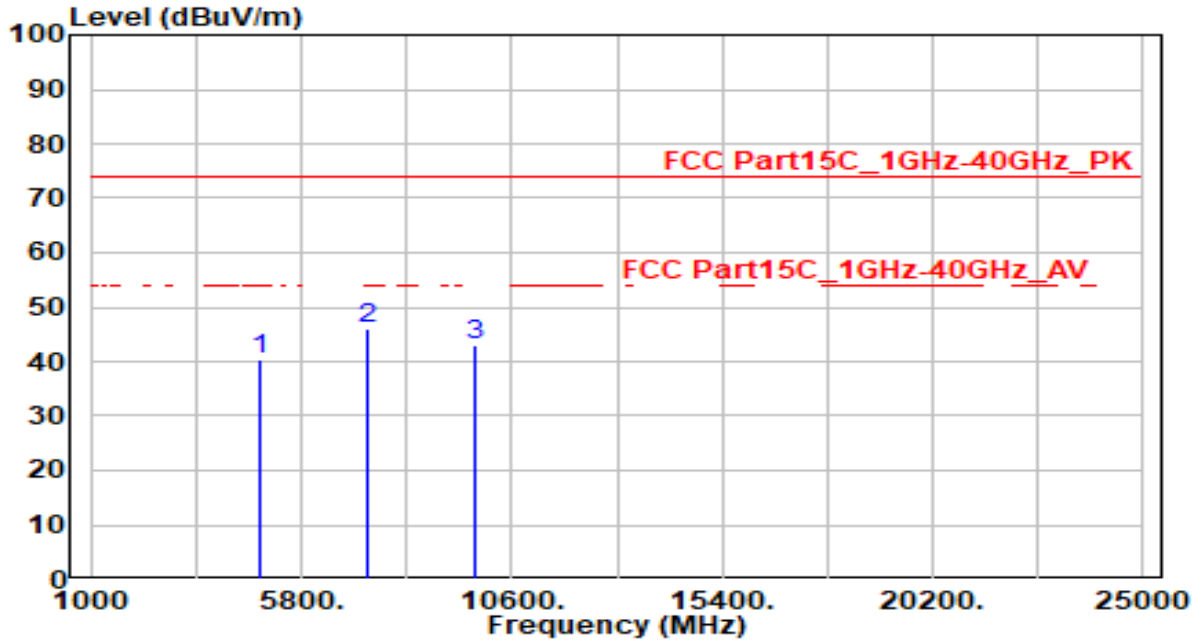

No	Frequency (MHz)	Reading (dBuV)	C.F (dB/m)	Measurement (dBuV/m)	Margin (dB)	Limit (dBuV/m)	Height (cm)	Angle (deg)	Remark (QP/PK/AV)
1	4874.000	40.16	0.08	40.25	-33.75	74.00	200	300	Peak
2	* 7311.000	41.05	5.09	46.14	-27.86	74.00	100	3225	Peak
3	9748.000	38.19	4.73	42.92	-31.08	74.00	200	105	Peak

Note:

1. " *", means this data is the worst emission level.
2. C.F (Correction Factor) = Antenna Factor (dB)+ Cable Loss (dB) – Preamplifier(dB).
3. Measurement (dBuV/m) = Reading(dBuV) + C.F (Correction Factor).
4. The emission levels of other frequencies are very lower than the limit and not show in test report.

EUT	Display	Date of Test	2022-01-05
Factor	DRH18-E & BBHA 9170	Temp. / Humidity	22°C /58%
Polarity	Vertical	Site / Test Engineer	AC2 / Owen
Test Mode	802.11n-20MHz_TX_CH6_Ant 0+1	Test Voltage	AC 120V/60Hz

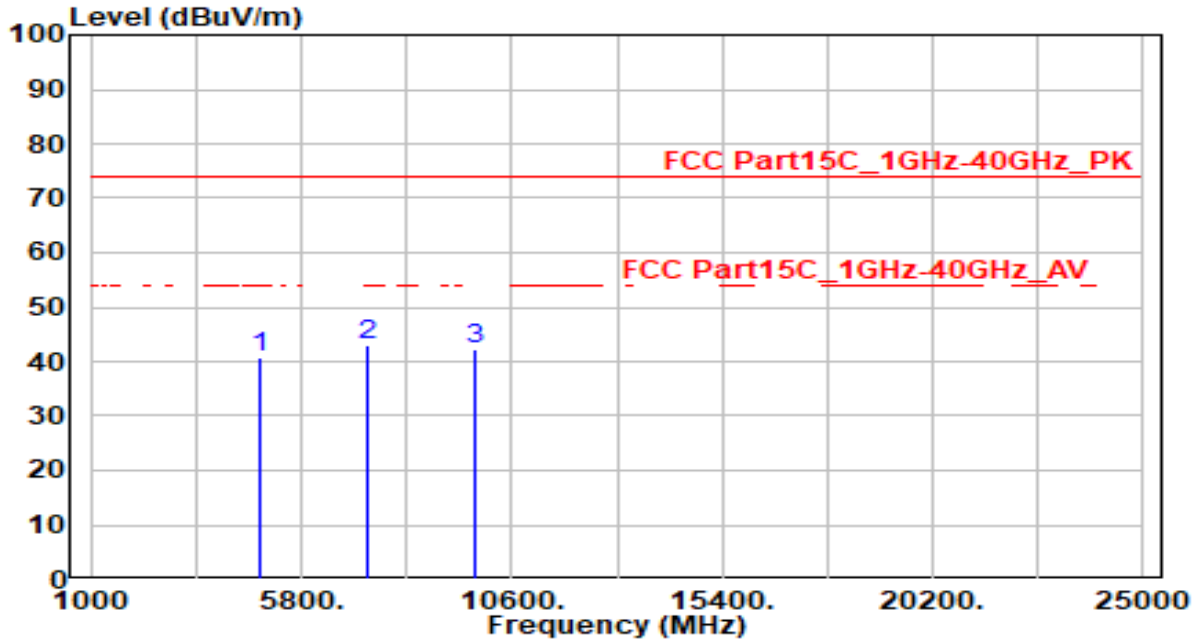

No	Frequency (MHz)	Reading (dBuV)	C.F (dB/m)	Measurement (dBuV/m)	Margin (dB)	Limit (dBuV/m)	Height (cm)	Angle (deg)	Remark (QP/PK/AV)
1	4874.000	40.66	0.08	40.74	-33.26	74.00	195	360	Peak
2	* 7311.000	38.00	5.09	43.08	-30.92	74.00	160	360	Peak
3	9748.000	37.49	4.73	42.22	-31.78	74.00	100	55	Peak

Note:

1. " *", means this data is the worst emission level.
2. C.F (Correction Factor) = Antenna Factor (dB)+ Cable Loss (dB) – Preamplifier(dB).
3. Measurement (dBuV/m) = Reading(dBuV) + C.F (Correction Factor).
4. The emission levels of other frequencies are very lower than the limit and not show in test report.

EUT	Display	Date of Test	2022-01-05
Factor	DRH18-E & BBHA 9170	Temp. / Humidity	22°C /58%
Polarity	Horizontal	Site / Test Engineer	AC2 / Owen
Test Mode	802.11n-20MHz_TX_CH11_Ant 0+1	Test Voltage	AC 120V/60Hz

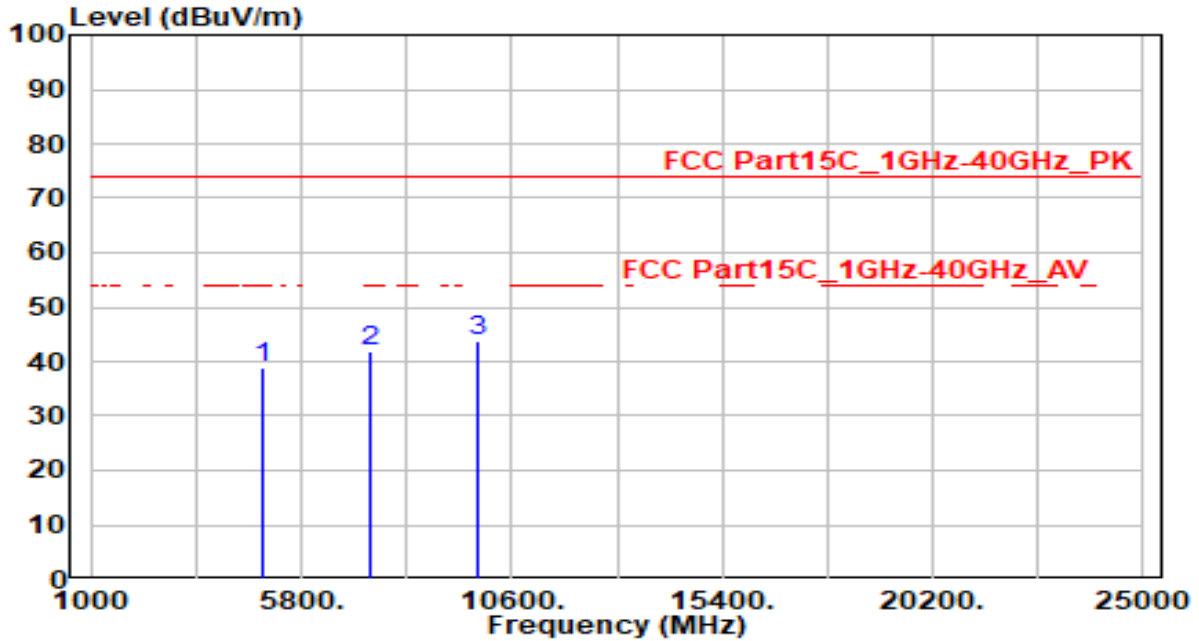

No	Frequency (MHz)	Reading (dBuV)	C.F (dB/m)	Measurement (dBuV/m)	Margin (dB)	Limit (dBuV/m)	Height (cm)	Angle (deg)	Remark (QP/PK/AV)
1	4924.000	38.80	0.19	38.99	-35.01	74.00	200	10	Peak
2	7386.000	36.76	5.16	41.92	-32.08	74.00	200	335	Peak
3	* 9848.000	39.04	4.75	43.78	-30.22	74.00	100	65	Peak

Note:

1. " *", means this data is the worst emission level.
2. C.F (Correction Factor) = Antenna Factor (dB)+ Cable Loss (dB) – Preamplifier(dB).
3. Measurement (dBuV/m) = Reading(dBuV) + C.F (Correction Factor).
4. The emission levels of other frequencies are very lower than the limit and not show in test report.

EUT	Display	Date of Test	2022-01-05
Factor	DRH18-E & BBHA 9170	Temp. / Humidity	22°C /58%
Polarity	Vertical	Site / Test Engineer	AC2 / Owen
Test Mode	802.11n-20MHz_TX_CH11_Ant 0+1	Test Voltage	AC 120V/60Hz

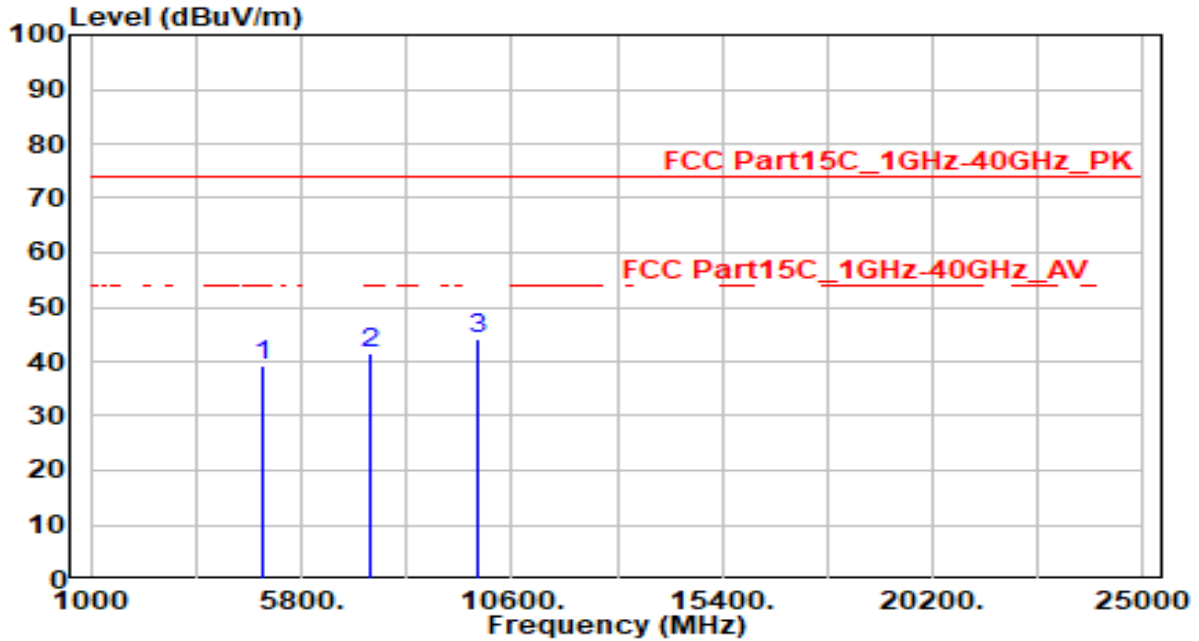

No	Frequency (MHz)	Reading (dBuV)	C.F (dB/m)	Measurement (dBuV/m)	Margin (dB)	Limit (dBuV/m)	Height (cm)	Angle (deg)	Remark (QP/PK/AV)
1	4924.000	39.22	0.19	39.41	-34.59	74.00	200	360	Peak
2	7386.000	36.48	5.16	41.64	-32.36	74.00	200	200	Peak
3	* 9848.000	39.25	4.75	44.00	-30.00	74.00	165	360	Peak

Note:

1. " *", means this data is the worst emission level.
2. C.F (Correction Factor) = Antenna Factor (dB)+ Cable Loss (dB) – Preamplifier(dB).
3. Measurement (dBuV/m) = Reading(dBuV) + C.F (Correction Factor).
4. The emission levels of other frequencies are very lower than the limit and not show in test report.

EUT	Display	Date of Test	2022-01-05
Factor	DRH18-E & BBHA 9170	Temp. / Humidity	22°C /58%
Polarity	Horizontal	Site / Test Engineer	AC2 / Owen
Test Mode	802.11n-40MHz_TX_CH3_Ant 0+1	Test Voltage	AC 120V/60Hz

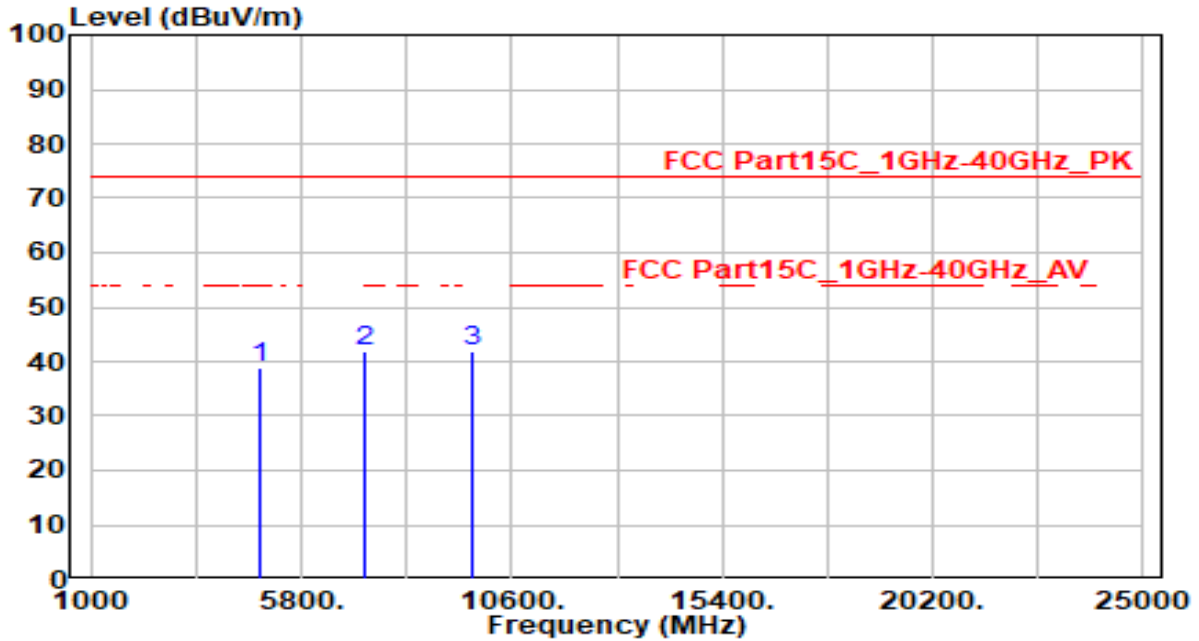

No	Frequency (MHz)	Reading (dBuV)	C.F (dB/m)	Measurement (dBuV/m)	Margin (dB)	Limit (dBuV/m)	Height (cm)	Angle (deg)	Remark (QP/PK/AV)
1	4844.000	38.92	0.02	38.94	-35.06	74.00	100	290	Peak
2	* 7266.000	36.88	5.04	41.92	-32.08	74.00	200	315	Peak
3	9688.000	37.20	4.71	41.91	-32.09	74.00	100	295	Peak

Note:

1. " *", means this data is the worst emission level.
2. C.F (Correction Factor) = Antenna Factor (dB)+ Cable Loss (dB) – Preamplifier(dB).
3. Measurement (dBuV/m) = Reading(dBuV) + C.F (Correction Factor).
4. The emission levels of other frequencies are very lower than the limit and not show in test report.

EUT	Display	Date of Test	2022-01-05
Factor	DRH18-E & BBHA 9170	Temp. / Humidity	22°C /58%
Polarity	Vertical	Site / Test Engineer	AC2 / Owen
Test Mode	802.11n-40MHz_TX_CH3_Ant 0+1	Test Voltage	AC 120V/60Hz

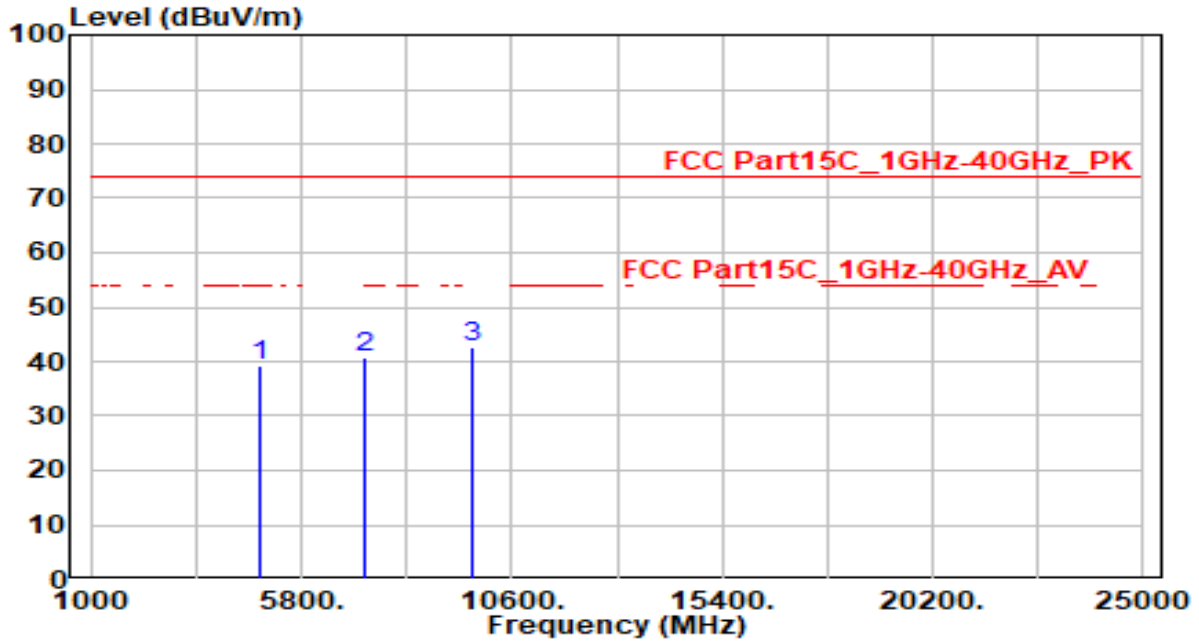

No	Frequency (MHz)	Reading (dBuV)	C.F (dB/m)	Measurement (dBuV/m)	Margin (dB)	Limit (dBuV/m)	Height (cm)	Angle (deg)	Remark (QP/PK/AV)
1	4844.000	39.19	0.02	39.21	-34.79	74.00	185	360	Peak
2	7266.000	35.89	5.04	40.93	-33.07	74.00	100	50	Peak
3	* 9688.000	38.07	4.71	42.77	-31.23	74.00	100	225	Peak

Note:

1. " *", means this data is the worst emission level.
2. C.F (Correction Factor) = Antenna Factor (dB)+ Cable Loss (dB) – Preamplifier(dB).
3. Measurement (dBuV/m) = Reading(dBuV) + C.F (Correction Factor).
4. The emission levels of other frequencies are very lower than the limit and not show in test report.

EUT	Display	Date of Test	2022-01-05
Factor	DRH18-E & BBHA 9170	Temp. / Humidity	22°C /58%
Polarity	Horizontal	Site / Test Engineer	AC2 / Owen
Test Mode	802.11n-40MHz_TX_CH6_Ant 0+1	Test Voltage	AC 120V/60Hz

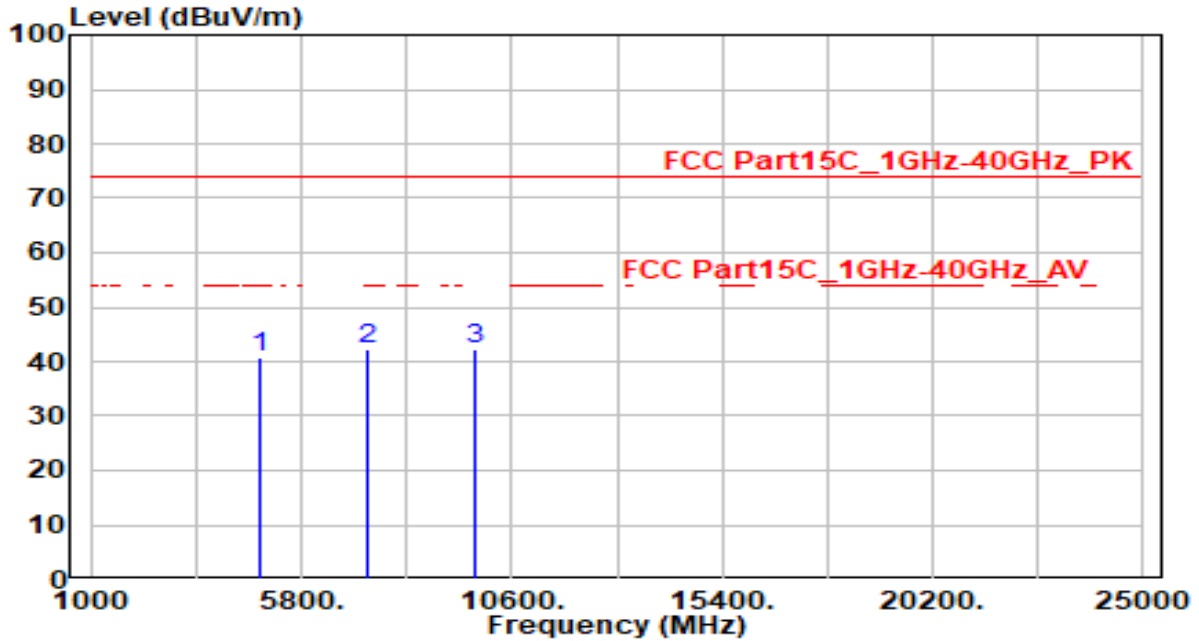

No	Frequency (MHz)	Reading (dBuV)	C.F (dB/m)	Measurement (dBuV/m)	Margin (dB)	Limit (dBuV/m)	Height (cm)	Angle (deg)	Remark (QP/PK/AV)
1	4874.000	40.77	0.08	40.85	-33.15	74.00	200	295	Peak
2	7311.000	36.99	5.09	42.08	-31.92	74.00	100	340	Peak
3	* 9748.000	37.64	4.73	42.37	-31.63	74.00	200	165	Peak

Note:

1. " *", means this data is the worst emission level.
2. C.F (Correction Factor) = Antenna Factor (dB)+ Cable Loss (dB) – Preamplifier(dB).
3. Measurement (dBuV/m) = Reading(dBuV) + C.F (Correction Factor).
4. The emission levels of other frequencies are very lower than the limit and not show in test report.

EUT	Display	Date of Test	2022-01-05
Factor	DRH18-E & BBHA 9170	Temp. / Humidity	22°C /58%
Polarity	Vertical	Site / Test Engineer	AC2 / Owen
Test Mode	802.11n-40MHz_TX_CH6_Ant 0+1	Test Voltage	AC 120V/60Hz

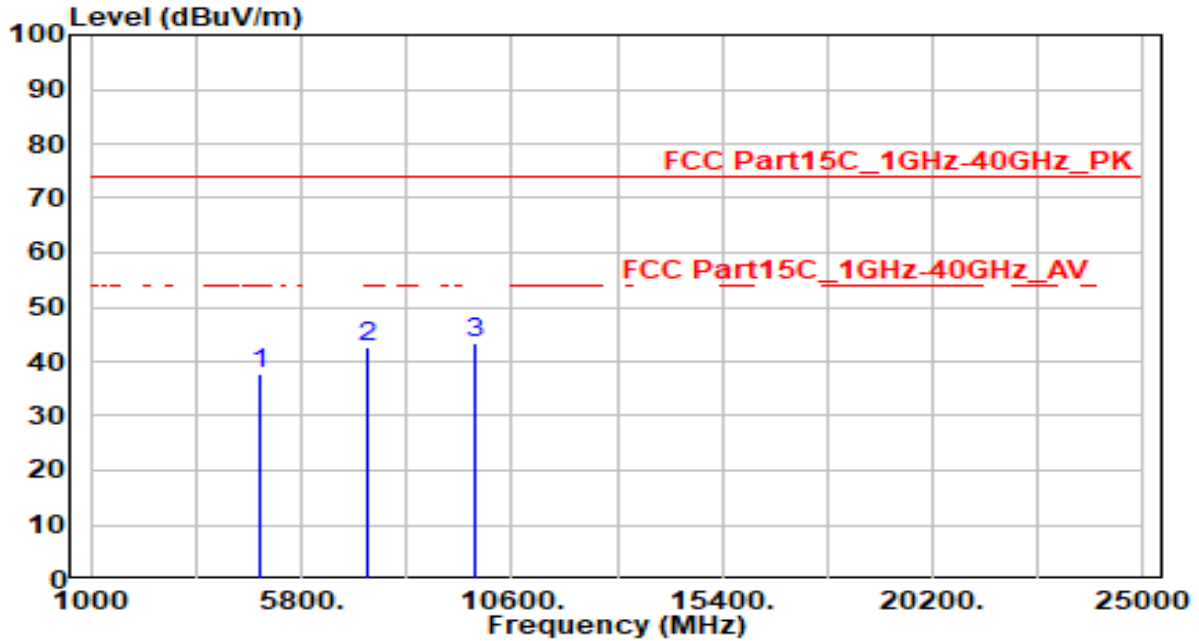

No	Frequency (MHz)	Reading (dBuV)	C.F (dB/m)	Measurement (dBuV/m)	Margin (dB)	Limit (dBuV/m)	Height (cm)	Angle (deg)	Remark (QP/PK/AV)
1	4874.000	37.53	0.08	37.61	-36.39	74.00	200	35	Peak
2	7311.000	37.69	5.09	42.78	-31.22	74.00	100	10	Peak
3	* 9748.000	38.76	4.73	43.49	-30.51	74.00	120	360	Peak

Note:

1. " *", means this data is the worst emission level.
2. C.F (Correction Factor) = Antenna Factor (dB)+ Cable Loss (dB) – Preamplifier(dB).
3. Measurement (dBuV/m) = Reading(dBuV) + C.F (Correction Factor).
4. The emission levels of other frequencies are very lower than the limit and not show in test report.

EUT	Display	Date of Test	2022-01-05
Factor	DRH18-E & BBHA 9170	Temp. / Humidity	22°C /58%
Polarity	Horizontal	Site / Test Engineer	AC2 / Owen
Test Mode	802.11n-40MHz_TX_CH11_Ant 0+1	Test Voltage	AC 120V/60Hz

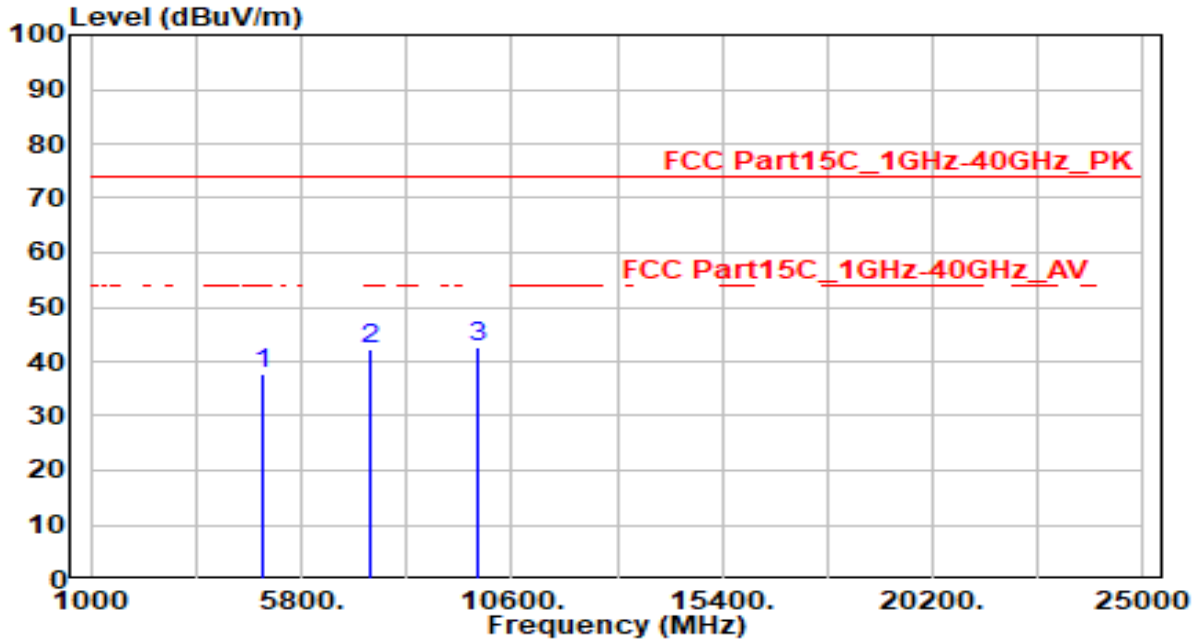

No	Frequency (MHz)	Reading (dBuV)	C.F (dB/m)	Measurement (dBuV/m)	Margin (dB)	Limit (dBuV/m)	Height (cm)	Angle (deg)	Remark (QP/PK/AV)
1	4904.000	37.45	0.15	37.60	-36.40	74.00	200	175	Peak
2	7356.000	37.25	5.13	42.38	-31.62	74.00	100	360	Peak
3	* 9808.000	37.81	4.75	42.56	-31.44	74.00	100	50	Peak

Note:

1. " *", means this data is the worst emission level.
2. C.F (Correction Factor) = Antenna Factor (dB)+ Cable Loss (dB) – Preamplifier(dB).
3. Measurement (dBuV/m) = Reading(dBuV) + C.F (Correction Factor).
4. The emission levels of other frequencies are very lower than the limit and not show in test report.

EUT	Display	Date of Test	2022-01-05
Factor	DRH18-E & BBHA 9170	Temp. / Humidity	22°C /58%
Polarity	Vertical	Site / Test Engineer	AC2 / Owen
Test Mode	802.11n-40MHz_TX_CH11_Ant 0+1	Test Voltage	AC 120V/60Hz

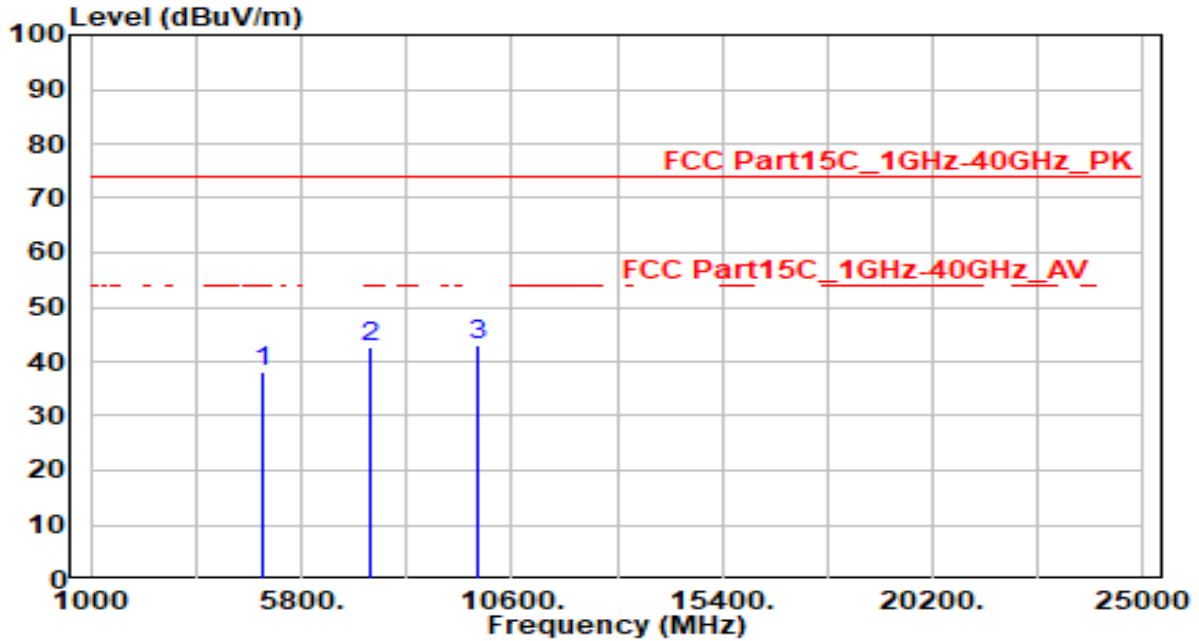

No	Frequency (MHz)	Reading (dBuV)	C.F (dB/m)	Measurement (dBuV/m)	Margin (dB)	Limit (dBuV/m)	Height (cm)	Angle (deg)	Remark (QP/PK/AV)
1	4904.000	37.80	0.15	37.95	-36.05	74.00	100	355	Peak
2	7356.000	37.63	5.13	42.76	-31.24	74.00	200	200	Peak
3	* 9808.000	38.08	4.75	42.83	-31.17	74.00	100	155	Peak

Note:

1. " *", means this data is the worst emission level.
2. C.F (Correction Factor) = Antenna Factor (dB)+ Cable Loss (dB) – Preamplifier(dB).
3. Measurement (dBuV/m) = Reading(dBuV) + C.F (Correction Factor).
4. The emission levels of other frequencies are very lower than the limit and not show in test report.

7.7. Radiated Restricted Band Edge Measurement

7.7.1. Test Limit

All out of band emissions appearing in a restricted band as specified in Section 15.205 of the Title 47 CFR must not exceed the limits shown in Table per Section 15.209.

FCC Part 15 Subpart C Paragraph 15.209		
Frequency [MHz]	Field Strength [V/m]	Measured Distance [Meters]
0.009 - 0.490	2400/F (kHz)	300
0.490 - 1.705	24000/F (kHz)	30
1.705 – 30	30	30
30 – 88	100	3
88 – 216	150	3
216 – 960	200	3
Above 960	500	3

7.7.2. Test Procedure Used

ANSI C63.10-2013 - Section 11.12.1

7.7.3. Test Setting

Peak Field Strength Measurements

1. Analyzer center frequency was set to the frequency of the radiated spurious emission of interest
2. RBW = as specified in Table 1
3. VBW = 3 * RBW
4. Detector = peak
5. Sweep time = auto couple
6. Trace mode = max hold

- Trace was allowed to stabilize

Table 1 - RBW as a function of frequency

Frequency	RBW
9 ~ 150 kHz	200 ~ 300 Hz
0.15 ~ 30 MHz	9 ~ 10 kHz
30 ~ 1000 MHz	100 ~ 120 kHz
> 1000 MHz	1 MHz

Average Field Strength Measurements

- Analyzer center frequency was set to the frequency of the radiated spurious emission of interest
- RBW = 1MHz
- VBW $\geq 1/T$
- De As an alternative, the instrument may be set to linear detector mode. Ensure that video filtering is applied in linear voltage domain (rather than in a log or dB domain). Some instruments require linear display mode in order to accomplish this. Others have a setting for Average-VBW Type, which can be set to "Voltage" regardless of the display mode
- Detector = Peak
- Sweep time = auto
- Trace mode = max hold
- Allow max hold to run for at least 50 times (1/duty cycle) traces

7.7.4. Test Setup

1GHz ~ 18GHz Test Setup:

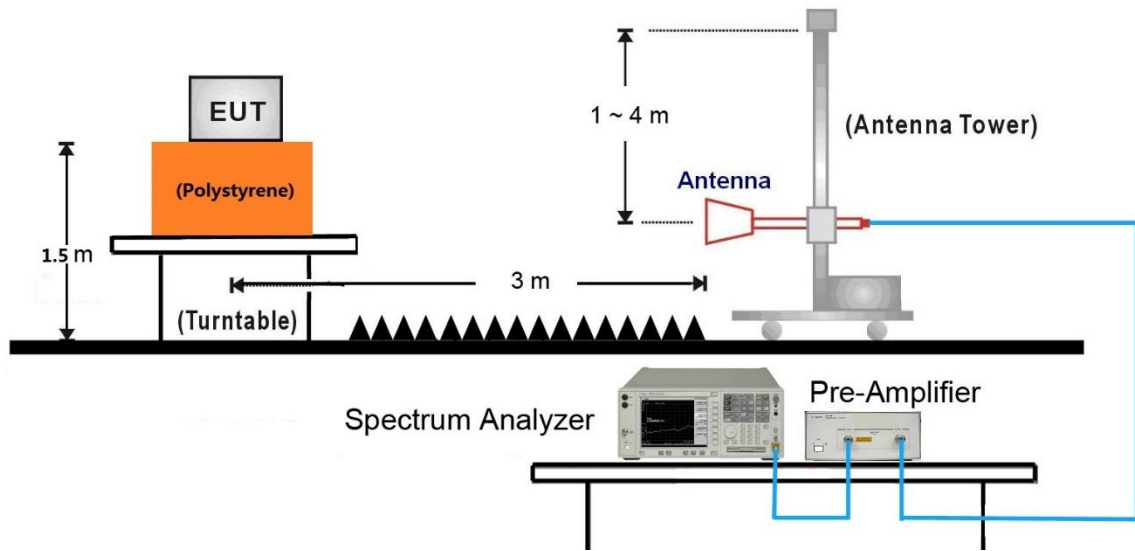

7.7.5. Test Result

EUT	Display	Date of Test	2022-01-05
Factor	DRH18-E	Temp. / Humidity	22°C /58%
Polarity	Horizontal	Site / Test Engineer	AC2 / Owen
Test Mode	802.11b_TX_CH1_Ant 0+1	Test Voltage	AC 120V/60Hz

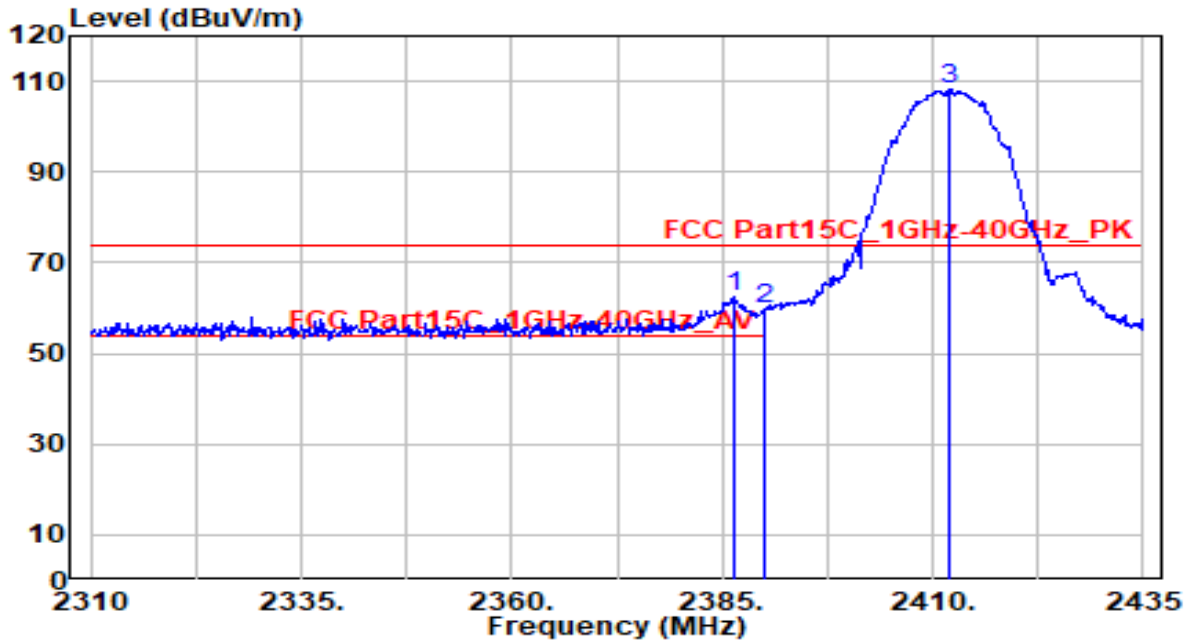

No	Frequency (MHz)	Reading (dBUV)	C.F (dB/m)	Measurement (dBUV/m)	Margin (dB)	Limit (dBUV/m)	Height (cm)	Angle (deg)	Remark (QP/PK/AV)
1	* 2386.375	31.81	30.80	62.61	-11.39	74.00	185	295	Peak
2	2390.000	29.15	30.80	59.95	-14.05	74.00	185	295	Peak
3	2412.000	77.37	30.85	108.23	N/A	N/A	185	295	Peak

Note:

1. " *", means this data is the worst emission level.
2. C.F (Correction Factor) = Antenna Factor (dB)+ Cable Loss (dB).
3. Measurement (dBUV/m) = Reading(dBUV) + C.F (Correction Factor).
4. The emission levels of other frequencies are very lower than the limit and not show in test report.

EUT	Display	Date of Test	2022-01-05
Factor	DRH18-E	Temp. / Humidity	22°C /58%
Polarity	Horizontal	Site / Test Engineer	AC2 / Owen
Test Mode	802.11b_TX_CH1_Ant 0+1	Test Voltage	AC 120V/60Hz

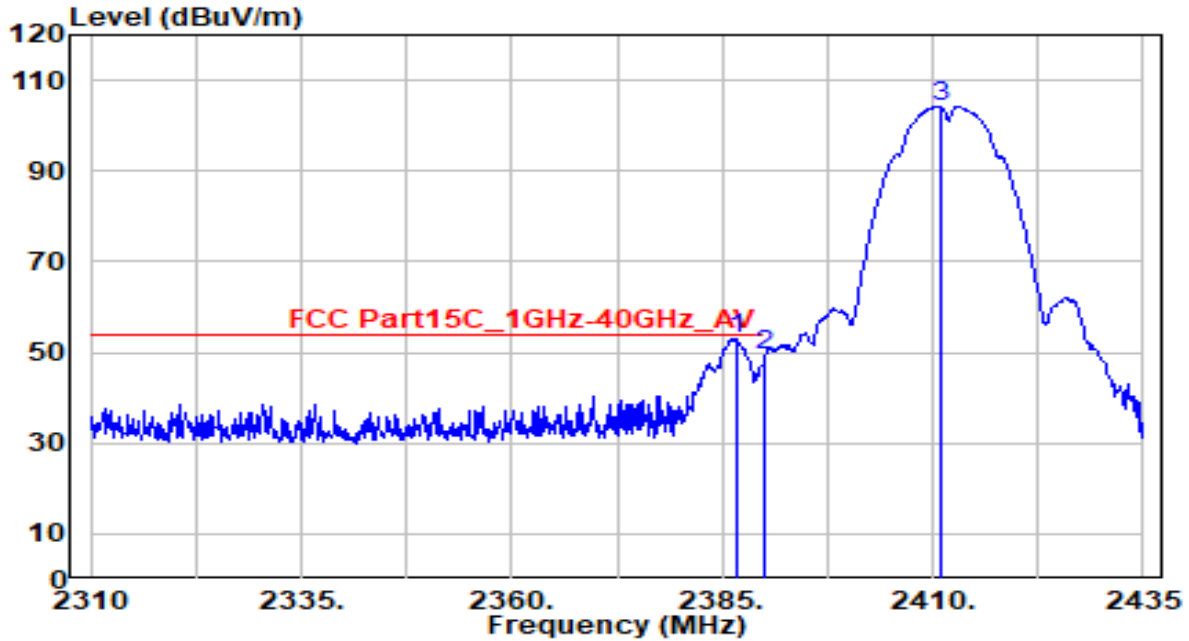

No	Frequency (MHz)	Reading (dBuV)	C.F (dB/m)	Measurement (dBuV/m)	Margin (dB)	Limit (dBuV/m)	Height (cm)	Angle (deg)	Remark (QP/PK/AV)
1	* 2386.625	22.12	30.80	52.92	-1.08	54.00	185	295	Average
2	2390.000	18.66	30.80	49.46	-4.54	54.00	185	295	Average
3	2410.875	73.45	30.85	104.30	N/A	N/A	185	295	Average

Note:

1. " *", means this data is the worst emission level.
2. C.F (Correction Factor) = Antenna Factor (dB)+ Cable Loss (dB).
3. Measurement (dBuV/m) = Reading(dBuV) + C.F (Correction Factor).
4. The emission levels of other frequencies are very lower than the limit and not show in test report.

EUT	Display	Date of Test	2022-01-05
Factor	DRH18-E	Temp. / Humidity	22°C /58%
Polarity	Vertical	Site / Test Engineer	AC2 / Owen
Test Mode	802.11b_TX_CH1_Ant 0+1	Test Voltage	AC 120V/60Hz

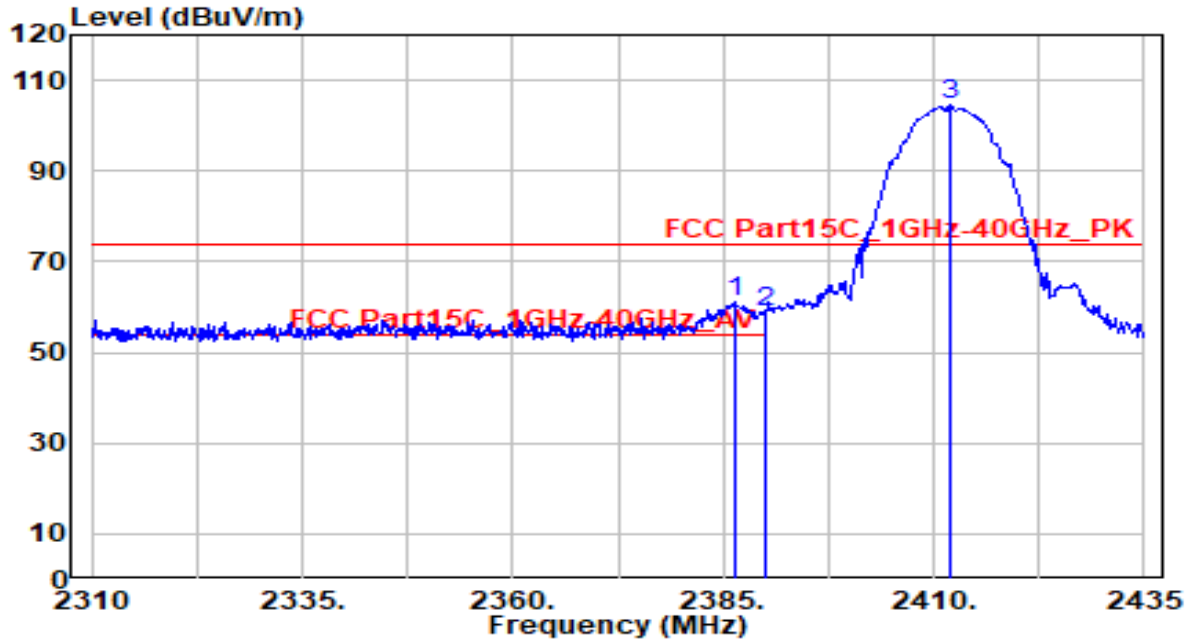

No	Frequency (MHz)	Reading (dBuV)	C.F (dB/m)	Measurement (dBuV/m)	Margin (dB)	Limit (dBuV/m)	Height (cm)	Angle (deg)	Remark (QP/PK/AV)
1	* 2386.500	30.21	30.80	61.01	-12.99	74.00	165	350	Peak
2	2390.000	28.23	30.80	59.03	-14.97	74.00	165	350	Peak
3	2412.000	73.57	30.85	104.42	N/A	N/A	165	350	Peak

Note:

1. " *", means this data is the worst emission level.
2. C.F (Correction Factor) = Antenna Factor (dB)+ Cable Loss (dB).
3. Measurement (dBuV/m) = Reading(dBuV) + C.F (Correction Factor).
4. The emission levels of other frequencies are very lower than the limit and not show in test report.

EUT	Display	Date of Test	2022-01-05
Factor	DRH18-E	Temp. / Humidity	22°C /58%
Polarity	Vertical	Site / Test Engineer	AC2 / Owen
Test Mode	802.11b_TX_CH1_Ant 0+1	Test Voltage	AC 120V/60Hz

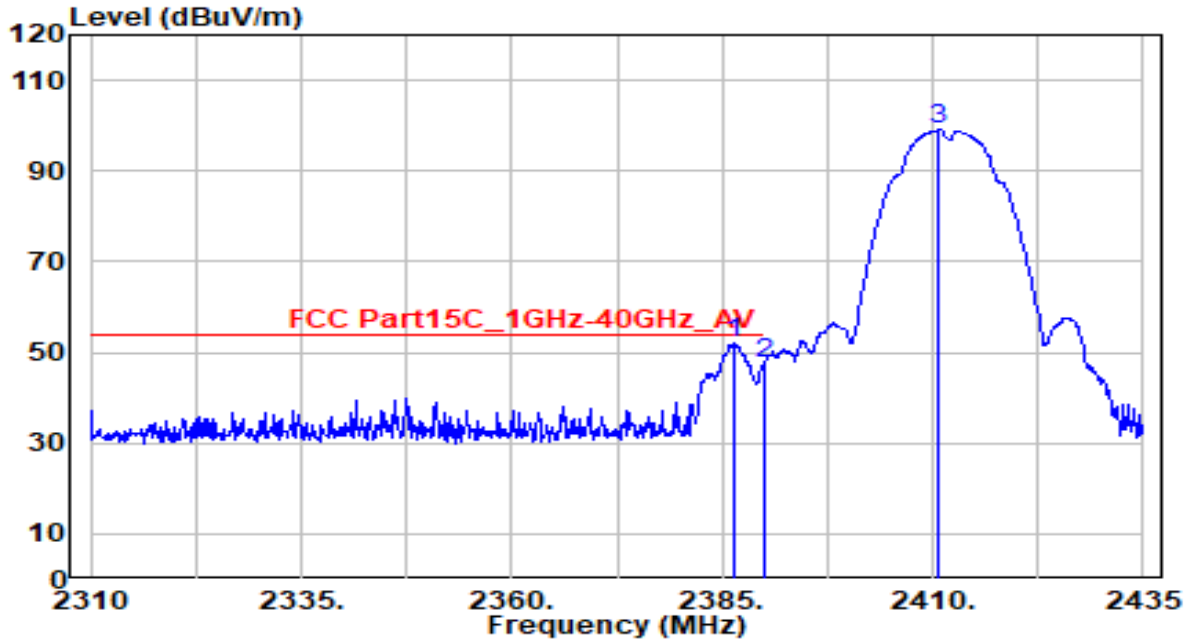

No	Frequency (MHz)	Reading (dBuV)	C.F (dB/m)	Measurement (dBuV/m)	Margin (dB)	Limit (dBuV/m)	Height (cm)	Angle (deg)	Remark (QP/PK/AV)
1	* 2386.375	21.19	30.80	51.98	-2.02	54.00	165	350	Average
2	2390.000	16.87	30.80	47.68	-6.32	54.00	165	350	Average
3	2410.750	68.21	30.85	99.06	N/A	N/A	165	350	Average

Note:

1. " *", means this data is the worst emission level.
2. C.F (Correction Factor) = Antenna Factor (dB)+ Cable Loss (dB).
3. Measurement (dBuV/m) = Reading(dBuV) + C.F (Correction Factor).
4. The emission levels of other frequencies are very lower than the limit and not show in test report.

EUT	Display	Date of Test	2022-01-05
Factor	DRH18-E	Temp. / Humidity	22°C /58%
Polarity	Horizontal	Site / Test Engineer	AC2 / Owen
Test Mode	802.11b_TX_CH11_Ant 0+1	Test Voltage	AC 120V/60Hz

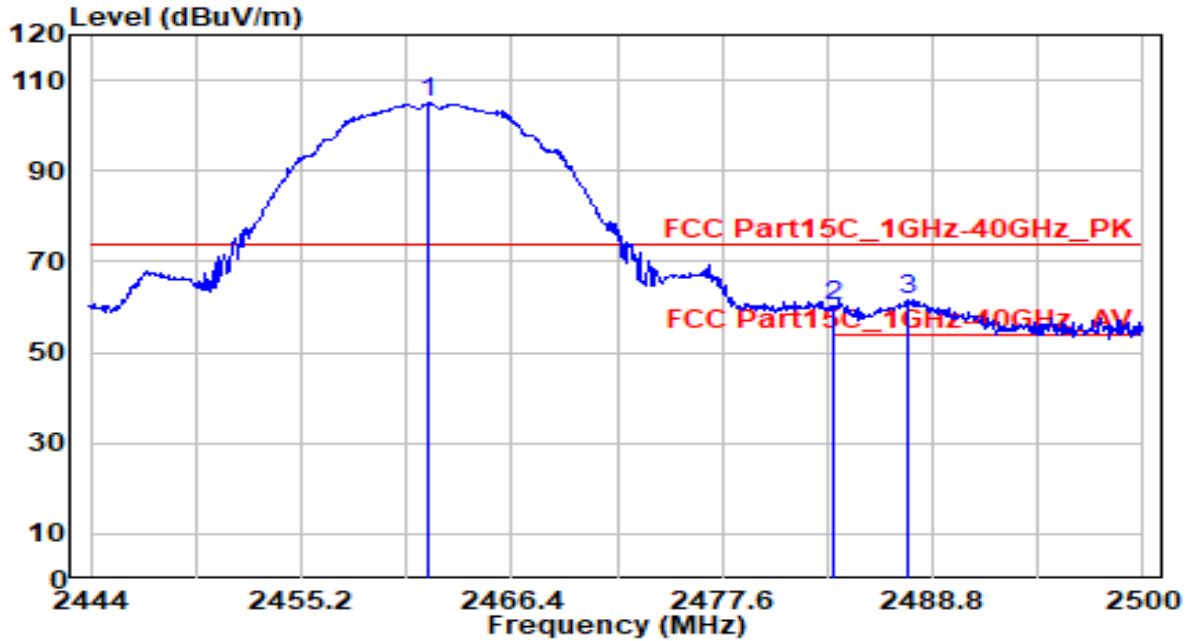

No	Frequency (MHz)	Reading (dBuV)	C.F (dB/m)	Measurement (dBuV/m)	Margin (dB)	Limit (dBuV/m)	Height (cm)	Angle (deg)	Remark (QP/PK/AV)
1	2462.020	74.02	30.95	104.97	N/A	N/A	175	295	Peak
2	2483.500	29.43	30.99	60.41	-13.59	74.00	175	295	Peak
3	* 2487.460	30.47	31.00	61.47	-12.53	74.00	175	295	Peak

Note:

1. " *", means this data is the worst emission level.
2. C.F (Correction Factor) = Antenna Factor (dB)+ Cable Loss (dB).
3. Measurement (dBuV/m) = Reading(dBuV) + C.F (Correction Factor).
4. The emission levels of other frequencies are very lower than the limit and not show in test report.

EUT	Display	Date of Test	2022-01-05
Factor	DRH18-E	Temp. / Humidity	22°C /58%
Polarity	Horizontal	Site / Test Engineer	AC2 / Owen
Test Mode	802.11b_TX_CH11_Ant 0+1	Test Voltage	AC 120V/60Hz

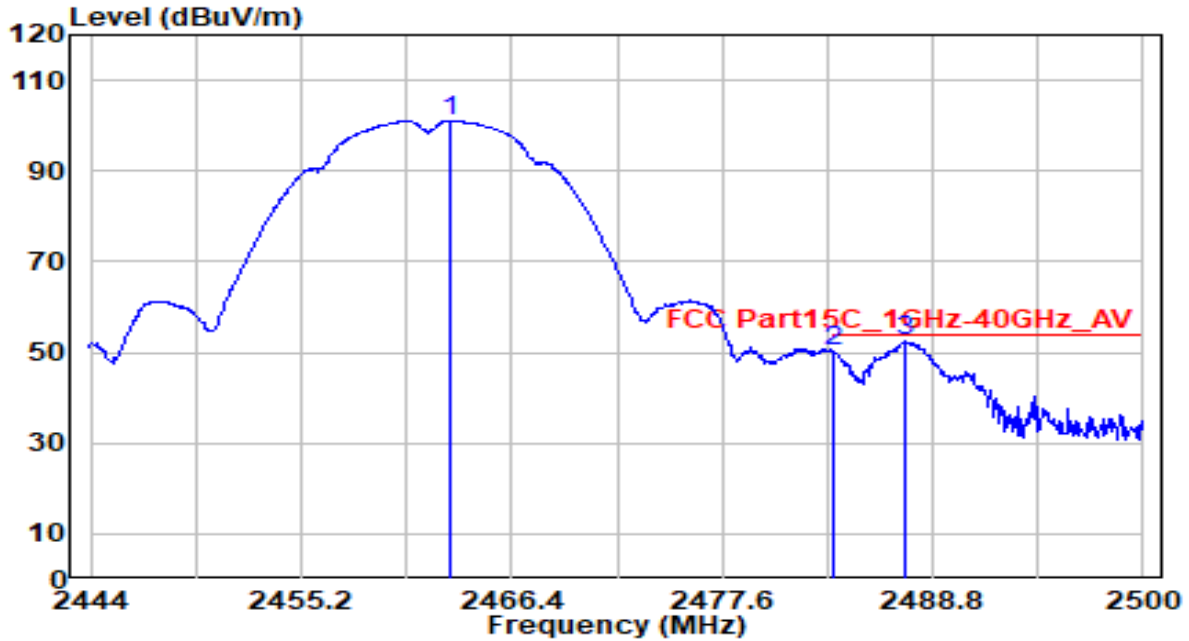

No	Frequency (MHz)	Reading (dBuV)	C.F (dB/m)	Measurement (dBuV/m)	Margin (dB)	Limit (dBuV/m)	Height (cm)	Angle (deg)	Remark (QP/PK/AV)
1	2463.100	70.18	30.95	101.13	N/A	N/A	175	295	Average
2	2483.500	19.06	30.99	50.05	-3.95	54.00	175	295	Average
3	* 2487.400	21.38	31.00	52.37	-1.63	54.00	175	295	Average

Note:

1. " *", means this data is the worst emission level.
2. C.F (Correction Factor) = Antenna Factor (dB)+ Cable Loss (dB).
3. Measurement (dBuV/m) = Reading(dBuV) + C.F (Correction Factor).
4. The emission levels of other frequencies are very lower than the limit and not show in test report.

EUT	Display	Date of Test	2022-01-05
Factor	DRH18-E	Temp. / Humidity	22°C /58%
Polarity	Vertical	Site / Test Engineer	AC2 / Owen
Test Mode	802.11b_TX_CH11_Ant 0+1	Test Voltage	AC 120V/60Hz

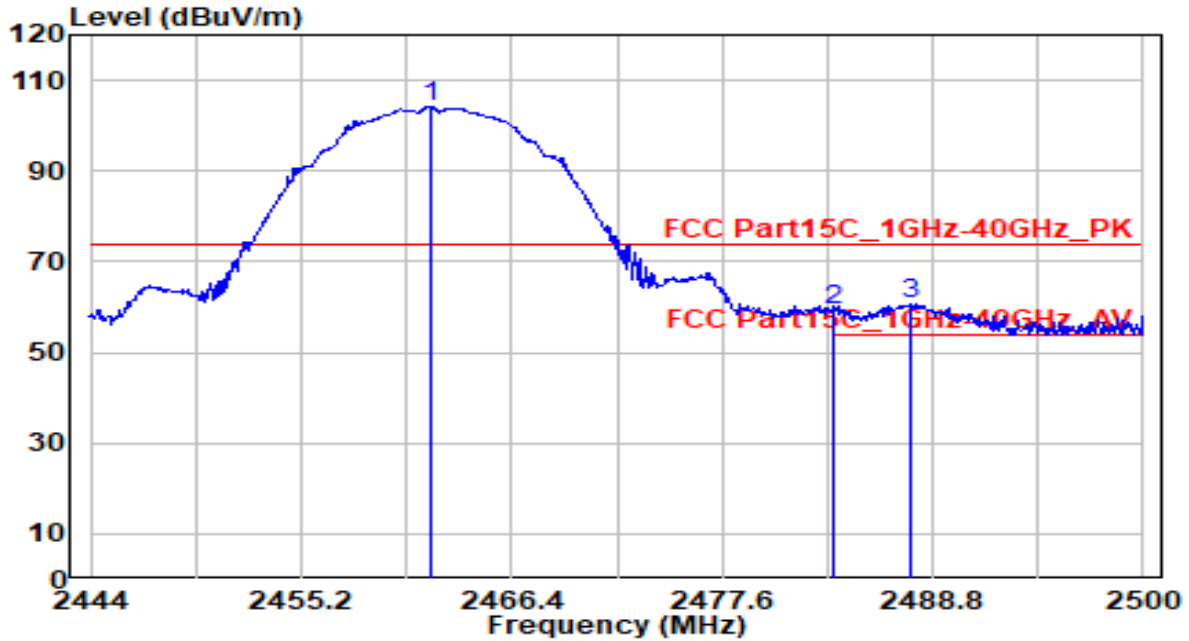

No	Frequency (MHz)	Reading (dBuV)	C.F (dB/m)	Measurement (dBuV/m)	Margin (dB)	Limit (dBuV/m)	Height (cm)	Angle (deg)	Remark (QP/PK/AV)
1	2462.080	73.16	30.95	104.11	N/A	N/A	205	0	Peak
2	2483.500	28.24	30.99	59.23	-14.77	74.00	205	0	Peak
3	* 2487.580	29.88	31.00	60.87	-13.13	74.00	205	0	Peak

Note:

1. " *", means this data is the worst emission level.
2. C.F (Correction Factor) = Antenna Factor (dB)+ Cable Loss (dB).
3. Measurement (dBuV/m) = Reading(dBuV) + C.F (Correction Factor).
4. The emission levels of other frequencies are very lower than the limit and not show in test report.

EUT	Display	Date of Test	2022-01-05
Factor	DRH18-E	Temp. / Humidity	22°C /58%
Polarity	Vertical	Site / Test Engineer	AC2 / Owen
Test Mode	802.11b_TX_CH11_Ant 0+1	Test Voltage	AC 120V/60Hz

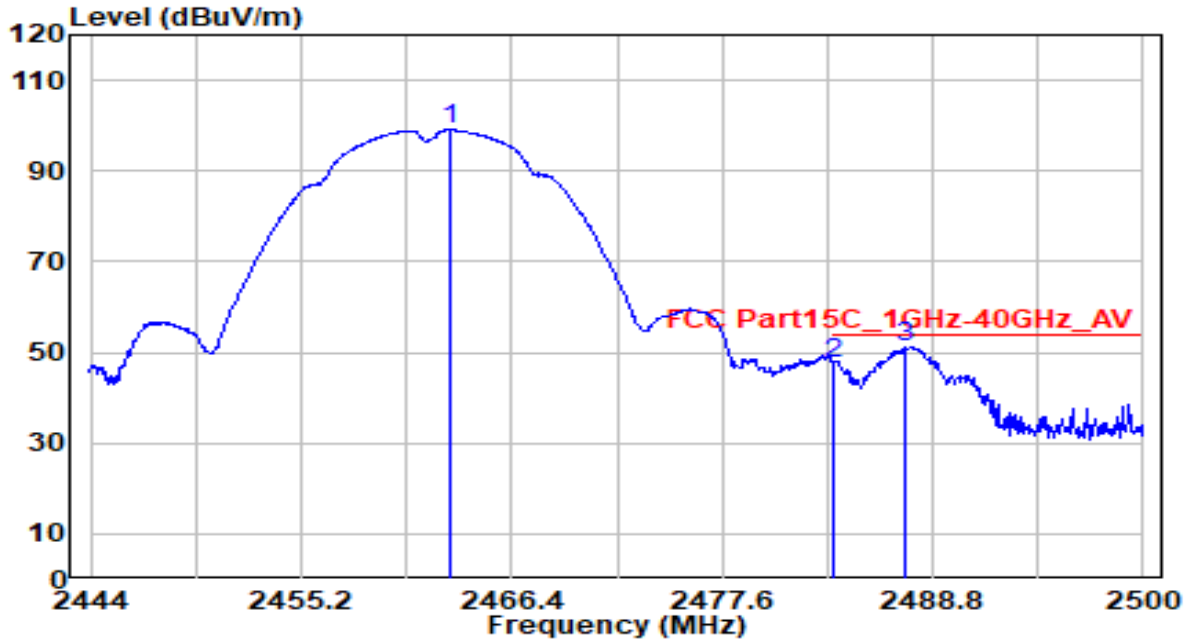

No	Frequency (MHz)	Reading (dBuV)	C.F (dB/m)	Measurement (dBuV/m)	Margin (dB)	Limit (dBuV/m)	Height (cm)	Angle (deg)	Remark (QP/PK/AV)
1	2463.100	68.09	30.95	99.04	N/A	N/A	205	0	Average
2	2483.500	16.55	30.99	47.54	-6.46	54.00	205	0	Average
3	* 2487.400	20.38	31.00	51.37	-2.63	54.00	205	0	Average

Note:

1. " *", means this data is the worst emission level.
2. C.F (Correction Factor) = Antenna Factor (dB)+ Cable Loss (dB).
3. Measurement (dBuV/m) = Reading(dBuV) + C.F (Correction Factor).
4. The emission levels of other frequencies are very lower than the limit and not show in test report.

EUT	Display	Date of Test	2022-01-05
Factor	DRH18-E	Temp. / Humidity	22°C /58%
Polarity	Horizontal	Site / Test Engineer	AC2 / Owen
Test Mode	802.11g_TX_CH1_Ant 0+1	Test Voltage	AC 120V/60Hz

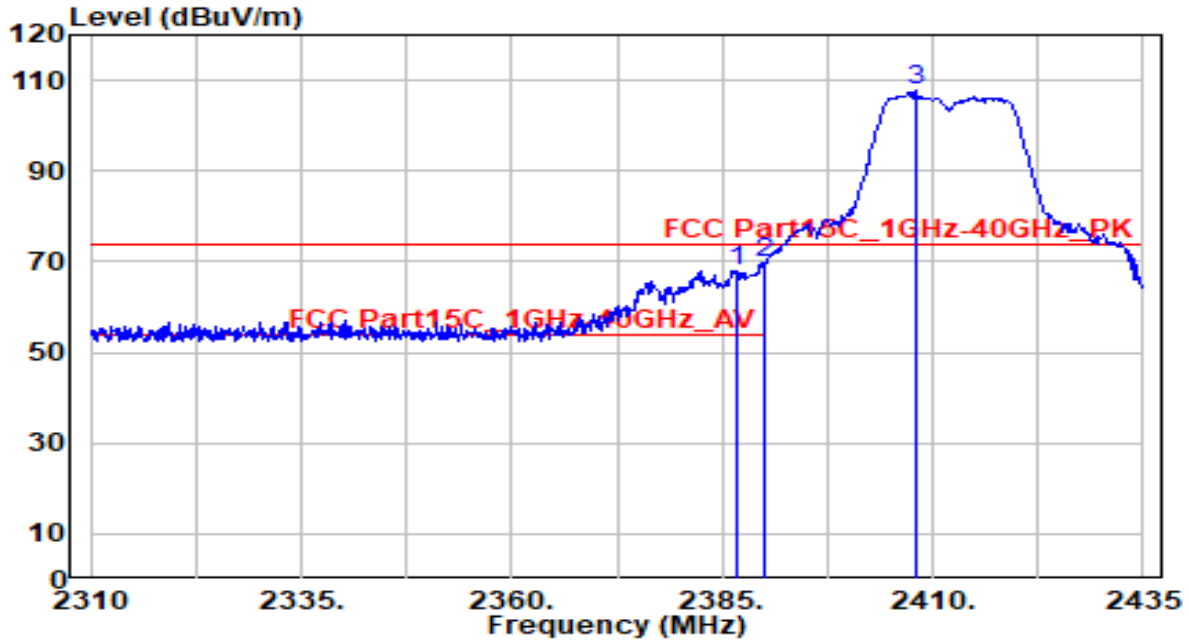

No	Frequency (MHz)	Reading (dBuV)	C.F (dB/m)	Measurement (dBuV/m)	Margin (dB)	Limit (dBuV/m)	Height (cm)	Angle (deg)	Remark (QP/PK/AV)
1	2386.625	37.28	30.80	68.08	-5.92	74.00	180	295	Peak
2	* 2390.000	38.92	30.80	69.72	-4.28	74.00	180	295	Peak
3	2408.000	76.78	30.84	107.62	N/A	N/A	180	295	Peak

Note:

1. " *", means this data is the worst emission level.
2. C.F (Correction Factor) = Antenna Factor (dB)+ Cable Loss (dB).
3. Measurement (dBuV/m) = Reading(dBuV) + C.F (Correction Factor).
4. The emission levels of other frequencies are very lower than the limit and not show in test report.

EUT	Display	Date of Test	2022-01-05
Factor	DRH18-E	Temp. / Humidity	22°C /58%
Polarity	Horizontal	Site / Test Engineer	AC2 / Owen
Test Mode	802.11g_TX_CH1_Ant 0+1	Test Voltage	AC 120V/60Hz

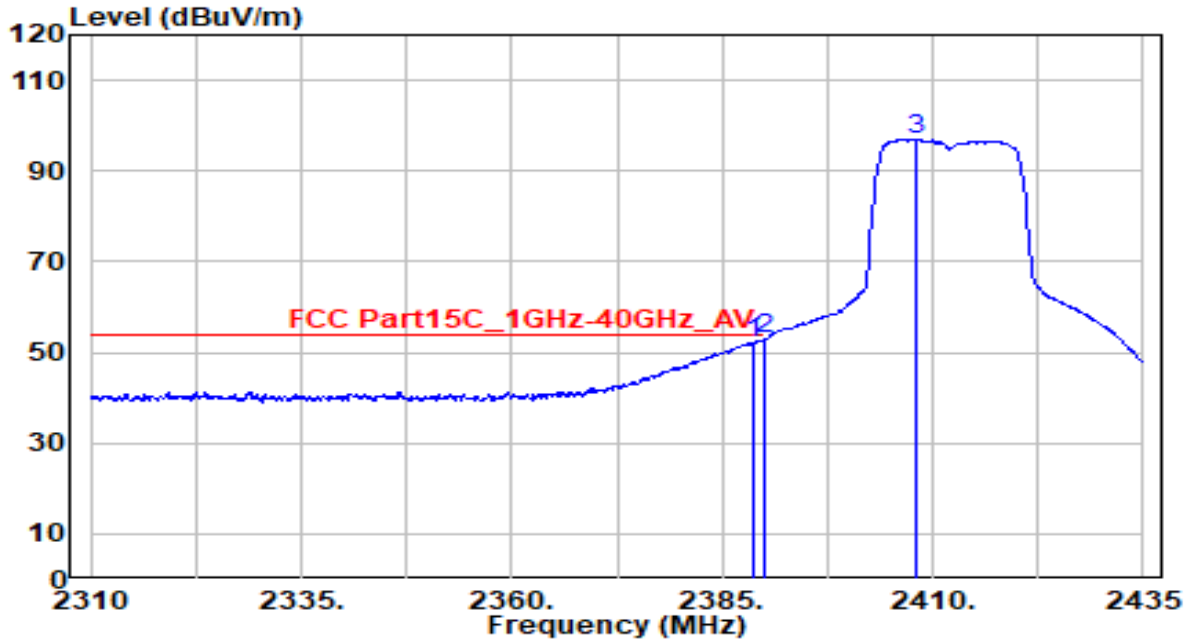

No	Frequency (MHz)	Reading (dBuV)	C.F (dB/m)	Measurement (dBuV/m)	Margin (dB)	Limit (dBuV/m)	Height (cm)	Angle (deg)	Remark (QP/PK/AV)
1	2388.750	21.44	30.80	52.24	-1.76	54.00	180	295	Average
2	* 2390.000	22.06	30.80	52.87	-1.13	54.00	180	295	Average
3	2408.125	66.19	30.84	97.03	N/A	N/A	180	295	Average

Note:

1. " *", means this data is the worst emission level.
2. C.F (Correction Factor) = Antenna Factor (dB)+ Cable Loss (dB).
3. Measurement (dBuV/m) = Reading(dBuV) + C.F (Correction Factor).
4. The emission levels of other frequencies are very lower than the limit and not show in test report.

EUT	Display	Date of Test	2022-01-05
Factor	DRH18-E	Temp. / Humidity	22°C /58%
Polarity	Vertical	Site / Test Engineer	AC2 / Owen
Test Mode	802.11g_TX_CH1_Ant 0+1	Test Voltage	AC 120V/60Hz

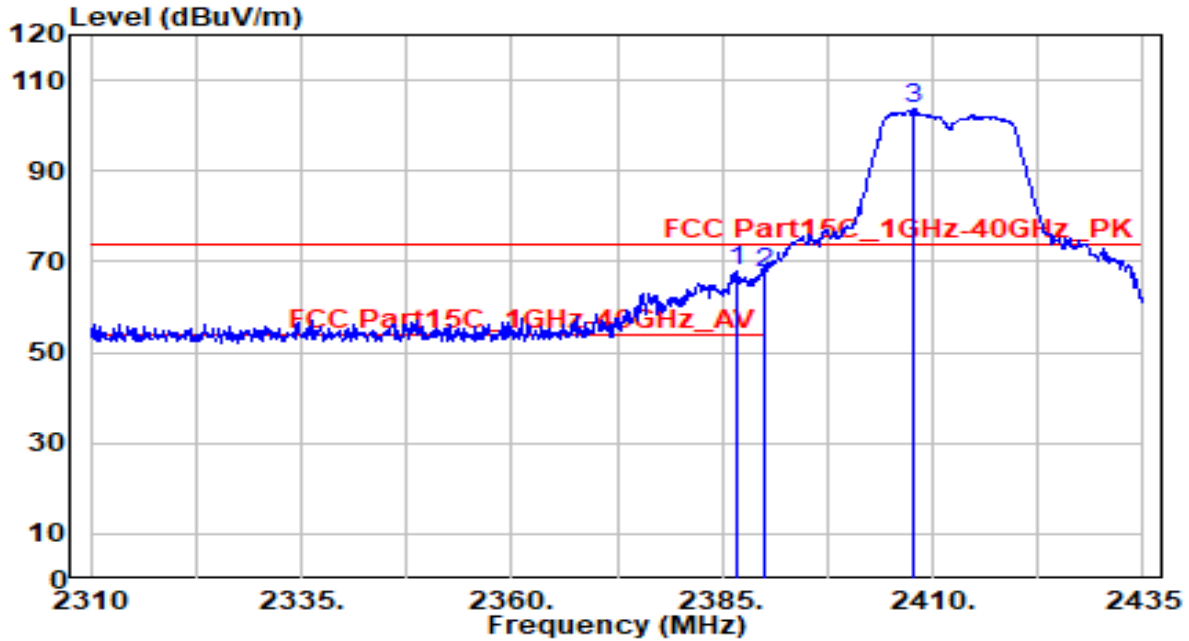

No	Frequency (MHz)	Reading (dBuV)	C.F (dB/m)	Measurement (dBuV/m)	Margin (dB)	Limit (dBuV/m)	Height (cm)	Angle (deg)	Remark (QP/PK/AV)	
1	*	2386.875	37.33	30.80	68.13	-5.87	74.00	255	10	Peak
2		2390.000	36.75	30.80	67.56	-6.44	74.00	255	10	Peak
3		2407.750	72.89	30.84	103.73	N/A	N/A	255	10	Peak

Note:

1. " *", means this data is the worst emission level.
2. C.F (Correction Factor) = Antenna Factor (dB)+ Cable Loss (dB).
3. Measurement (dBuV/m) = Reading(dBuV) + C.F (Correction Factor).
4. The emission levels of other frequencies are very lower than the limit and not show in test report.

EUT	Display	Date of Test	2022-01-05
Factor	DRH18-E	Temp. / Humidity	22°C /58%
Polarity	Vertical	Site / Test Engineer	AC2 / Owen
Test Mode	802.11g_TX_CH1_Ant 0+1	Test Voltage	AC 120V/60Hz

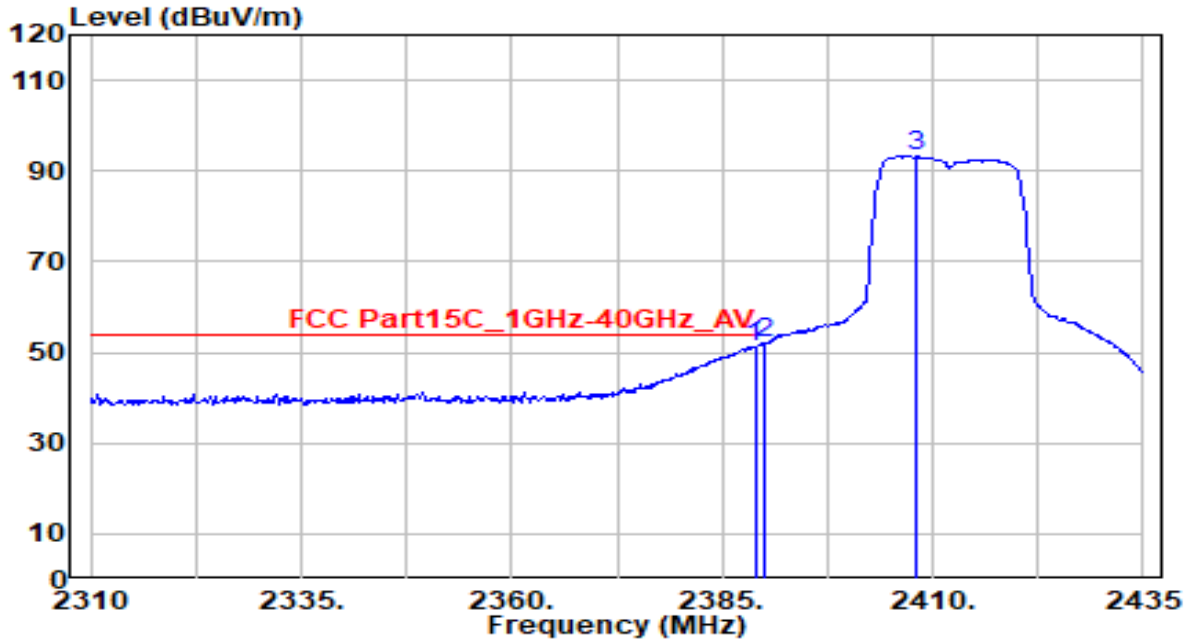

No	Frequency (MHz)	Reading (dBuV)	C.F (dB/m)	Measurement (dBuV/m)	Margin (dB)	Limit (dBuV/m)	Height (cm)	Angle (deg)	Remark (QP/PK/AV)
1	2388.875	20.54	30.80	51.34	-2.66	54.00	255	10	Average
2	* 2390.000	21.14	30.80	51.95	-2.05	54.00	255	10	Average
3	2408.000	62.47	30.84	93.32	N/A	N/A	255	10	Average

Note:

1. " *", means this data is the worst emission level.
2. C.F (Correction Factor) = Antenna Factor (dB)+ Cable Loss (dB).
3. Measurement (dBuV/m) = Reading(dBuV) + C.F (Correction Factor).
4. The emission levels of other frequencies are very lower than the limit and not show in test report.

EUT	Display	Date of Test	2022-01-05
Factor	DRH18-E	Temp. / Humidity	22°C /58%
Polarity	Horizontal	Site / Test Engineer	AC2 / Owen
Test Mode	802.11g_TX_CH11_Ant 0+1	Test Voltage	AC 120V/60Hz

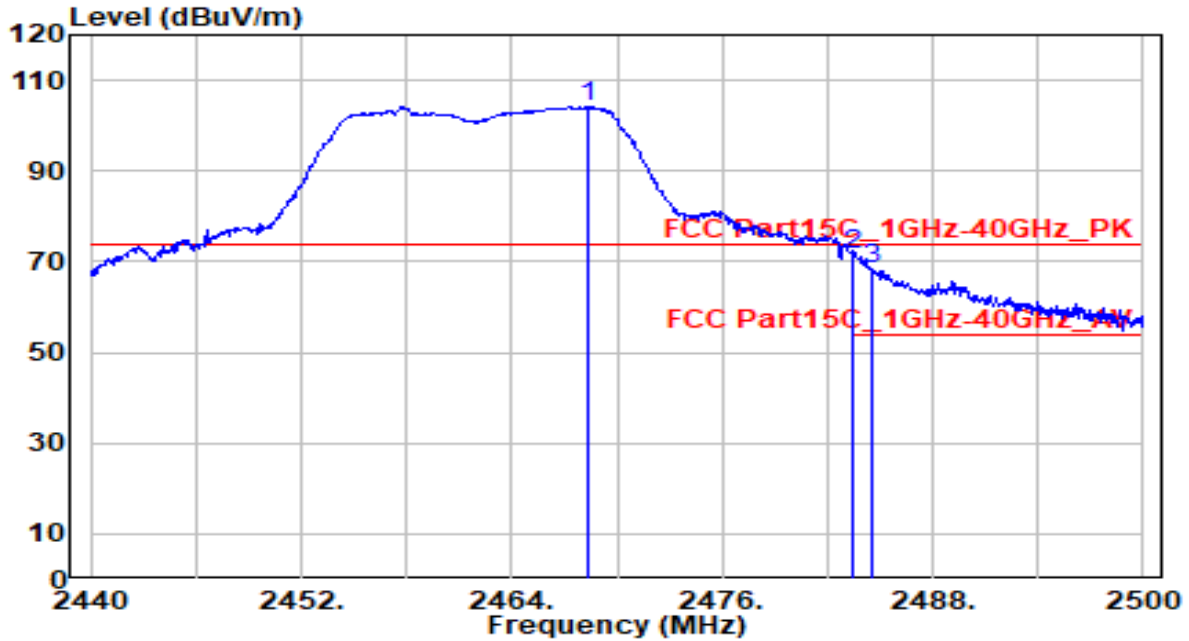

No	Frequency (MHz)	Reading (dBuV)	C.F (dB/m)	Measurement (dBuV/m)	Margin (dB)	Limit (dBuV/m)	Height (cm)	Angle (deg)	Remark (QP/PK/AV)
1	2468.320	73.11	30.96	104.07	N/A	N/A	180	300	Peak
2	* 2483.500	40.58	30.99	71.57	-2.43	74.00	180	300	Peak
3	2484.580	37.31	30.99	68.30	-5.70	74.00	180	300	Peak

Note:

1. " *", means this data is the worst emission level.
2. C.F (Correction Factor) = Antenna Factor (dB)+ Cable Loss (dB).
3. Measurement (dBuV/m) = Reading(dBuV) + C.F (Correction Factor).
4. The emission levels of other frequencies are very lower than the limit and not show in test report.

EUT	Display	Date of Test	2022-01-05
Factor	DRH18-E	Temp. / Humidity	22°C /58%
Polarity	Horizontal	Site / Test Engineer	AC2 / Owen
Test Mode	802.11g_TX_CH11_Ant 0+1	Test Voltage	AC 120V/60Hz

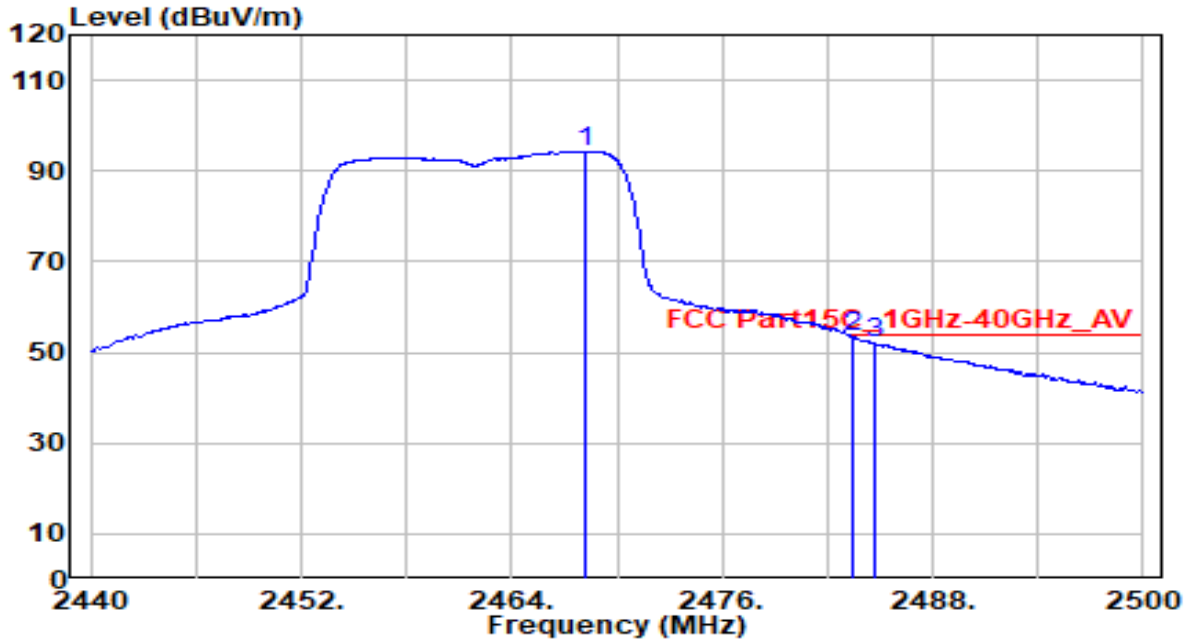

No	Frequency (MHz)	Reading (dBuV)	C.F (dB/m)	Measurement (dBuV/m)	Margin (dB)	Limit (dBuV/m)	Height (cm)	Angle (deg)	Remark (QP/PK/AV)
1	2468.260	63.46	30.96	94.41	N/A	N/A	180	300	Average
2	* 2483.500	22.24	30.99	53.23	-0.77	54.00	180	300	Average
3	2484.640	20.99	30.99	51.98	-2.02	54.00	180	300	Average

Note:

1. " *", means this data is the worst emission level.
2. C.F (Correction Factor) = Antenna Factor (dB)+ Cable Loss (dB).
3. Measurement (dBuV/m) = Reading(dBuV) + C.F (Correction Factor).
4. The emission levels of other frequencies are very lower than the limit and not show in test report.

EUT	Display	Date of Test	2022-01-05
Factor	DRH18-E	Temp. / Humidity	22°C /58%
Polarity	Vertical	Site / Test Engineer	AC2 / Owen
Test Mode	802.11g_TX_CH11_Ant 0+1	Test Voltage	AC 120V/60Hz

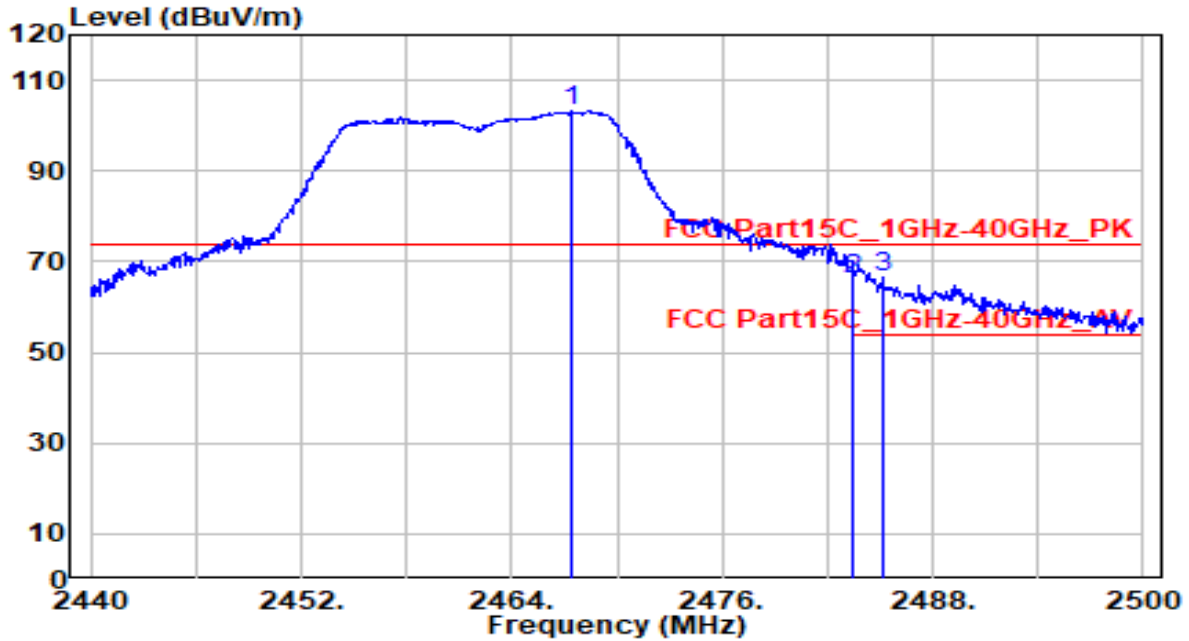

No	Frequency (MHz)	Reading (dBuV)	C.F (dB/m)	Measurement (dBuV/m)	Margin (dB)	Limit (dBuV/m)	Height (cm)	Angle (deg)	Remark (QP/PK/AV)
1	2467.420	72.10	30.96	103.06	N/A	N/A	240	0	Peak
2	2483.500	35.15	30.99	66.13	-7.87	74.00	240	0	Peak
3	* 2485.120	35.56	30.99	66.56	-7.44	74.00	240	0	Peak

Note:

1. " *", means this data is the worst emission level.
2. C.F (Correction Factor) = Antenna Factor (dB)+ Cable Loss (dB).
3. Measurement (dBuV/m) = Reading(dBuV) + C.F (Correction Factor).
4. The emission levels of other frequencies are very lower than the limit and not show in test report.

EUT	Display	Date of Test	2022-01-05
Factor	DRH18-E	Temp. / Humidity	22°C /58%
Polarity	Vertical	Site / Test Engineer	AC2 / Owen
Test Mode	802.11g_TX_CH11_Ant 0+1	Test Voltage	AC 120V/60Hz

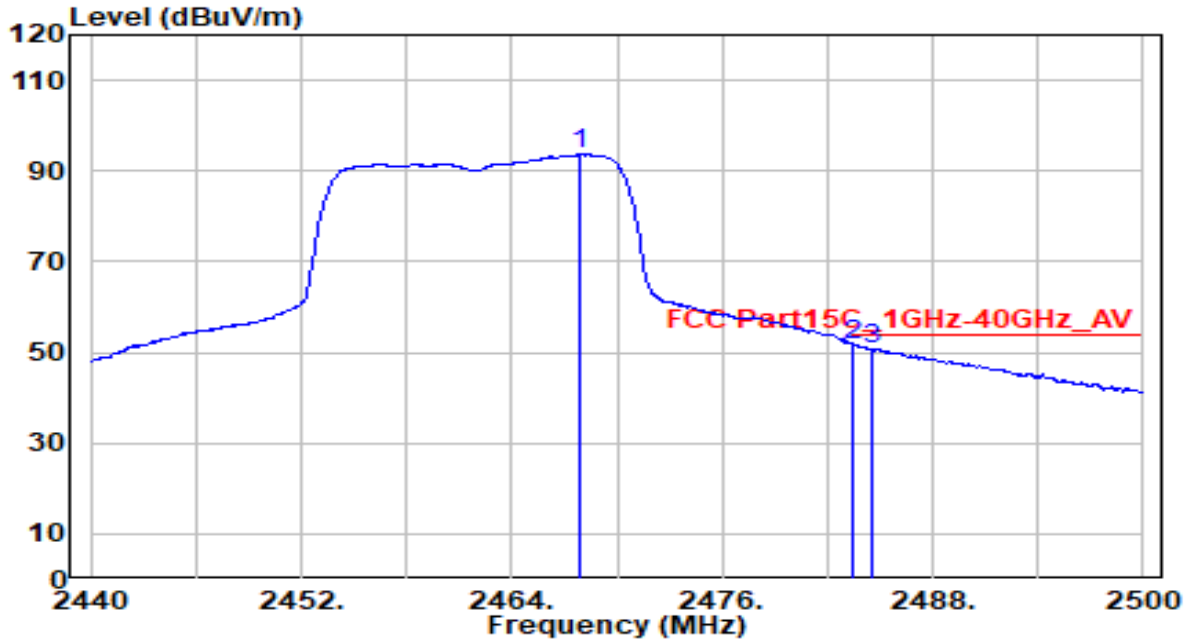

No	Frequency (MHz)	Reading (dBuV)	C.F (dB/m)	Measurement (dBuV/m)	Margin (dB)	Limit (dBuV/m)	Height (cm)	Angle (deg)	Remark (QP/PK/AV)
1	2467.900	62.66	30.96	93.62	N/A	N/A	240	0	Average
2	* 2483.500	20.78	30.99	51.77	-2.23	54.00	240	0	Average
3	2484.580	19.64	30.99	50.63	-3.37	54.00	240	0	Average

Note:

1. " *", means this data is the worst emission level.
2. C.F (Correction Factor) = Antenna Factor (dB)+ Cable Loss (dB).
3. Measurement (dBuV/m) = Reading(dBuV) + C.F (Correction Factor).
4. The emission levels of other frequencies are very lower than the limit and not show in test report.

EUT	Display	Date of Test	2022-01-05
Factor	DRH18-E	Temp. / Humidity	22°C /58%
Polarity	Horizontal	Site / Test Engineer	AC2 / Owen
Test Mode	802.11n-20MHz_TX_CH1_Ant 0+1	Test Voltage	AC 120V/60Hz

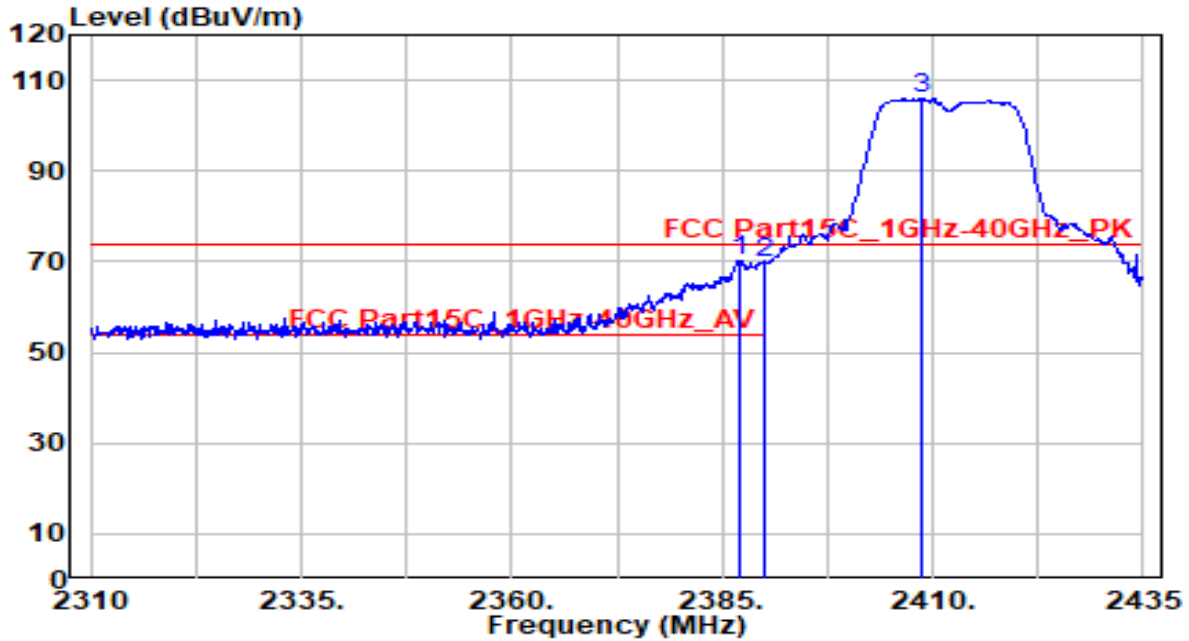

No	Frequency (MHz)	Reading (dBuV)	C.F (dB/m)	Measurement (dBuV/m)	Margin (dB)	Limit (dBuV/m)	Height (cm)	Angle (deg)	Remark (QP/PK/AV)
1	* 2387.125	39.24	30.80	70.04	-3.96	74.00	175	295	Peak
2	2390.000	39.04	30.80	69.84	-4.16	74.00	175	295	Peak
3	2408.750	75.16	30.84	106.00	N/A	N/A	175	295	Peak

Note:

1. " *", means this data is the worst emission level.
2. C.F (Correction Factor) = Antenna Factor (dB)+ Cable Loss (dB).
3. Measurement (dBuV/m) = Reading(dBuV) + C.F (Correction Factor).
4. The emission levels of other frequencies are very lower than the limit and not show in test report.

EUT	Display	Date of Test	2022-01-05
Factor	DRH18-E	Temp. / Humidity	22°C /58%
Polarity	Horizontal	Site / Test Engineer	AC2 / Owen
Test Mode	802.11n-20MHz_TX_CH1_Ant 0+1	Test Voltage	AC 120V/60Hz

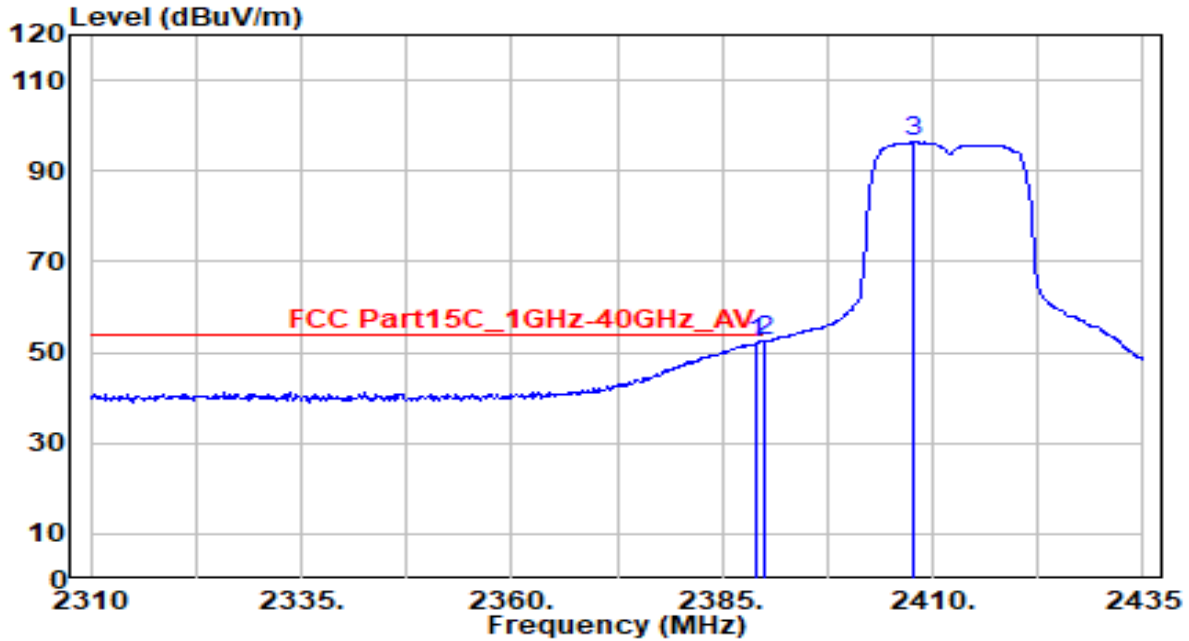

No	Frequency (MHz)	Reading (dBuV)	C.F (dB/m)	Measurement (dBuV/m)	Margin (dB)	Limit (dBuV/m)	Height (cm)	Angle (deg)	Remark (QP/PK/AV)
1	2389.000	21.05	30.80	51.85	-2.15	54.00	175	295	Average
2	* 2390.000	21.75	30.80	52.56	-1.44	54.00	175	295	Average
3	2407.625	65.57	30.84	96.41	N/A	N/A	175	295	Average

Note:

1. " *", means this data is the worst emission level.
2. C.F (Correction Factor) = Antenna Factor (dB)+ Cable Loss (dB).
3. Measurement (dBuV/m) = Reading(dBuV) + C.F (Correction Factor).
4. The emission levels of other frequencies are very lower than the limit and not show in test report.

EUT	Display	Date of Test	2022-01-05
Factor	DRH18-E	Temp. / Humidity	22°C /58%
Polarity	Vertical	Site / Test Engineer	AC2 / Owen
Test Mode	802.11n-20MHz_TX_CH1_Ant 0+1	Test Voltage	AC 120V/60Hz

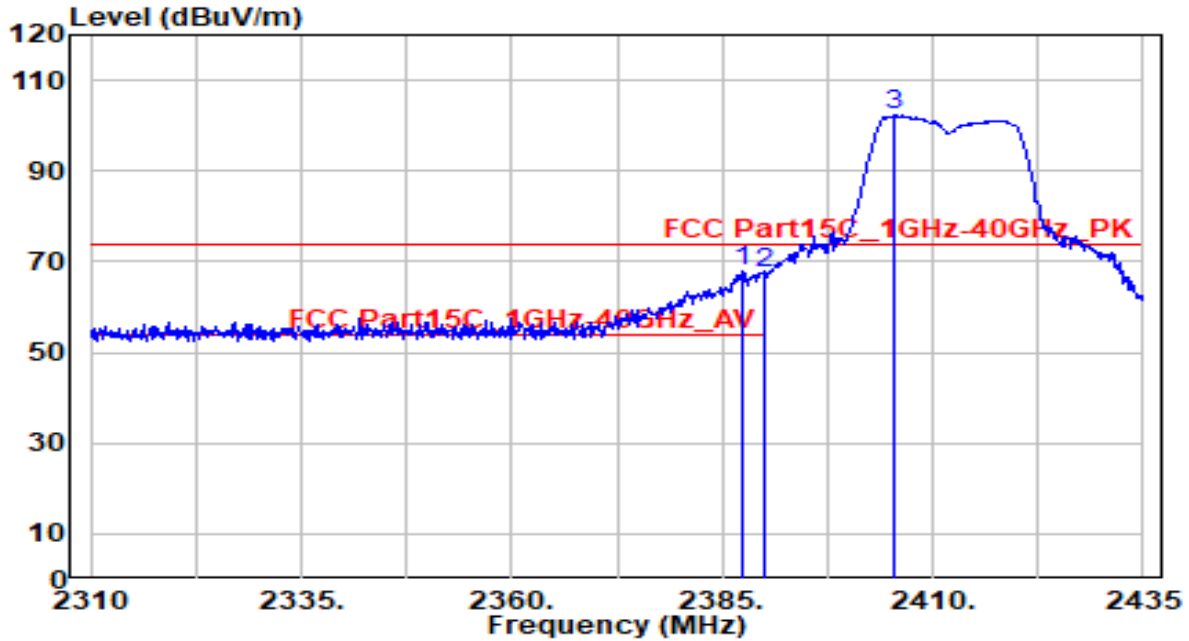

No	Frequency (MHz)	Reading (dBuV)	C.F (dB/m)	Measurement (dBuV/m)	Margin (dB)	Limit (dBuV/m)	Height (cm)	Angle (deg)	Remark (QP/PK/AV)
1	* 2387.250	37.03	30.80	67.83	-6.17	74.00	250	0	Peak
2	2390.000	36.88	30.80	67.68	-6.32	74.00	250	0	Peak
3	2405.500	71.36	30.84	102.20	N/A	N/A	250	0	Peak

Note:

1. " *", means this data is the worst emission level.
2. C.F (Correction Factor) = Antenna Factor (dB)+ Cable Loss (dB).
3. Measurement (dBuV/m) = Reading(dBuV) + C.F (Correction Factor).
4. The emission levels of other frequencies are very lower than the limit and not show in test report.

EUT	Display	Date of Test	2022-01-05
Factor	DRH18-E	Temp. / Humidity	22°C /58%
Polarity	Vertical	Site / Test Engineer	AC2 / Owen
Test Mode	802.11n-20MHz_TX_CH1_Ant 0+1	Test Voltage	AC 120V/60Hz

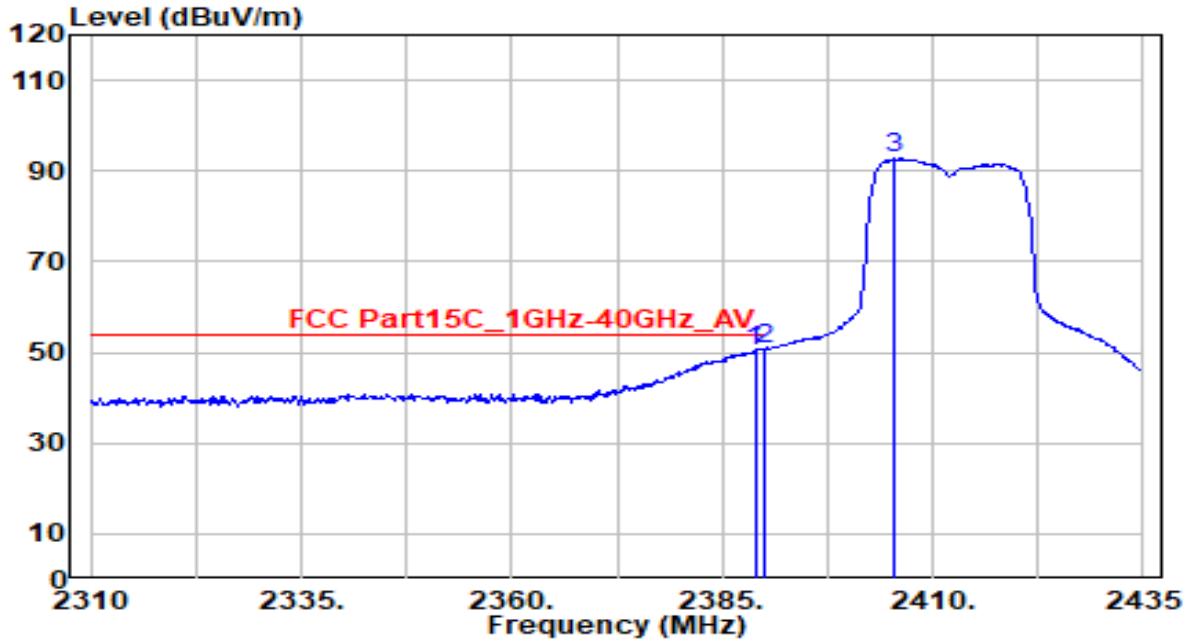

No	Frequency (MHz)	Reading (dBuV)	C.F (dB/m)	Measurement (dBuV/m)	Margin (dB)	Limit (dBuV/m)	Height (cm)	Angle (deg)	Remark (QP/PK/AV)
1	2388.875	19.51	30.80	50.31	-3.69	54.00	250	0	Average
2	* 2390.000	19.90	30.80	50.70	-3.30	54.00	250	0	Average
3	2405.500	61.96	30.84	92.80	N/A	N/A	250	0	Average

Note:

1. " *", means this data is the worst emission level.
2. C.F (Correction Factor) = Antenna Factor (dB)+ Cable Loss (dB).
3. Measurement (dBuV/m) = Reading(dBuV) + C.F (Correction Factor).
4. The emission levels of other frequencies are very lower than the limit and not show in test report.

EUT	Display	Date of Test	2022-01-05
Factor	DRH18-E	Temp. / Humidity	22°C /58%
Polarity	Horizontal	Site / Test Engineer	AC2 / Owen
Test Mode	802.11n-20MHz_TX_CH11_Ant 0+1	Test Voltage	AC 120V/60Hz

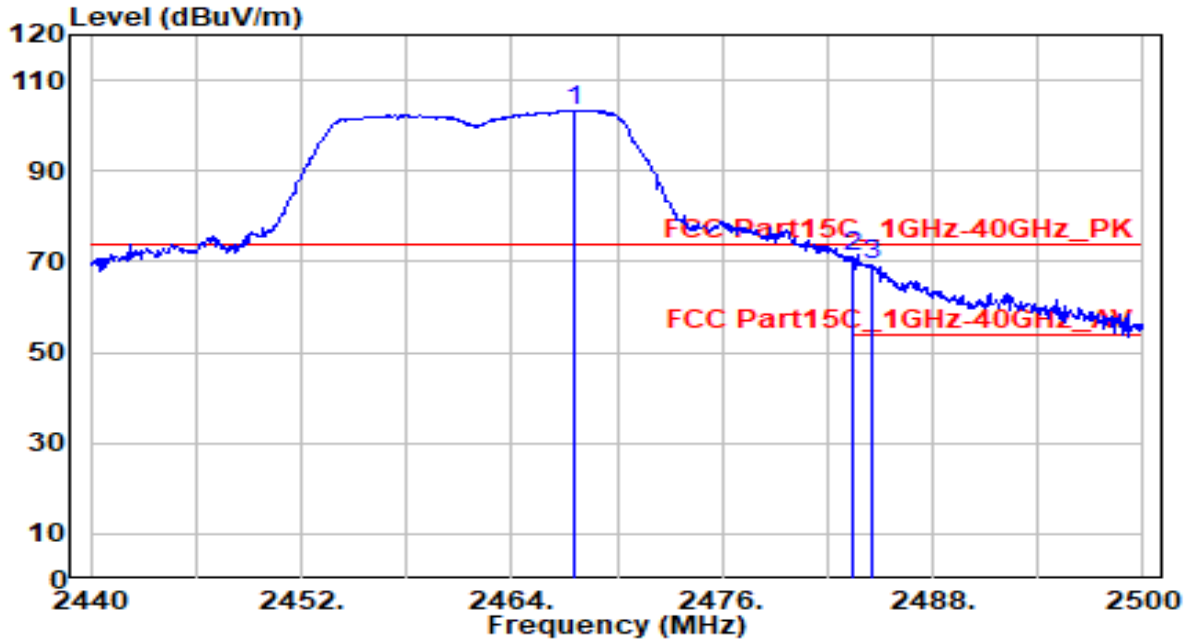

No	Frequency (MHz)	Reading (dBuV)	C.F (dB/m)	Measurement (dBuV/m)	Margin (dB)	Limit (dBuV/m)	Height (cm)	Angle (deg)	Remark (QP/PK/AV)
1	2467.540	72.47	30.96	103.43	N/A	N/A	176	297	Peak
2	* 2483.500	40.19	30.99	71.17	-2.83	74.00	176	297	Peak
3	2484.580	38.20	30.99	69.19	-4.81	74.00	176	297	Peak

Note:

1. " *", means this data is the worst emission level.
2. C.F (Correction Factor) = Antenna Factor (dB)+ Cable Loss (dB).
3. Measurement (dBuV/m) = Reading(dBuV) + C.F (Correction Factor).
4. The emission levels of other frequencies are very lower than the limit and not show in test report.

EUT	Display	Date of Test	2022-01-05
Factor	DRH18-E	Temp. / Humidity	22°C /58%
Polarity	Horizontal	Site / Test Engineer	AC2 / Owen
Test Mode	802.11n-20MHz_TX_CH11_Ant 0+1	Test Voltage	AC 120V/60Hz

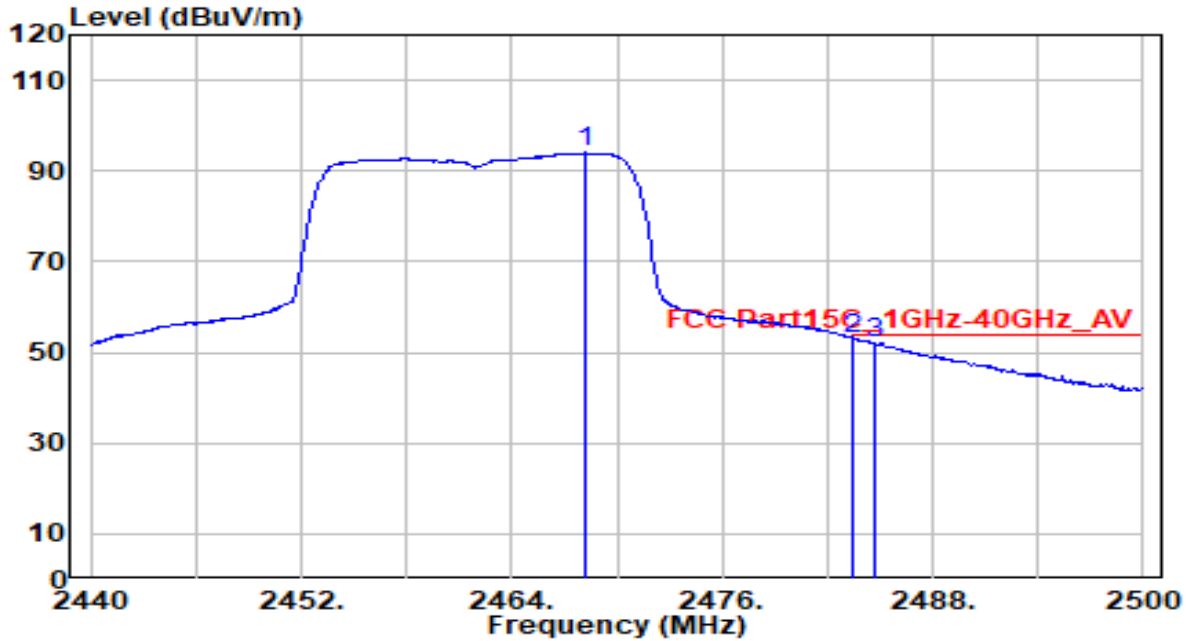

No	Frequency (MHz)	Reading (dBuV)	C.F (dB/m)	Measurement (dBuV/m)	Margin (dB)	Limit (dBuV/m)	Height (cm)	Angle (deg)	Remark (QP/PK/AV)
1	2468.260	63.02	30.96	93.98	N/A	N/A	175	295	Average
2	* 2483.500	22.06	30.99	53.05	-0.95	54.00	175	295	Average
3	2484.700	21.17	30.99	52.16	-1.84	54.00	175	295	Average

Note:

1. " *", means this data is the worst emission level.
2. C.F (Correction Factor) = Antenna Factor (dB)+ Cable Loss (dB).
3. Measurement (dBuV/m) = Reading(dBuV) + C.F (Correction Factor).
4. The emission levels of other frequencies are very lower than the limit and not show in test report.

EUT	Display	Date of Test	2022-01-05
Factor	DRH18-E	Temp. / Humidity	22°C /58%
Polarity	Vertical	Site / Test Engineer	AC2 / Owen
Test Mode	802.11n-20MHz_TX_CH11_Ant 0+1	Test Voltage	AC 120V/60Hz

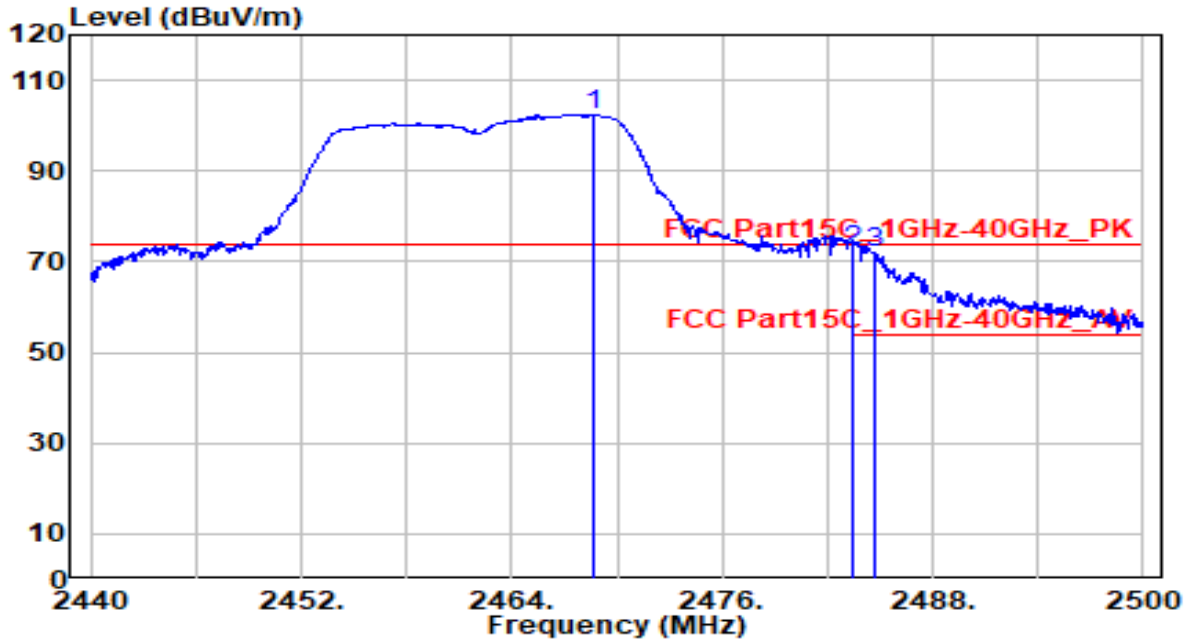

No	Frequency (MHz)	Reading (dBuV)	C.F (dB/m)	Measurement (dBuV/m)	Margin (dB)	Limit (dBuV/m)	Height (cm)	Angle (deg)	Remark (QP/PK/AV)
1	2468.740	71.45	30.96	102.41	N/A	N/A	240	0	Peak
2	* 2483.500	41.27	30.99	72.26	-1.74	74.00	240	0	Peak
3	2484.640	41.14	30.99	72.13	-1.87	74.00	240	0	Peak

Note:

1. " *", means this data is the worst emission level.
2. C.F (Correction Factor) = Antenna Factor (dB)+ Cable Loss (dB).
3. Measurement (dBuV/m) = Reading(dBuV) + C.F (Correction Factor).
4. The emission levels of other frequencies are very lower than the limit and not show in test report.

EUT	Display	Date of Test	2022-01-05
Factor	DRH18-E	Temp. / Humidity	22°C /58%
Polarity	Vertical	Site / Test Engineer	AC2 / Owen
Test Mode	802.11n-20MHz_TX_CH11_Ant 0+1	Test Voltage	AC 120V/60Hz

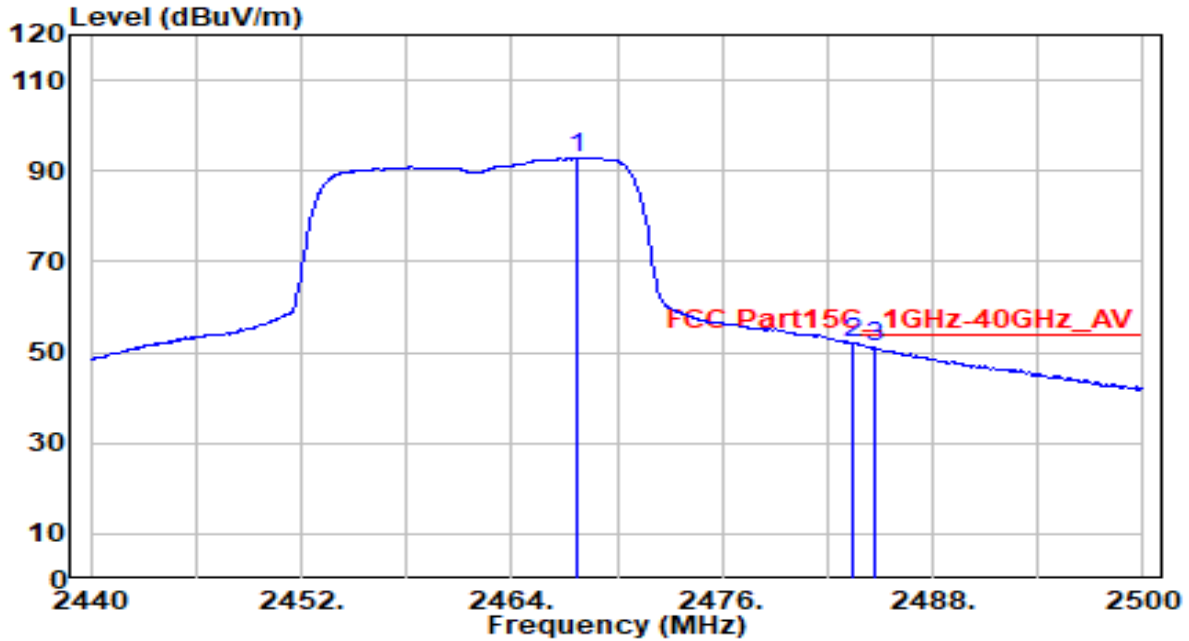

No	Frequency (MHz)	Reading (dBuV)	C.F (dB/m)	Measurement (dBuV/m)	Margin (dB)	Limit (dBuV/m)	Height (cm)	Angle (deg)	Remark (QP/PK/AV)
1	2467.720	61.89	30.96	92.84	N/A	N/A	240	0	Average
2	* 2483.500	21.07	30.99	52.06	-1.94	54.00	240	0	Average
3	2484.760	20.03	30.99	51.02	-2.98	54.00	240	0	Average

Note:

1. " *", means this data is the worst emission level.
2. C.F (Correction Factor) = Antenna Factor (dB)+ Cable Loss (dB).
3. Measurement (dBuV/m) = Reading(dBuV) + C.F (Correction Factor).
4. The emission levels of other frequencies are very lower than the limit and not show in test report.

EUT	Display	Date of Test	2022-01-05
Factor	DRH18-E	Temp. / Humidity	22°C /58%
Polarity	Horizontal	Site / Test Engineer	AC2 / Owen
Test Mode	802.11n-40MHz_TX_CH3_Ant 0+1	Test Voltage	AC 120V/60Hz

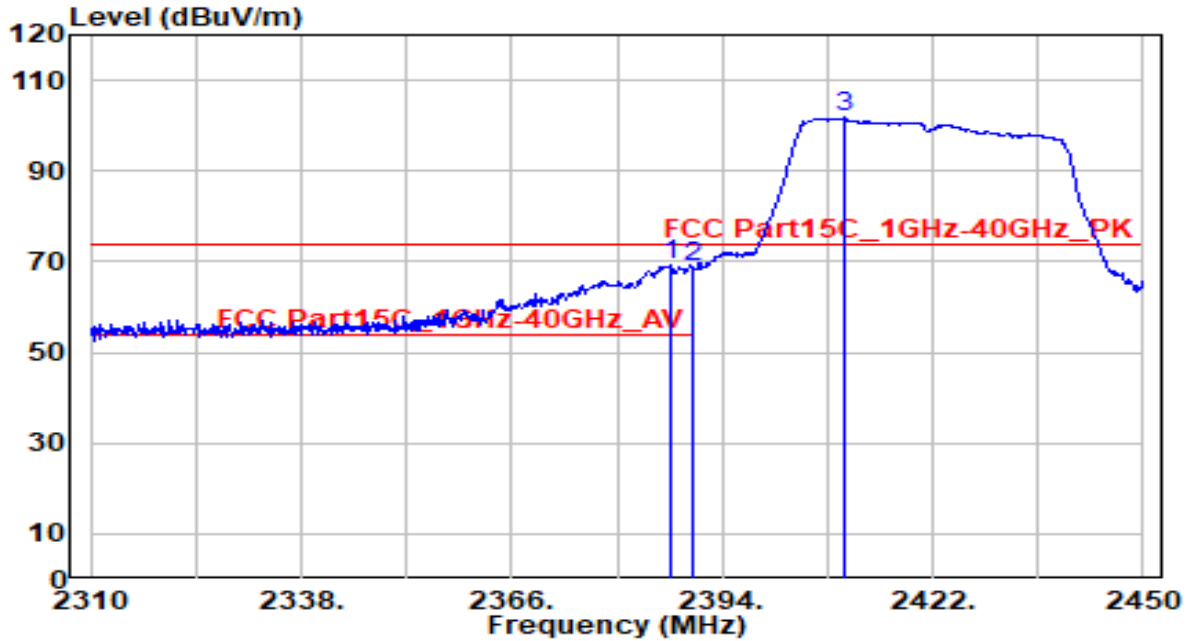

No	Frequency (MHz)	Reading (dBuV)	C.F (dB/m)	Measurement (dBuV/m)	Margin (dB)	Limit (dBuV/m)	Height (cm)	Angle (deg)	Remark (QP/PK/AV)
1	* 2387.280	38.64	30.80	69.43	-4.57	74.00	180	295	Peak
2	2390.000	38.06	30.80	68.87	-5.13	74.00	180	295	Peak
3	2410.240	70.89	30.85	101.74	N/A	N/A	180	295	Peak

Note:

1. " *", means this data is the worst emission level.
2. C.F (Correction Factor) = Antenna Factor (dB)+ Cable Loss (dB).
3. Measurement (dBuV/m) = Reading(dBuV) + C.F (Correction Factor).
4. The emission levels of other frequencies are very lower than the limit and not show in test report.

EUT	Display	Date of Test	2022-01-05
Factor	DRH18-E	Temp. / Humidity	22°C /58%
Polarity	Horizontal	Site / Test Engineer	AC2 / Owen
Test Mode	802.11n-40MHz_TX_CH3_Ant 0+1	Test Voltage	AC 120V/60Hz

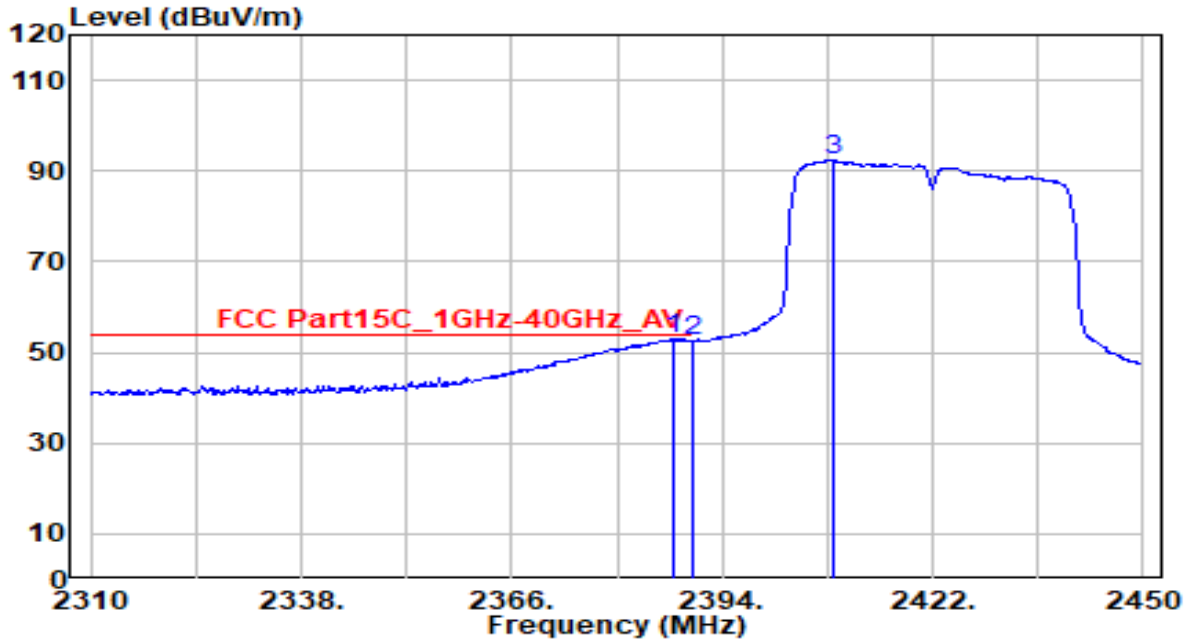

No	Frequency (MHz)	Reading (dBuV)	C.F (dB/m)	Measurement (dBuV/m)	Margin (dB)	Limit (dBuV/m)	Height (cm)	Angle (deg)	Remark (QP/PK/AV)
1	* 2387.560	22.34	30.80	53.14	-0.86	54.00	180	295	Average
2	2390.000	21.63	30.80	52.43	-1.57	54.00	180	295	Average
3	2408.700	61.50	30.84	92.34	N/A	N/A	180	295	Average

Note:

1. " *", means this data is the worst emission level.
2. C.F (Correction Factor) = Antenna Factor (dB)+ Cable Loss (dB).
3. Measurement (dBuV/m) = Reading(dBuV) + C.F (Correction Factor).
4. The emission levels of other frequencies are very lower than the limit and not show in test report.

EUT	Display	Date of Test	2022-01-05
Factor	DRH18-E	Temp. / Humidity	22°C /58%
Polarity	Vertical	Site / Test Engineer	AC2 / Owen
Test Mode	802.11n-40MHz_TX_CH3_Ant 0+1	Test Voltage	AC 120V/60Hz

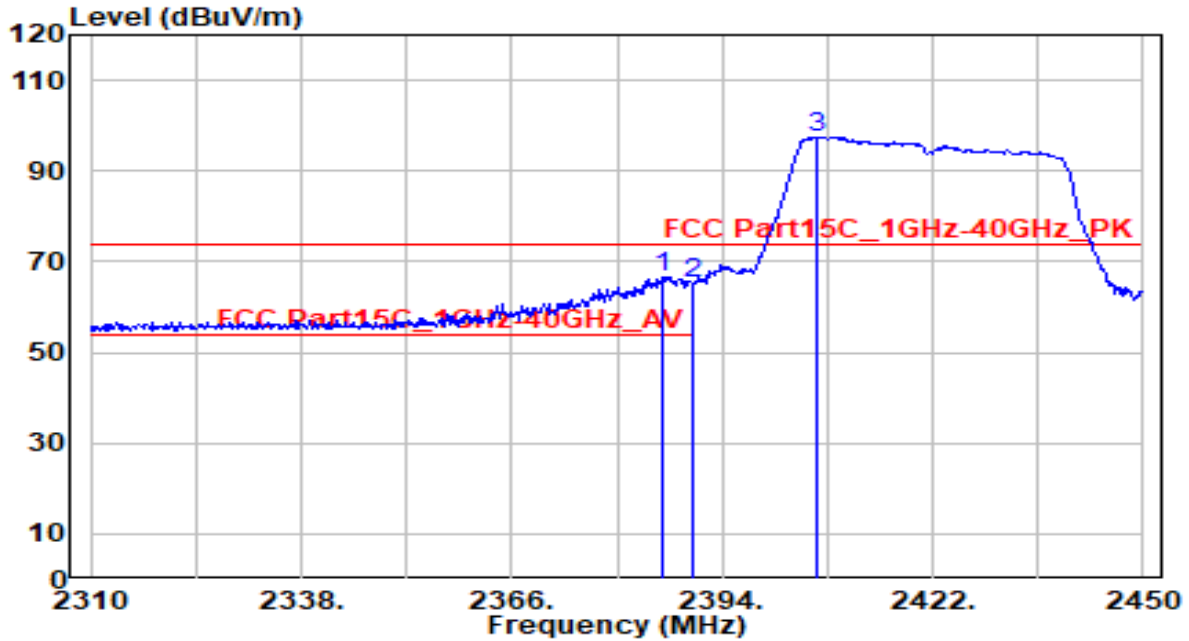

No	Frequency (MHz)	Reading (dBuV)	C.F (dB/m)	Measurement (dBuV/m)	Margin (dB)	Limit (dBuV/m)	Height (cm)	Angle (deg)	Remark (QP/PK/AV)
1	* 2386.160	35.95	30.79	66.74	-7.26	74.00	250	5	Peak
2	2390.000	34.38	30.80	65.19	-8.81	74.00	250	5	Peak
3	2406.600	66.66	30.84	97.50	N/A	N/A	250	5	Peak

Note:

1. " *", means this data is the worst emission level.
2. C.F (Correction Factor) = Antenna Factor (dB)+ Cable Loss (dB).
3. Measurement (dBuV/m) = Reading(dBuV) + C.F (Correction Factor).
4. The emission levels of other frequencies are very lower than the limit and not show in test report.

EUT	Display	Date of Test	2022-01-05
Factor	DRH18-E	Temp. / Humidity	22°C /58%
Polarity	Vertical	Site / Test Engineer	AC2 / Owen
Test Mode	802.11n-40MHz_TX_CH3_Ant 0+1	Test Voltage	AC 120V/60Hz

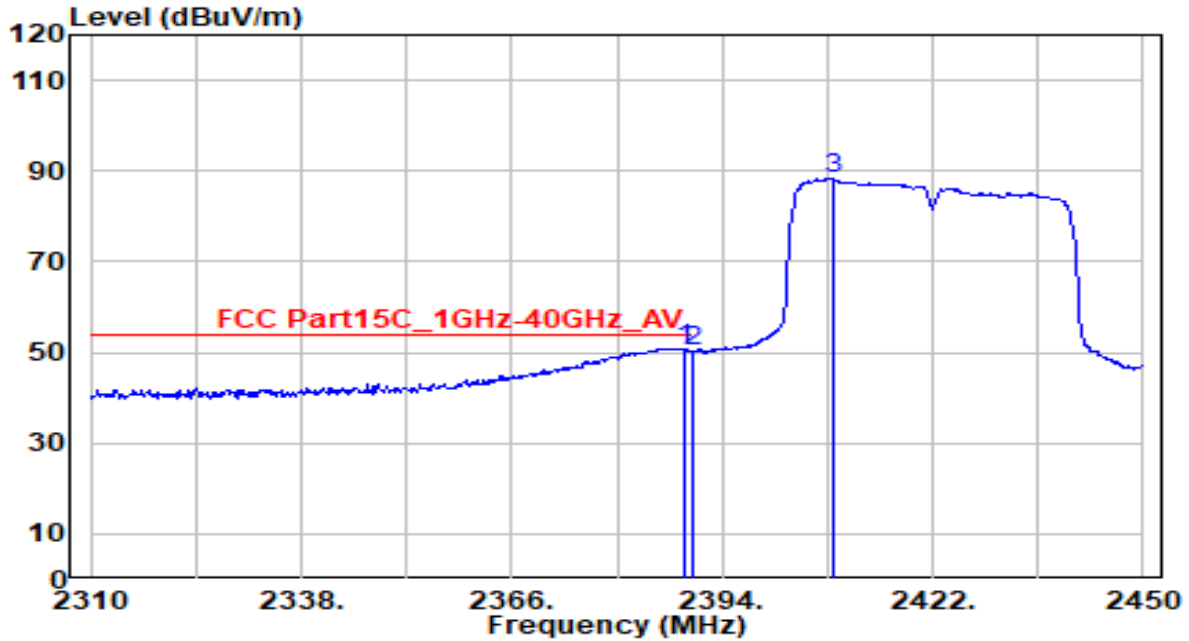

No	Frequency (MHz)	Reading (dBuV)	C.F (dB/m)	Measurement (dBuV/m)	Margin (dB)	Limit (dBuV/m)	Height (cm)	Angle (deg)	Remark (QP/PK/AV)
1	*	20.13	30.80	50.93	-3.07	54.00	250	5	Average
2		19.45	30.80	50.26	-3.74	54.00	250	5	Average
3		57.39	30.84	88.23	N/A	N/A	250	5	Average

Note:

1. " *", means this data is the worst emission level.
2. C.F (Correction Factor) = Antenna Factor (dB)+ Cable Loss (dB).
3. Measurement (dBuV/m) = Reading(dBuV) + C.F (Correction Factor).
4. The emission levels of other frequencies are very lower than the limit and not show in test report.

EUT	Display	Date of Test	2022-01-05
Factor	DRH18-E	Temp. / Humidity	22°C /58%
Polarity	Horizontal	Site / Test Engineer	AC2 / Owen
Test Mode	802.11n-40MHz_TX_CH9_Ant 0+1	Test Voltage	AC 120V/60Hz

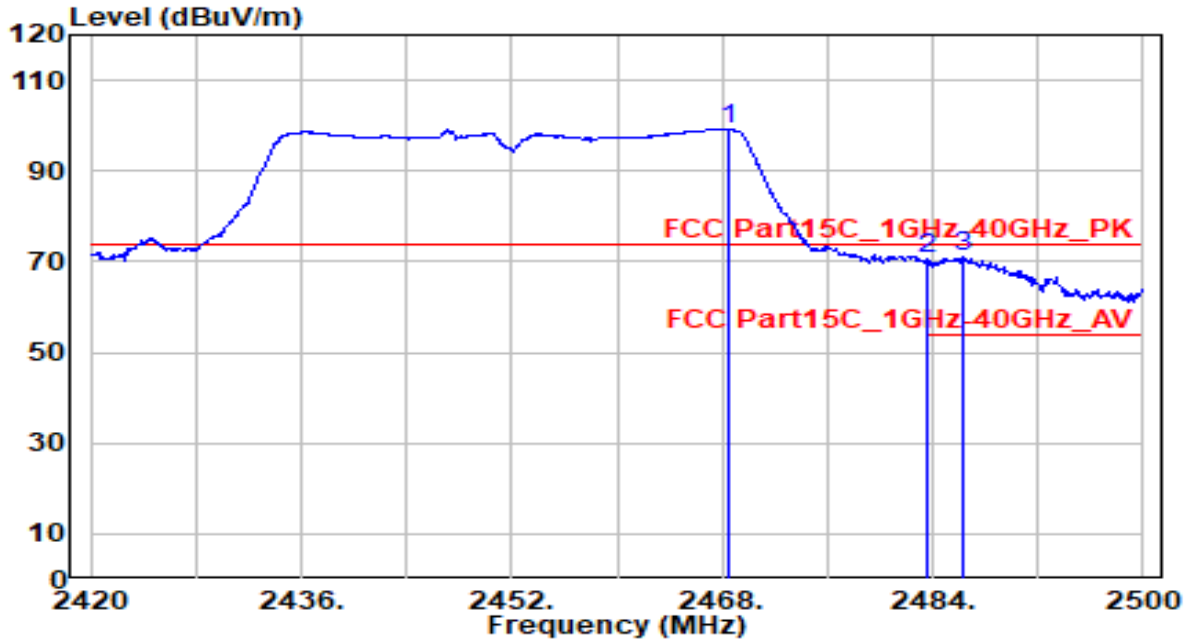

No	Frequency (MHz)	Reading (dBuV)	C.F (dB/m)	Measurement (dBuV/m)	Margin (dB)	Limit (dBuV/m)	Height (cm)	Angle (deg)	Remark (QP/PK/AV)
1	2468.560	68.23	30.96	99.19	N/A	N/A	185	300	Peak
2	2483.500	39.54	30.99	70.53	-3.47	74.00	185	300	Peak
3	* 2486.320	40.05	30.99	71.05	-2.95	74.00	185	300	Peak

Note:

1. " *", means this data is the worst emission level.
2. C.F (Correction Factor) = Antenna Factor (dB)+ Cable Loss (dB).
3. Measurement (dBuV/m) = Reading(dBuV) + C.F (Correction Factor).
4. The emission levels of other frequencies are very lower than the limit and not show in test report.

EUT	Display	Date of Test	2022-01-05
Factor	DRH18-E	Temp. / Humidity	22°C /58%
Polarity	Horizontal	Site / Test Engineer	AC2 / Owen
Test Mode	802.11n-40MHz_TX_CH9_Ant 0+1	Test Voltage	AC 120V/60Hz

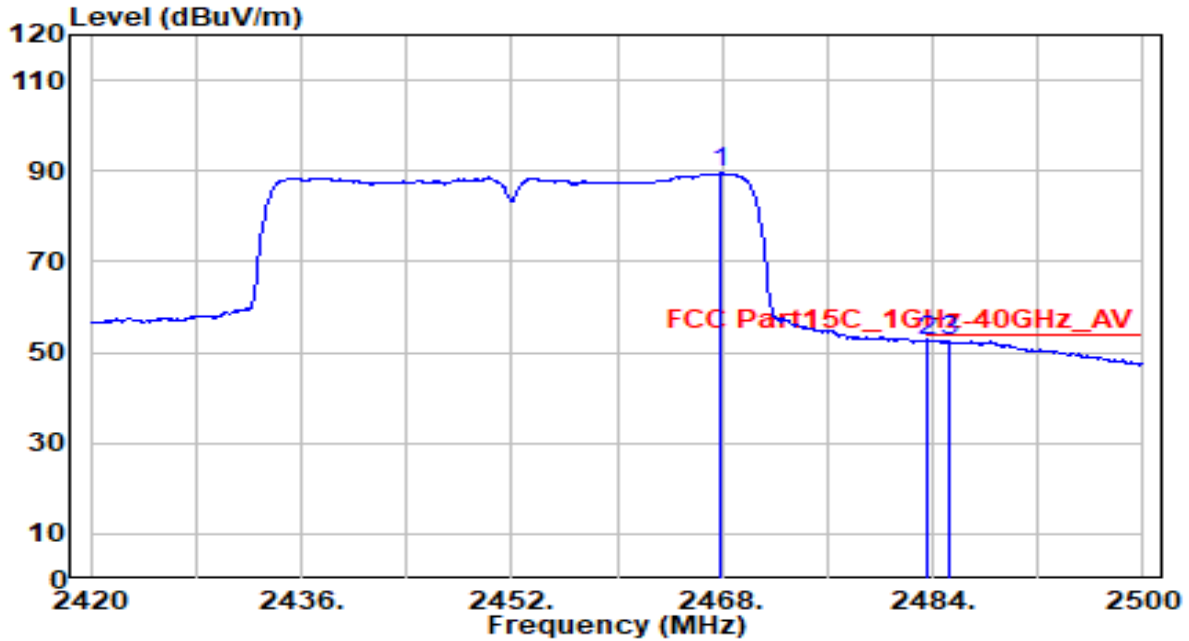

No	Frequency (MHz)	Reading (dBuV)	C.F (dB/m)	Measurement (dBuV/m)	Margin (dB)	Limit (dBuV/m)	Height (cm)	Angle (deg)	Remark (QP/PK/AV)
1	2467.920	58.52	30.96	89.48	N/A	N/A	185	300	Average
2	2483.500	21.49	30.99	52.47	-1.53	54.00	185	300	Average
3	* 2485.200	21.74	30.99	52.73	-1.27	54.00	185	300	Average

Note:

1. " *", means this data is the worst emission level.
2. C.F (Correction Factor) = Antenna Factor (dB)+ Cable Loss (dB).
3. Measurement (dBuV/m) = Reading(dBuV) + C.F (Correction Factor).
4. The emission levels of other frequencies are very lower than the limit and not show in test report.

EUT	Display	Date of Test	2022-01-05
Factor	DRH18-E	Temp. / Humidity	22°C /58%
Polarity	Vertical	Site / Test Engineer	AC2 / Owen
Test Mode	802.11n-40MHz_TX_CH9_Ant 0+1	Test Voltage	AC 120V/60Hz

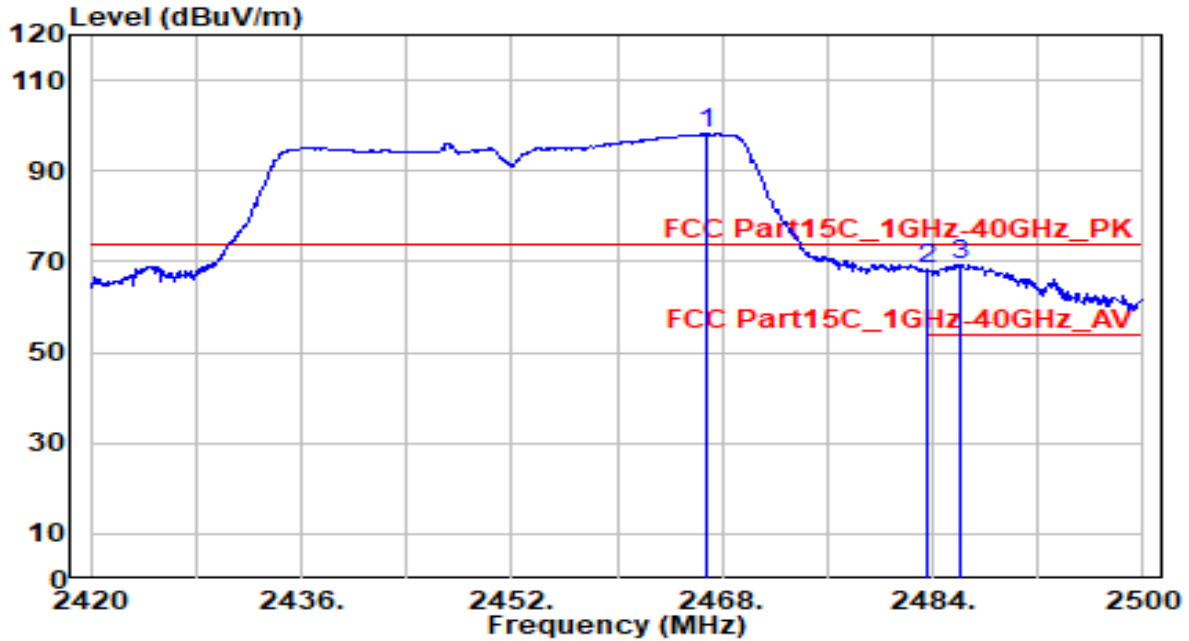

No	Frequency (MHz)	Reading (dBuV)	C.F (dB/m)	Measurement (dBuV/m)	Margin (dB)	Limit (dBuV/m)	Height (cm)	Angle (deg)	Remark (QP/PK/AV)
1	2466.720	67.18	30.96	98.13	N/A	N/A	215	0	Peak
2	2483.500	37.17	30.99	68.16	-5.84	74.00	215	0	Peak
3	* 2486.160	38.32	30.99	69.32	-4.68	74.00	215	0	Peak

Note:

1. " *", means this data is the worst emission level.
2. C.F (Correction Factor) = Antenna Factor (dB)+ Cable Loss (dB).
3. Measurement (dBuV/m) = Reading(dBuV) + C.F (Correction Factor).
4. The emission levels of other frequencies are very lower than the limit and not show in test report.

EUT	Display	Date of Test	2022-01-05
Factor	DRH18-E	Temp. / Humidity	22°C /58%
Polarity	Vertical	Site / Test Engineer	AC2 / Owen
Test Mode	802.11n-40MHz_TX_CH9_Ant 0+1	Test Voltage	AC 120V/60Hz

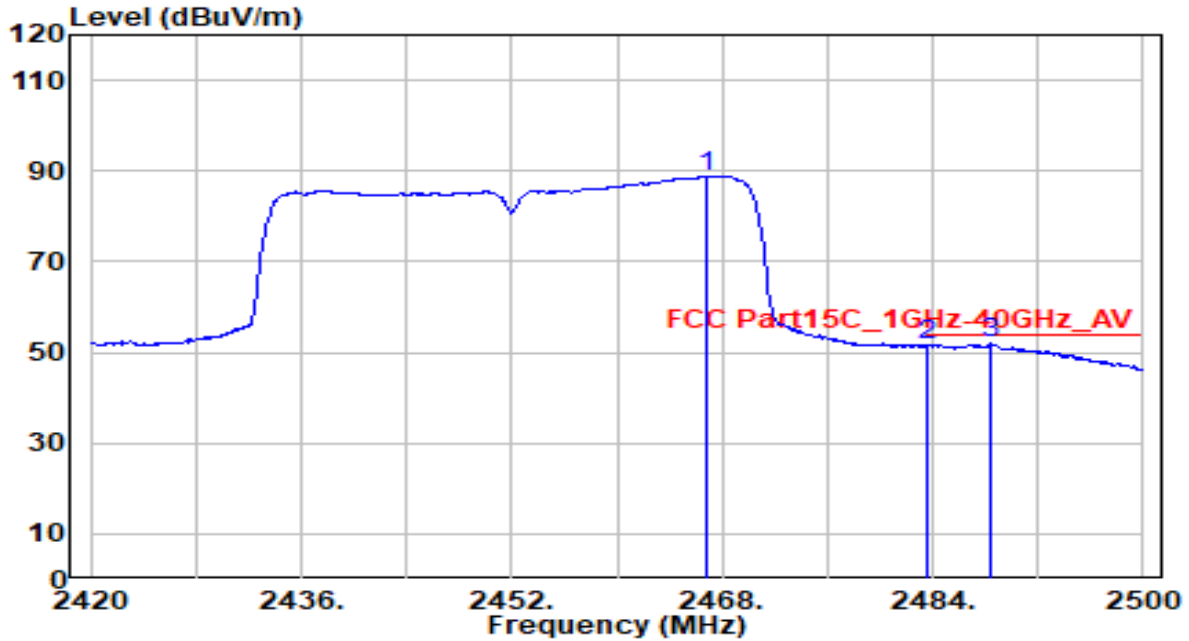

No	Frequency (MHz)	Reading (dBuV)	C.F (dB/m)	Measurement (dBuV/m)	Margin (dB)	Limit (dBuV/m)	Height (cm)	Angle (deg)	Remark (QP/PK/AV)
1	2466.880	57.92	30.96	88.87	N/A	N/A	215	0	Average
2	2483.500	20.42	30.99	51.41	-2.59	54.00	215	0	Average
3	* 2488.400	20.90	31.00	51.90	-2.10	54.00	215	0	Average

Note:

1. " *", means this data is the worst emission level.
2. C.F (Correction Factor) = Antenna Factor (dB)+ Cable Loss (dB).
3. Measurement (dBuV/m) = Reading(dBuV) + C.F (Correction Factor).
4. The emission levels of other frequencies are very lower than the limit and not show in test report.

7.8. AC Conducted Emissions Measurement

7.8.1. Test Limit

FCC Part 15 Subpart C Paragraph 15.207 / RSS-Gen Limits		
Frequency (MHz)	QP (dB μ V)	Average (dB μ V)
0.15 - 0.50	66 - 56	56 - 46
0.50 - 5.0	56	46
5.0 - 30	60	50

Note 1: The lower limit shall apply at the transition frequencies.

Note 2: The limit decreases linearly with the logarithm of the frequency in the range 0.15MHz to 0.5MHz.

7.8.2. Test Setup

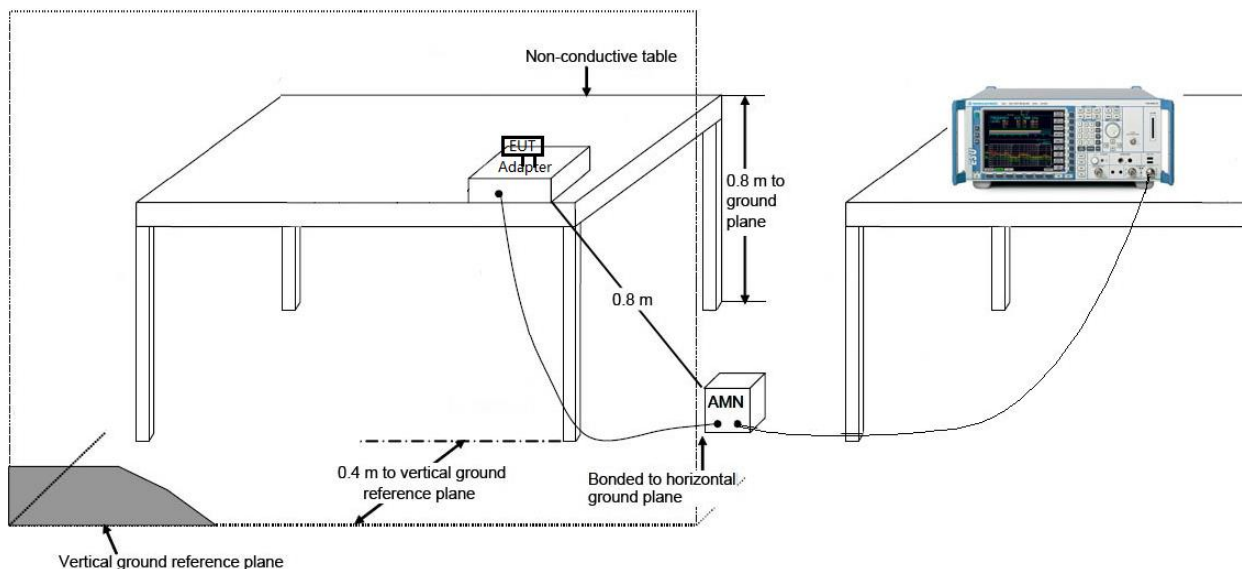

7.8.3. Test Result

EUT	Display	Date of Test	2022-01-08
Factor	CE_ENV216-L1 (Filter ON)	Temp. / Humidity	21.4°C /57%
Polarity	Line1	Site / Test Engineer	SR2 / Volvo
Test Mode	802.11n-20MHz_TX_CH 6_ANT 0+1	Test Voltage	AC 120V/60Hz

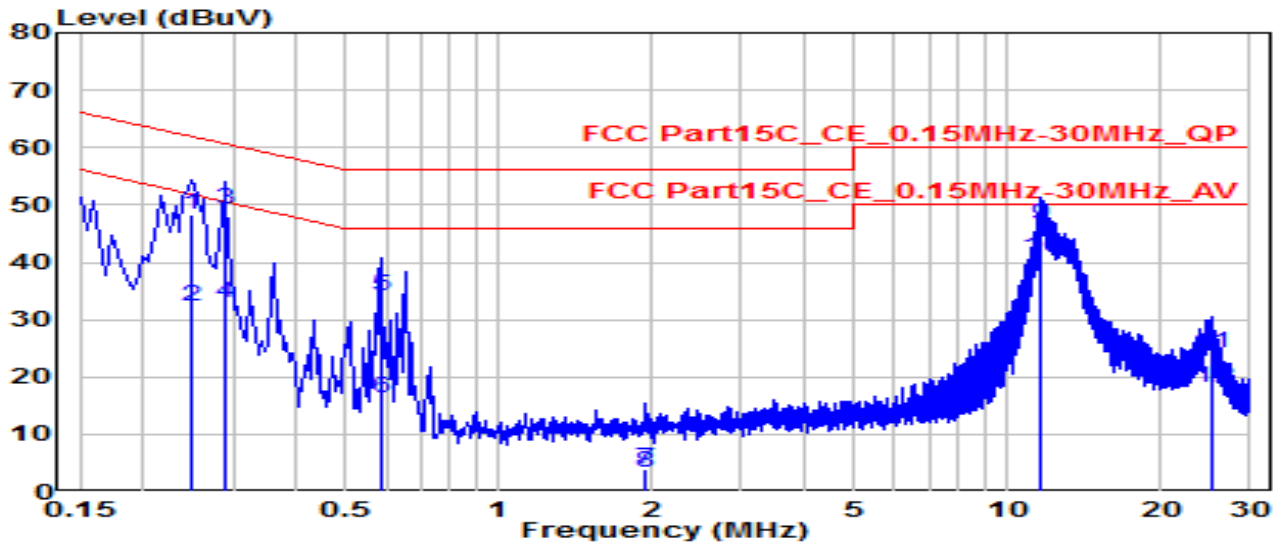

No	Frequency (MHz)	Reading (dBuV)	C.F (dB)	Measurement (dBuV/m)	Margin (dB)	Limit (dBuV/m)	Remark (QP/PK/AV)
1	0.249	38.78	9.62	48.39	-13.40	61.79	QP
2	0.249	22.78	9.62	32.40	-19.39	51.79	Average
3	0.289	39.46	9.62	49.08	-11.46	60.54	QP
4	0.289	23.15	9.62	32.77	-17.77	50.54	Average
5	0.586	24.58	9.64	34.21	-21.79	56.00	QP
6	0.586	6.53	9.64	16.17	-29.83	46.00	Average
7	1.936	-5.73	9.69	3.96	-52.04	56.00	QP
8	1.936	-6.28	9.69	3.41	-42.59	46.00	Average
9	*	11.682	9.89	46.43	-13.57	60.00	QP
10	*	11.682	9.89	40.86	-9.14	50.00	Average
11	25.127	14.07	10.01	24.07	-35.93	60.00	QP
12	25.127	8.19	10.01	18.20	-31.80	50.00	Average

Note:

1. " *", means this data is the worst emission level.
2. C.F (Correction Factor) = Antenna Factor (dB)+ Cable Loss (dB).
3. Measurement (dBuV/m) = Reading(dBuV) + C.F (Correction Factor).

EUT	Display	Date of Test	2022-01-08
Factor	CE_ENV216-N (Filter ON)	Temp. / Humidity	21.4°C /57%
Polarity	Neutral	Site / Test Engineer	SR2 / Volvo
Test Mode	802.11n-20MHz_TX_CH 6_ANT 0+1	Test Voltage	AC 120V/60Hz

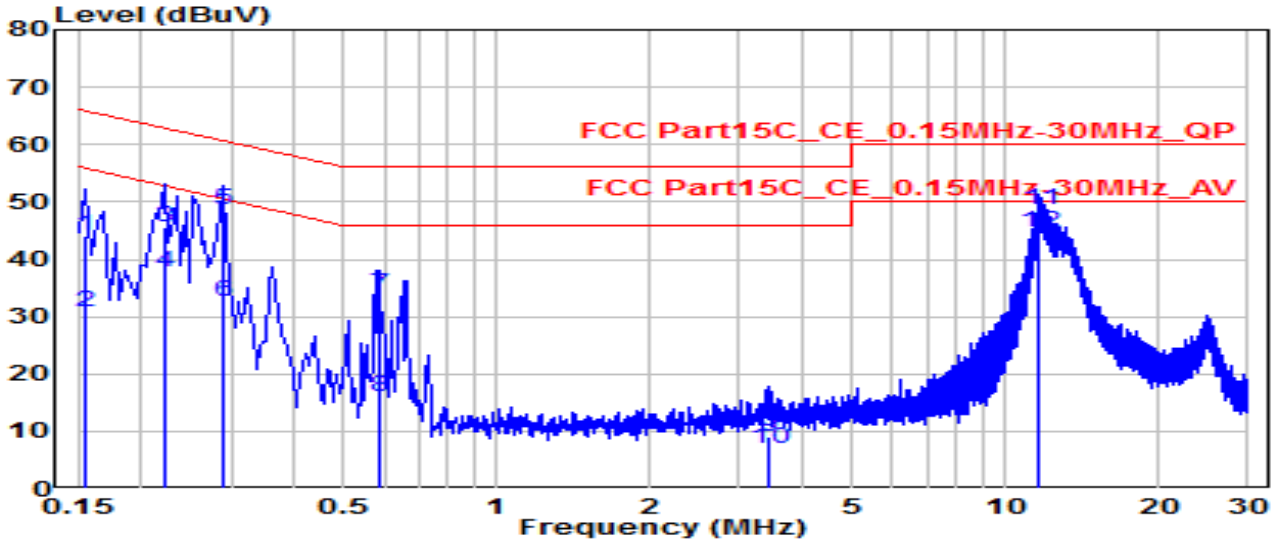

No	Frequency (MHz)	Reading (dBuV)	C.F (dB)	Measurement (dBuV/m)	Margin (dB)	Limit (dBuV/m)	Remark (QP/PK/AV)
1	0.154	34.55	9.62	44.17	-21.59	65.75	QP
2	0.154	21.25	9.62	30.87	-24.89	55.75	Average
3	0.222	35.83	9.61	45.45	-17.30	62.74	QP
4	0.222	28.20	9.61	37.82	-14.93	52.74	Average
5	0.289	38.87	9.62	48.49	-12.05	60.54	QP
6	0.289	22.96	9.62	32.58	-17.96	50.54	Average
7	0.586	24.08	9.64	33.72	-22.28	56.00	QP
8	0.586	6.50	9.64	16.14	-29.86	46.00	Average
9	3.439	-0.62	9.72	9.10	-46.90	56.00	QP
10	3.439	-2.79	9.72	6.93	-39.07	46.00	Average
11	*	11.678	9.92	48.72	-11.28	60.00	QP
12	*	11.678	9.92	44.55	-5.45	50.00	Average

Note:

1. " *", means this data is the worst emission level.
2. C.F (Correction Factor) = Antenna Factor (dB)+ Cable Loss (dB).
3. Measurement (dBuV/m) = Reading(dBuV) + C.F (Correction Factor).

EUT	Display	Date of Test	2022-01-08
Factor	CE_ENV216-L1 (Filter ON)	Temp. / Humidity	21.4°C /57%
Polarity	Line1	Site / Test Engineer	SR2 / Volvo
Test Mode	802.11n-20MHz_TX_CH 6_ANT 0+1	Test Voltage	AC 240V/60Hz

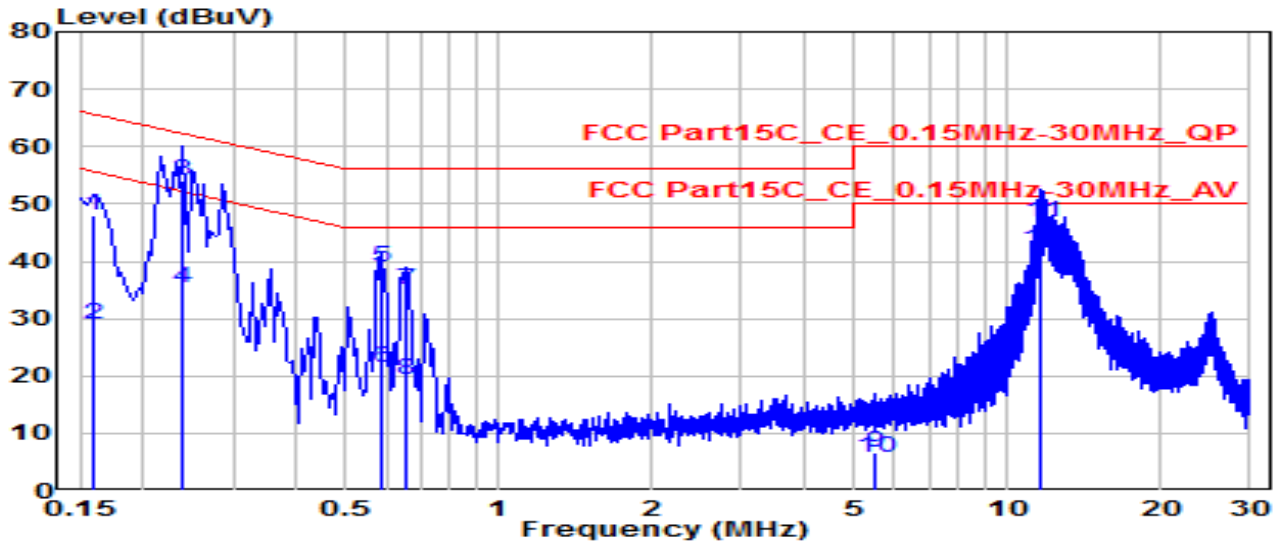

No	Frequency (MHz)	Reading (dBuV)	C.F (dB)	Measurement (dBuV/m)	Margin (dB)	Limit (dBuV/m)	Remark (QP/PK/AV)
1	0.159	38.52	9.61	48.13	-17.39	65.52	QP
2	0.159	19.31	9.61	28.92	-26.59	55.52	Average
3	* 0.240	44.39	9.62	54.01	-8.09	62.10	QP
4	* 0.240	25.85	9.62	35.47	-16.63	52.10	Average
5	0.586	29.35	9.64	38.99	-17.01	56.00	QP
6	0.586	11.81	9.64	21.44	-24.56	46.00	Average
7	0.654	25.28	9.64	34.92	-21.08	56.00	QP
8	0.654	9.74	9.64	19.38	-26.62	46.00	Average
9	5.464	-2.99	9.75	6.76	-53.24	60.00	QP
10	5.464	-4.12	9.75	5.63	-44.37	50.00	Average
11	11.673	36.98	9.89	46.87	-13.13	60.00	QP
12	11.673	31.93	9.89	41.82	-8.18	50.00	Average

Note:

1. " *", means this data is the worst emission level.
2. C.F (Correction Factor) = Antenna Factor (dB)+ Cable Loss (dB).
3. Measurement (dBuV/m) = Reading(dBuV) + C.F (Correction Factor).

EUT	Display	Date of Test	2022-01-08
Factor	CE_ENV216-N (Filter ON)	Temp. / Humidity	21.4°C /57%
Polarity	Neutral	Site / Test Engineer	SR2 / Volvo
Test Mode	802.11n-20MHz_TX_CH 6_ANT 0+1	Test Voltage	AC 240V/60Hz

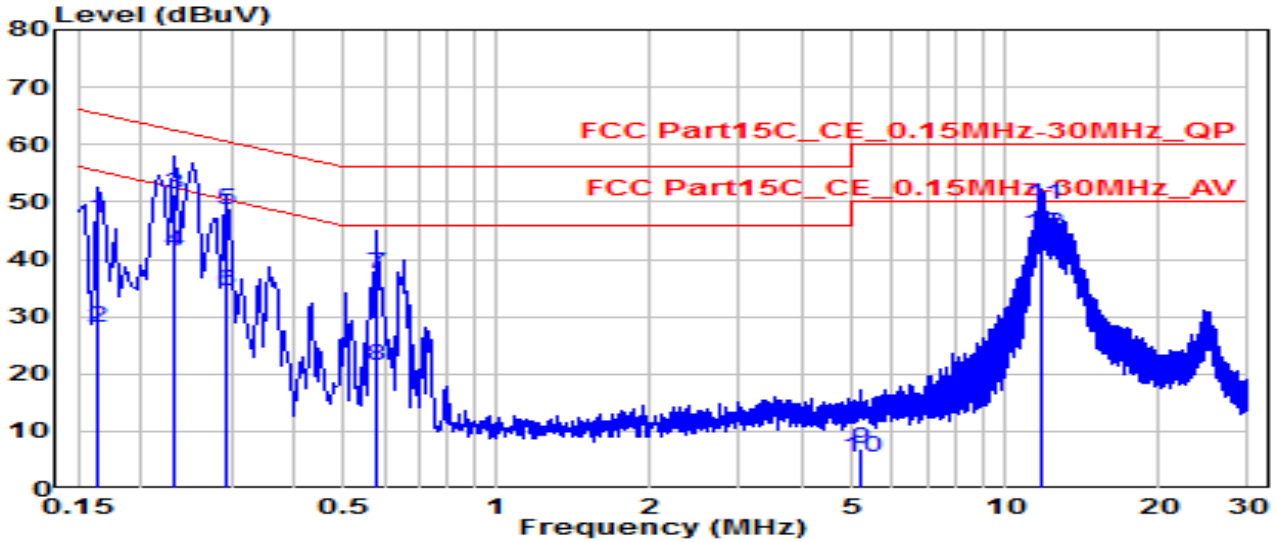

No	Frequency (MHz)	Reading (dBuV)	C.F (dB)	Measurement (dBuV/m)	Margin (dB)	Limit (dBuV/m)	Remark (QP/PK/AV)
1	0.163	37.60	9.62	47.22	-18.06	65.28	QP
2	0.163	18.43	9.62	28.04	-27.24	55.28	Average
3	0.231	41.83	9.61	51.45	-10.97	62.41	QP
4	0.231	31.66	9.61	41.28	-11.14	52.41	Average
5	0.294	38.94	9.62	48.55	-11.86	60.41	QP
6	0.294	24.93	9.62	34.54	-15.87	50.41	Average
7	0.582	27.91	9.64	37.55	-18.45	56.00	QP
8	0.582	11.91	9.64	21.55	-24.45	46.00	Average
9	5.189	-2.91	9.76	6.85	-53.15	60.00	QP
10	5.189	-4.30	9.76	5.46	-44.54	50.00	Average
11	* 11.813	39.44	9.92	49.36	-10.64	60.00	QP
12	* 11.813	34.45	9.92	44.37	-5.63	50.00	Average

Note:

1. " *", means this data is the worst emission level.
2. C.F (Correction Factor) = Antenna Factor (dB)+ Cable Loss (dB).
3. Measurement (dBuV/m) = Reading(dBuV) + C.F (Correction Factor).

8. CONCLUSION

The data collected relate only the item(s) tested and show that the **Display** is in compliance with Part 15C of the FCC Rules.

————— The End —————