

**DS552LT6-2**

# USER MANUAL

55" Clean Back Digital Signage

Please read this manual carefully before operating the product and keep it for future reference. The use of diagrams and illustrations in the manual are for reference only, the actual product may be different.



## FOR MORE INFORMATION

For more information about DynaScan, visit our site at [www.dynascan.com](http://www.dynascan.com). Copyright © DynaScan Technology Inc. All rights reserved. All specifications and descriptions are subject to change without notice. Reproduction in whole or in part without permission is prohibited.

**DynaScan**

# Contents

---

Material Contents Declaration .....	1
Recycling and Energy Information .....	1
Declaration of Conformity .....	2
Déclaration de conformité.....	3
Safety Precautions .....	4
Précautions relatives à la sécurité.....	5
Important Safety Information .....	6
Informations importantes relatives à la sécurité.....	7
Getting Started .....	8
Contents .....	8
Installing and Replacing Remote Control Batteries.....	8
Bien débuter .....	9
Contenu .....	9
Mise en place et remplacement des piles de la télécommande.....	9
Installation.....	10
Mounting .....	10
Wall Mounting.....	13
Connecting to a Power Source.....	13
Connecting an External Video Source .....	14
Input / Output Terminals.....	15
Operating Instructions .....	16
Powering On/Off the Display .....	16
Using the Remote Control .....	17
Using the built-in keypad .....	19
Navigating the On Screen Display (OSD) Menu .....	20
Specifications .....	25
Input Mode.....	26
Pin Assignments.....	27
RS-232 Input .....	27
Troubleshooting.....	28
About DSM365 .....	29

# Material Contents Declaration

Part Name	Hazardous Substances					
	Lead	Mercury	Cadmium	Hexavalent Chromium	Polybrominated Biphenyls	Polybromodiphenyl Ethers
	Pb	Hg	Cd	Cr <sup>6+</sup>	PBB	PBDE
PCBA	○	○	○	○	○	○
CHASSIS	○	○	○	○	○	○
ACCESSORY	○	○	○	○	○	○
PACKAGE	○	○	○	○	○	○

“○” indicates that the level of the specified chemical substance is less than the threshold level specified in the standards of SJ/T-11363-2006 and EU 2005/618/EC.  
 “×” indicates that the level of the specified chemical substance exceeds the threshold level specified in the standards of SJ/T-11363-2006 and EU 2005/618/EC.

## Recycling and Energy Information

DynaScan is firmly committed to its environmental protection efforts and we believe that reducing our products' impact on the environment is of the utmost importance. We are dedicated to meet the latest environmental protection regulations.

### Energy usage

Mode	Energy Consumption
Normal	Max. 400 W
Standby	< 1 W

### Disposal

Do not dispose of electrical appliances as unsorted municipal waste, use separate collection facilities. Contact your local government for information regarding the collection systems available. If electrical appliances are disposed of in landfills or dumps, hazardous substances can leak into the groundwater and get into the food chain, damaging your health and well-being. When replacing old appliances with new one, the retailer is legally obligated to take back your old appliances for disposal at least for free of charge.



# Declaration of Conformity

---

## FCC

This device complies with Part 15 of the FCC Rules. Operation is subject to the following two conditions: (1) this device may not cause harmful interference, and (2) this device must accept any interference received, including interference that may cause undesired operation.

## FEDERAL COMMUNICATIONS COMMISSION INTERFERENCE STATEMENT

This equipment has been tested and found to comply with the limits for a Class A digital device, pursuant to part 15 of the FCC Rules. These limits are designed to provide reasonable protection against harmful interference when the equipment is operated in a commercial environment. This equipment generates, uses, and can radiate radio frequency energy and, if not installed and used in accordance with the instruction manual, may cause harmful interference to radio communications. Operation of this equipment in a residential area is likely to cause harmful interference in which case the user will be required to correct the interference at his own expense.

## CAUTION:

Any changes or modifications not expressly approved by the grantee of this device could void the user's authority to operate the equipment.

## RF exposure warning

This equipment must be installed and operated in accordance with provided instructions and the antenna(s) used for this transmitter must be installed to provide a separation distance of at least 20 cm from all persons and must not be co-located or operating in conjunction with any other antenna or transmitter. End-users and installers must be provide with antenna installation instructions and transmitter operating conditions for satisfying RF exposure compliance.

**Manufacturer Name** DynaScan Technology Corp.

**Manufacturer Address** 6F, No. 88 Wenmao Rd., Guishan Dist, Taoyuan City 333001, Taiwan



This device complies with **Directive 2014/53/EU** issued by the Commission of the European Community.

Article (a) EN 62368-1	Article (b) EN 55032 Class A EN 61000-3-2:2014 EN 61000-3-3:2013 EN 55035:2017 EN 301 489-1 Class A EN 301 489-17
---------------------------	---

## - Frequency bands and Powers

- a. WIFI 2.4G-2412~2462MHz.
- b. Maximum radio-frequency power transmitted in the 2.4GHz is 50mW.

# Déclaration de conformité

---

## FCC

Cet appareil est conforme à la section 15 de la réglementation FCC. Son utilisation est sujette aux deux conditions suivantes : (1) cet appareil ne doit pas causer d'interférence nuisible, et (2) cet appareil doit accepter toute interférence reçue, y compris celles qui peuvent causer un fonctionnement non souhaité.

## DÉCLARATION DE LA COMMISSION FÉDÉRALE DES COMMUNICATIONS

Cet équipement a été testé et déclaré conforme aux limites d'un appareil numérique de classe A, conformément à la partie 15 des règles FCC. Ces limites sont conçues pour fournir une protection raisonnable contre les interférences nuisibles lorsque l'équipement est utilisé dans un environnement commercial. Ce l'équipement génère, utilise et peut émettre de l'énergie radiofréquence et, s'il n'est pas installé et utilisé conformément au manuel d'instructions, peut provoquer des interférences nuisibles aux communications radio.

Le fonctionnement de cet équipement dans une zone résidentielle est susceptible de provoquer des interférences nuisibles, auquel cas l'utilisateur devra corriger les interférences à ses propres frais.

## ATTENTION :

Tout changement ou modification, non expressément approuvé par le responsable de la conformité, peut révoquer l'autorité de l'utilisateur à employer l'appareil en question.

## Avertissement relatif aux expositions RF

Cet appareil doit être installé et utilisé en accord avec les instructions fournies et les antennes utilisées pour cet émetteur doivent être installées de façon à fournir une distance de séparation d'au moins 20 cm par rapport à toute personne, et elles ne doivent pas être co-localisées ni opérées en conjonction avec d'autres antennes ou émetteurs. Les utilisateurs finaux et les installateurs doivent recevoir les instructions d'installation des antennes et les conditions d'utilisation de l'émetteur pour satisfaire à la conformité aux expositions RF.

**Nom du fabricant**            **DynaScan Technology Corp.**

**Adresse du fabricant**    **6F, No. 88 Wenmao Rd., Guishan Dist, Taoyuan City 333001, Taiwan**



Cet appareil est conforme à la **directive 2014/53/UE** émise par la Commission de la Communauté européenne.

L'article (a) EN 62368-1	L'article (b) EN 55032 Class A EN 61000-3-2:2014 EN 61000-3-3:2013 EN 55035:2017 EN 301 489-1 Class A EN 301 489-17
-----------------------------	---

## - Bandes de fréquences et puissances

a. WIFI 2,4G-2412~2462MHz.

b. La puissance radiofréquence maximale transmise dans la bande 2,4 GHz est de 50 mW

# Safety Precautions

<b>CAUTION</b>	
	Do not install near flammable material or any heat sources.
	Do not defeat the safety purpose of the grounding-type plug.
	Do not disassemble the display to avoid electrical shock or burn.
	Normal operating condition considers installation at an altitude below 2000m; some abnormalities may be experienced when installed at an altitude above 2000m.

<b>WARNING</b>	
	Please power off the LCD and the video source before plugging in the DP or HDMI cable.
	Please installed the display in well-ventilated place, do not install in a confined space.
	Suitable for mounting on concrete or other non-combustible surface only.
	If it gives off smoke, strange smell, or unusual noise, or when it gets too hot to touch, immediately unplug the display and contact the dealer.
	Clean only with soft, dry cloth but not use chemical liquids, and unplug while cleaning.
	Do not use extreme force or any sharp or pointed objects to touch the display.
	Do not drop or allow any object to fall to the display.
	Do not operate the display with wet hands to avoid electric shock.
	Do not discard this product with general household waste. Please be sure to comply with the local waste regulations.
	This device uses, generates and radiated radio frequency energy. The radio frequency energy produced by this device is well below the maximum exposure allows by Federal Communications Commission (FCC).
	When a stationary or fixed image is displayed on the screen for a long time, the image may be permanently imprinted on the screen. This phenomenon is known as image burn-in and is not covered by the manufacturer's warranty.
	In order to avoid burn-in, avoid prolonged display of static or fixed images on the screen.
	Power supply cord must not be attached to the building surface, nor run through walls, ceilings, floors and similar openings in the building structure.
Power cord shall be connected to a socket-outlet with earthing connection.	

## Précautions relatives à la sécurité

PRÉCAUTIONS	
	N'installez pas à proximité de matériaux inflammables ou de sources de chaleur.
	Ne pas compromettre la sécurité de la fiche de mise à la terre.
	Pour éviter tout choc électrique ou la brûlure, ne démontez pas l'écran.
	Le produit peut normalement être utilisé à une altitude inférieure à 2000 m. Des anomalies peuvent survenir lors de l'installation de l'appareil à une altitude supérieure à 2000 m.

AVERTISSEMENT	
	Veillez éteindre l'écran LCD et la source vidéo avant de brancher le câble DP ou HDMI.
	Veillez installer l'écran dans un endroit bien ventilé, pas dans un espace confiné.
	Convient pour le montage sur du béton ou autre surface non combustible uniquement.
	S'il dégage de la fumée, une odeur étrange ou un bruit inhabituel, ou s'il est trop chaud au toucher, débranchez immédiatement l'écran et contactez le revendeur.
	Nettoyez uniquement avec un chiffon doux et sec, sans utiliser de produits chimiques, et débranchez-le pendant le nettoyage.
	N'exercez pas une force excessive et n'utilisez pas d'objets tranchants ou pointus pour toucher l'écran.
	Ne laissez pas tomber l'écran et ne laissez aucun objet tomber dessus.
	Afin d'éviter tout choc électrique, n'utilisez pas l'écran avec les mains mouillées.
	Ne jetez pas ce produit avec les déchets ménagers. Assurez-vous de respecter les réglementations locales en matière de déchets.
	Cet appareil utilise, génère et rayonne de l'énergie radiofréquence. L'énergie de radiofréquence produite par cet appareil est bien inférieure à l'exposition maximale autorisée par la FCC (Federal Communications Commission).
	Lorsqu'une image immobile ou fixe est affichée sur l'écran pendant une longue période, l'image peut être imprimée de manière permanente sur l'écran. Ce phénomène est connu sous le nom d'image rémanente et n'est pas couvert par la garantie du fabricant.
	Afin d'éviter toute détérioration, évitez l'affichage prolongé d'images statiques ou fixes sur l'écran.
	Le cordon d'alimentation ne doit pas être connecté à la surface du bâtiment, ni traverser les murs, les plafonds, les planchers et les ouvertures similaires du bâtiment.
	Le cordon d'alimentation doit être connecté à une prise électrique mise à la terre

# Important Safety Information

---

- Disassembling the LCD is strictly prohibited. Opening the cover may expose the user to electric shock or other hazards. Please contact DynaScan certified service professionals for all maintenance requirements.
- Do not allow any liquid to enter the LCD. Also avoid placing the LCD close to water sources.
- Do not place heavy objects on the power cord. A damaged power cord might cause electric shock or fire.
- Do not bend, twist, or damage the power cord.
- The power cord must comply with the local safety regulations.
- Do not damage or modify the prongs/pins and the ground contact on the power cord plug.
- Do not place the LCD on an unlevelled surface or an unstable vehicle. The LCD could fall over and cause substantial damage.
- Do not cover the vents and/or the heat sink.
- Do not install the LCD beside radiators or other heat sources. The installation site should have sufficient ventilation so the heat generated by the LCD can be dissipated.
- Do not use the Signage in a hot, humid, dusty, or fummy environment.
- Handle the LCD with care. Save the packaging materials for transport later.
- Clean the LCD backside at least once a month for dust and other particles.

**Unplug the LCD immediately and contact a DynaScan certified service professional as soon as possible when any of the following situations occurs:**

- Damaged power cord or power plug.
- If liquid or foreign object has entered the LCD.
- If the LCD has been exposed to rain or water.
- If the LCD has been dropped or the casing has become damaged.
- If any structural damage such as cracks or unnatural vibration is found.
- If the LCD cannot be operated following the steps outlined in this manual.
- If the LCD emits smoke or other odors, or generates strange noises.

## Operating Suggestions

- Avoid displaying a stationary image for a long period of time in order to prevent image sticking.

## Cleaning the Panel

- Use a soft, lint-free cloth to gently wipe the dust off from the screen panel.
- Do not use any hard material to wipe the panel.
- Do not poke the panel with your hand or any sharp object (such as a pen or a nail) or exert excessive pressure on the panel to prevent any damage.
- Do not use any cleaning solutions on the panel as it might cause discoloration.

## Cleaning the Casing

- Unplug the power cord.
- Gently wipe the casing with a soft cloth.

## Attention

- Do not use any of the following solutions to clean the casing as they may damage the paint and cause it to crack or peel: benzene solution, alkaline solution, alcohol-based cleaning solution, glass cleaner, wax, polisher, or detergent.



# Informations importantes relatives à la sécurité

---

- Le démontage de l'écran LCD est strictement interdit. L'ouverture du capot peut exposer l'utilisateur à un choc électrique ou à d'autres dangers. Veuillez contacter des professionnels de service certifiés DynaScan pour tous les besoins de maintenance.
- Ne laissez aucun liquide pénétrer dans l'écran LCD. Évitez également de placer l'écran LCD à proximité de sources d'eau.
- Ne placez aucun objet lourd sur le cordon d'alimentation. Un cordon d'alimentation endommagé peut provoquer un choc électrique ou un incendie.
- Ne pliez pas, ne tordez pas et n'endommagez pas le cordon d'alimentation.
- Le cordon d'alimentation doit être conforme aux réglementations locales de sécurité.
- Veillez à ne pas endommager ni modifier les broches ou le contact de terre sur la fiche du cordon d'alimentation.
- Ne placez pas l'écran LCD sur une surface qui n'est pas de niveau ou sur un véhicule instable. L'écran LCD pourrait tomber et causer des dégâts importants.
- Ne couvrez pas les orifices de ventilation et / ou le dissipateur de chaleur.
- N'installez pas l'écran LCD à côté de radiateurs ou d'autres sources de chaleur. Le site d'installation doit disposer d'une ventilation suffisante pour que la chaleur générée par l'écran LCD puisse être dissipée.
- N'utilisez pas l'affichage signalétique dans un environnement chaud, humide, poussiéreux ou enfumé.
- Manipulez l'écran LCD avec soin. Conservez les matériaux d'emballage pour tout transport ultérieur.
- Nettoyez l'arrière de l'écran LCD au moins une fois par mois afin d'éliminer la poussière et autres particules.

## **Débranchez immédiatement l'écran LCD et contactez un réparateur professionnel certifié DynaScan dès que possible lorsque l'une des situations suivantes se produit :**

- Cordon d'alimentation ou fiche d'alimentation endommagé.
- Si du liquide ou un corps étranger est entré dans l'écran LCD.
- Si l'écran LCD a été exposé à la pluie ou à l'eau.
- Si l'écran LCD est tombé ou si le boîtier a été endommagé.
- Si vous constatez des dommages structurels comme des fissures ou des vibrations non naturelles.
- Si l'écran LCD ne peut pas être utilisé en suivant les étapes décrites dans le présent manuel.
- Si l'écran LCD émet de la fumée ou d'autres odeurs, ou génère des bruits étranges.

## **Suggestions d'utilisation**

- Évitez d'afficher une image immobile pendant une période prolongée afin d'éviter que la rémanence d'image.

## **Nettoyage du panneau**

- Utilisez un chiffon doux non pelucheux pour essuyer délicatement la poussière du panneau de l'écran.
- N'utilisez aucun matériau dur pour essuyer le panneau.
- Afin d'éviter tout dommage, n'appuyez pas sur le panneau avec votre main ou un objet pointu (comme un stylo ou un ongle) et n'exercez pas de pression excessive sur le panneau.
- N'utilisez aucune solution de nettoyage sur le panneau car cela pourrait provoquer une décoloration.

«Danger de stabilité» ou libellé équivalent;

«Le moniteur peut tomber, entraînant des blessures graves ou mortelles» ou texte équivalent;

Le texte suivant ou équivalent:

Pour éviter les blessures, ce moniteur doit être solidement fixé au sol / mur conformément aux instructions d'installation.



# Getting Started

## Contents

Confirm that the accessories below are shipped along with the display. If any item is missing, please contact your dealer. The color and shape of the accessories may vary with the products.

- DS552LT6-2 Professional LCD.
- Remote Control x 1 pc.
- Batteries (1.5V / AAA) x2 pcs.
- Power cable x1 pc.
- Quick Start Guide x1 pc.
- ESK302 x1 pc.

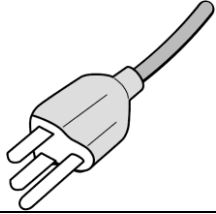
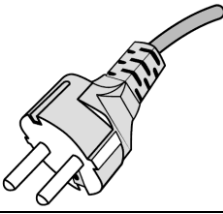
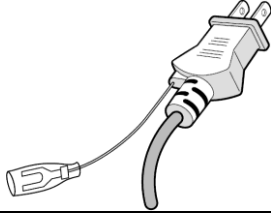
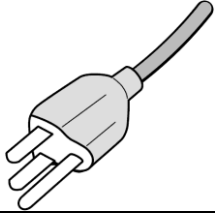
**Attention:** Please use the following table to check whether the included power cord is suitable for your region. If the power cord does not match your region, please contact your local supplier. Please use matching AC socket in order to meet your local safety regulations.

Plug Type	North America	European Continental	Japan	Taiwan
Plug Shape				
Region	U.S.A. / Canada	EU (Except U.K.)	Japan	Taiwan
Voltage	120V	230V	100V	110V
NEMA TYPE	NEMA 5-15	CEE 7/7	NEMA 1-15	NEMA 5-15
IEC Display Plug				
IEC Plug TYPE	IEC320 C13			

## Installing and Replacing Remote Control Batteries

1. Open the battery compartment cover.
2. Insert 2 new AAA batteries.
3. Close the battery compartment cover.

### Warning:

- Incorrect usage of batteries may cause leakage or explosion.
- Pay attention to the polarity when installing the batteries.
- Do not mix different types of batteries or new and used batteries. Doing so may shorten the battery life or cause leakage.
- Remove or replace the batteries when they are empty in order to prevent acid leaking in the battery compartment.
- Do not touch the leaked substance from the batteries in case of a battery leakage. Doing so may hurt human skin.

**Note:** If the remote control is not going to be used for a long time, we recommend removing the batteries from the remote control.



# Bien débiter

## Contenu

Vérifiez que les accessoires ci-dessous sont fournis avec l'écran. Si l'un d'eux est manquant, veuillez contacter immédiatement votre revendeur. La couleur et la forme des accessoires peuvent varier selon les produits.

- Écran LCD DS552LT6-2 Professional.
- Télécommande x 1
- Piles (1,5V / AAA) x 2
- Câble d'alimentation x 1
- Guide de démarrage rapide x 1
- ESK302 x1 pc.

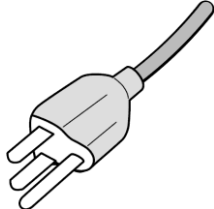
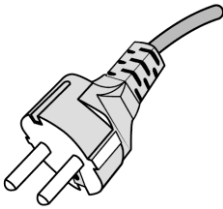
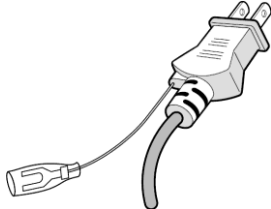
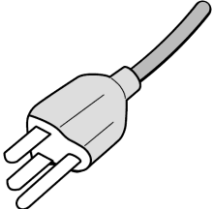
**Attention :** Veuillez utiliser le tableau suivant afin de vérifier que le cordon d'alimentation fourni est adapté à votre région. Si le cordon d'alimentation ne correspond pas à votre région, veuillez contacter votre fournisseur local. Veuillez utiliser la prise secteur correspondante afin de respecter les réglementations locales de sécurité.

Type de fiche	Amérique du Nord	Europe continentale	Japon	Taiwan
Forme de la fiche				
Région	États-Unis / Canada	UE (Hors R.-U.)	Japon	Taiwan
Tension	120V	230V	100V	110V
TYPE NEMA	NEMA 5-15	CEE 7/7	NEMA 1-15	NEMA 5-15
Fiche d'affichage CEI				
TYPE fiche CEI	IEC320 C13			

## Mise en place et remplacement des piles de la télécommande

1. Ouvrez le couvercle du logement à piles.
2. Insérez 2 nouvelles piles AAA.
3. Fermez le couvercle du logement à piles.

### Avertissement :

- Une mauvaise utilisation des piles peut provoquer des fuites ou une explosion.
- Faites attention à la polarité lors de l'installation des piles.
- Ne mélangez pas différents types de piles ou des piles neuves et usagées. Cela pourrait raccourcir la durée de vie des piles ou causer des fuites.
- Retirez ou remplacez les piles lorsqu'elles sont vides afin d'éviter toute fuite d'acide dans le logement à piles.
- Ne touchez pas la substance qui s'écoule des piles en cas de fuite. Cela pourrait blesser la peau.

**Remarque :** Si la télécommande ne doit pas être utilisée pendant une période prolongée, nous vous recommandons d'en retirer les piles.

# Installation

---

*The LCD must be properly installed using a wall mount. Incorrect installation may cause injury or damage the equipment. Product warranty does not cover the damage caused by improper installation and DynaScan shall not be held responsible in such incident. Refer to the mount manufacturer's instructions for proper installation.*

## Mounting

- We recommend for at least four people to handle and mount the display.
- Mounting the Professional LCD on the wall is the responsibility of the user. Not all walls provide enough strength to support the LCD. The LCD may drop and cause serious injury if it is mounted on a slanted wall. Product warranty does not cover improper installation, modification, or damage caused by natural disasters. DynaScan recommends having certified professionals to evaluate the installation site and perform the mounting operation.
- Do not to cover the vent and/or the heat sink in order to ensure proper heat dissipation.
- Refer to the installation guide provided by the manufacturer for proper mounting.

### When mounting on a wall

- A wall mount is not included in the accessory. Please purchase a VESA Standard wall mount to secure the LCD. DynaScan is not responsible for the damage caused by using non-standard wall mounts.
- Verify that the mounting location can support the weight of the LCD before installation.
- The installation angle must be within 15 degrees of the vertical axis.
- Do not install the wall mount while the power is turned on as it may cause serious injury due to electrical shock.

Model Number	VESA (mm)		Screw Specification	Screw Length	Number
DS552LT6-2	(A * B)	400 * 400	M6	Greater than 10mm Smaller than 12mm (not including wall mount thickness)	4

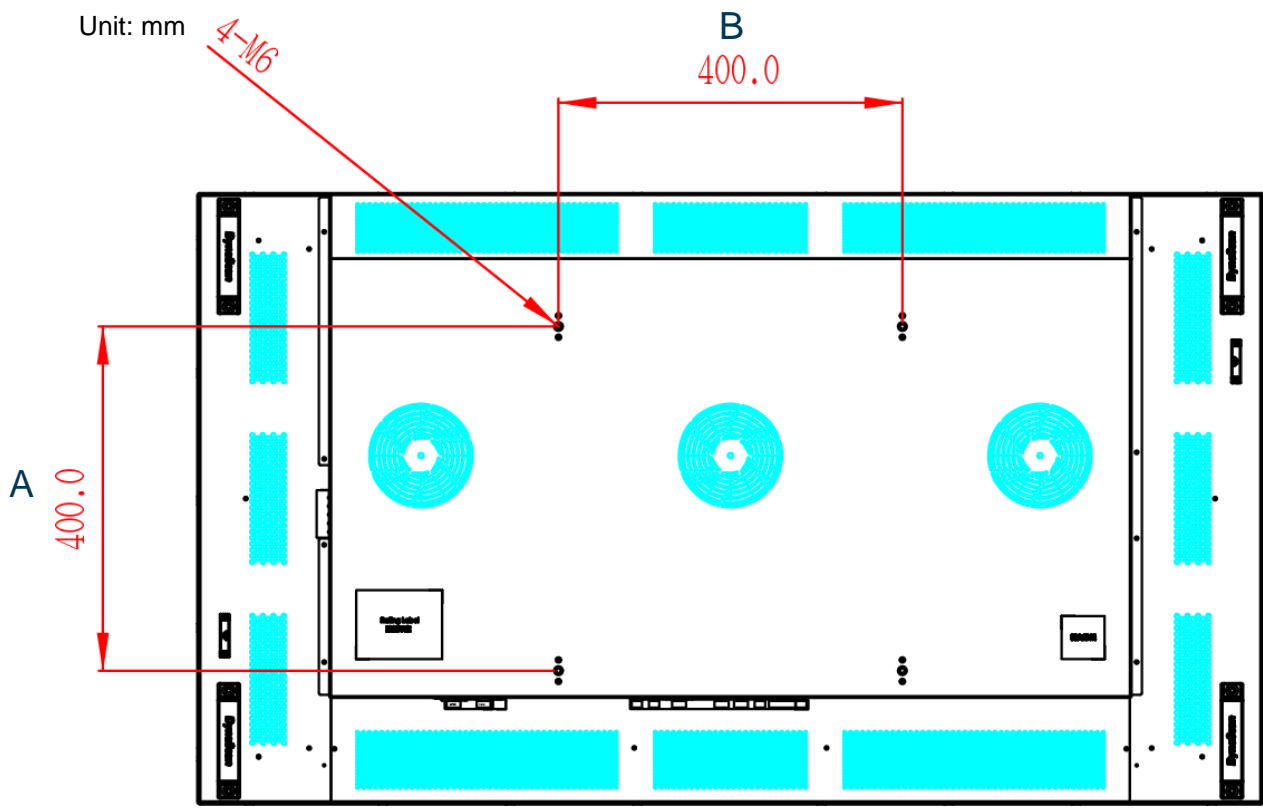

**Orientation**

- When used in the portrait orientation, the LCD should be rotated clockwise when looking at the front of the display such that the left edge becomes the top edge.

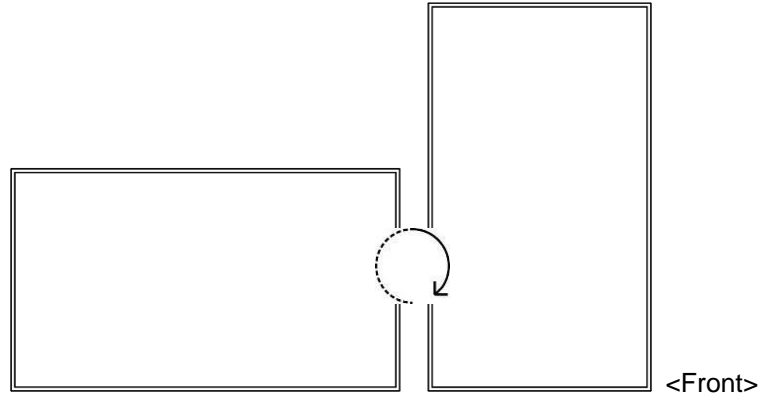

Portrait mode: Rotate the set clockwise 90° (mandatory)

- The orientation sticker can be found on the rear of display, which is for distinguishing the direction of installation.

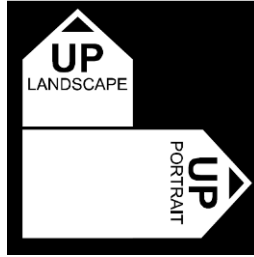

### Installation Location

- The wall and mount must have enough strength to support the LCD and its accessories.
- Do not install in a location with strong vibrations or dusty.
- Do not install near the building's main electric panel.
- Ensure the LCD is secured in such a manner that it cannot be easily removed by the general public.
- Leave clearance around the outer edge of the LCD (or video wall matrix) from other objects to ensure proper ventilation.
- For installations with screens inset into the wall, refer to section: Enclosures for cooling and ventilation considerations.

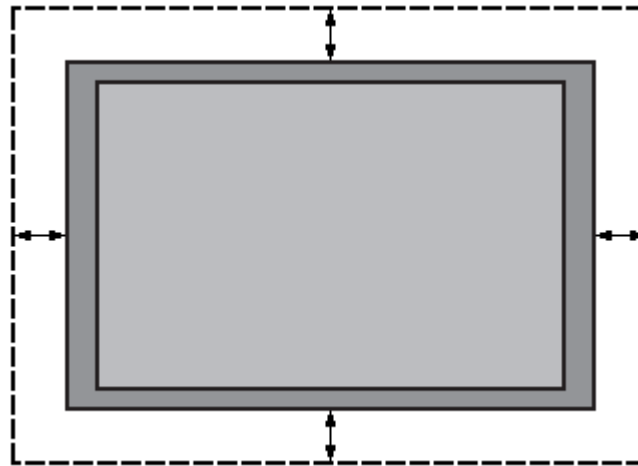

Single display

### Maintenance

- Inspect the fasteners regularly for signs of loosening or deformation. Please perform appropriate corrective measures when a problem is identified. Neglecting the problem may worsen the situation.
- Increase the inspection frequency on areas where previous maintenance had occurred to ensure the problems do not occur again.

## Wall Mounting

- A wall mount is not included. Please purchase a VESA Standard wall mount to secure the LCD. DynaScan is not responsible for damages caused by using non-standard wall mounts.
- Verify that the mounting location can support the weight of the LCD before installation.
- The installation angle must be within 15 degrees of the vertical axis.
- Do not install the wall mount while the power is turned on as it may cause serious injury from electrical shock.

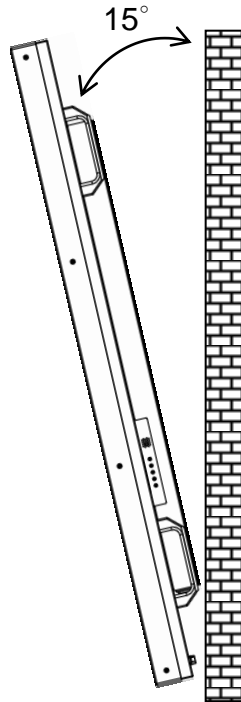

## Connecting to a Power Source

Using the power cable provided, plug it in the power inlet on the back of the display shown in the diagram below. Connect the power cable to a 100-240 volt, 50 / 60Hz AC power outlet.

 Insert the plug completely into the socket. A loose power connection may cause damage to the display and/or lead to a fire hazard.

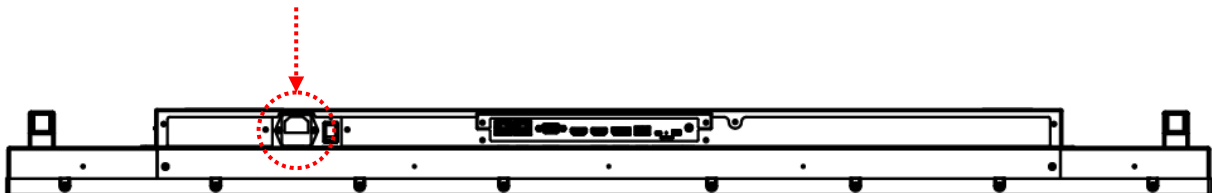

# Connecting an External Video Source

Turn OFF the power of both LCD and external video device. Using the DP cable (or HDMI cable) provided, insert one end into the DP-IN (or HDMI 1-IN, HDMI 2-IN) on the back of the display shown the in the diagram below. Connect the other end of the DP cable (HDMI cable) to the DP output (or HDMI output) of the video source. Refer to your video device's manual for additional information.

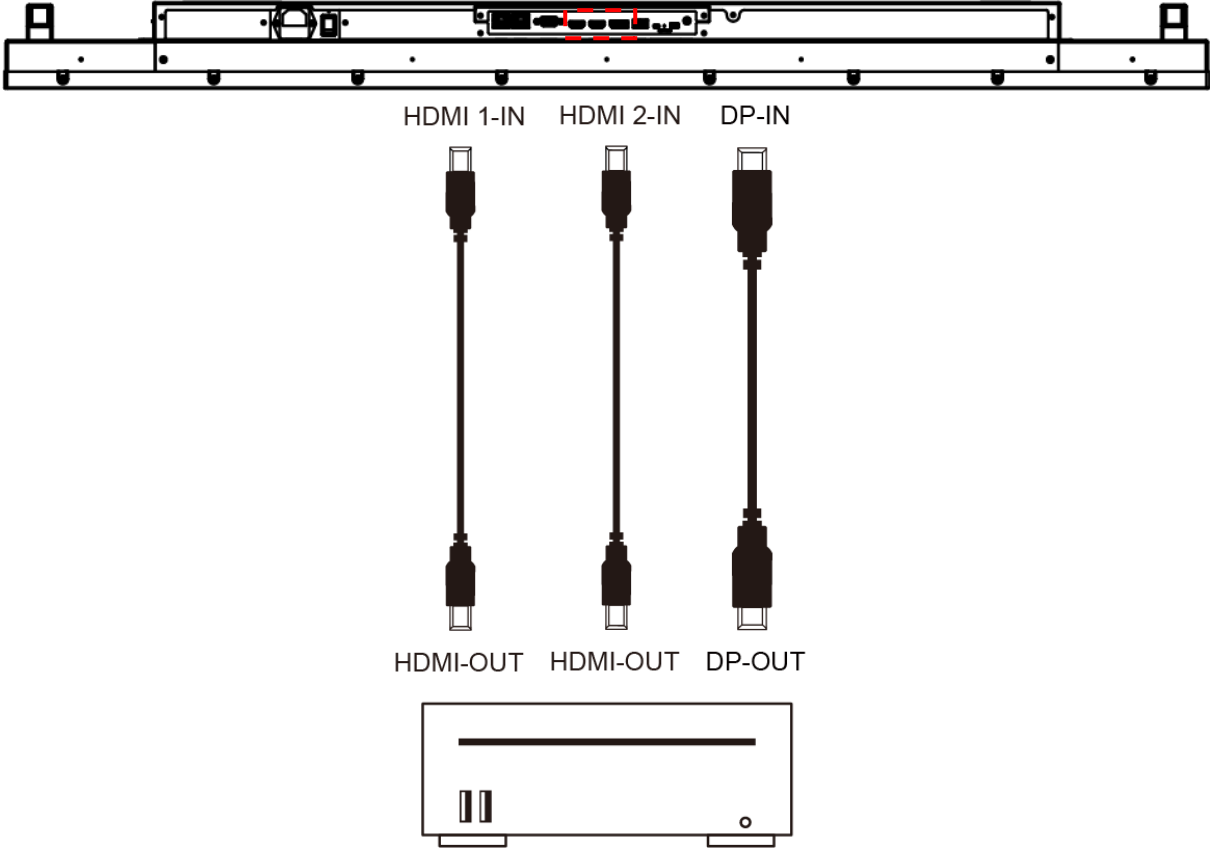



## Input / Output Terminals

- A. **AC (IN):** Connect the supplied power cord to the wall outlet.
- B. **Power Switch:** Press to switch the main power on/off.
- C. **RJ-45 1 (IN):** RJ45 network input connection.
- D. **RJ-45 2 (IN):** RJ45 network input connection.
- E. **RS-232 (IN):** RS232C network input connection for remote control from PC.
- F. **HDMI 1 (IN):** Connect the HDMI output of a PC or an AV device via a HDMI cable.
- G. **HDMI 2 (IN):** Connect the HDMI output of a PC or an AV device via a HDMI cable.
- H. **DP (IN):** Connect the DP output of a PC or an AV device via a DP cable.
- I. **USB 3.0 port:** Support for USB flash drive storage, mouse and keyboard.
- J. **Extension Connector:** Extension Connector for optional IR Extension sensor kit (ESK302).
- K. **Micro SD card:** Support for up to 128GB, FAT32 format is supported.
- L. **Thermal:** Extension Connector for optional Extension thermal kit (ETK203).
- M. **Audio (OUT):** Connect the audio signal output from Audio IN jack to an external AV device.

*\*USB 3.0 port: A standardized port to connect a variety of devices like mouse, keyboard, and flash drive. Support USB storage devices formatted with NTFS, FAT32 (32G) file system.*

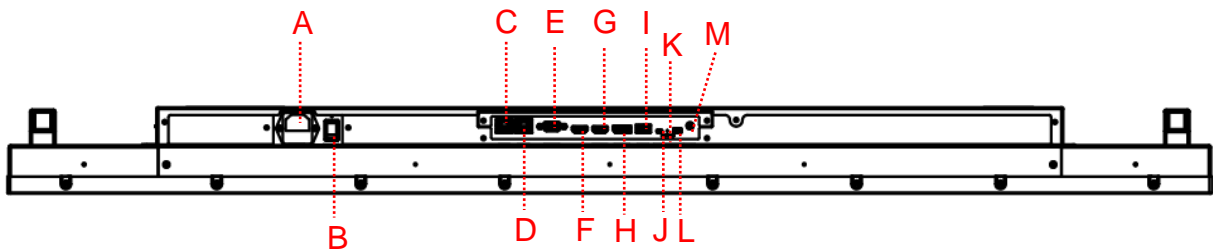

# Operating Instructions

---

## Powering On/Off the Display

To turn on/off the display, press the power switch on the back of the display as shown in the diagram below.

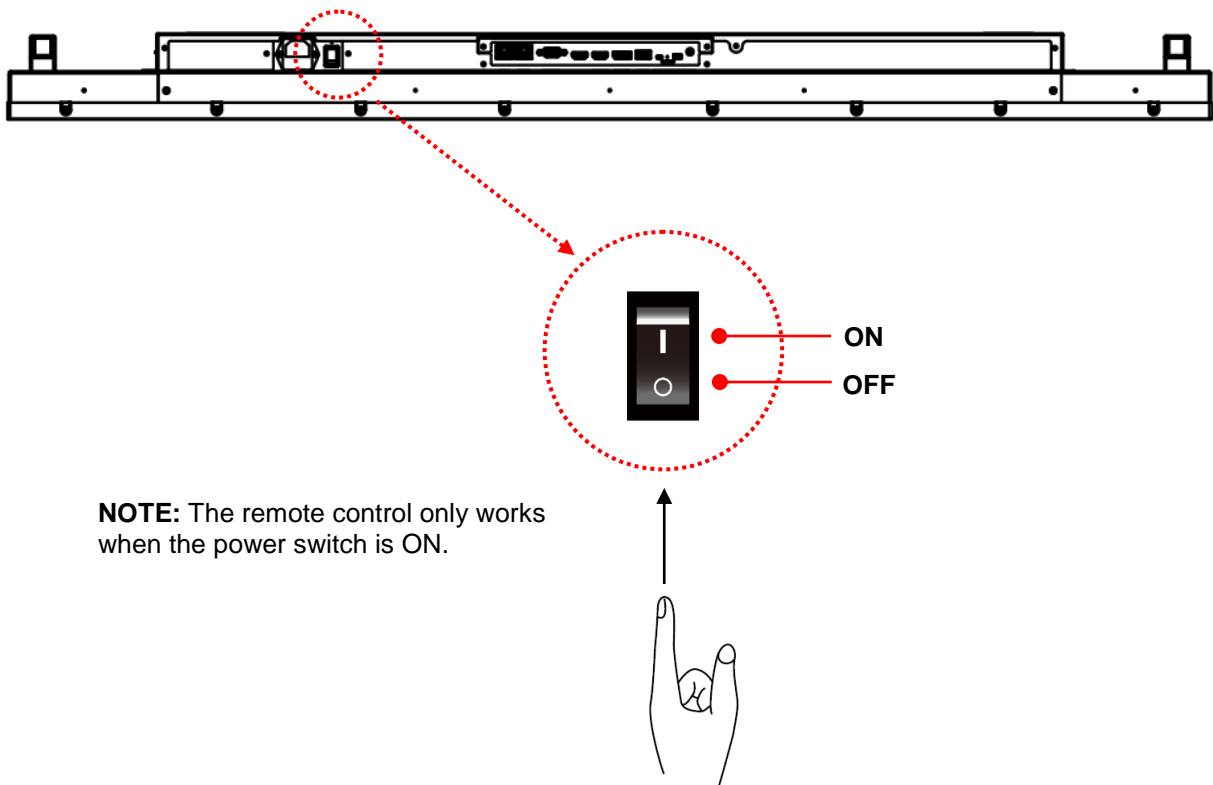

**NOTE:** The remote control only works when the power switch is ON.

## Using the Remote Control

### Connection using an External Sensor Kit (ESK302)

Connect the ESK302 cable to the mini USB port on the side of the display, and aim the remote at the IR receiver as shown below. Meanwhile, the IR receiver on the display will be disabled. The operating range of the remote control is 2.5 meters (8 feet).

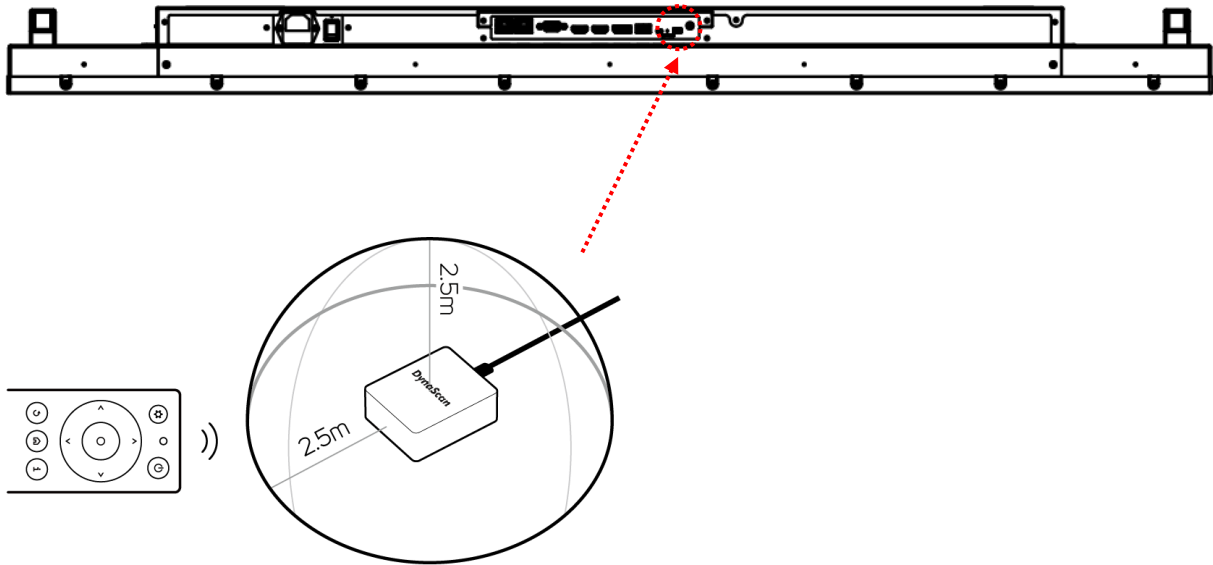

**NOTE:** Ambient light may affect the performance of the remote control. Avoid fluorescent or neon lights in the vicinity.

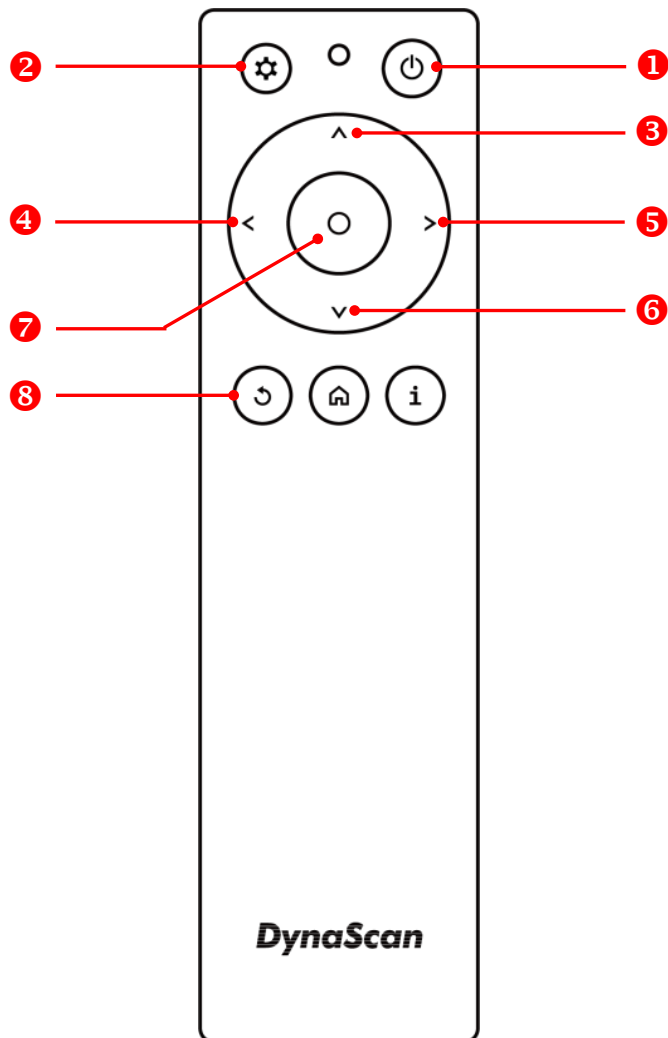

\*Color and shape may vary by model.

ITEM		DESCRIPTION
①	POWER	Power On / Off
②	MENU	OSD On / Off
③	UP	Move the cursor up or change the setting of selected item.
④	LEFT	Exit the current selection.
⑤	RIGHT	Select the highlighted item.
⑥	DOWN	Move the cursor down or change the setting of selected item.
⑦	OK	Enter (for DSM365 only)
⑧	BACK	Return to the last page. (for DSM365 only)

## Using the built-in keypad

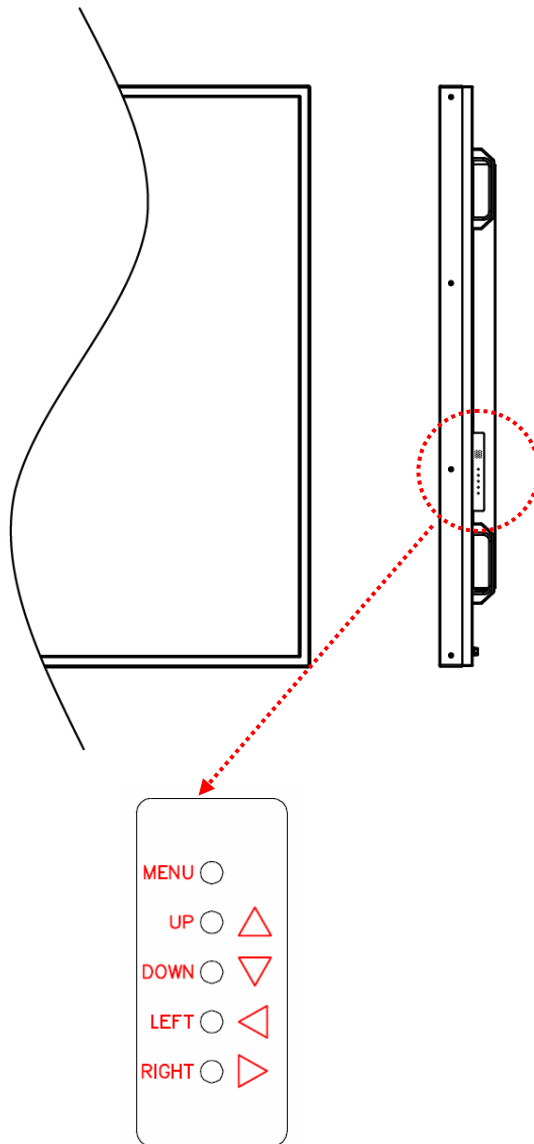

ITEM	DESCRIPTION
MENU	OSD On / Off, Power On / Off.
UP	Move the cursor up or change the setting of selected item.
DOWN	Move the cursor down or change the setting of selected item.
LEFT	Exit the current selection.
RIGHT	Select the highlighted item.

# Navigating the On Screen Display (OSD) Menu

Press the MENU button on the built-in keypad or remote control to show the OSD. Use the navigation arrows to select and adjust the menu items.

\*The change of each setting can only enable when you press “LEFT” (refer to p.19) to back to the last menu layer.

## 1. Input Source



ITEM 1	ITEM 2	DEFAULT	DESCRIPTION
Input Source	Main	HDMI 1	Set the Main input to display.
	Failover 1	HDMI 2	Set the Failover 1 input to display.
	Failover 2	DP	Set the Failover 2 input to display.
	Failover 3	DSM365	Set the Failover 3 input to display.
	Command Detection	Off	Only effective in Main input source. If the display didn't get both of command and the input signal, it will change to Failover1 input.

## 2. Picture

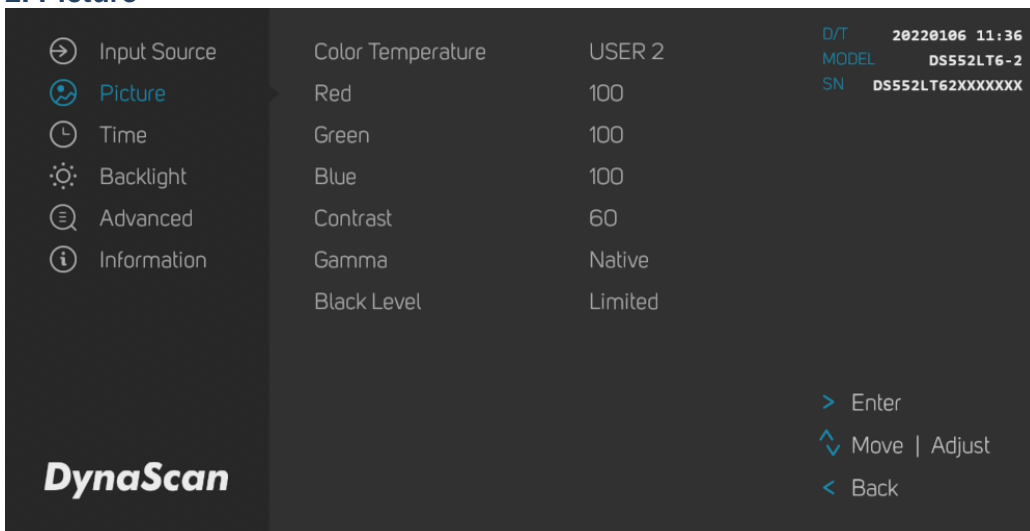

ITEM 1	ITEM 2	DEFAULT	DESCRIPTION
Picture	Color Temperature	USER 2	Select the color temperature. (User2, User1, D93, D65 and D55).
	Red		Adjust the red light level. Range 0 – 100. <b>Note:</b> The feature is only supported on User2 mode.
	Green		Adjust the green light level. Range 0 – 100. <b>Note:</b> The feature is only supported on User2 mode.
	Blue		Adjust the blue light level. Range 0 – 100. <b>Note:</b> The feature is only supported on User2 mode.
	Contrast	60	Adjust the contrast level. Range 0 – 100.
	Gamma	Native	Adjusts the Gamma value. (Native, 2.2, 2.4 and sGamma)
	Black Level	Limited	Selects the black level to adjust the screen gray scale. "Limited" for video source uses 16 to 235 levels for R/G/B, such as HDMI. "RGB Full" for video source uses all levels from 0 to 255 levels. "Auto" is for detecting the video source to determine its value is applicable for "Limited" or "RGB Full".

### 3. Time

Input Source      Current Date      2022/01/06      D/T      20220106 11:36  
 Picture      Current Time      11:36      MODEL      DS552LT6-2  
**Time**      Day of Week      Thursday      SN      DS552LT62XXXXXX  
 Backlight      Time Zone      GMT+08:00  
 Advanced      Power Control Time      OFF  
 Information      On Time      08:00  
                          Off Time      18:00

> Enter  
 ⬆️ Move | Adjust  
 < Back

**DynaScan**

ITEM 1	ITEM 2	DEFAULT	DESCRIPTION
Time	Current Date		Set the date.
	Current Time		Set the clock. <b>Note:</b> The internal clock will continue to function when the power is turned off.
	Day of Week		Set the day of week. (Monday to Sunday)
	Time Zone		Set the Time Zone.
	Power Control Timer	Off	Automatic power on / off schedule function.
	On Time	08:00	Set turn-on time.
	Off Time	18:00	Set turn-off time.

#### 4. Backlight

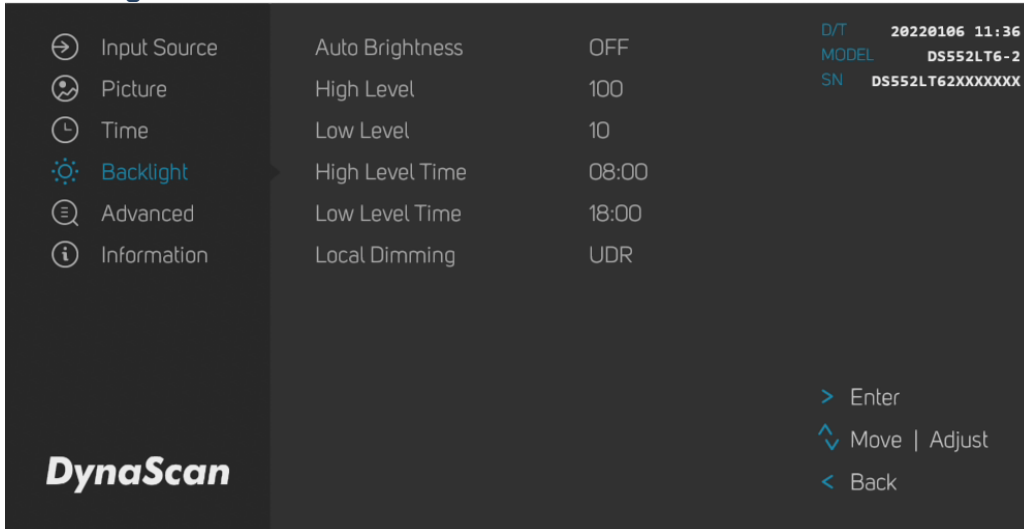

ITEM 1	ITEM 2	DEFAULT	DESCRIPTION
Backlight	Auto Brightness	Off	<p>A. If the AUTO BRIGHTNESS is “Off”, the screen brightness will remain at HIGH LEVEL brightness value.</p> <p>B. If the AUTO BRIGHTNESS is “Auto”, the brightness of display will be adjusted according to the ambient light. When ambient light is bright, the screen will adjust to the High Level brightness value set; when ambient light is dark, the screen will adjust to the Low Level brightness value set.</p> <p>C. When the Timer (“High Level Time” &amp; “Low Level Time”) mode is set, the display will automatically switch the brightness according to the time set.</p> <p>D. When setting “Mix” mode, Timer and Light sensor will work at this mode. For example, setting "High Level Time = 8:00am" and "Low Level Time = 6:00pm", the light sensor will detect environment brightness and then display will adjust the value of High Level during 8:00am and 6:00pm.</p>
	High Level	100	Adjusts the highest brightness level. Range 0 – 100.
	Low Level	10	Adjusts the lowest brightness level. Range 0 – 100.
	High Level Time	08:00	Set high level time.
	Low Level Time	18:00	Set low level time.
	Local Dimming	UDR	Adjusts the contrast. UDR is the highest contrast. Local Dimming 1 is the lowest contrast. (Local Dimming 1/2, UDR)



## 5. Advance

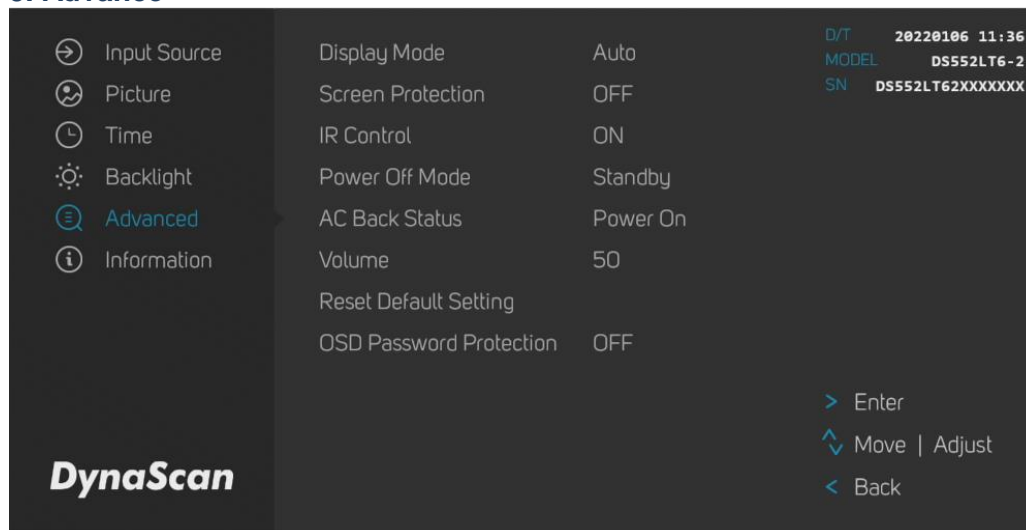

ITEM 1	ITEM 2	DEFAULT	DESCRIPTION
Advance	Display Mode	Auto	Change the Menu orientation. The Menu can be displayed in either LANDSCAPE, or PORTRAIT mode.
	Screen Protection	Off	Turn on / off image burn-in protection. Set image burn-in protection interval. Range 0 – 100 minutes.
	IR Control	On	Enable/disable the remote control for Menu. <b>Note:</b> When disabled, the remote control function can be enabled again from the control panel on the display or through the DynaScan “Display Manager” application.
	Power Off Mode	Standby	Standby: Background processes are still running, and remote control in normal operation.  Sleep: When placed in sleep mode, background processes and remote control are not running. The display is at a minimum power state which helps conserve power when the device is not in use. IR/ Keypad working normally. Only [Keypad] on the display or [Power Button] on the remote control can wake up the display.
	AC Back Status	Power On	Choose to use the AC back status function. <u>Power On:</u> Display booting up when the power back after an outage. <u>Standby:</u> Display keeps soft-off status when the power back after an outage. <u>Memory:</u> Display will back to the last state when the power back after an outage.
	Volume	50	Set volume. Range 100 – 0.
	Reset Default Setting	Off	Restore all settings to default. <b>Note:</b> It does not modify CURRENT DATE, CURRENT TIME, DATE OF WEEK,

			TIME ZONE, POWER ON TIME and POWER OFF TIME.
	OSD Password Protection	Off	Turn On: Create Password > Confirm Password > Password Protection On Turn Off: Enter Password > Password Protection Off
	Reset OSD Password		Enter Password > Enter New Password > Confirm New Password > Success

## 6. Information

ITEM 1	ITEM 2	DEFAULT	DESCRIPTION
Information	Model	DS552LT6-2	The display's model.
	SN		The display's serial number.
	Resolution		Input resolution
	MCB Version		The MCB version.
	FW Version		The F/W version.
	Fan Status		<u>Good</u> : Fan under normal working conditions <u>NG</u> : A malfunction of the fan system.
	Cabinet Temp.		LCD inner (backlight unit) temperature monitoring.
	Ambient Temp.		LCD Ambient temperature monitoring.
	ETK Temp.		The Extension Thermal Kit (ETK203) is for ambient temperature monitoring.

Some functions may not be available for all models.

# Specifications

MODEL		DS552LT6-2
PANEL	LCD Panel Size	54.64 inches
	Native Resolution	1920 x 1080
	Brightness	5,500 cd/m <sup>2</sup> (Typ.)
	Contrast Ratio	3,000:1
	Response Time	8 ms (Typ.)
	Viewing Angle	178°/ 178°
	Life Time	100,000 hrs (Typ.)
	Panel Surface	AG Haze 3%, 2H
POWER	Power Supply	Internal
	Rated Voltage	100 - 240V, 50 / 60Hz
	Power On Mode	300W (Typ.) / 400W (Max.)
	Standby Mode	< 1W
MECHANICAL SPECS	Bezel Width (T/B/L/R)	10.9/10.9/10.9/10.9 mm
	Cabinet Color	Black
	Monitor Dimension (LxHxD)	1240 x 710.4 x 87.7 mm
	Monitor Weight (set / package)	29.5 kg / 34.5 kg
	VESA Mounting (Dimension)	4 Holes (400x800 mm)
USER INTERFACE	OSD Language	English
ENVIRONMENT	Operation Temperature	0°C ~ 45°C
	Storage Temperature	-20°C ~ 60°C
	Humidity	10%~80% RH Non-Condensing
I/O Ports	HDMI	IN *2
	DP	IN *1
	RS-232	IN *1
	Audio	OUT *1
	USB port	IN *1
	RJ-45	IN *2
	Micro SD Slot	IN *1
	Extension Connector (Mini USB)	IN *1 (ESK only)
Fuse		6.3A



Design and specifications are subject to change without notice.

# Input Mode

Active Resolution		Refresh Rate
H Pixels	V Lines	
640	480	60 Hz
720	480	60 Hz
800	600	60 Hz
960	600	60 Hz
1024	768	60 Hz
1280	720	60 Hz
1280	768	60 Hz
1280	960	60 Hz
1280	1024	60 Hz
1366	768	60 Hz
1400	1050	60 Hz
1440	900	60 Hz
1600	1200	60 Hz
1680	1050	60 Hz
1920	720	60 Hz
1920	1080	60 Hz

# Pin Assignments

---

## RS-232 Input

PIN No.	NAME
01	Connected to 7&8
02	TXD
03	RXD
04	Connected to 6
05	GND
06	Connected to 4
07	Connected to 1&8
08	Connected to 1&7
09	NC

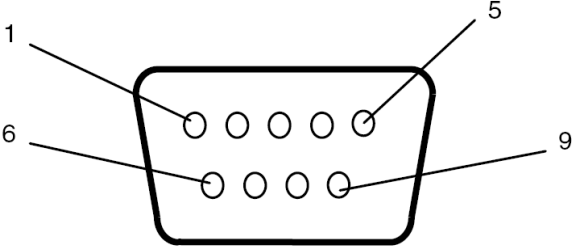

# Troubleshooting

ISSUE	RECOMMENDED SOLUTION
No image is displayed.	<ul style="list-style-type: none"> <li>● Check whether the cable is completely plugged in.</li> <li>● Check whether the main switch is in the ON position, and the power cord is completely plugged in.</li> <li>● Check whether the image source's resolution is set as the supported format (refer to section "Input Mode", p.27).</li> <li>● Check whether the cable is damaged or bent excessively.</li> </ul>
Nothing happens when switching the main switch on.	<ul style="list-style-type: none"> <li>● Unplug the power cord from the socket and plug it in again after a few seconds to reset the Signage.</li> </ul> <p><b>Note:</b> Unplugging the power cord will not change the settings.</p>
Image is unstable.	<ul style="list-style-type: none"> <li>● Check whether the cable is completely plugged in.</li> </ul>
The remote control does not work.	<ul style="list-style-type: none"> <li>● Check whether there are batteries in the remote control.</li> <li>● Check the batteries for freshness, polarity, etc.</li> <li>● Check whether the remote is in the operation range.</li> <li>● Bright light may interfere with the remote control. Please avoid using the remote control near special fluorescent lights or neon lights.</li> </ul>
Auto on/off does not work or does not function properly.	<ul style="list-style-type: none"> <li>● Check whether the TIMER setting in the menu is set to "OFF".</li> <li>● Check whether the "Power On Time" and "Power Off Time" settings are set correctly.</li> </ul>
Cannot control the display remotely via RS-232.	<ul style="list-style-type: none"> <li>● Check whether the RS-232 cable is connected properly.</li> </ul>

If you are still having trouble with your DynaScan DS<sup>2</sup> Professional LCD, contact your dealer or DynaScan directly for more assistance.

# About DSM365

DSM365 is an internal operating system as Android, which can install the applications via USB flash drive storage, SD card or Internet.

## How to Switch to DSM365

- Press the MENU button on either the rear panel control or remote control to show the OSD.
- Use the navigation arrows to select and adjust the Input Source.  
[Input Source → Main → DSM365]

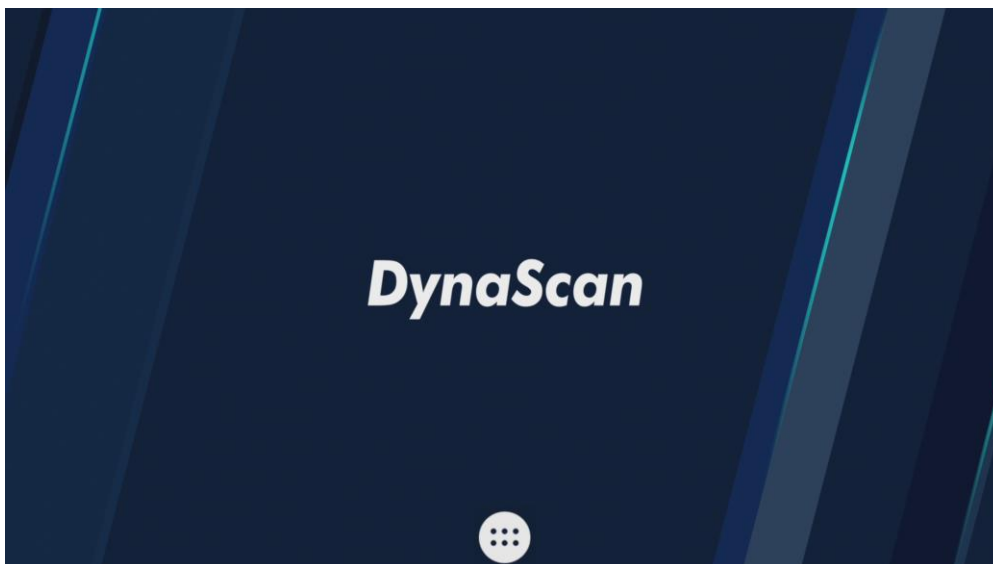
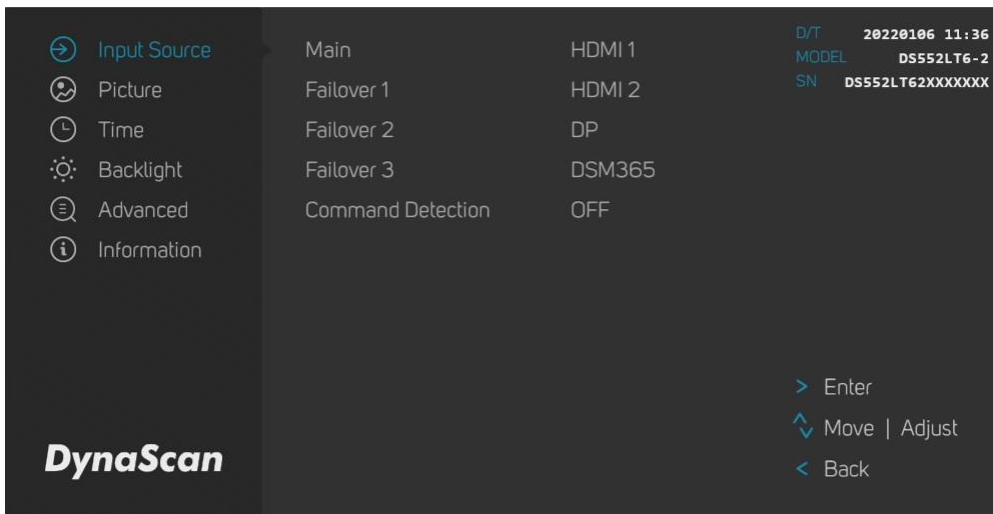

1

ITEM		DESCRIPTION
1	APPS	Show the Installed APPS.

**[www.dynascandisplay.com](http://www.dynascandisplay.com)**

Copyright © DynaScan Technology, Inc. All Rights Reserved.