

## Safety Precautions



### CAUTION

- Do not install display in a wet environment or place anything on the top of the display filled with liquid, such as vase or beverage.
- Do not install near flammable objects, such as gasoline or other volatile liquids.
- Do not install near any heat sources such as radiators or other heating devices.
- Do not install in the dusty environment.
- Do not damage the power cord or plug.
- Do not disassemble the screen to avoid electric shock.
- The product can normally operate only under 2000m in altitude. In installations at altitudes above 2000m, some abnormalities may be experienced.



### WARNING

- After extended use the heat sink behind the screen may be hot. Do not touch to avoid being burned.
- Do not touch the screen panel with sharp objects or extreme pressure to avoid damage to the panel.
- The display should be installed in well-ventilated place, do not install in a confined space.
- Do not drop or allow any object to fall to the screen.
- Do not touch the screen with wet hands to avoid electric shock.
- When cleaning, unplug the monitor. Use a soft, dry cloth to wipe the screen off. Do not use alcohol or other chemical liquids.
- If you smell smoke or hear a strange noise, immediately unplug the monitor and contact the vendor.
- Do not discard this product with general household waste. Please be sure to comply with the local waste regulations.
- Suitable for mounting on concrete or other non-combustible surface only.
- Please power off the LCD and the video source before plugging in the DVI cable.
- This device uses, generates and radiated radio frequency energy. The radio frequency energy produced by this device is well below the maximum exposure allows by Federal Communications Commission (FCC).**



### IMAGE BURN-IN WARNING

- When a stationary or fixed image is displayed for a long time on the screen, the image may be permanently imprinted on the screen. This phenomenon is known as image burn-in and is not covered by the manufacturer's warranty.
- In order to avoid burn in, avoid prolonged display of static or fixed images on the screen.

V 1.01

#### FEDERAL COMMUNICATIONS COMMISSION INTERFERENCE STATEMENT

This equipment has been tested and found to comply with the limits for a Class B digital device, pursuant to part 15 of the FCC Rules. These limits are designed to provide reasonable protection against harmful interference in a residential installation. This equipment generates, uses and can radiate radio frequency energy and, if not installed and used in accordance with the instructions, may cause harmful interference to radio communications. However, there is no guarantee that interference will not occur in a particular installation. If this equipment does cause harmful interference to radio or television reception, which can be determined by turning the equipment off and on, the user is encouraged to try to correct the interference by one or more of the following measures:

- Reorient or relocate the receiving antenna.
- Increase the separation between the equipment and receiver.
- Connect the equipment into an outlet on a circuit different from that to which the receiver is connected.
- Consult the dealer or an experienced radio/TV technician for help.

## Contents

Confirm the items below are included with the display. If any item is missing, please contact your dealer.

**NOTE:** The color and shape of the accessories may vary by product.

- DS751LT5 Professional LCD x1 pc
- Remote control x1 pc
- Batteries (1.5V / AAA) x2 pcs
- Power cable x1 pc
- Quick Start Guide x1 pc
- ESK302 x1 pc
- Warranty card x1 pc

## Mounting the Display

When used in the portrait orientation, the LCD should be rotated clockwise such that the left edge becomes the top edge.

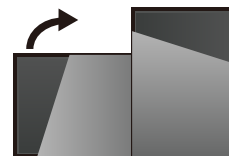

A standard VESA wall mount may be used to secure the display to wall (purchased separately).

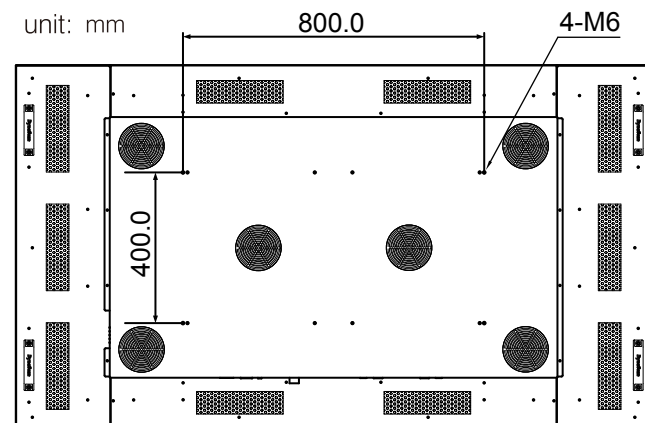

#### CAUTION:

Any changes or modifications not expressly approved by the grantee of this device could void the user's authority to operate the equipment.

#### RF exposure warning

This equipment must be installed and operated in accordance with provided instructions and the antenna(s) used for this transmitter must be installed to provide a separation distance of at least 20 cm from all persons and must not be co-located or operating in conjunction with any other antenna or transmitter. End-users and installers must be provided with antenna installation instructions and transmitter operating conditions for satisfying RF exposure compliance.

## Powering On the Display

- Connect the power cable to the AC-IN of display. Connect other end to 110-220 VAC power outlet.

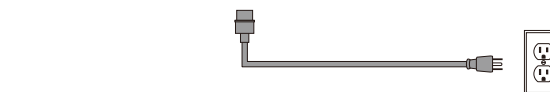
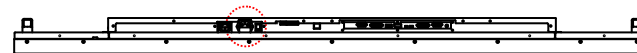

- Switch ON the power switch on back of display.

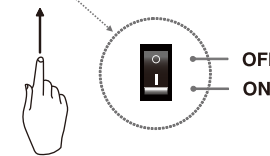
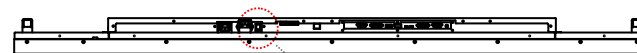

#### NOTE:

The remote control only works when the mains switch is in the ON position.

## Using the Remote

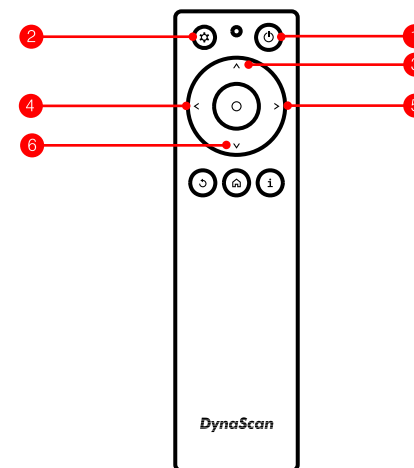

ITEM	DESCRIPTION
1	POWER Power On / Off
2	MENU OSD On / Off
3	UP Move the cursor up or change the setting of the selected item
4	LEFT Exit the current selection
5	RIGHT Select the highlighted item
6	DOWN Move the cursor down or change the setting of the selected item

## Connecting a Video Source

- Connect the DVI cable (or DP cable, HDMI cable) to the DVI-IN port (or DP-IN port, HDMI-IN port) on the back of the display.

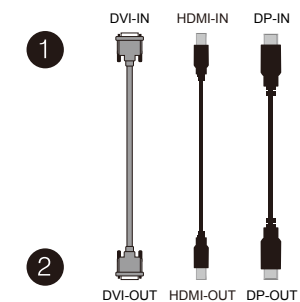

- Connect the other end of the DVI cable (or DP cable, HDMI cable) to the DVI-OUT port (or DP-OUT port, HDMI-OUT port) of your video source device.

## Aiming the Remote

