

**DS552LT5**

# USER MANUAL

55" 4000 Nits Ultra-High Brightness Digital Signage

Please read this manual carefully before operating the product and keep it for future reference. The use of diagrams and illustrations in the manual are for reference only, the actual product may be different.



## FOR MORE INFORMATION

For more information about DynaScan, visit our site at [www.dynascandisplay.com](http://www.dynascandisplay.com). Copyright © DynaScan Technology Inc. All rights reserved. All specifications and descriptions are subject to change without notice. Reproduction without permission is prohibited.

**DynaScan**

64422 | V2.00

# Contents

---

- Material Contents Declaration ..... 2
- Recycling and Energy Information ..... 2
- Declaration of Conformity ..... 3
- Safety Precautions ..... 4
- Important Safety Information ..... 5
- Getting Started ..... 6
  - Contents ..... 6
  - Installing and Replacing Remote Control Batteries ..... 6
- Installation ..... 7
  - Mounting ..... 7
    - Wall Mounting ..... 10
    - Connecting to a Power Source ..... 10
    - Connecting an External Video Source ..... 10
    - Connecting Multiple Displays for Video Wall Applications ..... 11
  - Input / Output Terminals ..... 13
- Operating Instructions ..... 14
  - Powering On/Off the Display ..... 14
  - Using the Remote Control ..... 15
  - Using the Rear Panel Controls ..... 17
- Navigating the On Screen Display (OSD) Menu ..... 18
- Specifications ..... 23
- Input Mode ..... 24
- Pin Assignments ..... 25
  - Digital RGB Output (DVI-D): DVI ..... 25
  - Digital RGB Input (DVI-D): DVI ..... 25
  - RS-232 Output ..... 26
  - RS-232 Input ..... 26
- Troubleshooting ..... 27
- About DSM365 ..... 28

# Material Contents Declaration

Part Name	Hazardous Substances					
	Lead	Mercury	Cadmium	Hexavalent Chromium	Polybrominated Biphenyls	Polybromodiphenyl Ethers
	Pb	Hg	Cd	Cr <sup>6+</sup>	PBB	PBDE
PCBA	○	○	○	○	○	○
CHASSIS	○	○	○	○	○	○
ACCESSORY	○	○	○	○	○	○
PACKAGE	○	○	○	○	○	○
“○” indicates that the level of the specified chemical substance is less than the threshold level specified in the standards of SJ/T-11363-2006 and EU 2011/65/EC. “×” indicates that the level of the specified chemical substance exceeds the threshold level specified in the standards of SJ/T-11363-2006 and EU 2011/65/EC.						

# Recycling and Energy Information

DynaScan is firmly committed to its environmental protection efforts and we believe that reducing our products' impact on the environment is of the utmost importance. We are dedicated to meet the latest environmental protection regulations.

## Energy usage

Mode	Energy Consumption
Normal	Max. 240 W
Standby	< 1 W

## Disposal

Do not dispose of electrical appliances as unsorted municipal waste, use separate collection facilities. Contact your local government for information regarding the collection systems available. If electrical appliances are disposed of in landfills or dumps, hazardous substances can leak into the groundwater and get into the food chain, damaging your health and well-being. When replacing old appliances with new one, the retailer is legally obligated to take back your old appliances for disposal at least for free of charge.



# Declaration of Conformity

---

## FCC

This device complies with Part 15 of the FCC Rules. Operation is subject to the following two conditions: (1) this device may not cause harmful interference, and (2) this device must accept any interference received, including interference that may cause undesired operation.

## FEDERAL COMMUNICATIONS COMMISSION INTERFERENCE STATEMENT

This equipment has been tested and found to comply with the limits for a Class A digital device, pursuant to part 15 of the FCC Rules. These limits are designed to provide reasonable protection against harmful interference when the equipment is operated in a commercial environment. This equipment generates, uses, and can radiate radio frequency energy and, if not installed and used in accordance with the instruction manual, may cause harmful interference to radio communications. Operation of this equipment in a residential area is likely to cause harmful interference in which case the user will be required to correct the interference at his own expense.

## CAUTION:

Any changes or modifications not expressly approved by the grantee of this device could void the user's authority to operate the equipment.

## RF exposure warning

This equipment must be installed and operated in accordance with provided instructions and the antenna(s) used for this transmitter must be installed to provide a separation distance of at least 20 cm from all persons and must not be co-located or operating in conjunction with any other antenna or transmitter. End-users and installers must be provide with antenna installation instructions and transmitter operating conditions for satisfying RF exposure compliance.

**Manufacturer Name** DynaScan Technology Corp.

**Manufacturer Address** 7F, 66 Huaya 1st Road, Guishan, Taoyuan 33383,Taiwan



This device complies with **Directive 2014/53/EU** issued by the Commission of the European Community.

<b>Article 3.1 (a)</b> EN 62368-1:2014/AC:2015	<b>Article 3.1 (b)</b> EN 55032:2015/AC:2016 Class B EN 61000-3-2:2014 EN 61000-3-3:2013 EN 55035:2017
<b>Article 3.2</b> EN 300 328 V2.2.2(2019-07) EN 62311	EN 301 489-1 V2.2.0(2017-03) EN 301 489-17 V3.2.0(2017-03)

## - Frequency bands and Powers

- a. WIFI 2.4G-2412~2462MHz.
- b. Maximum radio-frequency power transmitted in the 2.4GHz is 50mW

# Safety Precautions

<b>CAUTION</b>	
	Do not install the display in a wet environment or place anything filled with liquid such as a vase or beverage on top of it.
	Do not install the display near flammable objects such as gasoline or other volatile liquids.
	Do not install the display near any heat sources such as radiators or other heating devices.
	Do not install the display in the dusty environment.
	Do not damage the power cord or plug.
	Do not disassemble the screen to avoid electric shock.
	The product can normally be operated at an altitude under 2000m. Abnormalities may occur when installing the device at an altitude above 2000m.

<b>WARNING</b>	
	Please power off the LCD and the video source before plugging in the DVI, DP or HDMI cable.
	Please installed the display in well-ventilated place, do not install in a confined space.
	Suitable for mounting on concrete or other non-combustible surface only.
	If it gives off smoke, strange smell, or unusual noise, or when it gets too hot to touch, immediately unplug the display and contact the dealer.
	Clean only with soft, dry cloth but not use chemical liquids, and unplug while cleaning.
	Do not use extreme force or any sharp or pointed objects to touch the display.
	Do not drop or allow any object to fall to the display.
	Do not operate the display with wet hands to avoid electric shock.
	Do not discard this product with general household waste. Please be sure to comply with the local waste regulations.
	This device uses, generates and radiated radio frequency energy. The radio frequency energy produced by this device is well below the maximum exposure allows by Federal Communications Commission (FCC).
	When a stationary or fixed image is displayed on the screen for a long time, the image may be permanently imprinted on the screen. This phenomenon is known as image burn-in and is not covered by the manufacturer's warranty.
	In order to avoid burn-in, avoid prolonged display of static or fixed images on the screen.
	Power supply cord must not be attached to the building surface, nor run through walls, ceilings, floors and similar openings in the building structure. Power cord shall be connected to a socket-outlet with earthing connection.

# Important Safety Information

---

- Disassembling the LCD is strictly prohibited. Opening the cover may expose the user to electric shock or other hazards. Please contact DynaScan certified service professionals for all maintenance requirements.
- Do not allow any liquid to enter the LCD. Also avoid placing the LCD close to water sources.
- Do not place heavy objects on the power cord. A damaged power cord might cause electric shock or fire.
- Do not bend, twist, or damage the power cord.
- The power cord must comply with the local safety regulations.
- Do not damage or modify the prongs/pins and the ground contact on the power cord plug.
- Do not place the LCD on an unlevelled surface or an unstable vehicle. The LCD could fall over and cause substantial damage.
- Do not cover the vents and/or the heat sink.
- Do not install the LCD beside radiators or other heat sources. The installation site should have sufficient ventilation so the heat generated by the LCD can be dissipated.
- Do not use the Signage in a hot, humid, dusty, or fume environment.
- Handle the LCD with care. Save the packaging materials for transport later.
- Clean the LCD backside at least once a month for dust and other particles.

**Unplug the LCD immediately and contact a DynaScan certified service professional as soon as possible when any of the following situations occurs:**

- Damaged power cord or power plug.
- If liquid or foreign object has entered the LCD.
- If the LCD has been exposed to rain or water.
- If the LCD has been dropped or the casing has become damaged.
- If any structural damage such as cracks or unnatural vibration is found.
- If the LCD cannot be operated following the steps outlined in this manual.
- If the LCD emits smoke or other odors, or generates strange noises.

## **Operating Suggestions**

- Avoid displaying a stationary image for a long period of time in order to prevent image sticking.

## **Cleaning the Panel**

- Use a soft, lint-free cloth to gently wipe the dust off from the screen panel.
- Do not use any hard material to wipe the panel.
- Do not poke the panel with your hand or any sharp object (such as a pen or a nail) or exert excessive pressure on the panel to prevent any damage.
- Do not use any cleaning solutions on the panel as it might cause discoloration.

## **Cleaning the Casing**

- Unplug the power cord.
- Gently wipe the casing with a soft cloth.

## **Attention**

- Do not use any of the following solutions to clean the casing as they may damage the paint and cause it to crack or peel: benzene solution, alkaline solution, alcohol-based cleaning solution, glass cleaner, wax, polisher, or detergent.



# Getting Started

## Contents

Confirm that the accessories below are shipped along with the display. If any item is missing, please contact your dealer. The color and shape of the accessories may vary with the products.

- DS552LT5 Professional LCD.
- Remote Control x 1 pc.
- Batteries (1.5V / AAA) x2 pcs.
- Power cable x1 pc.
- Quick Start Guide x1 pc.
- ESK302 x1 pc.

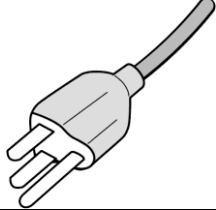
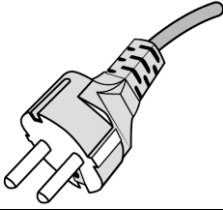
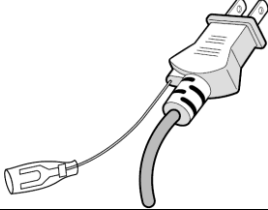
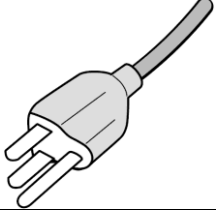
**Attention:** Please use the following table to check whether the included power cord is suitable for your region. If the power cord does not match your region, please contact your local supplier. Please use matching AC socket in order to meet your local safety regulations.

Plug Type	North America	European Continental	Japan	Taiwan
Plug Shape				
Region	U.S.A. / Canada	EU (Except U.K.)	Japan	Taiwan
Voltage	120V	230V	100V	110V
NEMA TYPE	NEMA 5-15	CEE 7/7	NEMA 1-15	NEMA 5-15
IEC Display Plug				
IEC Plug TYPE	IEC320 C13			

## Installing and Replacing Remote Control Batteries

1. Open the battery compartment cover.
2. Insert 2 new AAA batteries.
3. Close the battery compartment cover.

### Warning:

- Incorrect usage of batteries may cause leakage or explosion.
- Pay attention to the polarity when installing the batteries.
- Do not mix different types of batteries or new and used batteries. Doing so may shorten the battery life or cause leakage.
- Remove or replace the batteries when they are empty in order to prevent acid leaking in the battery compartment.
- Do not touch the leaked substance from the batteries in case of a battery leakage. Doing so may hurt human skin.

**Note:** If the remote control is not going to be used for a long time, we recommend removing the batteries from the remote control.

# Installation

---

*The LCD must be properly installed using a wall mount. Incorrect installation may cause injury or damage the equipment. Product warranty does not cover the damage caused by improper installation and DynaScan shall not be held responsible in such incident. Refer to the mount manufacturer's instructions for proper installation.*

## Mounting

- Hanging the Professional LCD from the ceiling or mounting it on the wall is the responsibility of the user. Not all ceilings or walls provide enough strength to support the LCD. The LCD may drop and cause serious injury if it is hanging from the ceiling with insufficient support or is mounted on a slanted wall. Product warranty does not cover improper installation, modification, or damage caused by natural disasters. DynaScan recommends having certified professionals to evaluate the installation site and perform the mounting operation.
- Do not to cover the vent and/or the heat sink in order to ensure proper heat dissipation.
- Refer to the installation guide provided by the manufacturer for proper mounting.

### When mounting on a wall or hanging from a ceiling

- A wall mount is not included in the accessory. Please purchase a VESA Standard wall mount to secure the LCD. DynaScan is not responsible for the damage caused by using non-standard wall mounts.
- Verify that the mounting location can support the weight of the LCD before installation.
- The installation angle must be within 15 degrees of the vertical axis.
- Do not install the wall mount while the power is turned on as it may cause serious injury due to electrical shock.

Model Number	VESA (mm)		Screw Specification	Screw Length	Number
DS552LT5	(A * B)	400 * 400	M6	Greater than 10mm Smaller than 12mm (not including wall mount thickness)	4



## DS552LT5

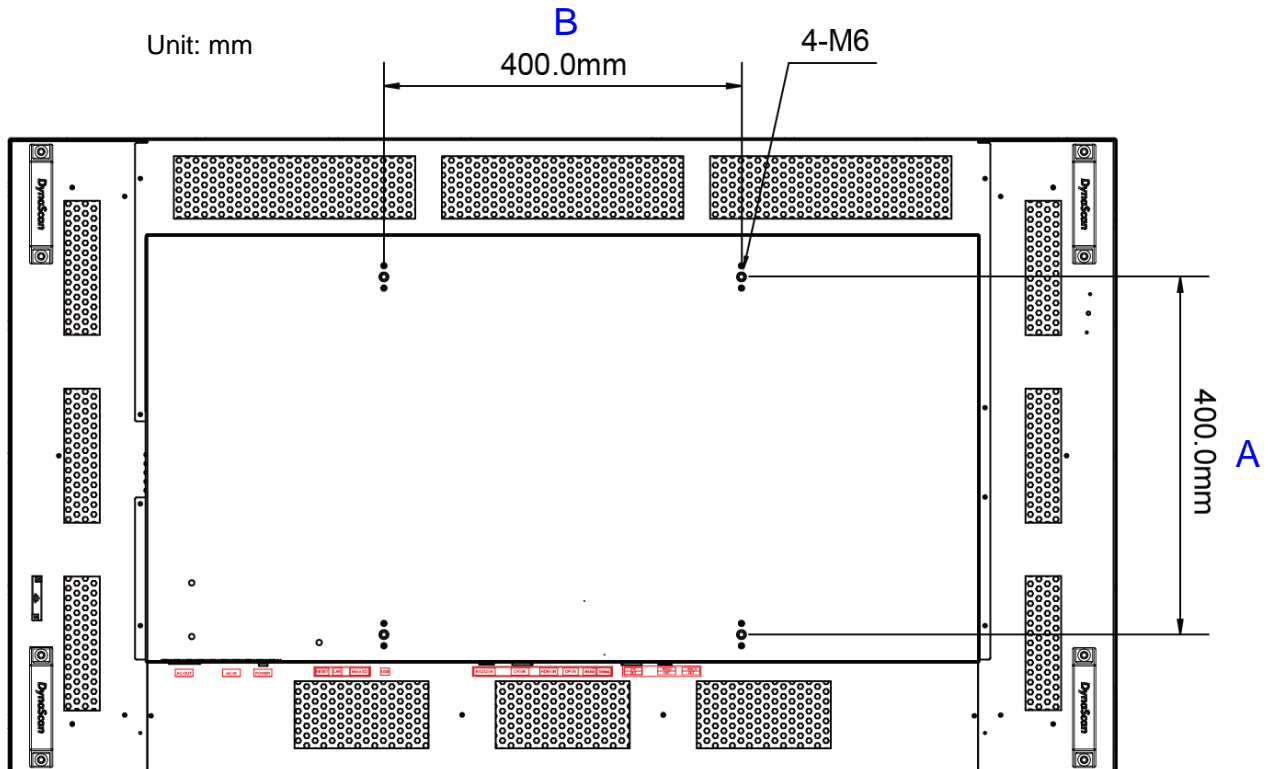

### Orientation

- When used in the portrait orientation, the LCD should be rotated clockwise when looking at the front of the display such that the left edge becomes the top edge.

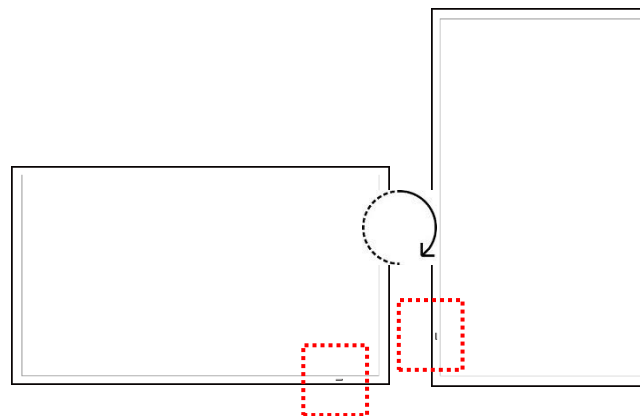

Portrait mode: Rotate the set clockwise 90° (mandatory)

### Installation Location

- The wall and mount must have enough strength to support the LCD and its accessories.
- Do not install in a location with strong vibrations or is dusty.
- Do not install near the building's main electric panel.
- Ensure the LCD is secured in such a manner that it cannot be easily removed by the general public.
- Leave clearance around the outer edge of the LCD (or video wall matrix) from other objects to ensure proper ventilation.
- For installations with screens inset into the wall, refer to section: Enclosures for cooling and ventilation considerations.

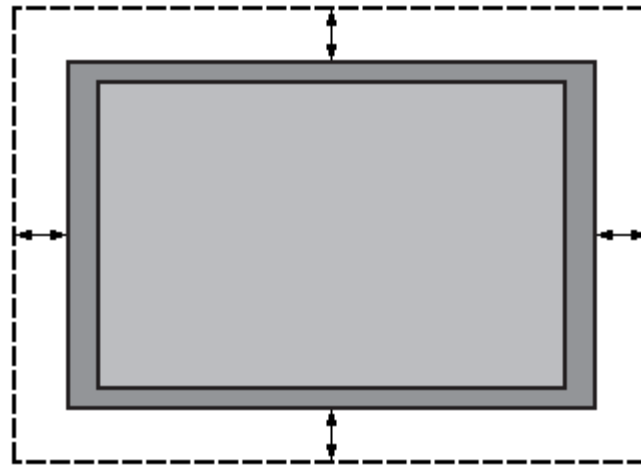

Single display

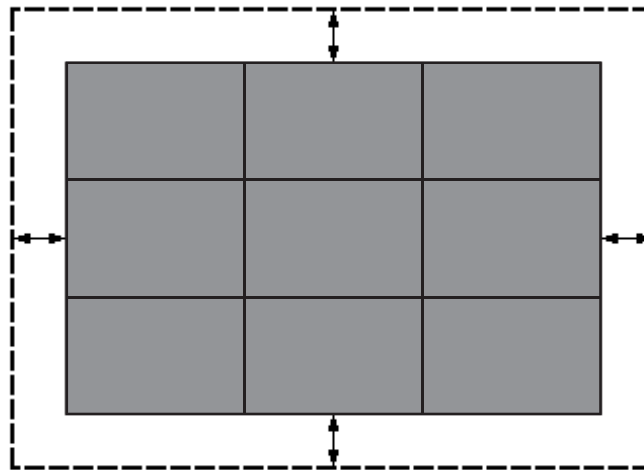

Video wall

### When hanging from a ceiling

- Ensure that the ceiling is strong enough to support the LCD and its accessories. Earthquake, unexpected vibration and other external forces should be taken into consideration when evaluating the ceiling strength.
- The LCD should be secured to the building's structural frame such as a beam rather than light steel frame or interior decoration.
- Do not use wood screws or dry wall anchors for installation.

### Maintenance

- Inspect the fasteners regularly for signs of loosening or deformation. Please perform appropriate corrective measures when a problem is identified. Neglecting the problem may worsen the situation.
- Increase the inspection frequency on areas where previous maintenance had occurred to ensure the problems do not occur again.

## Wall Mounting

- A wall mount is not included. Please purchase a VESA Standard wall mount to secure the LCD. DynaScan is not responsible for damages caused by using non-standard wall mounts.
- Verify that the mounting location can support the weight of the LCD before installation.
- The installation angle must be within 15 degrees of the vertical axis.
- Do not install the wall mount while the power is turned on as it may cause serious injury from electrical shock

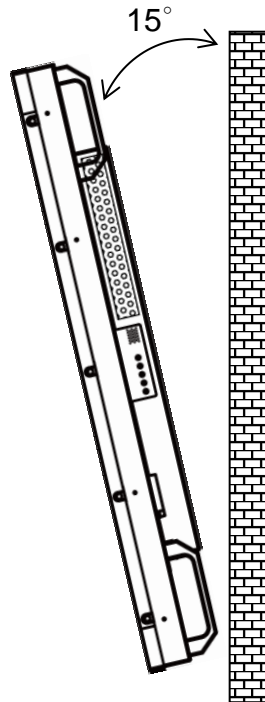

## Connecting to a Power Source

Using the power cable provided, plug it in the power inlet on the back of the display shown in the diagram below. Connect the power cable to a 100-240 volt, 50 / 60Hz AC power outlet.

 Insert the plug completely into the socket. A loose power connection may cause damage to the display and/or lead to a fire hazard.

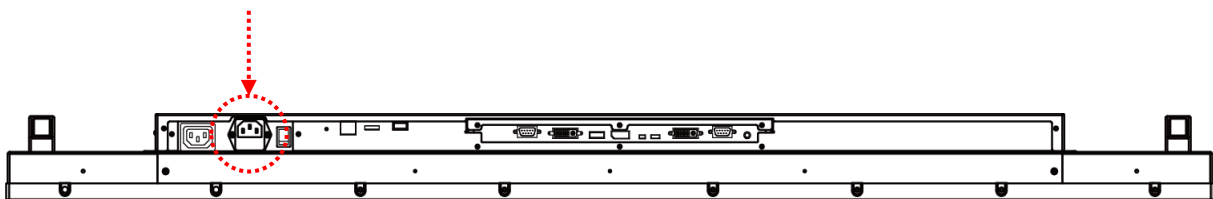

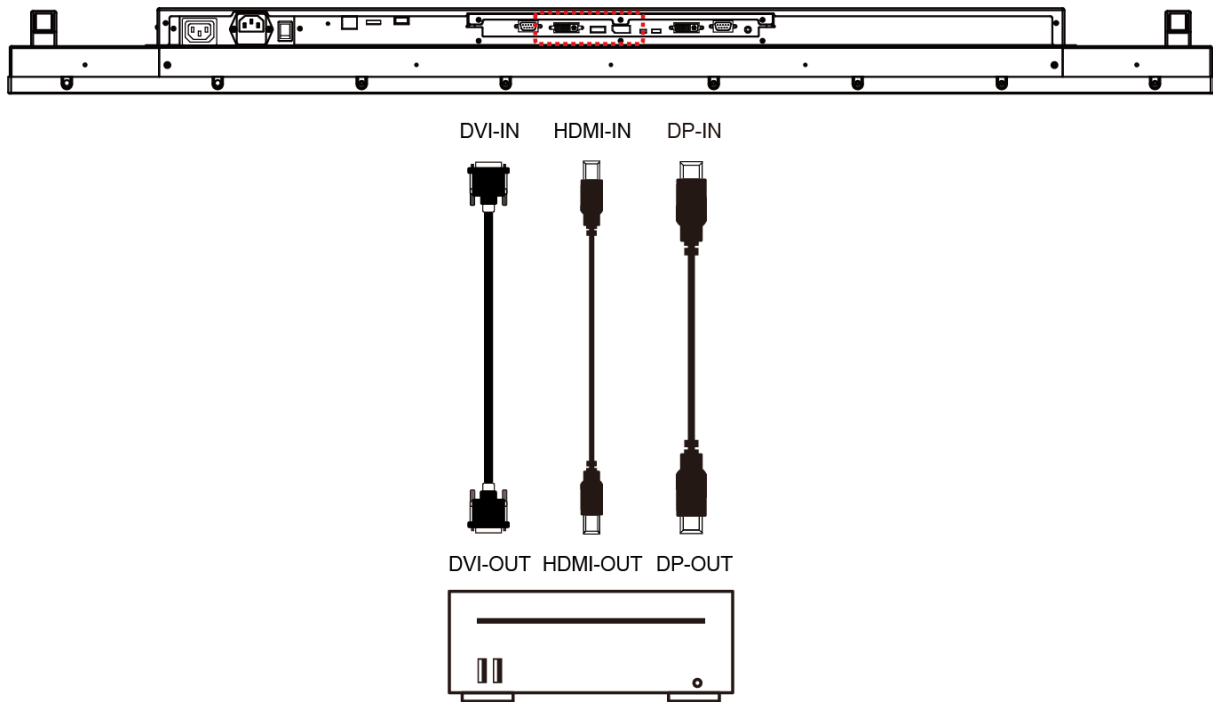

## Connecting an External Video Source

Turn OFF the power of both LCD and external video device. Using the DVI cable (or DP cable, HDMI cable) provided, insert one end into the DVI-IN (or DP-IN, HDMI-IN) on the back of the display shown in the diagram below. Connect the other end of the DVI cable (or DP cable, HDMI cable) to the DVI output (or DP output, HDMI output) of the video source. Refer to your video device's manual for additional information.



## Connecting Multiple Displays for Video Wall Applications

To daisy chain multiple displays for a video wall application, connect a video source to the 1<sup>st</sup> display into the chain with the supplied DVI cable (or DP cable, HDMI cable) and RS-232 cable. Connect the DVI-OUT of the 1<sup>st</sup> display to the DVI-IN of the 2<sup>nd</sup> display. Using the RS-232 cable provided, connect the RS-232 OUT of the 1<sup>st</sup> display to the RS-232 IN of the 2<sup>nd</sup> display. Repeat the connection for the remaining displays. Use the OSD Menu or Display Manager software to configure the size of the video wall and the position of each display.

-  **Note:** The maximum number of DS552LT5's in a Video Wall is 15 x 15.
-  **Note:** The DynaScan "Display Manager" application is required to be installed on the PC in order to use the External Control feature.
-  **Note:** The Daisy Chain Setting (video wall function) only supports a resolution of 1920 x 1080 (1080p).

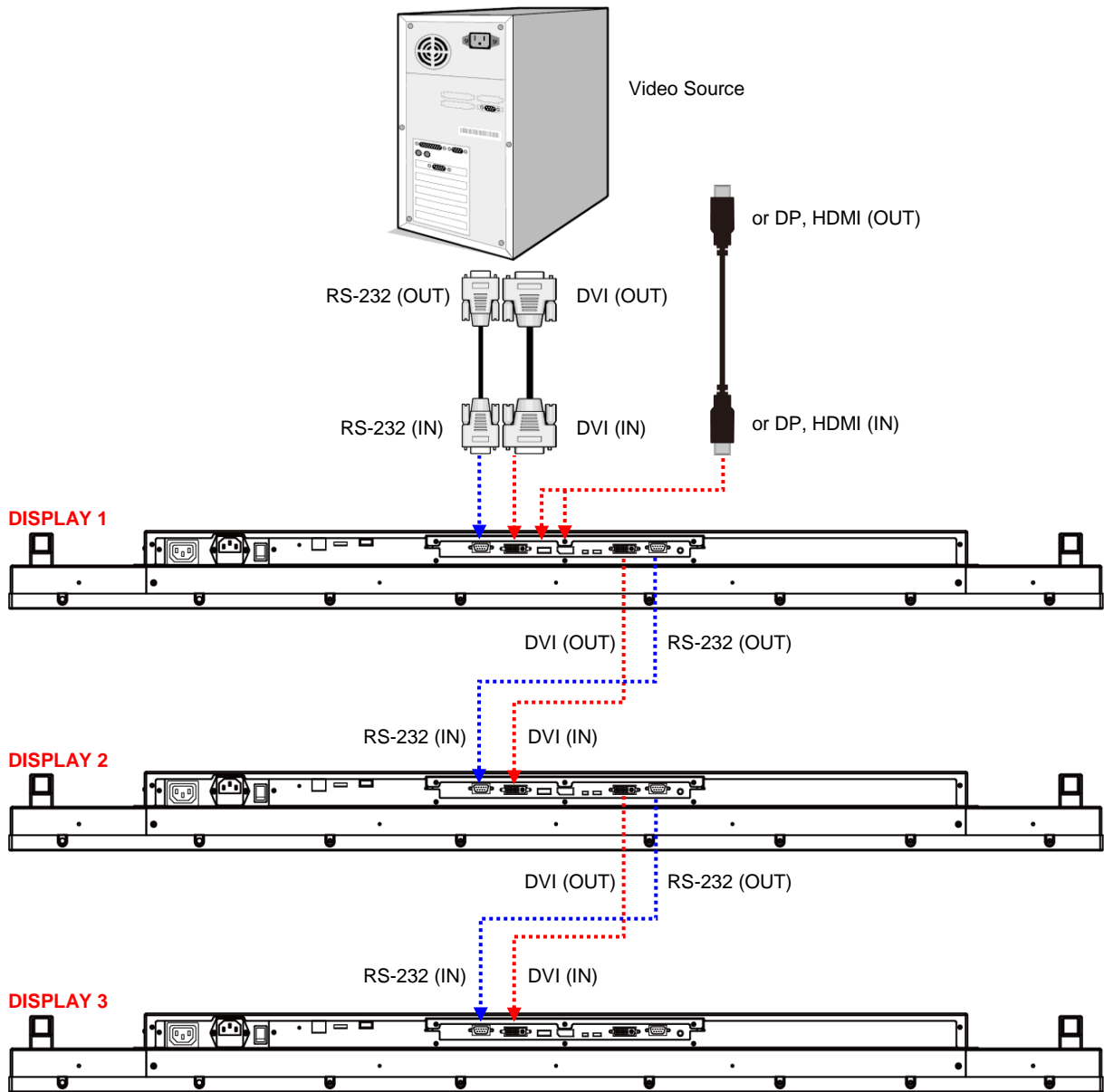

## Input / Output Terminals

1. **AC (OUT):** AC outlet 100-240V up to 100 Watt.
2. **AC (IN):** Connect the supplied power cord to the wall outlet.
3. **Power Switch:** Press to switch the main power on/off.
4. **RJ-45 (IN):** RJ45 network input connection.
5. **Micro SD card:** Support for up to 32GB, FAT32/NTFS format is supported.
6. **USB port:** Support for USB flash drive storage, mouse and keyboard.
7. **RS-232 (IN):** RS232C network input connection for remote control from PC.
8. **DVI (IN):** Connect the DVI-D output of a PC, or the HDMI output of an AV device via a DVI-HDMI cable.
9. **HDMI (IN):** Connect the HDMI output of a PC, or the HDMI output of an AV device via a HDMI cable.
10. **DP (IN):** Connect the DP output of a PC, or the DP output of an AV device via a DP cable.
11. **Extension Connector:** Extension Connector for optional IR Extension sensor kit (ESK302).
12. **Thermal:** Extension Connector for optional Extension thermal kit (ETK201).
13. **DVI (OUT):** Output the signal from DVI IN.
14. **RS-232 (OUT):** RS232 control function for daisy chain application.
15. **Audio (OUT):** Connect the audio signal output from Audio IN jack to an external AV device.

### DS552LT5

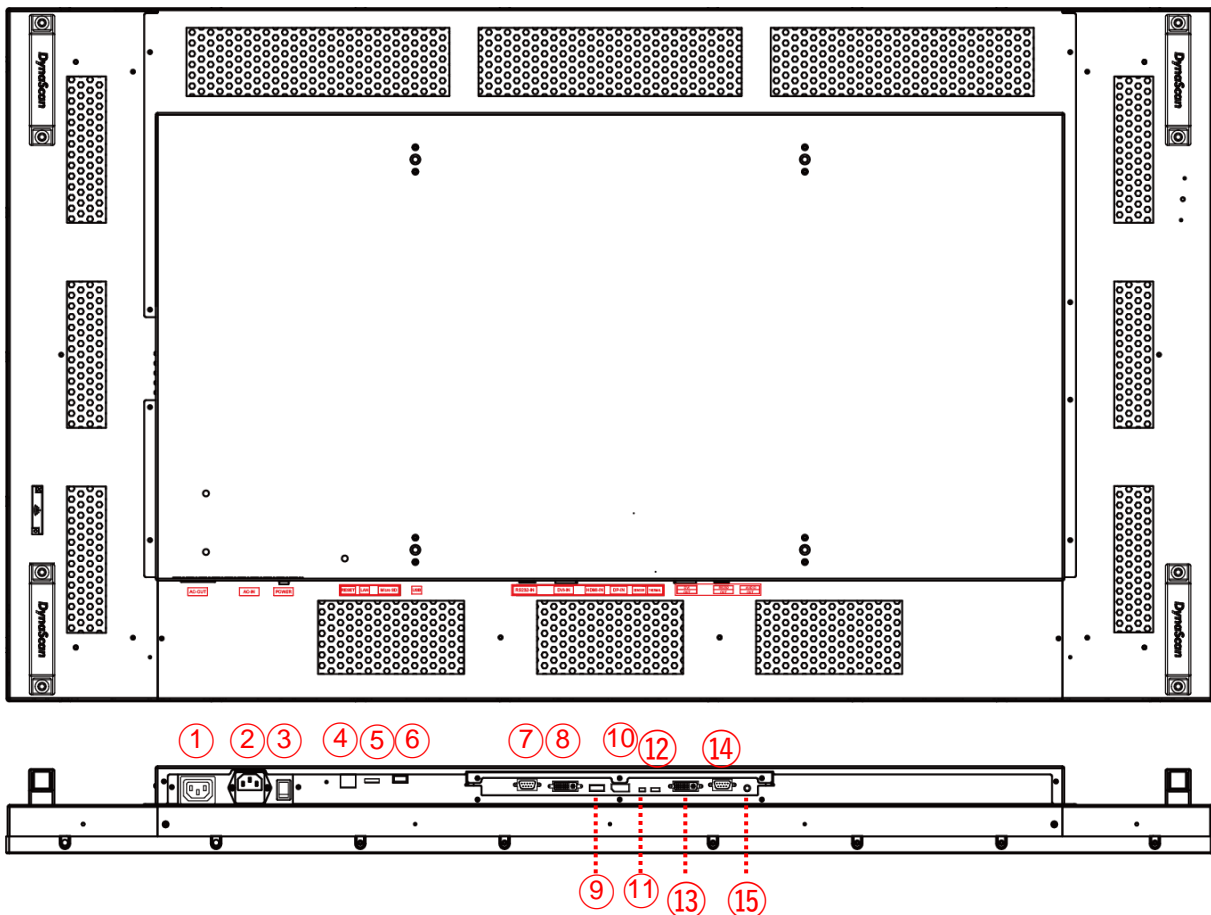

# Operating Instructions

---

## Powering On/Off the Display

To turn on/off the display, press the power switch on the back of the display as shown in the diagram below.

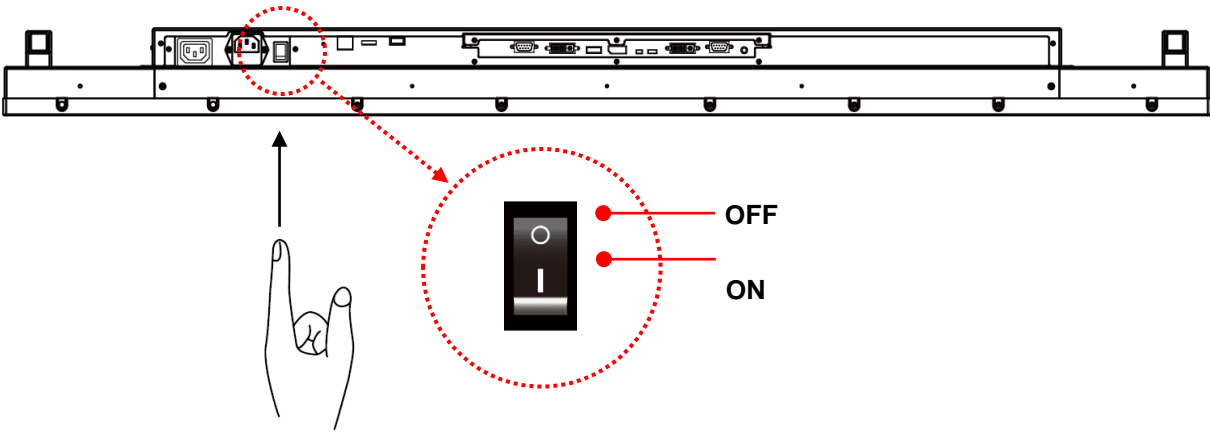

**NOTE:** The remote control only works when the power switch is ON.

# Using the Remote Control

When using the remote control, aim the remote at the IR receiver on the display. The IR receiver on the DS552LT5 model is at the rear of the display with a receiving angle of 100 degrees. The IR receiver configurations of the model are shown in the figure below.

The operating range of the remote control is 2.5 meters (8 feet).

Ambient light may affect the performance of the remote control. Avoid fluorescent or neon lights in the vicinity.

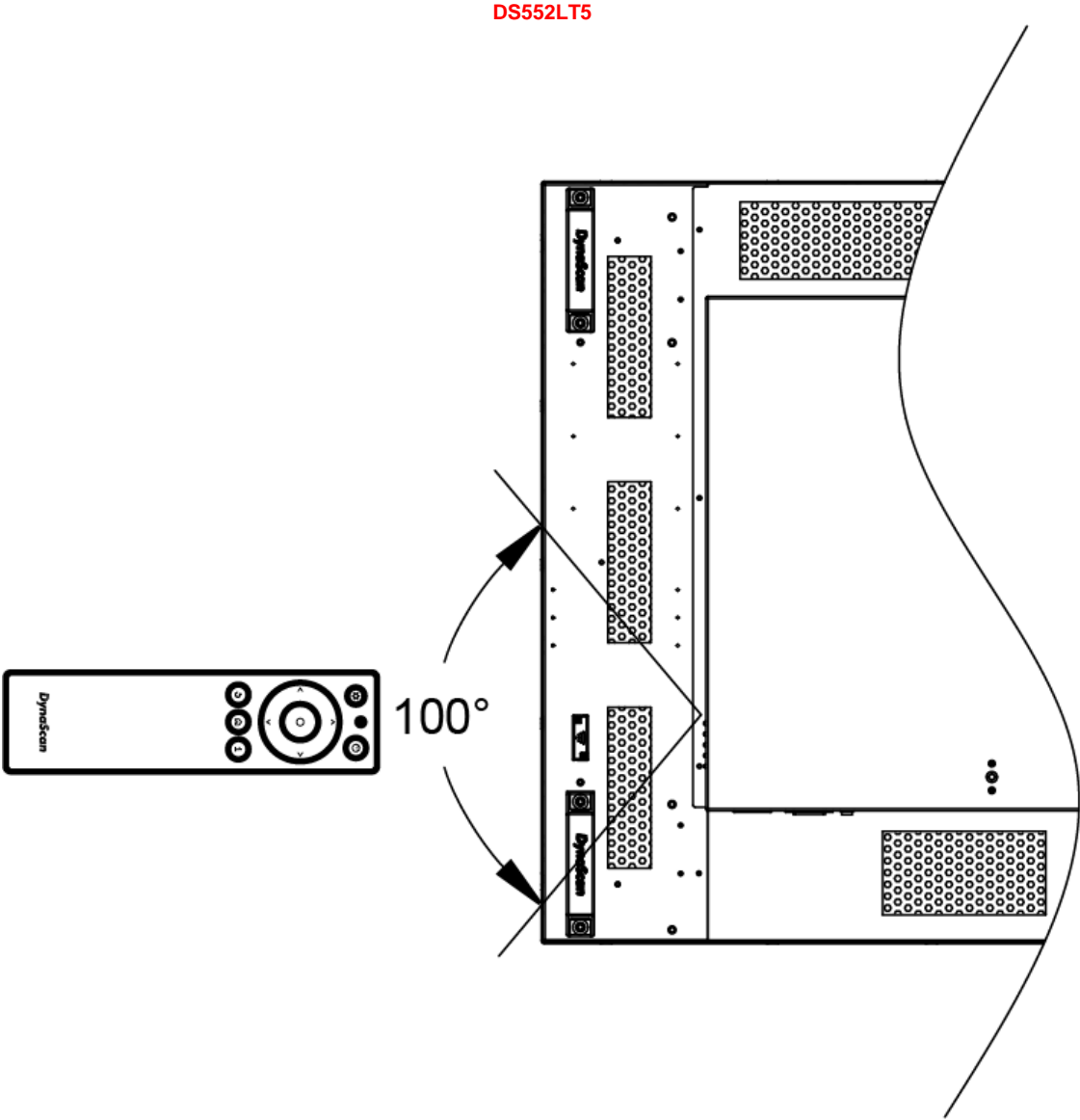



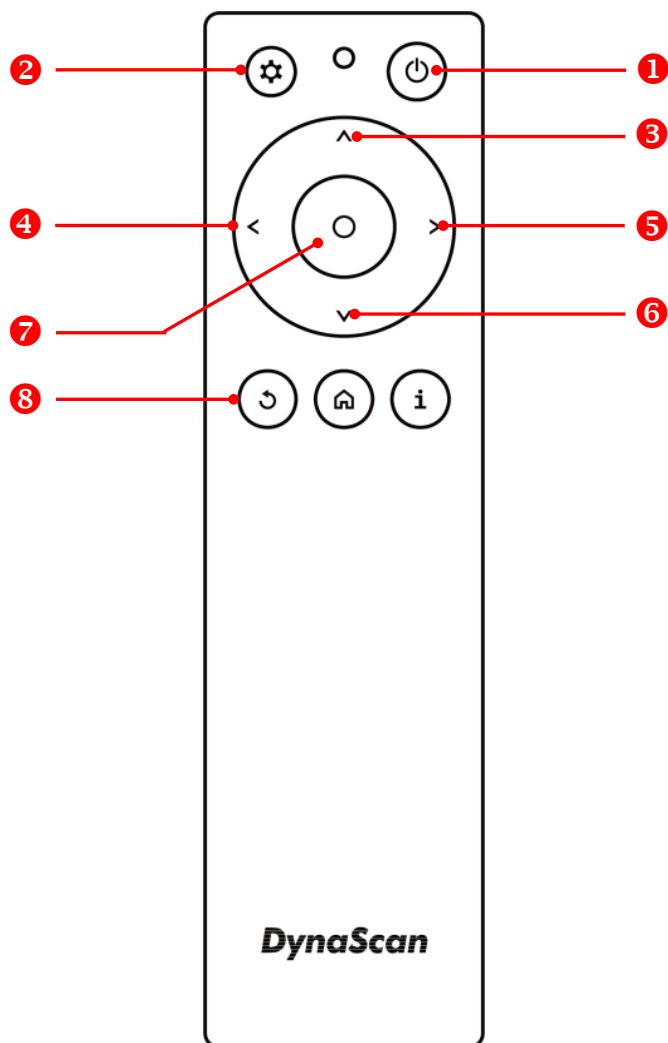

\*Color and shape may vary by model.

ITEM		DESCRIPTION
①	POWER	Power On / Off
②	MENU	OSD On / Off
③	UP	Move the cursor up or change the setting of selected item.
④	LEFT	Exit the current selection.
⑤	RIGHT	Select the highlighted item.
⑥	DOWN	Move the cursor down or change the setting of selected item.
⑦	OK	Enter (for DSM365 only)
⑧	BACK	Return to the last page. (for DSM365 only)

## Using the Rear Panel Controls

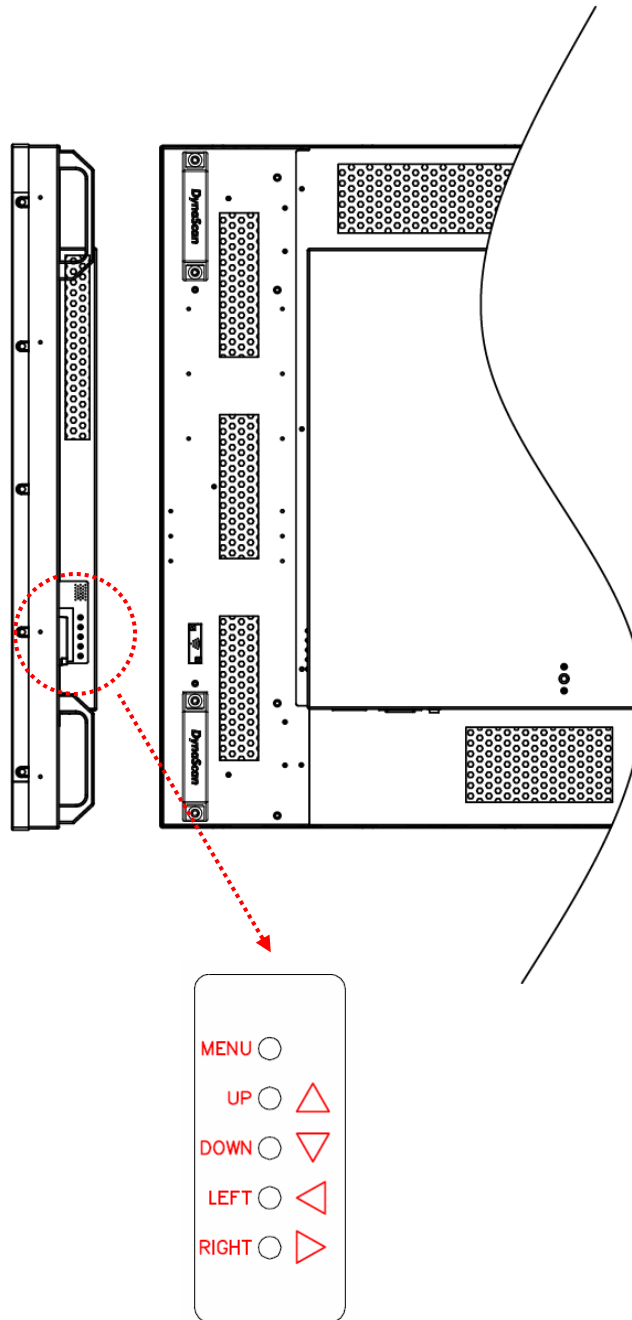

ITEM	DESCRIPTION
MENU	OSD On / Off, Power On / Off.
UP	Move the cursor up or change the setting of selected item.
DOWN	Move the cursor down or change the setting of selected item.
LEFT	Exit the current selection.
RIGHT	Select the highlighted item.

# Navigating the On Screen Display (OSD) Menu

Press the MENU button on either the rear panel control or remote control to show the OSD. Use the navigation arrows to select and adjust the menu items.

<b>Input Source</b>	Main	HDMI
Picture	Failover 1	DP
Time	Failover 2	DVI
Video Wall	Failover 3	DSM365
Backlight		
Advance		

ITEM 1	ITEM 2	DEFAULT	DESCRIPTION
Input Source	Main	HDMI	Set the Main input to display.
	Failover 1	DP	Set the Failover 1 input to display.
	Failover 2	DVI	Set the Failover 2 input to display.
	Failover 3	DSM365	Set the Failover 3 input to display.

<b>Input Source</b>	<b>Color Temperature</b>	<b>User</b>
<b>Picture</b>	R	100
Time	G	100
Video Wall	B	100
Backlight	Contrast	50
Advance	Gamma	Native
	Black Level	RGB Full

ITEM 1	ITEM 2	DEFAULT	DESCRIPTION
Picture	Color Temperature	D65	Select the color temperature. (User, D93, D65 and D55).
	R		Adjust the red light level. Range 0 – 100. <b>Note:</b> The feature is only supported on User mode.
	G		Adjust the green light level. Range 0 – 100. <b>Note:</b> The feature is only supported on User mode.
	B		Adjust the blue light level. Range 0 – 100. <b>Note:</b> The feature is only supported on User mode.
	Contrast	50	Adjust the contrast level. Range 0 – 100.
	Gamma	Native	Adjusts the Gamma value. (Native, 2.2, 2.4 and sgamma)
	Black Level	RGB Full	Selects the black level to adjust the screen gray scale. "Limited" for video source uses 16 to 235 levels for R/G/B, such as HDMI. "RGB Full" for video source uses all levels from 0 to 255 levels.

Input Source	Current Date	2017/01/01
Picture	Current Time	12:00:00
<b>Time</b>	Power Control Timer	Off
Video Wall	Power On Time	00:00
Backlight	Power Off Time	00:00
Advance		

ITEM 1	ITEM 2	DEFAULT	DESCRIPTION
Time	Current Date	YYYY:MM:DD	Set the date.
	Current Time	HH:MM:SS	Set the clock. <b>Note:</b> The internal clock will continue to function when the power is turned off.
	Power Control Timer	Off	Turn on / off automatic power schedule function.
	Power On Time	HH:MM	Set turn-on time.
	Power Off Time	HH:MM	Set turn-off time.

Input Source	Number of Rows	1
Picture	Number of Columns	1
Time	Row Position	1
<b>Video Wall</b>	Column Position	1
Backlight	Bezel Compensation	On
Advance		

ITEM 1	ITEM 2	DEFAULT	DESCRIPTION
Video Wall	Number of Rows	1	Set number of rows in a video wall. <b>Note:</b> The maximum number of rows in a daisy chain is 15.
	Number of Columns	1	Set number of columns in a video wall. <b>Note:</b> The maximum number of columns in a daisy chain is 15.
	Row Position	1	Vertical position in a video wall.
	Column Position	1	Horizontal position in a video wall.
	Bezel Compensation	On	Choose to turn the frame compensation function on or off. When turned on, the display will adjust the image to compensate the width of display bezels in order to accurately display the image.

Input Source	Auto Brightness	Off
Picture	High Level	100
Time	Low Level	15
Video Wall	High Level Time	00:00
Backlight	Low Level Time	00:00
Advance	Local Dimming	Medium

ITEM 1	ITEM 2	DEFAULT	DESCRIPTION
Backlight	Auto Brightness	Off	To turn On / Off the auto brightness adjustment. <b>Note:</b> If the AUTO BRIGHTNESS is off, the screen brightness will remain at HIGH LEVEL brightness value. If the AUTO BRIGHTNESS is on (Auto), the display brightness adjusts according to the ambient light. When ambient light is bright, the screen will adjust to the HIGH LEVEL brightness value set; when ambient light is dark, the screen will adjust to the LOW LEVEL brightness value set. When the Timer mode is set, the display will automatically switch the brightness according to the time set.
	High Level	100	Adjusts the highest brightness level. Range 0 – 100.
	Low Level	15	Adjusts the lowest brightness level. Range 0 – 100.
	High Level Time	HH:MM	Set high level time.
	Low Level Time	HH:MM	Set low level time.
	Local Dimming	Medium	Adjusts the contrast. High is the highest contrast. Off is the lowest contrast. (Off, Low, Medium and High)

Input Source	Display Mode	Auto
Picture	Screen Protection	Off
Time	IR Control	On
Video Wall	Power Off Mode	Standby
Backlight	Volume	100
Advance	Reset to Default Setting	Off

ITEM 1	ITEM 2	DEFAULT	DESCRIPTION
Advance	Display Mode	Auto	Change the Menu orientation. The Menu can be displayed in either LANDSCAPE or PORTRAIT mode.
	Screen Protection	Off	Turn on / off image burn-in protection. Set image burn-in protection interval. Range 1 – 100.
	IR Control	On	Enable/disable the remote control for

			Menu. <b>Note:</b> When disabled, the remote control function can be enabled again from the control panel on the display or through the DynaScan "Display Manager" application.
	Power Off Mode	Standby	When in Power Off Mode, RS-232 controls do not function. Only [Main Power Switch] on the display or [Power Button] on the remote control can wake up the display.
	Volume	100	Set volume. Range 100 – 0.
	Reset to Default Setting	Off	Restore all settings to default. <b>Note:</b> It does not modify CURRENT TIME, POWER ON TIME and POWER OFF TIME.

<b>Information 1</b>	Resolution	HDMI 1920x1080
<b>Information 2</b>	Model	DS552LT5
<b>Information 3</b>	Serial Number	552LT5XXXXXXXX
	Hardware	XXXXX
	Firmware	X.X.X
	Color Depth	8 bits

ITEM 1	ITEM 2	DEFAULT	DESCRIPTION
Information 1	Resolution		Input resolution.
	Model	DS552LT5	The display's model.
	Serial Number		The display's serial number.
	Hardware		The H/W version.
	Firmware		The F/W version.
	Color Depth		The color depth of current input.

<b>Information 1</b>	Temperature (BLU)	27°C/ 80°F
<b>Information 2</b>	Temperature (Amb.)	No Connection
<b>Information 3</b>	ALS Level (Amb.)	10

ITEM 1	ITEM 2	DEFAULT	DESCRIPTION
Information 2	Temperature (BLU)		LCD inner (backlight unit) temperature monitoring.
	Temperature (Amb.)		LCD outer (ambience) temperature monitoring. (temperature sensor installation is necessary)
	ALS Level (Amb.)		The brightness of ambience monitoring. (Ambience Light Sensor)

Information 1	Over Heat Protection	Inactive
Information 2		
Information 3		

ITEM 1	ITEM 2	DEFAULT	DESCRIPTION
Information 3	Over Heat Protection	Inactive	It will enter into protection mode when the display internal temperature is over heat. 56°C = Brightness 50%. 61°C = Brightness 25%. 66°C = Brightness 03%. When the temperature is decreased to exit the protection, the brightness will restore to 100% and Over Heat Protection is disabled.

Some functions may not be available for all models.



\*Adjusted value: Each R/G/B value for this product has been individually adjusted during production to a preset color temperature of 6500K.

# Specifications

MODEL		DS552LT5
PANEL	LCD Panel Size	54.64 inches
	Native Resolution	1920 x 1080
	Brightness	3500 cd/m <sup>2</sup> (Typ.)
	Contrast Ratio	3,000:1
	Response Time	9 ms (Typ.)
	Viewing Angle	178°/ 178°
	Life Time	100,000 hrs (Typ.)
	Panel Surface	AR 1.5%, 2H
POWER	Power Supply	Internal
	Rated Voltage	100 - 240V, 50 / 60Hz
	Power On Mode	Typ. 160W / Max. 240W
	Standby Mode	< 1W
	AC Out	< 100W
MECHANICAL SPECS	Bezel Width (T/B/L/R)	10.9/10.9/10.9/10.9 mm
	Cabinet Color	Black
	Monitor Dimension (LxHxD, w/o Stand)	1239.4 x 710.0 x 87.7 mm
	Monitor Weight (set / package)	27.5 kg / 32.5 kg
	VESA Mounting (Dimension)	4 Holes (400x400 mm)
USER INTERFACE	OSD Language	English
ENVIRONMENT	Operation Temperature	0°C ~ 45°C
	Storage Temperature	-20°C ~ 60°C
	Humidity	10%~80% RH Non-Condensing
I/O Ports	DVI-D	IN *1 / OUT *1 (support HDMI)
	DP	IN *1
	HDMI	IN *1
	RS-232	IN *1 / OUT *1
	Audio	OUT *1
	RJ-45	*1
	Micro SD card	*1
	USB port	*1
Fuse		5A



Design and specifications are subject to change without notice.



# Input Mode

---

Active Resolution		Refresh Rate	Pixel Rate	Aspect Ratio
H Pixels	V Lines			
640	480	60 Hz	25.175 MHz	4:3
720	480	59.94 Hz	27 MHz	4:3
800	600	60 Hz	40 MHz	4:3
1024	768	60 Hz	65 MHz	4:3
1280	720	60 Hz	74.25 MHz	16:9
1280	768	60 Hz	79.5 MHz	5:3
1360	768	60 Hz	85.5 MHz	16:9
1920	1080	60 Hz	148.5 MHz	16:9

# Pin Assignments

## Digital RGB Output (DVI-D): DVI

PIN ASSIGNMENT OF DVI CONNECTOR					
01	TX2-	09	TX1-	17	TX0-
02	TX2+	10	TX1+	18	TX0+
03	Shield (TX2 / TX4)	11	Shield (TX1 / TX3)	19	Shield (TX0 / TX5)
04	NC	12	NC	20	NC
05	NC	13	NC	21	NC
06	DDC-Serial Clock	14	+5V power	22	Shield (TXC)
07	DDC-Serial Data	15	Ground	23	TXC+
08	NC	16	Hot plug detect	24	TXC-

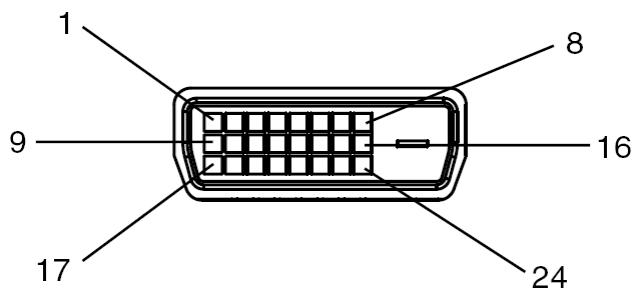

## Digital RGB Input (DVI-D): DVI

PIN ASSIGNMENT OF DVI CONNECTOR					
01	RX2-	09	RX1-	17	RX0-
02	RX2+	10	RX1+	18	RX0+
03	Shield (RX2 / RX4)	11	Shield (RX1 / RX3)	19	Shield (RX0 / RX5)
04	NC	12	NC	20	NC
05	NC	13	NC	21	NC
06	DDC-Serial Clock	14	+5V power	22	Shield (RXC)
07	DDC-Serial Data	15	Ground	23	RXC+
08	NC	16	Hot plug detect	24	RXC-

### RS-232 Output

PIN No.	NAME
01	Connected to 7&8
02	RXD
03	TXD
04	Connected to 6
05	GND
06	Connected to 4
07	Connected to 1&8
08	Connected to 1&7
09	NC

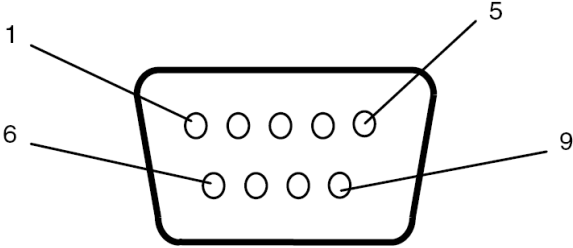

### RS-232 Input

PIN No.	NAME
01	Connected to 7&8
02	TXD
03	RXD
04	Connected to 6
05	GND
06	Connected to 4
07	Connected to 1&8
08	Connected to 1&7
09	NC

# Troubleshooting

ISSUE	RECOMMENDED SOLUTION
No image is displayed.	<ul style="list-style-type: none"> <li>● Check whether the cable is completely plugged in.</li> <li>● Check whether the main switch is in the ON position, and the power cord is completely plugged in.</li> <li>● Check whether the image source's resolution is set as the supported format (refer to section "Input Mode", p.24).</li> <li>● Check whether the cable is damaged or bent excessively.</li> </ul>
Nothing happens when switching the main switch on.	<ul style="list-style-type: none"> <li>● Unplug the power cord from the socket and plug it in again after a few seconds to reset the Signage. <b>Note:</b> Unplugging the power cord will not change the settings.</li> </ul>
Image is unstable.	<ul style="list-style-type: none"> <li>● Check whether the cable is completely plugged in.</li> </ul>
The remote control does not work.	<ul style="list-style-type: none"> <li>● Check whether there are batteries in the remote control.</li> <li>● Check the batteries for freshness, polarity, etc.</li> <li>● Check whether the remote is in the operation range.</li> <li>● Bright light may interfere with the remote control. Please avoid using the remote control near special fluorescent lights or neon lights.</li> </ul>
Auto on/off does not work or does not function properly.	<ul style="list-style-type: none"> <li>● Check whether the TIMER setting in the menu is set to "OFF".</li> <li>● Check whether the "Power On Time" and "Power Off Time" settings are set correctly.</li> </ul>
Cannot control the display remotely via RS-232.	<ul style="list-style-type: none"> <li>● Check whether the RS-232 cable is connected properly.</li> </ul>

If you are still having trouble with your DynaScan DS<sup>2</sup> Professional LCD, contact your dealer or DynaScan directly for more assistance.

# About DSM365

---

DSM365 is an internal operating system as Android, which can install the applications via USB flash drive storage, Micro SD card or Internet.

## How to Switch to DSM365

- Press the MENU button on either the rear panel control or remote control to show the OSD.
- Use the navigation arrows to select and adjust the Input Source.

[Input Source → Main → DSM365]

<b>Input Source</b>	<b>Main</b>	<b>DSM365</b>
Picture	Failover 1	HDMI
Time	Failover 2	DP
Video Wall	Failover 3	DVI
Backlight		
Advance		

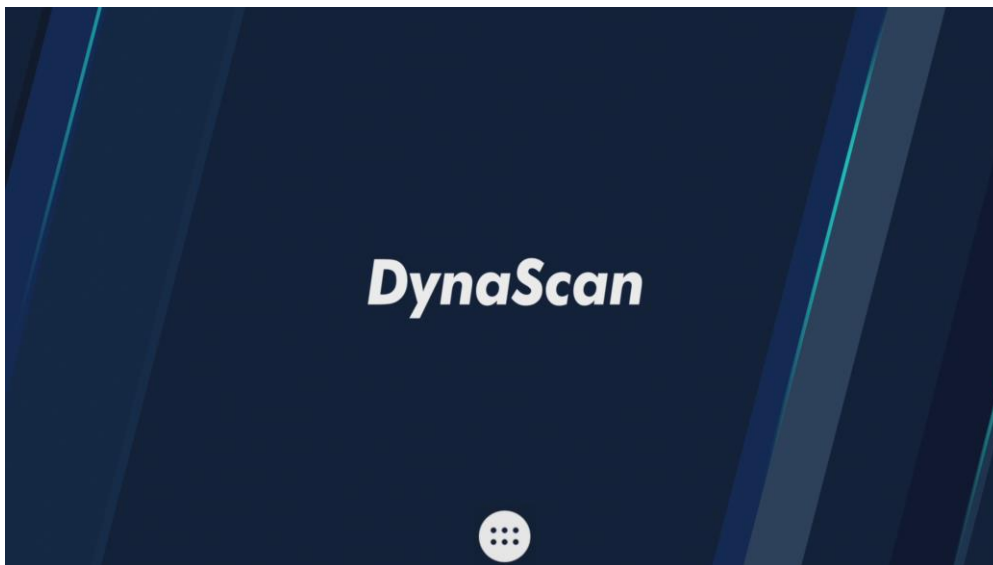

ITEM	DESCRIPTION
① APPS	Show the Installed APPS.

**[www.dynascandisplay.com](http://www.dynascandisplay.com)**

Copyright © DynaScan Technology, Inc. All Rights Reserved.