



SPORTON International Inc.

No. 52, Hwa Ya 1st Rd., Hwa Ya Technology Park, Kwei-Shan Hsiang, Tao Yuan Hsien, Taiwan, R.O.C.
Ph: 886-3-327-3456 / FAX: 886-3-327-0973 / www.sporton.com.tw

FCC RADIO TEST REPORT

Applicant's company	AOD Co., Ltd.
Applicant Address	No. 4 Building, 16 East Guangdian Road, High-tech Development Zone, Weifang, Shandong, 261061, China.
FCC ID	2AKWW-A22001462
Manufacturer's company	Abocom Systems, Inc.
Manufacturer Address	No.77, Yu-Yih Rd., Chu-Nan, Miao-Lih County 35059, Taiwan R.O.C.

Product Name	AW-B2 Super WiFi CPE/AP
Brand Name	AODGROUP
Model No.	A22001462
Test Rule	47 CFR FCC Part 15 Subpart C § 15.247
Test Freq. Range	2400 ~ 2483.5MHz
Received Date	Nov. 05, 2015
Final Test Date	Jan. 10, 2017
Submission Type	Original Equipment

Statement

Test result included in this report is for the IEEE 802.11n and IEEE 802.11b/g of the product.

The test result in this report refers exclusively to the presented test model / sample.

Without written approval of SPORTON International Inc., the test report shall not be reproduced except in full.

The measurements and test results shown in this test report were made in accordance with the procedures and found in compliance with the limit given in **ANSI C63.10-2013, 47 CFR FCC Part 15 Subpart C, KDB558074 D01 v03r05 and KDB 662911 D01 v02r01.**

The test equipment used to perform the test is calibrated and traceable to NML/ROC.



Table of Contents

1. VERIFICATION OF COMPLIANCE	1
2. SUMMARY OF THE TEST RESULT	2
3. GENERAL INFORMATION	3
3.1. Product Details.....	3
3.2. Accessories.....	4
3.3. Table for Filed Antenna.....	5
3.4. Table for Carrier Frequencies	5
3.5. Table for Test Modes.....	6
3.6. Table for Testing Locations.....	7
3.7. Table for Supporting Units	7
3.8. Table for Parameters of Test Software Setting	8
3.9. EUT Operation during Test	8
3.10. Duty Cycle.....	8
3.11. Test Configurations	9
4. TEST RESULT	12
4.1. AC Power Line Conducted Emissions Measurement.....	12
4.2. Maximum Conducted Output Power Measurement.....	16
4.3. Power Spectral Density Measurement	18
4.4. 6dB Spectrum Bandwidth Measurement	25
4.5. Radiated Emissions Measurement	32
4.6. Emissions Measurement	51
4.7. Antenna Requirements	69
5. LIST OF MEASURING EQUIPMENTS	70
6. MEASUREMENT UNCERTAINTY.....	71
APPENDIX A. TEST PHOTOS	A1 ~ A4
APPENDIX B. RADIATED EMISSION CO-LOCATION REPORT.....	B1 ~ B3
PHOTOGRAPHS OF EUT V01	



1. VERIFICATION OF COMPLIANCE

Product Name : AW-B2 Super WIFI CPE/AP
Brand Name : AODGROUP
Model No. : A22001462
Applicant : AOD Co., Ltd.
Test Rule Part(s) : 47 CFR FCC Part 15 Subpart C § 15.247

Sporton International as requested by the applicant to evaluate the EMC performance of the product sample received on Nov. 05, 2015 would like to declare that the tested sample has been evaluated and found to be in compliance with the tested rule parts. The data recorded as well as the test configuration specified is true and accurate for showing the sample's EMC nature.

Cliff Chang
SPORTON INTERNATIONAL INC.

2. SUMMARY OF THE TEST RESULT

Applied Standard: 47 CFR FCC Part 15 Subpart C			
Part	Rule Section	Description of Test	Result
4.1	15.207	AC Power Line Conducted Emissions	Complies
4.2	15.247(b)(3)	Maximum Conducted Output Power	Complies
4.3	15.247(e)	Power Spectral Density	Complies
4.4	15.247(a)(2)	6dB Spectrum Bandwidth	Complies
4.5	15.247(d)	Radiated Emissions	Complies
4.6	15.247(d)	Band Edge Emissions	Complies
4.7	15.203	Antenna Requirements	Complies

3. GENERAL INFORMATION

3.1. Product Details

Items	Description
Product Type	WLAN (2TX, 2RX)
Radio Type	Intentional Transceiver
Power Type	From power adapter and PoE
Modulation	IEEE 802.11b: DSSS IEEE 802.11g: OFDM IEEE 802.11n: see the below table
Data Modulation	IEEE 802.11b: DSSS (BPSK / QPSK / CCK) IEEE 802.11g/n: OFDM (BPSK / QPSK / 16QAM / 64QAM)
Data Rate (Mbps)	IEEE 802.11b: DSSS (1/ 2/ 5.5/11) IEEE 802.11g: OFDM (6/9/12/18/24/36/48/54) IEEE 802.11n: see the below table
Frequency Range	2400 ~ 2483.5MHz
Channel Number	11 for 20MHz bandwidth ; 7 for 40MHz bandwidth
Channel Band Width (99%)	IEEE 802.11b: 13.72 MHz IEEE 802.11g: 16.50 MHz IEEE 802.11n MCS0 (HT20): 17.63 MHz IEEE 802.11n MCS0 (HT40): 36.47 MHz
Maximum Conducted Output Power	IEEE 802.11b: 24.26 dBm IEEE 802.11g: 21.66 dBm IEEE 802.11n MCS0 (HT20): 22.06 dBm IEEE 802.11n MCS0 (HT40): 21.87 dBm
Carrier Frequencies	Please refer to section 3.4
Antenna	Please refer to section 3.3

Items	Description	
Beamforming Function	<input type="checkbox"/> With beamforming	<input checked="" type="checkbox"/> Without beamforming

Antenna and Band width

Antenna	Two (TX)	
Band width Mode	20 MHz	40 MHz
IEEE 802.11b	V	X
IEEE 802.11g	V	X
IEEE 802.11n	V	V

IEEE 11n Spec.

Protocol	Number of Transmit Chains (NTX)	Data Rate / MCS
802.11n (HT20)	2	MCS 0-15
802.11n (HT40)	2	MCS 0-15

Note 1: IEEE Std. 802.11n modulation consists of HT20 and HT40 (HT: High Throughput).
Then EUT supports HT20 and HT40.

Note 2: Modulation modes consist of below configuration: HT20/HT40: IEEE 802.11n

3.2. Accessories

Power	Brand	Model No.	Rating	Remark
Adapter	MW	GST25U24	Input: 100-240VAC, 50/60Hz, 0.6A Output: 24V, 1.04A, 25W MAX.	-
PoE	CERiO	POE-PE03GE	-	With adapter use

3.3. Table for Filed Antenna

Ant.	Brand	Model Name	Antenna Type	Connector	Gain (dBi)	
					2.4GHz	5GHz
1	SmartAnt	ABO14-220550	Directional Antenna	I-PEX	6	9

Note: Chain 1 and Chain 2 could transmit/receive simultaneously.

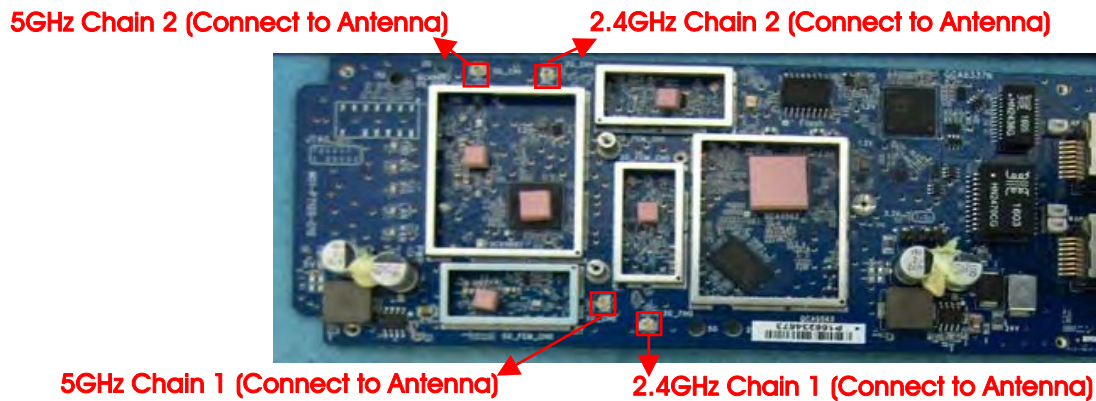

3.4. Table for Carrier Frequencies

There are two bandwidth systems.

For 20MHz bandwidth systems, use Channel 1~Channel 11.

For 40MHz bandwidth systems, use Channel 3~Channel 9.

Frequency Band	Channel No.	Frequency	Channel No.	Frequency
2400~2483.5MHz	1	2412 MHz	7	2442 MHz
	2	2417 MHz	8	2447 MHz
	3	2422 MHz	9	2452 MHz
	4	2427 MHz	10	2457 MHz
	5	2432 MHz	11	2462 MHz
	6	2437 MHz	-	-

3.5. Table for Test Modes

Preliminary tests were performed in different data rate to find the worst radiated emission. The data rate shown in the table below is the worst-case rate with respect to the specific test item. Investigation has been done on all the possible configurations for searching the worst cases. The following table is a list of the test modes shown in this test report.

Test Items	Mode	Data Rate	Channel	Chain
AC Power Line Conducted Emissions	Normal Link	-	-	-
Maximum Conducted Output Power	11b/CCK	1 Mbps	1/6/11	1+2
	11g/BPSK	6 Mbps	1/6/11	1+2
	11n HT20	MCS0	1/6/11	1+2
	11n HT40	MCS0	3/6/9	1+2
Power Spectral Density	11b/CCK	1 Mbps	1/6/11	1+2
	11g/BPSK	6 Mbps	1/6/11	1+2
	11n HT20	MCS0	1/6/11	1+2
	11n HT40	MCS0	3/6/9	1+2
6dB Spectrum Bandwidth	11b/CCK	1 Mbps	1/6/11	1+2
	11g/BPSK	6 Mbps	1/6/11	1+2
	11n HT20	MCS0	1/6/11	1+2
	11n HT40	MCS0	3/6/9	1+2
Radiated Emissions 9kHz~1GHz	Normal Link	-	-	-
Radiated Emissions 1GHz~10 th Harmonic	11b/CCK	1 Mbps	1/6/11	1+2
	11g/BPSK	6 Mbps	1/6/11	1+2
	11n HT20	MCS0	1/6/11	1+2
	11n HT40	MCS0	3/6/9	1+2
Band Edge Emissions	11b/CCK	1 Mbps	1/6/11	1+2
	11g/BPSK	6 Mbps	1/6/11	1+2
	11n HT20	MCS0	1/6/11	1+2
	11n HT40	MCS0	3/6/9	1+2

Note: The EUT can used in Y-axis only.

For Co-location MPE and Radiated Emission Co-location test:

The EUT could be applied with 2.4GHz WLAN function and 5GHz WLAN function; therefore Co-location Maximum Permissible Exposure (Please refer to FA5N0420-03) and Radiated Emission Co-location (please refer to Appendix B) tests are added for simultaneously transmit between 2.4GHz WLAN function and 5GHz WLAN function.

3.6. Table for Testing Locations

Test Site Location				
Address:	No.8, Lane 724, Bo-ai St., Jhubei City, Hsinchu County 302, Taiwan, R.O.C.			
TEL:	886-3-656-9065			
FAX:	886-3-656-9085			
Test Site No.	Site Category	Location	FCC Reg. No.	IC File No.
03CH01-CB	SAC	Hsin Chu	TW0006	IC 4086D
CO02-CB	Conduction	Hsin Chu	TW0006	IC 4086D
TH01-CB	OVEN Room	Hsin Chu	-	-

Open Area Test Site (OATS); Semi Anechoic Chamber (SAC).

3.7. Table for Supporting Units

For Test Site No: 03CH01-CB (below 1GHz)

Support Unit	Brand	Model	FCC ID
Notebook*2	DELL	E4300	DoC
Notebook*2	Apple	Mac Book	DoC

For Test Site No: 03CH01-CB (above 1GHz) and TH01-CB

Support Unit	Brand	Model	FCC ID
Notebook	DELL	E4300	DoC

For Test Site No: CO02-CB

Support Unit	Brand	Model	FCC ID
Notebook*4	DELL	E6430	DoC

3.8. Table for Parameters of Test Software Setting

During testing, Channel and Power Controlling Software provided by the customer was used to control the operating channel as well as the output power level. The RF output power selection is for the setting of RF output power expected by the customer and is going to be fixed on the firmware of the final end product.

Test Software Version	ART2-GUI 2.3					
Mode	Test Frequency (MHz)					
	NCB: 20MHz			NCB: 40MHz		
	2412 MHz	2437 MHz	2462 MHz	2422 MHz	2437 MHz	2452 MHz
802.11b	18	20	20.5	-	-	-
802.11g	15.5	15	18	-	-	-
802.11n MCS0 HT20	15.5	15.5	18.5	-	-	-
802.11n MCS0 HT40	-	-	-	14	18	16.5

3.9. EUT Operation during Test

The EUT was programmed to be in continuously transmitting mode.

3.10. Duty Cycle

Mode	On Time (ms)	On+Off Time (ms)	Duty Cycle (%)	Duty Factor (dB)	1/T Minimum VBW (kHz)
802.11b	1.000	1.000	100.00	0.00	0.01
802.11g	2.022	2.076	97.37	0.12	0.49
802.11n MCS0 HT20	1.875	1.939	96.69	0.15	0.53
802.11n MCS0 HT40	0.912	0.964	94.51	0.25	1.10

3.11. Test Configurations

3.11.1. AC Power Line Conduction Emissions Test Configuration

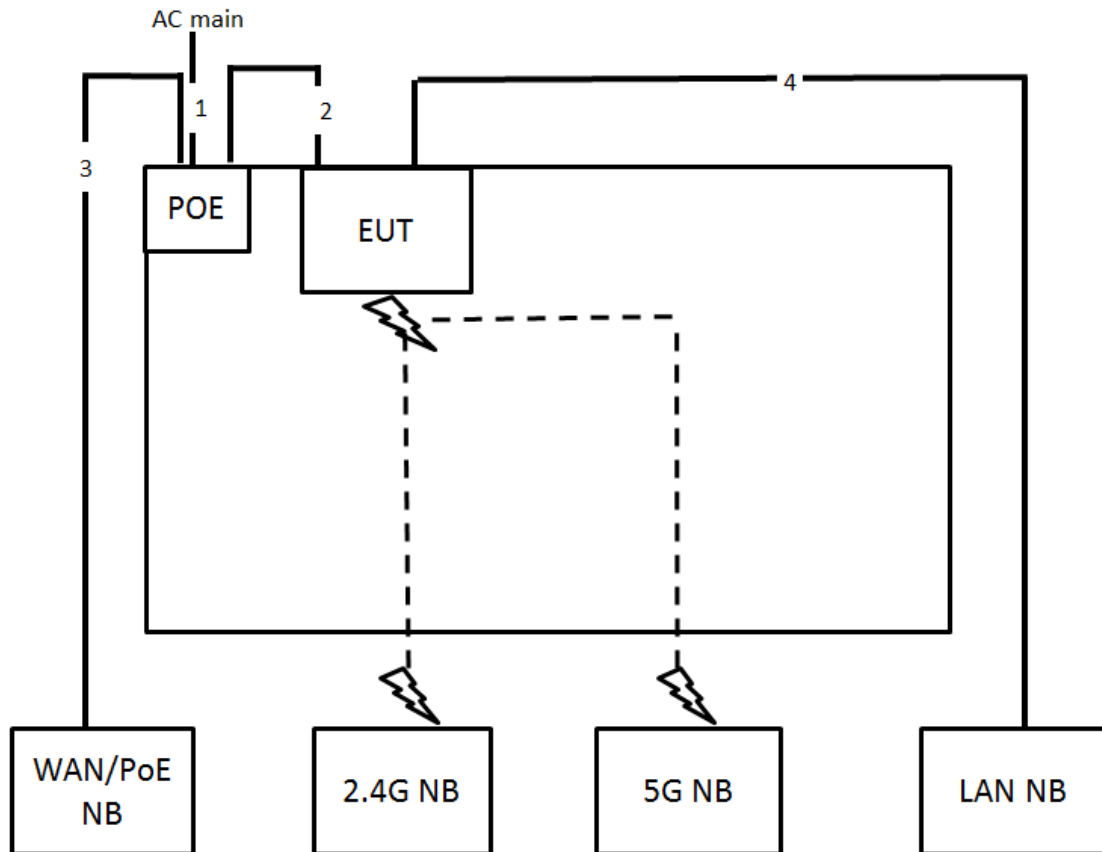

Item	Connection	Shielded	Length
1	Power cable	No	1.8m
2	RJ-45 cable	No	1.5m
3	RJ-45 cable	No	10m
4	RJ-45 cable	No	10m

3.11.2. Radiation Emissions Test Configuration

Test Configuration: 30MHz~1GHz

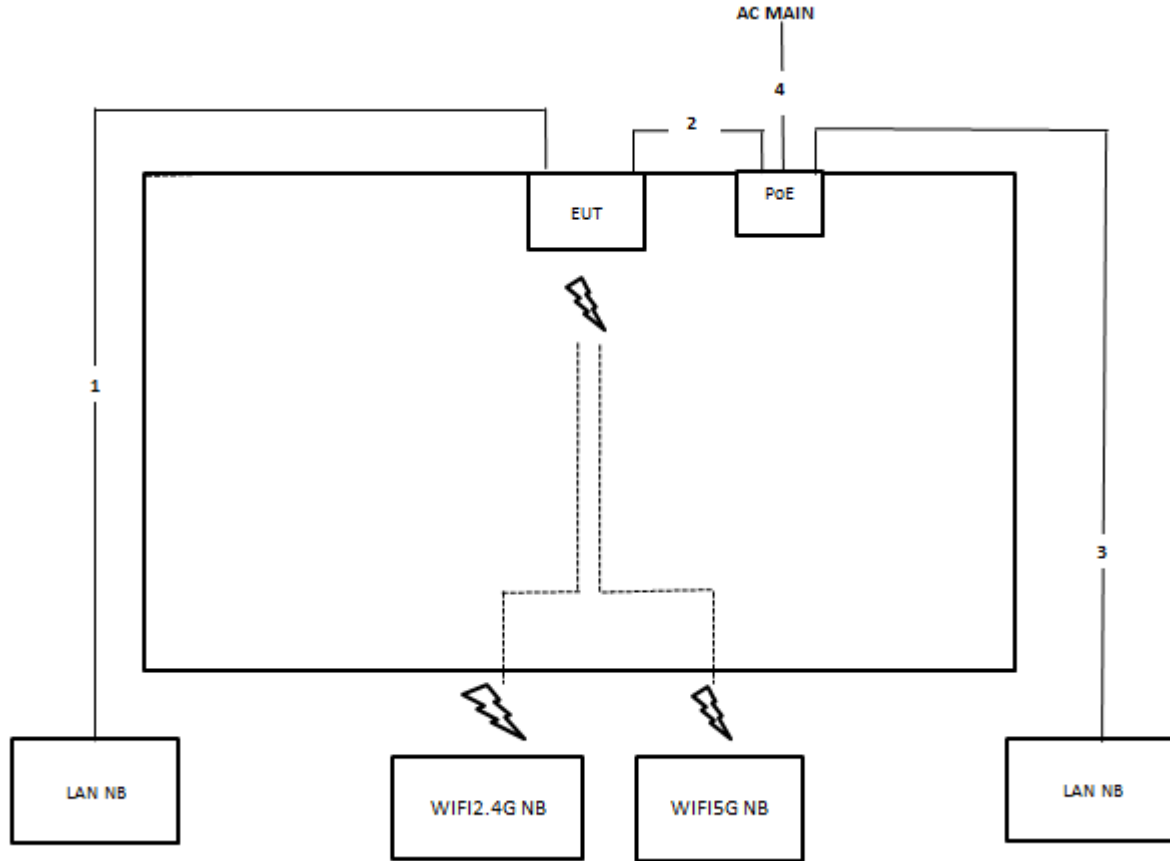

Item	Connection	Shielded	Length
1	RJ-45 cable	No	10m
2	RJ-45 cable	No	1.5m
3	RJ-45 cable	No	10m
4	Power cable	No	1.8m

Test Configuration: above 1GHz

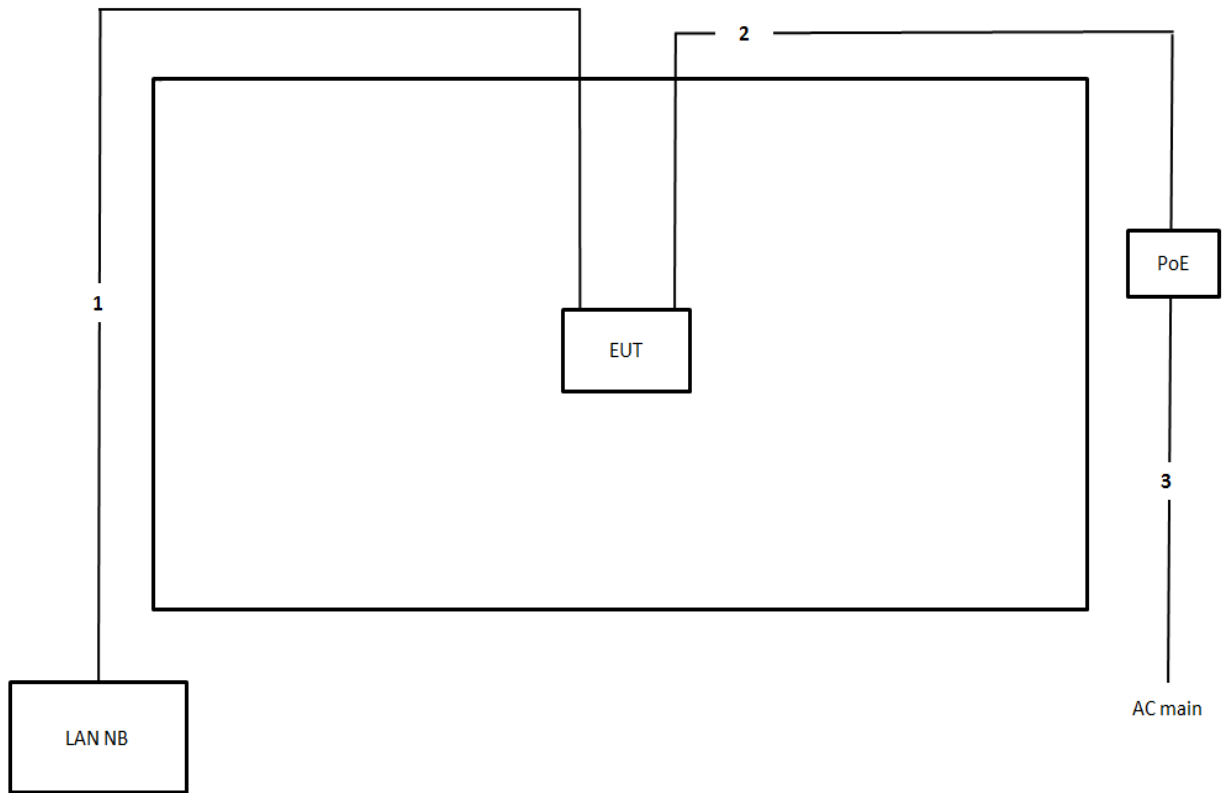

Item	Connection	Shielded	Length
1	RJ-45 cable	No	10m
2	RJ-45 cable	No	10m
3	Power cable	No	1.8m

4. TEST RESULT

4.1. AC Power Line Conducted Emissions Measurement

4.1.1. Limit

For this product which is designed to be connected to the AC power line, the radio frequency voltage that is conducted back onto the AC power line on any frequency or frequencies within the band 150 kHz to 30 MHz shall not exceed below limits table.

Frequency (MHz)	QP Limit (dBuV)	AV Limit (dBuV)
0.15~0.5	66~56	56~46
0.5~5	56	46
5~30	60	50

4.1.2. Measuring Instruments and Setting

Please refer to section 5 of equipments list in this report. The following table is the setting of the receiver.

Receiver Parameters	Setting
Attenuation	10 dB
Start Frequency	0.15 MHz
Stop Frequency	30 MHz
IF Bandwidth	9 kHz

4.1.3. Test Procedures

1. Configure the EUT according to ANSI C63.10. The EUT or host of EUT has to be placed 0.4 meter far from the conducting wall of the shielding room and at least 80 centimeters from any other grounded conducting surface.
2. Connect EUT or host of EUT to the power mains through a line impedance stabilization network (LISN).
3. All the support units are connected to the other LISNs. The LISN should provide 50uH/50ohms coupling impedance.
4. The frequency range from 150 kHz to 30 MHz was searched.
5. Set the test-receiver system to Peak Detect Function and Specified Bandwidth with Maximum Hold Mode.
6. The measurement has to be done between each power line and ground at the power terminal.

4.1.7. Results of AC Power Line Conducted Emissions Measurement

Temperature	23°C	Humidity	55%
Test Engineer	GN Hou / Deven Huang	Phase	Line
Configuration	Normal Link		

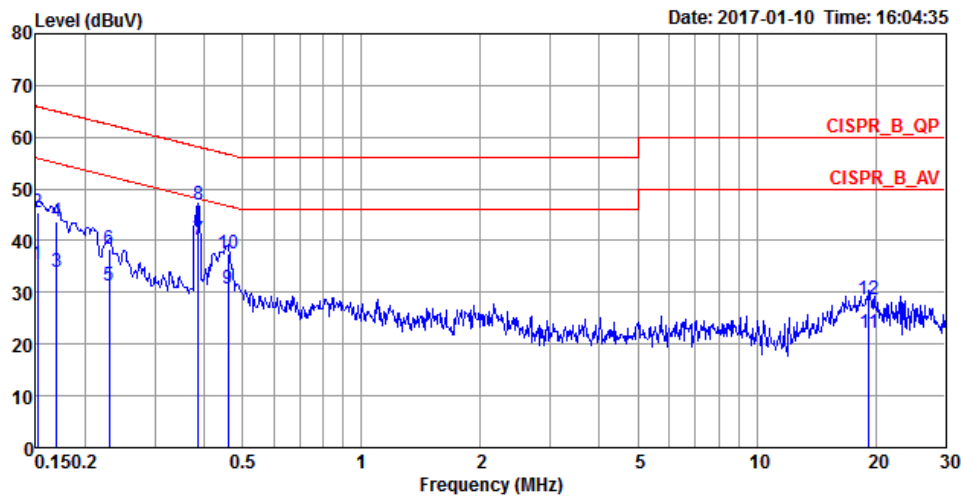

	Freq	Level	Over Limit	Limit Line	Read Level	LISN Factor	Cable Loss	Remark	Pol/Phase
	MHz	dBuV	dB	dBuV	dBuV	dB	dB		
1	0.1516	35.44	-20.47	55.91	25.45	9.95	0.04	Average	LINE
2	0.1516	45.48	-20.43	65.91	35.49	9.95	0.04	QP	LINE
3	0.1694	33.93	-21.06	54.99	23.95	9.94	0.04	Average	LINE
4	0.1694	43.73	-21.26	64.99	33.75	9.94	0.04	QP	LINE
5	0.2304	31.16	-21.28	52.44	21.19	9.92	0.05	Average	LINE
6	0.2304	38.26	-24.18	62.44	28.29	9.92	0.05	QP	LINE
7	0.3872	40.09	-8.03	48.12	30.16	9.89	0.04	Average	LINE
8	0.3872	46.85	-11.27	58.12	36.92	9.89	0.04	QP	LINE
9	0.4588	30.56	-16.15	46.71	20.62	9.90	0.04	Average	LINE
10	0.4588	37.59	-19.12	56.71	27.65	9.90	0.04	QP	LINE
11	19.2236	22.00	-28.00	50.00	11.54	10.21	0.25	Average	LINE
12	19.2236	28.61	-31.39	60.00	18.15	10.21	0.25	QP	LINE

Temperature	23°C	Humidity	55%
Test Engineer	GN Hou / Deven Huang	Phase	Neutral
Configuration	Normal Link		

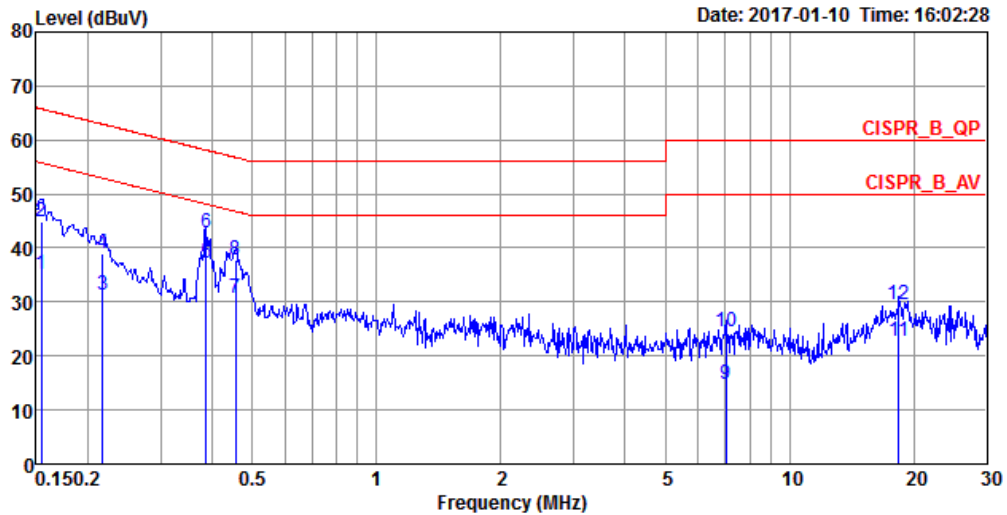

	Freq	Level	Over Limit	Limit Line	Read Level	LISN Factor	Cable Loss	Remark	Pol/Phase
	MHz	dBuV	dB	dBuV	dBuV	dB	dB		
1	0.1540	35.13	-20.65	55.78	25.15	9.94	0.04	Average	NEUTRAL
2	0.1540	45.00	-20.78	65.78	35.02	9.94	0.04	QP	NEUTRAL
3	0.2174	31.40	-21.52	52.92	21.37	9.98	0.05	Average	NEUTRAL
4	0.2174	38.97	-23.95	62.92	28.94	9.98	0.05	QP	NEUTRAL
5	0.3872	37.19	-10.93	48.12	27.19	9.96	0.04	Average	NEUTRAL
6	0.3872	42.93	-15.19	58.12	32.93	9.96	0.04	QP	NEUTRAL
7	0.4564	30.66	-16.10	46.76	20.66	9.96	0.04	Average	NEUTRAL
8	0.4564	37.68	-19.08	56.76	27.68	9.96	0.04	QP	NEUTRAL
9	7.0249	14.69	-35.31	50.00	4.40	10.13	0.16	Average	NEUTRAL
10	7.0249	24.53	-35.47	60.00	14.24	10.13	0.16	QP	NEUTRAL
11	18.4258	22.81	-27.19	50.00	12.30	10.27	0.24	Average	NEUTRAL
12	18.4258	29.66	-30.34	60.00	19.15	10.27	0.24	QP	NEUTRAL

Note:

Level = Read Level + LISN Factor + Cable Loss.

4.2. Maximum Conducted Output Power Measurement

4.2.1. Limit

The limit for output power is 30dBm.

4.2.2. Measuring Instruments and Setting

Please refer to section 5 of equipments list in this report. The following table is the setting of the power meter.

Power Meter Parameter	Setting
Bandwidth	50MHz bandwidth is greater than the EUT emission bandwidth
Detector	Average

4.2.3. Test Procedures

1. Test procedures refer KDB558074 D01 v03r05 section 9.2.3.2 Measurement using a power meter (PM).
2. Multiple antenna systems was performed in accordance with KDB 662911 D01 v02r01 Emissions Testing of Transmitters with Multiple Outputs in the Same Band.
3. This procedure provides an alternative for determining the RMS output power using a broadband RF average power meter with a thermocouple detector.

4.2.4. Test Setup Layout

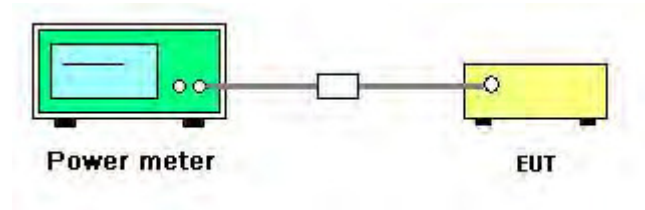

4.2.5. Test Deviation

There is no deviation with the original standard.

4.2.6. EUT Operation during Test

The EUT was programmed to be in continuously transmitting mode.

4.2.7. Test Result of Maximum Conducted Output Power

Temperature	25°C	Humidity	45%
Test Engineer	Lucas Huang	Test Date	Nov. 24, 2015

Mode	Frequency	Conducted Power (dBm)			Max. Limit (dBm)	Result
		Chain 1	Chain 2	Total		
802.11b	2412 MHz	19.21	19.33	22.28	30.00	Complies
	2437 MHz	21.19	21.31	24.26	30.00	Complies
	2462 MHz	21.04	21.08	24.07	30.00	Complies
802.11g	2412 MHz	16.77	16.91	19.85	30.00	Complies
	2437 MHz	16.38	16.13	19.27	30.00	Complies
	2462 MHz	18.42	18.87	21.66	30.00	Complies
802.11n MCS0 HT20	2412 MHz	16.07	16.44	19.27	30.00	Complies
	2437 MHz	16.42	16.51	19.48	30.00	Complies
	2462 MHz	19.02	19.08	22.06	30.00	Complies
802.11n MCS0 HT40	2422 MHz	15.08	15.62	18.37	30.00	Complies
	2437 MHz	18.79	18.92	21.87	30.00	Complies
	2452 MHz	16.64	17.08	19.88	30.00	Complies

4.3. Power Spectral Density Measurement

4.3.1. Limit

For digitally modulated systems, the power spectral density conducted from the intentional radiator to the antenna shall not be greater than 8 dBm in any 3 kHz band during any time interval of continuous transmission.

4.3.2. Measuring Instruments and Setting

Please refer to section 5 of equipments list in this report. The following table is the setting of the spectrum analyzer.

Spectrum Parameter	Setting
Attenuation	Auto
Span Frequency	Set the span to 1.5 times the DTS channel bandwidth.
RBW	$3 \text{ kHz} \leq \text{RBW} \leq 100\text{kHz}$
VBW	$\geq 3 \times \text{RBW}$
Detector	Peak
Trace	Max Hold
Sweep Time	Auto couple

4.3.3. Test Procedures

1. Test was performed in accordance with KDB558074 D01 v03r05 for Performing Compliance Measurements on Digital Transmission Systems (DTS) - section 10.2 Method PKPSD (peak PSD) and KDB 662911 D01 v02r01 section In-Band Power Spectral Density (PSD) Measurements option (b) Measure and sum spectral maximal across the outputs.
2. Use this procedure when the maximum conducted output power in the fundamental emission is used to demonstrate compliance. The EUT must be configured to transmit continuously at full power over the measurement duration.
3. Ensure that the number of measurement points in the sweep $\geq 2 \times \text{span}/\text{RBW}$ (use of a greater number of measurement points than this minimum requirement is recommended).
4. Use the peak marker function to determine the maximum level in any 3 kHz band segment within the fundamental EBW.
5. The resulting PSD level must be $\leq 8 \text{ dBm}$.

4.3.4. Test Setup Layout

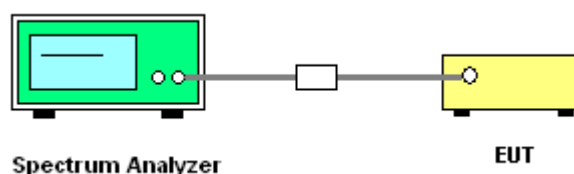

4.3.5. Test Deviation

There is no deviation with the original standard.

4.3.6. EUT Operation during Test

The EUT was programmed to be in continuously transmitting mode.

4.3.7. Test Result of Power Spectral Density

Temperature	25°C	Humidity	45%
Test Engineer	Lucas Huang		

Mode	Frequency	Power Density (dBm/3kHz)			Power Density Limit (dBm/3kHz)	Result
		Chain 1	Chain 2	Total		
802.11b	2412 MHz	-4.64	-4.46	-1.54	4.99	Complies
	2437 MHz	-2.78	-2.79	0.23	4.99	Complies
	2462 MHz	-2.03	-3.34	0.37	4.99	Complies
802.11g	2412 MHz	-11.08	-10.36	-7.69	4.99	Complies
	2437 MHz	-10.60	-9.46	-6.98	4.99	Complies
	2462 MHz	-6.66	-6.68	-3.66	4.99	Complies
802.11n MCS0 HT20	2412 MHz	-10.73	-11.41	-8.05	4.99	Complies
	2437 MHz	-10.08	-9.57	-6.81	4.99	Complies
	2462 MHz	-7.02	-6.65	-3.82	4.99	Complies
802.11n MCS0 HT40	2422 MHz	-14.48	-13.60	-11.01	4.99	Complies
	2437 MHz	-10.52	-9.84	-7.16	4.99	Complies
	2452 MHz	-12.60	-12.79	-9.68	4.99	Complies

Note: $Directional\ Gain = 10 \log \left[\frac{\sum_{j=1}^{N_{SS}} \left(\sum_{K=1}^{N_{ANT}} g_{j,k} \right)^2}{N_{ANT}} \right] = 9.01\text{ dBi} > 6\text{dBi}$, so limit = $8 - (9.01 - 6) = 4.99\text{dBm}/3\text{kHz}$.

Note: All the test values were listed in the report.

For plots, only the channel with worse result was shown.

Power Density Plot on Configuration IEEE 802.11b / 2462 MHz / Chain 1

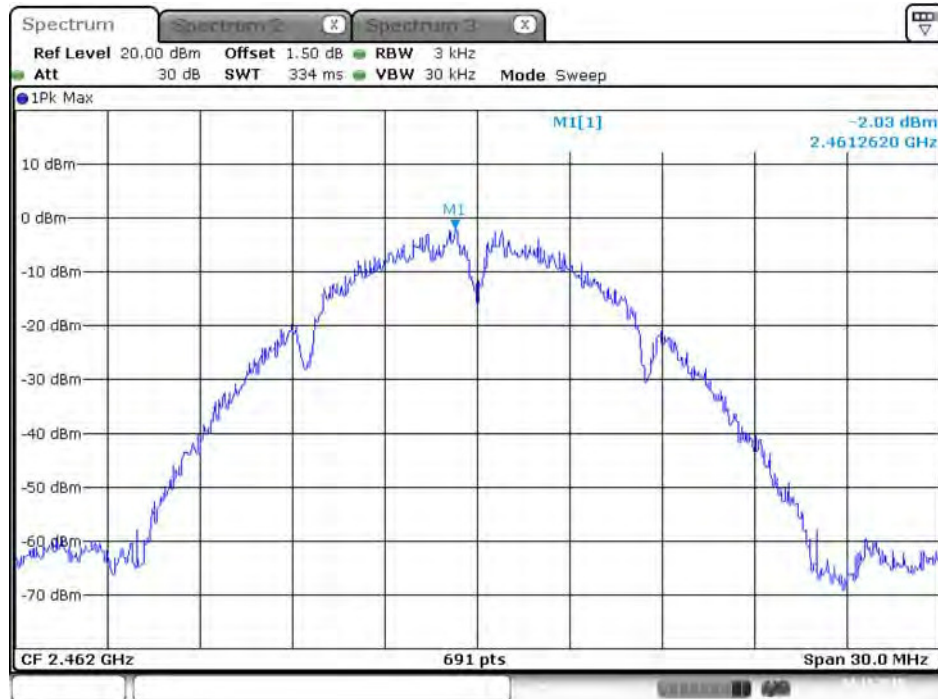

Date: 24.NOV.2015 01:41:47

Power Density Plot on Configuration IEEE 802.11b / 2462 MHz / Chain 2

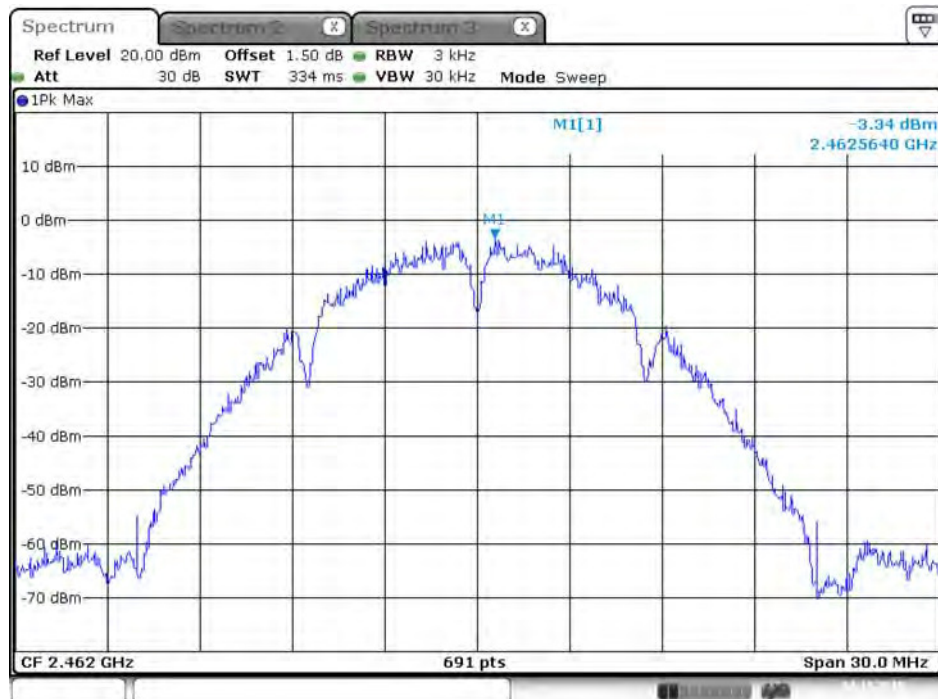

Date: 24.NOV.2015 01:42:03

Power Density Plot on Configuration IEEE 802.11g / 2462 MHz / Chain 1

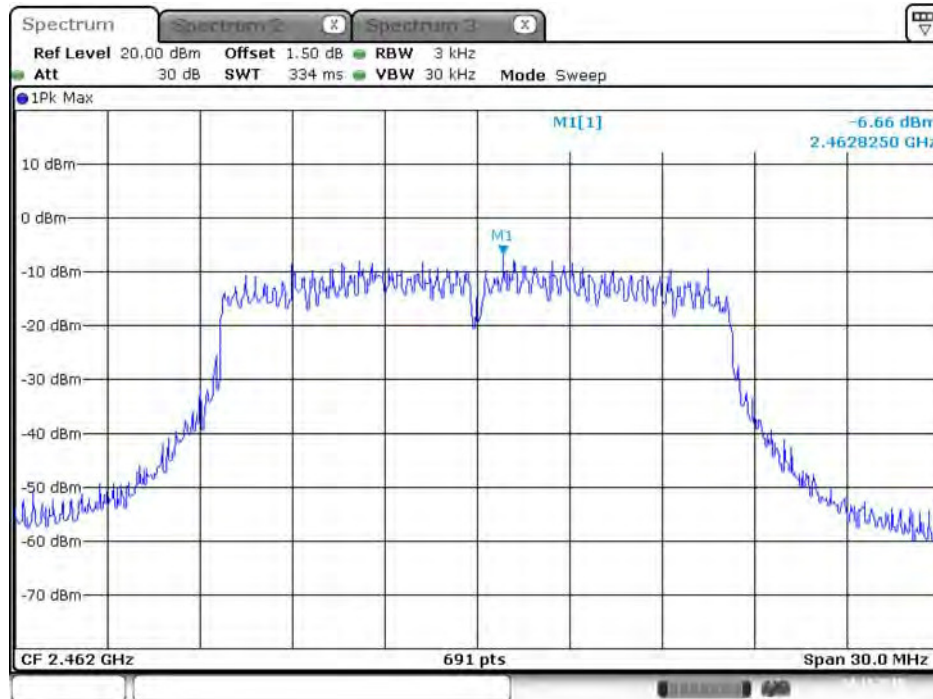

Date: 24.NOV.2015 01:44:12

Power Density Plot on Configuration IEEE 802.11g / 2462 MHz / Chain 2

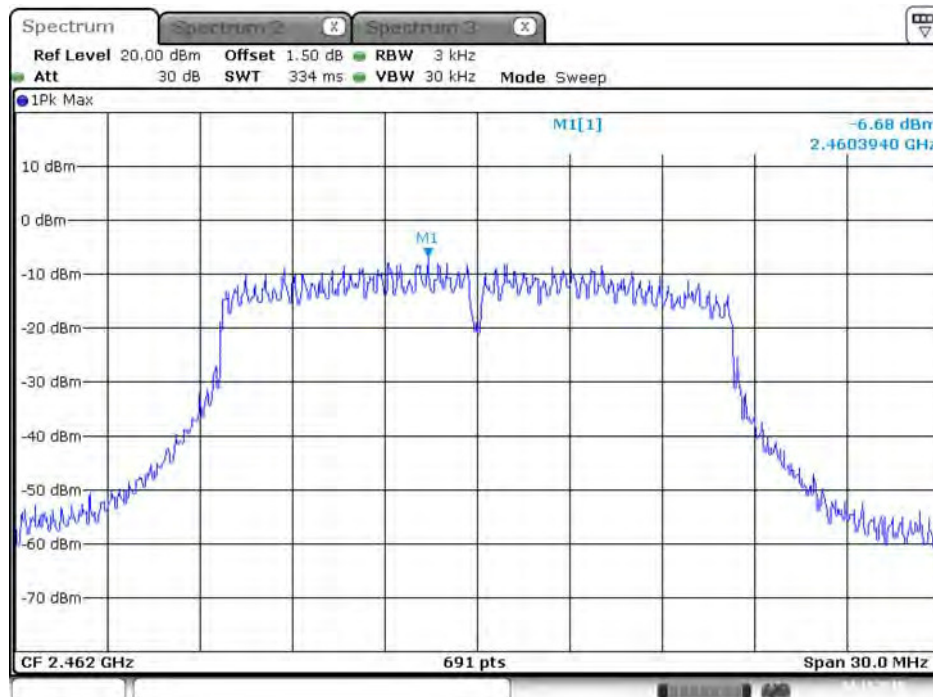

Date: 24.NOV.2015 01:44:21

Power Density Plot on Configuration IEEE 802.11n MCS0 HT20 / 2462 MHz / Chain 1

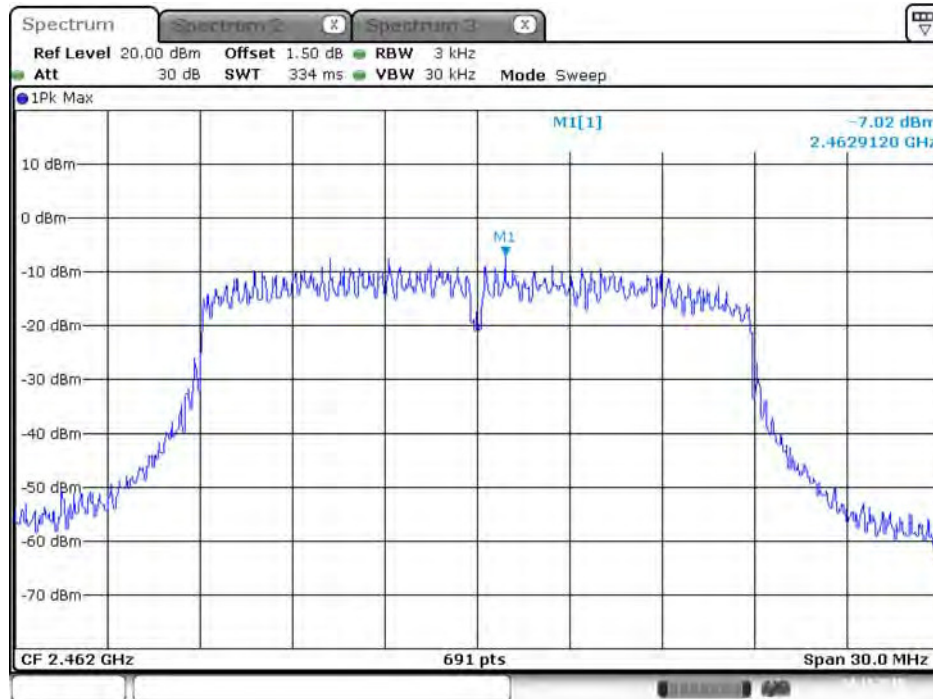

Date: 24.NOV.2015 01:46:02

Power Density Plot on Configuration IEEE 802.11n MCS0 HT20 / 2462 MHz / Chain 2

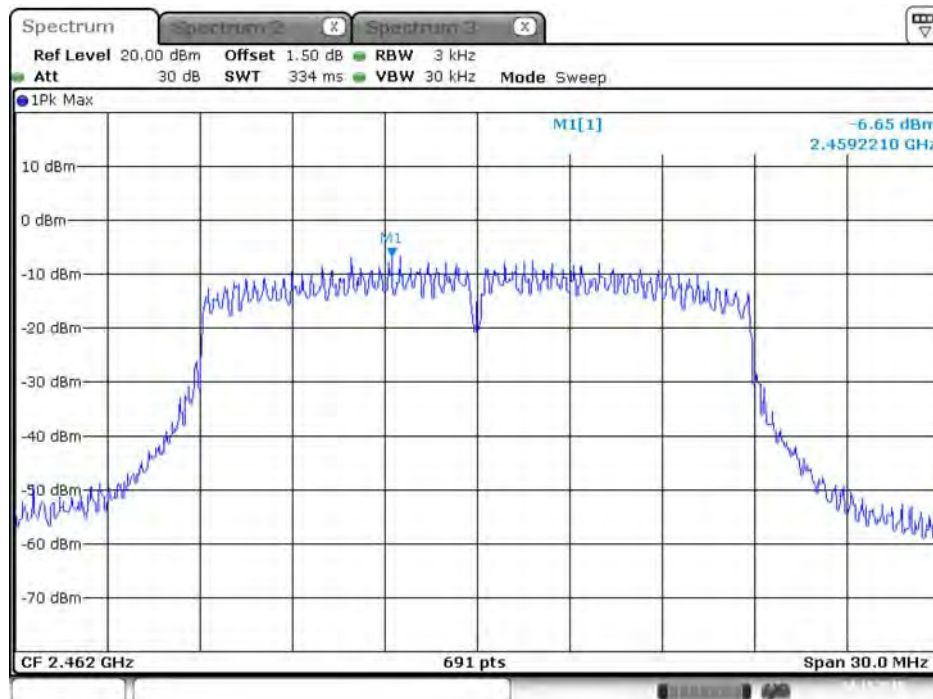

Date: 24.NOV.2015 01:46:14

Power Density Plot on Configuration IEEE 802.11n MCS0 HT40 / 2437 MHz / Chain 1

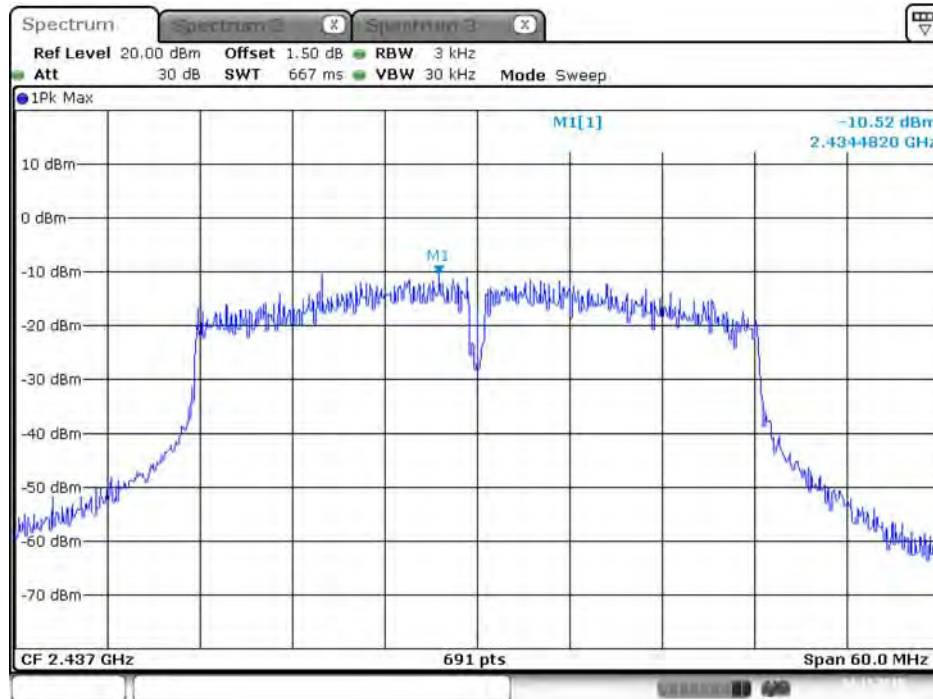

Date: 24.NOV.2015 01:47:51

Power Density Plot on Configuration IEEE 802.11n MCS0 HT40 / 2437 MHz / Chain 2

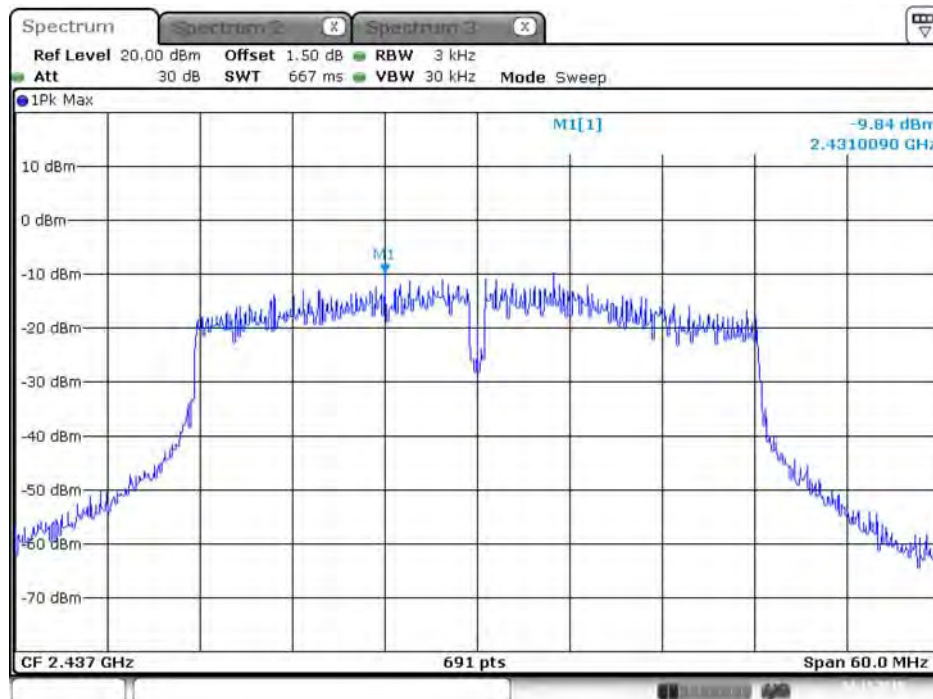

Date: 24.NOV.2015 01:48:01

4.4. 6dB Spectrum Bandwidth Measurement

4.4.1. Limit

For digital modulation systems, the minimum 6 dB bandwidth shall be at least 500 kHz.

4.4.2. Measuring Instruments and Setting

Please refer to section 5 of equipments list in this report. The following table is the setting of the Spectrum Analyzer.

6dB Spectrum Bandwidth	
Spectrum Parameters	Setting
Attenuation	Auto
Span Frequency	> 6dB Bandwidth
RBW	100kHz
VBW	$\geq 3 \times \text{RBW}$
Detector	Peak
Trace	Max Hold
Sweep Time	Auto
99% Occupied Bandwidth	
Spectrum Parameters	Setting
Span	1.5 times to 5.0 times the OBW
RBW	1 % to 5 % of the OBW
VBW	$\geq 3 \times \text{RBW}$
Detector	Peak
Trace	Max Hold

4.4.3. Test Procedures

For Radiated 6dB Bandwidth Measurement:

1. The transmitter was radiated to the spectrum analyzer in peak hold mode.
2. Test was performed in accordance with KDB558074 D01 v03r05 for Performing Compliance Measurements on Digital Transmission Systems (DTS) - section 8.0 DTS bandwidth => 8.1 Option 1.
3. Multiple antenna system was performed in accordance with KDB 662911 D01 v02r01 Emissions Testing of Transmitters with Multiple Outputs in the Same Band.
4. Measured the spectrum width with power higher than 6dB below carrier.

4.4.4. Test Setup Layout

For Radiated 6dB Bandwidth Measurement:

This test setup layout is the same as that shown in section 4.5.4.

4.4.5. Test Deviation

There is no deviation with the original standard.

4.4.6. EUT Operation during Test

The EUT was programmed to be in continuously transmitting mode.

4.4.7. Test Result of 6dB Spectrum Bandwidth

Temperature	25°C	Humidity	45%
Test Engineer	Lucas Huang		

Mode	Frequency	6dB Bandwidth (MHz)	99% Occupied Bandwidth (MHz)	Min. Limit (kHz)	Test Result
802.11b	2412 MHz	6.49	13.72	500	Complies
	2437 MHz	6.49	13.72	500	Complies
	2462 MHz	4.06	9.81	500	Complies
802.11g	2412 MHz	13.22	16.50	500	Complies
	2437 MHz	13.22	15.20	500	Complies
	2462 MHz	12.64	15.37	500	Complies
802.11n MCS0 HT20	2412 MHz	8.75	15.89	500	Complies
	2437 MHz	11.30	17.63	500	Complies
	2462 MHz	10.84	15.80	500	Complies
802.11n MCS0 HT40	2422 MHz	20.06	35.89	500	Complies
	2437 MHz	15.65	35.89	500	Complies
	2452 MHz	24.81	36.47	500	Complies

Note: All the test values were listed in the report.

For plots, only the channel with worse result was shown.

6 dB Bandwidth Plot on Configuration IEEE 802.11b / 2462 MHz / Chain 1 + Chain 2

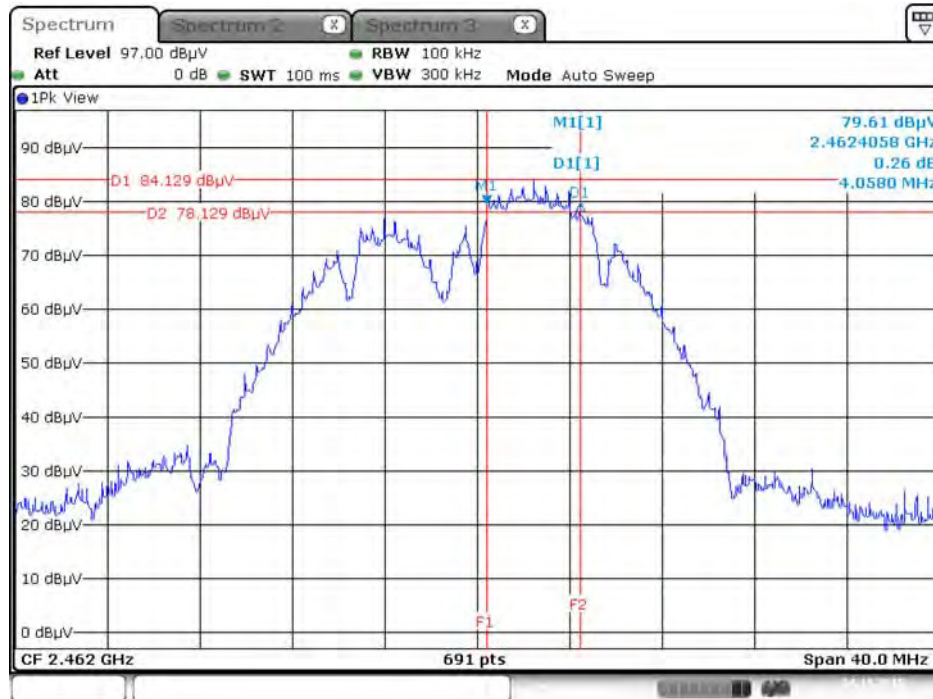

Date: 24.NOV.2015 01:58:11

99% Occupied Bandwidth Plot on Configuration IEEE 802.11b / 2412 MHz / Chain 1 + Chain 2

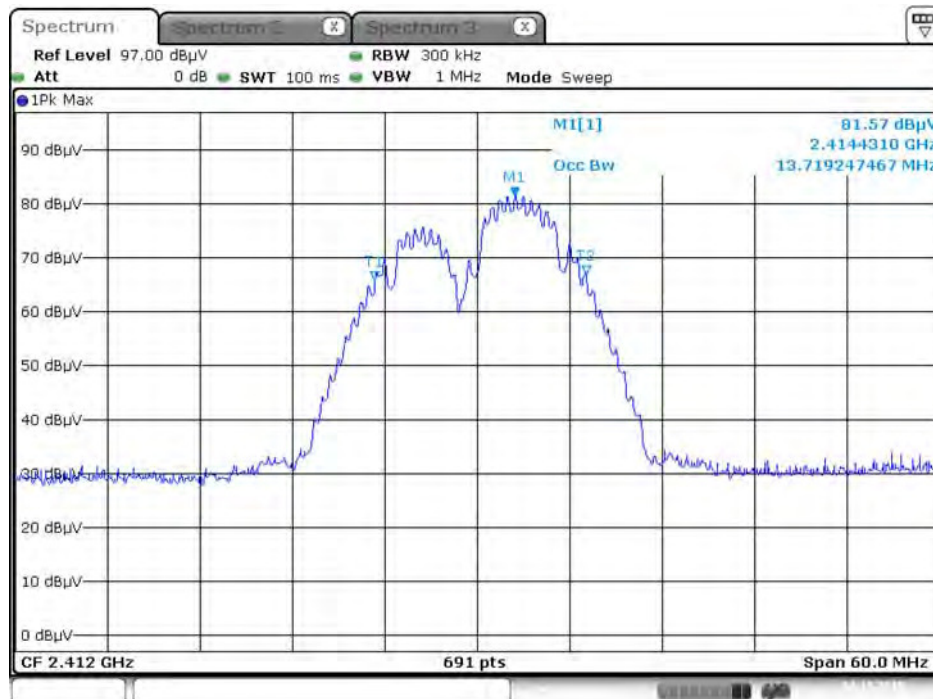

Date: 24.NOV.2015 01:50:35

6 dB Bandwidth Plot on Configuration IEEE 802.11g / 2462 MHz / Chain 1 + Chain 2

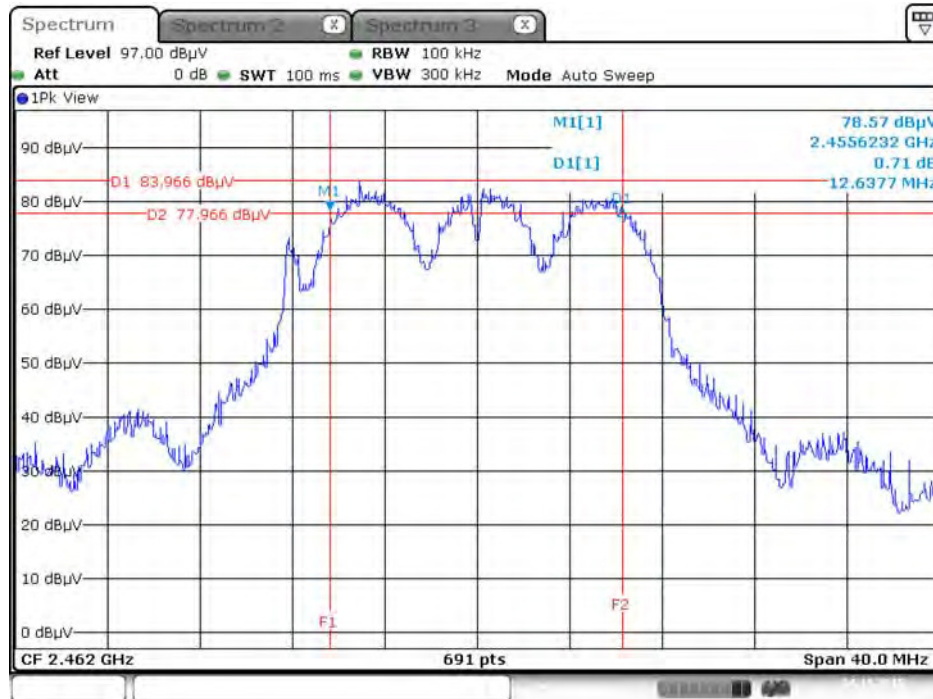

Date: 24.NOV.2015 01:59:32

99% Occupied Bandwidth Plot on Configuration IEEE 802.11g / 2412 MHz / Chain 1 + Chain 2

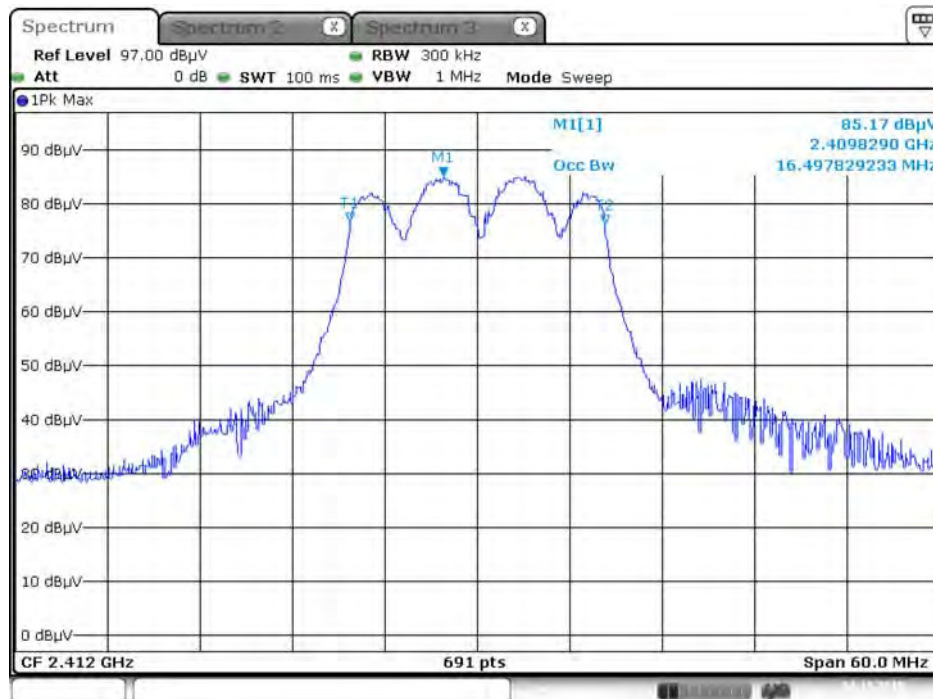

Date: 24.NOV.2015 01:51:57

6 dB Bandwidth Plot on Configuration IEEE 802.11n MCS0 HT20 / 2412 MHz / Chain 1 + Chain 2

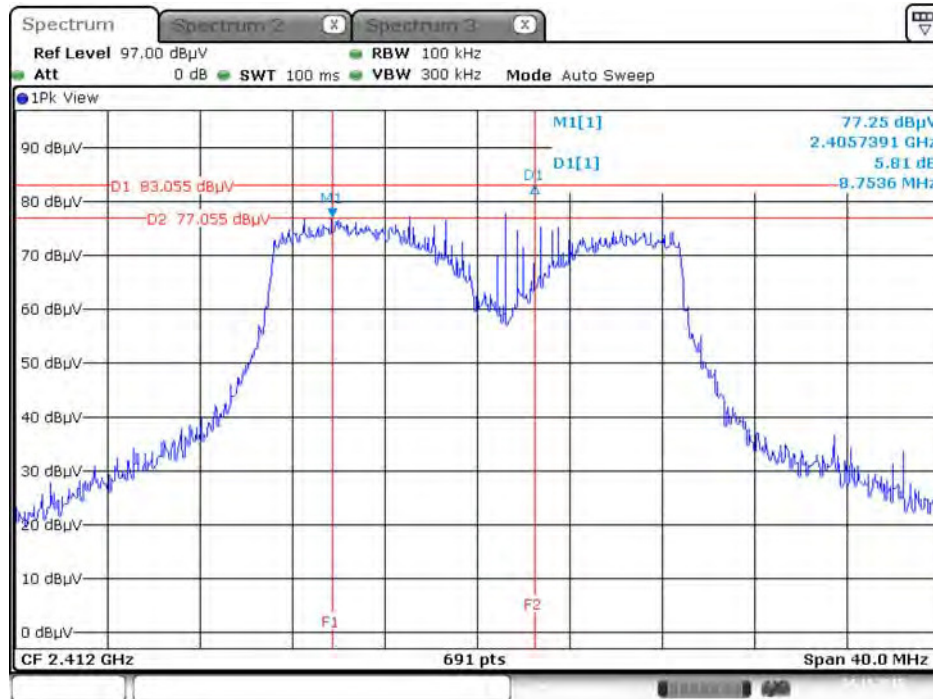

Date: 24.NOV.2015 02:00:42

99% Occupied Bandwidth Plot on Configuration IEEE 802.11n MCS0 HT20 / 2437 MHz / Chain 1 + Chain 2

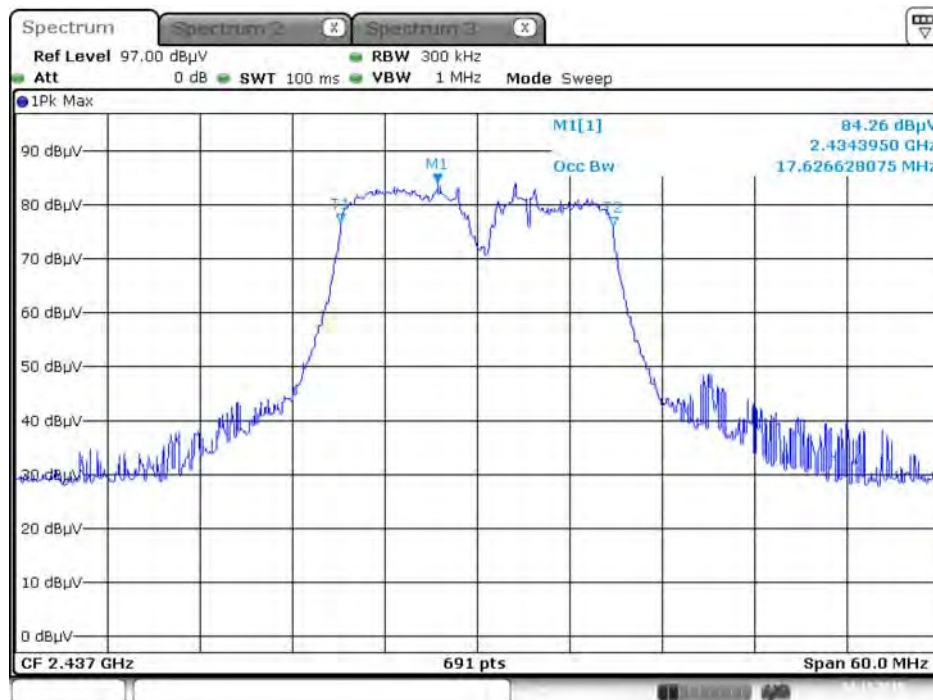

Date: 24.NOV.2015 01:53:19

6 dB Bandwidth Plot on Configuration IEEE 802.11n MCS0 HT40 / 2437 MHz / Chain 1 + Chain 2

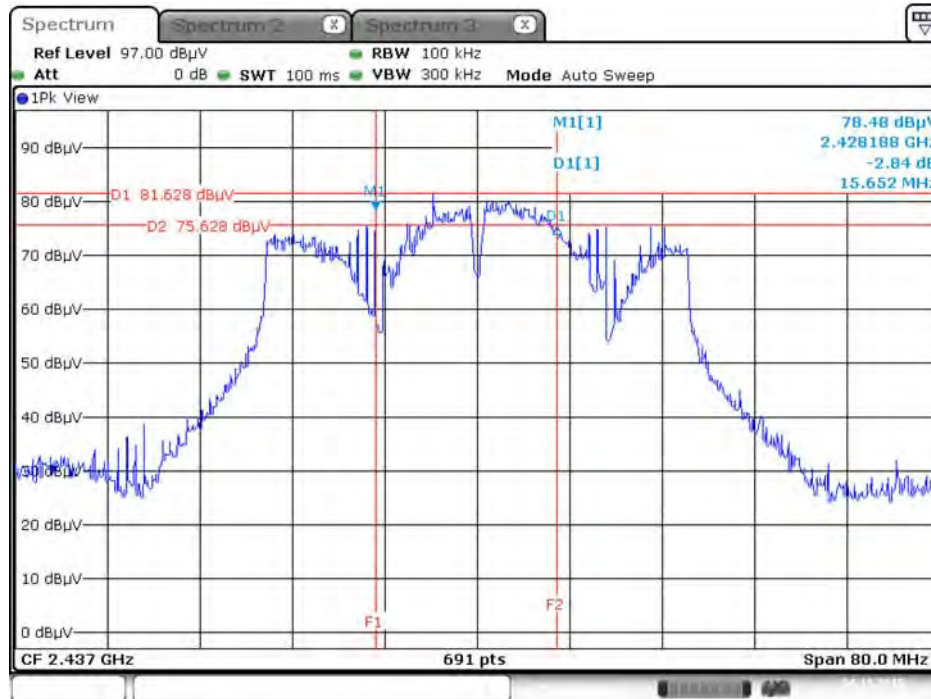

Date: 24.NOV.2015 02:01:25

99% Occupied Bandwidth Plot on Configuration IEEE 802.11n MCS0 HT40 / 2452 MHz / Chain 1 + Chain 2

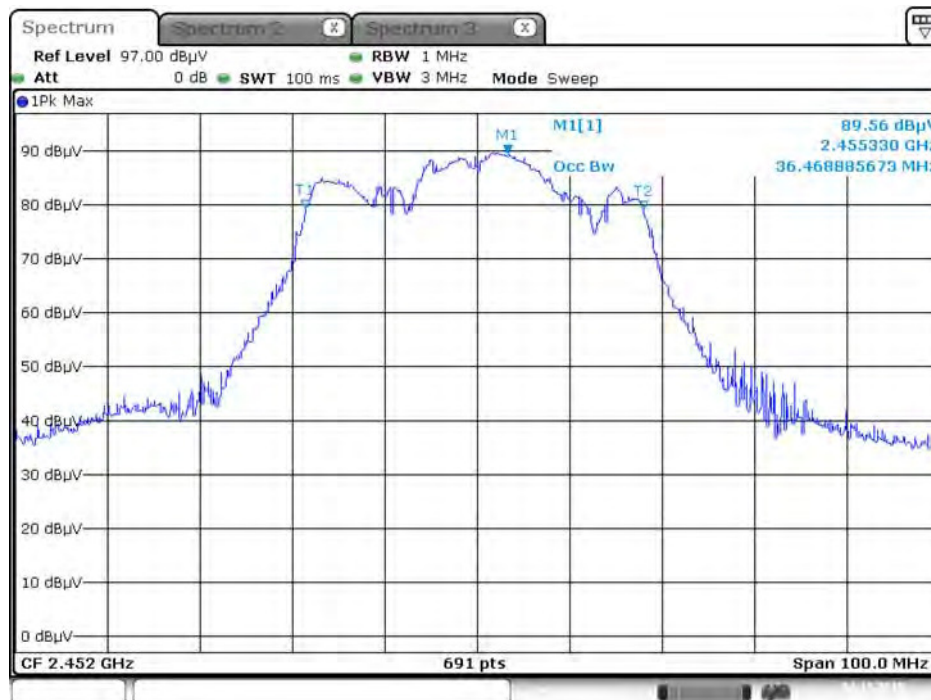

Date: 24.NOV.2015 01:54:59

4.5. Radiated Emissions Measurement

4.5.1. Limit

30dBc in any 100 kHz bandwidth outside the operating frequency band. In case the emission fall within the restricted band specified on 15.205(a), then the 15.209(a) limit in the table below has to be followed.

Frequencies (MHz)	Field Strength (micorvolts/meter)	Measurement Distance (meters)
0.009~0.490	2400/F(kHz)	300
0.490~1.705	24000/F(kHz)	30
1.705~30.0	30	30
30~88	100	3
88~216	150	3
216~960	200	3
Above 960	500	3

4.5.2. Measuring Instruments and Setting

Please refer to section 5 of equipments list in this report. The following table is the setting of spectrum analyzer and receiver.

Spectrum Parameter	Setting
Attenuation	Auto
Start Frequency	1000 MHz
Stop Frequency	10th carrier harmonic
RBW / VBW (Emission in restricted band)	1MHz / 3MHz for Peak, 1MHz / 1/T for Average
RBW / VBW (Emission in non-restricted band)	100kHz / 300kHz for peak

Receiver Parameter	Setting
Attenuation	Auto
Start ~ Stop Frequency	9kHz~150kHz / RBW 200Hz for QP
Start ~ Stop Frequency	150kHz~30MHz / RBW 9kHz for QP
Start ~ Stop Frequency	30MHz~1000MHz / RBW 120kHz for QP

4.5.3. Test Procedures

1. Configure the EUT according to ANSI C63.10. The EUT was placed on the top of the turntable 1.5 meter above ground. The phase center of the receiving antenna mounted on the top of a height-variable antenna tower was placed 1m & 3m far away from the turntable.
2. Power on the EUT and all the supporting units. The turntable was rotated by 360 degrees to determine the position of the highest radiation.
3. The height of the broadband receiving antenna was varied between one meter and four meters above ground to find the maximum emissions field strength of both horizontal and vertical polarization.
4. For each suspected emissions, the antenna tower was scan (from 1 m to 4 m) and then the turntable was rotated (from 0 degree to 360 degrees) to find the maximum reading.
5. Set the test-receiver system to Peak or CISPR quasi-peak Detect Function with specified bandwidth under Maximum Hold Mode.
6. For emissions above 1GHz, use 1MHz VBW and 3MHz RBW for peak reading. Then 1MHz RBW and 1/T VBW for average reading in spectrum analyzer.
7. If the emissions level of the EUT in peak mode was 3 dB lower than the average limit specified, then testing will be stopped and peak values of EUT will be reported, otherwise, the emissions which do not have 3 dB margin will be repeated one by one using the quasi-peak method for below 1GHz.
8. For testing above 1GHz, the emissions level of the EUT in peak mode was lower than average limit (that means the emissions level in peak mode also complies with the limit in average mode), then testing will be stopped and peak values of EUT will be reported, otherwise, the emissions will be measured in average mode again and reported.
9. In case the emission is lower than 30MHz, loop antenna has to be used for measurement and the recorded data should be QP measured by receiver. High – Low scan is not required in this case.

4.5.4. Test Setup Layout

For Radiated Emissions: 9kHz ~30MHz

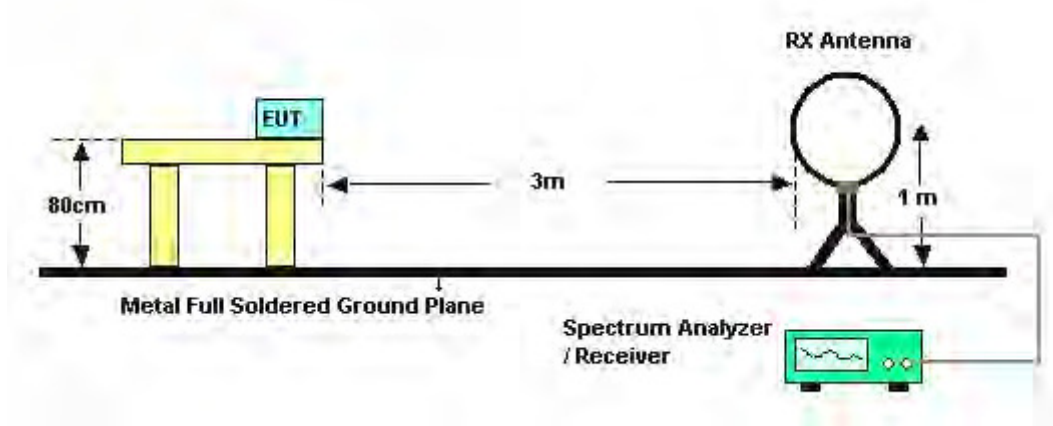

For Radiated Emissions: 30MHz~1GHz

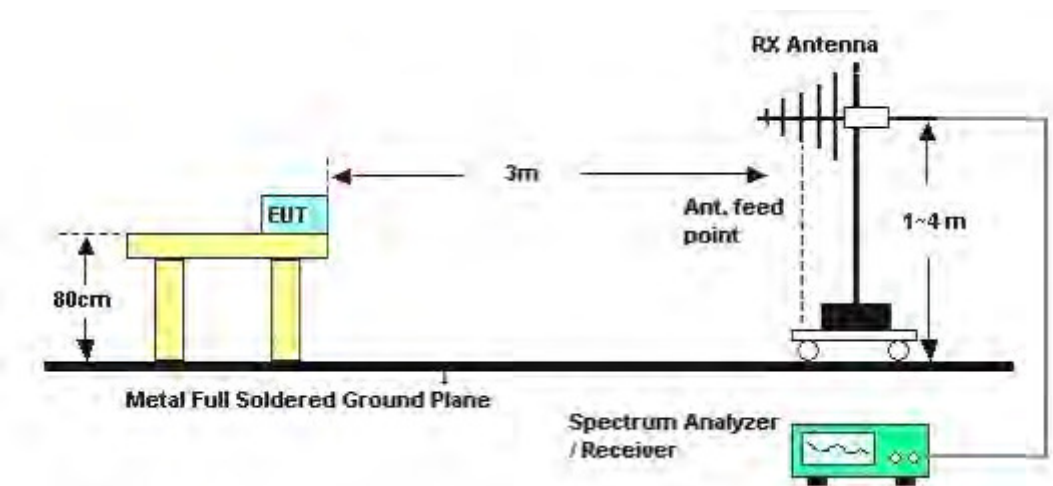

For Radiated Emissions: Above 1GHz

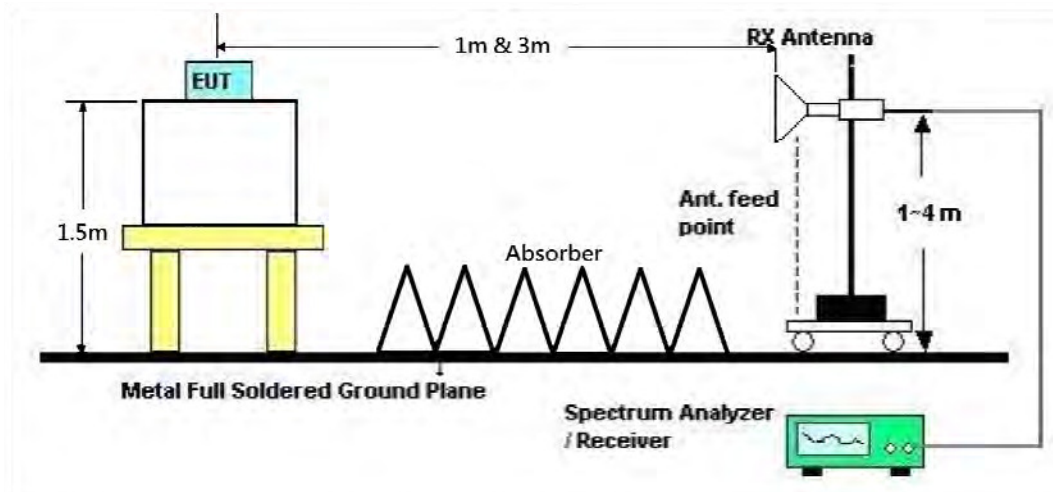

4.5.5. Test Deviation

There is no deviation with the original standard.

4.5.6. EUT Operation during Test

The EUT was programmed to be in continuously transmitting mode.

4.5.7. Results of Radiated Emissions (9kHz~30MHz)

Temperature	20.9°C	Humidity	65%
Test Engineer	Ron Huang	Configurations	Normal Link
Test Date	Jan. 06, 2017		

Freq. (MHz)	Level (dBuV)	Over Limit (dB)	Limit Line (dBuV)	Remark
-	-	-	-	See Note

Note:

The amplitude of spurious emissions which are attenuated by more than 20 dB below the permissible value has no need to be reported.

Distance extrapolation factor = $40 \log(\text{specific distance} / \text{test distance})$ (dB);

Limit line = specific limits (dBuV) + distance extrapolation factor.

4.5.8. Results of Radiated Emissions (30MHz~1GHz)

Temperature	20.9°C	Humidity	65%
Test Engineer	Ron Huang	Configurations	Normal Link

Horizontal

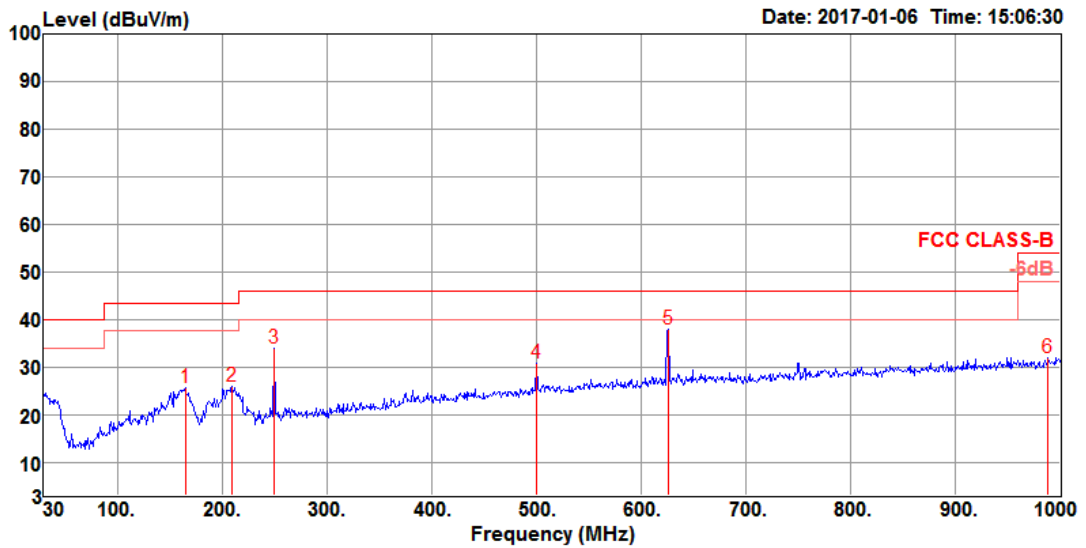

	Freq	Level	Limit	Over	Read	CableAntenna	Preamp	A/Pos	T/Pos	Remark	PoI/Phase
	MHz	dBuV/m	dBuV/m	dB	dBuV	dB	dB/m	dB	cm	deg	
1	164.83	25.56	43.50	-17.94	39.72	1.45	16.75	32.36	200	184	Peak HORIZONTAL
2	209.45	26.04	43.50	-17.46	40.04	1.63	16.70	32.33	300	358	Peak HORIZONTAL
3	250.19	33.80	46.00	-12.20	45.24	1.79	19.10	32.33	150	333	Peak HORIZONTAL
4	500.45	30.64	46.00	-15.36	36.33	2.58	24.03	32.30	100	189	Peak HORIZONTAL
5	625.58	37.86	46.00	-8.14	41.61	2.88	25.77	32.40	100	26	Peak HORIZONTAL
6	988.36	31.85	54.00	-22.15	30.60	3.63	28.50	30.88	125	273	Peak HORIZONTAL

Vertical

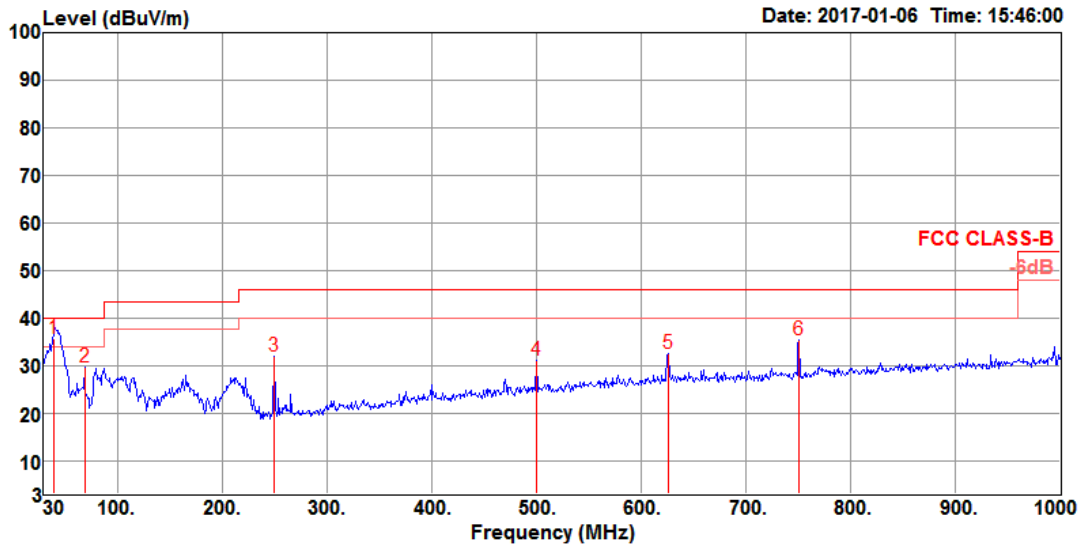

	Freq	Level	Limit Line	Over Limit	Read Level	Cable Loss	Antenna Factor	Preamp Factor	A/Pos	T/Pos	Remark	Pol/Phase
	MHz	dBuV/m	dBuV/m	dB	dBuV	dB	dB/m	dB	cm	deg		
1	39.70	35.52	40.00	-4.48	47.13	0.70	20.36	32.67	100	189	QP	VERTICAL
2	68.80	29.49	40.00	-10.51	47.99	0.92	12.99	32.41	300	92	Peak	VERTICAL
3	250.19	31.91	46.00	-14.09	43.35	1.79	19.10	32.33	200	171	Peak	VERTICAL
4	500.45	30.97	46.00	-15.03	36.66	2.58	24.03	32.30	100	164	Peak	VERTICAL
5	625.58	32.46	46.00	-13.54	36.21	2.88	25.77	32.40	100	63	Peak	VERTICAL
6	750.71	35.43	46.00	-10.57	38.14	3.17	26.40	32.28	100	171	Peak	VERTICAL

Note:

The amplitude of spurious emissions which are attenuated by more than 20 dB below the permissible value has no need to be reported.

Emission level (dBuV/m) = 20 log Emission level (uV/m).

Corrected Reading: Antenna Factor + Cable Loss + Read Level - Preamp Factor = Level.

4.5.9. Results for Radiated Emissions (1GHz~10th Harmonic)

Temperature	25°C	Humidity	58%
Test Engineer	Owen Hsu	Configurations	IEEE 802.11b CH 1 / Chain 1 + Chain 2
Test Date	Nov. 16, 2015		

Horizontal

	Freq	Level	Limit	Over	Read	CableAntenna	Preamp	T/Pos	A/Pos	Remark	Pol/Phase
	MHz	dBuV/m	dBuV/m	dB	dBuV	dB	dB/m	deg	cm		
1	4823.94	33.94	54.00	-20.06	30.03	5.61	32.82	34.52	76	214 Average	HORIZONTAL
2	4824.35	46.40	74.00	-27.60	42.49	5.61	32.82	34.52	76	214 Peak	HORIZONTAL

Vertical

	Freq	Level	Limit	Over	Read	CableAntenna	Preamp	T/Pos	A/Pos	Remark	Pol/Phase
	MHz	dBuV/m	dBuV/m	dB	dBuV	dB	dB/m	deg	cm		
1	4823.86	34.56	54.00	-19.44	30.65	5.61	32.82	34.52	26	189 Average	VERTICAL
2	4824.19	46.04	74.00	-27.96	42.13	5.61	32.82	34.52	26	189 Peak	VERTICAL



Temperature	25°C	Humidity	58%
Test Engineer	Owen Hsu	Configurations	IEEE 802.11b CH 6 / Chain 1 + Chain 2
Test Date	Nov. 16, 2015		

Horizontal

	Freq	Level	Limit Line	Over Limit	Read Level	Cable Loss	Antenna Factor	Preamp Factor	T/Pos	A/Pos	Remark	Pol/Phase
	MHz	dBuV/m	dBuV/m	dB	dBuV	dB	dB/m	dB	deg	cm		
1	4869.79	45.37	74.00	-28.63	41.38	5.59	32.91	34.51	252	146	Peak	HORIZONTAL
2	4873.97	32.43	54.00	-21.57	28.44	5.59	32.91	34.51	252	146	Average	HORIZONTAL

Vertical

	Freq	Level	Limit Line	Over Limit	Read Level	Cable Loss	Antenna Factor	Preamp Factor	T/Pos	A/Pos	Remark	Pol/Phase
	MHz	dBuV/m	dBuV/m	dB	dBuV	dB	dB/m	dB	deg	cm		
1	4873.92	35.18	54.00	-18.82	31.19	5.59	32.91	34.51	307	156	Average	VERTICAL
2	4873.94	45.76	74.00	-28.24	41.77	5.59	32.91	34.51	307	156	Peak	VERTICAL

Temperature	25°C	Humidity	58%
Test Engineer	Owen Hsu	Configurations	IEEE 802.11b CH 11 / Chain 1 + Chain 2
Test Date	Nov. 16, 2015		

Horizontal

	Freq	Level	Limit	Over	Read	CableAntenna	Preamp	T/Pos	A/Pos	Remark	Pol/Phase	
	MHz	dBuV/m	dBuV/m	dB	dBuV	dB	dB/m	dB	deg	cm		
1	4923.87	34.45	54.00	-19.55	30.37	5.58	32.99	34.49	227	220	Average	HORIZONTAL
2	4926.05	45.14	74.00	-28.86	41.06	5.58	32.99	34.49	227	220	Peak	HORIZONTAL

Vertical

	Freq	Level	Limit	Over	Read	CableAntenna	Preamp	T/Pos	A/Pos	Remark	Pol/Phase	
	MHz	dBuV/m	dBuV/m	dB	dBuV	dB	dB/m	dB	deg	cm		
1	4923.94	38.11	54.00	-15.89	34.03	5.58	32.99	34.49	325	146	Average	VERTICAL
2	4924.16	47.41	74.00	-26.59	43.33	5.58	32.99	34.49	325	146	Peak	VERTICAL

Temperature	25°C	Humidity	58%
Test Engineer	Owen Hsu	Configurations	IEEE 802.11g CH 1 / Chain 1 + Chain 2
Test Date	Nov. 16, 2015		

Horizontal

	Freq	Level	Limit Line	Over Limit	Read Level	CableAntenna Loss	Antenna Factor	Preamp Factor	T/Pos	A/Pos	Remark	Pol/Phase
	MHz	dBuV/m	dBuV/m	dB	dBuV	dB	dB/m	dB	deg	cm		
1	4823.65	32.89	54.00	-21.11	28.98	5.61	32.82	34.52	114	177	Average	HORIZONTAL
2	4826.90	45.83	74.00	-28.17	41.91	5.60	32.84	34.52	114	177	Peak	HORIZONTAL

Vertical

	Freq	Level	Limit Line	Over Limit	Read Level	CableAntenna Loss	Antenna Factor	Preamp Factor	T/Pos	A/Pos	Remark	Pol/Phase
	MHz	dBuV/m	dBuV/m	dB	dBuV	dB	dB/m	dB	deg	cm		
1	4824.75	45.93	74.00	-28.07	42.02	5.61	32.82	34.52	38	187	Peak	VERTICAL
2	4826.04	32.98	54.00	-21.02	29.06	5.60	32.84	34.52	38	187	Average	VERTICAL



Temperature	25°C	Humidity	58%
Test Engineer	Owen Hsu	Configurations	IEEE 802.11g CH 6 / Chain 1 + Chain 2
Test Date	Nov. 16, 2015		

Horizontal

	Freq	Level	Limit Line	Over Limit	Read Level	CableAntenna Loss	Antenna Factor	Preamp Factor	T/Pos	A/Pos	Remark	Pol/Phase
	MHz	dBuV/m	dBuV/m	dB	dBuV	dB	dB/m	dB	deg	cm		
1	4871.05	45.79	74.00	-28.21	41.80	5.59	32.91	34.51	133	165	Peak	HORIZONTAL
2	4876.31	32.13	54.00	-21.87	28.14	5.59	32.91	34.51	133	165	Average	HORIZONTAL

Vertical

	Freq	Level	Limit Line	Over Limit	Read Level	CableAntenna Loss	Antenna Factor	Preamp Factor	T/Pos	A/Pos	Remark	Pol/Phase
	MHz	dBuV/m	dBuV/m	dB	dBuV	dB	dB/m	dB	deg	cm		
1	4869.48	32.11	54.00	-21.89	28.12	5.59	32.91	34.51	169	165	Average	VERTICAL
2	4876.21	45.61	74.00	-28.39	41.62	5.59	32.91	34.51	169	165	Peak	VERTICAL



Temperature	25°C	Humidity	58%
Test Engineer	Owen Hsu	Configurations	IEEE 802.11g CH 11 / Chain 1 + Chain 2
Test Date	Nov. 16, 2015		

Horizontal

	Freq	Level	Limit Line	Over Limit	Read Level	Cable Loss	Antenna Factor	Preamp Factor	T/Pos	A/Pos	Remark	Pol/Phase
	MHz	dBuV/m	dBuV/m	dB	dBuV	dB	dB/m	dB	deg	cm		
1	4922.32	32.27	54.00	-21.73	28.21	5.58	32.97	34.49	112	165	Average	HORIZONTAL
2	4925.80	45.51	74.00	-28.49	41.43	5.58	32.99	34.49	112	165	Peak	HORIZONTAL

Vertical

	Freq	Level	Limit Line	Over Limit	Read Level	Cable Loss	Antenna Factor	Preamp Factor	T/Pos	A/Pos	Remark	Pol/Phase
	MHz	dBuV/m	dBuV/m	dB	dBuV	dB	dB/m	dB	deg	cm		
1	4924.19	44.68	74.00	-29.32	40.60	5.58	32.99	34.49	176	165	Peak	VERTICAL
2	4929.00	32.08	54.00	-21.92	28.00	5.58	32.99	34.49	176	165	Average	VERTICAL

Temperature	25°C	Humidity	58%
Test Engineer	Owen Hsu	Configurations	IEEE 802.11n MCS0 HT20 CH 1 / Chain 1 + Chain 2
Test Date	Nov. 16, 2015		

Horizontal

	Freq	Level	Limit Line	Over Limit	Read Level	CableAntenna Loss	Antenna Factor	Preamp Factor	T/Pos	A/Pos	Remark	Pol/Phase
	MHz	dBuV/m	dBuV/m	dB	dBuV	dB	dB/m	dB	deg	cm		
1	4821.40	33.00	54.00	-21.00	29.09	5.61	32.82	34.52	70	165	Average	HORIZONTAL
2	4822.53	45.69	74.00	-28.31	41.78	5.61	32.82	34.52	70	165	Peak	HORIZONTAL

Vertical

	Freq	Level	Limit Line	Over Limit	Read Level	CableAntenna Loss	Antenna Factor	Preamp Factor	T/Pos	A/Pos	Remark	Pol/Phase
	MHz	dBuV/m	dBuV/m	dB	dBuV	dB	dB/m	dB	deg	cm		
1	4823.30	45.96	74.00	-28.04	42.05	5.61	32.82	34.52	175	165	Peak	VERTICAL
2	4825.14	33.24	54.00	-20.76	29.32	5.60	32.84	34.52	175	165	Average	VERTICAL



Temperature	25°C	Humidity	58%
Test Engineer	Owen Hsu	Configurations	IEEE 802.11n MCS0 HT20 CH 6 / Chain 1 + Chain 2
Test Date	Nov. 16, 2015		

Horizontal

	Freq	Level	Limit Line	Over Limit	Read Level	CableAntenna Loss	Antenna Factor	Preamp Factor	T/Pos	A/Pos	Remark	Pol/Phase
	MHz	dBuV/m	dBuV/m	dB	dBuV	dB	dB/m	dB	deg	cm		
1	4872.33	32.03	54.00	-21.97	28.04	5.59	32.91	34.51	266	165	Average	HORIZONTAL
2	4877.38	45.72	74.00	-28.28	41.72	5.59	32.91	34.50	266	165	Peak	HORIZONTAL

Vertical

	Freq	Level	Limit Line	Over Limit	Read Level	CableAntenna Loss	Antenna Factor	Preamp Factor	T/Pos	A/Pos	Remark	Pol/Phase
	MHz	dBuV/m	dBuV/m	dB	dBuV	dB	dB/m	dB	deg	cm		
1	4870.39	32.09	54.00	-21.91	28.10	5.59	32.91	34.51	152	165	Average	VERTICAL
2	4878.33	45.17	74.00	-28.83	41.17	5.59	32.91	34.50	152	165	Peak	VERTICAL



Temperature	25°C	Humidity	58%
Test Engineer	Owen Hsu	Configurations	IEEE 802.11n MCS0 HT20 CH 11 / Chain 1 + Chain 2
Test Date	Nov. 16, 2015		

Horizontal

	Freq	Level	Limit Line	Over Limit	Read Level	CableAntenna Loss	Antenna Factor	Preamp Factor	T/Pos	A/Pos	Remark	Pol/Phase
	MHz	dBuV/m	dBuV/m	dB	dBuV	dB	dB/m	dB	deg	cm		
1	4924.47	31.63	54.00	-22.37	27.55	5.58	32.99	34.49	178	165	Average	HORIZONTAL
2	4925.27	44.98	74.00	-29.02	40.90	5.58	32.99	34.49	178	165	Peak	HORIZONTAL

Vertical

	Freq	Level	Limit Line	Over Limit	Read Level	CableAntenna Loss	Antenna Factor	Preamp Factor	T/Pos	A/Pos	Remark	Pol/Phase
	MHz	dBuV/m	dBuV/m	dB	dBuV	dB	dB/m	dB	deg	cm		
1	4923.62	32.20	54.00	-21.80	28.12	5.58	32.99	34.49	203	165	Average	VERTICAL
2	4924.59	45.06	74.00	-28.94	40.98	5.58	32.99	34.49	203	165	Peak	VERTICAL



Temperature	25°C	Humidity	58%
Test Engineer	Owen Hsu	Configurations	IEEE 802.11n MCS0 HT40 CH 3 / Chain 1 + Chain 2
Test Date	Nov. 16, 2015		

Horizontal

	Freq	Level	Limit	Over	Read	CableAntenna	Preamp	T/Pos	A/Pos	Remark	Pol/Phase	
	MHz	dBuV/m	dBuV/m	dB	dBuV	dB	dB/m	dB	deg	cm		
1	4840.15	45.73	74.00	-28.27	41.79	5.60	32.86	34.52	190	165	Peak	HORIZONTAL
2	4840.22	32.78	54.00	-21.22	28.84	5.60	32.86	34.52	190	165	Average	HORIZONTAL

Vertical

	Freq	Level	Limit	Over	Read	CableAntenna	Preamp	T/Pos	A/Pos	Remark	Pol/Phase	
	MHz	dBuV/m	dBuV/m	dB	dBuV	dB	dB/m	dB	deg	cm		
1	4839.48	32.76	54.00	-21.24	28.82	5.60	32.86	34.52	241	165	Average	VERTICAL
2	4840.23	45.85	74.00	-28.15	41.91	5.60	32.86	34.52	241	165	Peak	VERTICAL



Temperature	25°C	Humidity	58%
Test Engineer	Owen Hsu	Configurations	IEEE 802.11n MCS0 HT40 CH 6 / Chain 1 + Chain 2
Test Date	Nov. 16, 2015		

Horizontal

	Freq	Level	Limit Line	Over Limit	Read Level	CableAntenna Loss	Antenna Factor	Preamp Factor	T/Pos	A/Pos	Remark	Pol/Phase
	MHz	dBuV/m	dBuV/m	dB	dBuV	dB	dB/m	dB	deg	cm		
1	4876.13	32.06	54.00	-21.94	28.07	5.59	32.91	34.51	102	165	Average	HORIZONTAL
2	4878.92	44.85	74.00	-29.15	40.85	5.59	32.91	34.50	102	165	Peak	HORIZONTAL

Vertical

	Freq	Level	Limit Line	Over Limit	Read Level	CableAntenna Loss	Antenna Factor	Preamp Factor	T/Pos	A/Pos	Remark	Pol/Phase
	MHz	dBuV/m	dBuV/m	dB	dBuV	dB	dB/m	dB	deg	cm		
1	4872.51	45.10	74.00	-28.90	41.11	5.59	32.91	34.51	136	165	Peak	VERTICAL
2	4876.18	32.07	54.00	-21.93	28.08	5.59	32.91	34.51	136	165	Average	VERTICAL

Temperature	25°C	Humidity	58%
Test Engineer	Owen Hsu	Configurations	IEEE 802.11n MCS0 HT40 CH 9 / Chain 1 + Chain 2
Test Date	Nov. 16, 2015		

Horizontal

	Freq	Level	Limit	Over	Read	CableAntenna	Preamp	T/Pos	A/Pos	Remark	Pol/Phase	
	MHz	dBuV/m	dBuV/m	dB	dBuV	dB	dB/m	dB	deg	cm		
1	4900.76	32.12	54.00	-21.88	28.08	5.59	32.95	34.50	161	165	Average	HORIZONTAL
2	4908.62	45.79	74.00	-28.21	41.75	5.59	32.95	34.50	161	165	Peak	HORIZONTAL

Vertical

	Freq	Level	Limit	Over	Read	CableAntenna	Preamp	T/Pos	A/Pos	Remark	Pol/Phase	
	MHz	dBuV/m	dBuV/m	dB	dBuV	dB	dB/m	dB	deg	cm		
1	4902.27	45.04	74.00	-28.96	41.00	5.59	32.95	34.50	172	165	Peak	VERTICAL
2	4908.68	32.27	54.00	-21.73	28.23	5.59	32.95	34.50	172	165	Average	VERTICAL

Note:

The amplitude of spurious emissions that are attenuated by more than 20dB below the permissible value has no need to be reported.

Emission level (dBuV/m) = 20 log Emission level (uV/m).

Corrected Reading: Antenna Factor + Cable Loss + Read Level - Preamp Factor = Level.

4.6. Emissions Measurement

4.6.1. Limit

30dBc in any 100 kHz bandwidth outside the operating frequency band. In case the emission fall within the restricted band specified on 15.205(a), then the 15.209(a) limit in the table below has to be followed.

Frequencies (MHz)	Field Strength (micorvolts/meter)	Measurement Distance (meters)
0.009~0.490	2400/F(kHz)	300
0.490~1.705	24000/F(kHz)	30
1.705~30.0	30	30
30~88	100	3
88~216	150	3
216~960	200	3
Above 960	500	3

4.6.2. Measuring Instruments and Setting

Please refer to section 5 of equipments list in this report. The following table is the setting of the spectrum analyzer.

Spectrum Parameter	Setting
Attenuation	Auto
Span Frequency	100 MHz
RBW / VBW (Emission in restricted band)	1MHz / 3MHz for Peak, 1MHz / 1/T for Average
RBW / VBW (30dBc in any 100 kHz bandwidth emission)	100 kHz / 300 kHz for Peak

4.6.3. Test Procedures

For Radiated band edges Measurement:

1. The test procedure is the same as section 4.5.3.

For Radiated Out of Band Emission Measurement:

1. Test was performed in accordance with KDB558074 D01 v03r05 for Performing Compliance Measurements on Digital Transmission Systems (DTS) Operating Under §15.247 section 10.1 Unwanted Emissions into Non-Restricted Frequency Bands Measurement Procedure.

4.6.4. Test Setup Layout

For Radiated band edges Measurement:

This test setup layout is the same as that shown in section 4.5.4.

For Radiated Out of Band Emission Measurement:

This test setup layout is the same as that shown in section 4.5.4.

4.6.5. Test Deviation

There is no deviation with the original standard.

4.6.6. EUT Operation during Test

The EUT was programmed to be in continuously transmitting mode.

4.6.7. Test Result of Band Edge and Fundamental Emissions

Temperature	25°C	Humidity	58%
Test Engineer	Owen Hsu	Configurations	IEEE 802.11b CH 1, 6, 11 / Chain 1 + Chain 2
Test Date	Nov. 14, 2015		

Channel 1

	Freq	Level	Limit	Over	Read	CableAntenna	Preamp	T/Pos	A/Pos	Remark	Pol/Phase
	MHz	dBuV/m	dBuV/m	dB	dBuV	dB	dB/m	deg	cm		
1	2369.37	67.05	74.00	-6.95	35.40	3.71	27.94	0.00	172	150 Peak	VERTICAL
2	2371.46	53.46	54.00	-0.54	21.81	3.71	27.94	0.00	172	150 Average	VERTICAL
3	2411.04	116.16			84.51	3.75	27.90	0.00	172	150 Peak	VERTICAL
4	2411.20	112.03			80.38	3.75	27.90	0.00	172	150 Average	VERTICAL

Item 3, 4 are the fundamental frequency at 2412 MHz.

Channel 6

	Freq	Level	Limit	Over	Read	CableAntenna	Preamp	T/Pos	A/Pos	Remark	Pol/Phase
	MHz	dBuV/m	dBuV/m	dB	dBuV	dB	dB/m	deg	cm		
1	2386.68	67.70	74.00	-6.30	36.05	3.73	27.92	0.00	186	209 Peak	HORIZONTAL
2	2387.64	53.90	54.00	-0.10	22.25	3.73	27.92	0.00	186	209 Average	HORIZONTAL
3	2435.40	114.05			82.40	3.77	27.88	0.00	186	209 Average	HORIZONTAL
4	2435.72	117.94			86.29	3.77	27.88	0.00	186	209 Peak	HORIZONTAL
5	2485.08	50.37	54.00	-3.63	18.74	3.81	27.82	0.00	186	209 Average	HORIZONTAL
6	2489.24	64.14	74.00	-9.86	32.53	3.81	27.80	0.00	186	209 Peak	HORIZONTAL

Item 3, 4 are the fundamental frequency at 2437 MHz.

Channel 11

	Freq	Level	Limit	Over	Read	CableAntenna	Preamp	T/Pos	A/Pos	Remark	Pol/Phase
	MHz	dBuV/m	dBuV/m	dB	dBuV	dB	dB/m	deg	cm		
1	2462.64	114.95			83.32	3.79	27.84	0.00	186	189 Average	HORIZONTAL
2	2462.96	118.95			87.32	3.79	27.84	0.00	186	189 Peak	HORIZONTAL
3	2500.00	64.71	74.00	-9.29	33.08	3.83	27.80	0.00	186	189 Peak	HORIZONTAL
4	2500.00	53.53	54.00	-0.47	21.90	3.83	27.80	0.00	186	189 Average	HORIZONTAL

Item 1, 2 are the fundamental frequency at 2462 MHz.

Temperature	25°C	Humidity	58%
Test Engineer	Owen Hsu	Configurations	IEEE 802.11g CH 1, 6, 11 / Chain 1 + Chain 2
Test Date	Nov. 14, 2015 / Nov. 16, 2015		

Channel 1

	Freq	Level	Limit	Over	Read	CableAntenna	Preamp	T/Pos	A/Pos	Remark	Pol/Phase
	MHz	dBuV/m	dBuV/m	dB	dBuV	dB	dB/m	deg	cm		
1	2371.30	65.29	74.00	-8.71	33.64	3.71	27.94	0.00	175	200 Peak	HORIZONTAL
2	2371.30	53.79	54.00	-0.21	22.14	3.71	27.94	0.00	175	200 Average	HORIZONTAL
3	2411.04	105.81			74.16	3.75	27.90	0.00	175	200 Average	HORIZONTAL
4	2415.85	115.89			84.24	3.75	27.90	0.00	175	200 Peak	HORIZONTAL

Item 3, 4 are the fundamental frequency at 2412 MHz.

Channel 6

	Freq	Level	Limit	Over	Read	CableAntenna	Preamp	T/Pos	A/Pos	Remark	Pol/Phase
	MHz	dBuV/m	dBuV/m	dB	dBuV	dB	dB/m	deg	cm		
1	2389.04	67.25	74.00	-6.75	35.60	3.73	27.92	0.00	188	187 Peak	HORIZONTAL
2	2389.24	53.62	54.00	-0.38	21.97	3.73	27.92	0.00	188	187 Average	HORIZONTAL
3	2433.15	116.00			84.35	3.77	27.88	0.00	188	187 Peak	HORIZONTAL
4	2438.60	104.91			73.28	3.77	27.86	0.00	188	187 Average	HORIZONTAL
5	2483.50	52.44	54.00	-1.56	20.81	3.81	27.82	0.00	188	187 Average	HORIZONTAL
6	2483.82	63.80	74.00	-10.20	32.17	3.81	27.82	0.00	188	187 Peak	HORIZONTAL

Item 3, 4 are the fundamental frequency at 2437 MHz.

Channel 11

	Freq	Level	Limit	Over	Read	CableAntenna	Preamp	T/Pos	A/Pos	Remark	Pol/Phase
	MHz	dBuV/m	dBuV/m	dB	dBuV	dB	dB/m	deg	cm		
1	2461.04	107.05			75.42	3.79	27.84	0.00	173	187 Average	HORIZONTAL
2	2461.36	117.17			85.54	3.79	27.84	0.00	173	187 Peak	HORIZONTAL
3	2500.00	65.00	74.00	-9.00	33.37	3.83	27.80	0.00	173	187 Peak	HORIZONTAL
4	2500.00	53.56	54.00	-0.44	21.93	3.83	27.80	0.00	173	187 Average	HORIZONTAL

Item 1, 2 are the fundamental frequency at 2462 MHz.

Temperature	25°C	Humidity	58%
Test Engineer	Owen Hsu	Configurations	IEEE 802.11n MCS0 HT20 CH 1, 6, 11 / Chain 1 + Chain 2
Test Date	Nov. 15, 2015		

Channel 1

	Freq	Level	Limit Line	Over Limit	Read Level	CableAntenna Loss	Antenna Factor	Preamp Factor	T/Pos	A/Pos	Remark	Pol/Phase
	MHz	dBuV/m	dBuV/m	dB	dBuV	dB	dB/m	dB	deg	cm		
1	2370.97	53.66	54.00	-0.34	22.01	3.71	27.94	0.00	172	132	Average	VERTICAL
2	2388.92	70.30	74.00	-3.70	38.65	3.73	27.92	0.00	172	132	Peak	VERTICAL
3	2413.28	115.92			84.27	3.75	27.90	0.00	172	132	Peak	VERTICAL
4	2414.89	104.10			72.45	3.75	27.90	0.00	172	132	Average	VERTICAL

Item 3, 4 are the fundamental frequency at 2412 MHz.

Channel 6

	Freq	Level	Limit Line	Over Limit	Read Level	CableAntenna Loss	Antenna Factor	Preamp Factor	T/Pos	A/Pos	Remark	Pol/Phase
	MHz	dBuV/m	dBuV/m	dB	dBuV	dB	dB/m	dB	deg	cm		
1	2389.04	66.19	74.00	-7.81	34.54	3.73	27.92	0.00	188	186	Peak	HORIZONTAL
2	2390.00	53.67	54.00	-0.33	22.02	3.73	27.92	0.00	188	186	Average	HORIZONTAL
3	2434.12	105.76			74.11	3.77	27.88	0.00	188	186	Average	HORIZONTAL
4	2434.44	116.44			84.79	3.77	27.88	0.00	188	186	Peak	HORIZONTAL
5	2483.50	51.69	54.00	-2.31	20.06	3.81	27.82	0.00	188	186	Average	HORIZONTAL
6	2484.44	64.45	74.00	-9.55	32.82	3.81	27.82	0.00	188	186	Peak	HORIZONTAL

Item 3, 4 are the fundamental frequency at 2437 MHz.

Channel 11

	Freq	Level	Limit Line	Over Limit	Read Level	CableAntenna Loss	Antenna Factor	Preamp Factor	T/Pos	A/Pos	Remark	Pol/Phase
	MHz	dBuV/m	dBuV/m	dB	dBuV	dB	dB/m	dB	deg	cm		
1	2459.44	107.61			75.98	3.79	27.84	0.00	188	232	Average	HORIZONTAL
2	2460.72	118.70			87.07	3.79	27.84	0.00	188	232	Peak	HORIZONTAL
3	2499.68	66.53	74.00	-7.47	34.90	3.83	27.80	0.00	188	232	Peak	HORIZONTAL
4	2500.00	53.52	54.00	-0.48	21.89	3.83	27.80	0.00	188	232	Average	HORIZONTAL

Item 1, 2 are the fundamental frequency at 2462 MHz.

Temperature	25°C	Humidity	58%
Test Engineer	Owen Hsu	Configurations	IEEE 802.11n MCS0 HT40 CH 3, 6, 9 / Chain 1 + Chain 2
Test Date	Nov. 15, 2015		

Channel 3

	Freq	Level	Limit	Over	Read	CableAntenna	Preamp	T/Pos	A/Pos	Remark	Pol/Phase	
	MHz	dBuV/m	dBuV/m	dB	dBuV	dB	dB/m	dB	deg	cm		
1	2390.00	65.26	74.00	-8.74	33.61	3.73	27.92	0.00	191	194	Peak	HORIZONTAL
2	2390.00	53.82	54.00	-0.18	22.17	3.73	27.92	0.00	191	194	Average	HORIZONTAL
3	2418.47	113.38			81.73	3.75	27.90	0.00	191	194	Peak	HORIZONTAL
4	2419.12	101.36			69.70	3.76	27.90	0.00	191	194	Average	HORIZONTAL

Item 3, 4 are the fundamental frequency at 2422 MHz.

Channel 6

	Freq	Level	Limit	Over	Read	CableAntenna	Preamp	T/Pos	A/Pos	Remark	Pol/Phase	
	MHz	dBuV/m	dBuV/m	dB	dBuV	dB	dB/m	dB	deg	cm		
1	2383.47	66.84	74.00	-7.16	35.17	3.73	27.94	0.00	175	187	Peak	HORIZONTAL
2	2390.00	53.75	54.00	-0.25	22.10	3.73	27.92	0.00	175	187	Average	HORIZONTAL
3	2432.51	104.91			73.26	3.77	27.88	0.00	175	187	Average	HORIZONTAL
4	2433.80	117.02			85.37	3.77	27.88	0.00	175	187	Peak	HORIZONTAL
5	2483.50	51.51	54.00	-2.49	19.88	3.81	27.82	0.00	175	187	Average	HORIZONTAL
6	2499.82	67.15	74.00	-6.85	35.52	3.83	27.80	0.00	175	187	Peak	HORIZONTAL

Item 3, 4 are the fundamental frequency at 2437 MHz.

Channel 9

	Freq	Level	Limit	Over	Read	CableAntenna	Preamp	T/Pos	A/Pos	Remark	Pol/Phase	
	MHz	dBuV/m	dBuV/m	dB	dBuV	dB	dB/m	dB	deg	cm		
1	2456.49	113.42			81.79	3.79	27.84	0.00	175	208	Peak	HORIZONTAL
2	2456.81	101.26			69.63	3.79	27.84	0.00	175	208	Average	HORIZONTAL
3	2483.50	53.72	54.00	-0.28	22.09	3.81	27.82	0.00	175	208	Average	HORIZONTAL
4	2483.82	66.76	74.00	-7.24	35.13	3.81	27.82	0.00	175	208	Peak	HORIZONTAL

Item 1, 2 are the fundamental frequency at 2452 MHz.

Note:

Emission level (dBuV/m) = 20 log Emission level (uV/m).

Corrected Reading: Antenna Factor + Cable Loss + Read Level - Preamp Factor = Level.

For Emission not in Restricted Band

Plot on Configuration IEEE 802.11b / Reference Level

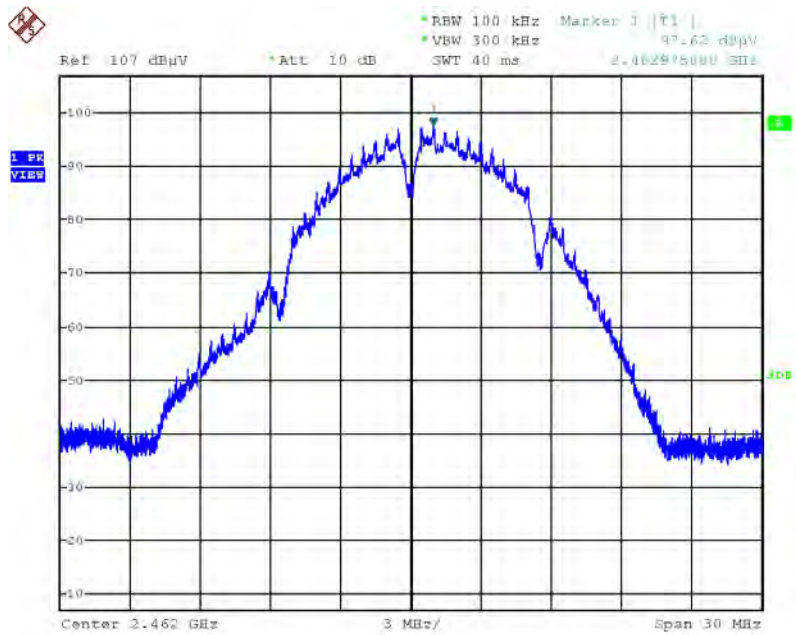

Date: 16.NOV.2015 12:45:40

Plot on Configuration IEEE 802.11b / CH 1 / 30MHz~2400MHz (down 30dBc)

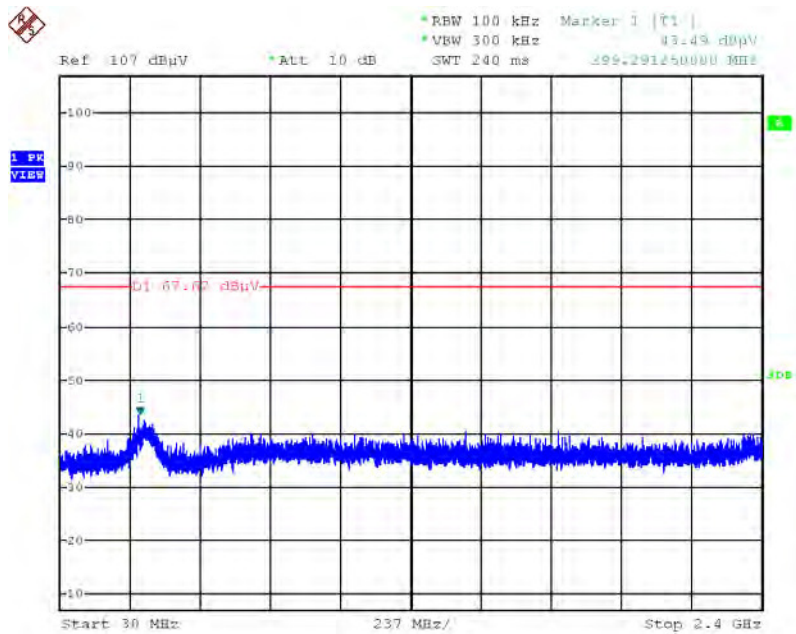

Date: 16.NOV.2015 12:47:35

Plot on Configuration IEEE 802.11b / CH 1 / 2500MHz~2650MHz (down 30dBc)

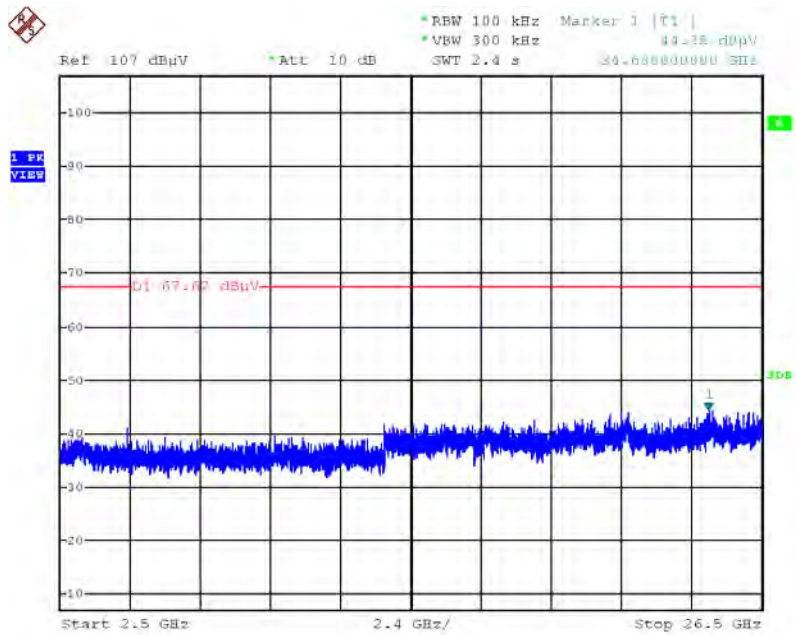

Date: 16.NOV.2015 12:48:17

Plot on Configuration IEEE 802.11b / CH 11 / 30MHz~2400MHz (down 30dBc)

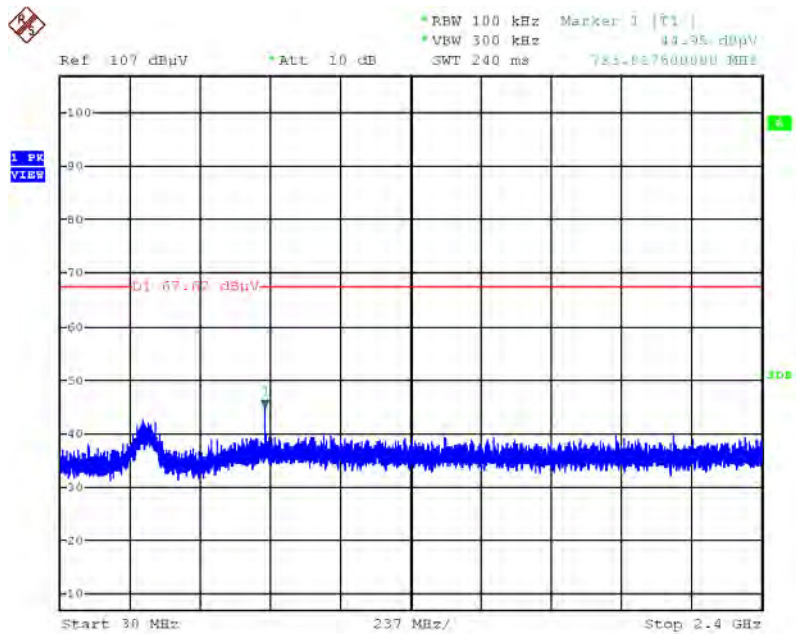

Date: 16.NOV.2015 12:46:35

Plot on Configuration IEEE 802.11b / CH 11 / 2500MHz~26500MHz (down 30dBc)

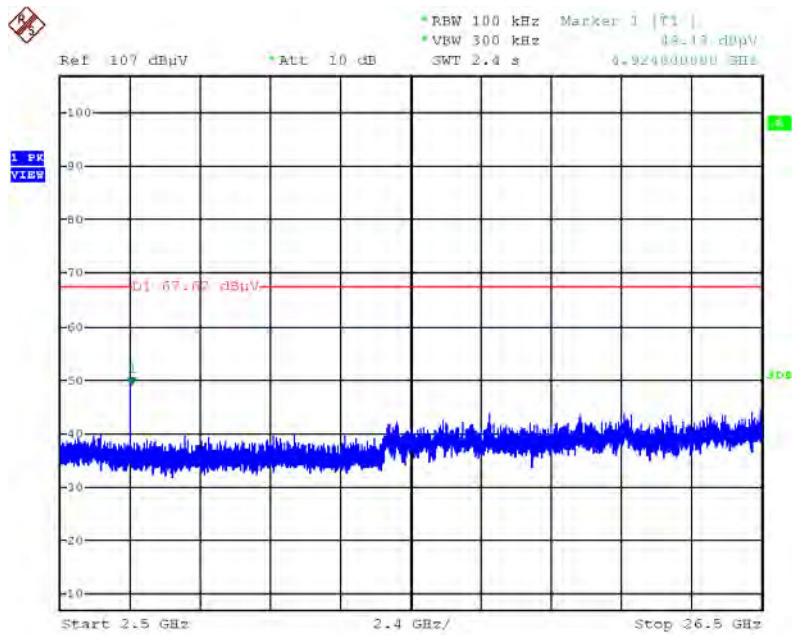

Date: 16.NOV.2015 12:47:02

Plot on Configuration IEEE 802.11g / CH 1 / 2500MHz~2650MHz (down 30dBc)

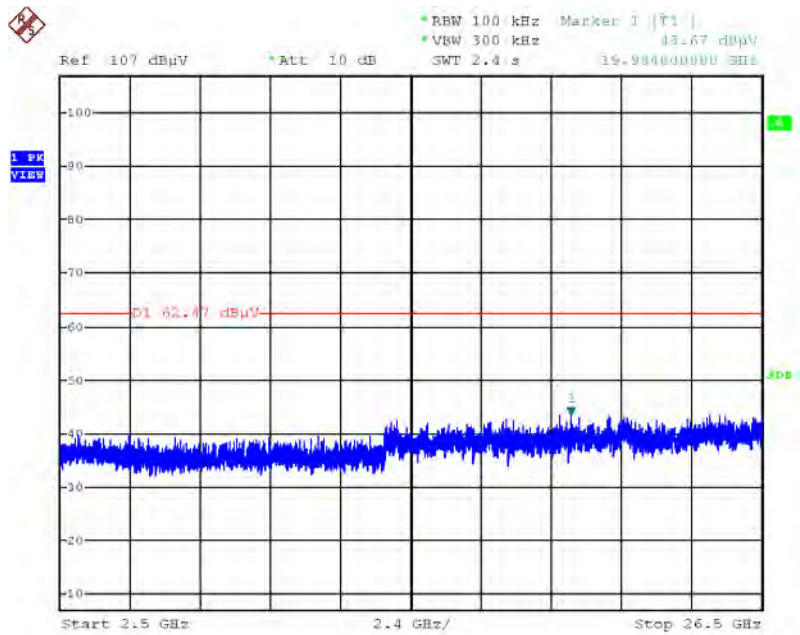

Date: 16.NOV.2015 12:53:09

Plot on Configuration IEEE 802.11g / CH 11 / 30MHz~2400MHz (down 30dBc)

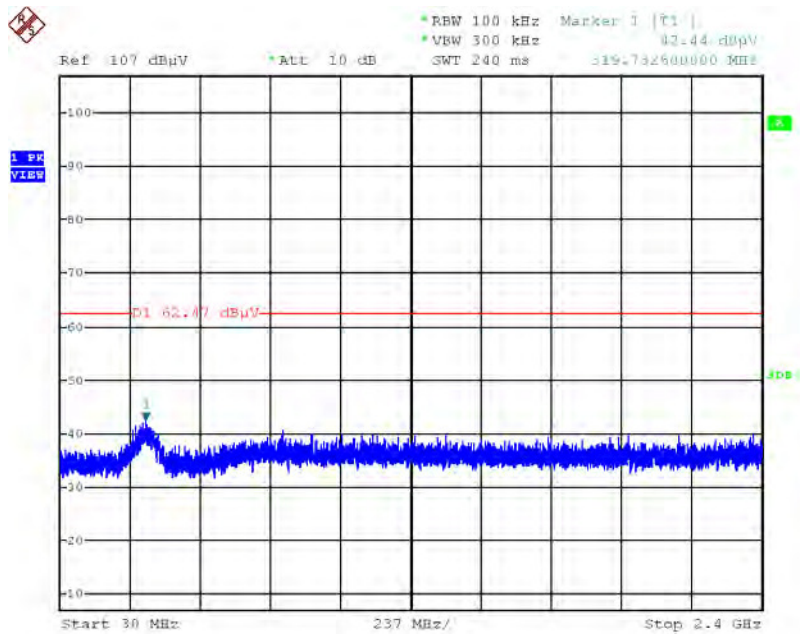

Date: 16.NOV.2015 12:51:33

Plot on Configuration IEEE 802.11g / CH 11 / 2500MHz~26500MHz (down 30dBc)

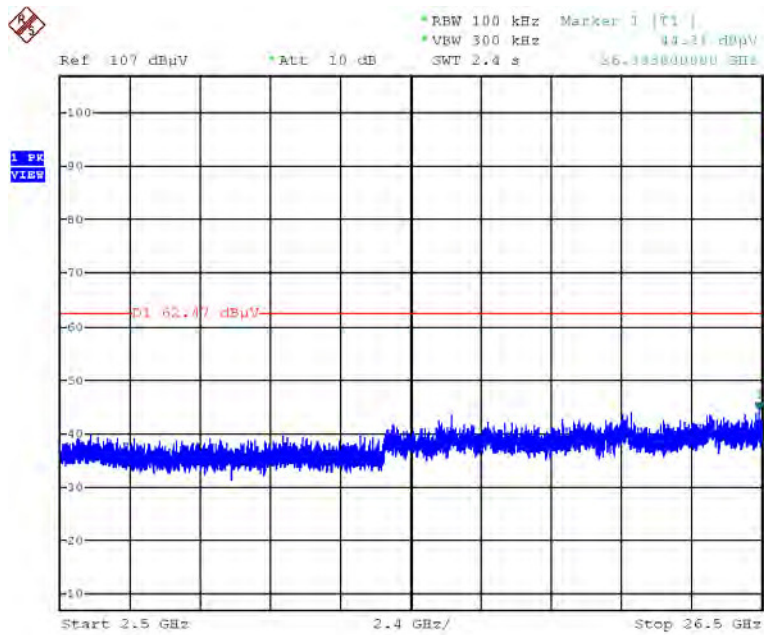

Date: 16.NOV.2015 12:51:57

Plot on Configuration IEEE 802.11n MCS0 HT20 / Reference Level

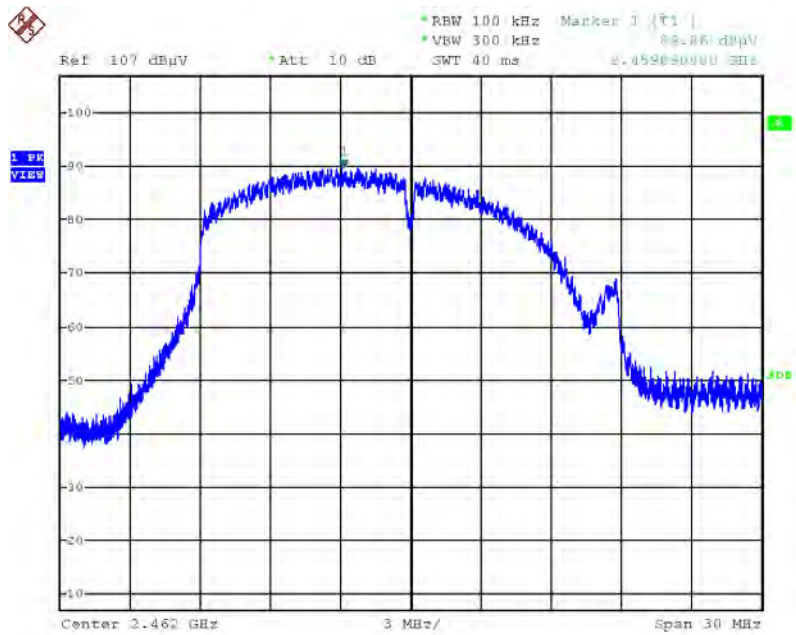

Date: 16.NOV.2015 12:55:27

Plot on Configuration IEEE 802.11n MCS0 HT20 / CH 1 / 30MHz~2400MHz (down 30dBc)

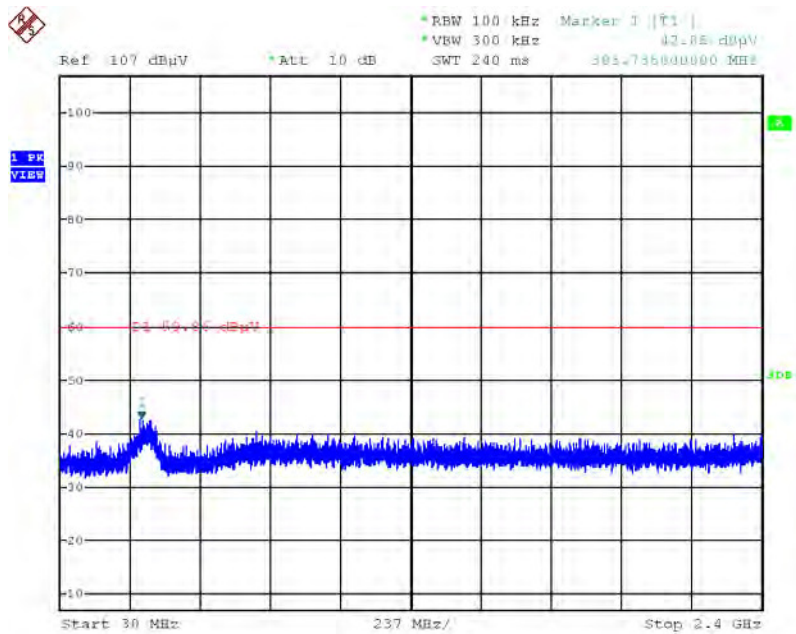

Date: 16.NOV.2015 12:57:13

Plot on Configuration IEEE 802.11n MCS0 HT20 / CH 1 / 2500MHz~26500MHz (down 30dBc)

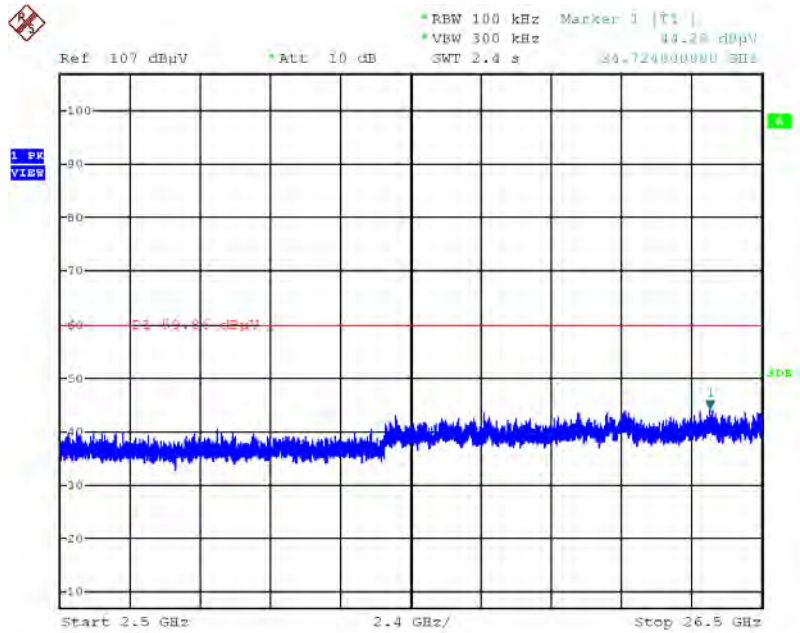

Date: 16.NOV.2015 12:57:49

Plot on Configuration IEEE 802.11n MCS0 HT20 / CH 11 / 30MHz~2400MHz (down 30dBc)

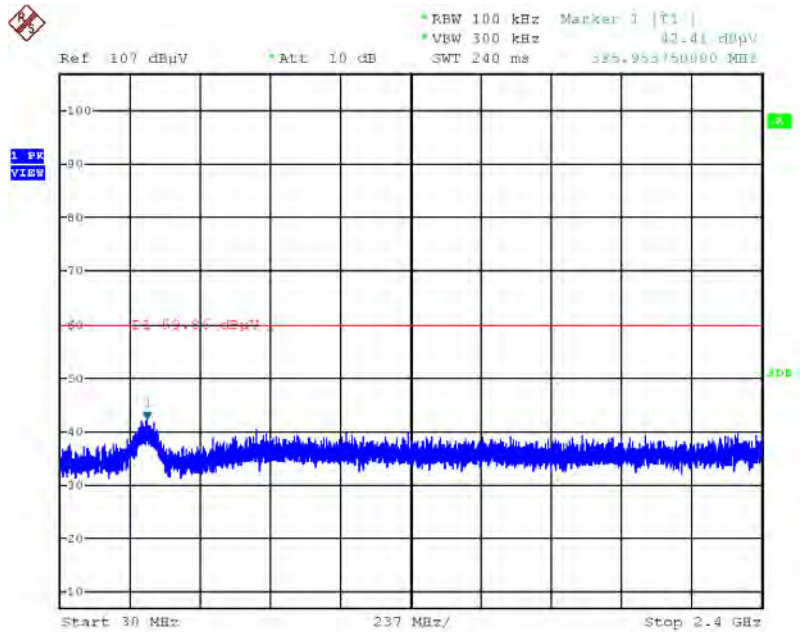

Date: 16.NOV.2015 12:56:01

Plot on Configuration IEEE 802.11n MCS0 HT20 / CH 11 / 2500MHz~26500MHz (down 30dBc)

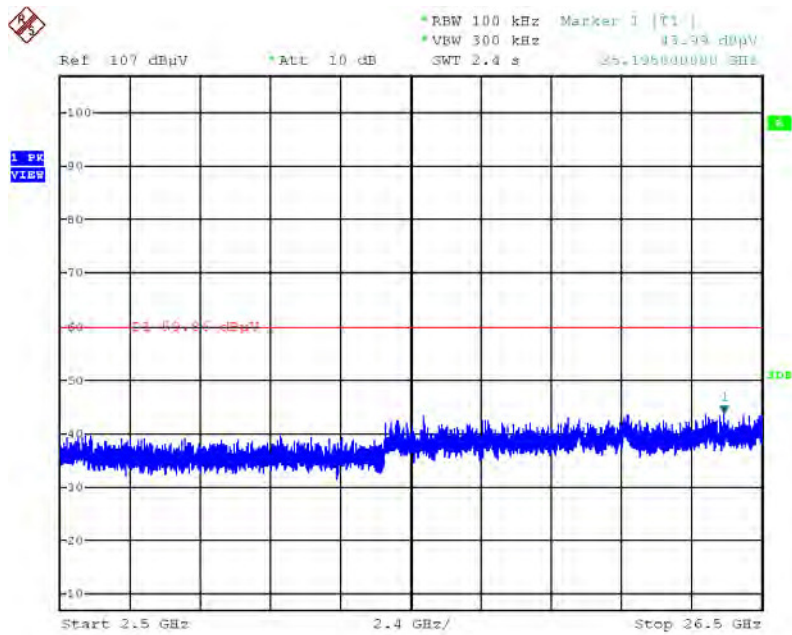

Date: 16.NOV.2015 12:56:26

Plot on Configuration IEEE 802.11n MCS0 HT40 / Reference Level

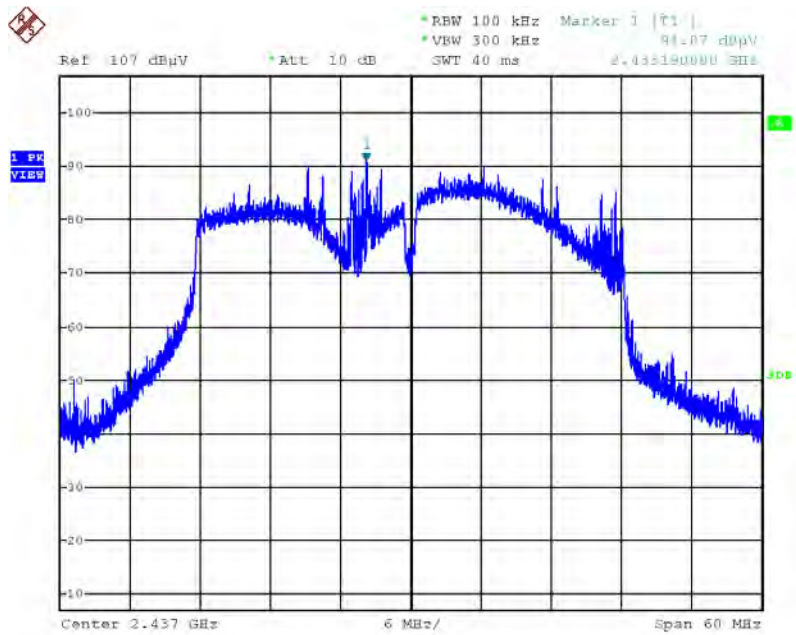

Date: 16.NOV.2015 12:59:24

Plot on Configuration IEEE 802.11n MCS0 HT40 / CH 3 / 30MHz~2400MHz (down 30dBc)

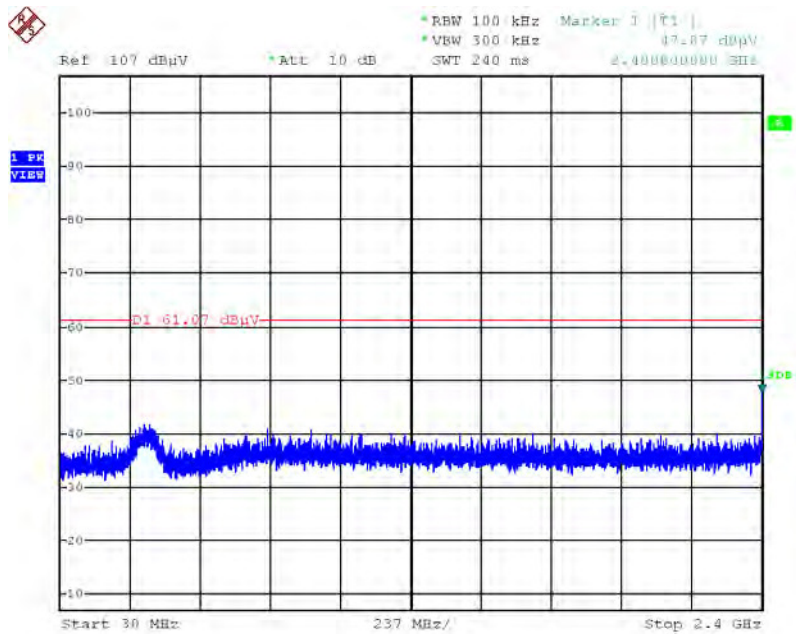

Date: 16.NOV.2015 13:00:47

Plot on Configuration IEEE 802.11n MCS0 HT40 / CH 3 / 2500MHz~26500MHz (down 30dBc)

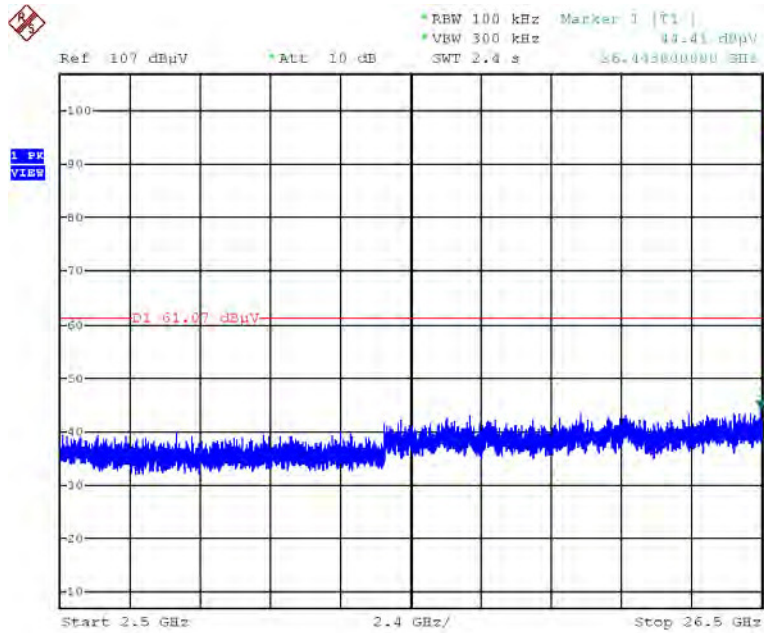

Date: 16.NOV.2015 13:01:15

Plot on Configuration IEEE 802.11n MCS0 HT40 / CH 9 / 30MHz~2400MHz (down 30dBc)

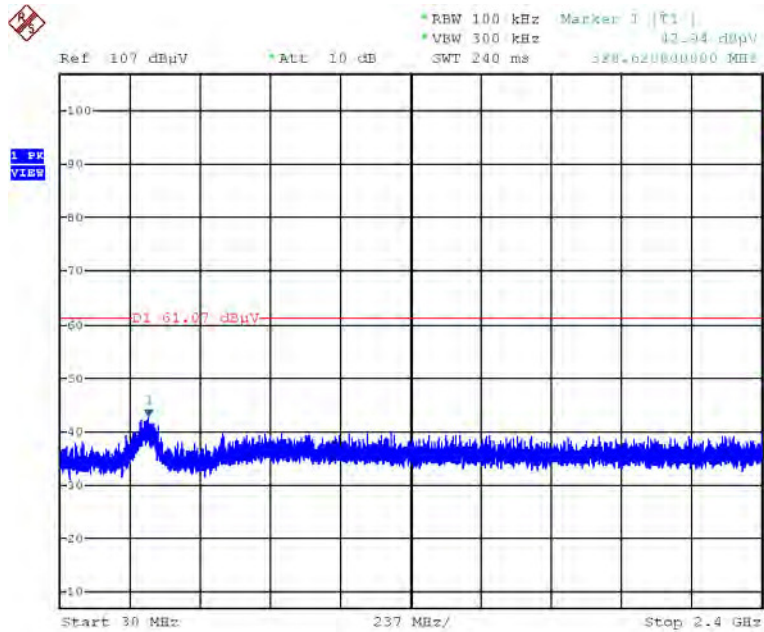

Date: 16.NOV.2015 13:02:02

Plot on Configuration IEEE 802.11n MCS0 HT40 / CH 9 / 2500MHz~26500MHz (down 30dBc)

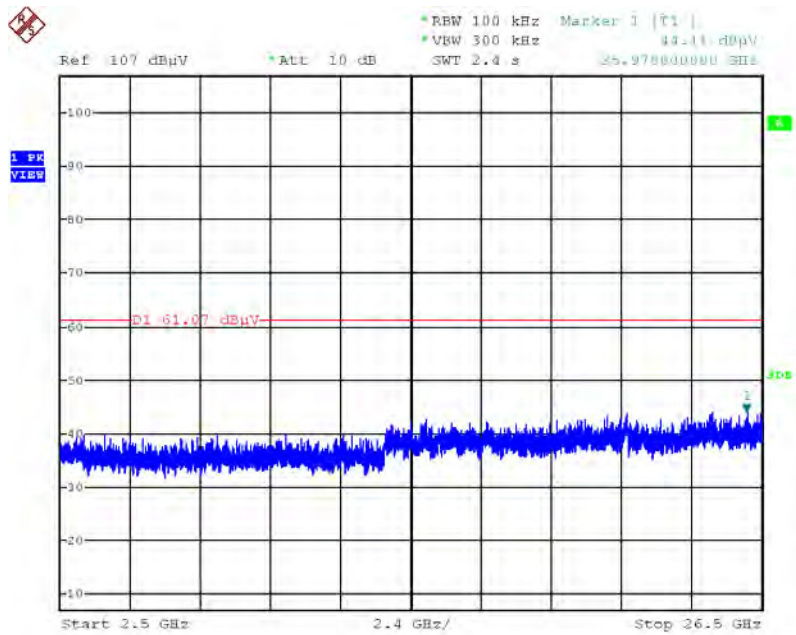

Date: 16.NOV.2015 13:02:30

4.7. Antenna Requirements

4.7.1. Limit

Except for special regulations, the Low-power Radio-frequency Devices must not be equipped with any jacket for installing an antenna with extension cable. An intentional radiator shall be designed to ensure that no antenna other than that furnished by the responsible party shall be used with the device. The use of a permanently attached antenna or of an antenna that uses a unique coupling to the intentional radiator shall be considered sufficient to comply with the provisions of this Section. The manufacturer may design the unit so that the user can replace a broken antenna, but the use of a standard antenna jack or electrical connector is prohibited. Further, this requirement does not apply to intentional radiators that must be professionally installed.

4.7.2. Antenna Connector Construction

Please refer to section 3.3 in this test report; antenna connector complied with the requirements.

5. LIST OF MEASURING EQUIPMENTS

Instrument	Manufacturer	Model No.	Serial No.	Characteristics	Calibration Date	Remark
LISN	Schwarzbeck	NSLK 8127	8127650	9kHz ~ 30MHz	Nov. 23, 2016	Conduction (CO02-CB)
LISN	Schwarzbeck	NSLK 8127	8127478	9kHz ~ 30MHz	Nov. 15, 2016	Conduction (CO02-CB)
EMI Receiver	Agilent	N9038A	MY52260140	9kHz ~ 8.4GHz	Jan. 18, 2016	Conduction (CO02-CB)
Software	Audix	E3	6.120210n	-	N.C.R.	Conduction (CO02-CB)
Pulse Limiter	Schwarzbeck	VTSD 9561F	9561-F073	9kHz ~ 30MHz	Sep. 29, 2016	Conduction (CO02-CB)
BILOG ANTENNA with 6dB Attenuator	TESEQ & EMCI	CBL6112D & N-6-06	37880 & AT-N0609	20MHz ~ 2GHz	Aug. 30, 2016	Radiation (03CH01-CB)
Horn Antenna	EMCO	3115	00075790	750MHz ~ 18GHz	Oct. 22, 2015	Radiation (03CH01-CB)
Horn Antenna	Schwarzbeck	BBHA 9170	BBHA9170252	15GHz ~ 40GHz	Jul. 21, 2015	Radiation (03CH01-CB)
Pre-Amplifier	Agilent	8447D	2944A10991	0.1MHz ~ 1.3GHz	Mar. 15, 2016	Radiation (03CH01-CB)
Pre-Amplifier	Agilent	8449B	3008A02099	1GHz ~ 26.5GHz	Jan. 12, 2015	Radiation (03CH01-CB)
Pre-Amplifier	WM	TF-130N-R1	923365	26GHz ~ 40GHz	Feb.10, 2015	Radiation (03CH01-CB)
Spectrum Analyzer	R&S	FSP40	100056	9kHz ~ 40GHz	Oct. 27, 2015	Radiation (03CH01-CB)
Spectrum Analyzer	R&S	FSP40	100056	9kHz ~ 40GHz	Nov. 21, 2016	Radiation (03CH01-CB)
EMI Test	R&S	ESCS	100355	9kHz ~ 2.75GHz	May 16, 2016	Radiation (03CH01-CB)
RF Cable-low	Woken	Low Cable-16+17	N/A	30 MHz ~ 1 GHz	Oct. 24, 2016	Radiation (03CH01-CB)
RF Cable-high	Woken	High Cable-16	N/A	1 GHz ~ 18 GHz	Nov. 02, 2015	Radiation (03CH01-CB)
RF Cable-high	Woken	High Cable-17	N/A	1 GHz ~ 18 GHz	Nov. 02, 2015	Radiation (03CH01-CB)
RF Cable-high	Woken	High Cable-40G-1	N/A	18GHz ~ 40 GHz	Nov. 02, 2015	Radiation (03CH01-CB)
RF Cable-high	Woken	High Cable-40G-2	N/A	18GHz ~ 40 GHz	Nov. 02, 2015	Radiation (03CH01-CB)
Loop Antenna	Teseq	HLA 6120	24155	9kHz - 30 MHz	Mar. 16, 2016*	Radiation (10CH01-CB)
Spectrum analyzer	R&S	FSV40	100979	9kHz~40GHz	Dec. 12, 2014	Conducted (TH01-CB)
RF Cable-high	Woken	RG402	High Cable-7	1 GHz ~ 26.5 GHz	Nov. 02, 2015	Conducted (TH01-CB)
RF Cable-high	Woken	RG402	High Cable-8	1 GHz ~ 26.5 GHz	Nov. 02, 2015	Conducted (TH01-CB)
RF Cable-high	Woken	RG402	High Cable-9	1 GHz ~ 26.5 GHz	Nov. 02, 2015	Conducted (TH01-CB)
RF Cable-high	Woken	RG402	High Cable-10	1 GHz ~ 26.5 GHz	Nov. 02, 2015	Conducted (TH01-CB)
RF Cable-high	Woken	RG402	High Cable-6	1 GHz ~ 26.5 GHz	Nov. 02, 2015	Conducted (TH01-CB)
Power Sensor	Agilent	U2021XA	MY53410001	50MHz~18GHz	Nov. 02, 2015	Conducted (TH01-CB)

Note: Calibration Interval of instruments listed above is one year.

“*” Calibration Interval of instruments listed above is two years.

N.C.R. means Non-Calibration required.

6. MEASUREMENT UNCERTAINTY

Test Items	Uncertainty	Remark
Conducted Emission (150kHz ~ 30MHz)	3.2 dB	Confidence levels of 95%
Radiated Emission (30MHz ~ 1,000MHz)	3.6 dB	Confidence levels of 95%
Radiated Emission (1GHz ~ 18GHz)	3.7 dB	Confidence levels of 95%
Radiated Emission (18GHz ~ 40GHz)	3.5 dB	Confidence levels of 95%
Conducted Emission	1.7 dB	Confidence levels of 95%
Output Power Measurement	1.33 dB	Confidence levels of 95%
Power Density Measurement	1.27 dB	Confidence levels of 95%
Bandwidth Measurement	9.74×10^{-8}	Confidence levels of 95%

Appendix B. Radiated Emission Co-location Report

1. Results of Radiated Emissions for Co-located

Temperature	25°C	Humidity	58%
Test Engineer	Owen Hsu	Configurations	2.4GHz + 5GHz

Horizontal

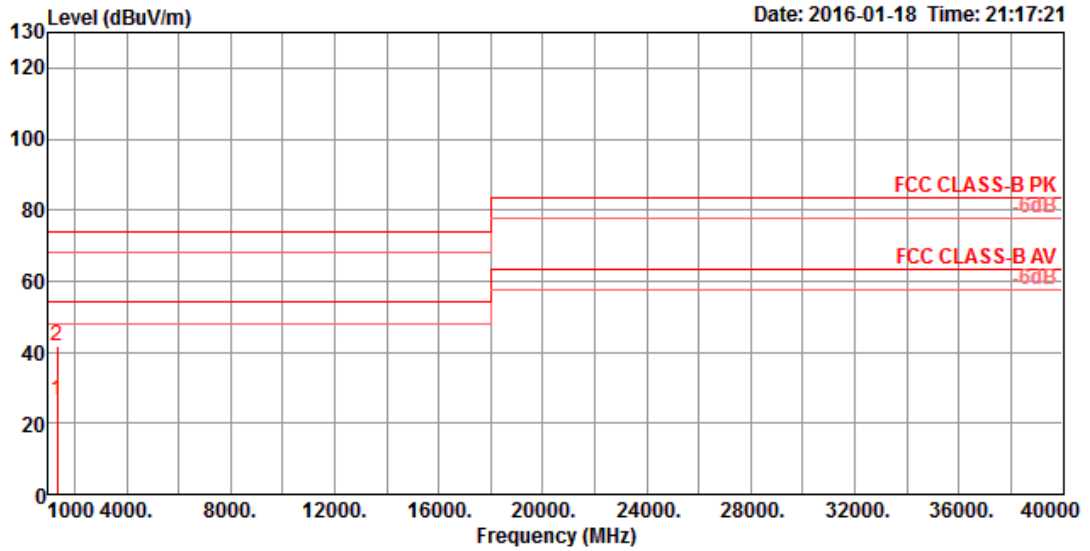

	Freq	Level	Limit Line	Over Limit	Read Level	Cable Loss	Preamp Factor	Antenna Factor	Pol/Phase	T/Pos	A/Pos	Remark
	MHz	dBuV/m	dBuV/m	dB	dBuV	dB	dB	dB/m		deg	cm	
1	1327.20	26.50	54.00	-27.50	33.00	4.31	35.87	25.06	HORIZONTAL	224	121	Average
2	1328.30	41.87	74.00	-32.13	48.35	4.31	35.85	25.06	HORIZONTAL	224	121	Peak

Vertical

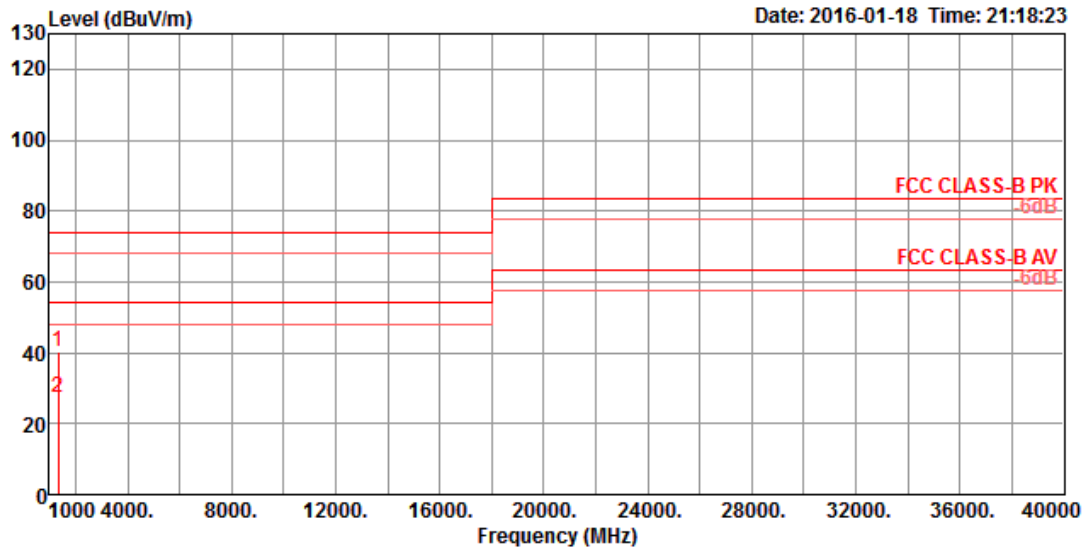

	Freq	Level	Limit Line	Over Limit	Read Level	Cable Loss	Preamp Factor	Antenna Factor	Pol/Phase	T/Pos	A/Pos	Remark
	MHz	dBuV/m	dBuV/m	dB	dBuV	dB	dB	dB/m		deg	cm	
1	1321.10	40.46	74.00	-33.54	47.01	4.29	35.89	25.05	VERTICAL	321	123	Peak
2	1321.11	27.42	54.00	-26.58	33.97	4.29	35.89	25.05	VERTICAL	321	123	Average