



SPORTON International Inc.

No. 52, Hwa Ya 1st Rd., Hwa Ya Technology Park, Kwei-Shan Hsiang, Tao Yuan Hsien, Taiwan, R.O.C.
Ph: 886-3-327-3456 / FAX: 886-3-327-0973 / www.sporton.com.tw

FCC RADIO TEST REPORT

Applicant's company	AOD Co., Ltd.
Applicant Address	No. 4 Building, 16 East Guangdian Road, High-tech Development Zone, Weifang, Shandong, 261061, China.
FCC ID	2AKWW-A22001462
Manufacturer's company	Abocom Systems, Inc.
Manufacturer Address	No.77, Yu-Yih Rd., Chu-Nan, Miao-Lih County 35059, Taiwan R.O.C.

Product Name	AW-B2 Super WiFi CPE/AP
Brand Name	AODGROUP
Model No.	A22001462
Test Rule Part(s)	47 CFR FCC Part 15 Subpart E § 15.407
Test Freq. Range	5150 ~ 5250 MHz / 5725 ~ 5850 MHz
Received Date	Nov. 05, 2015
Final Test Date	Jan. 10, 2017
Submission Type	Original Equipment

Statement

Test result included is for the IEEE 802.11n and IEEE 802.11a/ac of the product.

The test result in this report refers exclusively to the presented test model / sample.

Without written approval of SPORTON International Inc., the test report shall not be reproduced except in full.

The measurements and test results shown in this test report were made in accordance with the procedures and found in compliance with the limit given in **ANSI C63.10-2013, 47 CFR FCC Part 15 Subpart E, KDB789033 D02 v01r03, KDB662911 D01 v02r01, KDB644545 D03 v01.**

The test equipment used to perform the test is calibrated and traceable to NML/ROC.



Table of Contents

1. VERIFICATION OF COMPLIANCE	1
2. SUMMARY OF THE TEST RESULT	2
3. GENERAL INFORMATION	3
3.1. Product Details.....	3
3.2. Accessories.....	4
3.3. Table for Filed Antenna.....	5
3.4. Table for Carrier Frequencies	5
3.5. Table for Test Modes	6
3.6. Table for Testing Locations.....	8
3.7. Table for Supporting Units	8
3.8. Table for Parameters of Test Software Setting	9
3.9. EUT Operation during Test	9
3.10. Duty Cycle.....	9
3.11. Test Configurations	10
4. TEST RESULT	13
4.1. AC Power Line Conducted Emissions Measurement.....	13
4.2. 26dB Bandwidth and 99% Occupied Bandwidth Measurement.....	17
4.3. 6dB Spectrum Bandwidth Measurement	28
4.4. Maximum Conducted Output Power Measurement.....	33
4.5. Power Spectral Density Measurement	36
4.6. Radiated Emissions Measurement	45
4.7. Band Edge Emissions Measurement	70
4.8. Frequency Stability Measurement	79
4.9. Antenna Requirements	86
5. LIST OF MEASURING EQUIPMENTS	87
6. MEASUREMENT UNCERTAINTY.....	88
APPENDIX A. TEST PHOTOS	A1 ~ A4
APPENDIX B. RADIATED EMISSION CO-LOCATION REPORT.....	B1 ~ B3
PHOTOGRAPHS OF EUT V01	



History of This Test Report

REPORT NO.	VERSION	DESCRIPTION	ISSUED DATE
FR5N0420-03AB	Rev. 01	Initial issue of report	Mar. 24, 2017

1. VERIFICATION OF COMPLIANCE

Product Name : AW-B2 Super WiFi CPE/AP
Brand Name : AODGROUP
Model No. : A22001462
Applicant : AOD Co., Ltd.
Test Rule Part(s) : 47 CFR FCC Part 15 Subpart E § 15.407

Sporton International as requested by the applicant to evaluate the EMC performance of the product sample received on Nov. 05, 2015 would like to declare that the tested sample has been evaluated and found to be in compliance with the tested rule parts. The data recorded as well as the test configuration specified is true and accurate for showing the sample's EMC nature.

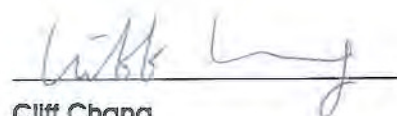

Cliff Chang

SPORTON INTERNATIONAL INC.

2. SUMMARY OF THE TEST RESULT

Applied Standard: 47 CFR FCC Part 15 Subpart E			
Part	Rule Section	Description of Test	Result
4.1	15.207	AC Power Line Conducted Emissions	Complies
4.2	15.407(a)	26dB Spectrum Bandwidth and 99% Occupied Bandwidth	Complies
4.3	15.407(e)	6dB Spectrum Bandwidth	Complies
4.4	15.407(a)	Maximum Conducted Output Power	Complies
4.5	15.407(a)	Power Spectral Density	Complies
4.6	15.407(b)	Radiated Emissions	Complies
4.7	15.407(b)	Band Edge Emissions	Complies
4.8	15.407(g)	Frequency Stability	Complies
4.9	15.203	Antenna Requirements	Complies

3. GENERAL INFORMATION

3.1. Product Details

Items	Description
Product Type	WLAN (2TX, 2RX)
Radio Type	Intentional Transceiver
Power Type	From power adapter and PoE
Modulation	IEEE 802.11a: OFDM IEEE 802.11n/ac: see the below table
Data Modulation	IEEE 802.11a/n: OFDM (BPSK / QPSK / 16QAM / 64QAM) IEEE 802.11ac: OFDM (BPSK / QPSK / 16QAM / 64QAM / 256QAM)
Data Rate (Mbps)	IEEE 802.11a: OFDM (6/9/12/18/24/36/48/54) IEEE 802.11n/ac: see the below table
Frequency Range	5150 ~ 5250 MHz / 5725 ~ 5850 MHz
Channel Number	9 for 20MHz bandwidth ; 4 for 40MHz bandwidth 2 for 80MHz bandwidth
Channel Band Width (99%)	Band 1: IEEE 802.11a: 16.76 MHz IEEE 802.11ac MCS0/Nss1 (VHT20): 17.80 MHz IEEE 802.11ac MCS0/Nss1 (VHT40): 36.76 MHz IEEE 802.11ac MCS0/Nss1 (VHT80): 74.67 MHz Band 4: IEEE 802.11a: 17.02 MHz IEEE 802.11ac MCS0/Nss1 (VHT20): 18.49 MHz IEEE 802.11ac MCS0/Nss1 (VHT40): 37.48 MHz IEEE 802.11ac MCS0/Nss1 (VHT80): 74.96 MHz
Maximum Conducted Output Power	Band 1: IEEE 802.11a: 23.96 dBm IEEE 802.11ac MCS0/Nss1 (VHT20): 23.87 dBm IEEE 802.11ac MCS0/Nss1 (VHT40): 24.69 dBm IEEE 802.11ac MCS0/Nss1 (VHT80): 15.59 dBm Band 4: IEEE 802.11a: 23.96 dBm IEEE 802.11ac MCS0/Nss1 (VHT20): 23.94 dBm IEEE 802.11ac MCS0/Nss1 (VHT40): 24.63 dBm IEEE 802.11ac MCS0/Nss1 (VHT80): 13.46 dBm
Carrier Frequencies	Please refer to section 3.4
Antenna	Please refer to section 3.3

Items	Description	
Communication Mode	<input checked="" type="checkbox"/> IP Based (Load Based)	<input type="checkbox"/> Frame Based
Beamforming Function	<input type="checkbox"/> With beamforming	<input checked="" type="checkbox"/> Without beamforming
Operate Condition	<input checked="" type="checkbox"/> Indoor	<input type="checkbox"/> Outdoor

Antenna and Band width

Antenna	Two (TX)		
	20 MHz	40 MHz	80 MHz
IEEE 802.11a	V	X	X
IEEE 802.11n	V	V	X
IEEE 802.11ac	V	V	V

IEEE 11n/ac Spec.

Protocol	Number of Transmit Chains (NTX)	Data Rate / MCS
802.11n (HT20)	2	MCS 0-15
802.11n (HT40)	2	MCS 0-15
802.11ac (VHT20)	2	MCS 0-9/Nss1-2
802.11ac (VHT40)	2	MCS 0-9/Nss1-2
802.11ac (VHT80)	2	MCS 0-9/Nss1-2

Note 1: IEEE Std. 802.11n modulation consists of HT20 and HT40 (HT: High Throughput).
Then EUT supports HT20 and HT40.

Note 2: IEEE Std. 802.11ac modulation consists of VHT20, VHT40, VHT80 and VHT160 (VHT: Very High Throughput). Then EUT supports VHT20, VHT40 and VHT80.

Note 3: Modulation modes consist of below configuration:
HT20/HT40: IEEE 802.11n, VHT20/VHT40/VHT80: IEEE 802.11ac

3.2. Accessories

Power	Brand	Model No.	Rating	Remark
Adapter	MW	GST25U24	Input: 100-240VAC, 50/60Hz, 0.6A Output: 24V, 1.04A, 25W MAX.	-
PoE	CERIO	POE-PE03GE	-	With adapter use

3.3. Table for Filed Antenna

Ant.	Brand	Model Name	Antenna Type	Connector	Gain (dBi)	
					2.4GHz	5GHz
1	SmartAnt	ABO14-220550	Directional Antenna	I-PEX	6	9

Note: Chain 1 and Chain 2 could transmit/receive simultaneously.

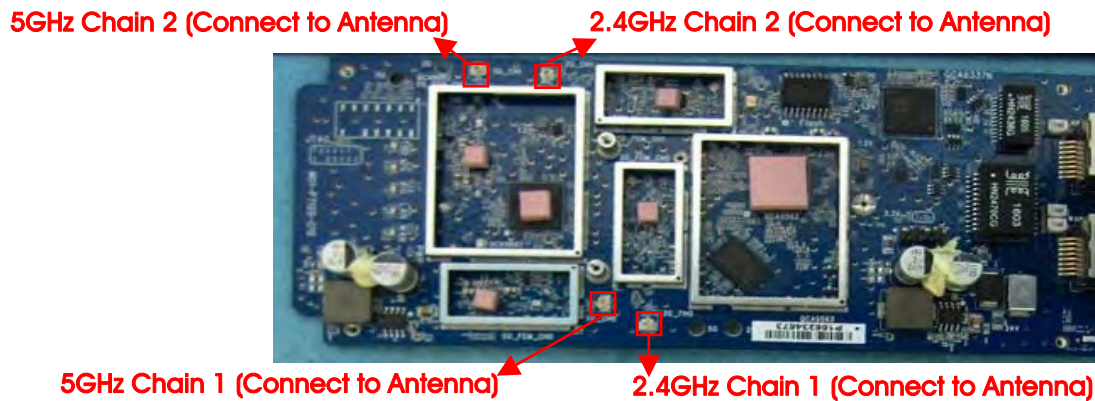

3.4. Table for Carrier Frequencies

There are three bandwidth systems.

For 20MHz bandwidth systems, use Channel 36, 40, 44, 48, 149, 153, 157, 161, 165.

For 40MHz bandwidth systems, use Channel 38, 46, 151, 159.

For 80MHz bandwidth systems, use Channel 42, 155.

Frequency Band	Channel No.	Frequency	Channel No.	Frequency
5150~5250 MHz Band 1	36	5180 MHz	44	5220 MHz
	38	5190 MHz	46	5230 MHz
	40	5200 MHz	48	5240 MHz
	42	5210 MHz	-	-
5725~5850 MHz Band 4	149	5745 MHz	157	5785 MHz
	151	5755 MHz	159	5795 MHz
	153	5765 MHz	161	5805 MHz
	155	5775 MHz	165	5825 MHz

3.5. Table for Test Modes

Preliminary tests were performed in different data rate to find the worst radiated emission. The data rate shown in the table below is the worst-case rate with respect to the specific test item. Investigation has been done on all the possible configurations for searching the worst cases. The following table is a list of the test modes shown in this test report.

Test Items	Mode		Data Rate	Channel	Chain
AC Power Conducted Emission	Normal Link		-	-	-
Max. Conducted Output Power	11a/BPSK	Band 1&4	6Mbps	36/40/48/149/157/ 165	1+2
	11ac VHT20	Band 1&4	MCS0/Nss1	36/40/48/149/157/ 165	1+2
	11ac VHT40	Band 1&4	MCS0/Nss1	38/46/151/159	1+2
	11ac VHT80	Band 1&4	MCS0/Nss1	42/155	1+2
Power Spectral Density	11a/BPSK	Band 1&4	6Mbps	36/40/48/149/157/ 165	1+2
	11ac VHT20	Band 1&4	MCS0/Nss1	36/40/48/149/157/ 165	1+2
	11ac VHT40	Band 1&4	MCS0/Nss1	38/46/151/159	1+2
	11ac VHT80	Band 1&4	MCS0/Nss1	42/155	1+2
26dB Spectrum Bandwidth & 99% Occupied Bandwidth Measurement	11a/BPSK	Band 1&4	6Mbps	36/40/48/149/157/ 165	1+2
	11ac VHT20	Band 1&4	MCS0/Nss1	36/40/48/149/157/ 165	1+2
	11ac VHT40	Band 1&4	MCS0/Nss1	38/46/151/159	1+2
	11ac VHT80	Band 1&4	MCS0/Nss1	42/155	1+2
6dB Spectrum Bandwidth Measurement	11a/BPSK	Band 4	6Mbps	149/157/165	1+2
	11ac VHT20	Band 4	MCS0/Nss1	149/157/165	1+2
	11ac VHT40	Band 4	MCS0/Nss1	151/159	1+2
	11ac VHT80	Band 4	MCS0/Nss1	155	1+2
Radiated Emission Below 1GHz	Normal Link		-	-	-
Radiated Emission Above 1GHz	11a/BPSK	Band 1&4	6Mbps	36/40/48/149/157/ 165	1+2
	11ac VHT20	Band 1&4	MCS0/Nss1	36/40/48/149/157/ 165	1+2
	11ac VHT40	Band 1&4	MCS0/Nss1	38/46/151/159	1+2
	11ac VHT80	Band 1&4	MCS0/Nss1	42/155	1+2

Band Edge Emission	11a/BPSK	Band 1&4	6Mbps	36/40/48/149/157/ 165	1+2
	11ac VHT20	Band 1&4	MCS0/Nss1	36/40/48/149/157/ 165	1+2
	11ac VHT40	Band 1&4	MCS0/Nss1	38/46/151/159	1+2
	11ac VHT80	Band 1&4	MCS0/Nss1	42/155	1+2
Frequency Stability	20 MHz	Band 1&4	-	40/157	1
	40 MHz	Band 1&4	-	38/151	1
	80 MHz	Band 1&4	-	42/155	1

Note: 1. The EUT can used in Y-axis only.

2. VHT20/VHT40 covers HT20/HT40, due to same modulation. The power setting for 802.11n HT20 and HT40 are the same or lower than 802.11ac VHT20 and VHT40.

For Co-location MPE and Radiated Emission Co-location test:

The EUT could be applied with 2.4GHz WLAN function and 5GHz WLAN function; therefore Co-location Maximum Permissible Exposure (Please refer to FA5N0420-03) and Radiated Emission Co-location (please refer to Appendix B) tests are added for simultaneously transmit between 2.4GHz WLAN function and 5GHz WLAN function.

3.6. Table for Testing Locations

Test Site Location				
Address:	No.8, Lane 724, Bo-ai St., Jhubei City, Hsinchu County 302, Taiwan, R.O.C.			
TEL:	886-3-656-9065			
FAX:	886-3-656-9085			
Test Site No.	Site Category	Location	FCC Reg. No.	IC File No.
03CH01-CB	SAC	Hsin Chu	TW0006	IC 4086D
CO02-CB	Conduction	Hsin Chu	TW0006	IC 4086D
TH01-CB	OVEN Room	Hsin Chu	-	-

Open Area Test Site (OATS); Semi Anechoic Chamber (SAC).

3.7. Table for Supporting Units

For Test Site No: 03CH01-CB (below 1GHz)

Support Unit	Brand	Model	FCC ID
Notebook*2	DELL	E4300	DoC
Notebook*2	Apple	Mac Book	DoC

For Test Site No: 03CH01-CB (above 1GHz) and TH01-CB

Support Unit	Brand	Model	FCC ID
Notebook	DELL	E4300	DoC

For Test Site No: CO02-CB

Support Unit	Brand	Model	FCC ID
Notebook*4	DELL	E6430	DoC

3.8. Table for Parameters of Test Software Setting

During testing, Channel and Power Controlling Software provided by the customer was used to control the operating channel as well as the output power level. The RF output power selection is for the setting of RF output power expected by the customer and is going to be fixed on the firmware of the final end product.

Test Software Version	ART2-GUI 2.3					
Mode	Test Frequency (MHz)					
	NCB: 20MHz					
	5180 MHz	5200 MHz	5240 MHz	5745 MHz	5785 MHz	5825 MHz
802.11a	19.5	20	20.5	19	21	21
802.11ac MCS0/Nss1 VHT20	19.5	20	20.5	19	21	20
Mode	NCB: 40MHz					
802.11ac MCS0/Nss1 VHT40	5190 MHz		5230 MHz		5755 MHz	
	19.5		21.5		17.5	
Mode	NCB: 80MHz					
802.11ac MCS0/Nss1 VHT80	5210 MHz			5775 MHz		
	13			11.5		

3.9. EUT Operation during Test

The EUT was programmed to be in continuously transmitting mode.

3.10. Duty Cycle

Mode	On Time (ms)	On+Off Time (ms)	Duty Cycle (%)	Duty Factor (dB)	1/T Minimum VBW (kHz)
802.11a	2.020	2.110	95.73	0.19	0.50
802.11ac MCS0/Nss1 VHT20	1.890	2.020	93.56	0.29	0.53
802.11ac MCS0/Nss1 VHT40	0.904	1.010	89.50	0.48	1.11
802.11ac MCS0/Nss1 VHT80	0.434	0.528	82.20	0.85	2.30

3.11. Test Configurations

3.11.1. AC Power Line Conduction Emissions Test Configuration

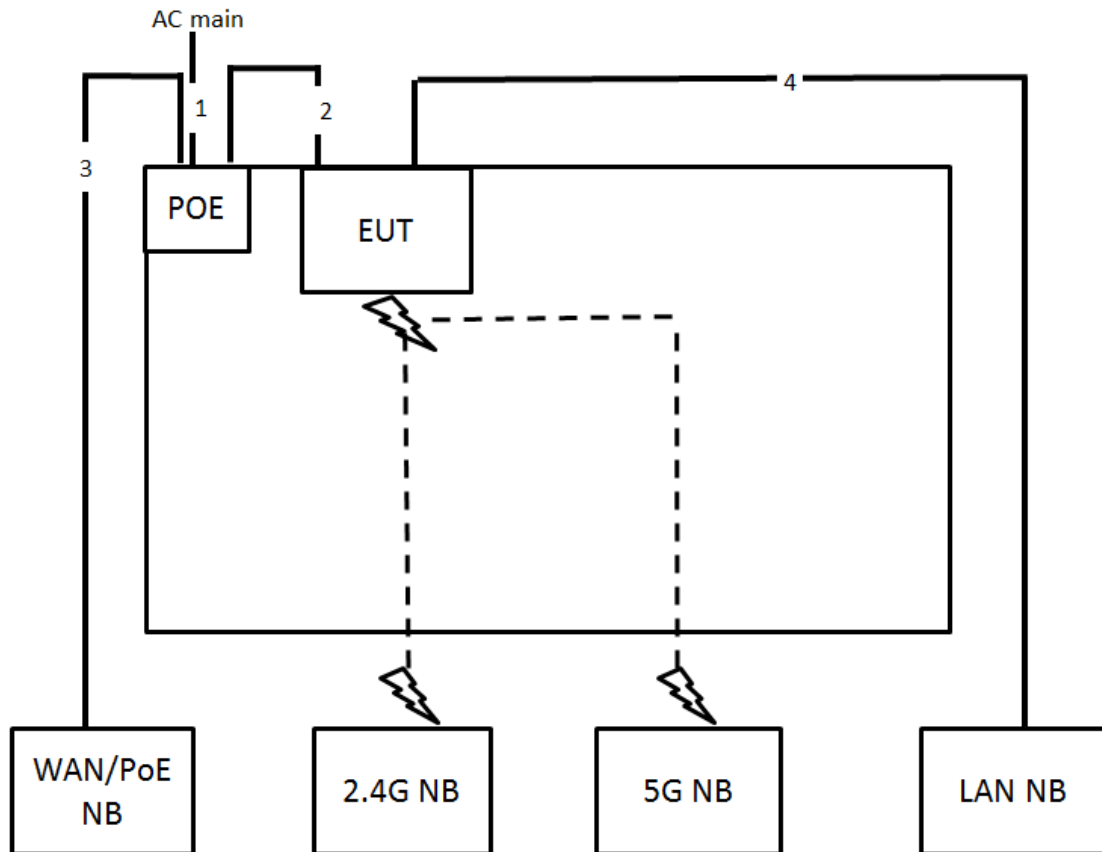

Item	Connection	Shielded	Length
1	Power cable	No	1.8m
2	RJ-45 cable	No	1.5m
3	RJ-45 cable	No	10m
4	RJ-45 cable	No	10m

3.11.2. Radiation Emissions Test Configuration

Test Configuration: 30MHz~1GHz

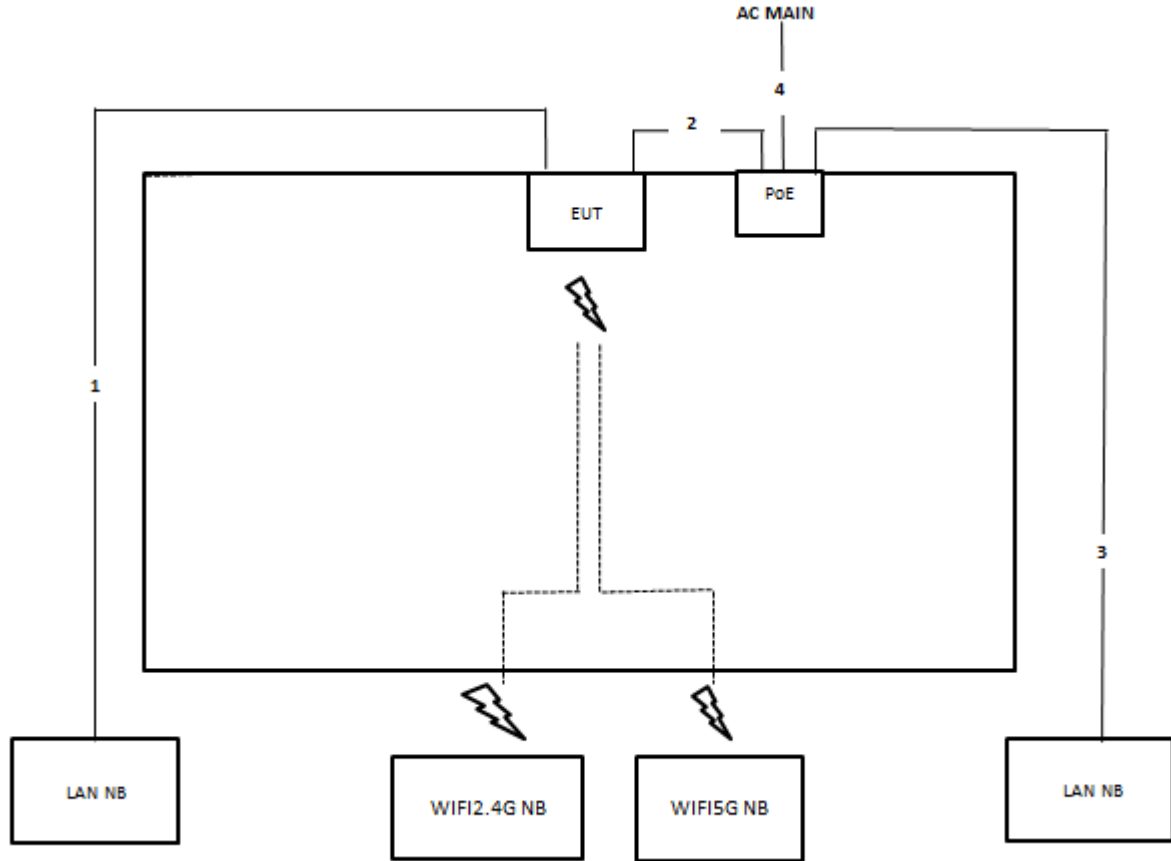

Item	Connection	Shielded	Length
1	RJ-45 cable	No	10m
2	RJ-45 cable	No	1.5m
3	RJ-45 cable	No	10m
4	Power cable	No	1.8m

Test Configuration: above 1GHz

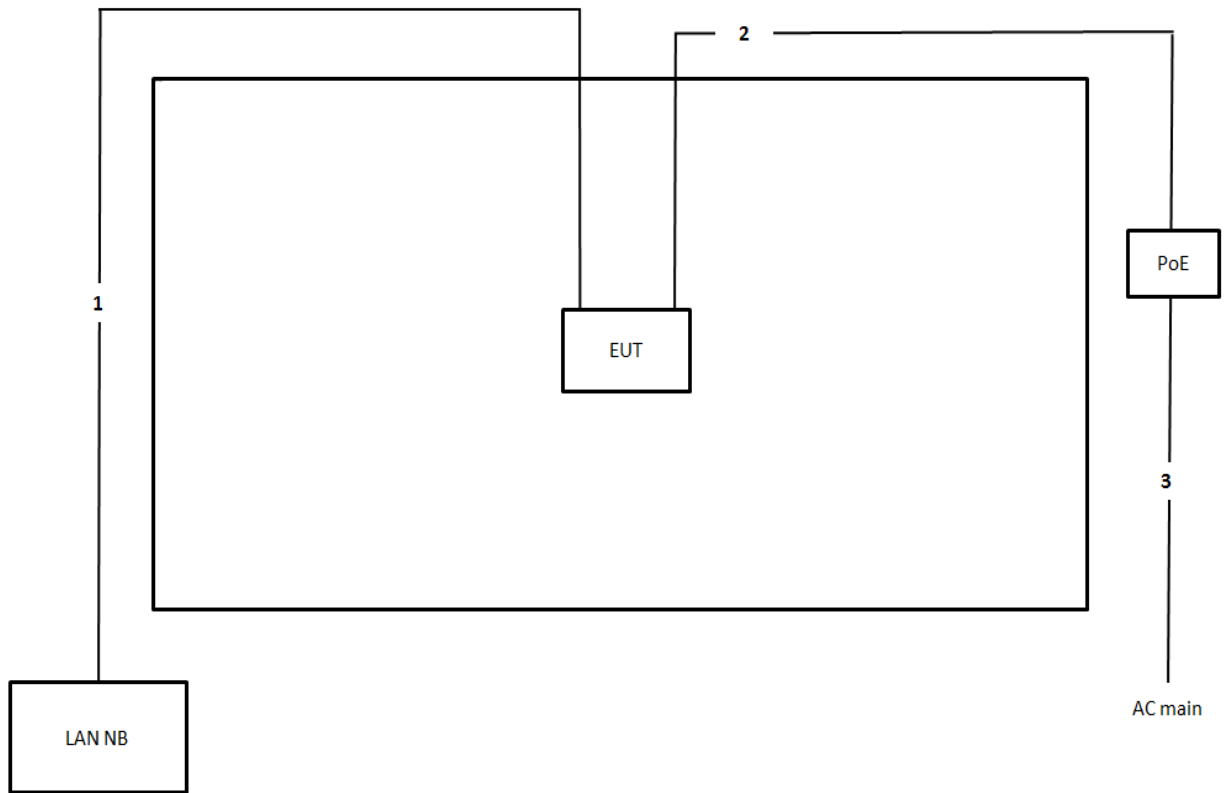

Item	Connection	Shielded	Length
1	RJ-45 cable	No	10m
2	RJ-45 cable	No	10m
3	Power cable	No	1.8m

4. TEST RESULT

4.1. AC Power Line Conducted Emissions Measurement

4.1.1. Limit

For this product that is designed to connect to the AC power line, the radio frequency voltage that is conducted back onto the AC power line on any frequency or frequencies within the band 150 kHz to 30 MHz shall not exceed below limits table.

Frequency (MHz)	QP Limit (dBuV)	AV Limit (dBuV)
0.15~0.5	66~56	56~46
0.5~5	56	46
5~30	60	50

4.1.2. Measuring Instruments and Setting

Please refer to section 5 of equipments list in this report. The following table is the setting of the receiver.

Receiver Parameters	Setting
Attenuation	10 dB
Start Frequency	0.15 MHz
Stop Frequency	30 MHz
IF Bandwidth	9 kHz

4.1.3. Test Procedures

1. Configure the EUT according to ANSI C63.10. The EUT or host of EUT has to be placed 0.4 meter far from the conducting wall of the shielding room and at least 80 centimeters from any other grounded conducting surface.
2. Connect EUT or host of EUT to the power mains through a line impedance stabilization network (LISN).
3. All the support units are connected to the other LISNs. The LISN should provide 50uH/50ohms coupling impedance.
4. The frequency range from 150 kHz to 30 MHz was searched.
5. Set the test-receiver system to Peak Detect Function and Specified Bandwidth with Maximum Hold Mode.
6. The measurement has to be done between each power line and ground at the power terminal.

4.1.4. Test Setup Layout

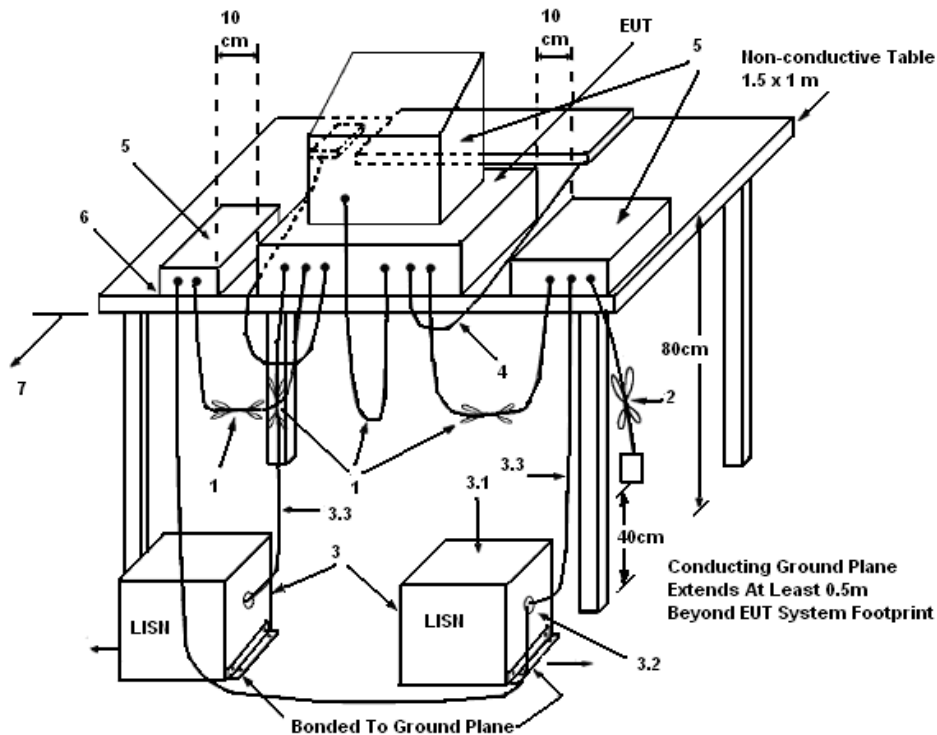

LEGEND:

- (1) Interconnecting cables that hang closer than 40 cm to the ground plane shall be folded back and forth in the center forming a bundle 30 to 40 cm long.
- (2) I/O cables that are not connected to a peripheral shall be bundled in the center. The end of the cable may be terminated, if required, using the correct terminating impedance. The overall length shall not exceed 1 m.
- (3) EUT connected to one LISN. Unused LISN measuring port connectors shall be terminated in 50 Ω . LISN can be placed on top of, or immediately beneath, reference ground plane.
 - (3.1) All other equipment powered from additional LISN(s).
 - (3.2) Multiple outlet strip can be used for multiple power cords of non-EUT equipment.
 - (3.3) LISN at least 80 cm from nearest part of EUT chassis.
- (4) Cables of hand-operated devices, such as keyboards, mice, etc., shall be placed as for normal use.
- (5) Non-EUT components of EUT system being tested.
- (6) Rear of EUT, including peripherals, shall all be aligned and flush with rear of tabletop.
- (7) Rear of tabletop shall be 40 cm removed from a vertical conducting plane that is bonded to the ground plane.

4.1.5. Test Deviation

There is no deviation with the original standard.

4.1.6. EUT Operation during Test

The EUT was placed on the test table and programmed in normal function.

4.1.7. Results of AC Power Line Conducted Emissions Measurement

Temperature	23°C	Humidity	55%
Test Engineer	GN Hou / Deven Huang	Phase	Line
Configuration	Normal Link		

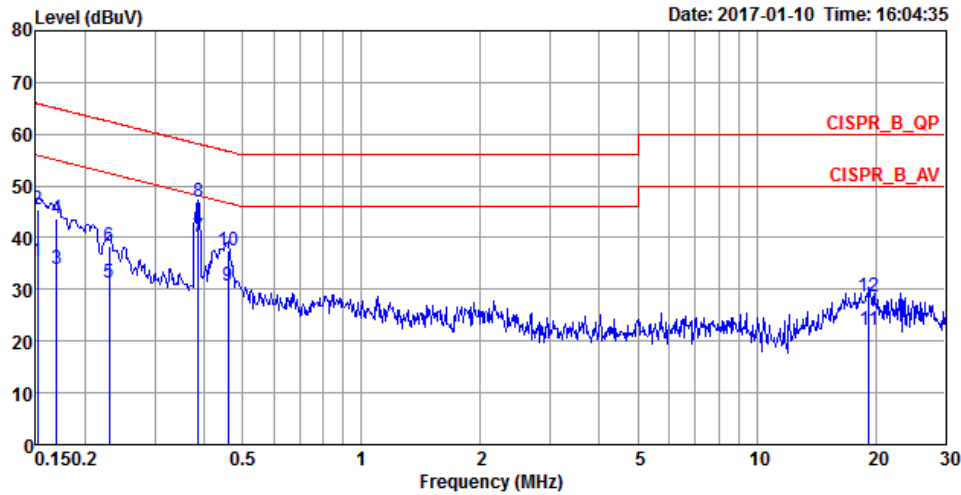

	Freq	Level	Over Limit	Limit Line	Read Level	LISN Factor	Cable Loss	Remark	Pol/Phase
	MHz	dBuV	dB	dBuV	dBuV	dB	dB		
1	0.1516	35.44	-20.47	55.91	25.45	9.95	0.04	Average	LINE
2	0.1516	45.48	-20.43	65.91	35.49	9.95	0.04	QP	LINE
3	0.1694	33.93	-21.06	54.99	23.95	9.94	0.04	Average	LINE
4	0.1694	43.73	-21.26	64.99	33.75	9.94	0.04	QP	LINE
5	0.2304	31.16	-21.28	52.44	21.19	9.92	0.05	Average	LINE
6	0.2304	38.26	-24.18	62.44	28.29	9.92	0.05	QP	LINE
7	0.3872	40.09	-8.03	48.12	30.16	9.89	0.04	Average	LINE
8	0.3872	46.85	-11.27	58.12	36.92	9.89	0.04	QP	LINE
9	0.4588	30.56	-16.15	46.71	20.62	9.90	0.04	Average	LINE
10	0.4588	37.59	-19.12	56.71	27.65	9.90	0.04	QP	LINE
11	19.2236	22.00	-28.00	50.00	11.54	10.21	0.25	Average	LINE
12	19.2236	28.61	-31.39	60.00	18.15	10.21	0.25	QP	LINE

Temperature	23°C	Humidity	55%
Test Engineer	GN Hou / Deven Huang	Phase	Neutral
Configuration	Normal Link		

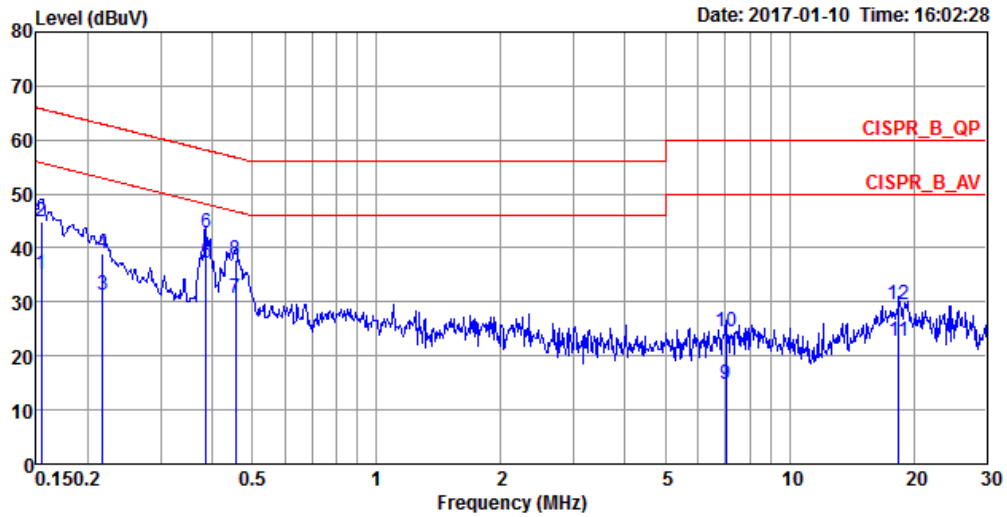

	Freq	Level	Over Limit	Limit Line	Read Level	LISN Factor	Cable Loss	Remark	Pol/Phase
	MHz	dBuV	dB	dBuV	dBuV	dB	dB		
1	0.1540	35.13	-20.65	55.78	25.15	9.94	0.04	Average	NEUTRAL
2	0.1540	45.00	-20.78	65.78	35.02	9.94	0.04	QP	NEUTRAL
3	0.2174	31.40	-21.52	52.92	21.37	9.98	0.05	Average	NEUTRAL
4	0.2174	38.97	-23.95	62.92	28.94	9.98	0.05	QP	NEUTRAL
5	0.3872	37.19	-10.93	48.12	27.19	9.96	0.04	Average	NEUTRAL
6	0.3872	42.93	-15.19	58.12	32.93	9.96	0.04	QP	NEUTRAL
7	0.4564	30.66	-16.10	46.76	20.66	9.96	0.04	Average	NEUTRAL
8	0.4564	37.68	-19.08	56.76	27.68	9.96	0.04	QP	NEUTRAL
9	7.0249	14.69	-35.31	50.00	4.40	10.13	0.16	Average	NEUTRAL
10	7.0249	24.53	-35.47	60.00	14.24	10.13	0.16	QP	NEUTRAL
11	18.4258	22.81	-27.19	50.00	12.30	10.27	0.24	Average	NEUTRAL
12	18.4258	29.66	-30.34	60.00	19.15	10.27	0.24	QP	NEUTRAL

Note:

Level = Read Level + LISN Factor + Cable Loss.

4.2. 26dB Bandwidth and 99% Occupied Bandwidth Measurement

4.2.1. Limit

No restriction limits.

4.2.2. Measuring Instruments and Setting

Please refer to section 5 of equipments list in this report. The following table is the setting of the spectrum analyzer.

26dB Bandwidth	
Spectrum Parameters	Setting
Attenuation	Auto
Span Frequency	> 26dB Bandwidth
RBW	Approximately 1% of the emission bandwidth
VBW	VBW > RBW
Detector	Peak
Trace	Max Hold
Sweep Time	Auto
99% Occupied Bandwidth	
Spectrum Parameters	Setting
Span	1.5 times to 5.0 times the OBW
RBW	1 % to 5 % of the OBW
VBW	$\geq 3 \times \text{RBW}$
Detector	Peak
Trace	Max Hold

4.2.3. Test Procedures

For Radiated 26dB Bandwidth and 99% Occupied Bandwidth Measurement:

1. The transmitter was radiated to the spectrum analyzer in peak hold mode.
2. Measure the maximum width of the emission that is 26 dB down from the peak of the emission. Compare this with the RBW setting of the analyzer. Readjust RBW and repeat measurement as needed until the RBW/EBW ratio is approximately 1%.

4.2.4. Test Setup Layout

For Radiated 26dB Bandwidth and 99% Occupied Bandwidth Measurement:

This test setup layout is the same as that shown in section 4.6.4.

4.2.5. Test Deviation

There is no deviation with the original standard.

4.2.6. EUT Operation during Test

The EUT was programmed to be in continuously transmitting mode.

4.2.7. Test Result of 26dB Bandwidth and 99% Occupied Bandwidth

Temperature	25°C	Humidity	45%
Test Engineer	Lucas Huang		

Mode	Frequency	26dB Bandwidth (MHz)	99% Occupied Bandwidth (MHz)
802.11a	5180 MHz	21.04	16.67
	5200 MHz	20.87	16.76
	5240 MHz	21.39	16.76
	5745 MHz	21.22	16.06
	5785 MHz	20.96	17.02
	5825 MHz	20.87	15.80
802.11ac MCS0/Nss1 VHT20	5180 MHz	22.00	17.80
	5200 MHz	20.78	17.71
	5240 MHz	20.69	17.63
	5745 MHz	23.57	18.41
	5785 MHz	22.86	18.49
	5825 MHz	19.91	16.15
802.11ac MCS0/Nss1 VHT40	5190 MHz	43.04	36.76
	5230 MHz	42.46	36.32
	5755 MHz	43.77	36.18
	5795 MHz	45.65	37.48
802.11ac MCS0/Nss1 VHT80	5210 MHz	82.60	74.67
	5775 MHz	82.32	74.96

26dB Bandwidth and 99% Occupied Bandwidth Plot on Configuration IEEE 802.11a / Chain 1 + Chain 2 / 5180 MHz

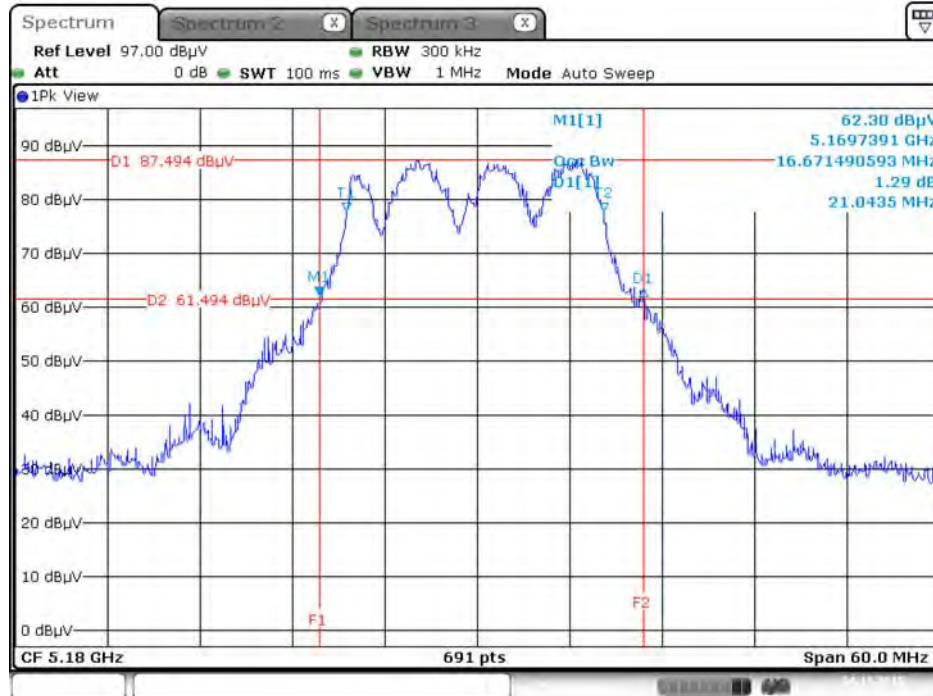

Date: 24.NOV.2015 02:09:46

26dB Bandwidth and 99% Occupied Bandwidth Plot on Configuration IEEE 802.11a / Chain 1 + Chain 2 / 5200 MHz

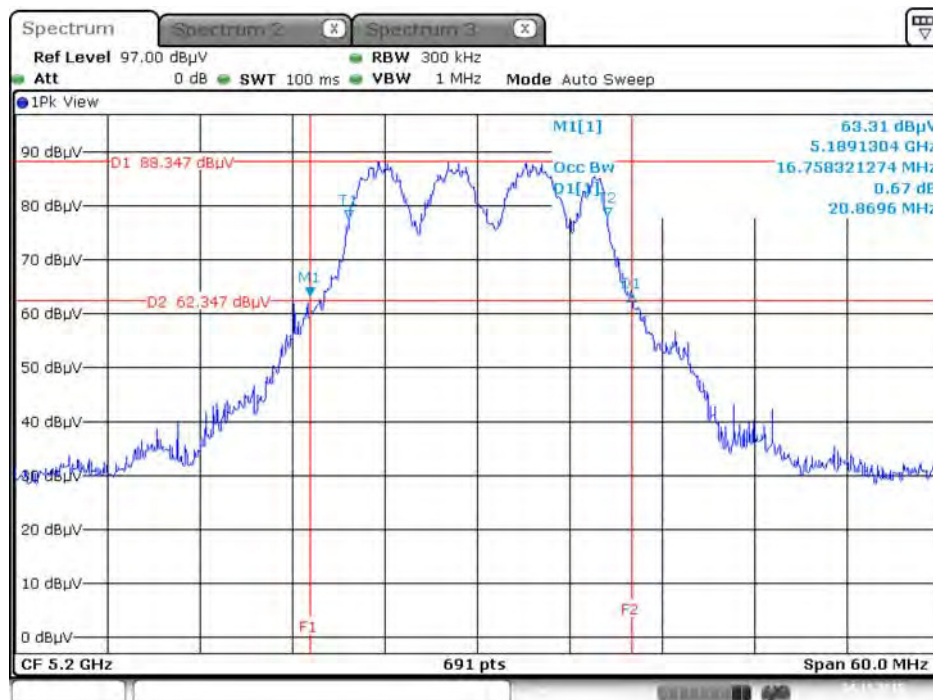

Date: 24.NOV.2015 02:10:22

26dB Bandwidth and 99% Occupied Bandwidth Plot on Configuration IEEE 802.11a / Chain 1 + Chain 2 / 5240 MHz

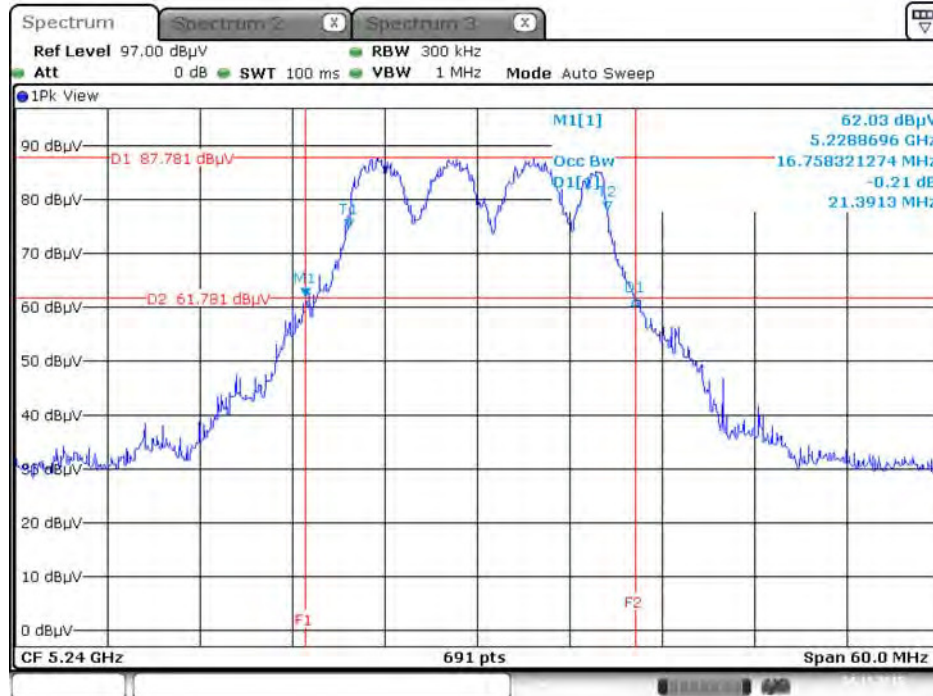

Date: 24.NOV.2015 02:10:44

26dB Bandwidth and 99% Occupied Bandwidth Plot on Configuration IEEE 802.11a / Chain 1 + Chain 2 / 5745 MHz

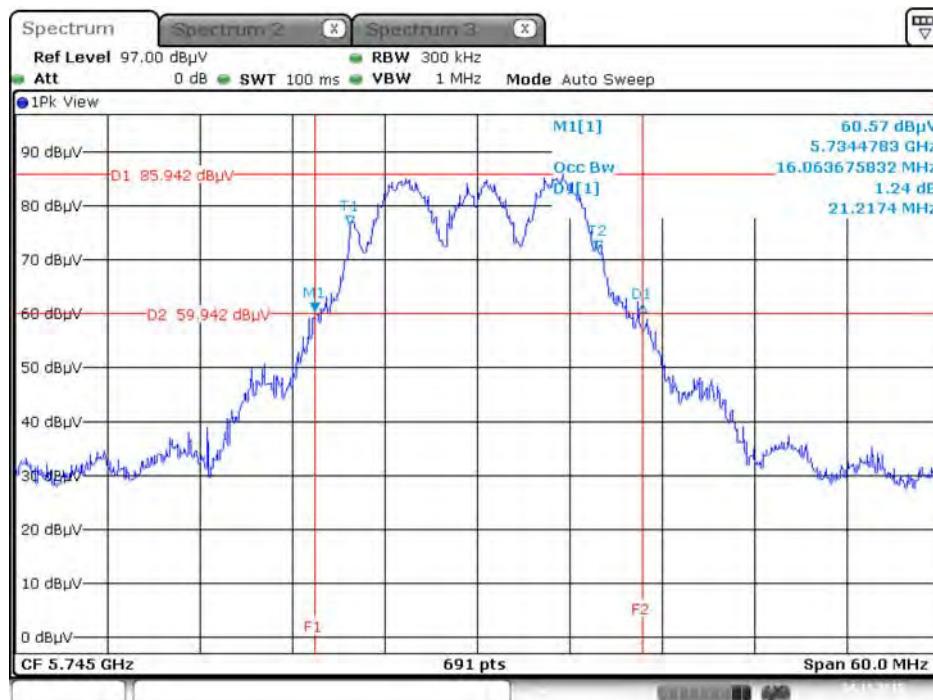

Date: 24.NOV.2015 02:11:10

26dB Bandwidth and 99% Occupied Bandwidth Plot on Configuration IEEE 802.11a / Chain 1 + Chain 2 / 5785 MHz

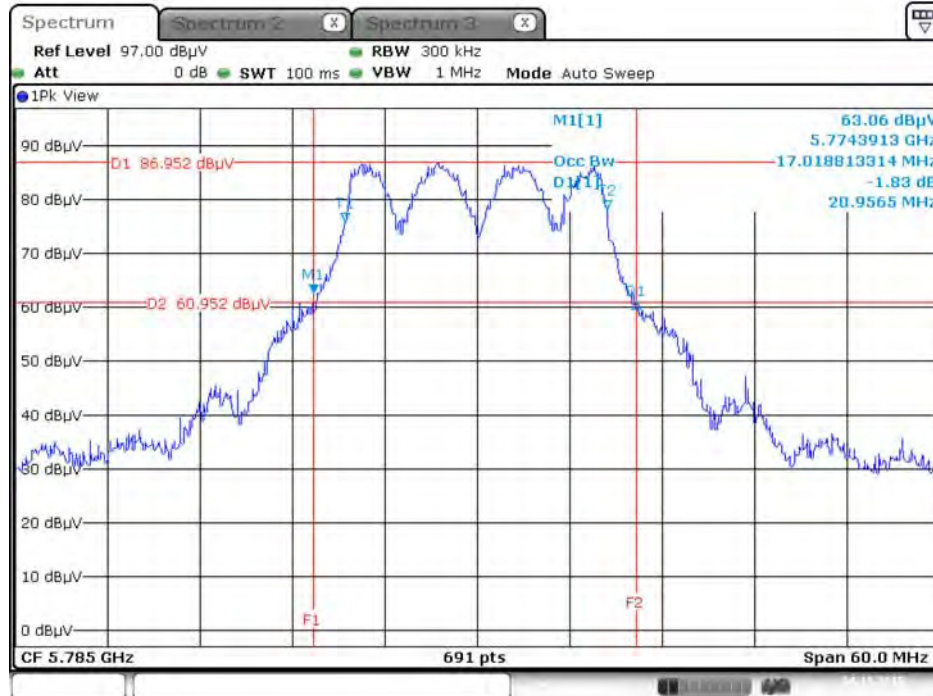

Date: 24.NOV.2015 02:11:37

26dB Bandwidth and 99% Occupied Bandwidth Plot on Configuration IEEE 802.11a / Chain 1 + Chain 2 / 5825 MHz

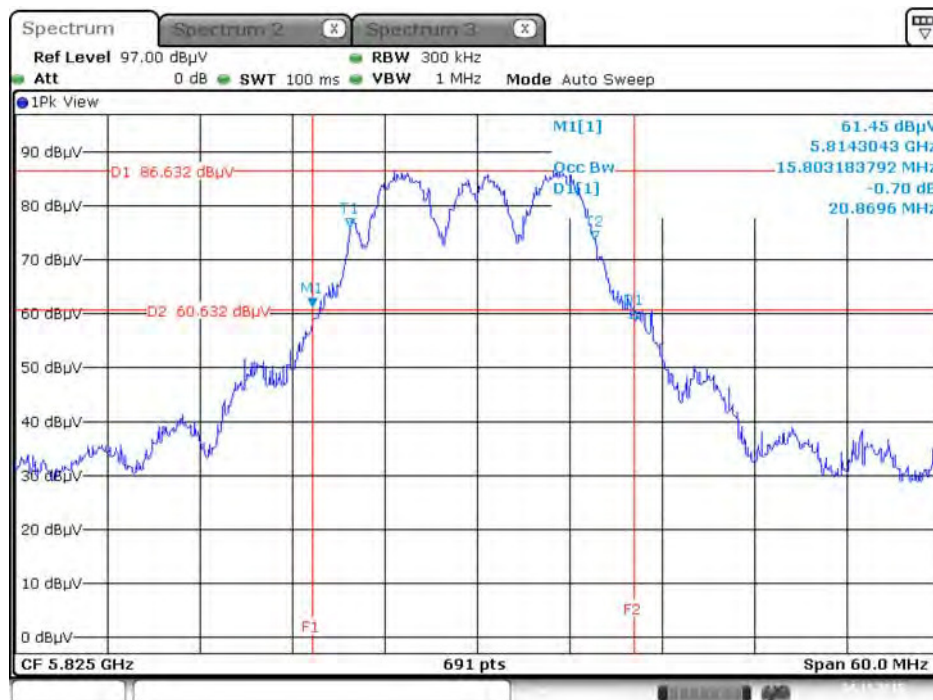

Date: 24.NOV.2015 02:12:35

26dB Bandwidth and 99% Occupied Bandwidth Plot on Configuration IEEE 802.11ac MCS0/Nss1 VHT20 / Chain 1 + Chain 2 / 5180 MHz

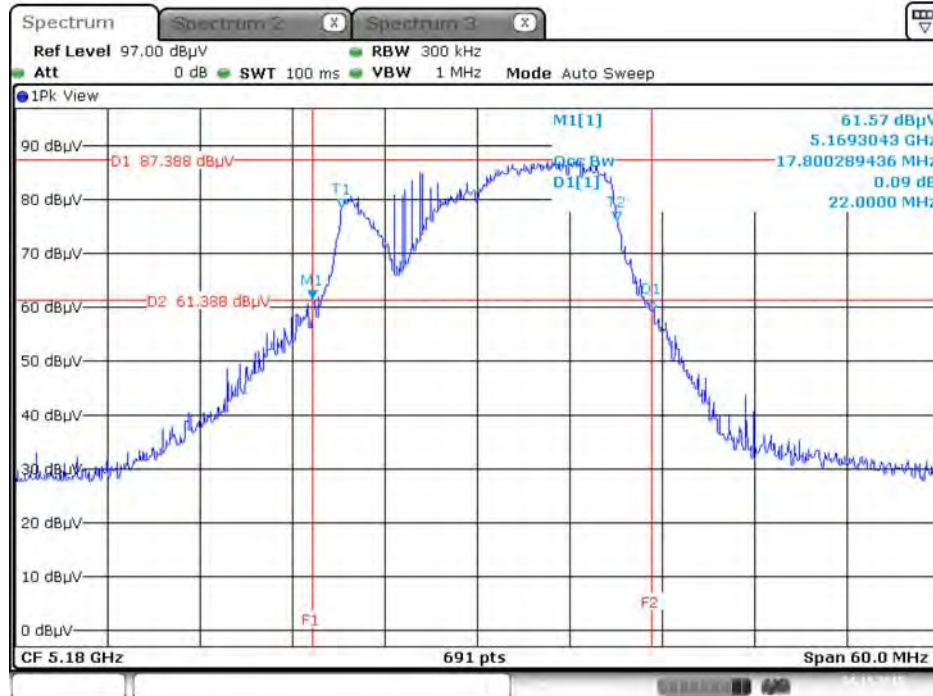

Date: 24.NOV.2015 02:13:09

26dB Bandwidth and 99% Occupied Bandwidth Plot on Configuration IEEE 802.11ac MCS0/Nss1 VHT20 / Chain 1 + Chain 2 / 5200 MHz

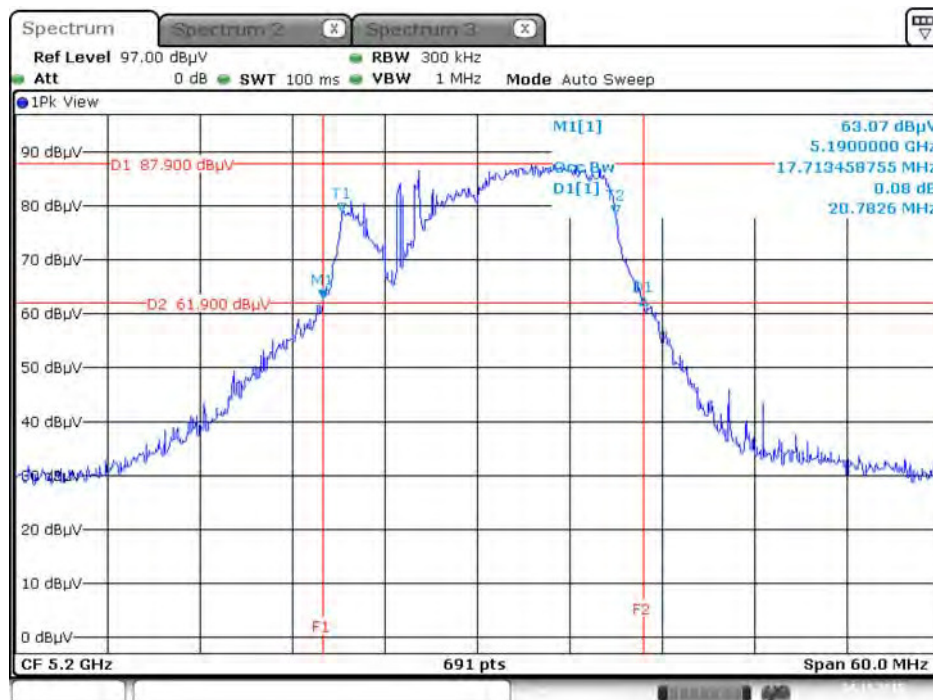

Date: 24.NOV.2015 02:13:39

26dB Bandwidth and 99% Occupied Bandwidth Plot on Configuration IEEE 802.11ac MCS0/Nss1 VHT20 / Chain 1 + Chain 2 / 5240 MHz

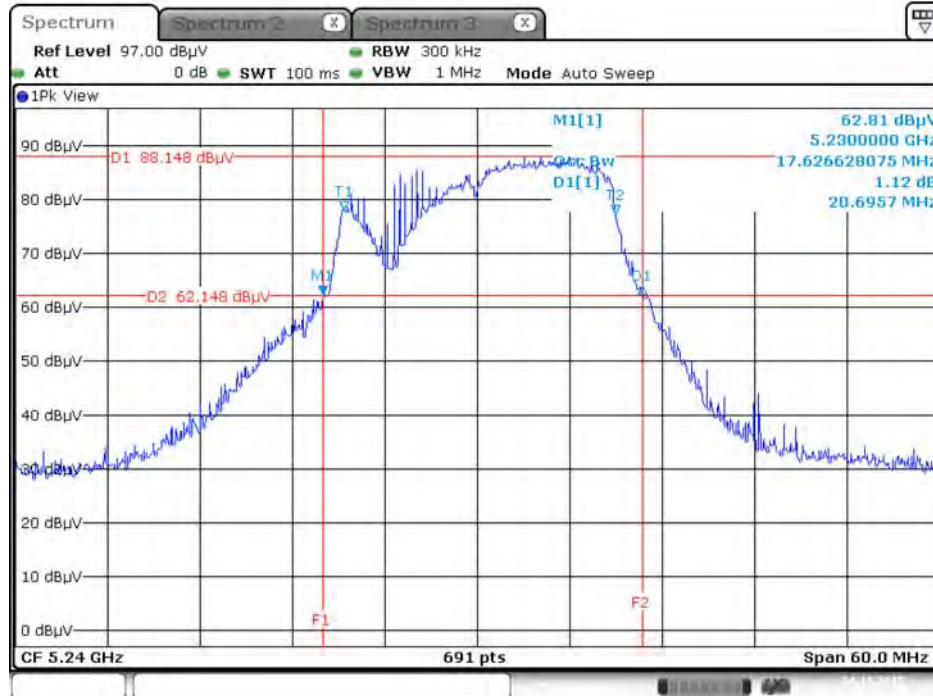

Date: 24.NOV.2015 02:13:56

26dB Bandwidth and 99% Occupied Bandwidth Plot on Configuration IEEE 802.11ac MCS0/Nss1 VHT20 / Chain 1 + Chain 2 / 5745 MHz

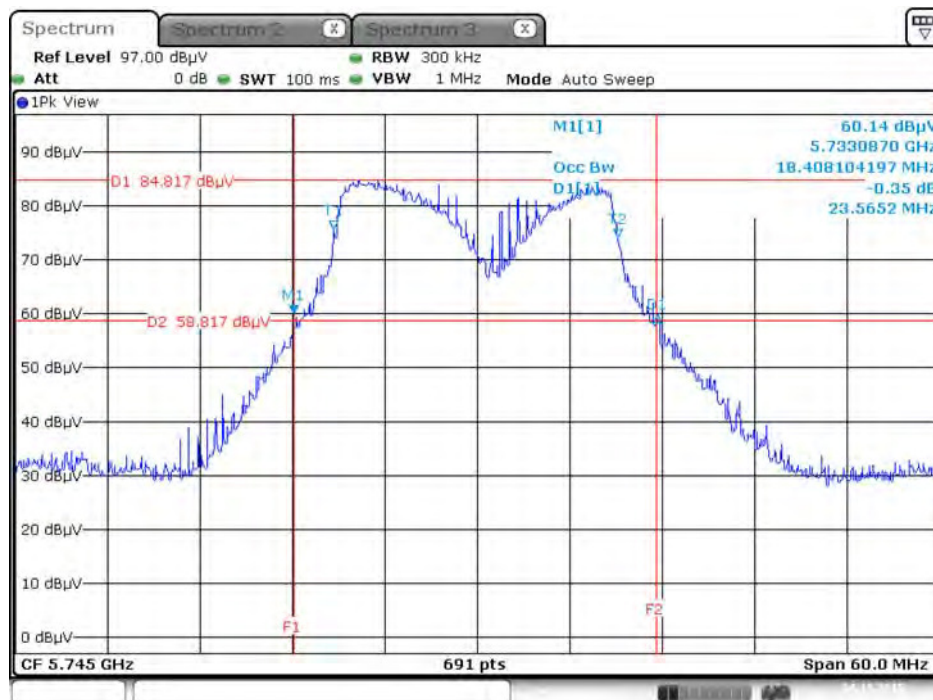

Date: 24.NOV.2015 02:14:25

26dB Bandwidth and 99% Occupied Bandwidth Plot on Configuration IEEE 802.11ac MCS0/Nss1 VHT20 / Chain 1 + Chain 2 / 5785 MHz

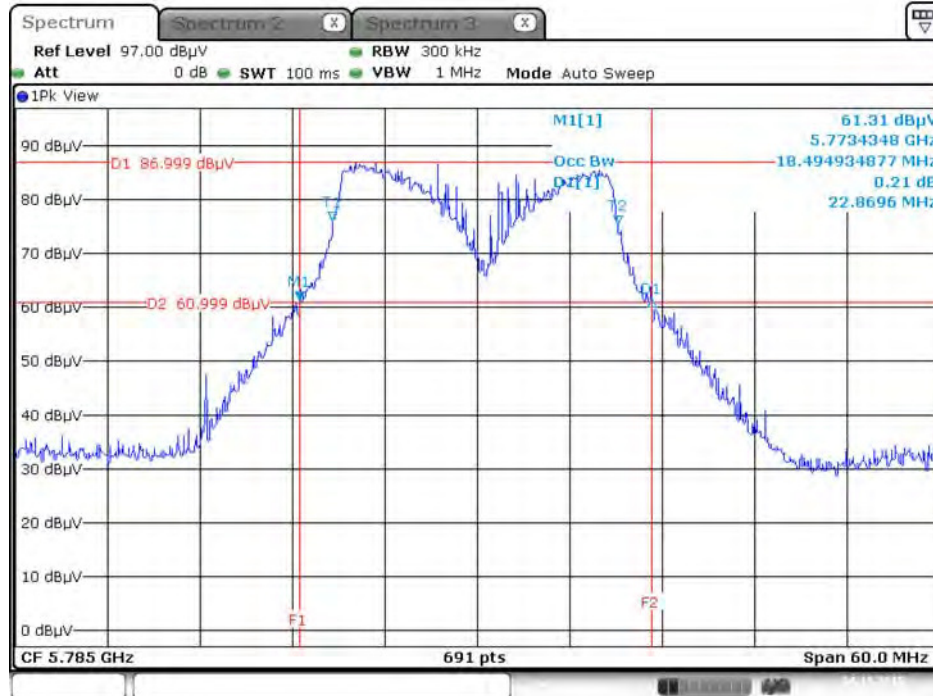

Date: 24.NOV.2015 02:14:50

26dB Bandwidth and 99% Occupied Bandwidth Plot on Configuration IEEE 802.11ac MCS0/Nss1 VHT20 / Chain 1 + Chain 2 / 5825 MHz

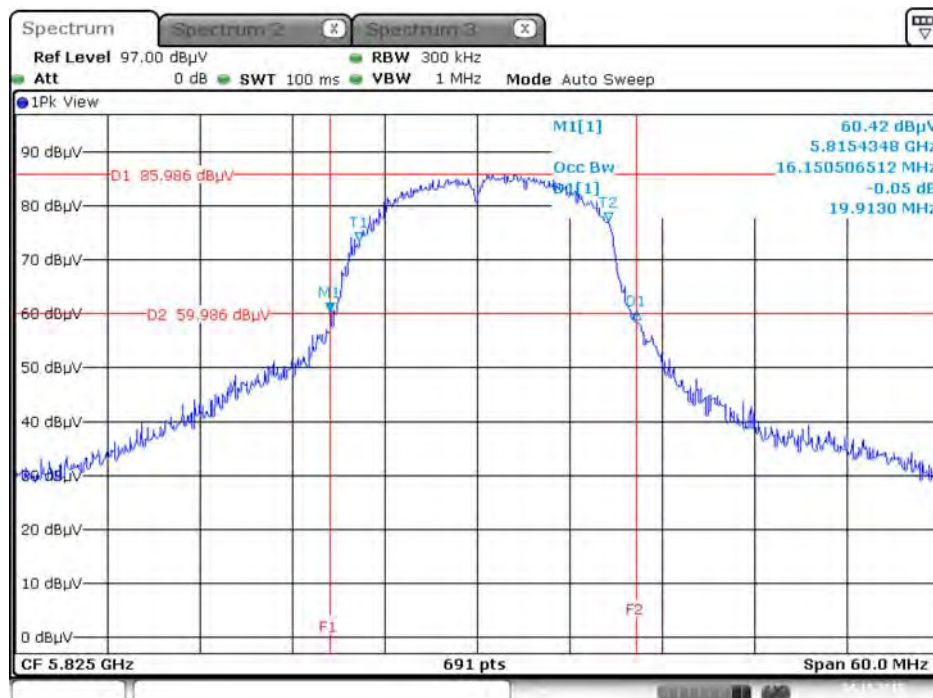

Date: 24.NOV.2015 02:15:15

26dB Bandwidth and 99% Occupied Bandwidth Plot on Configuration IEEE 802.11ac MCS0/Nss1 VHT40 / Chain 1 + Chain 2 / 5190 MHz

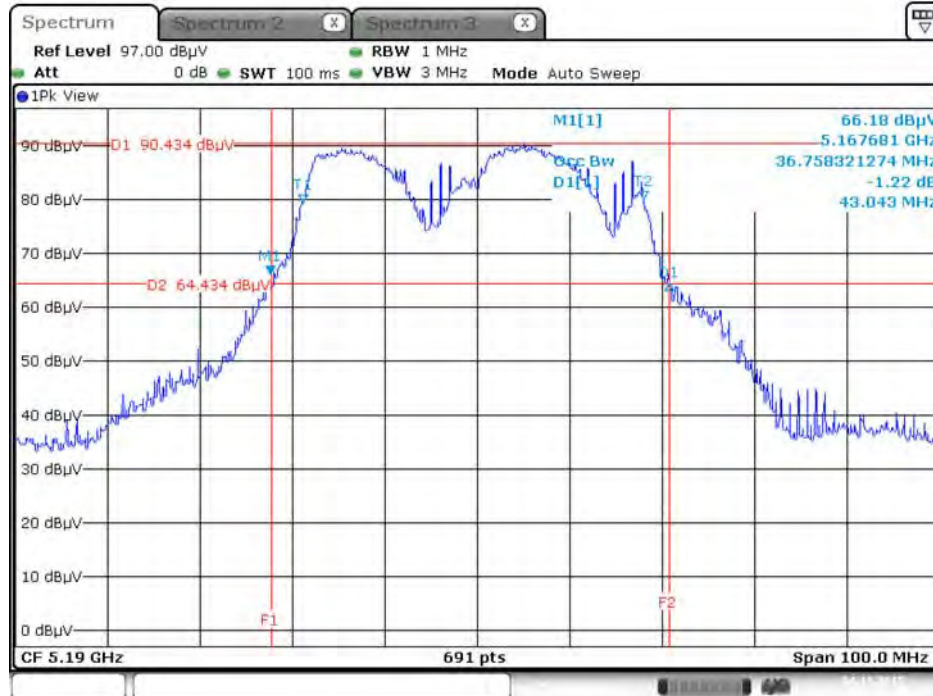

Date: 24.NOV.2015 02:16:05

26dB Bandwidth and 99% Occupied Bandwidth Plot on Configuration IEEE 802.11ac MCS0/Nss1 VHT40 / Chain 1 + Chain 2 / 5230 MHz

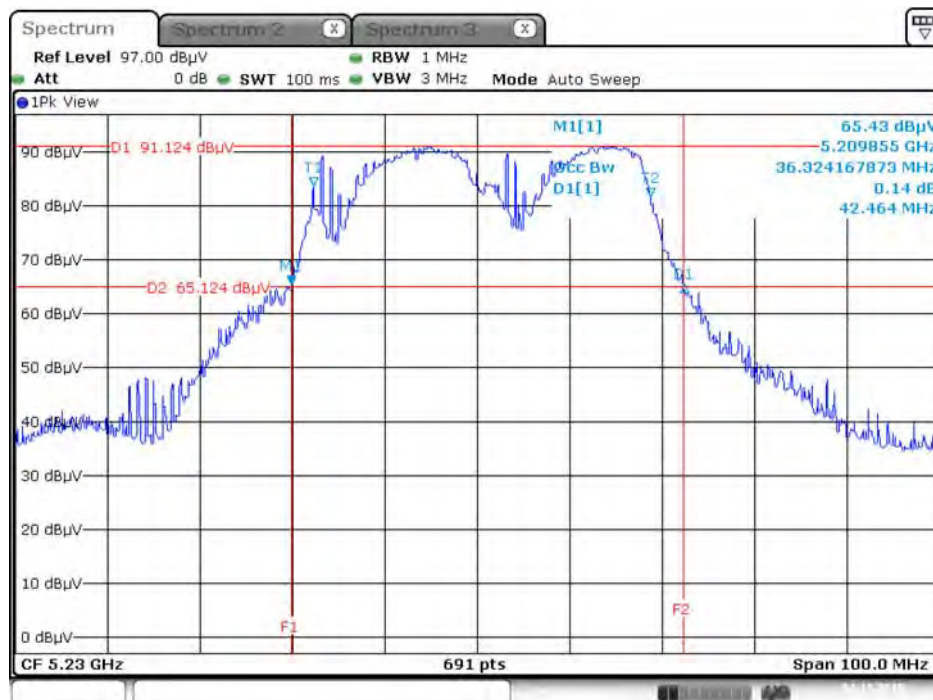

Date: 24.NOV.2015 02:16:43

26dB Bandwidth and 99% Occupied Bandwidth Plot on Configuration IEEE 802.11ac MCS0/Nss1 VHT40 / Chain 1 + Chain 2 / 5755 MHz

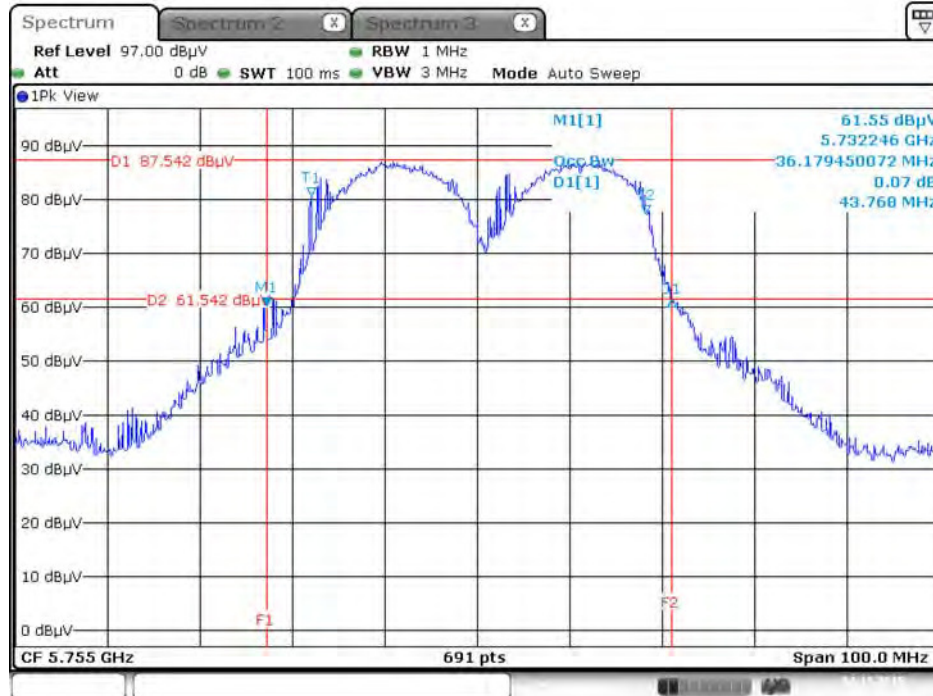

Date: 24.NOV.2015 02:17:34

26dB Bandwidth and 99% Occupied Bandwidth Plot on Configuration IEEE 802.11ac MCS0/Nss1 VHT40 / Chain 1 + Chain 2 / 5795 MHz

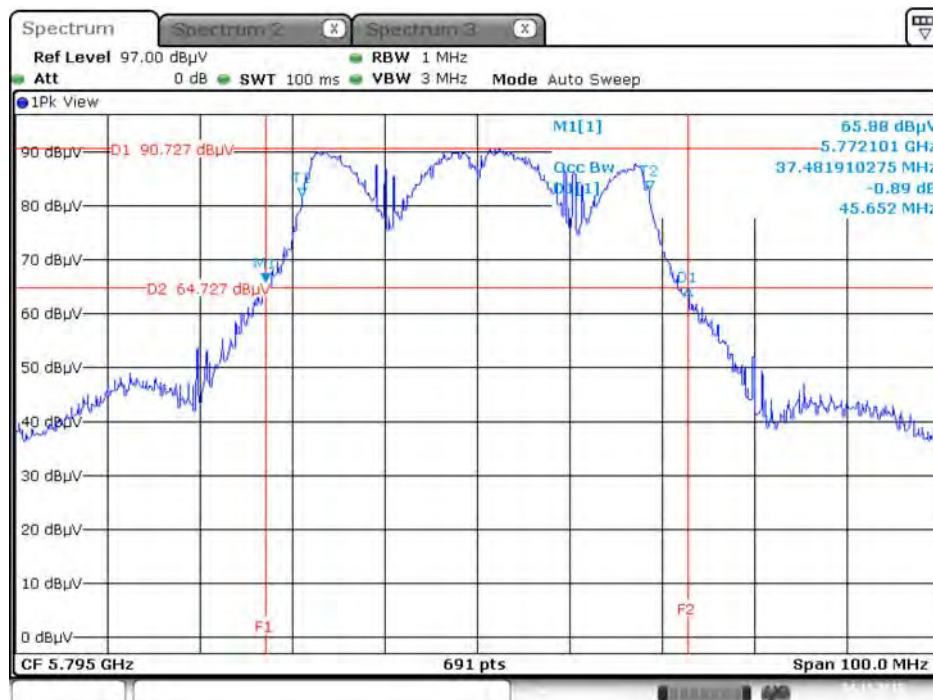

Date: 24.NOV.2015 02:18:11

26dB Bandwidth and 99% Occupied Bandwidth Plot on Configuration IEEE 802.11ac MCS0/Nss1 VHT80 / Chain 1 + Chain 2 / 5210 MHz

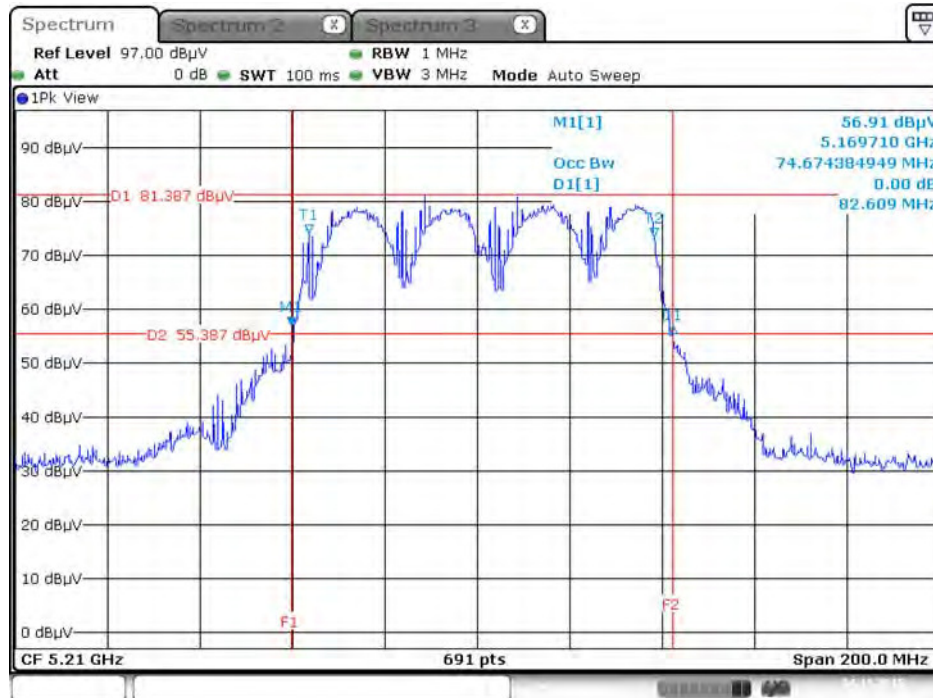

Date: 24.NOV.2015 02:19:19

26dB Bandwidth and 99% Occupied Bandwidth Plot on Configuration IEEE 802.11ac MCS0/Nss1 VHT80 / Chain 1 + Chain 2 / 5775 MHz

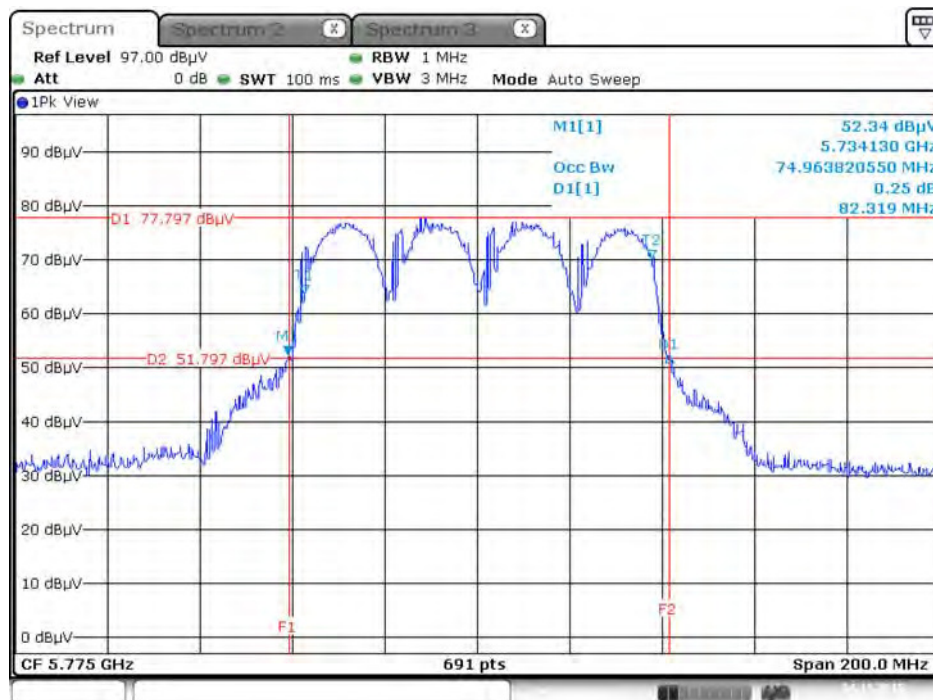

Date: 24.NOV.2015 02:20:07

4.3. 6dB Spectrum Bandwidth Measurement

4.3.1. Limit

For digital modulation systems, the minimum 6dB bandwidth shall be at least 500 kHz.

4.3.2. Measuring Instruments and Setting

Please refer to section 5 of equipments list in this report. The following table is the setting of spectrum analyzer.

6dB Spectrum Bandwidth	
Spectrum Parameters	Setting
Attenuation	Auto
Span Frequency	> 6dB Bandwidth
RBW	100kHz
VBW	$\geq 3 \times \text{RBW}$
Detector	Peak
Trace	Max Hold
Sweep Time	Auto

4.3.3. Test Procedures

For Radiated 6dB Bandwidth Measurement:

1. The transmitter was radiated to the spectrum analyzer in peak hold mode.
2. Test was performed in accordance with KDB789033 D02 v01r03 for Compliance Testing of Unlicensed National Information Infrastructure (U-NII) Devices - section (C) Emission Bandwidth.
3. Multiple antenna system was performed in accordance with KDB662911 D01 v02r01 Emissions Testing of Transmitters with Multiple Outputs in the Same Band.
4. Measured the spectrum width with power higher than 6dB below carrier.

4.3.4. Test Setup Layout

For Radiated 6dB Bandwidth Measurement:

This test setup layout is the same as that shown in section 4.6.4.

4.3.5. Test Deviation

There is no deviation with the original standard.

4.3.6. EUT Operation during Test

The EUT was programmed to be in continuously transmitting mode.

4.3.7. Test Result of 6dB Spectrum Bandwidth

Temperature	25°C	Humidity	45%
Test Engineer	Lucas Huang		

Mode	Frequency	6dB Bandwidth (MHz)	Min. Limit (kHz)	Test Result
802.11a	5745 MHz	16.35	500	Complies
	5785 MHz	12.29	500	Complies
	5825 MHz	13.10	500	Complies
802.11ac MCS0/Nss1 VHT20	5745 MHz	17.62	500	Complies
	5785 MHz	17.57	500	Complies
	5825 MHz	11.65	500	Complies
802.11ac MCS0/Nss1 VHT40	5755 MHz	33.74	500	Complies
	5795 MHz	35.13	500	Complies
802.11ac MCS0/Nss1 VHT80	5775 MHz	66.96	500	Complies

Note: All the test values were listed in the report.

For plots, only the channel with worse result was shown.

6 dB Bandwidth Plot on Configuration IEEE 802.11a / Chain 1 + Chain 2 / 5785 MHz

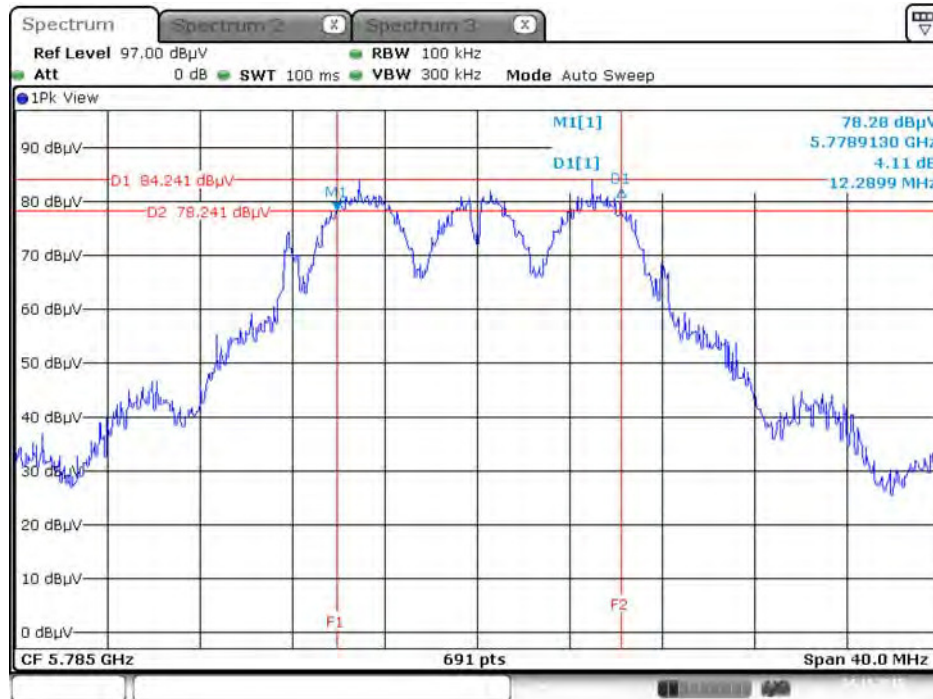

Date: 24.NOV.2015 02:25:41

6 dB Bandwidth Plot on Configuration IEEE 802.11ac MCS0/Ns1 VHT20 / Chain 1 + Chain 2 / 5825 MHz

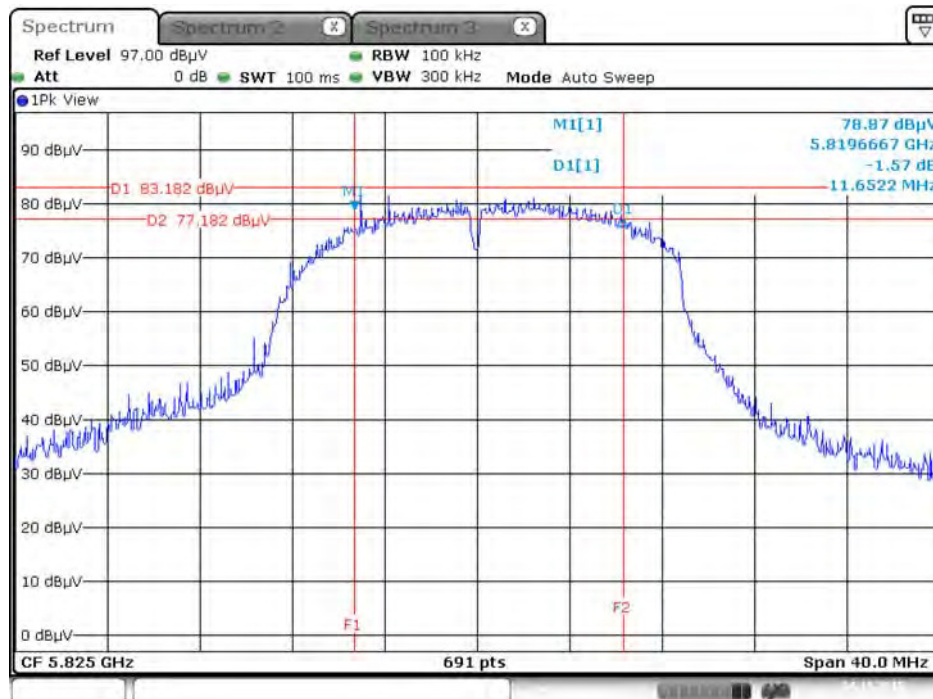

Date: 24.NOV.2015 02:24:51

6 dB Bandwidth Plot on Configuration IEEE 802.11ac MCS0/Nss1 VHT40 / Chain 1 + Chain 2 / 5755 MHz

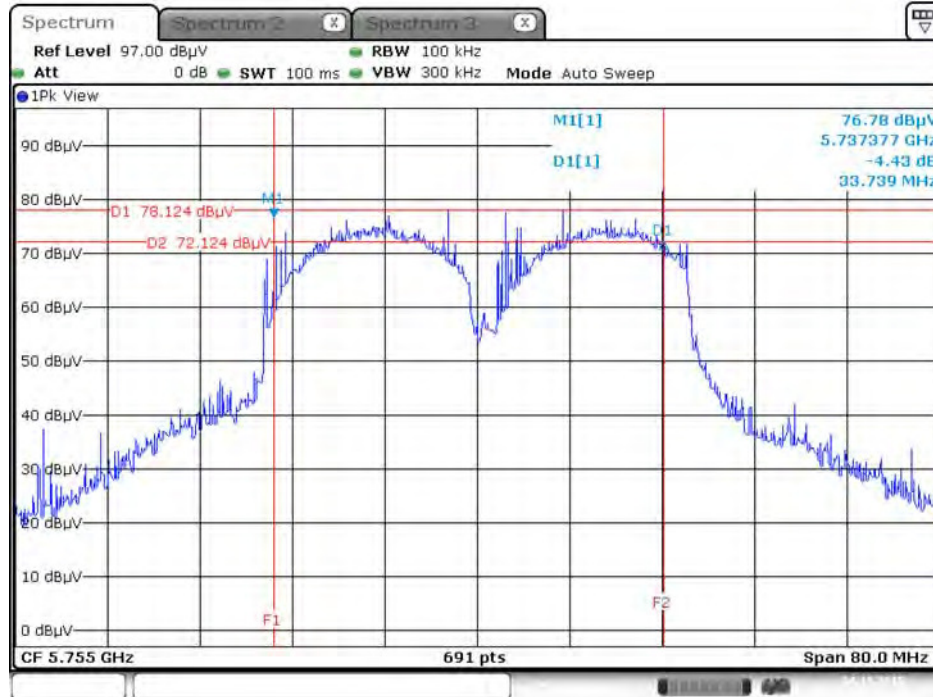

Date: 24.NOV.2015 02:21:53

6 dB Bandwidth Plot on Configuration IEEE 802.11ac MCS0/Nss1 VHT80 / Chain 1 + Chain 2 / 5775 MHz

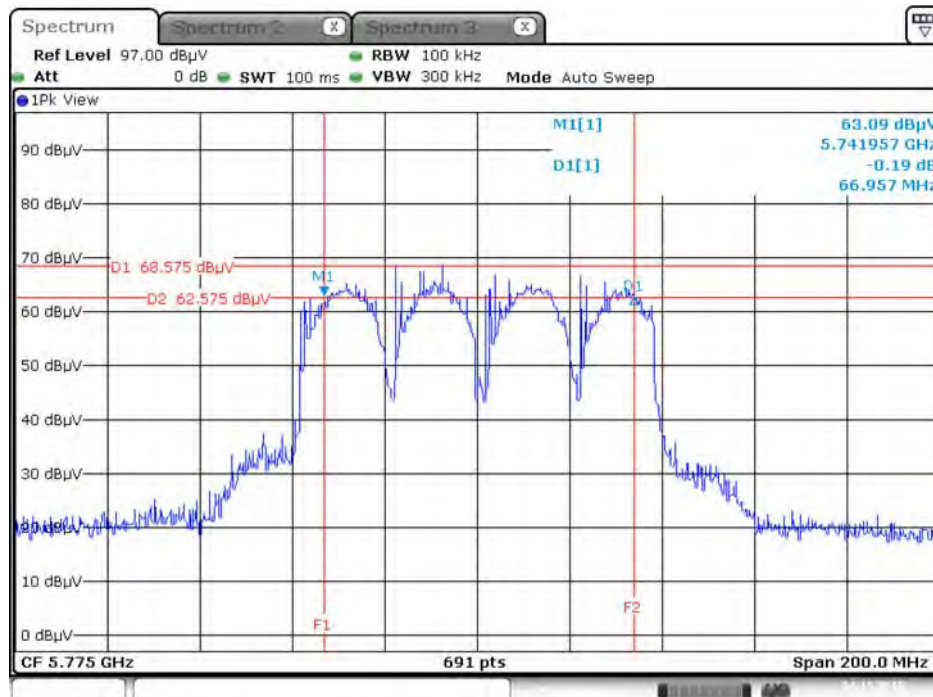

Date: 24.NOV.2015 02:20:51

4.4. Maximum Conducted Output Power Measurement

4.4.1. Limit

Frequency Band		Limit
<input checked="" type="checkbox"/>	5.15~5.25 GHz	
	Operating Mode	
<input type="checkbox"/>	Outdoor access point	The maximum conducted output power over the frequency band of operation shall not exceed 1 W (30dBm) provided the maximum antenna gain does not exceed 6 dBi. If transmitting antennas of directional gain greater than 6 dBi are used, both the maximum conducted output power and the maximum power spectral density shall be reduced by the amount in dB that the directional gain of the antenna exceeds 6 dBi. The maximum e.i.r.p. at any elevation angle above 30 degrees as measured from the horizon must not exceed 125 mW (21 dBm).
<input checked="" type="checkbox"/>	Indoor access point	The maximum conducted output power over the frequency band of operation shall not exceed 1 W (30dBm) provided the maximum antenna gain does not exceed 6 dBi. If transmitting antennas of directional gain greater than 6 dBi are used, both the maximum conducted output power and the maximum power spectral density shall be reduced by the amount in dB that the directional gain of the antenna exceeds 6 dBi.
<input type="checkbox"/>	Fixed point-to-point access points	The maximum conducted output power over the frequency band of operation shall not exceed 1 W (30dBm). Fixed point-to-point U-NII devices may employ antennas with directional gain up to 23 dBi without any corresponding reduction in the maximum conducted output power or maximum power spectral density. For fixed point-to-point transmitters that employ a directional antenna gain greater than 23 dBi, a 1 dB reduction in maximum conducted output power and maximum power spectral density is required for each 1 dB of antenna gain in excess of 23 dBi.
<input type="checkbox"/>	Mobile and portable client devices	The maximum conducted output power over the frequency band of operation shall not exceed 250 mW (24dBm) provided the maximum antenna gain does not exceed 6 dBi. If transmitting antennas of directional gain greater than 6 dBi are used, both the maximum conducted output power and the maximum power spectral density shall be reduced by the amount in dB that the directional gain of the antenna exceeds 6 dBi.

☒	5.725~5.85 GHz	The maximum conducted output power over the frequency band of operation shall not exceed 1 W (30dBm). If transmitting antennas of directional gain greater than 6 dBi are used, both the maximum conducted output power and the maximum power spectral density shall be reduced by the amount in dB that the directional gain of the antenna exceeds 6 dBi. However, fixed point-to-point U-NII devices operating in this band may employ transmitting antennas with directional gain greater than 6 dBi without any corresponding reduction in transmitter conducted power.
---	----------------	--

4.4.2. Measuring Instruments and Setting

Please refer to section 5 of equipments list in this report. The following table is the setting of the power meter.

Power Meter Parameter	Setting
Detector	AVERAGE

4.4.3. Test Procedures

1. The transmitter output (antenna port) was connected to the power meter.
2. Test was performed in accordance with KDB789033 D02 v01r03 for Compliance Testing of Unlicensed National Information Infrastructure (U-NII) Devices - section (E) Maximum conducted output power =>3. Measurement using a Power Meter (PM) =>b) Method PM-G (Measurement using a gated RF average power meter).
3. Multiple antenna systems was performed in accordance with KDB662911 D01 v02r01 Emissions Testing of Transmitters with Multiple Outputs in the Same Band.
4. When measuring maximum conducted output power with multiple antenna systems, add every result of the values by mathematic formula.

4.4.4. Test Setup Layout

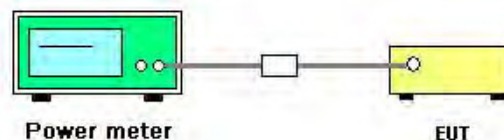

4.4.5. Test Deviation

There is no deviation with the original standard.

4.4.6. EUT Operation during Test

The EUT was programmed to be in continuously transmitting mode.

4.4.7. Test Result of Maximum Conducted Output Power

Temperature	25°C	Humidity	45%
Test Engineer	Lucas Huang	Test Date	Nov. 24, 2015

Mode	Frequency	Conducted Power (dBm)			Max. Limit (dBm)	Result
		Chain 1	Chain 2	Total		
802.11a	5180 MHz	20.22	20.85	23.56	27.00	Complies
	5200 MHz	20.55	21.31	23.96	27.00	Complies
	5240 MHz	20.21	21.25	23.77	27.00	Complies
	5745 MHz	19.05	19.59	22.34	27.00	Complies
	5785 MHz	20.71	21.18	23.96	27.00	Complies
	5825 MHz	20.51	21.09	23.82	27.00	Complies
802.11ac MCS0/Nss1 VHT20	5180 MHz	20.23	20.89	23.58	27.00	Complies
	5200 MHz	20.42	21.26	23.87	27.00	Complies
	5240 MHz	20.08	21.32	23.75	27.00	Complies
	5745 MHz	19.11	19.52	22.33	27.00	Complies
	5785 MHz	20.61	21.22	23.94	27.00	Complies
	5825 MHz	20.08	20.01	23.06	27.00	Complies
802.11ac MCS0/Nss1 VHT40	5190 MHz	19.61	20.77	23.24	27.00	Complies
	5230 MHz	21.16	22.15	24.69	27.00	Complies
	5755 MHz	17.38	17.64	20.52	27.00	Complies
	5795 MHz	21.81	21.42	24.63	27.00	Complies
802.11ac MCS0/Nss1 VHT80	5210 MHz	12.49	12.66	15.59	27.00	Complies
	5775 MHz	10.17	10.71	13.46	27.00	Complies

Note: Antenna gain=9.00dBi > 6dBi, so power limit= 30 – (9.00 – 6)=27.00dBm.

4.5. Power Spectral Density Measurement

4.5.1. Limit

The following table is power spectral density limits and decrease power density limit rule refer to section 4.4.1.

Frequency Band		Limit
<input checked="" type="checkbox"/>	5.15~5.25 GHz	
	Operating Mode	
<input type="checkbox"/>	Outdoor access point	17 dBm/MHz
<input checked="" type="checkbox"/>	Indoor access point	17 dBm/MHz
<input type="checkbox"/>	Fixed point-to-point access points	17 dBm/MHz
<input type="checkbox"/>	Mobile and portable client devices	11 dBm/MHz
<input checked="" type="checkbox"/>	5.725~5.85 GHz	30 dBm/500kHz

4.5.2. Measuring Instruments and Setting

Please refer to section 5 of equipments list in this report. The following table is the setting of the spectrum analyzer.

Spectrum Parameter	Setting
Attenuation	Auto
Span Frequency	Encompass the entire emissions bandwidth (EBW) of the signal
RBW	1000 kHz
VBW	3000 kHz
Detector	RMS
Trace	AVERAGE
Sweep Time	Auto
Trace Average	100 times
Note: If measurement bandwidth of Maximum PSD is specified in 500 kHz, add $10\log(500\text{kHz}/\text{RBW})$ to the measured result, whereas RBW (< 500 kHz) is the reduced resolution bandwidth of the spectrum analyzer set during measurement.	

4.5.3. Test Procedures

1. The transmitter output (antenna port) was connected RF switch to the spectrum analyzer.
2. Test was performed in accordance with KDB789033 D02 v01r03 for Compliance Testing of Unlicensed National Information Infrastructure (U-NII) Devices - section (F) Maximum Power Spectral Density (PSD).
3. Multiple antenna systems was performed in accordance KDB662911 D01 v02r01 in-Band Power Spectral Density (PSD) Measurements (a) Measure and sum the spectra across the outputs.
4. When measuring first spectral bin of output 1 is summed with that in the first spectral bin of output 2 and that from the first spectral bin of output 3 and so on up to the Nth output to obtain the value for the first frequency bin of the summed spectrum. The summed spectrum value for each of the other frequency bins is computed in the same way.
5. For 5.725~5.85 GHz, the measured result of PSD level must add $10\log(500\text{kHz}/\text{RBW})$ and the final result should ≤ 30 dBm.

4.5.4. Test Setup Layout

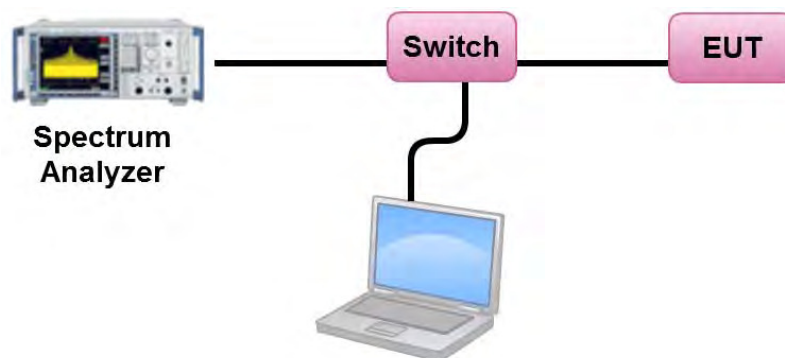

4.5.5. Test Deviation

There is no deviation with the original standard.

4.5.6. EUT Operation during Test

The EUT was programmed to be in continuously transmitting mode.

4.5.7. Test Result of Power Spectral Density

Temperature	25°C	Humidity	45%
Test Engineer	Lucas Huang	Test Date	Nov. 24, 2015

Configuration IEEE 802.11a / Chain 1 + Chain 2

Channel	Frequency	Power Density (dBm/MHz)	Max. Limit (dBm/MHz)	Result
36	5180 MHz	10.95	10.99	Complies
40	5200 MHz	10.70	10.99	Complies
48	5240 MHz	10.82	10.99	Complies

Note: $Directional\ Gain = 10 \log \left[\frac{\sum_{j=1}^{N_{SS}} \left(\sum_{K=1}^{N_{ANT}} g_{j,k} \right)^2}{N_{ANT}} \right] = 12.01\text{ dBi} > 6\text{ dBi}$, so limit = $17 - (12.01 - 6) = 10.99\text{ dBm/MHz}$.

Channel	Frequency	Power Density (dBm/MHz)	10log(500kHz/RBW) Factor (dB)	Power Density (dBm/500kHz)	Power Density Limit (dBm/500kHz)	Result
149	5745 MHz	9.56	-3.01	6.55	23.99	Complies
157	5785 MHz	10.82	-3.01	7.81	23.99	Complies
165	5825 MHz	11.04	-3.01	8.03	23.99	Complies

Note: $Directional\ Gain = 10 \log \left[\frac{\sum_{j=1}^{N_{SS}} \left(\sum_{K=1}^{N_{ANT}} g_{j,k} \right)^2}{N_{ANT}} \right] = 12.01\text{ dBi} > 6\text{ dBi}$, so limit = $30 - (12.01 - 6) = 23.99\text{ dBm/500kHz}$.

Configuration IEEE 802.11ac MCS0/Nss1 VHT20 / Chain 1 + Chain 2

Channel	Frequency	Power Density (dBm/MHz)	Max. Limit (dBm/MHz)	Result
36	5180 MHz	10.80	10.99	Complies
40	5200 MHz	10.82	10.99	Complies
48	5240 MHz	10.98	10.99	Complies

Note: $Directional\ Gain = 10 \log \left[\frac{\sum_{j=1}^{N_{SS}} \left\{ \sum_{K=1}^{N_{ANT}} g_{j,k} \right\}^2}{N_{ANT}} \right] = 12.01\text{ dBi} > 6\text{ dBi}$, so limit = $17 - (12.01 - 6) = 10.99\text{ dBm/MHz}$.

Channel	Frequency	Power Density (dBm/MHz)	10log(500kHz/RBW) Factor (dB)	Power Density (dBm/500kHz)	Power Density Limit (dBm/500kHz)	Result
149	5745 MHz	9.35	-3.01	6.34	23.99	Complies
157	5785 MHz	11.00	-3.01	7.99	23.99	Complies
165	5825 MHz	10.16	-3.01	7.15	23.99	Complies

Note: $Directional\ Gain = 10 \log \left[\frac{\sum_{j=1}^{N_{SS}} \left\{ \sum_{K=1}^{N_{ANT}} g_{j,k} \right\}^2}{N_{ANT}} \right] = 12.01\text{ dBi} > 6\text{ dBi}$, so limit = $30 - (12.01 - 6) = 23.99\text{ dBm/500kHz}$.

Configuration IEEE 802.11ac MCS0/Nss1 VHT40 / Chain 1 + Chain 2

Channel	Frequency	Power Density (dBm/MHz)	Max. Limit (dBm/MHz)	Result
38	5190 MHz	7.07	10.99	Complies
46	5230 MHz	8.48	10.99	Complies

Note: $Directional\ Gain = 10 \log \left[\frac{\sum_{j=1}^{N_{SS}} \left\{ \sum_{K=1}^{N_{ANT}} g_{j,k} \right\}^2}{N_{ANT}} \right] = 12.01\text{ dBi} > 6\text{ dBi}$, so limit = $17 - (12.01 - 6) = 10.99\text{ dBm/MHz}$.

Channel	Frequency	Power Density (dBm/MHz)	10log(500kHz/RBW) Factor (dB)	Power Density (dBm/500kHz)	Power Density Limit (dBm/500kHz)	Result
151	5755 MHz	4.64	-3.01	1.63	23.99	Complies
159	5795 MHz	8.83	-3.01	5.82	23.99	Complies

Note: $Directional\ Gain = 10 \log \left[\frac{\sum_{j=1}^{N_{SS}} \left\{ \sum_{K=1}^{N_{ANT}} g_{j,k} \right\}^2}{N_{ANT}} \right] = 12.01\text{ dBi} > 6\text{ dBi}$, so limit = $30 - (12.01 - 6) = 23.99\text{ dBm/500kHz}$.

Configuration IEEE 802.11ac MCS0/Nss1 VHT80 / Chain 1 + Chain 2

Channel	Frequency	Power Density (dBm/MHz)	Max. Limit (dBm/MHz)	Result
42	5210 MHz	-3.60	10.99	Complies

Note: $Directional\ Gain = 10 \log \left[\frac{\sum_{j=1}^{N_{SS}} \left\{ \sum_{K=1}^{N_{ANT}} g_{j,k} \right\}^2}{N_{ANT}} \right] = 12.01\text{ dBi} > 6\text{ dBi}$, so limit = $17 - (12.01 - 6) = 10.99\text{ dBm/MHz}$.

Channel	Frequency	Power Density (dBm/MHz)	10log(500kHz/RBW) Factor (dB)	Power Density (dBm/500kHz)	Power Density Limit (dBm/500kHz)	Result
155	5775 MHz	-5.48	-3.01	-8.49	23.99	Complies

Note: $Directional\ Gain = 10 \log \left[\frac{\sum_{j=1}^{N_{SS}} \left\{ \sum_{K=1}^{N_{ANT}} g_{j,k} \right\}^2}{N_{ANT}} \right] = 12.01\text{ dBi} > 6\text{ dBi}$, so limit = $30 - (12.01 - 6) = 23.99\text{ dBm/500kHz}$.

Note: All the test values were listed in the report.

For plots, only the channel with worse result was shown.

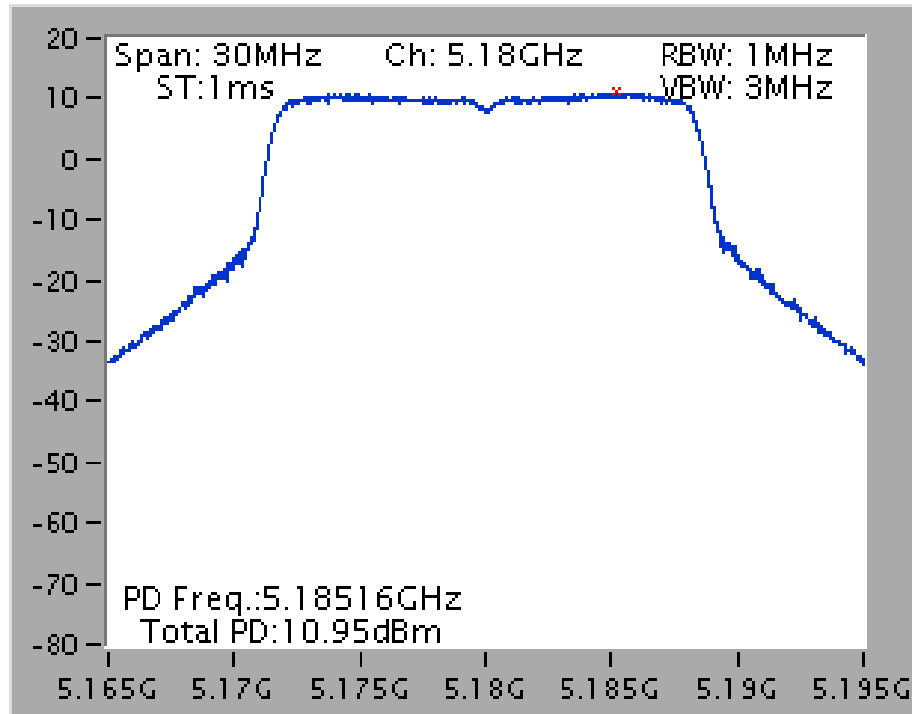
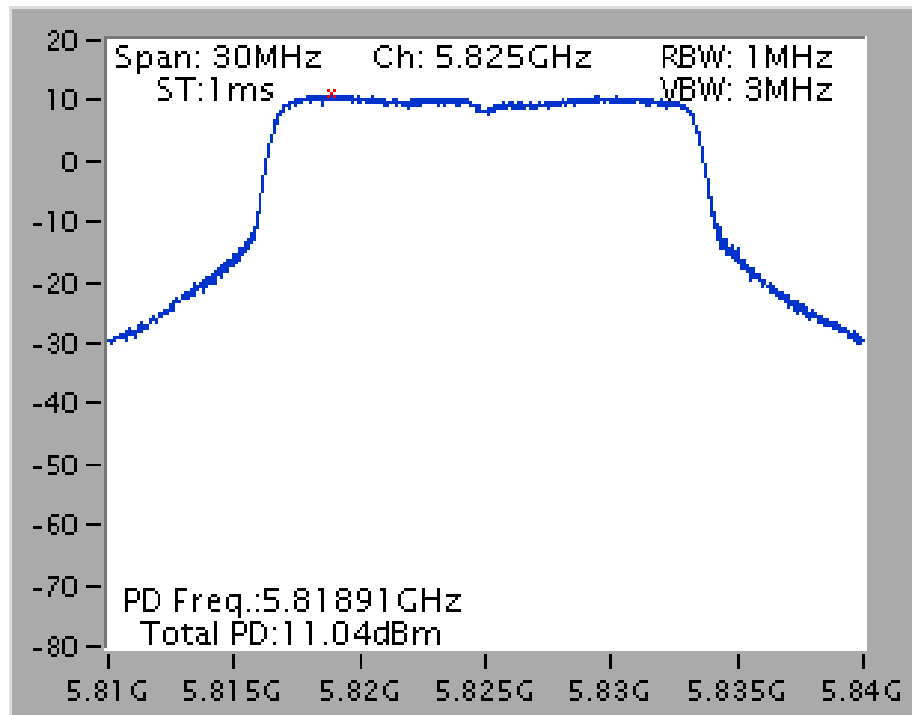
Power Density Plot on Configuration IEEE 802.11a / Chain 1 + Chain 2 / 5180 MHz**Power Density Plot on Configuration IEEE 802.11a / Chain 1 + Chain 2 / 5825 MHz**

Power Density Plot on Configuration IEEE 802.11ac MCS0/Nss1 VHT20 / Chain 1 + Chain 2 / 5240 MHz

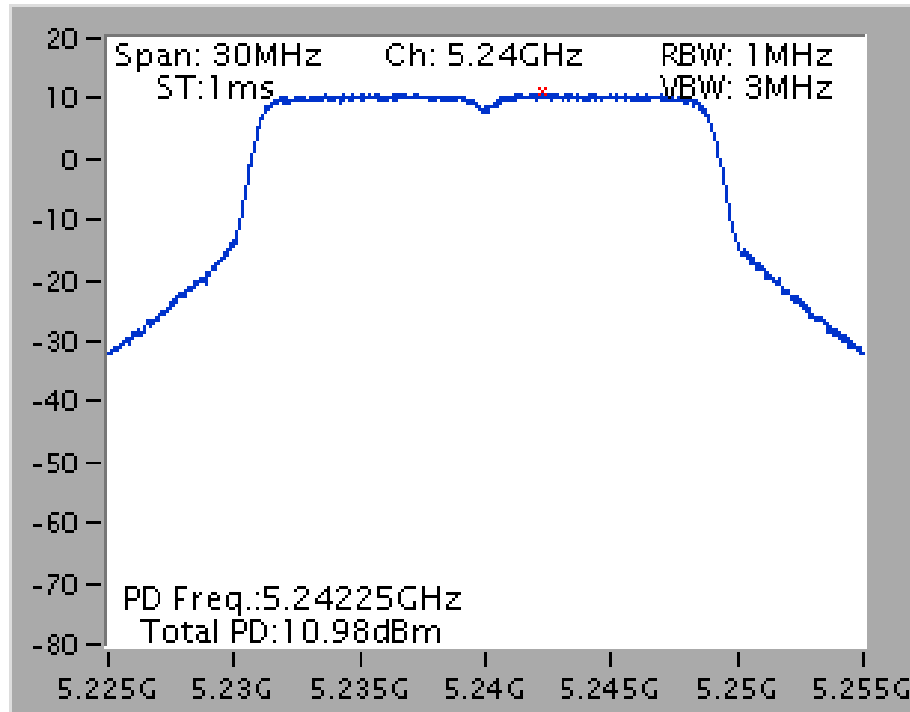

Power Density Plot on Configuration IEEE 802.11ac MCS0/Nss1 VHT20 / Chain 1 + Chain 2 / 5785 MHz

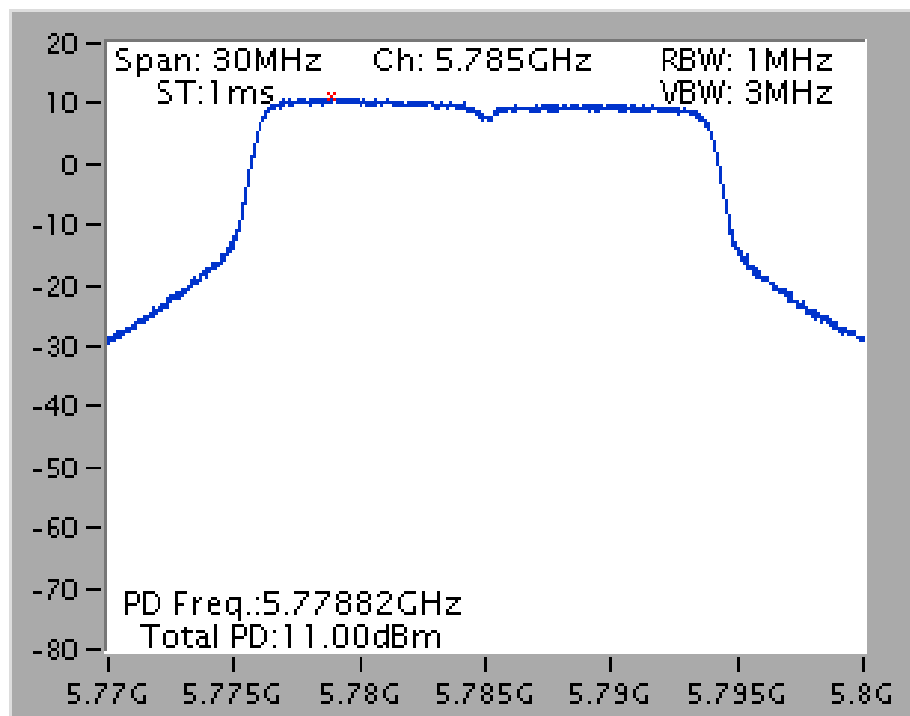

Power Density Plot on Configuration IEEE 802.11ac MCS0/Nss1 VHT40 / Chain 1 + Chain 2 / 5230 MHz

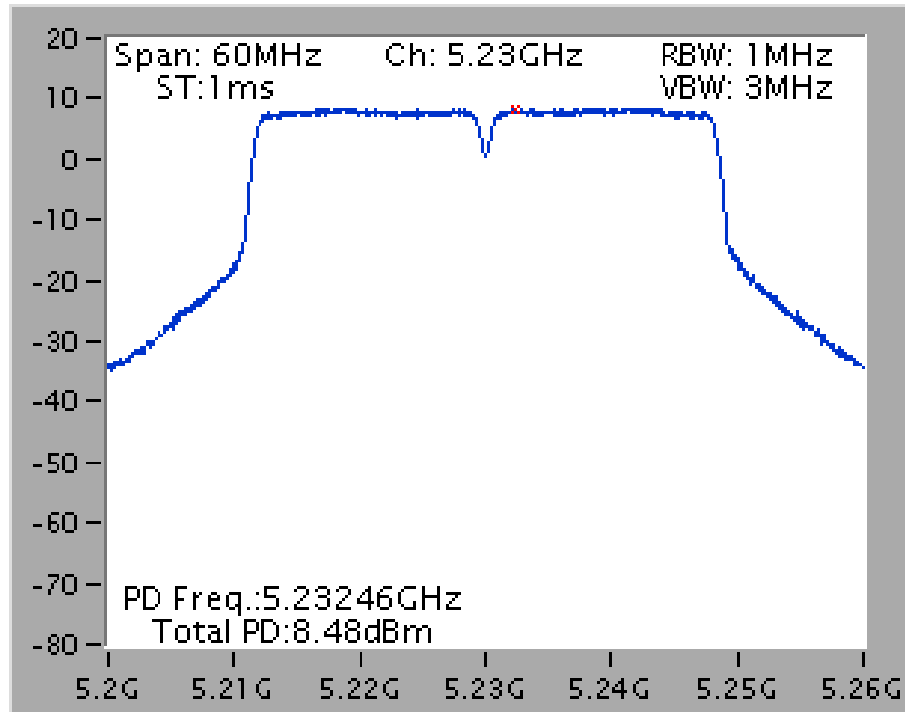

Power Density Plot on Configuration IEEE 802.11ac MCS0/Nss1 VHT40 / Chain 1 + Chain 2 / 5795 MHz

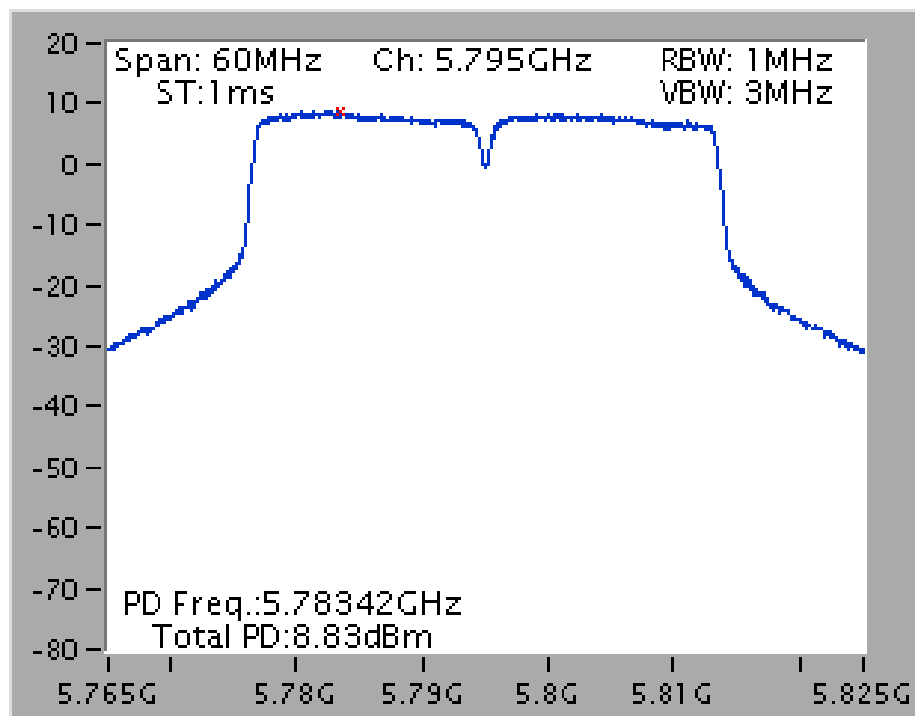

Power Density Plot on Configuration IEEE 802.11ac MCS0/Nss1 VHT80 / Chain 1 + Chain 2 / 5210 MHz

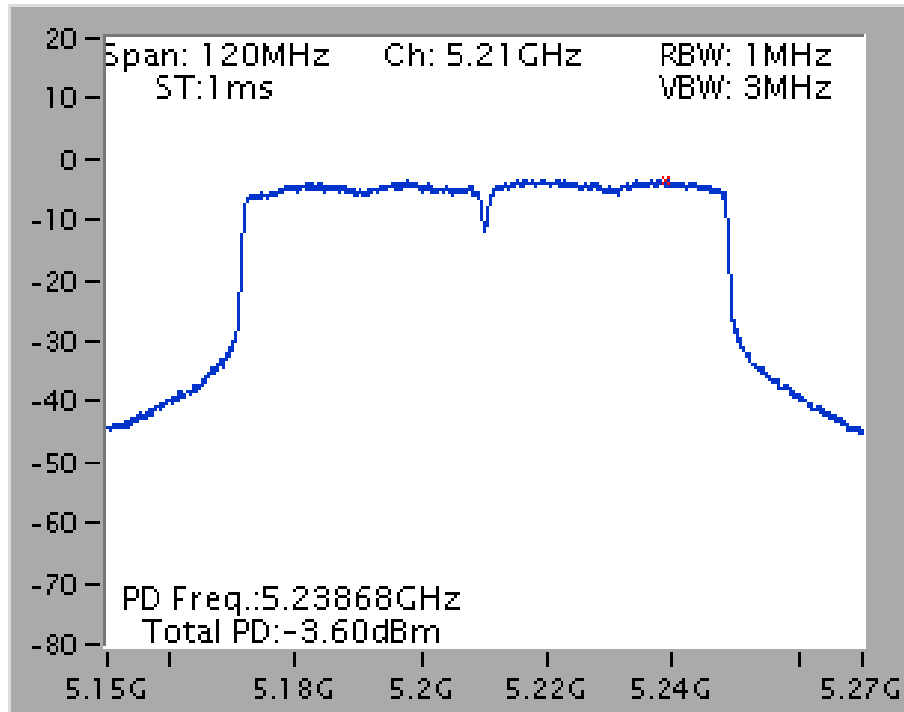

Power Density Plot on Configuration IEEE 802.11ac MCS0/Nss1 VHT80 / Chain 1 + Chain 2 / 5775 MHz

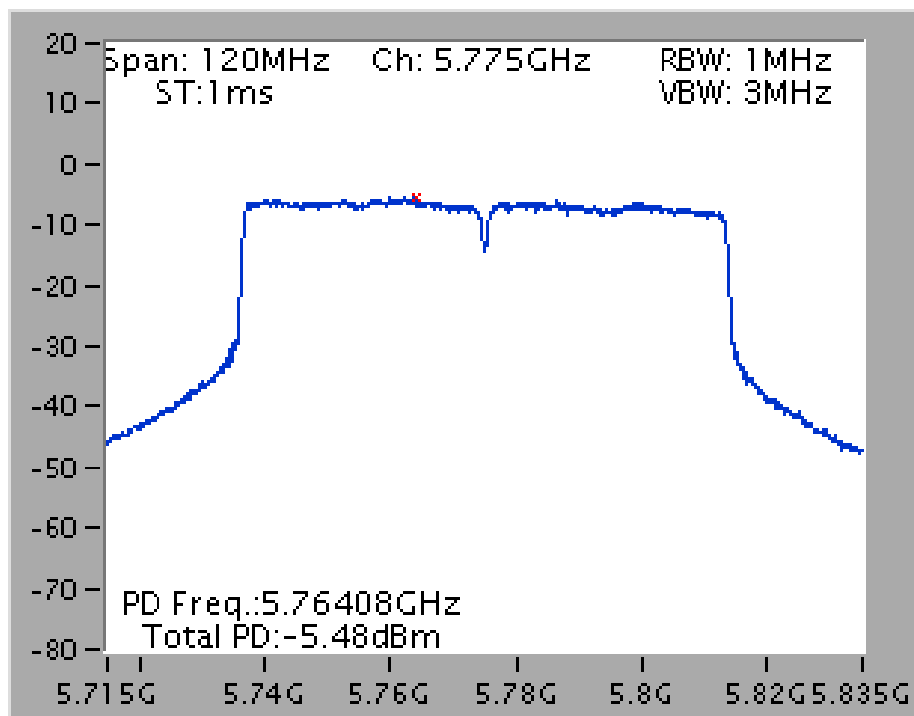

4.6. Radiated Emissions Measurement

4.6.1. Limit

For transmitters operating in the 5.15-5.25 GHz band: all emissions outside of the 5.15-5.35 GHz band shall not exceed an e.i.r.p. of -27 dBm/MHz.

For transmitters operating in the 5.725-5.85 GHz band: all emissions within the frequency range from the band edge to 10 MHz above or below the band edge shall not exceed an e.i.r.p. of -17 dBm/MHz; for frequencies 10 MHz or greater above or below the band edge, emissions shall not exceed an e.i.r.p. of -27 dBm/MHz.

In addition, In case the emission fall within the restricted band specified on 15.205(a), then the 15.209(a) limit in the table below has to be followed.

Frequencies (MHz)	Field Strength (micorvolts/meter)	Measurement Distance (meters)
0.009~0.490	2400/F(kHz)	300
0.490~1.705	24000/F(kHz)	30
1.705~30.0	30	30
30~88	100	3
88~216	150	3
216~960	200	3
Above 960	500	3

4.6.2. Measuring Instruments and Setting

Please refer to section 5 of equipments list in this report. The following table is the setting of spectrum analyzer and receiver.

Spectrum Parameter	Setting
Attenuation	Auto
Start Frequency	1000 MHz
Stop Frequency	40 GHz
RBW / VBW (Emission in restricted band)	1 MHz / 3MHz for Peak, 1 MHz / 1/T for Average
RBW / VBW (Emission in non-restricted band)	1 MHz / 3MHz for peak

Receiver Parameter	Setting
Attenuation	Auto
Start ~ Stop Frequency	9kHz~150kHz / RBW 200Hz for QP
Start ~ Stop Frequency	150kHz~30MHz / RBW 9kHz for QP
Start ~ Stop Frequency	30MHz~1000MHz / RBW 120kHz for QP

4.6.3. Test Procedures

1. Configure the EUT according to ANSI C63.10. The EUT was placed on the top of the turntable 1.5 meter above ground. The phase center of the receiving antenna mounted on the top of a height-variable antenna tower was placed 1m & 3m far away from the turntable.
2. Power on the EUT and all the supporting units. The turntable was rotated by 360 degrees to determine the position of the highest radiation.
3. The height of the broadband receiving antenna was varied between one meter and four meters above ground to find the maximum emissions field strength of both horizontal and vertical polarization.
4. For each suspected emissions, the antenna tower was scan (from 1 M to 4 M) and then the turntable was rotated (from 0 degree to 360 degrees) to find the maximum reading.
5. Set the test-receiver system to Peak or CISPR quasi-peak Detect Function with specified bandwidth under Maximum Hold Mode.
6. For emissions above 1GHz, use 1MHz VBW and 3MHz RBW for peak reading. Then 1MHz RBW and 1/T VBW for average reading in spectrum analyzer.
7. If the emissions level of the EUT in peak mode was 3 dB lower than the average limit specified, then testing will be stopped and peak values of EUT will be reported, otherwise, the emissions which do not have 3 dB margin will be repeated one by one using the quasi-peak method for below 1GHz.
8. For testing above 1GHz, the emissions level of the EUT in peak mode was lower than average limit (that means the emissions level in peak mode also complies with the limit in average mode), then testing will be stopped and peak values of EUT will be reported, otherwise, the emissions will be measured in average mode again and reported.
9. In case the emission is lower than 30MHz, loop antenna has to be used for measurement and the recorded data should be QP measured by receiver. High – Low scan is not required in this case.

4.6.4. Test Setup Layout

For Radiated Emissions: 9kHz ~30MHz

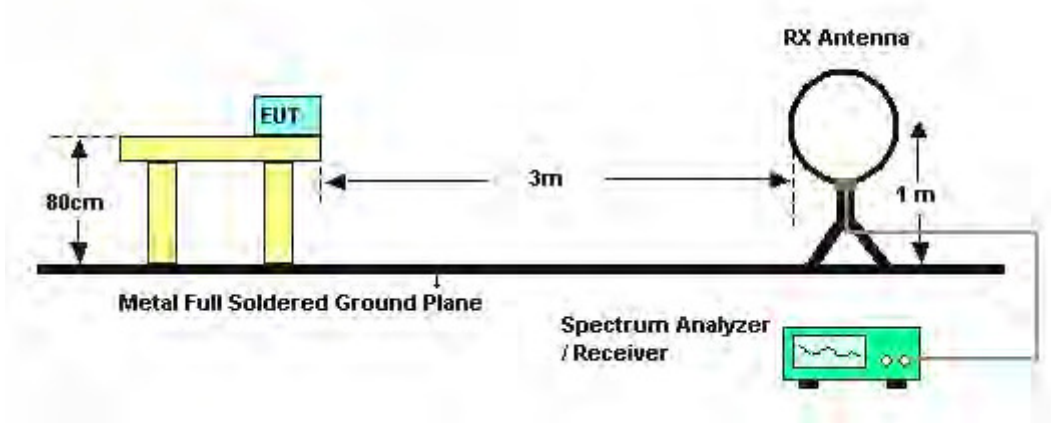

For Radiated Emissions: 30MHz~1GHz

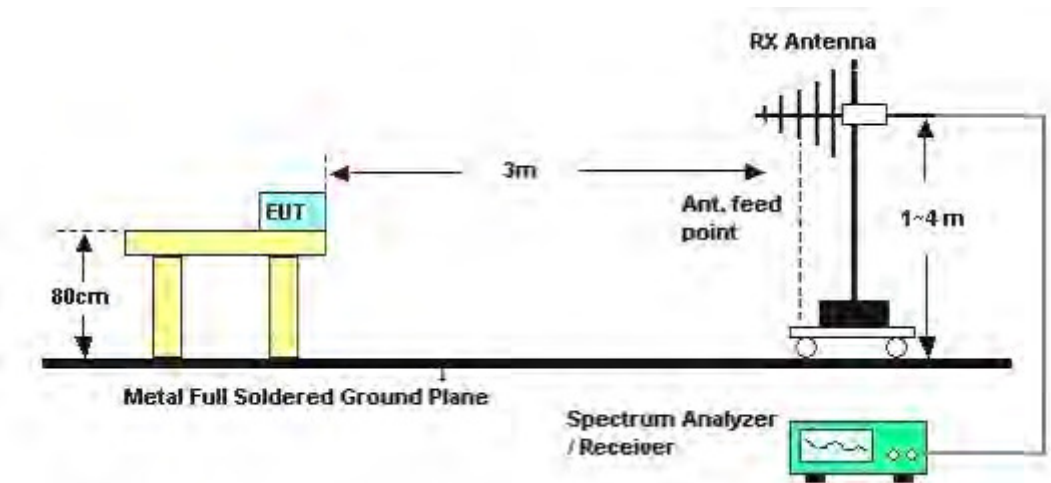

For Radiated Emissions: Above 1GHz

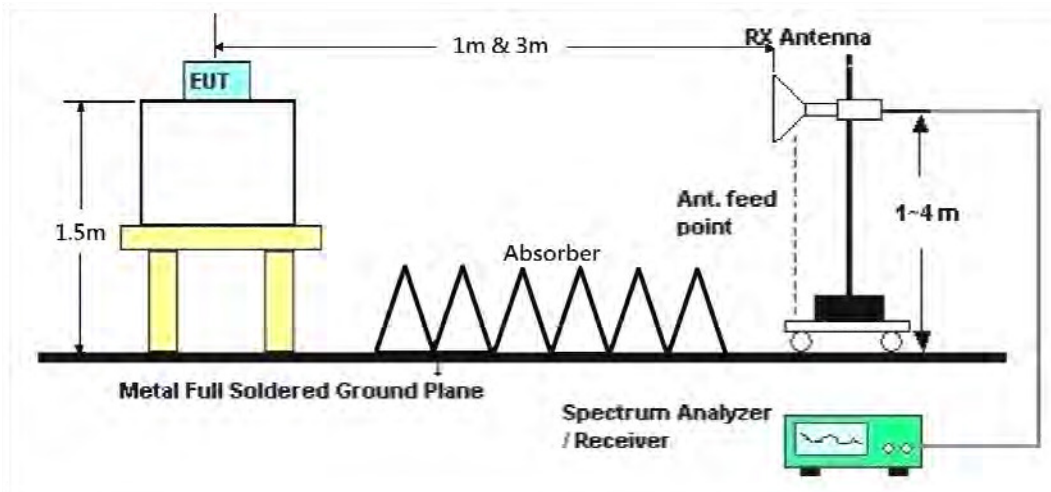

4.6.5. Test Deviation

There is no deviation with the original standard.

4.6.6. EUT Operation during Test

The EUT was programmed to be in continuously transmitting mode.

4.6.7. Results of Radiated Emissions (9kHz~30MHz)

Temperature	20.9°C	Humidity	65%
Test Engineer	Ron Huang	Configurations	Normal Link
Test Date	Jan. 06, 2017		

Freq. (MHz)	Level (dBuV)	Over Limit (dB)	Limit Line (dBuV)	Remark
-	-	-	-	See Note

Note:

The amplitude of spurious emissions which are attenuated by more than 20 dB below the permissible value has no need to be reported.

Distance extrapolation factor = $40 \log(\text{specific distance} / \text{test distance})$ (dB);

Limit line = specific limits (dBuV) + distance extrapolation factor.

4.6.8. Results of Radiated Emissions (30MHz~1GHz)

Temperature	20.9°C	Humidity	65%
Test Engineer	Ron Huang	Configurations	Normal Link

Horizontal

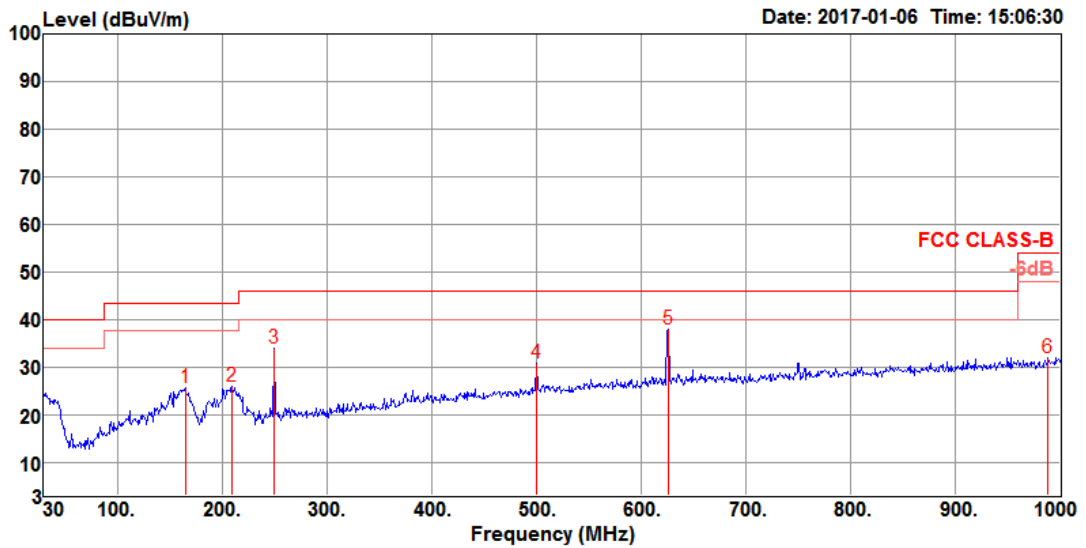

	Freq	Level	Limit	Over	Read	CableAntenna	Preamp	A/Pos	T/Pos	Remark	PoI/Phase
	MHz	dBuV/m	dBuV/m	dB	dBuV	dB	dB/m	dB	cm	deg	
1	164.83	25.56	43.50	-17.94	39.72	1.45	16.75	32.36	200	184	Peak HORIZONTAL
2	209.45	26.04	43.50	-17.46	40.04	1.63	16.70	32.33	300	358	Peak HORIZONTAL
3	250.19	33.80	46.00	-12.20	45.24	1.79	19.10	32.33	150	333	Peak HORIZONTAL
4	500.45	30.64	46.00	-15.36	36.33	2.58	24.03	32.30	100	189	Peak HORIZONTAL
5	625.58	37.86	46.00	-8.14	41.61	2.88	25.77	32.40	100	26	Peak HORIZONTAL
6	988.36	31.85	54.00	-22.15	30.60	3.63	28.50	30.88	125	273	Peak HORIZONTAL

Vertical

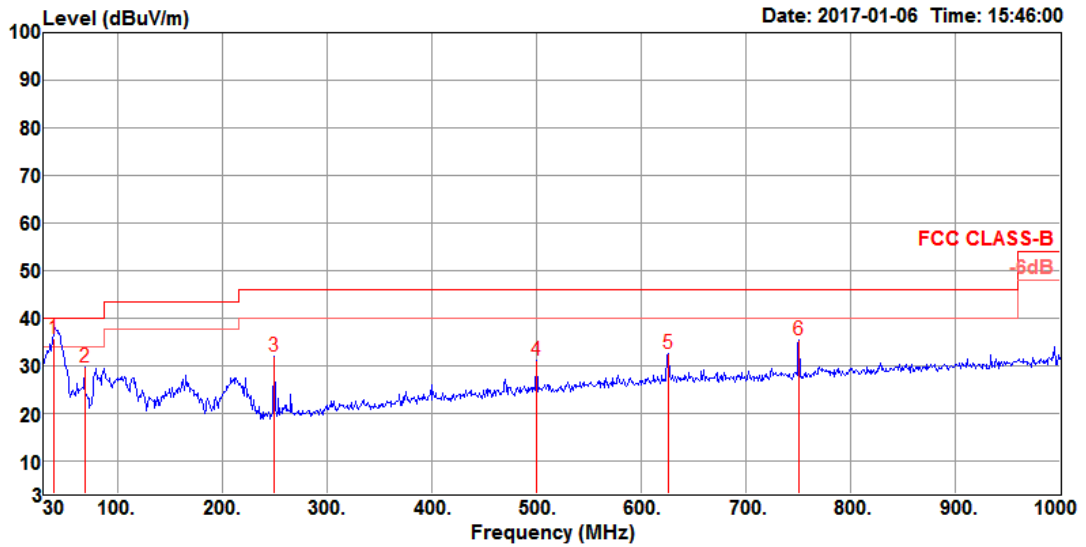

	Freq	Level	Limit Line	Over Limit	Read Level	Cable Loss	Antenna Factor	Preamp Factor	A/Pos	T/Pos	Remark	Pol/Phase
	MHz	dBuV/m	dBuV/m	dB	dBuV	dB	dB/m	dB	cm	deg		
1	39.70	35.52	40.00	-4.48	47.13	0.70	20.36	32.67	100	189	QP	VERTICAL
2	68.80	29.49	40.00	-10.51	47.99	0.92	12.99	32.41	300	92	Peak	VERTICAL
3	250.19	31.91	46.00	-14.09	43.35	1.79	19.10	32.33	200	171	Peak	VERTICAL
4	500.45	30.97	46.00	-15.03	36.66	2.58	24.03	32.30	100	164	Peak	VERTICAL
5	625.58	32.46	46.00	-13.54	36.21	2.88	25.77	32.40	100	63	Peak	VERTICAL
6	750.71	35.43	46.00	-10.57	38.14	3.17	26.40	32.28	100	171	Peak	VERTICAL

Note:

The amplitude of spurious emissions which are attenuated by more than 20 dB below the permissible value has no need to be reported.

Emission level (dBuV/m) = 20 log Emission level (uV/m).

Corrected Reading: Antenna Factor + Cable Loss + Read Level - Preamp Factor = Level.

4.6.9. Results for Radiated Emissions (1GHz~40GHz)

Temperature	25°C	Humidity	58%
Test Engineer	Owen Hsu	Configurations	IEEE 802.11a CH 36 / Chain 1 + Chain 2
Test Date	Nov. 16, 2015		

Horizontal

	Freq	Level	Limit Line	Over Limit	Read Level	CableAntenna Loss	Antenna Factor	Preamp Factor	T/Pos	A/Pos	Remark	Pol/Phase
	MHz	dBuV/m	dBuV/m	dB	dBuV	dB	dB/m	dB	deg	cm		
1	15538.64	59.92	74.00	-14.08	45.55	10.83	38.16	34.62	121	137	Peak	HORIZONTAL
2	15540.62	46.28	54.00	-7.72	31.91	10.83	38.16	34.62	121	137	Average	HORIZONTAL

Vertical

	Freq	Level	Limit Line	Over Limit	Read Level	CableAntenna Loss	Antenna Factor	Preamp Factor	T/Pos	A/Pos	Remark	Pol/Phase
	MHz	dBuV/m	dBuV/m	dB	dBuV	dB	dB/m	dB	deg	cm		
1	15538.19	59.98	74.00	-14.02	45.61	10.83	38.16	34.62	122	132	Peak	VERTICAL
2	15539.56	46.55	54.00	-7.45	32.18	10.83	38.16	34.62	122	132	Average	VERTICAL



Temperature	25°C	Humidity	58%
Test Engineer	Owen Hsu	Configurations	IEEE 802.11a CH 40 / Chain 1 + Chain 2
Test Date	Nov. 16, 2015		

Horizontal

	Freq	Level	Limit Line	Over Limit	Read Level	CableAntenna Loss	Antenna Factor	Preamp Factor	T/Pos	A/Pos	Remark	Pol/Phase
	MHz	dBuV/m	dBuV/m	dB	dBuV	dB	dB/m	dB	deg	cm		
1	15599.03	60.43	74.00	-13.57	45.97	10.86	38.29	34.69	154	136	Peak	HORIZONTAL
2	15599.24	46.37	54.00	-7.63	31.91	10.86	38.29	34.69	154	136	Average	HORIZONTAL

Vertical

	Freq	Level	Limit Line	Over Limit	Read Level	CableAntenna Loss	Antenna Factor	Preamp Factor	T/Pos	A/Pos	Remark	Pol/Phase
	MHz	dBuV/m	dBuV/m	dB	dBuV	dB	dB/m	dB	deg	cm		
1	15598.55	46.21	54.00	-7.79	31.73	10.86	38.29	34.67	162	138	Average	VERTICAL
2	15601.86	59.34	74.00	-14.66	44.88	10.86	38.29	34.69	162	138	Peak	VERTICAL



Temperature	25°C	Humidity	58%
Test Engineer	Owen Hsu	Configurations	IEEE 802.11a CH 48 / Chain 1 + Chain 2
Test Date	Nov. 16, 2015		

Horizontal

	Freq	Level	Limit Line	Over Limit	Read Level	CableAntenna Loss	Antenna Factor	Preamp Factor	T/Pos	A/Pos	Remark	Pol/Phase
	MHz	dBuV/m	dBuV/m	dB	dBuV	dB	dB/m	dB	deg	cm		
1	15719.09	58.92	74.00	-15.08	44.26	10.94	38.50	34.78	157	135	Peak	HORIZONTAL
2	15721.71	45.67	54.00	-8.33	31.01	10.94	38.50	34.78	157	135	Average	HORIZONTAL

Vertical

	Freq	Level	Limit Line	Over Limit	Read Level	CableAntenna Loss	Antenna Factor	Preamp Factor	T/Pos	A/Pos	Remark	Pol/Phase
	MHz	dBuV/m	dBuV/m	dB	dBuV	dB	dB/m	dB	deg	cm		
1	15719.07	59.01	74.00	-14.99	44.35	10.94	38.50	34.78	143	141	Peak	VERTICAL
2	15720.97	45.69	54.00	-8.31	31.03	10.94	38.50	34.78	143	141	Average	VERTICAL



Temperature	25°C	Humidity	58%
Test Engineer	Owen Hsu	Configurations	IEEE 802.11a CH 149 / Chain 1 + Chain 2
Test Date	Nov. 16, 2015		

Horizontal

	Freq	Level	Limit Line	Over Limit	Read Level	CableAntenna Loss	Antenna Factor	Preamp Factor	T/Pos	A/Pos	Remark	Pol/Phase
	MHz	dBuV/m	dBuV/m	dB	dBuV	dB	dB/m	dB	deg	cm		
1	11490.84	47.53	54.00	-6.47	34.40	9.05	38.70	34.62	208	201	Average	HORIZONTAL
2	11490.88	60.41	74.00	-13.59	47.28	9.05	38.70	34.62	208	201	Peak	HORIZONTAL

Vertical

	Freq	Level	Limit Line	Over Limit	Read Level	CableAntenna Loss	Antenna Factor	Preamp Factor	T/Pos	A/Pos	Remark	Pol/Phase
	MHz	dBuV/m	dBuV/m	dB	dBuV	dB	dB/m	dB	deg	cm		
1	11481.28	56.95	74.00	-17.05	43.82	9.05	38.70	34.62	179	203	Peak	VERTICAL
2	11490.40	43.24	54.00	-10.76	30.11	9.05	38.70	34.62	179	203	Average	VERTICAL



Temperature	25°C	Humidity	58%
Test Engineer	Owen Hsu	Configurations	IEEE 802.11a CH 157 / Chain 1 + Chain 2
Test Date	Nov. 16, 2015		

Horizontal

	Freq	Level	Limit Line	Over Limit	Read Level	CableAntenna Loss	Antenna Factor	Preamp Factor	T/Pos	A/Pos	Remark	Pol/Phase
	MHz	dBuV/m	dBuV/m	dB	dBuV	dB	dB/m	dB	deg	cm		
1	11562.24	58.92	74.00	-15.08	45.76	9.09	38.71	34.64	202	203	Peak	HORIZONTAL
2	11571.48	46.20	54.00	-7.80	33.05	9.09	38.71	34.65	202	203	Average	HORIZONTAL

Vertical

	Freq	Level	Limit Line	Over Limit	Read Level	CableAntenna Loss	Antenna Factor	Preamp Factor	T/Pos	A/Pos	Remark	Pol/Phase
	MHz	dBuV/m	dBuV/m	dB	dBuV	dB	dB/m	dB	deg	cm		
1	11571.80	58.36	74.00	-15.64	45.21	9.09	38.71	34.65	221	199	Peak	VERTICAL
2	11571.96	45.16	54.00	-8.84	32.01	9.09	38.71	34.65	221	199	Average	VERTICAL

Temperature	25°C	Humidity	58%
Test Engineer	Owen Hsu	Configurations	IEEE 802.11a CH 165 / Chain 1 + Chain 2
Test Date	Nov. 16, 2015		

Horizontal

	Freq	Level	Limit Line	Over Limit	Read Level	CableAntenna Loss	Antenna Factor	Preamp Factor	T/Pos	A/Pos	Remark	Pol/Phase
	MHz	dBuV/m	dBuV/m	dB	dBuV	dB	dB/m	dB	deg	cm		
1	11651.32	48.96	54.00	-5.04	35.79	9.12	38.73	34.68	207	197	Average	HORIZONTAL
2	11651.96	61.46	74.00	-12.54	48.29	9.12	38.73	34.68	207	197	Peak	HORIZONTAL

Vertical

	Freq	Level	Limit Line	Over Limit	Read Level	CableAntenna Loss	Antenna Factor	Preamp Factor	T/Pos	A/Pos	Remark	Pol/Phase
	MHz	dBuV/m	dBuV/m	dB	dBuV	dB	dB/m	dB	deg	cm		
1	11650.72	48.28	54.00	-5.72	35.11	9.12	38.73	34.68	222	192	Average	VERTICAL
2	11652.48	61.58	74.00	-12.42	48.41	9.12	38.73	34.68	222	192	Peak	VERTICAL



Temperature	25°C	Humidity	58%
Test Engineer	Owen Hsu	Configurations	IEEE 802.11ac MCS0/Nss1 VHT20 CH 36 / Chain 1 + Chain 2
Test Date	Nov. 16, 2015		

Horizontal

	Freq	Level	Limit Line	Over Limit	Read Level	CableAntenna Loss	Antenna Factor	Preamp Factor	T/Pos	A/Pos	Remark	Pol/Phase
	MHz	dBuV/m	dBuV/m	dB	dBuV	dB	dB/m	dB	deg	cm		
1	15538.52	46.42	54.00	-7.58	32.05	10.83	38.16	34.62	211	184	Average	HORIZONTAL
2	15541.15	60.06	74.00	-13.94	45.69	10.83	38.16	34.62	211	184	Peak	HORIZONTAL

Vertical

	Freq	Level	Limit Line	Over Limit	Read Level	CableAntenna Loss	Antenna Factor	Preamp Factor	T/Pos	A/Pos	Remark	Pol/Phase
	MHz	dBuV/m	dBuV/m	dB	dBuV	dB	dB/m	dB	deg	cm		
1	15538.60	46.34	54.00	-7.66	31.97	10.83	38.16	34.62	207	176	Average	VERTICAL
2	15541.75	59.76	74.00	-14.24	45.39	10.83	38.16	34.62	207	176	Peak	VERTICAL

Temperature	25°C	Humidity	58%
Test Engineer	Owen Hsu	Configurations	IEEE 802.11ac MCS0/Nss1 VHT20 CH 40 / Chain 1 + Chain 2
Test Date	Nov. 16, 2015		

Horizontal

	Freq	Level	Limit Line	Over Limit	Read Level	CableAntenna Loss	Antenna Factor	Preamp Factor	T/Pos	A/Pos	Remark	Pol/Phase
	MHz	dBuV/m	dBuV/m	dB	dBuV	dB	dB/m	dB	deg	cm		
1	15598.89	46.19	54.00	-7.81	31.73	10.86	38.29	34.69	199	168	Average	HORIZONTAL
2	15601.06	59.49	74.00	-14.51	45.03	10.86	38.29	34.69	199	168	Peak	HORIZONTAL

Vertical

	Freq	Level	Limit Line	Over Limit	Read Level	CableAntenna Loss	Antenna Factor	Preamp Factor	T/Pos	A/Pos	Remark	Pol/Phase
	MHz	dBuV/m	dBuV/m	dB	dBuV	dB	dB/m	dB	deg	cm		
1	15597.93	60.16	74.00	-13.84	45.68	10.86	38.29	34.67	231	162	Peak	VERTICAL
2	15597.99	46.17	54.00	-7.83	31.69	10.86	38.29	34.67	231	162	Average	VERTICAL



Temperature	25°C	Humidity	58%
Test Engineer	Owen Hsu	Configurations	IEEE 802.11ac MCS0/Nss1 VHT20 CH 48 / Chain 1 + Chain 2
Test Date	Nov. 16, 2015		

Horizontal

	Freq	Level	Limit Line	Over Limit	Read Level	CableAntenna Loss	Antenna Factor	Preamp Factor	T/Pos	A/Pos	Remark	Pol/Phase
	MHz	dBuV/m	dBuV/m	dB	dBuV	dB	dB/m	dB	deg	cm		
1	15718.94	59.29	74.00	-14.71	44.63	10.94	38.50	34.78	211	159	Peak	HORIZONTAL
2	15719.18	45.84	54.00	-8.16	31.18	10.94	38.50	34.78	211	159	Average	HORIZONTAL

Vertical

	Freq	Level	Limit Line	Over Limit	Read Level	CableAntenna Loss	Antenna Factor	Preamp Factor	T/Pos	A/Pos	Remark	Pol/Phase
	MHz	dBuV/m	dBuV/m	dB	dBuV	dB	dB/m	dB	deg	cm		
1	15720.56	45.76	54.00	-8.24	31.10	10.94	38.50	34.78	215	156	Average	VERTICAL
2	15721.28	59.73	74.00	-14.27	45.07	10.94	38.50	34.78	215	156	Peak	VERTICAL



Temperature	25°C	Humidity	58%
Test Engineer	Owen Hsu	Configurations	IEEE 802.11ac MCS0/Nss1 VHT20 CH 149 / Chain 1 + Chain 2
Test Date	Nov. 16, 2015		

Horizontal

	Freq	Level	Limit Line	Over Limit	Read Level	CableAntenna Loss	Antenna Factor	Preamp Factor	T/Pos	A/Pos	Remark	Pol/Phase
	MHz	dBuV/m	dBuV/m	dB	dBuV	dB	dB/m	dB	deg	cm		
1	11488.96	60.76	74.00	-13.24	47.63	9.05	38.70	34.62	211	151	Peak	HORIZONTAL
2	11491.56	46.08	54.00	-7.92	32.95	9.05	38.70	34.62	211	151	Average	HORIZONTAL

Vertical

	Freq	Level	Limit Line	Over Limit	Read Level	CableAntenna Loss	Antenna Factor	Preamp Factor	T/Pos	A/Pos	Remark	Pol/Phase
	MHz	dBuV/m	dBuV/m	dB	dBuV	dB	dB/m	dB	deg	cm		
1	11487.65	46.25	54.00	-7.75	33.12	9.05	38.70	34.62	217	148	Average	VERTICAL
2	11491.70	60.44	74.00	-13.56	47.31	9.05	38.70	34.62	217	148	Peak	VERTICAL



Temperature	25°C	Humidity	58%
Test Engineer	Owen Hsu	Configurations	IEEE 802.11ac MCS0/Nss1 VHT20 CH 157 / Chain 1 + Chain 2
Test Date	Nov. 16, 2015		

Horizontal

	Freq	Level	Limit Line	Over Limit	Read Level	CableAntenna Loss	Antenna Factor	Preamp Factor	T/Pos	A/Pos	Remark	Pol/Phase
	MHz	dBuV/m	dBuV/m	dB	dBuV	dB	dB/m	dB	deg	cm		
1	11568.72	59.23	74.00	-14.77	46.07	9.09	38.71	34.64	219	145	Peak	HORIZONTAL
2	11569.43	45.71	54.00	-8.29	32.55	9.09	38.71	34.64	219	145	Average	HORIZONTAL

Vertical

	Freq	Level	Limit Line	Over Limit	Read Level	CableAntenna Loss	Antenna Factor	Preamp Factor	T/Pos	A/Pos	Remark	Pol/Phase
	MHz	dBuV/m	dBuV/m	dB	dBuV	dB	dB/m	dB	deg	cm		
1	11568.79	59.64	74.00	-14.36	46.48	9.09	38.71	34.64	206	143	Peak	VERTICAL
2	11571.27	46.24	54.00	-7.76	33.09	9.09	38.71	34.65	206	143	Average	VERTICAL



Temperature	25°C	Humidity	58%
Test Engineer	Owen Hsu	Configurations	IEEE 802.11ac MCS0/Nss1 VHT20 CH 165 / Chain 1 + Chain 2
Test Date	Nov. 16, 2015		

Horizontal

	Freq	Level	Limit Line	Over Limit	Read Level	CableAntenna Loss	Antenna Factor	Preamp Factor	T/Pos	A/Pos	Remark	Pol/Phase
	MHz	dBuV/m	dBuV/m	dB	dBuV	dB	dB/m	dB	deg	cm		
1	11649.91	48.11	54.00	-5.89	34.94	9.12	38.73	34.68	200	141	Average	HORIZONTAL
2	11651.24	61.77	74.00	-12.23	48.60	9.12	38.73	34.68	200	141	Peak	HORIZONTAL

Vertical

	Freq	Level	Limit Line	Over Limit	Read Level	CableAntenna Loss	Antenna Factor	Preamp Factor	T/Pos	A/Pos	Remark	Pol/Phase
	MHz	dBuV/m	dBuV/m	dB	dBuV	dB	dB/m	dB	deg	cm		
1	11649.06	47.78	54.00	-6.22	34.61	9.12	38.73	34.68	198	140	Average	VERTICAL
2	11649.15	61.78	74.00	-12.22	48.61	9.12	38.73	34.68	198	140	Peak	VERTICAL



Temperature	25°C	Humidity	58%
Test Engineer	Owen Hsu	Configurations	IEEE 802.11ac MCS0/Nss1 VHT40 CH 38 / Chain 1 + Chain 2
Test Date	Nov. 16, 2015		

Horizontal

	Freq	Level	Limit Line	Over Limit	Read Level	CableAntenna Loss	Antenna Factor	Preamp Factor	T/Pos	A/Pos	Remark	Pol/Phase
	MHz	dBuV/m	dBuV/m	dB	dBuV	dB	dB/m	dB	deg	cm		
1	15567.89	46.49	54.00	-7.51	32.05	10.86	38.22	34.64	187	143	Average	HORIZONTAL
2	15570.64	60.26	74.00	-13.74	45.82	10.86	38.22	34.64	187	143	Peak	HORIZONTAL

Vertical

	Freq	Level	Limit Line	Over Limit	Read Level	CableAntenna Loss	Antenna Factor	Preamp Factor	T/Pos	A/Pos	Remark	Pol/Phase
	MHz	dBuV/m	dBuV/m	dB	dBuV	dB	dB/m	dB	deg	cm		
1	15570.63	46.71	54.00	-7.29	32.27	10.86	38.22	34.64	187	143	Average	VERTICAL
2	15571.50	60.02	74.00	-13.98	45.58	10.86	38.22	34.64	187	143	Peak	VERTICAL



Temperature	25°C	Humidity	58%
Test Engineer	Owen Hsu	Configurations	IEEE 802.11ac MCS0/Nss1 VHT40 CH 46 / Chain 1 + Chain 2
Test Date	Nov. 16, 2015		

Horizontal

	Freq	Level	Limit Line	Over Limit	Read Level	CableAntenna Loss	Antenna Factor	Preamp Factor	T/Pos	A/Pos	Remark	Pol/Phase
	MHz	dBuV/m	dBuV/m	dB	dBuV	dB	dB/m	dB	deg	cm		
1	15687.92	58.97	74.00	-15.03	44.37	10.91	38.44	34.75	196	139	Peak	HORIZONTAL
2	15690.64	45.80	54.00	-8.20	31.20	10.91	38.44	34.75	196	139	Average	HORIZONTAL

Vertical

	Freq	Level	Limit Line	Over Limit	Read Level	CableAntenna Loss	Antenna Factor	Preamp Factor	T/Pos	A/Pos	Remark	Pol/Phase
	MHz	dBuV/m	dBuV/m	dB	dBuV	dB	dB/m	dB	deg	cm		
1	15688.36	59.90	74.00	-14.10	45.30	10.91	38.44	34.75	201	136	Peak	VERTICAL
2	15692.50	45.88	54.00	-8.12	31.28	10.91	38.44	34.75	201	136	Average	VERTICAL



Temperature	25°C	Humidity	58%
Test Engineer	Owen Hsu	Configurations	IEEE 802.11ac MCS0/Nss1 VHT40 CH 151 / Chain 1 + Chain 2
Test Date	Nov. 16, 2015		

Horizontal

	Freq	Level	Limit Line	Over Limit	Read Level	CableAntenna Loss	Antenna Factor	Preamp Factor	T/Pos	A/Pos	Remark	Pol/Phase
	MHz	dBuV/m	dBuV/m	dB	dBuV	dB	dB/m	dB	deg	cm		
1	11508.65	57.91	74.00	-16.09	44.78	9.05	38.70	34.62	197	134	Peak	HORIZONTAL
2	11509.73	44.16	54.00	-9.84	31.01	9.07	38.70	34.62	197	134	Average	HORIZONTAL

Vertical

	Freq	Level	Limit Line	Over Limit	Read Level	CableAntenna Loss	Antenna Factor	Preamp Factor	T/Pos	A/Pos	Remark	Pol/Phase
	MHz	dBuV/m	dBuV/m	dB	dBuV	dB	dB/m	dB	deg	cm		
1	11510.24	44.41	54.00	-9.59	31.26	9.07	38.70	34.62	201	130	Average	VERTICAL
2	11511.10	58.03	74.00	-15.97	44.88	9.07	38.70	34.62	201	130	Peak	VERTICAL



Temperature	25°C	Humidity	58%
Test Engineer	Owen Hsu	Configurations	IEEE 802.11ac MCS0/Nss1 VHT40 CH 159 / Chain 1 + Chain 2
Test Date	Nov. 16, 2015		

Horizontal

	Freq	Level	Limit Line	Over Limit	Read Level	CableAntenna Loss	Antenna Factor	Preamp Factor	T/Pos	A/Pos	Remark	Pol/Phase
	MHz	dBuV/m	dBuV/m	dB	dBuV	dB	dB/m	dB	deg	cm		
1	11590.92	45.22	54.00	-8.78	32.05	9.10	38.72	34.65	209	134	Average	HORIZONTAL
2	11592.07	58.93	74.00	-15.07	45.76	9.10	38.72	34.65	209	134	Peak	HORIZONTAL

Vertical

	Freq	Level	Limit Line	Over Limit	Read Level	CableAntenna Loss	Antenna Factor	Preamp Factor	T/Pos	A/Pos	Remark	Pol/Phase
	MHz	dBuV/m	dBuV/m	dB	dBuV	dB	dB/m	dB	deg	cm		
1	11587.56	44.62	54.00	-9.38	31.45	9.10	38.72	34.65	211	130	Average	VERTICAL
2	11588.46	58.07	74.00	-15.93	44.90	9.10	38.72	34.65	211	130	Peak	VERTICAL



Temperature	25°C	Humidity	58%
Test Engineer	Owen Hsu	Configurations	IEEE 802.11ac MCS0/Nss1 VHT80 CH 42 / Chain 1 + Chain 2
Test Date	Nov. 16, 2015		

Horizontal

	Freq	Level	Limit Line	Over Limit	Read Level	CableAntenna Loss	Antenna Factor	Preamp Factor	T/Pos	A/Pos	Remark	Pol/Phase
	MHz	dBuV/m	dBuV/m	dB	dBuV	dB	dB/m	dB	deg	cm		
1	15629.38	45.94	54.00	-8.06	31.42	10.88	38.35	34.71	215	126	Average	HORIZONTAL
2	15630.00	59.48	74.00	-14.52	44.96	10.88	38.35	34.71	215	126	Peak	HORIZONTAL

Vertical

	Freq	Level	Limit Line	Over Limit	Read Level	CableAntenna Loss	Antenna Factor	Preamp Factor	T/Pos	A/Pos	Remark	Pol/Phase
	MHz	dBuV/m	dBuV/m	dB	dBuV	dB	dB/m	dB	deg	cm		
1	15628.01	59.17	74.00	-14.83	44.68	10.88	38.32	34.71	209	124	Peak	VERTICAL
2	15628.73	45.93	54.00	-8.07	31.41	10.88	38.35	34.71	209	124	Average	VERTICAL



Temperature	25°C	Humidity	58%
Test Engineer	Owen Hsu	Configurations	IEEE 802.11ac MCS0/Nss1 VHT80 CH 155 / Chain 1 + Chain 2
Test Date	Nov. 16, 2015		

Horizontal

	Freq	Level	Limit	Over	Read	CableAntenna	Preamp	T/Pos	A/Pos	Remark	Pol/Phase	
	MHz	dBuV/m	dBuV/m	dB	dBuV	dB	dB/m	dB	deg	cm		
1	11549.18	42.45	54.00	-11.55	29.29	9.09	38.71	34.64	209	124	Average	HORIZONTAL
2	11552.43	55.39	74.00	-18.61	42.23	9.09	38.71	34.64	209	124	Peak	HORIZONTAL

Vertical

	Freq	Level	Limit	Over	Read	CableAntenna	Preamp	T/Pos	A/Pos	Remark	Pol/Phase	
	MHz	dBuV/m	dBuV/m	dB	dBuV	dB	dB/m	dB	deg	cm		
1	11552.11	42.07	54.00	-11.93	28.91	9.09	38.71	34.64	193	117	Average	VERTICAL
2	11552.32	55.33	74.00	-18.67	42.17	9.09	38.71	34.64	193	117	Peak	VERTICAL

Note:

The amplitude of spurious emissions that are attenuated by more than 20dB below the permissible value has no need to be reported.

Emission level (dBuV/m) = 20 log Emission level (uV/m).

Corrected Reading: Antenna Factor + Cable Loss + Read Level - Preamp Factor = Level.

4.7. Band Edge Emissions Measurement

4.7.1. Limit

For transmitters operating in the 5.15-5.25 GHz band: all emissions outside of the 5.15-5.35 GHz band shall not exceed an e.i.r.p. of -27 dBm/MHz.

For transmitters operating in the 5.725-5.85 GHz band: all emissions within the frequency range from the band edge to 10 MHz above or below the band edge shall not exceed an e.i.r.p. of -17 dBm/MHz; for frequencies 10 MHz or greater above or below the band edge, emissions shall not exceed an e.i.r.p. of -27 dBm/MHz.

In addition, In case the emission fall within the restricted band specified on 15.205(a), then the 15.209(a) limit in the table below has to be followed.

Frequencies (MHz)	Field Strength (micorvolts/meter)	Measurement Distance (meters)
0.009~0.490	2400/F(kHz)	300
0.490~1.705	24000/F(kHz)	30
1.705~30.0	30	30
30~88	100	3
88~216	150	3
216~960	200	3
Above 960	500	3

4.7.2. Measuring Instruments and Setting

Please refer to section 5 of equipments list in this report. The following table is the setting of the spectrum analyzer.

Spectrum Parameter	Setting
Attenuation	Auto
Span Frequency	100 MHz
RBW / VBW (Emission in restricted band)	1 MHz / 3MHz for Peak, 1 MHz / 1/T for Average
RBW / VBW (Emission in non-restricted band)	1 MHz / 3MHz for Peak

4.7.3. Test Procedures

1. The test procedure is the same as section 4.6.3.

4.7.4. Test Setup Layout

This test setup layout is the same as that shown in section 4.6.4.

4.7.5. Test Deviation

There is no deviation with the original standard.

4.7.6. EUT Operation during Test

The EUT was programmed to be in continuously transmitting mode.

4.7.7. Test Result of Band Edge and Fundamental Emissions

Temperature	25°C	Humidity	58%
Test Engineer	Owen Hsu	Configurations	IEEE 802.11a CH 36, 40, 48 / Chain 1 + Chain 2
Test Date	Nov. 16, 2015		

Channel 36

	Freq	Level	Limit	Over	Read	CableAntenna	Preamp	T/Pos	A/Pos	Remark	Pol/Phase
	MHz	dBuV/m	dBuV/m	dB	dBuV	dB	dB/m	deg	cm		
1	5147.40	66.86	74.00	-7.14	62.37	5.69	33.27	34.47	9	168 Peak	VERTICAL
2	5150.00	53.81	54.00	-0.19	49.32	5.69	33.27	34.47	9	168 Average	VERTICAL
3	5176.00	110.69			106.11	5.72	33.33	34.47	9	168 Average	VERTICAL
4	5176.20	122.49			117.91	5.72	33.33	34.47	9	168 Peak	VERTICAL

Item 3, 4 are the fundamental frequency at 5180 MHz.

Channel 40

	Freq	Level	Limit	Over	Read	CableAntenna	Preamp	T/Pos	A/Pos	Remark	Pol/Phase
	MHz	dBuV/m	dBuV/m	dB	dBuV	dB	dB/m	deg	cm		
1	5120.40	66.21	74.00	-7.79	61.81	5.66	33.21	34.47	358	167 Peak	HORIZONTAL
2	5148.40	53.62	54.00	-0.38	49.13	5.69	33.27	34.47	358	167 Average	HORIZONTAL
3	5193.60	124.06			119.43	5.74	33.36	34.47	358	167 Peak	HORIZONTAL
4	5193.60	113.86			109.23	5.74	33.36	34.47	358	167 Average	HORIZONTAL

Item 3, 4 are the fundamental frequency at 5200 MHz.

Channel 48

	Freq	Level	Limit	Over	Read	CableAntenna	Preamp	T/Pos	A/Pos	Remark	Pol/Phase
	MHz	dBuV/m	dBuV/m	dB	dBuV	dB	dB/m	deg	cm		
1	5112.20	64.86	74.00	-9.14	60.46	5.66	33.21	34.47	358	169 Peak	HORIZONTAL
2	5150.00	51.94	54.00	-2.06	47.45	5.69	33.27	34.47	358	169 Average	HORIZONTAL
3	5236.40	122.81			118.06	5.80	33.42	34.47	358	169 Peak	HORIZONTAL
4	5236.40	113.11			108.36	5.80	33.42	34.47	358	169 Average	HORIZONTAL
5	5374.40	65.76	74.00	-8.24	60.54	6.03	33.66	34.47	358	169 Peak	HORIZONTAL
6	5384.60	53.71	54.00	-0.29	48.43	6.06	33.69	34.47	358	169 Average	HORIZONTAL

Item 3, 4 are the fundamental frequency at 5240 MHz.

Temperature	25°C	Humidity	58%
Test Engineer	Owen Hsu	Configurations	IEEE 802.11a CH 149, 157, 165 / Chain 1 + Chain 2
Test Date	Nov. 16, 2015		

Channel 149

	Freq	Level	Limit	Over	Read	CableAntenna	Preamp	T/Pos	A/Pos	Remark	Pol/Phase
	MHz	dBuV/m	dBuV/m	dB	dBuV	dB	dB/m	dB	deg	cm	
1	5714.20	68.11	68.20	-0.09	62.05	6.05	34.52	34.51	2	163 Peak	HORIZONTAL
2	5725.00	71.41	78.20	-6.79	65.30	6.05	34.57	34.51	2	163 Peak	HORIZONTAL
3	5740.20	119.89			113.78	6.01	34.62	34.52	2	163 Peak	HORIZONTAL
4	5740.20	110.26			104.15	6.01	34.62	34.52	2	163 Average	HORIZONTAL

Item 3, 4 are the fundamental frequency at 5745 MHz.

Channel 157

	Freq	Level	Limit	Over	Read	CableAntenna	Preamp	T/Pos	A/Pos	Remark	Pol/Phase
	MHz	dBuV/m	dBuV/m	dB	dBuV	dB	dB/m	dB	deg	cm	
1	5702.20	67.98	68.20	-0.22	61.87	6.10	34.52	34.51	3	152 Average	HORIZONTAL
2	5719.80	68.00	78.20	-10.20	61.89	6.05	34.57	34.51	3	152 Average	HORIZONTAL
3	5777.40	121.75			115.64	5.91	34.73	34.53	3	152 Average	HORIZONTAL
4	5777.80	111.88			105.77	5.91	34.73	34.53	3	152 Peak	HORIZONTAL
5	5850.00	66.86	78.20	-11.34	60.46	6.01	34.93	34.54	3	152 Average	HORIZONTAL
6	5869.00	66.32	68.20	-1.88	59.81	6.06	34.99	34.54	3	152 Average	HORIZONTAL

Item 3, 4 are the fundamental frequency at 5785 MHz.

Channel 165

	Freq	Level	Limit	Over	Read	CableAntenna	Preamp	T/Pos	A/Pos	Remark	Pol/Phase
	MHz	dBuV/m	dBuV/m	dB	dBuV	dB	dB/m	dB	deg	cm	
1	5822.60	122.86			116.55	5.96	34.88	34.53	2	156 Peak	HORIZONTAL
2	5822.60	112.53			106.22	5.96	34.88	34.53	2	156 Average	HORIZONTAL
3	5853.40	72.58	78.20	-5.62	66.18	6.01	34.93	34.54	2	156 Peak	HORIZONTAL
4	5861.80	68.04	68.20	-0.16	61.53	6.06	34.99	34.54	2	156 Peak	HORIZONTAL

Item 1, 2 are the fundamental frequency at 5825 MHz.



Temperature	25°C	Humidity	58%
Test Engineer	Owen Hsu	Configurations	IEEE 802.11ac MCS0/Nss1 VHT20 CH 36, 40, 48 / Chain 1 + Chain 2
Test Date	Nov. 16, 2015		

Channel 36

	Freq	Level	Limit Line	Over Limit	Read Level	CableAntenna Loss	Antenna Factor	Preamp Factor	T/Pos	A/Pos	Remark	Pol/Phase
	MHz	dBuV/m	dBuV/m	dB	dBuV	dB	dB/m	dB	deg	cm		
1	5149.40	53.94	54.00	-0.06	49.45	5.69	33.27	34.47	3	154	Average	HORIZONTAL
2	5150.00	67.40	74.00	-6.60	62.91	5.69	33.27	34.47	3	154	Peak	HORIZONTAL
3	5174.40	111.40			106.82	5.72	33.33	34.47	3	154	Average	HORIZONTAL
4	5176.00	122.04			117.46	5.72	33.33	34.47	3	154	Peak	HORIZONTAL

Item 3, 4 are the fundamental frequency at 5180 MHz.

Channel 40

	Freq	Level	Limit Line	Over Limit	Read Level	CableAntenna Loss	Antenna Factor	Preamp Factor	T/Pos	A/Pos	Remark	Pol/Phase
	MHz	dBuV/m	dBuV/m	dB	dBuV	dB	dB/m	dB	deg	cm		
1	5141.60	53.76	54.00	-0.24	49.27	5.69	33.27	34.47	1	172	Average	HORIZONTAL
2	5142.00	66.27	74.00	-7.73	61.78	5.69	33.27	34.47	1	172	Peak	HORIZONTAL
3	5194.80	123.50			118.87	5.74	33.36	34.47	1	172	Peak	HORIZONTAL
4	5194.80	114.20			109.57	5.74	33.36	34.47	1	172	Average	HORIZONTAL

Item 3, 4 are the fundamental frequency at 5200 MHz.

Channel 48

	Freq	Level	Limit Line	Over Limit	Read Level	CableAntenna Loss	Antenna Factor	Preamp Factor	T/Pos	A/Pos	Remark	Pol/Phase
	MHz	dBuV/m	dBuV/m	dB	dBuV	dB	dB/m	dB	deg	cm		
1	5120.00	64.38	74.00	-9.62	59.98	5.66	33.21	34.47	358	173	Peak	VERTICAL
2	5137.40	51.86	54.00	-2.14	47.41	5.68	33.24	34.47	358	173	Average	VERTICAL
3	5243.00	122.49			117.68	5.83	33.45	34.47	358	173	Peak	VERTICAL
4	5243.00	111.73			106.92	5.83	33.45	34.47	358	173	Average	VERTICAL
5	5350.00	53.68	54.00	-0.32	48.52	6.00	33.63	34.47	358	173	Average	VERTICAL
6	5379.20	66.45	74.00	-7.55	61.20	6.03	33.69	34.47	358	173	Peak	VERTICAL

Item 3, 4 are the fundamental frequency at 5240 MHz.

Temperature	25°C	Humidity	58%
Test Engineer	Owen Hsu	Configurations	IEEE 802.11ac MCS0/Nss1 VHT20 CH 149, 157, 165 / Chain 1 + Chain 2
Test Date	Nov. 16, 2015		

Channel 149

	Freq	Level	Limit Line	Over Limit	Read Level	CableAntenna Loss	Antenna Factor	Preamp Factor	T/Pos	A/Pos	Remark	Pol/Phase
	MHz	dBuV/m	dBuV/m	dB	dBuV	dB	dB/m	dB	deg	cm		
1	5708.20	68.08	68.20	-0.12	62.02	6.05	34.52	34.51	359	161	Peak	HORIZONTAL
2	5725.00	74.69	78.20	-3.51	68.58	6.05	34.57	34.51	359	161	Peak	HORIZONTAL
3	5746.20	120.21			114.15	5.96	34.62	34.52	359	161	Peak	HORIZONTAL
4	5746.20	109.87			103.81	5.96	34.62	34.52	359	161	Average	HORIZONTAL

Item 3, 4 are the fundamental frequency at 5745 MHz.

Channel 157

	Freq	Level	Limit Line	Over Limit	Read Level	CableAntenna Loss	Antenna Factor	Preamp Factor	T/Pos	A/Pos	Remark	Pol/Phase
	MHz	dBuV/m	dBuV/m	dB	dBuV	dB	dB/m	dB	deg	cm		
1	5697.00	67.96	68.20	-0.24	61.90	6.10	34.47	34.51	358	155	Peak	HORIZONTAL
2	5725.00	66.37	78.20	-11.83	60.26	6.05	34.57	34.51	358	155	Peak	HORIZONTAL
3	5777.40	120.71			114.60	5.91	34.73	34.53	358	155	Peak	HORIZONTAL
4	5777.40	110.96			104.85	5.91	34.73	34.53	358	155	Average	HORIZONTAL
5	5850.00	65.69	78.20	-12.51	59.29	6.01	34.93	34.54	358	155	Peak	HORIZONTAL
6	5872.20	66.31	68.20	-1.89	59.75	6.06	35.04	34.54	358	155	Peak	HORIZONTAL

Item 3, 4 are the fundamental frequency at 5785 MHz.

Channel 165

	Freq	Level	Limit Line	Over Limit	Read Level	CableAntenna Loss	Antenna Factor	Preamp Factor	T/Pos	A/Pos	Remark	Pol/Phase
	MHz	dBuV/m	dBuV/m	dB	dBuV	dB	dB/m	dB	deg	cm		
1	5817.40	110.24			104.02	5.92	34.83	34.53	3	169	Average	HORIZONTAL
2	5817.80	120.26			114.04	5.92	34.83	34.53	3	169	Peak	HORIZONTAL
3	5857.00	71.34	78.20	-6.86	64.88	6.01	34.99	34.54	3	169	Peak	HORIZONTAL
4	5861.00	68.01	68.20	-0.19	61.50	6.06	34.99	34.54	3	169	Peak	HORIZONTAL

Item 1, 2 are the fundamental frequency at 5825 MHz.



Temperature	25°C	Humidity	58%
Test Engineer	Owen Hsu	Configurations	IEEE 802.11ac MCS0/Nss1 VHT40 CH 38, 46 / Chain 1 + Chain 2
Test Date	Nov. 16, 2015		

Channel 38

	Freq	Level	Limit Line	Over Limit	Read Level	CableAntenna Loss	Preamp Factor	T/Pos	A/Pos	Remark	Pol/Phase
	MHz	dBuV/m	dBuV/m	dB	dBuV	dB	dB/m	deg	cm		
1	5143.60	66.70	74.00	-7.30	62.21	5.69	33.27	34.47	4	167 Peak	HORIZONTAL
2	5149.20	53.92	54.00	-0.08	49.43	5.69	33.27	34.47	4	167 Average	HORIZONTAL
3	5184.40	117.15			112.57	5.72	33.33	34.47	4	167 Peak	HORIZONTAL
4	5204.00	107.44			102.81	5.74	33.36	34.47	4	167 Average	HORIZONTAL

Item 3, 4 are the fundamental frequency at 5190 MHz.

Channel 46

	Freq	Level	Limit Line	Over Limit	Read Level	CableAntenna Loss	Preamp Factor	T/Pos	A/Pos	Remark	Pol/Phase
	MHz	dBuV/m	dBuV/m	dB	dBuV	dB	dB/m	deg	cm		
1	5083.60	65.56	74.00	-8.44	61.25	5.63	33.15	34.47	1	154 Peak	HORIZONTAL
2	5150.00	52.79	54.00	-1.21	48.30	5.69	33.27	34.47	1	154 Average	HORIZONTAL
3	5242.80	109.25			104.44	5.83	33.45	34.47	1	154 Average	HORIZONTAL
4	5243.60	119.40			114.59	5.83	33.45	34.47	1	154 Peak	HORIZONTAL
5	5359.60	66.12	74.00	-7.88	60.96	6.00	33.63	34.47	1	154 Peak	HORIZONTAL
6	5404.40	53.64	54.00	-0.36	48.30	6.09	33.72	34.47	1	154 Average	HORIZONTAL

Item 3, 4 are the fundamental frequency at 5230 MHz.



Temperature	25°C	Humidity	58%
Test Engineer	Owen Hsu	Configurations	IEEE 802.11ac MCS0/Nss1 VHT40 CH 151, 159 / Chain 1 + Chain 2
Test Date	Nov. 16, 2015		

Channel 151

	Freq	Level	Limit Line	Over Limit	Read Level	CableAntenna Loss	Antenna Factor	Preamp Factor	T/Pos	A/Pos	Remark	Pol/Phase
	MHz	dBuV/m	dBuV/m	dB	dBuV	dB	dB/m	dB	deg	cm		
1	5707.40	66.62	68.20	-1.58	60.51	6.10	34.52	34.51	3	155	Peak	HORIZONTAL
2	5725.00	78.11	78.20	-0.09	72.00	6.05	34.57	34.51	3	155	Peak	HORIZONTAL
3	5745.00	105.68			99.57	6.01	34.62	34.52	3	155	Average	HORIZONTAL
4	5745.80	115.56			109.50	5.96	34.62	34.52	3	155	Peak	HORIZONTAL

Item 3, 4 are the fundamental frequency at 5755 MHz.

Channel 159

	Freq	Level	Limit Line	Over Limit	Read Level	CableAntenna Loss	Antenna Factor	Preamp Factor	T/Pos	A/Pos	Remark	Pol/Phase
	MHz	dBuV/m	dBuV/m	dB	dBuV	dB	dB/m	dB	deg	cm		
1	5703.00	66.52	68.20	-1.68	60.41	6.10	34.52	34.51	3	169	Peak	HORIZONTAL
2	5722.20	68.13	78.20	-10.07	62.02	6.05	34.57	34.51	3	169	Peak	HORIZONTAL
3	5786.60	119.84			113.72	5.87	34.78	34.53	3	169	Peak	HORIZONTAL
4	5805.40	109.86			103.64	5.92	34.83	34.53	3	169	Average	HORIZONTAL
5	5850.60	69.31	78.20	-8.89	62.91	6.01	34.93	34.54	3	169	Peak	HORIZONTAL
6	5868.20	68.00	68.20	-0.20	61.49	6.06	34.99	34.54	3	169	Peak	HORIZONTAL

Item 3, 4 are the fundamental frequency at 5795 MHz.



Temperature	25°C	Humidity	58%
Test Engineer	Owen Hsu	Configurations	IEEE 802.11ac MCS0/Nss1 VHT80 CH 42, 155 / Chain 1 + Chain 2
Test Date	Nov. 16, 2015		

Channel 42

	Freq	Level	Limit	Over	Read	CableAntenna	Preamp	T/Pos	A/Pos	Remark	Pol/Phase
	MHz	dBuV/m	dBuV/m	dB	dBuV	dB	dB/m	deg	cm		
1	5149.00	69.18	74.00	-4.82	64.69	5.69	33.27	34.47	4	167 Peak	HORIZONTAL
2	5149.00	53.98	54.00	-0.02	49.49	5.69	33.27	34.47	4	167 Average	HORIZONTAL
3	5199.00	109.68			105.05	5.74	33.36	34.47	4	167 Peak	HORIZONTAL
4	5225.00	96.95			92.20	5.80	33.42	34.47	4	167 Average	HORIZONTAL
5	5404.00	64.28	74.00	-9.72	58.94	6.09	33.72	34.47	4	167 Peak	HORIZONTAL
6	5443.00	51.60	54.00	-2.40	46.16	6.13	33.78	34.47	4	167 Average	HORIZONTAL

Item 3, 4 are the fundamental frequency at 5210 MHz.

Channel 155

	Freq	Level	Limit	Over	Read	CableAntenna	Preamp	T/Pos	A/Pos	Remark	Pol/Phase
	MHz	dBuV/m	dBuV/m	dB	dBuV	dB	dB/m	deg	cm		
1	5713.00	65.83	68.20	-2.37	59.77	6.05	34.52	34.51	358	177 Peak	HORIZONTAL
2	5725.00	77.81	78.20	-0.39	71.70	6.05	34.57	34.51	358	177 Peak	HORIZONTAL
3	5746.00	95.46			89.40	5.96	34.62	34.52	358	177 Average	HORIZONTAL
4	5762.00	105.32			99.21	5.96	34.68	34.53	358	177 Peak	HORIZONTAL
5	5850.00	61.53	78.20	-16.67	55.13	6.01	34.93	34.54	358	177 Peak	HORIZONTAL
6	5861.00	62.36	68.20	-5.84	55.85	6.06	34.99	34.54	358	177 Peak	HORIZONTAL

Item 3, 4 are the fundamental frequency at 5775 MHz.

Note:

Emission level (dBuV/m) = 20 log Emission level (uV/m)

Corrected Reading: Antenna Factor + Cable Loss + Read Level - Preamp Factor = Level

4.8. Frequency Stability Measurement

4.8.1. Limit

In-band emission is maintained within the band of operation under all conditions of normal operation as specified in the user's manual.

The transmitter center frequency tolerance shall be ± 20 ppm maximum for the 5 GHz band (IEEE 802.11n specification).

4.8.2. Measuring Instruments and Setting

Please refer to section 5 of equipments list in this report. The following table is the setting of the spectrum analyzer.

Spectrum Parameter	Setting
Attenuation	Auto
Span Frequency	Entire absence of modulation emissions bandwidth
RBW	10 kHz
VBW	10 kHz
Sweep Time	Auto

4.8.3. Test Procedures

1. The transmitter output (antenna port) was connected to the spectrum analyzer.
2. EUT have transmitted absence of modulation signal and fixed channelize.
3. Set the spectrum analyzer span to view the entire absence of modulation emissions bandwidth.
4. Set RBW = 10 kHz, VBW = 10 kHz with peak detector and maxhold settings.
5. f_c is declaring of channel frequency. Then the frequency error formula is $(f_c-f)/f_c \times 10^6$ ppm and the limit is less than ± 20 ppm (IEEE 802.11n specification).
6. Allow sufficient time (approximately 30 min) for the temperature of the chamber to stabilize, turn the EUT on and measure the operating frequency after 2, 5, and 10 minutes.
7. The test extreme voltage is to change the primary supply voltage from 85 to 115 percent of the nominal value
8. Extreme temperature is $-20^{\circ}\text{C} \sim 60^{\circ}\text{C}$.

4.8.4. Test Setup Layout

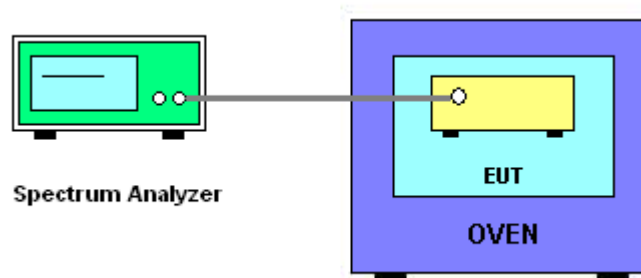

4.8.5. Test Deviation

There is no deviation with the original standard.

4.8.6. EUT Operation during Test

The EUT was programmed to be in continuously un-modulation transmitting mode.

4.8.7. Test Result of Frequency Stability

Temperature	25°C	Humidity	45%
Test Engineer	Lucas Huang	Test Date	Nov. 24, 2015

Mode: 20 MHz / Chain 1

Voltage vs. Frequency Stability

Voltage (V)	Measurement Frequency (MHz)			
	5200 MHz			
	0 Minute	2 Minute	5 Minute	10 Minute
126.50	5200.0172	5200.0158	5200.0140	5200.0119
110.00	5200.0160	5200.0147	5200.0131	5200.0112
93.50	5200.0146	5200.0135	5200.0123	5200.0101
Max. Deviation (MHz)	0.0172	0.0158	0.0140	0.0119
Max. Deviation (ppm)	3.31	3.04	2.69	2.29
Result	Complies			

Temperature vs. Frequency Stability

Temperature (°C)	Measurement Frequency (MHz)			
	5200 MHz			
	0 Minute	2 Minute	5 Minute	10 Minute
-20	5200.0114	5200.0101	5200.0084	5200.0060
-10	5200.0099	5200.0087	5200.0071	5200.0052
0	5200.0085	5200.0073	5200.0054	5200.0032
10	5200.0072	5200.0059	5200.0044	5200.0026
20	5200.0060	5200.0047	5200.0031	5200.0012
30	5200.0046	5200.0035	5200.0021	5200.0005
40	5200.0030	5200.0015	5199.9999	5199.9979
50	5200.0013	5200.0001	5199.9986	5199.9959
60	5200.0018	5200.0006	5199.9984	5199.9979
Max. Deviation (MHz)	0.0114	0.0101	0.0084	0.0060
Max. Deviation (ppm)	2.19	1.94	1.62	1.15
Result	Complies			

Voltage vs. Frequency Stability

Voltage	Measurement Frequency (MHz)			
(V)	5785 MHz			
	0 Minute	2 Minute	5 Minute	10 Minute
126.50	5785.0116	5785.0102	5784.9994	5784.9963
110.00	5785.0104	5784.9997	5784.9985	5784.9956
93.50	5784.9990	5784.9979	5784.9987	5784.9945
Max. Deviation (MHz)	0.0116	0.0102	0.0015	0.0055
Max. Deviation (ppm)	2.01	1.76	0.26	0.95
Result	Complies			

Temperature vs. Frequency Stability

Temperature	Measurement Frequency (MHz)			
(°C)	5785 MHz			
	0 Minute	2 Minute	5 Minute	10 Minute
-20	5785.0058	5785.0045	5785.0028	5785.0004
-10	5785.0043	5785.0031	5785.0015	5784.9996
0	5785.0029	5785.0017	5784.9998	5784.9976
10	5785.0016	5785.0003	5784.9988	5784.9970
20	5785.0004	5784.9991	5784.9975	5784.9956
30	5784.9990	5784.9979	5784.9965	5784.9949
40	5784.9974	5784.9959	5784.9943	5784.9923
50	5784.9957	5784.9945	5784.9930	5784.9903
60	5784.9956	5784.9945	5784.9980	5784.9906
Max. Deviation (MHz)	0.0058	0.0055	0.0070	0.0097
Max. Deviation (ppm)	1.00	0.95	1.21	1.68
Result	Complies			

Mode: 40 MHz / Chain 1

Voltage vs. Frequency Stability

Voltage	Measurement Frequency (MHz)			
(V)	5190 MHz			
	0 Minute	2 Minute	5 Minute	10 Minute
126.50	5190.0060	5190.0046	5190.0028	5190.0007
110.00	5190.0048	5190.0035	5190.0019	5190.0000
93.50	5190.0034	5190.0023	5190.0011	5189.9989
Max. Deviation (MHz)	0.0060	0.0046	0.0028	0.0011
Max. Deviation (ppm)	1.16	0.89	0.54	0.21
Result	Complies			

Temperature vs. Frequency Stability

Temperature	Measurement Frequency (MHz)			
(°C)	5190 MHz			
	0 Minute	2 Minute	5 Minute	10 Minute
-20	5190.0102	5190.0089	5190.0072	5190.0048
-10	5190.0087	5190.0075	5190.0059	5190.0040
0	5190.0073	5190.0061	5190.0042	5190.0020
10	5190.0060	5190.0047	5190.0032	5190.0014
20	5190.0048	5190.0035	5190.0019	5190.0000
30	5190.0034	5190.0023	5190.0009	5189.9993
40	5190.0018	5190.0003	5189.9987	5189.9967
50	5190.0001	5189.9989	5189.9974	5189.9947
60	5190.0008	5189.9984	5189.9972	5189.9946
Max. Deviation (MHz)	0.0102	0.0089	0.0072	0.0053
Max. Deviation (ppm)	1.97	1.71	1.39	1.02
Result	Complies			

Voltage vs. Frequency Stability

Voltage	Measurement Frequency (MHz)			
(V)	5755 MHz			
	0 Minute	2 Minute	5 Minute	10 Minute
126.50	5755.0076	5755.0062	5755.0044	5755.0023
110.00	5755.0064	5755.0051	5755.0035	5755.0016
93.50	5755.0050	5755.0039	5755.0027	5755.0005
Max. Deviation (MHz)	0.0076	0.0062	0.0044	0.0023
Max. Deviation (ppm)	1.32	1.08	0.76	0.40
Result	Complies			

Temperature vs. Frequency Stability

Temperature	Measurement Frequency (MHz)			
(°C)	5755 MHz			
	0 Minute	2 Minute	5 Minute	10 Minute
-20	5755.0118	5755.0105	5755.0088	5755.0064
-10	5755.0103	5755.0091	5755.0075	5755.0056
0	5755.0089	5755.0077	5755.0058	5755.0036
10	5755.0076	5755.0063	5755.0048	5755.0030
20	5755.0064	5755.0051	5755.0035	5755.0016
30	5755.0050	5755.0039	5755.0025	5755.0009
40	5755.0034	5755.0019	5755.0003	5754.9983
50	5755.0017	5755.0005	5754.9990	5754.9963
60	5755.0017	5755.0007	5754.9980	5754.9969
Max. Deviation (MHz)	0.0118	0.0105	0.0088	0.0064
Max. Deviation (ppm)	2.05	1.82	1.53	1.11
Result	Complies			

Mode: 80 MHz / Chain 1

Voltage vs. Frequency Stability

Voltage	Measurement Frequency (MHz)			
(V)	5210 MHz			
	0 Minute	2 Minute	5 Minute	10 Minute
126.50	5210.0063	5210.0049	5210.0031	5210.0010
110.00	5210.0051	5210.0038	5210.0022	5210.0003
93.50	5210.0037	5210.0026	5210.0014	5209.9992
Max. Deviation (MHz)	0.0063	0.0049	0.0031	0.0010
Max. Deviation (ppm)	1.21	0.94	0.60	0.19
Result	Complies			

Temperature vs. Frequency Stability

Temperature	Measurement Frequency (MHz)			
(°C)	5210 MHz			
	0 Minute	2 Minute	5 Minute	10 Minute
-20	5210.0105	5210.0092	5210.0075	5210.0051
-10	5210.0090	5210.0078	5210.0062	5210.0043
0	5210.0076	5210.0064	5210.0045	5210.0023
10	5210.0063	5210.0050	5210.0035	5210.0017
20	5210.0051	5210.0038	5210.0022	5210.0003
30	5210.0037	5210.0026	5210.0012	5209.9996
40	5210.0021	5210.0006	5209.9990	5209.9970
50	5210.0004	5209.9992	5209.9977	5209.9950
60	5210.0004	5209.9977	5209.9976	5209.9547
Max. Deviation (MHz)	0.0105	0.0092	0.0075	0.0051
Max. Deviation (ppm)	2.02	1.77	1.44	0.98
Result	Complies			

Voltage vs. Frequency Stability

Voltage	Measurement Frequency (MHz)			
(V)	5775 MHz			
	0 Minute	2 Minute	5 Minute	10 Minute
126.50	5775.0067	5775.0053	5775.0035	5775.0014
110.00	5775.0055	5775.0042	5775.0026	5775.0007
93.50	5775.0041	5775.0030	5775.0018	5774.9996
Max. Deviation (MHz)	0.0066	0.0052	0.0034	0.0013
Max. Deviation (ppm)	1.15	0.91	0.60	0.23
Result	Complies			

Temperature vs. Frequency Stability

Temperature	Measurement Frequency (MHz)			
(°C)	5775 MHz			
	0 Minute	2 Minute	5 Minute	10 Minute
-20	5775.0109	5775.0096	5775.0079	5775.0055
-10	5775.0094	5775.0082	5775.0066	5775.0047
0	5775.0079	5775.0068	5775.0049	5775.0027
10	5775.0067	5775.0054	5775.0039	5775.0021
20	5775.0055	5775.0042	5775.0026	5775.0007
30	5775.0041	5775.0030	5775.0016	5775.0000
40	5775.0025	5775.0010	5774.9994	5774.9974
50	5775.0008	5774.9996	5774.9981	5774.9954
60	5775.0008	5774.9996	5774.9985	5774.9955
Max. Deviation (MHz)	0.0108	0.0095	0.0078	0.0054
Max. Deviation (ppm)	1.88	1.65	1.36	0.94
Result	Complies			

4.9. Antenna Requirements

4.9.1. Limit

Except for special regulations, the Low-power Radio-frequency Devices must not be equipped with any jacket for installing an antenna with extension cable. An intentional radiator shall be designed to ensure that no antenna other than that furnished by the responsible party shall be used with the device. The use of a permanently attached antenna or of an antenna that uses a unique coupling to the intentional radiator shall be considered sufficient to comply with the provisions of this Section. The manufacturer may design the unit so that the user can replace a broken antenna, but the use of a standard antenna jack or electrical connector is prohibited. Further, this requirement does not apply to intentional radiators that must be professionally installed.

4.9.2. Antenna Connector Construction

Please refer to section 3.3 in this test report; antenna connector complied with the requirements.

5. LIST OF MEASURING EQUIPMENTS

Instrument	Manufacturer	Model No.	Serial No.	Characteristics	Calibration Date	Remark
LISN	Schwarzbeck	NSLK 8127	8127650	9kHz ~ 30MHz	Nov. 23, 2016	Conduction (CO02-CB)
LISN	Schwarzbeck	NSLK 8127	8127478	9kHz ~ 30MHz	Nov. 15, 2016	Conduction (CO02-CB)
EMI Receiver	Agilent	N9038A	MY52260140	9kHz ~ 8.4GHz	Jan. 18, 2016	Conduction (CO02-CB)
Software	Audix	E3	6.120210n	-	N.C.R.	Conduction (CO02-CB)
Pulse Limiter	Schwarzbeck	VTSD 9561F	9561-F073	9kHz ~ 30MHz	Sep. 29, 2016	Conduction (CO02-CB)
BILOG ANTENNA with 6dB Attenuator	TESEQ & EMCI	CBL6112D & N-6-06	37880 & AT-N0609	20MHz ~ 2GHz	Aug. 30, 2016	Radiation (O3CH01-CB)
Horn Antenna	EMCO	3115	00075790	750MHz ~ 18GHz	Oct. 22, 2015	Radiation (O3CH01-CB)
Horn Antenna	Schwarzbeck	BBHA 9170	BBHA9170252	15GHz ~ 40GHz	Jul. 21, 2015	Radiation (O3CH01-CB)
Pre-Amplifier	Agilent	8447D	2944A10991	0.1MHz ~ 1.3GHz	Mar. 15, 2016	Radiation (O3CH01-CB)
Pre-Amplifier	Agilent	8449B	3008A02099	1GHz ~ 26.5GHz	Jan. 12, 2015	Radiation (O3CH01-CB)
Pre-Amplifier	WM	TF-130N-R1	923365	26GHz ~ 40GHz	Feb.10, 2015	Radiation (O3CH01-CB)
Spectrum Analyzer	R&S	FSP40	100056	9kHz ~ 40GHz	Oct. 27, 2015	Radiation (O3CH01-CB)
Spectrum Analyzer	R&S	FSP40	100056	9kHz ~ 40GHz	Nov. 21, 2016	Radiation (O3CH01-CB)
EMI Test	R&S	ESCS	100355	9kHz ~ 2.75GHz	May 16, 2016	Radiation (O3CH01-CB)
RF Cable-low	Woken	Low Cable-16+17	N/A	30 MHz ~ 1 GHz	Oct. 24, 2016	Radiation (O3CH01-CB)
RF Cable-high	Woken	High Cable-16	N/A	1 GHz ~ 18 GHz	Nov. 02, 2015	Radiation (O3CH01-CB)
RF Cable-high	Woken	High Cable-17	N/A	1 GHz ~ 18 GHz	Nov. 02, 2015	Radiation (O3CH01-CB)
RF Cable-high	Woken	High Cable-40G-1	N/A	18GHz ~ 40 GHz	Nov. 02, 2015	Radiation (O3CH01-CB)
RF Cable-high	Woken	High Cable-40G-2	N/A	18GHz ~ 40 GHz	Nov. 02, 2015	Radiation (O3CH01-CB)
Loop Antenna	Teseq	HLA 6120	24155	9kHz - 30 MHz	Mar. 16, 2016*	Radiation (10CH01-CB)
Spectrum analyzer	R&S	FSV40	100979	9kHz~40GHz	Dec. 12, 2014	Conducted (TH01-CB)
Temp. and Humidity Chamber	Ten Billion	TTH-D3SP	TBN-931011	-30~100 degree	Jun. 02, 2015	Conducted (TH01-CB)
RF Cable-high	Woken	RG402	High Cable-7	1 GHz – 26.5 GHz	Nov. 02, 2015	Conducted (TH01-CB)
RF Cable-high	Woken	RG402	High Cable-8	1 GHz – 26.5 GHz	Nov. 02, 2015	Conducted (TH01-CB)
RF Cable-high	Woken	RG402	High Cable-9	1 GHz – 26.5 GHz	Nov. 02, 2015	Conducted (TH01-CB)
RF Cable-high	Woken	RG402	High Cable-10	1 GHz – 26.5 GHz	Nov. 02, 2015	Conducted (TH01-CB)
RF Cable-high	Woken	RG402	High Cable-6	1 GHz – 26.5 GHz	Nov. 02, 2015	Conducted (TH01-CB)
Power Sensor	Agilent	U2021XA	MY53410001	50MHz~18GHz	Nov. 02, 2015	Conducted (TH01-CB)

Note: Calibration Interval of instruments listed above is one year.

“*” Calibration Interval of instruments listed above is two years.

N.C.R. means Non-Calibration required.

6. MEASUREMENT UNCERTAINTY

Test Items	Uncertainty	Remark
Conducted Emission (150kHz ~ 30MHz)	3.2 dB	Confidence levels of 95%
Radiated Emission (30MHz ~ 1,000MHz)	3.6 dB	Confidence levels of 95%
Radiated Emission (1GHz ~ 18GHz)	3.7 dB	Confidence levels of 95%
Radiated Emission (18GHz ~ 40GHz)	3.5 dB	Confidence levels of 95%
Conducted Emission	1.7 dB	Confidence levels of 95%
Output Power Measurement	1.33 dB	Confidence levels of 95%
Power Density Measurement	1.27 dB	Confidence levels of 95%
Bandwidth Measurement	9.74×10^{-8}	Confidence levels of 95%
Frequency Stability	6.06×10^{-8}	Confidence levels of 95%

Appendix B. Radiated Emission Co-location Report

1. Results of Radiated Emissions for Co-located

Temperature	25°C	Humidity	58%
Test Engineer	Owen Hsu	Configurations	2.4GHz + 5GHz

Horizontal

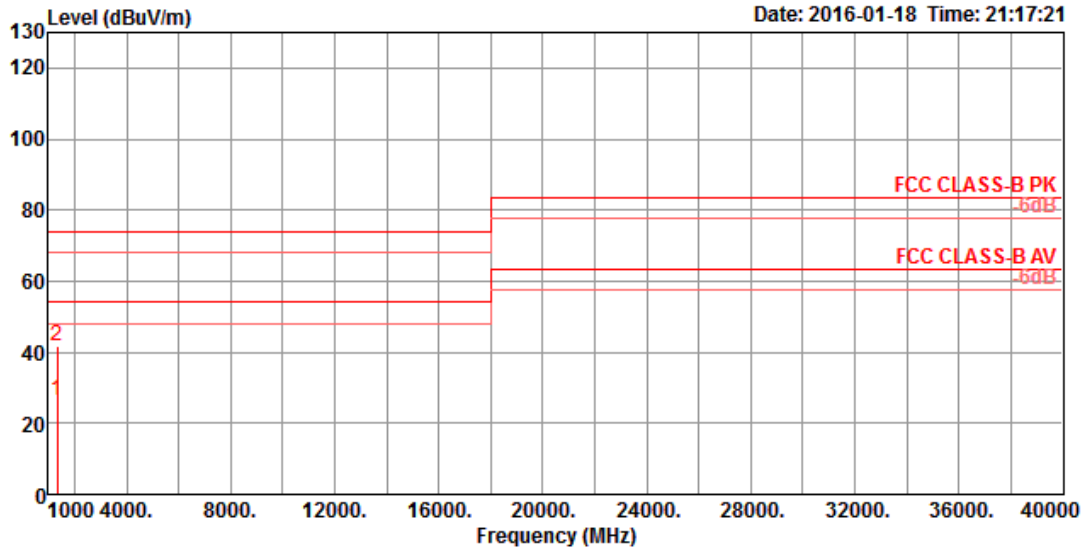

	Freq	Level	Limit	Over	Read	Cable	Preamp	Antenna		T/Pos	A/Pos	Remark
	MHz	dBuV/m	dBuV/m	dB	dBuV	dB	dB	dB/m	Pol/Phase	deg	cm	
1	1327.20	26.50	54.00	-27.50	33.00	4.31	35.87	25.06	HORIZONTAL	224	121	Average
2	1328.30	41.87	74.00	-32.13	48.35	4.31	35.85	25.06	HORIZONTAL	224	121	Peak

Vertical

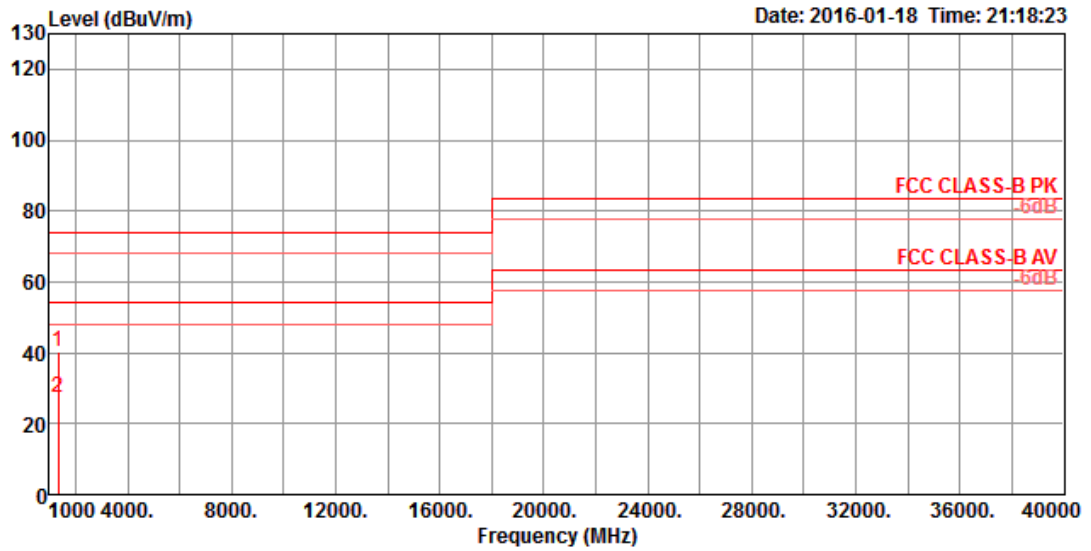

	Freq	Level	Limit	Over	Read	Cable	Preamp	Antenna		T/Pos	A/Pos	Remark
	MHz	dBuV/m	dBuV/m	dB	dBuV	dB	dB	dB/m	Pol/Phase	deg	cm	
1	1321.10	40.46	74.00	-33.54	47.01	4.29	35.89	25.05	VERTICAL	321	123	Peak
2	1321.11	27.42	54.00	-26.58	33.97	4.29	35.89	25.05	VERTICAL	321	123	Average