

# Kidsneed

## BABY MONITOR SM935A

(Digital Wireless Video Baby Monitor With 3.5 inches Color Screen)

### USER MANUAL



**KIDS NEED TO BE SAFE**

## **Thanks for Choosing Kidsneed:)**

We provide 24h Professional Service Center.

Lifetime Manufacturer's Technical Support.

And 30 Days Money-Back Service.

Ensures Long-lasting Enjoyment of Your Purchase.

If you have any questions,feel free to contact us.

Scan the QR Code & Start Chatting

USE YOUR PHONE  
CAMERA TO SCAN ME

support@kidsneed.top



## **Congratulation!**

Now you can take care of your babies anywhere and anytime!

Please read the user manual before use!

Please retain your original dated sales receipt for your to records.

For warranty service of your baby monitor, you will need to provide a copy of your dated sales receipt to confirm warranty status. Registration is not required for warranty coverage.

Before you use the product, we recommend you fully charge the battery in the parent unit, so that it continues to work so that it continues to work even when disconnected from the power supply for transferring to another location.

Please read the safety instructions.

Please make sure you have the following in the packing.

1. Parent unit x 1
2. Baby unit x 1
3. Adapter x 2
4. User manual x 1
5. Wall mount shim x 1

## 1. SAFETY INSTRUCTIONS :

**CAUTION:** Keep small parts away from children.

**Strangulation Hazard:** Children can become entangled in cords. Power cords should be kept more than 3 feet away from the crib and baby's reach all the time. Baby monitors and cameras with power cords should never be hung on or near the crib. This product is not a toy and should be kept out of children's reach. This product contains small parts. Be care when unpacking and assembling the product.

**Read and keep instructions:** All the safety and operating instructions should be read before the video baby monitor is operated.

**This product cannot replace responsible adult supervision.**

**Water and moisture:** This product is designed for indoor use only. The unit should not be exposed to rain, moisture, dripping or splashing. No objects filled with liquid should be placed on top of, or beside the product, such as a glass or vase. This item should not be used near water.

**DO NOT USE THE APPLIANCE:**

- If the cord or plug is damaged.
- If your baby monitor is not operating properly or has suffered any damage.

**Contact service:** The service center to request inspection and repair it in order to avoid any possible risk.

**DO NOT:** Attempt to repair or adjust any of the electrical or mechanical functions of the unit since, if you do, the guarantee will be made void.

**Ventilation:** This baby monitor should not be used on a bed, sofa, rug or similar surface that may block the ventilation openings, or be placed in an

enclosed area, such as a bookcase or drawer that may impede air flow.

**Keep away from sources of heat:** This unit should not be exposed to direct heat sources such as a candle, replace, radiator, heat register, stove or other appliance that emits heat. The unit should not be left in direct sunlight.

**Power source:** This unit should only be used with the adapter included in this package.

**Damage requiring service:** This unit should be serviced by qualified personnel.

 **WARNING: IR emitted from this product. Do not stare at operating lamp !!**

 **CAUTION: RISK OF EXPLOSION IF BATTERY IS REPLACED BY AN INCORRECT TYPE. DISPOSE OF USED BATTERIES ACCORDING TO THE INSTRUCTIONS.**

#### FCC STATEMENTS:

**This device complies with part 15 of the FCC Rules. Operation is subject to the following two conditions:**

- (1) This device may not cause harmful interference.
- (2) This device must accept any interference received, including interference that may cause undesired operation.

**NOTE 1:** This equipment has been tested and found to comply with the limits for a Class B digital device, pursuant to part 15 of the FCC Rules. These limits are designed to provide reasonable protection against harmful interference in a residential installation.

This equipment generates, uses and can radiate radio frequency energy and

if not installed and used in accordance with the instructions, may cause harmful interference to radio communications. However, there is no guarantee that interference will not occur in a particular installation. If this equipment does cause harmful interference to radio or television reception, which can be determined by turning the equipment off and on, the user is encouraged to try to correct the interference by one or more of the following measures:

- Reorient or relocate the receiving antenna.
- Increase the separation between the equipment and receiver.
- Connect the equipment into an outlet on a circuit different from that to which the receiver is connected.
- Consult the dealer or an experienced radio/TV technician for help.

**NOTE 2:** Any changes or modifications to this unit not expressly approved by the party responsible for compliance could void the user's authority to operate the equipment.

## **FCC WARNING**

This equipment has been tested and found to comply with the limits for a Class B digital device, pursuant to Part 15 of the FCC Rules. These limits are designed to provide reasonable protection against harmful interference in a residential installation. This equipment generates, uses and can radiate radio frequency energy and, if not installed and used in accordance with the instructions, may cause harmful interference to radio communications. However, there is no guarantee that interference will not occur in a particular installation. If this equipment does cause harmful interference to radio or

television reception, which can be determined by turning the equipment off and on, the user is encouraged to try to correct the interference by one or more of the following measures:

- Reorient or relocate the receiving antenna.
- Increase the separation between the equipment and the receiver.
- Connect the equipment into an outlet different from that to which the receiver is connected.
- Consult the dealer or an experienced radio/TV technician for help.

**IC STATEMENTS:**

This device complies with Industry Canada licence-exempt RSS standard(s):

Operation is subject to the following Two conditions:

- (1) This device may not cause interference.
- (2) This device must accept any interference, including interference that may cause undesired operation of the device.

## 2. WARRANTY TERMS

We take quality very seriously. This is why all of our products come with one year warranty from the original purchase date against defects in workmanship and materials. If you have warranty or support issues please contact [support@kidsneed.top](mailto:support@kidsneed.top). We will definitely give you a satisfactory solution.

## 3. Important guidelines for installing your baby monitor

To use your parent unit and baby unit together, you must be able to establish a radio link between them, and the range will be affected by environmental conditions.

Any large metal object, like a refrigerator, a mirror, a filing cabinet, metallic doors or reinforced concrete between the baby and parent unit may block the radio signal.

The signal strength may also be reduced by other solid structures, like walls, or by radio or electrical equipment, such as TV, computers, cordless or mobile phones, fluorescent lights or dimmer switches.

Use of other 2.4GHz products, such as wireless networks (Wi-Fi routers), Bluetooth systems, or microwave ovens, may cause interference with this product, so keep the baby monitor away at least 5ft(1.5m) from these types of products, or turn them off if they appear to be causing interference.



## 4. PRODUCT OVERVIEW

### 4.1 What's included:

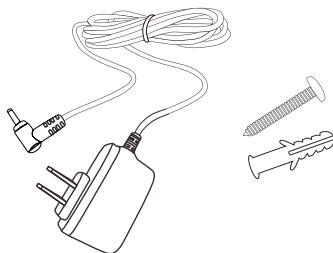
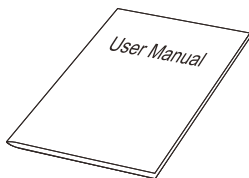
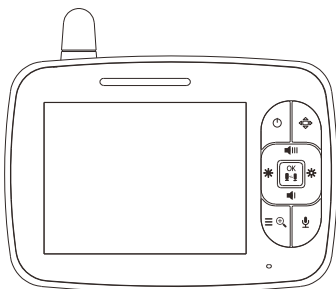
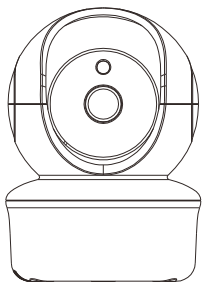

1. Parent unit x 1
2. Baby unit x 1
3. Adapter x 2

4. User manual x 1

## 4.2 Parent Unit (Monitor)

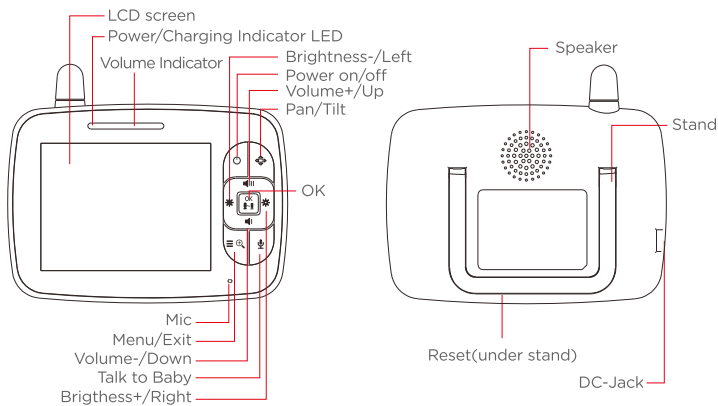



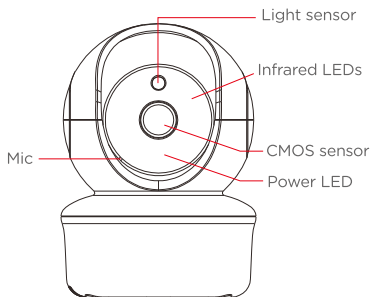

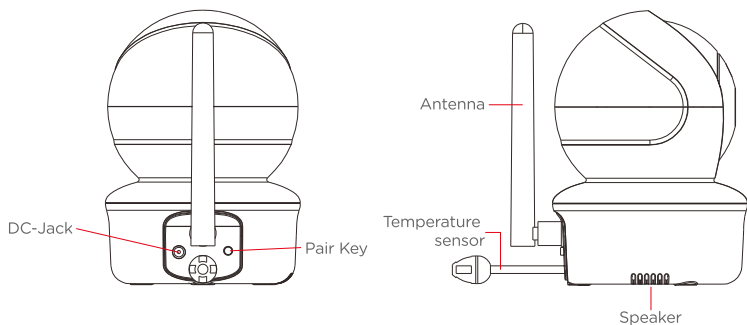







## 4.3 Baby Unit (Camera)





## 4.4 Icons Overview:

	Signal		Volume		Zoom
	Alarm		Brightness		Night vision
	Lullaby		ECO		Talk to baby
	Camera		Battery		78°F Temperature

## 5. PLACEMENT OF THE BABY MONITOR

Aim to provide the viewing area: Select a location for the baby unit that provides a clear view of the area you want to monitor, which is free from dust, and is not in line -of- sight to a strong light source or direct sunlight. Avoid installing the baby unit where there are thick walls or obstructions between the camera and the monitor.

STRANGULATION HAZARD--keep cord out of child's reach.

Never place camera or cords within 3 feet of crib or playpen. NEVER use extension cords with adapter, only use the adapter provided.

## 6. USING THE BABY MONITOR

### 6.1 TURN ON THE BABY UNIT:

Only use the adapter included in this package.

Use the provided adapter to connect the wall outlet with the baby unit.

Once the adapter connects then the unit will turn on automatically and the power LED will light up.

### 6.2 TURN ON THE PARENT UNIT:

Only use the adapter included in this package.

The parent unit is supplied with a built-in rechargeable Li-ion battery. We suggest connecting the monitor to the adapter plugged into the mains whenever possible to keep the battery charged.

Press and hold the power key  5 seconds on the Parent Unit.

Once parent unit turned on , the power LED will light up and the image will display on the LCD screen.

### 6.3 CHARGING THE PARENT UNIT:

Connect the adapter to the Parent Unit.

Plug the adapter into the wall outlet.

When Parent Unit is turned off, charging LED on the Parent Unit will light in RED.

When Parent Unit is turned on, the charging LED will light in ORANGE and battery charging icon(charging bars) will appear at the top right corner of the LCD screen.

It takes about 8 hours to fully charge the battery.

Full battery indicator(4 fixed bars) will appear at the top right corner of the LCD screen, indicating the battery is fully charged.

**Note:** Before the first use or after a long product storage, it is recommended to fully charge the Parent Unit battery prior to operating the monitor.

## 7. OSD MODE OPERATION

### 7.1 PARENT UNIT SCREEN ON/OFF

Under the boot state, short press the power key  to turn on / off the screen.

### 7.2 VOLUME ADJUSTMENT

Under the boot state, press the UP key  to increase the volume.

Under the boot state, press the DOWN key  to decrease the volume.

### 7.3 BRIGHTNESS ADJUSTMENT

Under the boot state, press the Left key  to decrease the brightness.

Under the boot state, press the Right key  to increase the brightness.

### 7.4 DIGITAL ZOOM & PAN / TILT

Press and hold Menu/Exit key   around 2 seconds to operate.

At the Zoom mode, press the LEFT key  RIGHT key  UP key 

DOWN key  to Pan/Tilt the image.

During digital zoom mode, the zoom icon will be displayed on the top of screen.

**Warm reminder:** If you want to adjust the Volume/Brightness, you have to exit the Zoom mode before you operate it.

## 7.5 CAMERA VIEW / SCAN

**(This function is only available when two or more cameras paired)**

Press OK key  to view / scan camera.

During scan mode, the scan icon  will be displayed on the top of LCD screen and each paired camera (when more than one camera is paired) will be displayed on the screen for approx 10 seconds and then will automatically change to the next paired camera.

## 7.6 TALK TO BABY

To talk, press and hold the talk key  on the front of the monitor.

Release the button when you finish talking to start listening to the sound from your baby's room.

While the "TALK TO BABY" function is in use, there is no possibility to hear the sounds from the Baby Unit. Releasing the talk key, allows hearing the sounds from the baby's room again.

## 7.7 INFRARED NIGHT VISION (Automatic)

The infrared night vision function allows the camera to pick up images of your baby or the monitored area in dark or low light conditions.

In this mode, only black and white images will be displayed on the monitor, the optimum image is 6 feet distance between baby unit and object.

## 8. MENU OPERATION







### 8.1 ECO SETTING

This mode allows you to control the sound activation of your baby monitor. The ECO default setting is OFF. If there is no sound around the camera within 30 Seconds, it will stops transmitting.

The monitor screen turns off when the camera is not transmitting.









When the camera detects the sound is louder than set sensitivity level, it will start transmitting the signal to the monitor again.

To change the ECO level, please follow the next instructions:

1. Press the Menu/Exit key  and the menu will pop up.
2. Press the LEFT key  or RIGHT key  until the ECO icon is highlighted then press UP key  or DOWN key  to select desired level.
3. Press OK key  to confirm.
4. Press the Menu/Exit key  to Exit.

### 8.2 ALARM SETTING

You can use the alarm to remind yourself to feed baby /change diapers / sleep, etc.

1. Press the Menu/Exit key  and the menu will pop up.
2. Press the LEFT key  or RIGHT key  until the alarm icon  is highlighted.
3. Press UP key  to increment or press DOWN key  to decrement.
4. Press OK key  to confirm.
5. Press the Menu/Exit key  to Exit.







**Note:** If the alarm is ringing and no one answers, the ringing will last 1 minute, after 3minutes the ringing will start again.

The ringing will sound up three times total if no one answers.









### 8.3 LULLABY SETTING







You can soothe the baby to sleep by playing a gentle lullaby from the baby unit.

1. Press the Menu/Exit key  and the menu will pop up.
2. Press the LEFT key  or RIGHT key  until the lullaby icon is highlighted.
3. Press UP key  or DOWN key  to select.
4. Press OK key  to confirm.
5. Press the Menu/Exit key  to Exit.







### 8.4 PAIRING THE CAMERA AND MONITOR

1. Press the Menu/Exit key  then the menu will pop up.
2. Press the LEFT key  or RIGHT key  until the camera icon is highlighted then press UP key  or DOWN key  to select the desired camera to pair.
3. Press OK key  to start the pairing.
4. While the LED is flashing then press the PAIR button on the back of camera.
5. Once paired, then the screen will display the image from the camera.
6. If unsuccessful, please repeat above steps.

### 8.5 TEMPERATURE UNIT SETTING

1. Press the Menu/Exit key  and the menu will pop up.
2. Press the LEFT key  or RIGHT key  until the temperature icon is highlighted.
3. Press UP key  or DOWN key  to select between °C or °F.
4. Press OK key  to confirm.
5. Press the Menu/Exit key  to Exit.

## 8.6 Video Pan/Tilt

1. Press the shot-cut key  enter into the Pan/Tilt mode.
2. Press  or key  to Tilt the video.
3. Press  or key  to Pan the video.
4. Press the shot-cut key  to exit the Pan/Tilt mode.

**Note:** During the Pan/Tilt mode can not use the navigation key to adjust Volume and brightness.

## 9. TECHNICAL DATA

### 9.1 System General

Frequency	2.4GHz FHSS
Operation Environment	Indoor use only; Temperature: 0-40 °C ; Humidity: 5% to 90% rh. ( relative humidity)
Operating Range	Up to 900 feet (straight line and open space)
Power adapter	Input: 100-240VAC 50 / 60Hz, 300mA Max Output: 5V, 700mA
LCD	3.5" LCD Screen
Rechargeable battery for monitor	Model: 503450; 3.7V, 1200 mAh
Operating time with battery fully charged (parent unit)	Up to 12 hours (ECO on)
Image sensor type	1/6.5" Color CMOS image sensor
IR LED Type	940 nm

## 10. TROUBLE SHOOTING

<p>No reception on the monitor</p>	<p><b>1. The power adapters may not be properly connected.</b> Confirm that the camera and monitor are ON. See item 2 “Getting started”, connect the baby unit in the right way. If it is still unconnected, choose another baby unit to connect.</p> <p><b>2. The baby unit may be too far from the parent unit.</b> Keep the distance between the baby unit and the parent unit with 900 feet (open space).</p> <p><b>3. The baby unit and parent unit may not be properly paired.</b> Following the Pairing instructions.</p> <p><b>4. If the above strategies do not work, restart the parent unit.</b> At the back of the parent unit (under the stand) you will see a small black hole marked “Reset”. Just take a sharp object and press the reset button for a few seconds.</p>
<p>Interference or Poor Reception</p>	<p><b>1. The baby unit may be too far from the parent unit.</b> Keep the distance between baby unit and parent unit in 900 feet (open space).</p> <p><b>2. The baby unit or the parent may be placed too close to metal objects.</b> Keep the metal objects at least 5 feet away from the parent unit. In most cases it is even enough to move them about 8-10 inch away</p> <p><b>3. Other electronic devices may be interfering with signal.</b> Keep the electronic devices at least 5 feet away from the parent unit. In most cases it is even enough to move them about 8- 10 inches away.</p> <p><b>4. The battery power may be too low.</b> Full charge the parent unit with AC adapter provided</p> <p><b>5. If the above strategies do not work, restart the parent unit.</b></p>

A high-pitched Noise is Heard	<p><b>1. The baby unit and parent unit may be place too close together.</b> Keep the distance between parent unit and the baby unit.</p> <p><b>2. The volume on the parent unit may be set too high.</b> Turn down the volume on the parent unit.</p> <p><b>3. If the above strategies do not work, restart the parent unit.</b></p>
No Sound on the Parent Unit	<p><b>1. Volume may be set too low.</b> Turn up the volume on the parent unit.</p> <p><b>2. If the above strategies do not work, restart the parent unit.</b></p>
Image Freezes	<p>Restart the baby unit(plug out the adapter then plug it into the socket again) Press the reset key at the back of the parent unit(hide behind the stand)</p>
Temperature is Inaccurate	<p><b>1. The temperature sensor is positioned very close to the baby unit and when it warms up during operation.</b> Stretch out the sensor so it would be far enough from the baby unit Place the baby unit in an area with good air circulation.</p> <p><b>2. If the above strategies do not work, restart the parent unit.</b></p>
Can not Connect with Multiple Baby Unit	<p><b>1. Pair the baby unit in wrong ways.</b> Refer to 3.1 Paring More than one baby unit with parent unit.</p> <p><b>2. If the above strategies do not work, restart the parent unit.</b></p>
<p>If the above suggestions can't help you solve the problem, contact us for professional solutions. Any questions or problems let us know! Customer service e-mail address: <a href="mailto:support@kidsneed.top">support@kidsneed.top</a></p>	

## 11. MAINTENANCE

Clean the surfaces of the camera and monitor with a soft, fluff-free cloth.  
Never use cleaning agents or solvents.

If the units become dirty, use a lightly dampened cloth to wipe surfaces,  
taking care to not allow water into any openings.

# Kidsneed

All rights reserved

The features described in user's manual are subject to modifications without prior notice.



**WARNING**

**Keep the small parts away from children**



# Kidsneed

For support and warranty, please visit

 <https://kidsneed.top>

We will respond all inquires within 24 hours.



Need Help?  
Scan QR Code & Send mail  to us



Printed in China

 [support@kidsneed.top](mailto:support@kidsneed.top)

 [www.kidsneed.top](http://www.kidsneed.top)