

Makerfire

GHOST II



Product Introduction

Makerfire Technology Co., Ltd.

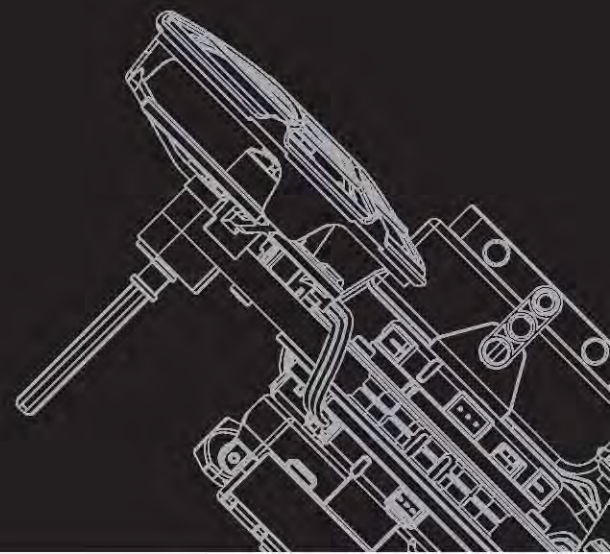

Contents

1

Product Introduction

- P02 STEAM Education
- P03 Aerial drone-Ghost
- P04 Flight Controller
- P05 Smart Driver
- P06 Application Docking Station
- P07 LiPo Battery Management
- P08 Battery Charging Guide
- P11 Operation Guide

2

Graphical Programming

- P21 Computer Programming
- P29 Graphical Programming

3

Application Extension

- P31 Six-axis / Eight-axis Expansion
- P37 3D Indoor Positioning Technology

- P38 Example for Application Docking Station

4

Frequently Asked Questions

- P40 Other aspects



1 product
description



STEAM Education



STEAM education is the new style teaching way which mixed with Science, Technology, Engineering, Art and Maths. It emphasizes on motivating students' imagination and creativity, also improving the ability of thinking, solving the problem and cooperation.

STEAM education is the quality-oriented education indeed, which was originated from United States and now spreads all over the world.

Aerial drone- Ghost

Ghost is a STEAM Educational aerial drone kit, customized for 8-16 years old students and can enhance their creative thinking.

Ghost is compatible with LEGO machinery parts, and it is including the powerful brushless system and built-in ultrasound and Optical flow sensor.

Students can learn the drone structure, assemble Schematic, and get a deeper understanding about the aerial drone by the online/offline graphical programming.

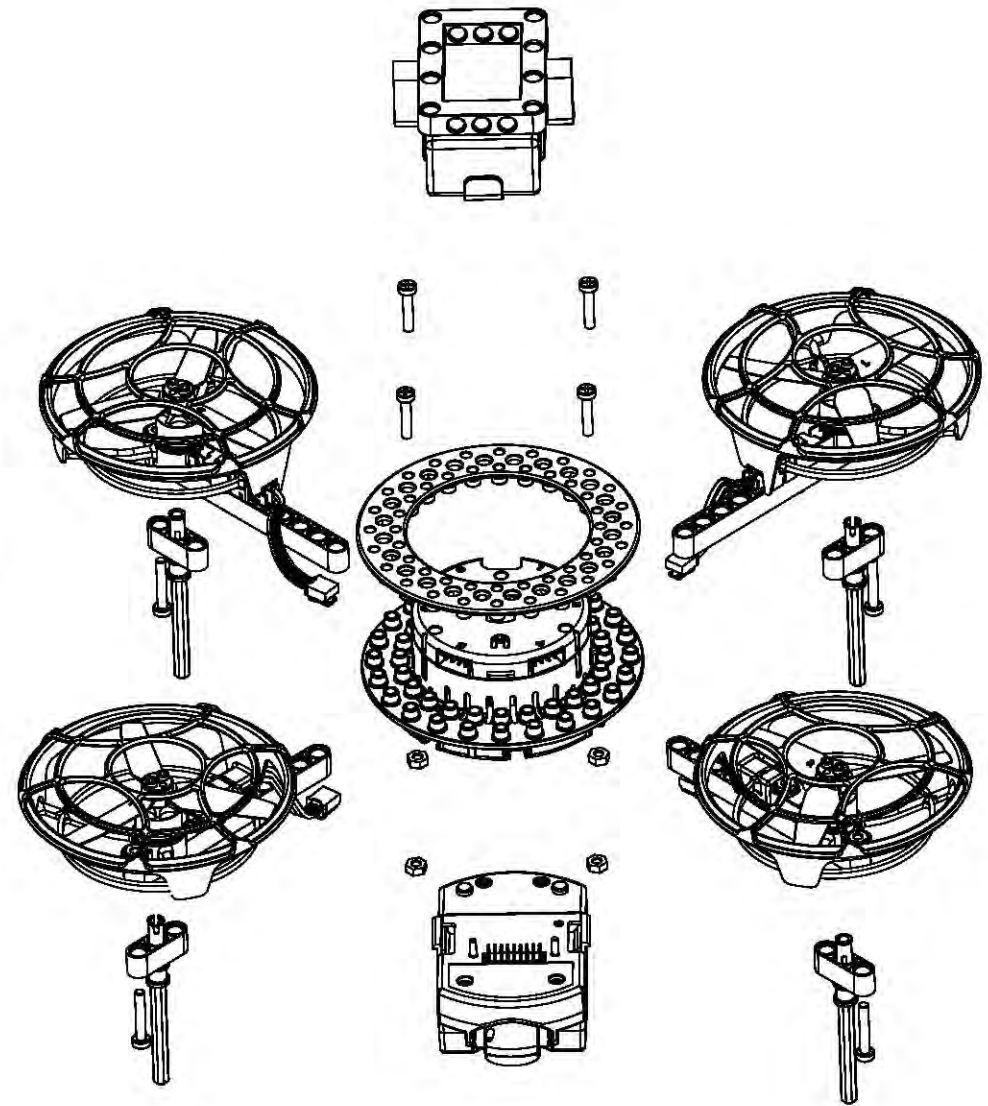

Flight Controller

Camera

Optical Flow Sensor Module

Ultrasonic Module

Indicator Light

Power Switch

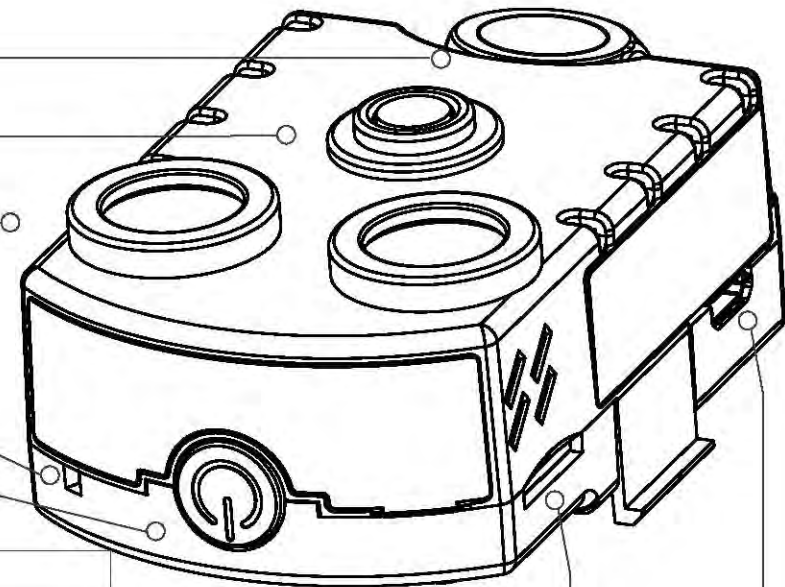

Micro USB

SD Card

Green Light solid: Take off waiting (Attitude hold and fixed point function)
Green Light flash slow: One-key landing(Fixed point movement)
Blue light flash: Photography mode (It can be take photo anytime)
Blue light flash fast: SD card failure
Blue light flash slow: Record mode(video recording)
Red light flash slow: Fail to connect (fail to connected with remote control or APP, fail to binding, no signal)
Red light flash fast: Low voltage protection landing automatically/Low voltage
Red light solid: System crash/System major failure
Red light and green light flash alternately: Sensor abnormality (Calibration fail, Optical flow/Ultrasonic/ Barometer abnormal, etc.)
Blue light and green light flash alternately: Gyroscope on the calibration
Red light and blue light flash alternately: Special flight mode(switch to sport mode, 360°flip, spin, etc.)

Failsafe: When the remote control loses the signal or exits abnormally from the APP, Ghost will land automatically to the ground.

Low voltage protection: When the battery voltage is lower than 10.5V, Ghost will activate the low voltage protection system, land automatically, and buzzer keeps buzzing.

Smart Driver

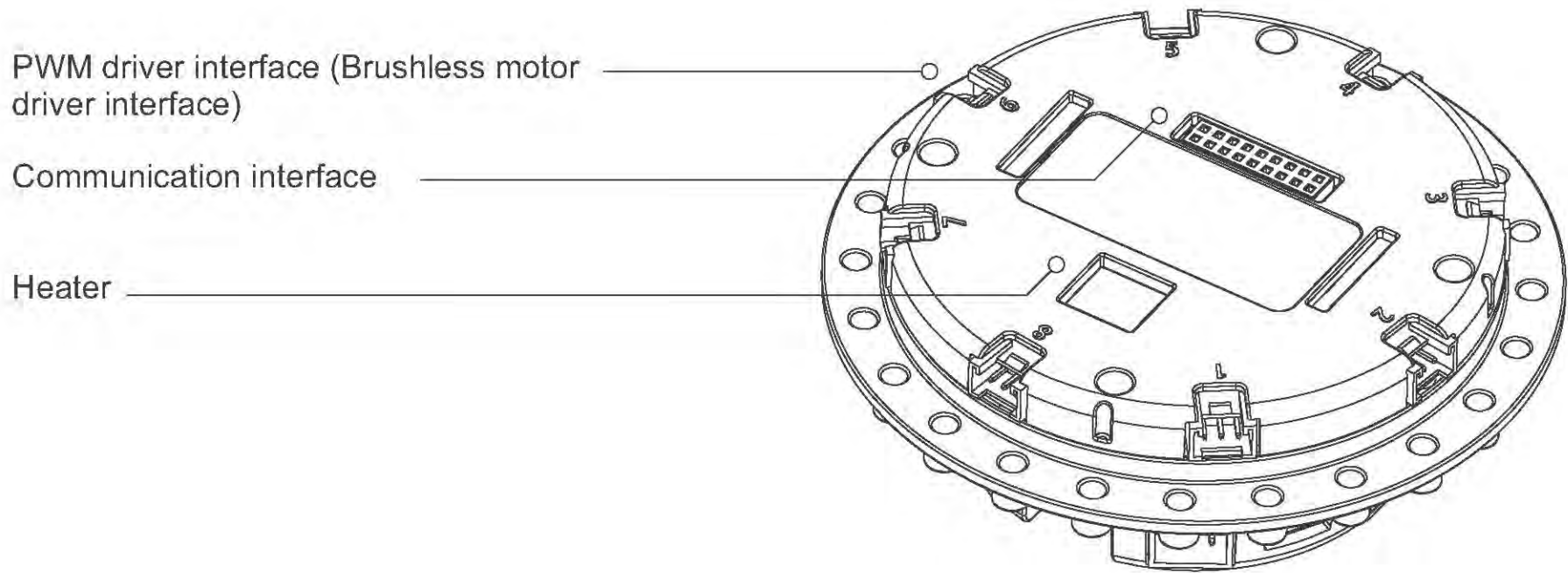

Smart driver can drive brushless motor and connect the hardware through the adapter cable and brushless power system;
The 1-way maximal current is 12A and the maximal brushless motor drive is 8-way, the PWM driver interface can activate interface based on the customized mapping of Ghost in the Scratch.

Application Docking Station

Power interface

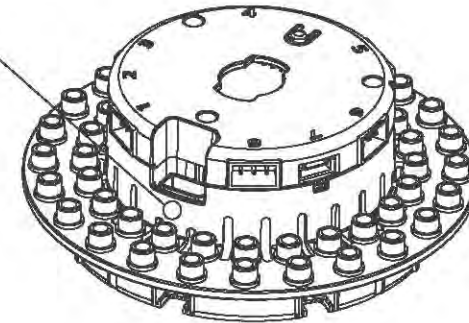

Expanding Interface Number	Type of the interface
No. 1 and No. 8	Digital IO port
No. 2	UART 2
No. 3 and No. 6	Analog IO port
No. 4 and No. 5	PWM output port
No. 7	IIC

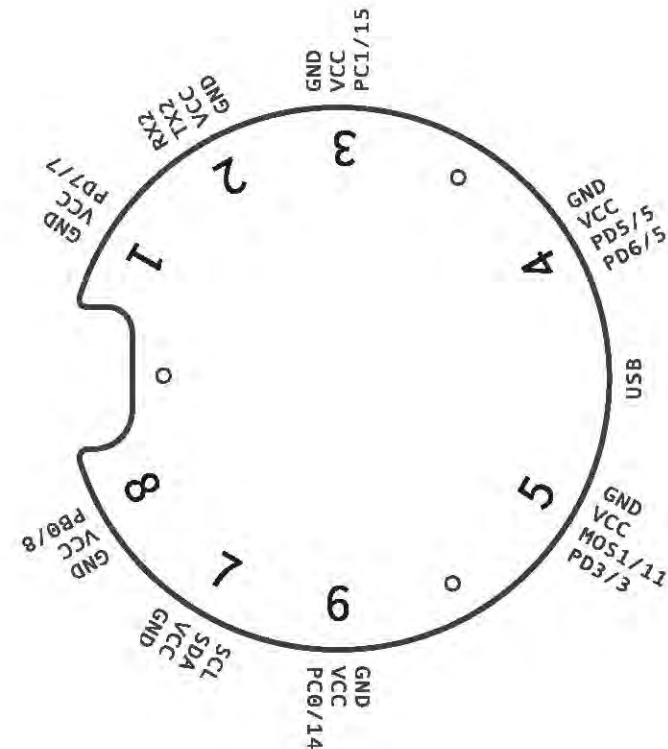

LiPo Battery Management

Caution:

1. Do NOT insert the anode and Cathode of the battery directly into the battery socket.
2. Do NOT short the battery, it will cause serious damage to the battery.
3. Do NOT transport the battery with metal.
4. Do NOT throw, tread, strike and take the battery apart.
5. Do NOT solder the battery without any protection or use other sharp weapon to impale the battery.
6. Do NOT charge the battery without any monitor.

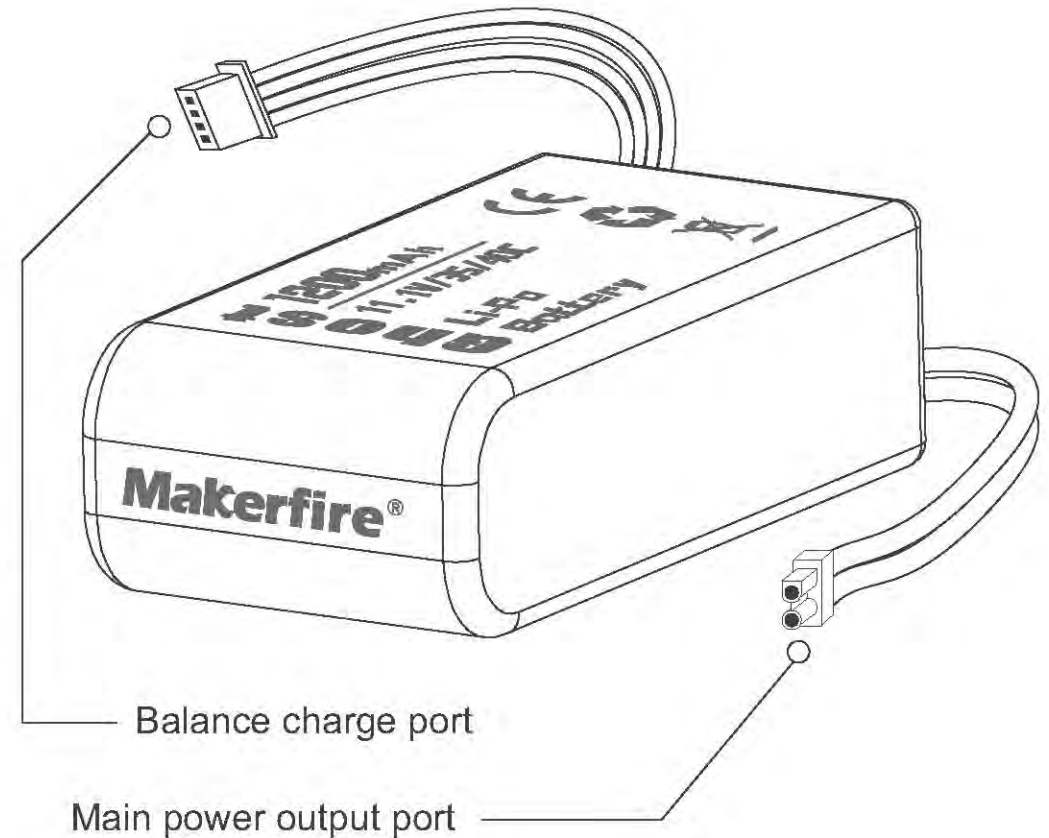

Battery Charging Guide-The use of the charger

Battery configuration of Ghost: 3s LiPo Battery

Indicator status description

Red light and green light flash alternately	Ready to charge (stand by)
Red light solid	Electricity <25%
Red light flash	Electricity 25%-50%
Yellow light flash	Electricity 50%-75%
Green light flash	Electricity 75%-99%
Green light solid	Fully charged

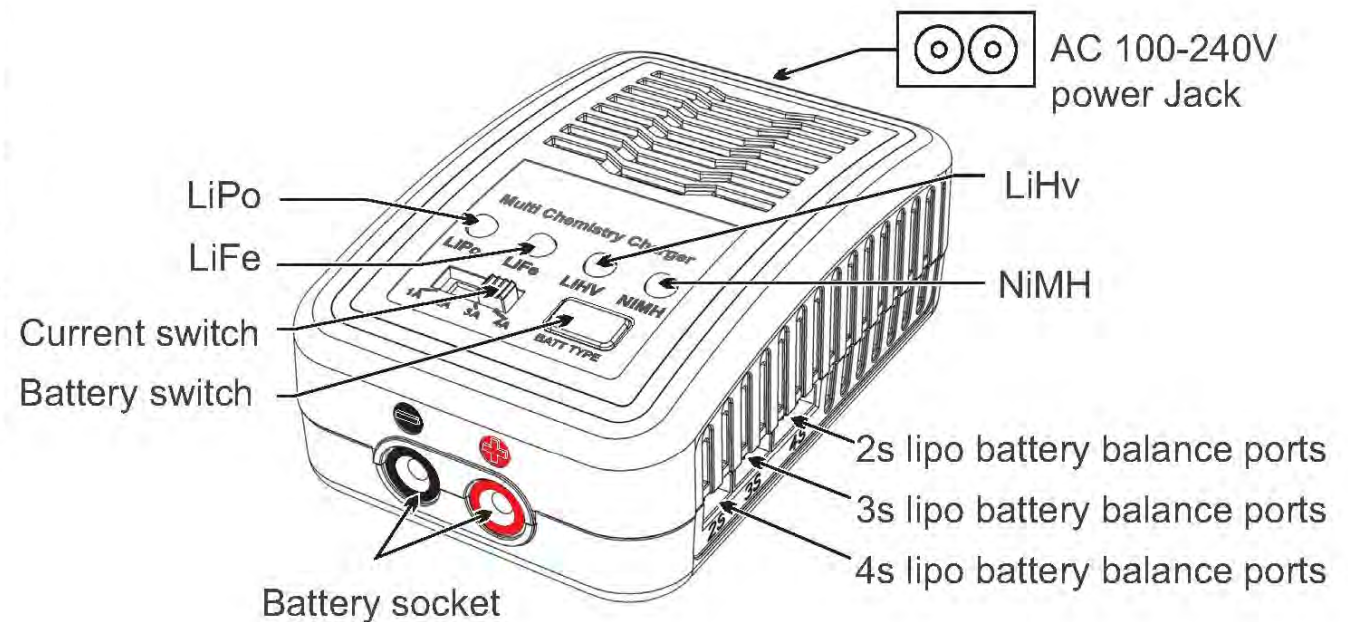

Battery Charging Guide-The use of the charger

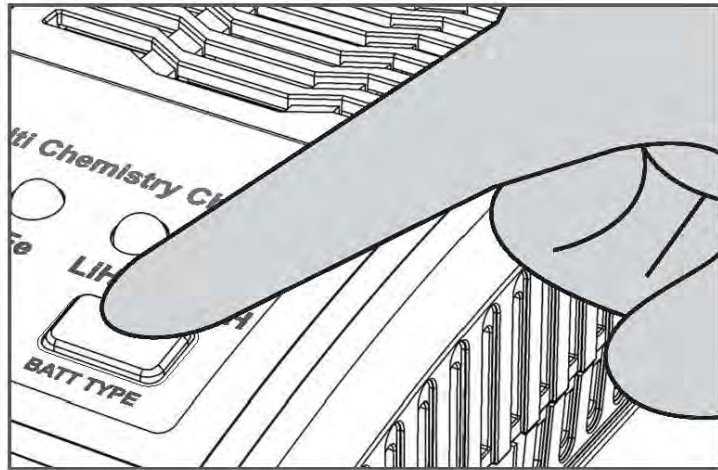

Battery type switch

Press the "BATT TYPE" to switch battery type cyclically. Set the LiPo mode when charging the Ghost battery.

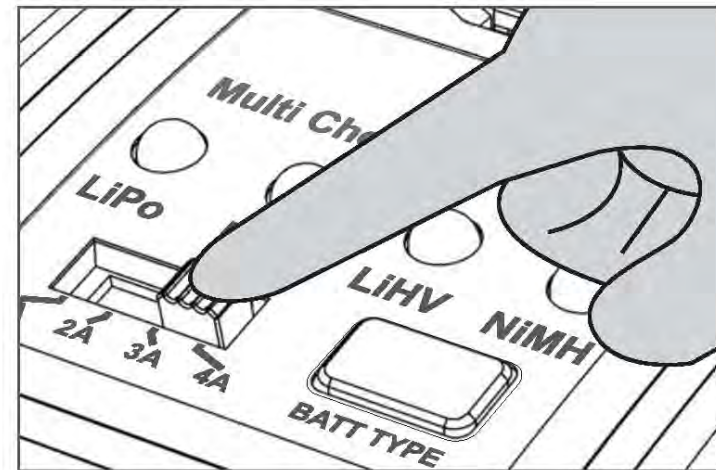

Current switch

Toggle the switch manually to switch 4-level charging current, the max current input is 4A.

Battery Charging Guide-The use of the charger

Wire connection and charging settings:

- 1) Insert the AC power cord into the charger and insert the plug as tight as possible to ensure a good connection
- 2) Set the charging type to LiPo mode
- 3) Set the charging current; Choose the current setting from 1-4A, we kindly recommend set it to 2A.
- 4) Insert the switch cable, the black one is anode, which corresponding to the black socket "-"; The red one is cathode, which corresponding to the red socket "+"; Please insert the plug as tight as possible to ensure a good connection.
- 5) Insert the white blank sprt into the "3s" port(it is in the middle), and 4 of the LED light should be all in flashing state.
- 6) Insert the dynamic electricity to the XT30 port and 4 of the LED will be change to "LiPo" lighting solid.

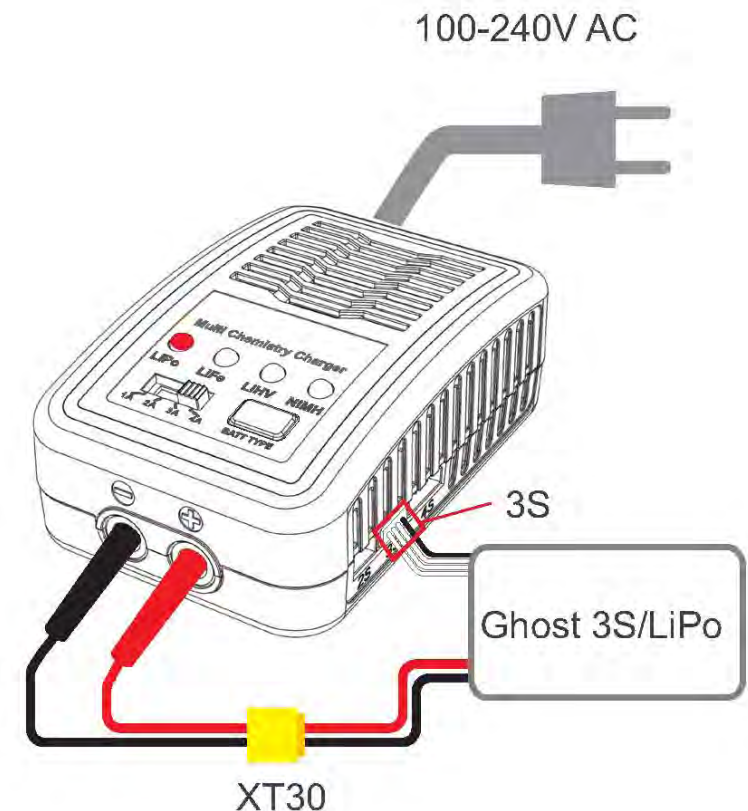

Caution:

- 1) Switch cable will takes the risk of short circuit, please disconnect the XT30 port before you take the battery.
- 2) The battery charge mode that you set must be matched with the battery types
- 3) Please keep the battery charger in ventilation place, do Not cover it by any flammable object(towel, chothes etc.)
- 4) Do NOT charge the battery without look after.

Operation Guide-Radio Transmitter

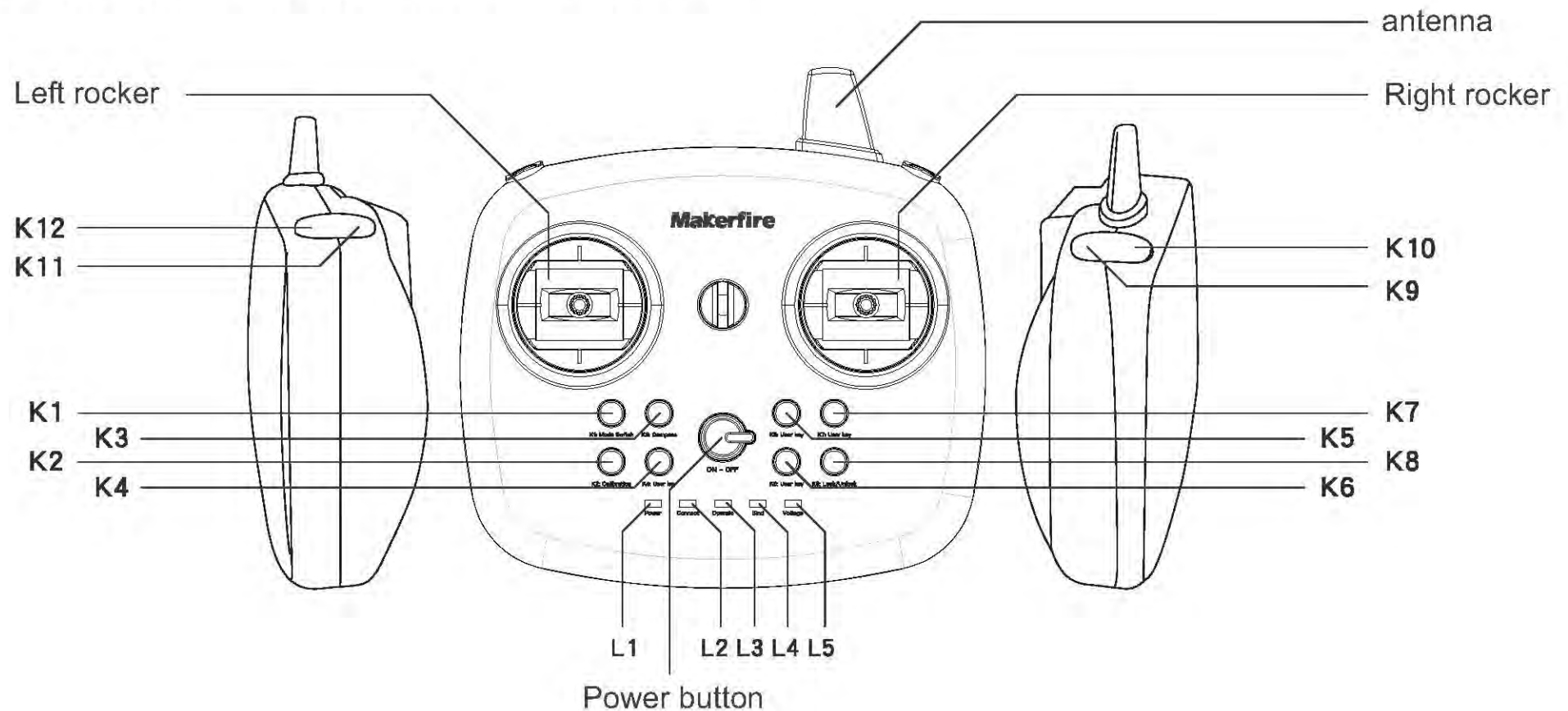

Power switch button: turn on/ turn off

K1: Online mode/offline mode switch

K2: Gyroscope calibration

K3: Magnetometer calibration

K4: Speed switch

K5: Spin 360°

K6: Bouncing mode

K7: One-key landing

K8: Lock/unlock

K10: Photographic mode

K12: Recording mode

Note: Radio transmitter distance is 100 meters, maximal flight height is 30 meters, please fly safely within the sight.

Operation Guide-Radio Transmitter

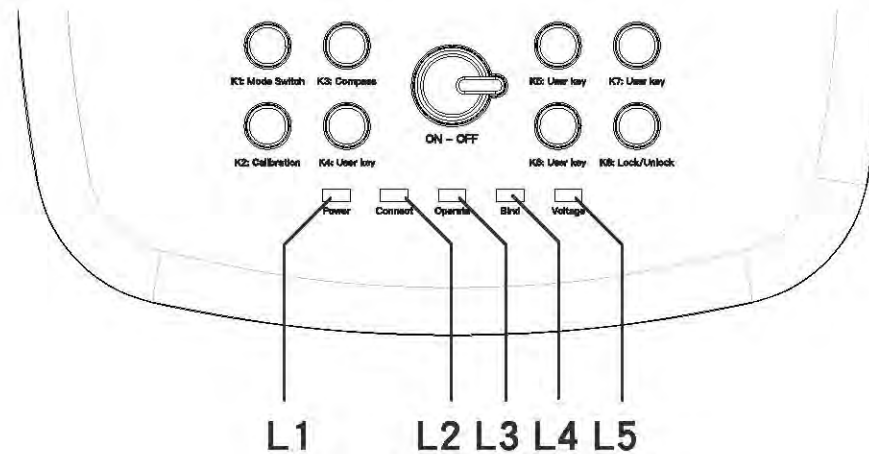

L1: Power Indicator

Light on: Power on
Light off: Remote controller fail or battery overcharged

L2: Connection status

Light off: Connect successfully
Flash slow : Fail to connect

L3: Operation mode

Light on: Online programming mode
Light Off: Radio transmitter mode

L4: Binding status

Flash fast : Binding status
Light Off: Normal status

L5: Voltage indicator

Flash fast: Low battery
Flash slow : Low battery of the radio transmitter
Light off: Fully charged

Note: L2 and L4 light flash fast shows the GHOST goes into binding process.

Operation Guide-Radio transmitter

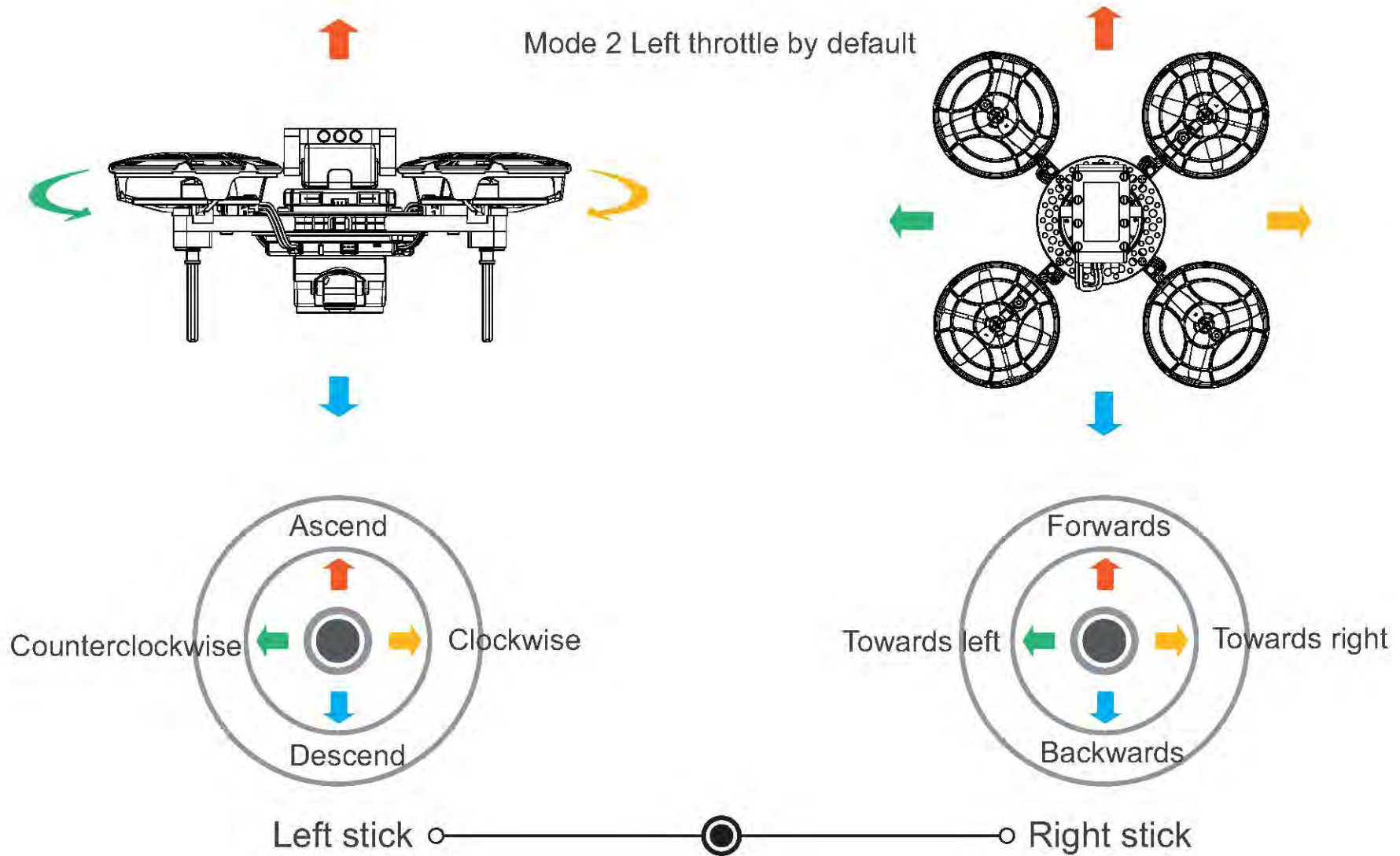

Operation Guide-Radio transmitter

Mode 1 Right throttle

When change to Mode 1, download the software and burn from the litebee.com website

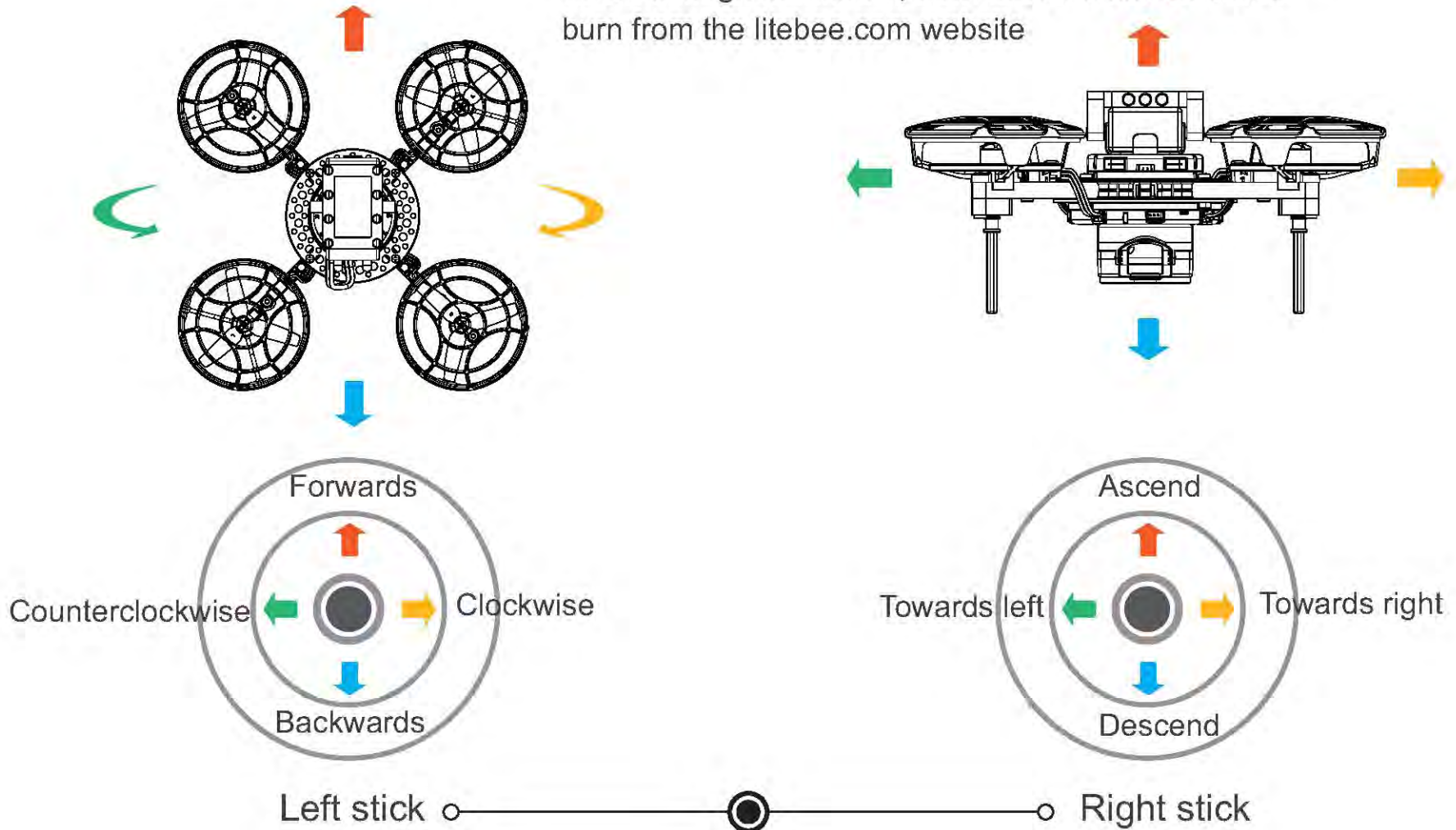

Operation guide-Fly with your phone

Adriod

Search “LiteBee” on your App store to download the application

IOS

Search “LiteBee” on your App store to download the application

Open the application, click Ghost to get into the operation interface; based on Wi-Fi communication, palm device supports operation and image transmission; Connect Wi-Fi: “Ghost II_XXXXX”, password by default is “12345678”.



IOS App requires IOS 9.0 or advanced version

Android App requires Android 4.4 or advanced version

Operation guide-Fly with your phone

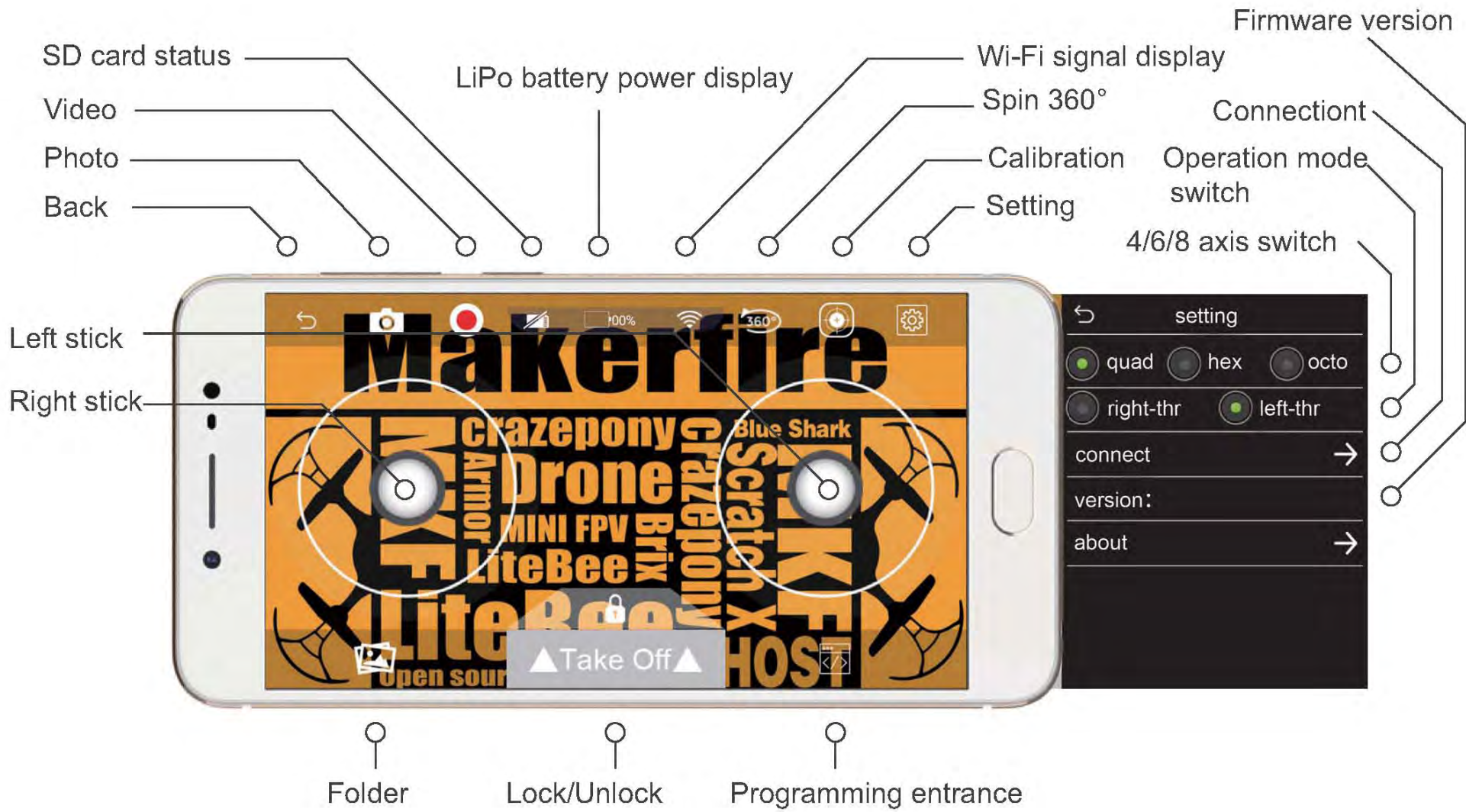

Operation Guide-Binding

Note: Ghost needs to bind if first use

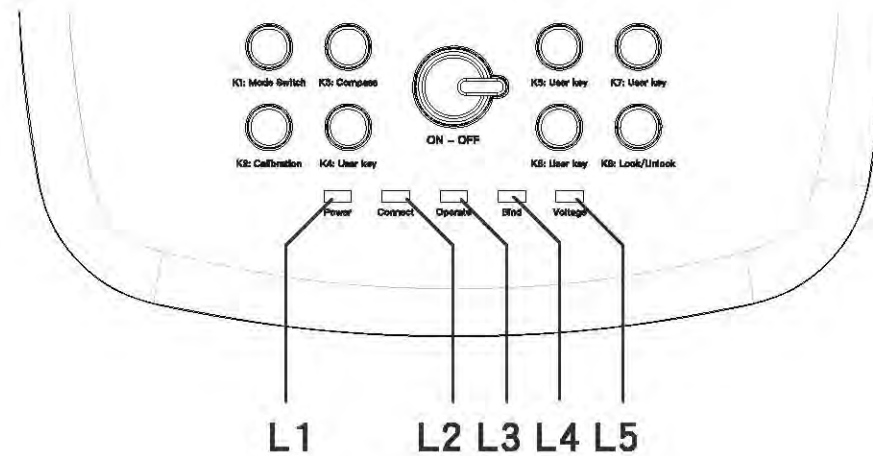

1. Turn on the radio transmitter(The Ghost is power off)
2. Push the right joystick to upper right 45° and press mode switch at the same time, then light L2 & L4 change to flash.

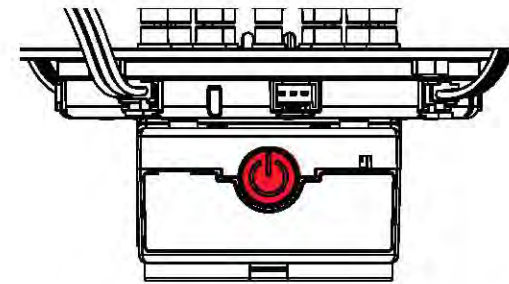

3. Turn on Ghost, then radio transmitter has “di” sound, the light L2 & L4 turn off and the light L1 flashes solid shows binding is successfully.

Operation Guide-Lock&Unlock

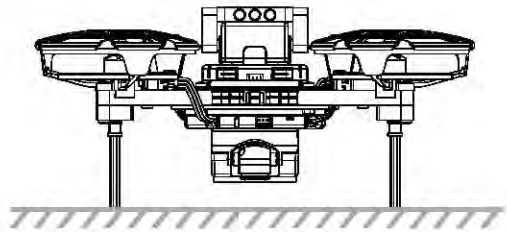

1. Put Ghost in the horizontal position.



- 1) Press the calibration button, Ghost will have a “di” sound and finish the calibration in 5 seconds.
- 2) Press the Unlock button, Ghost starts to take off.

解锁

降落



- 1) Pull down the left joystick, when the Ghost lands to the ground, press the lock button.
- 2) Press one-key landing, Ghost will land vertically to the ground and lock automatically.

Operation Guide-Precaution

1. Insure the correct installation before flying the Ghost.
2. Insure the battery is in fully charged, and the motor wires in correct connection.
3. Place the Ghost in the horizontal place.
4. Press the calibration button before flying, the buzzer has the "di" sound and blue and green light finish flash.
5. If replace the new battery when control with the phone, please restart the APP before flying again.

2 Graphical programming



Computer programming-connecting devices

1. Turn on Ghost and remote control, connect the remote control to the computer with a USB cable
2. Press the K1 button, Enter programming mode, Operate indicator stays lit.

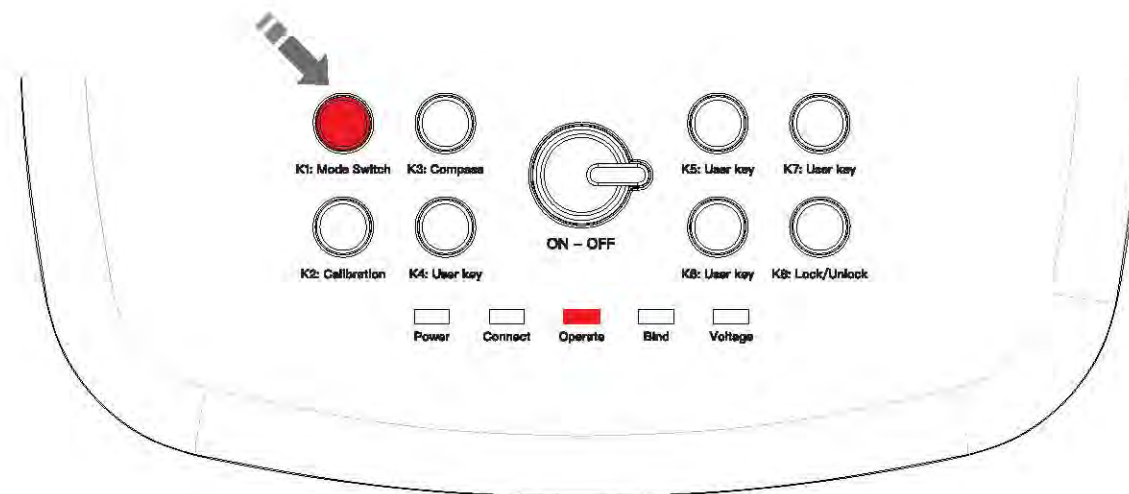

Computer programming-Software acquisition and installation

1. Go to <http://www.litebee.com>, download Ghost offline programming software (please download the software package that matches your computer's windows version)
2. Unpacking the package, install the driver, and install Google Chrome
3. Open the "Offline version - run Begin" folder, extract the file "Ghost_bat", and double-click to open the file Begin, the following two pages appear

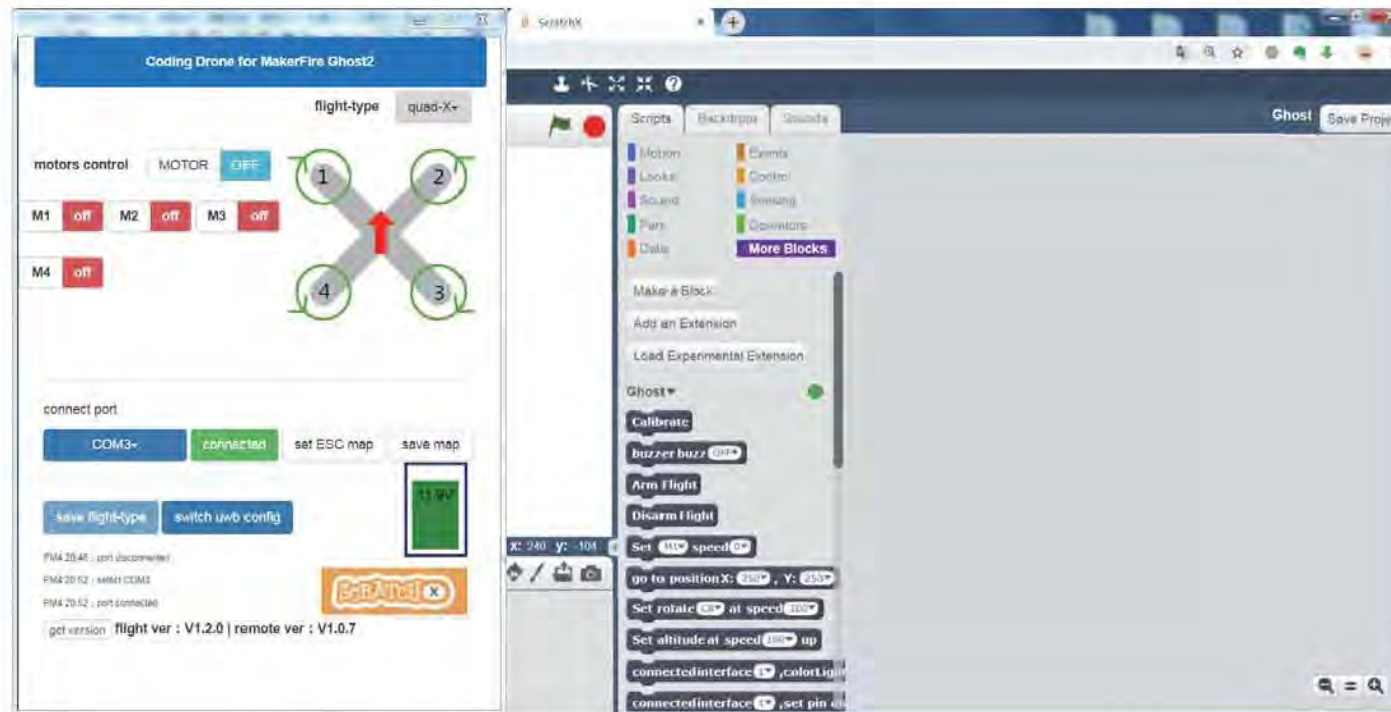

Computer programming-Software acquisition and installation

4. On the connection page, choose the serial port COM3, click Connect
5. After connection succeed, please check if the installed flight programming can run. Click "Motor" in the control to display "Start"; then click "off" in "M1" to display "on". At this time, observe whether the blade rotates. If it rotated, the environment is set up successfully. Then click on "Scratch" in the lower right corner to enter the programming interface.

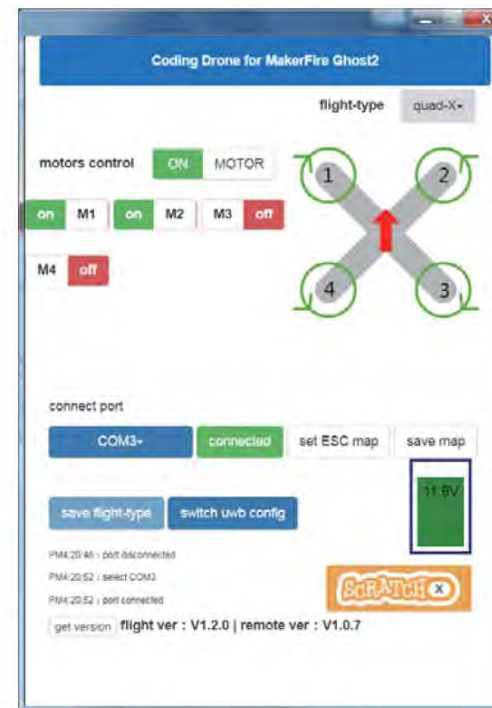
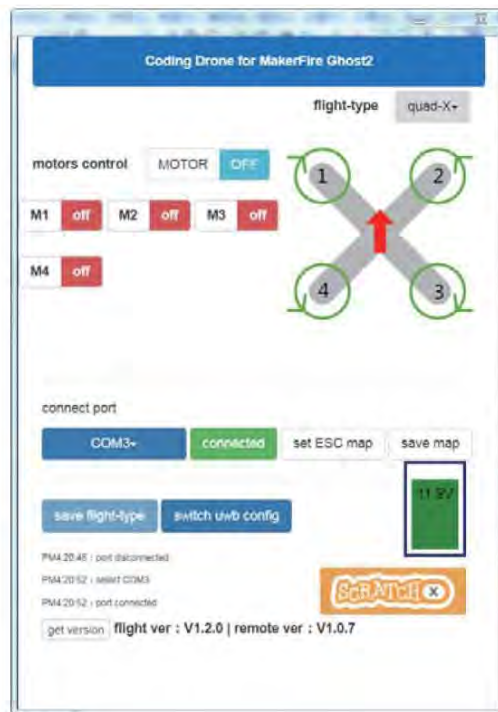

Computer programming-Software acquisition and installation

6. The initial programming language is English. You can query the fly instructions in “More blocks” to control Ghost.

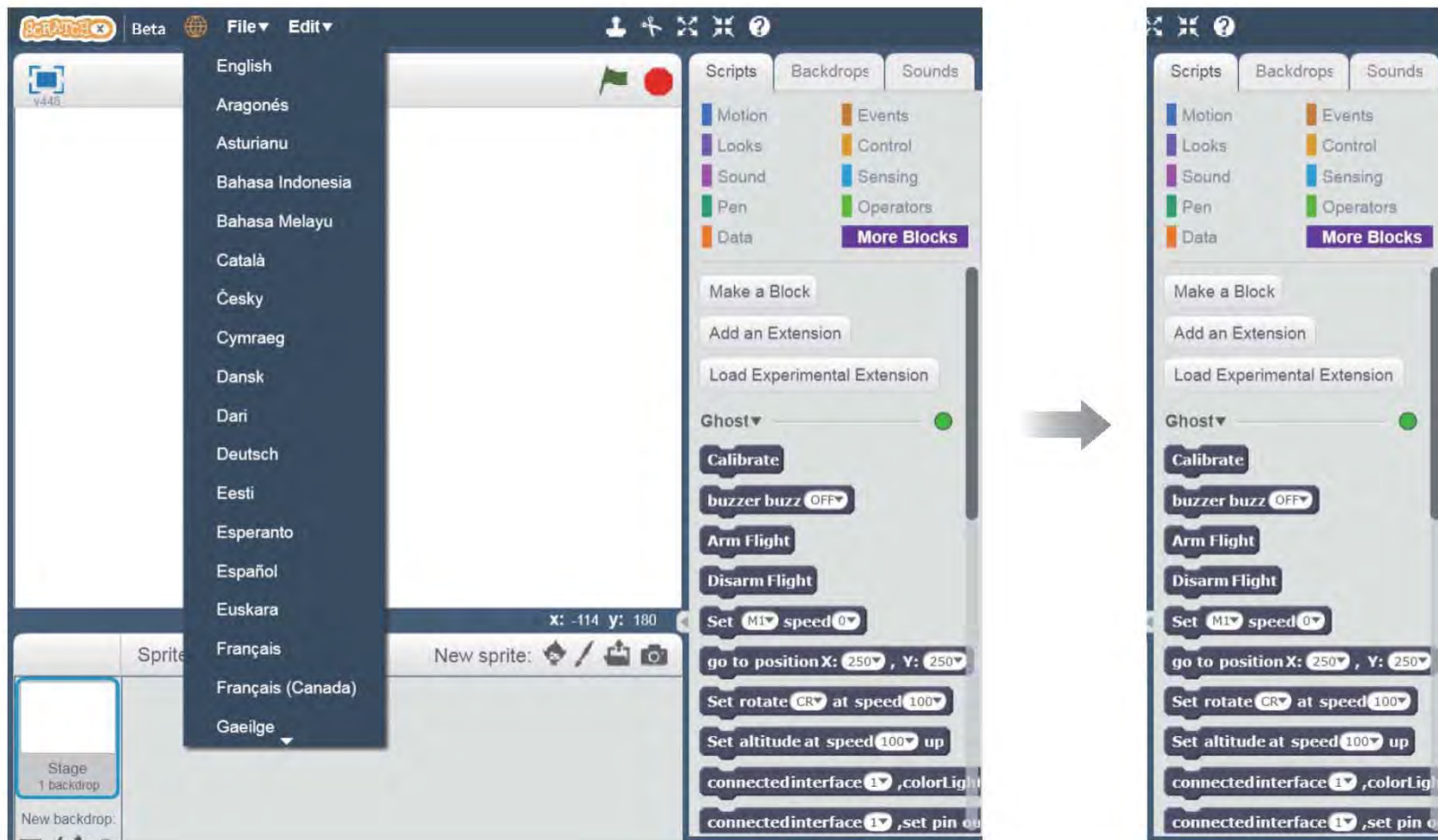

Computer programming-Software acquisition and installation

The screenshot shows a software window titled "Coding Drone for MakerFire Ghost2". At the top right, there is a "flight-type" dropdown menu set to "quad-X". Below this, a "motors control" section features a "MOTOR OFF" button and four motor status indicators: M1 off, M2 off, M3 off, and M4 off. A central diagram shows a quadcopter with four rotors numbered 1 to 4 and a red arrow pointing upwards. Below the motor controls, a "connect port" section shows "COM3" selected and a "connected" status. To the right of this are "set ESC map" and "save map" buttons. Further down, there are "save flight-type" and "switch twb config" buttons. A green box displays "11.8V" for the aircraft voltage. At the bottom, a "Scratch" logo is visible, and a status bar shows "flight ver : V1.2.0 | remote ver : V1.0.7".

Motor control master switch
(Click "Stop" to switch to "Start")

Single motor rotation test switch
(used to test if the Ghost programming environment is built successfully)

PC connection

Switch space coordinate position

After selecting the flight type, you need to save the number of axes.

View historical operational data

flight-type quad-X

Aircraft type selection
(4 axes, 6 axes, 8 axes respectively)

Aircraft type diagram
(following the type of aircraft to change)

Motor custom mapping

Aircraft voltage display

Scratch web programming button

Computer programming-Software acquisition and installation

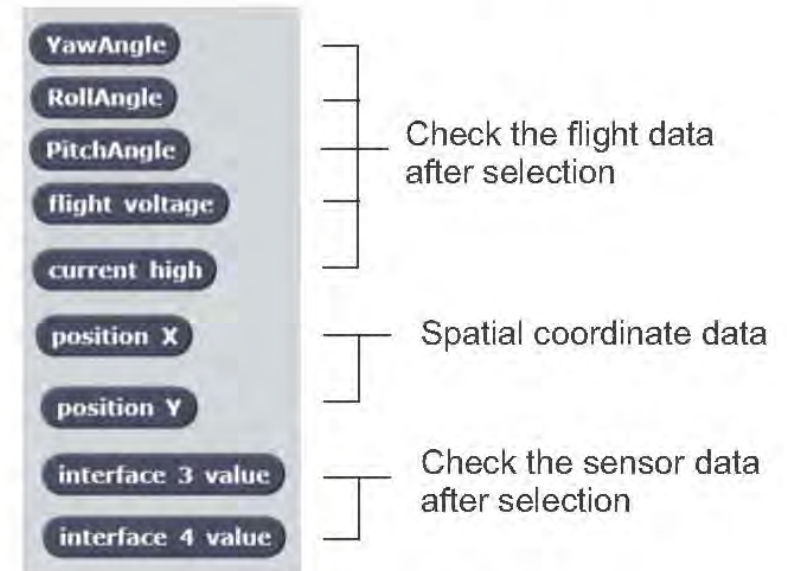
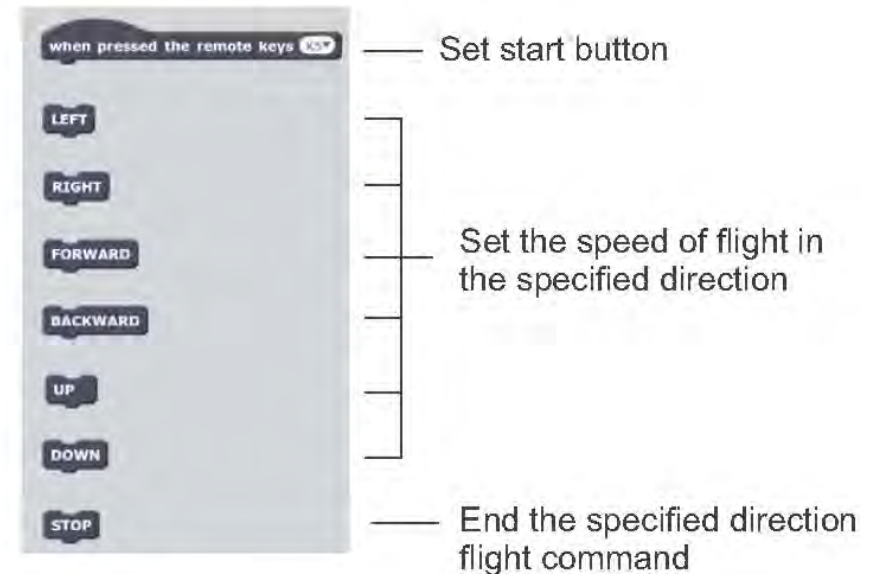
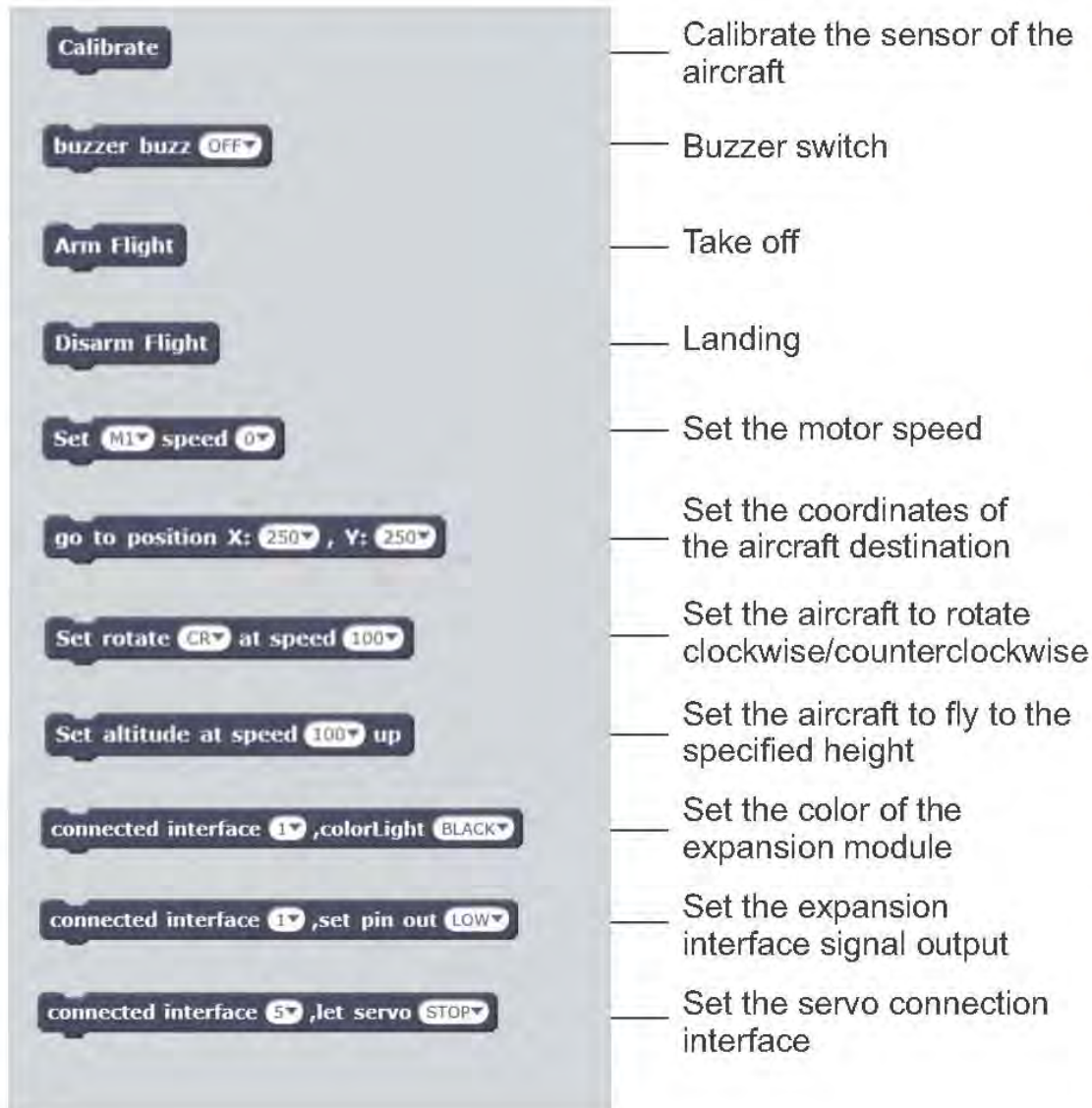

Computer programming-Task-based routine one

Task: Scratch sets the motor. In the order of number 1-4, each motor rotates at an idle value of 90 for 1 second, end the task after 3 cycles.

Routine idea:

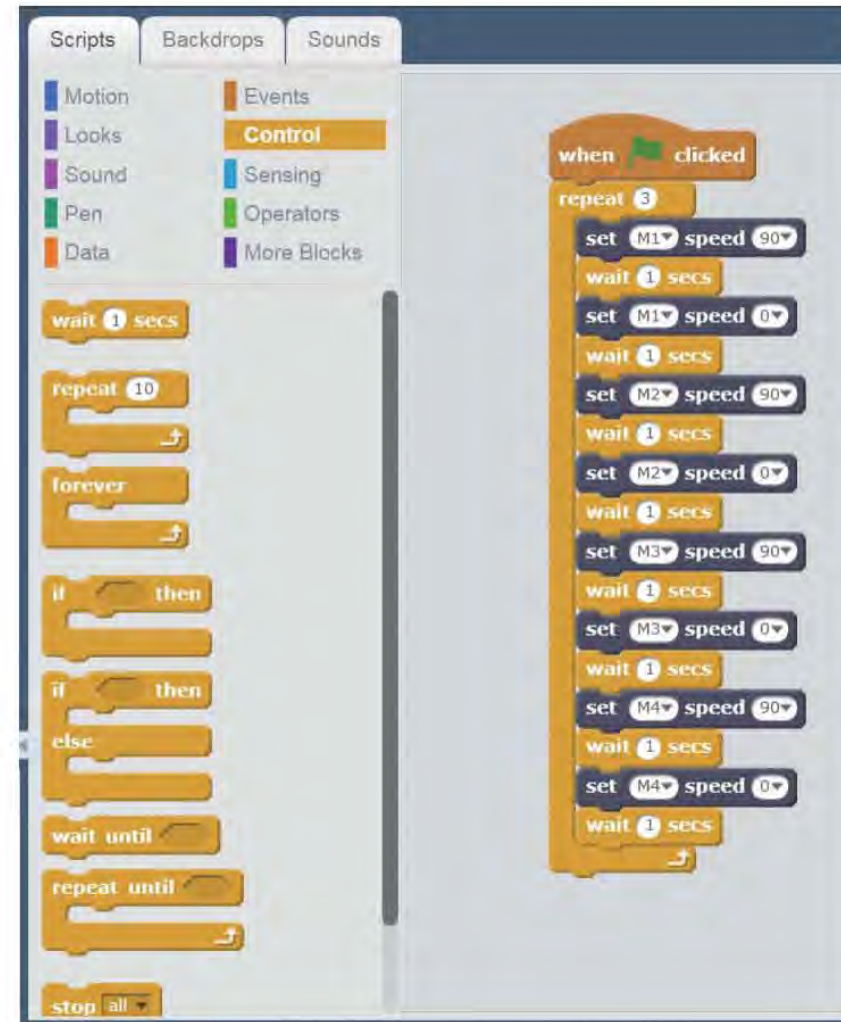
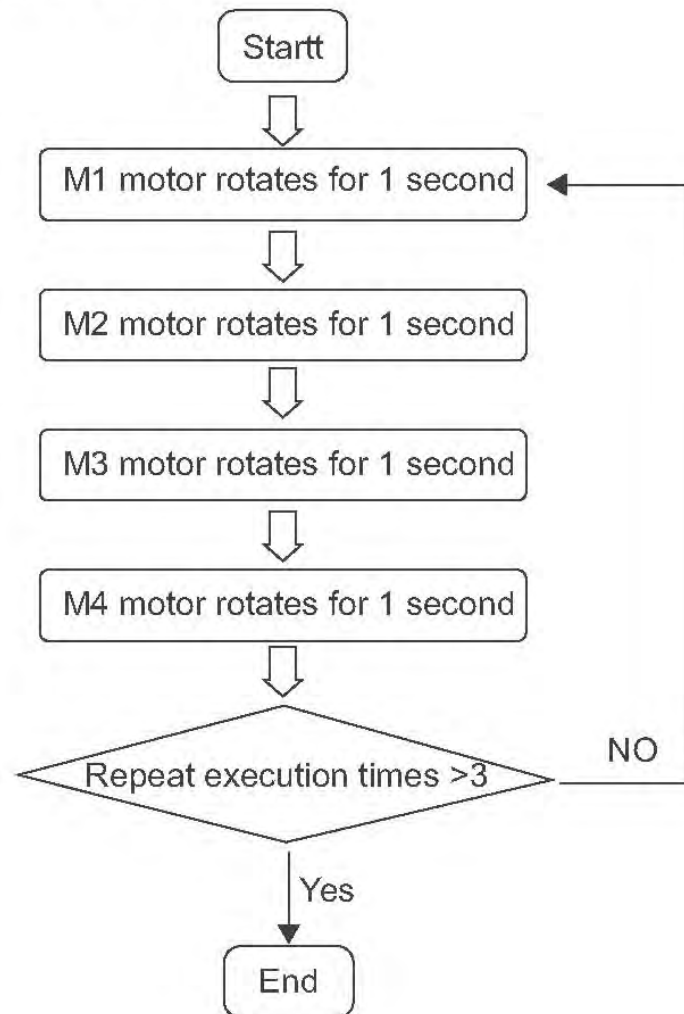

Computer programming-Task-based routine two

Task: Scratch programming control Ghost, calibration, wait 5 seconds, take off, fly Ghost to 100cm height, set buzzer beep when the flight altitude is higher than 90cm, buzzer beeping 1 second, wait 0.5 seconds in the sky, turn off the buzzer and land.

Routine ideas:

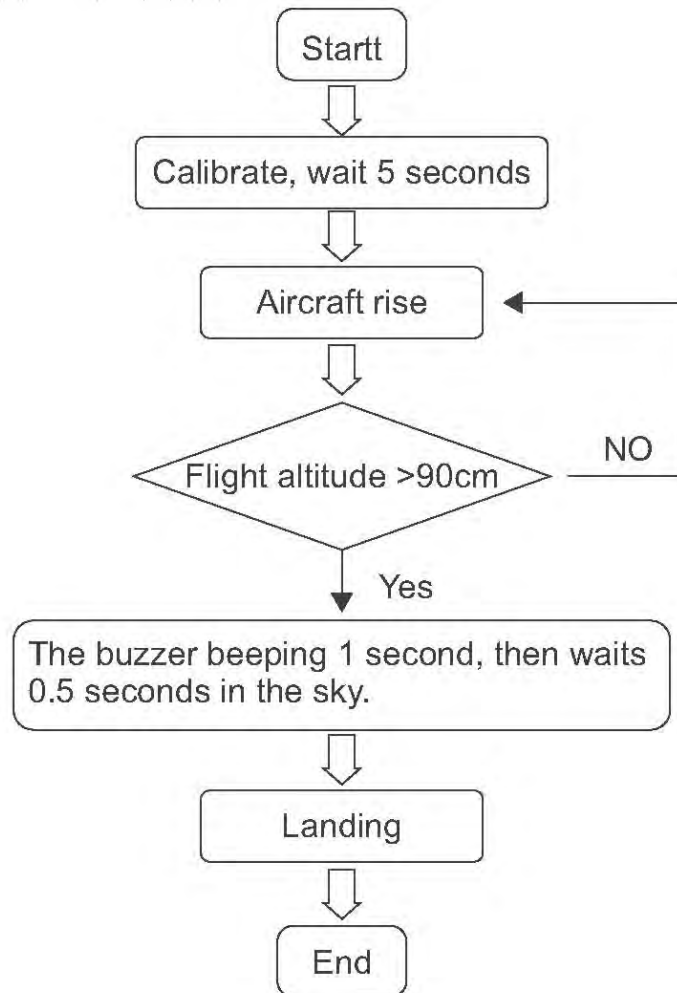

Graphical programming-Android programming interface

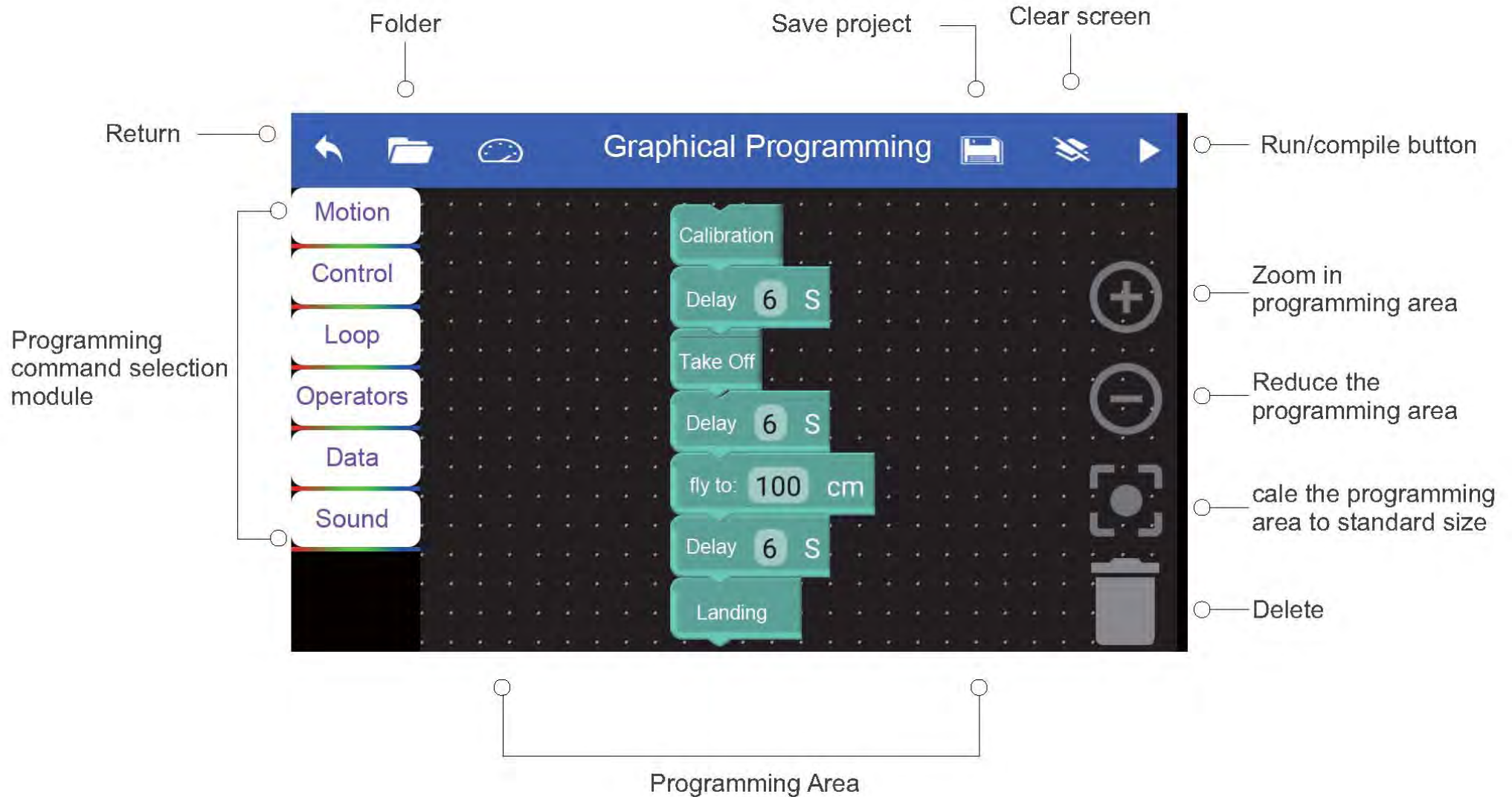



3 Application development

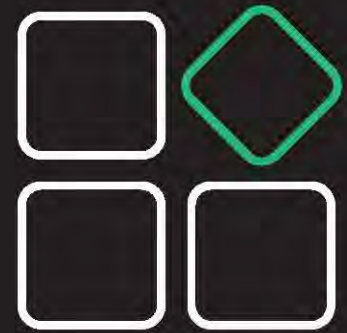

Six-axis / Eight-axis expansion-six-axis installation

1. Before assembling the six-axis, in addition to the original accessories, additional preparation is required:

Positive power kit*1 and negative power kit*1, Clockwise power kit*1, Counterclockwise power kit*1, Power cable*2, eleven-hole structural rod*2, 1*5 cross shaft*2, Long pin with bushing*2, Screw nuts*6, Screws (M3*15)*2, Screws (M3*20)*4, three-hole structural rod*2

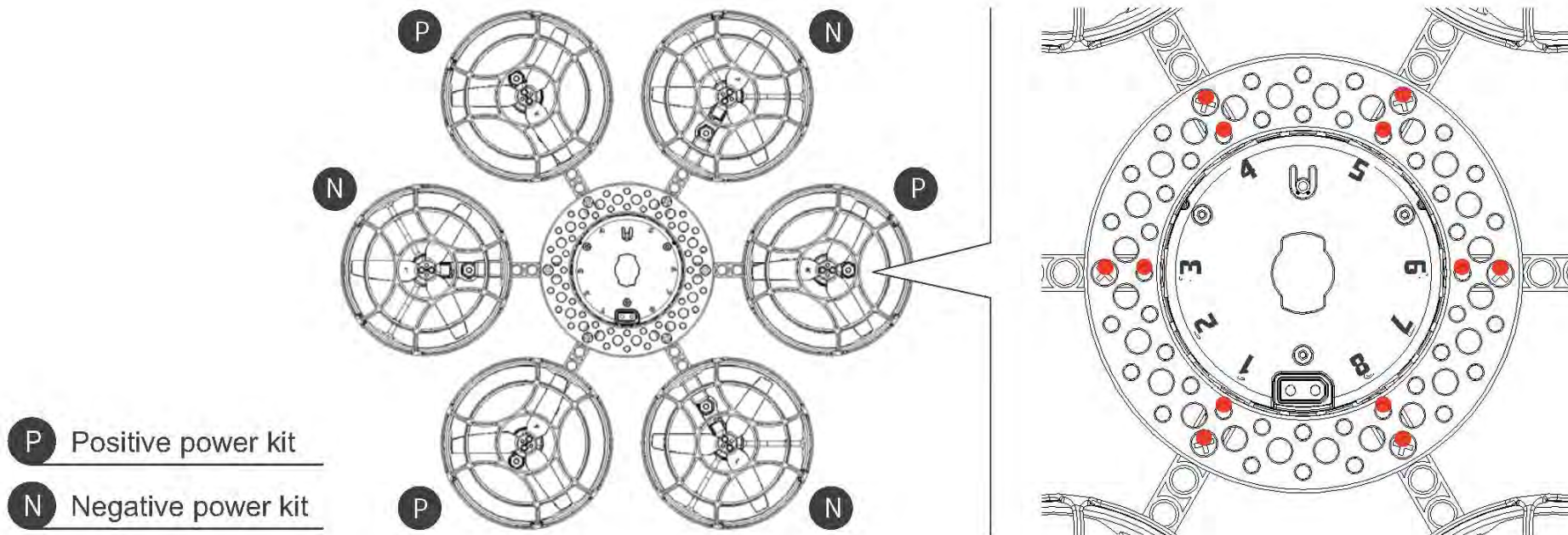

2. Install the power kit in the position shown above, according to the installation method of the assembly manual.

Six-axis / Eight-axis expansion-six-axis installation

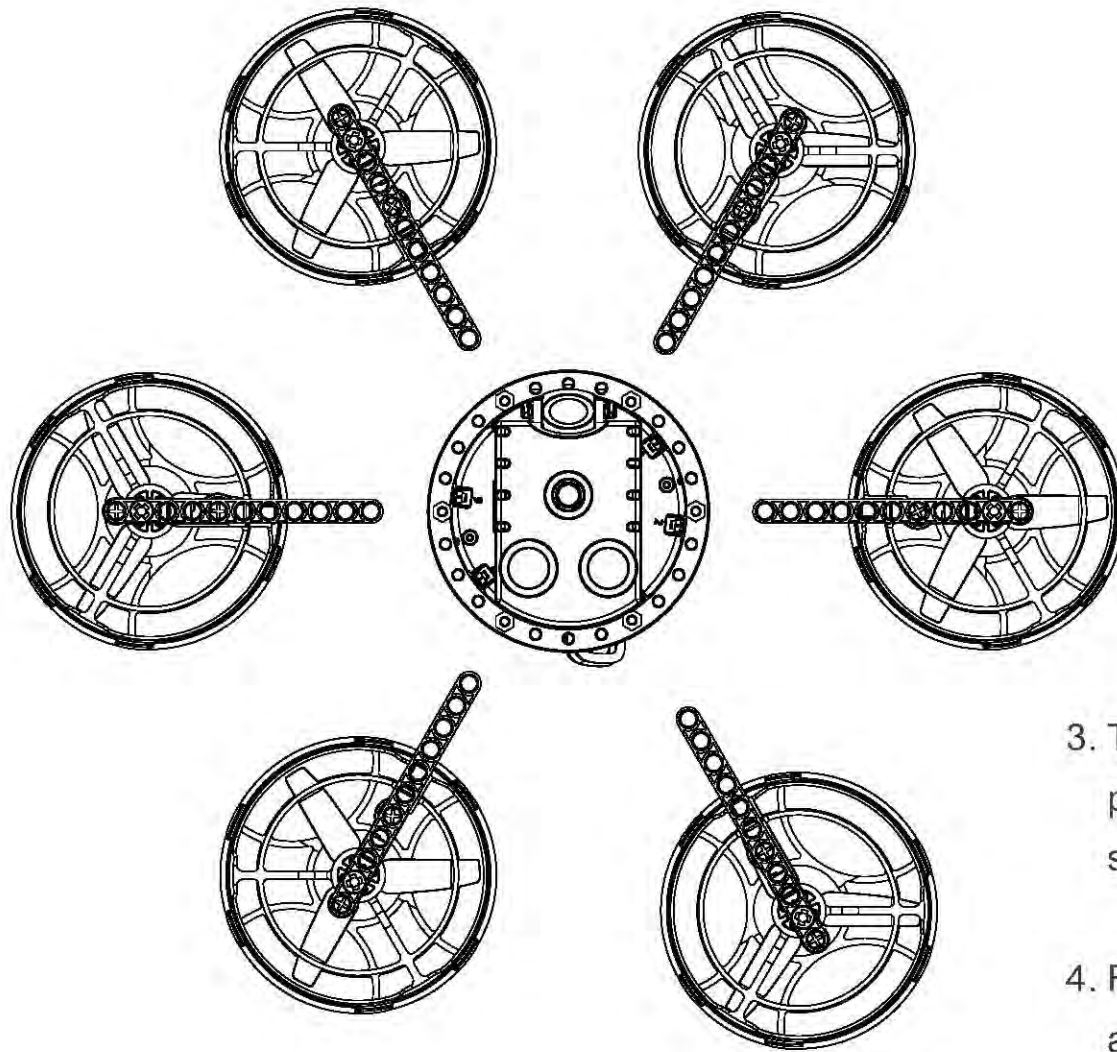

3. Turn the aircraft upside down, and connect the power cables to the corresponding sockets as shown in the figure above.
4. Finally, install other accessories as shown in the assembly manual.

Six-axis / Eight-axis expansion-six-axis installation

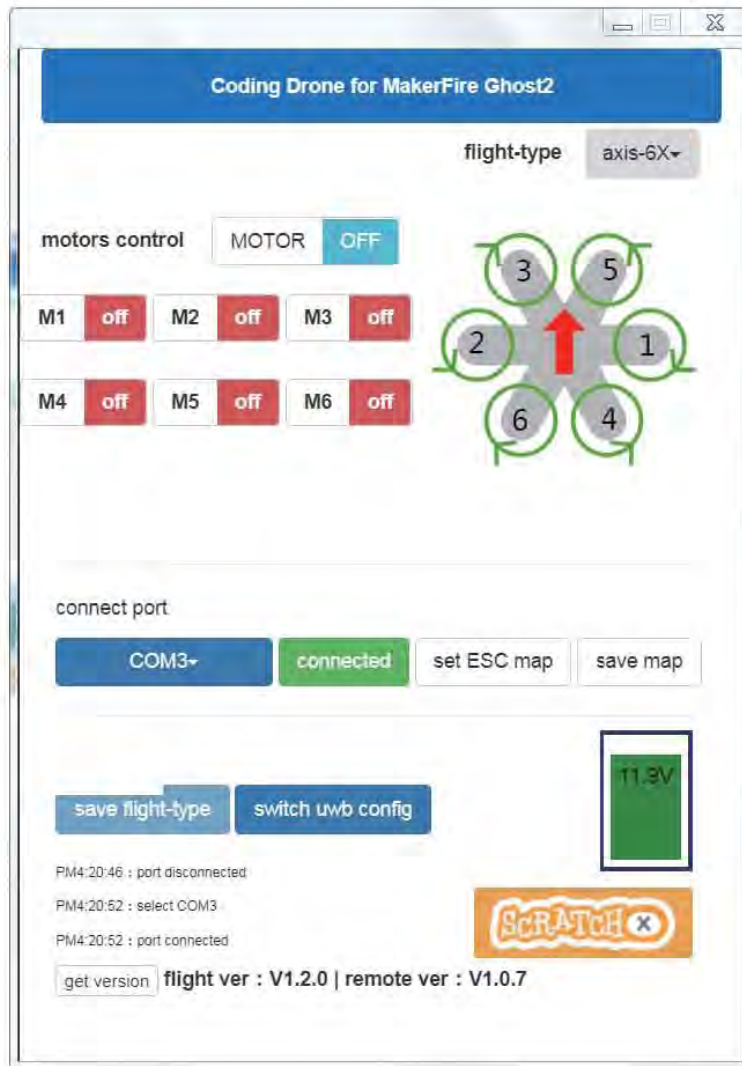

5. Open the Google App plugin - Ghost, open the remote control and connect to the computer (note: the remote control is in online mode)
6. Click "Select Serial Port". After connecting, the port will automatically detect the current axis type of the aircraft. Please set the aircraft type to "6-axis X" in the upper right corner. Finally, click "Axis save" button to save.
7. Rebinding the Ghost with remote control, then the aircraft can be operated to fly.

Six-axis / Eight-axis expansion-eight-axis installation

1. Before assembling the eight-axis, in addition to the original accessories, additional preparation is required:
Positive power kit*2 and negative power kit*2, Clockwise power kit*2, Counterclockwise power kit*2, Power cable*4,
Thirteen-hole structural rod*8, 1*5 cross shaft*4, Long pin with bushing*4, Screw nuts*12, Screws (M3*15)*4,
Screws (M3*20)*8, Three-hole structural rod*4

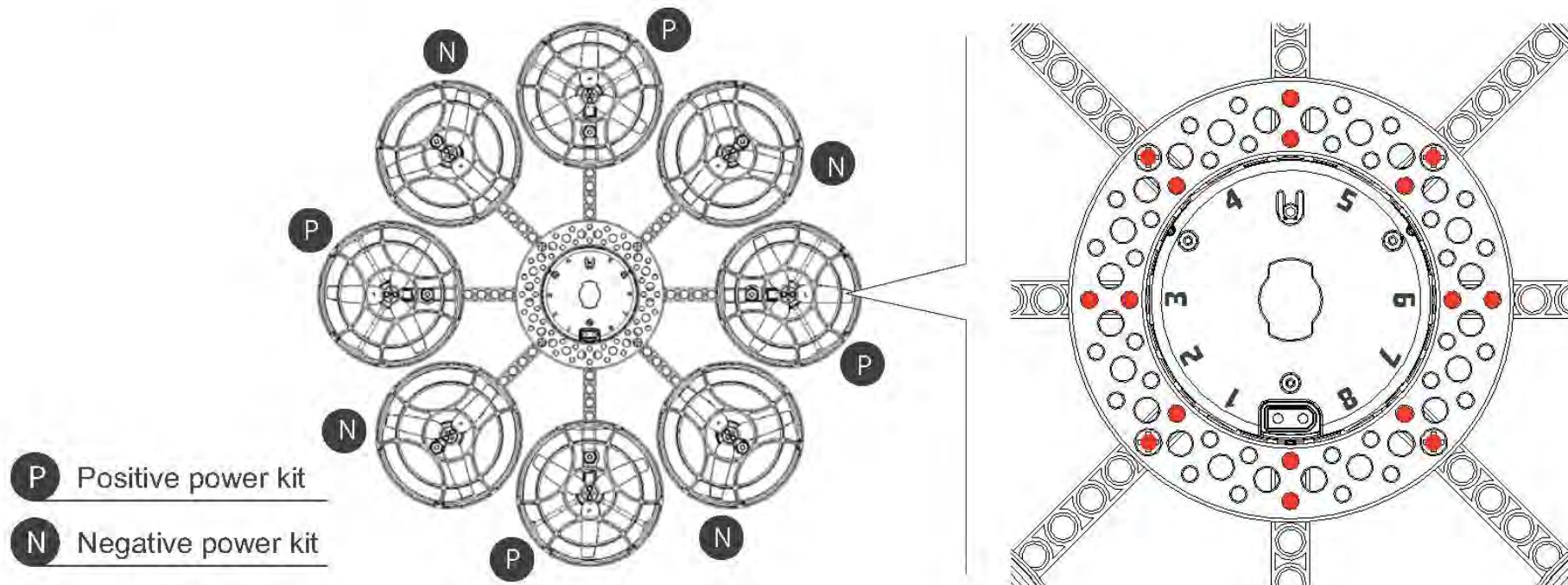

2. Install the power kit in the position shown above, according to the installation method of the assembly manual.

Six-axis / Eight-axis expansion-eight-axis installation

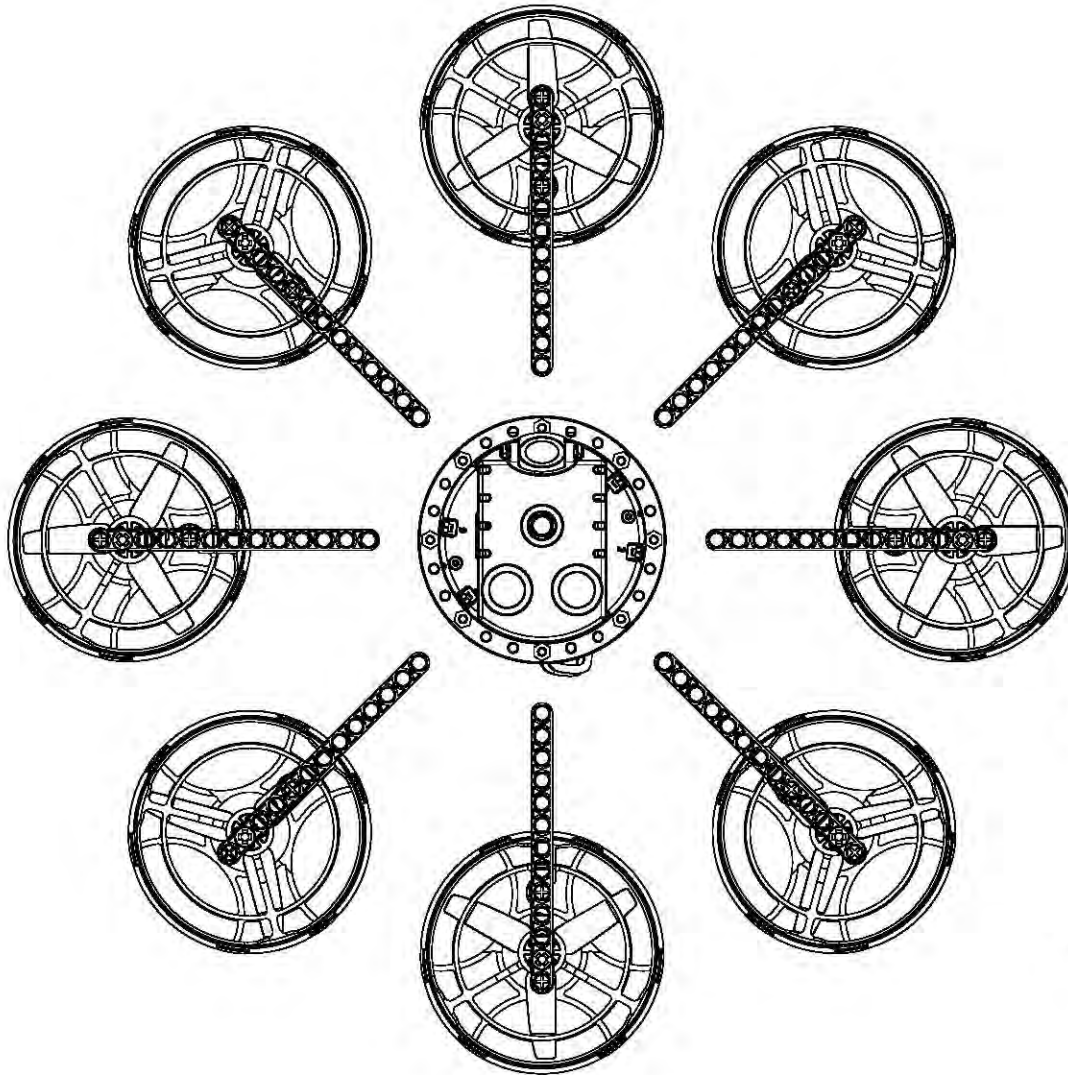

3. Turn the aircraft upside down, and connect the power cables to the corresponding sockets as shown in the figure above.
4. Finally, install other accessories as shown in the assembly manual.

Six-axis / Eight-axis expansion-eight-axis installation

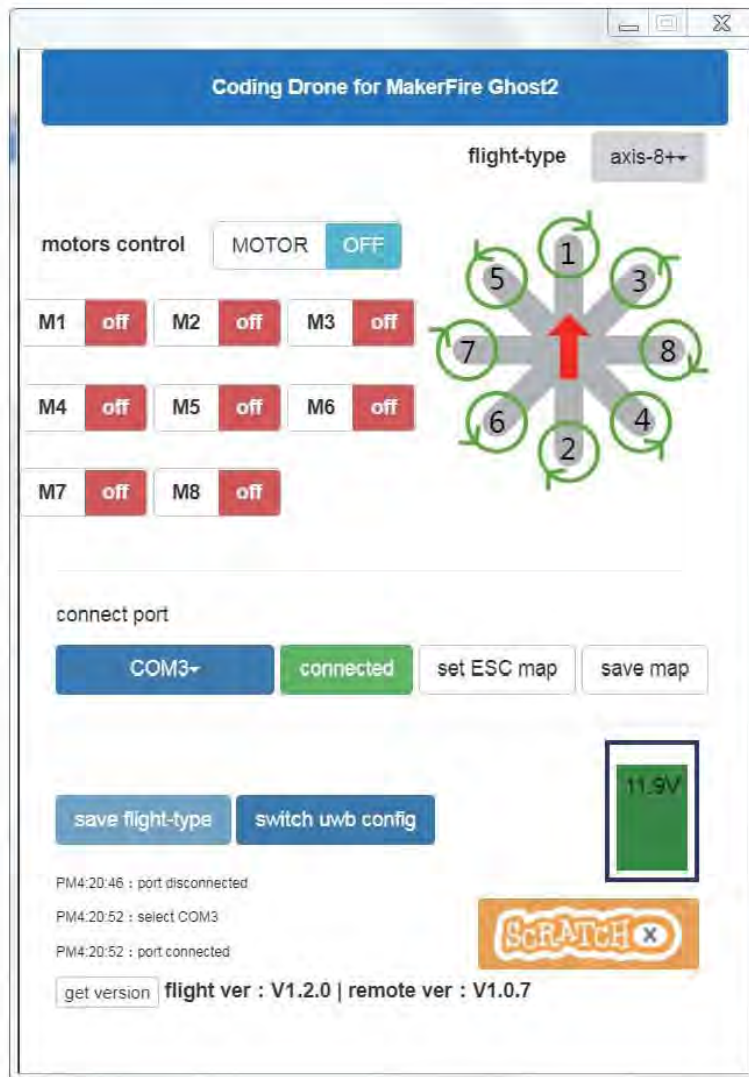

5. Open the Google App plugin - Ghost, open the remote control and connect to the computer.
(note: the remote control is in online mode)
6. Click "Select Serial Port". After connecting, the port will automatically detect the current axis type of the aircraft. Please set the aircraft type to "8-axis +" in the upper right corner. Finally, click "Axis save" button to save.
7. Rebinding the Ghost with remote, then the aircraft can be operated to fly.

Indoor 3D positioning solution

By using a space coordinate positioning system to build a 3D space in an indoor environment, so that each Ghost can get accurate 3D coordinate data. It can be used for indoor programming flight shows or multi-level task programming.

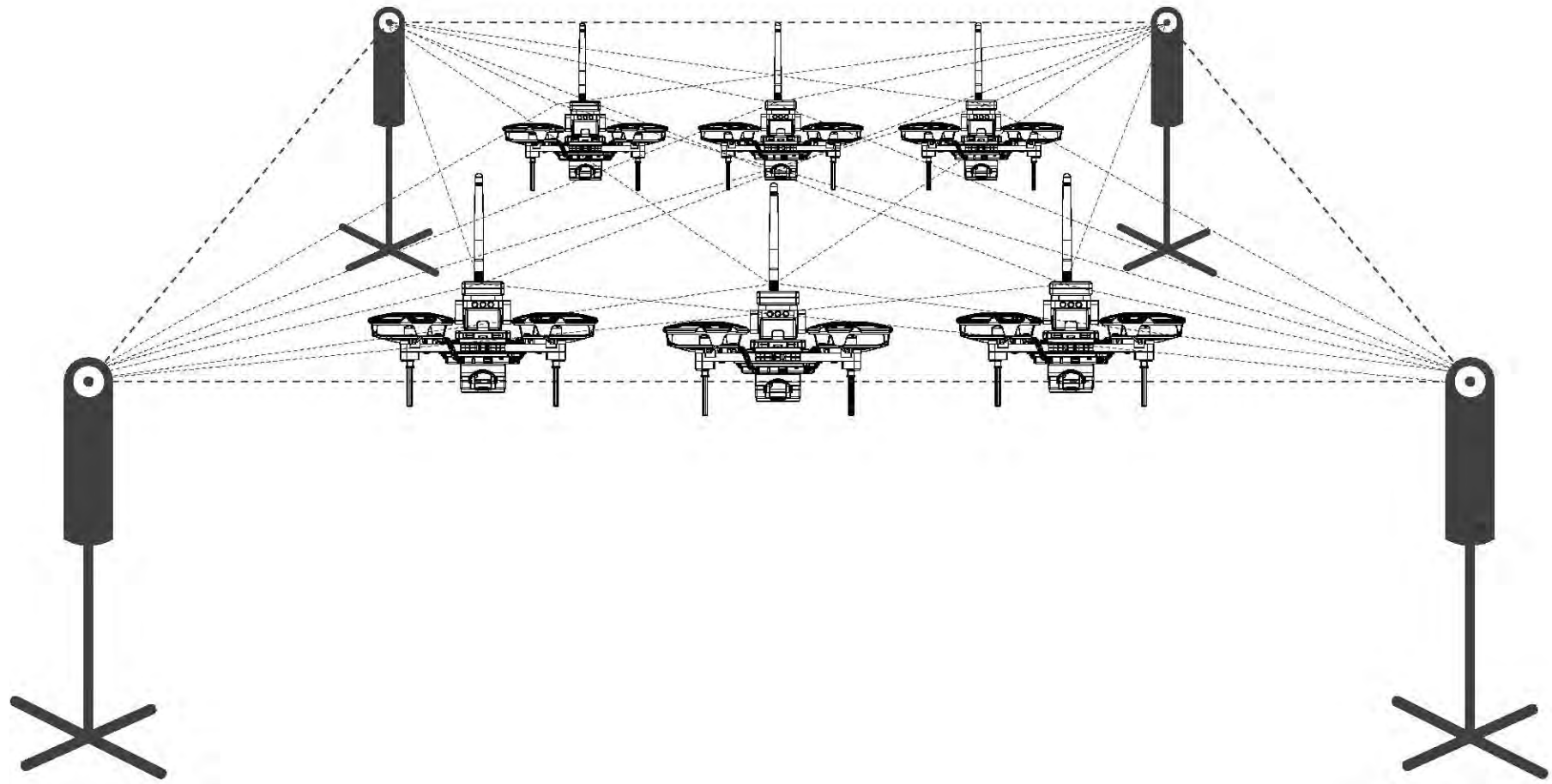

Application docking station instance

Application docking station access to programmable lights and DC motors. Scratch programming controls the motor to rotate forward and lighting the yellow light strip for 1 second; then control the motor reverse and lighting the pink light strip for 2 seconds to execute 10 times in a loop. At the end, flash white light (each 0.4 seconds) to remind.

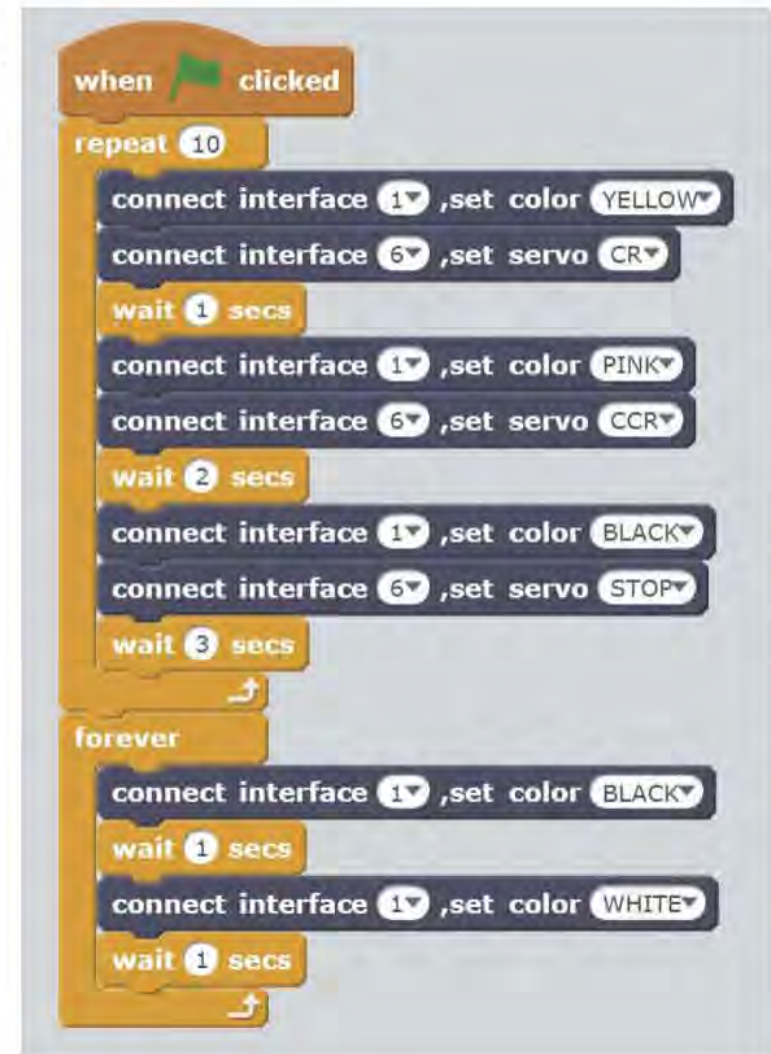
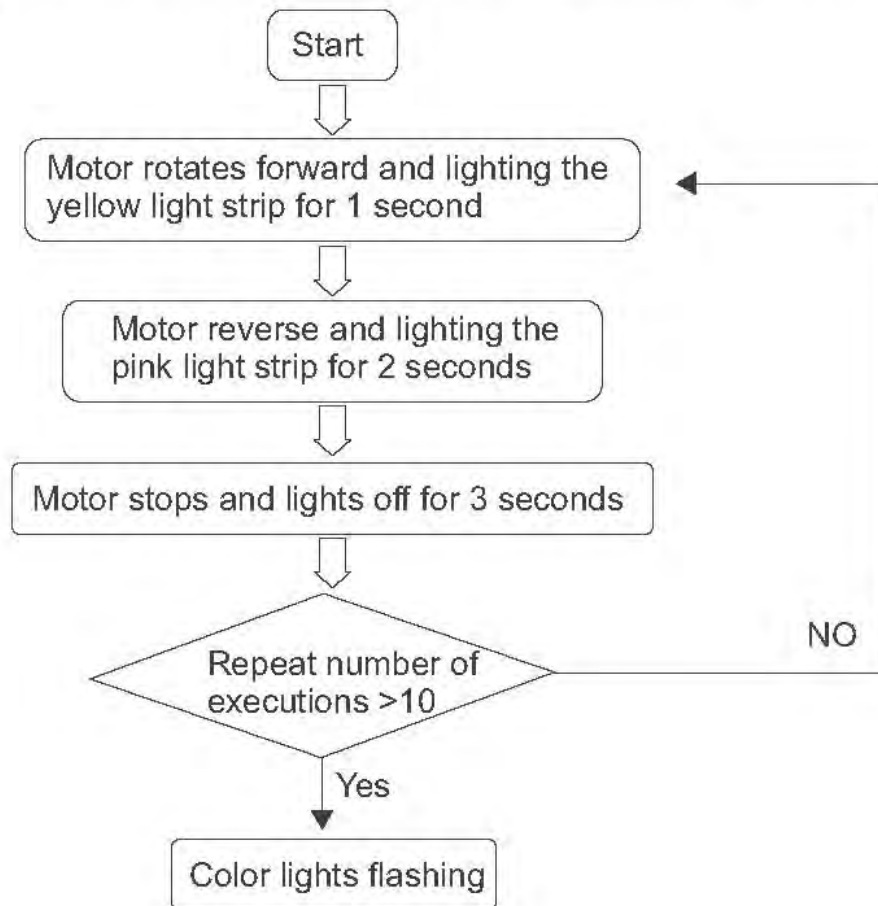

4 Frequently asked questions



Other aspects

- If the programming interface cannot be displayed completely when open Scratch interface, please use Google Chrome to open it.

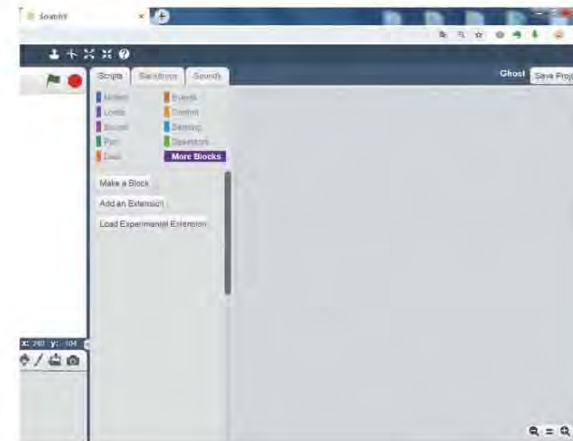
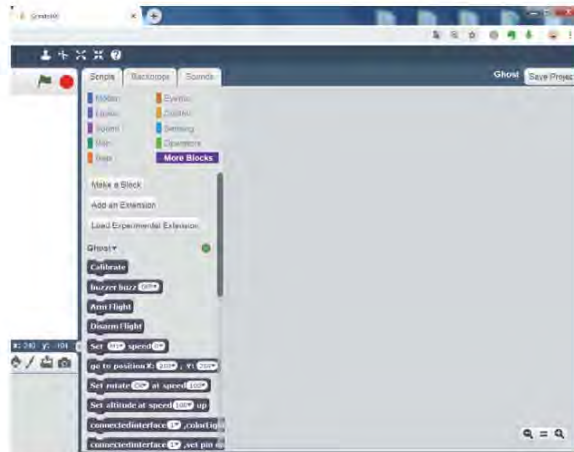

- If the PC can't read serial port when the remote control is connected to it, please right-click Computer to open the device manager on your computer to check if there is a driver not installed prompt (with a yellow exclamation mark, as shown below). If so, please download the PC2102 driver from LiteBee's official website or use the Driver Wizard to detect and install.



Other aspects

- The battery balance connector can be connected to the charger for charging, but be sure not to access to the application docking station.



- If the remote control fails to connect to the flight controller when updating the remote control or flight controller firmware, rebinding method as follows:



1. Turn on the remote control (Ghost needs to be turned off)
2. Press the right joy stick to the upper right corner for 45 degrees, and press the mode switch at the same time. Then the remote control L2 and L4 lights will flash.

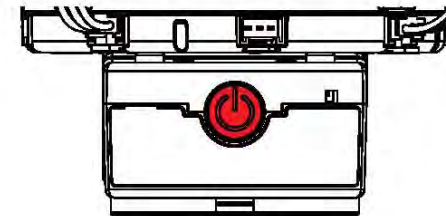

3. Turn on the aircraft, the buzzer will sound and the flight controller status indicator will be on. It means binding successful.

Disclaimer statement

This product is a multi-rotor aircraft. We recommend for children over 8 years of age. Children under the age of 8 are required to be accompanied by adults. Please be careful when handling this product in the presence of children.

Please read this document carefully before using this product. This statement has important guidance for your safe use of this product and your legal rights. This product provides an easy flight experience when the power supply is working properly and the components are not damaged. Be sure to know your legal rights, responsibilities, and safety instructions before using this product, and also clear about that use this product may bring property damage, safety accidents and personal safety hazards. By using this product, you are deemed to have read, recognized and accepted all terms and conditions of this statement. The user is committed to being responsible for his non-compliant operations and the consequences thereof; the user undertakes to use the product solely for legitimate purposes and agrees to these terms and any relevant policies or guidelines that may be developed by us. We are not liable for any direct or indirect personal injury or property damage caused by failure to use this product in accordance with the safety guidelines.

Air Robot LiteBee Series



LiteBee Brix
DIY building block drone



LiteBee
Graphical programming drone



LiteBee Pro
Graphical Programming Drone Pro

FCC Warning

This equipment has been tested and found to comply with the limits for a Class B digital device, pursuant to Part 15 of the FCC Rules. These limits are designed to provide reasonable protection against harmful interference in a residential installation. This equipment generates uses and can radiate radio frequency energy and, if not installed and used in accordance with the instructions, may cause harmful interference to radio communications. However, there is no guarantee that interference will not occur in a particular installation. If this equipment does cause harmful interference to radio or television reception, which can be determined by turning the equipment off and on, the user is encouraged to try to correct the interference by one or more of the following measures:

- Reorient or relocate the receiving antenna.
- Increase the separation between the equipment and receiver.
- Connect the equipment into an outlet on a circuit different from that to which the receiver is connected.
- Consult the dealer or an experienced radio/TV technician for help.

Changes or modifications not expressly approved by the party responsible for compliance could void the user's authority to operate the equipment.

This device complies with part 15 of the FCC Rules. Operation is subject to the following two conditions: (1) This device may not cause harmful interference, and (2) this device must accept any interference received, including interference that may cause undesired operation.

Aerial drone:

The antenna(s) used for this transmitter must be installed to provide a separation distance of at least 20 cm from all persons and must not be co-located or operating in conjunction with any other antenna or transmitter. This equipment complies with FCC radiation exposure limits set forth for an uncontrolled environment. End user must follow the specific operating instructions for satisfying RF exposure compliance. This transmitter must not be co-located or operating in conjunction with any other antenna or transmitter.

Controller:

The device has been evaluated to meet general RF exposure requirement. The device can be used in portable exposure condition without restriction.



 www.makerfire.com



LiteBee