



Shenzhen Global Test Service Co.,Ltd.

No.7-101 and 8A-104, Building 7 and 8, DCC Cultural and Creative Garden, No.98, Pingxin North Road, Shangmugu Community, Pinghu Street, Longgang District, Shenzhen, Guangdong

FCC PART 15 SUBPART C TEST REPORT

FCC PART 15.249

Report Reference No......: **GTS20190327004-1-3**

FCC ID..... : **2AKUCMKFC05A**

Compiled by

(position+printed name+signature)..: File administrators Jimmy Wang

Supervised by

(position+printed name+signature)..: Test Engineer Aaron Tan



Approved by

(position+printed name+signature)..: Manager Jason Hu

Date of issue.....: May.7, 2019

Representative Laboratory Name .: **Shenzhen Global Test Service Co.,Ltd.**

Address.....: No.7-101 and 8A-104, Building 7 and 8, DCC Cultural and Creative Garden, No.98, Pingxin North Road, Shangmugu Community, Pinghu Street, Longgang District, Shenzhen, Guangdong, China

Applicant's name.....: **Shenzhen Makerfire Technology Co., Ltd.**

Address: 502 Room, Panbao Building , No.7-1 Lipu Street, Bantian, Longgang District,Shenzhen,PRC

Test specification

Standard: **FCC Part 15.249**

TRF Originator.....: Shenzhen Global Test Service Co.,Ltd.

Master TRF.....: Dated 2014-12

Shenzhen Global Test Service Co.,Ltd. All rights reserved.

This publication may be reproduced in whole or in part for non-commercial purposes as long as the Shenzhen Global Test Service Co.,Ltd. is acknowledged as copyright owner and source of the material. Shenzhen Global Test Service Co.,Ltd. takes no responsibility for and will not assume liability for damages resulting from the reader's interpretation of the reproduced material due to its placement and context.

Test item description

Trade Aprk.....: /

Manufacturer: **Shenzhen Makerfire Technology Co., Ltd.**

Model/Type reference.....: Ghost II-MC-1

Listed Models: /

Modulation Type.....: GFSK

Operation Frequency.....: From 2405 - 2454MHz

Rating: DC 11.1V from Battery

Result.....: **PASS**

TEST REPORT

Test Report No. : GTS20190327004-1-3	May. 7, 2019
	Date of issue

Equipment under Test : Programming building block drone

Model /Type : Ghost II-MC-1

Listed Models : /

Applicant : **Shenzhen Makerfire Technology Co., Ltd.**

Address : 502 Room, Panbao Building , No.7-1 Lipu Street, Bantian, Longgang District,Shenzhen,PRC.

Manufacturer : **Shenzhen Makerfire Technology Co., Ltd.**

Address : 502 Room, Panbao Building , No.7-1 Lipu Street, Bantian, Longgang District,Shenzhen,PRC.

Test Result:	PASS
---------------------	-------------

The test report merely corresponds to the test sample.
It is not permitted to copy extracts of these test result without the written permission of the test laboratory.

Contents

1.	<u>TEST STANDARDS</u>	4
2.	<u>SUMAPRY</u>	5
2.1.	General ReAprks	5
2.2.	Product Description	5
2.3.	Equipment Under Test	5
2.4.	Short description of the Equipment under Test (EUT)	5
2.5.	EUT operation mode	5
2.6.	Block Diagram of Test Setup	6
2.7.	Special Accessories	6
2.8.	Related Submittal(s) / Grant (s)	6
2.9.	Modifications	6
3.	<u>TEST ENVIRONMENT</u>	7
3.1.	Address of the test laboratory	7
3.2.	Test Facility	7
3.3.	Environmental conditions	7
3.4.	Test Description	8
3.5.	Statement of the measurement uncertainty	8
3.6.	Equipments Used during the Test	9
4.	<u>TEST CONDITIONS AND RESULTS</u>	10
4.1.	AC Power Conducted Emission	10
4.2.	Radiated Emission	11
4.3.	Bandwidth test	15
4.4.	Band Edge Compliance Test	17
4.5.	Antenna Requirements	19
5.	<u>TEST SETUP PHOTOS OF THE EUT</u>	20
6.	<u>EXTERNAL AND INTERNAL PHOTOS OF THE EUT</u>	21

1. TEST STANDARDS

The tests were performed according to following standards:

[FCC Rules Part 15.249](#): Operation within the bands 902 - 928 MHz, 2400 - 2483.5 MHz, 5725 - 5875 MHz, and 24.0 - 24.25 GHz.

[ANSI C63.10:2013](#) : American National Standard for Testing Unlicensed Wireless Devices

[ANSI C63.4: 2014](#): –American National Standard for Methods of Measurement of Radio-Noise Emissions from Low-Voltage Electrical and Electronic Equipment in the Range of 9 kHz to 40GHz
Range of 9 kHz to 40GHz

2. SUMAprY

2.1. General ReAprks

Date of receipt of test sample	:	Apr. 4, 2019
Testing commenced on	:	May. 6, 2019
Testing concluded on	:	May. 7, 2019

2.2. Product Description

Product Name:	Programming building block drone
Trade Aprk:	/
Model/Type reference:	Ghost II-MC-1
List Model:	/
Power supply:	DC 11.1V
Antenna Type	Internal Antenna
Operation frequency	2405MHz ~ 2454MHz
Antenna Type:	2.1dBi
Modulation Type	GFSK

2.3. Equipment Under Test

Power supply system utilised

Power supply voltage	:	<input type="radio"/> 230V / 50 Hz	<input type="radio"/> 120V / 60Hz
		<input type="radio"/> 12 V DC	<input type="radio"/> 24 V DC
		<input checked="" type="radio"/> Other (specified in blank below)	

DC 11.1V

2.4. Short description of the Equipment under Test (EUT)

This is a Programming building block drone.

2.5. EUT operation mode

Channel	Frequency	Channel	Frequency
1	2405MHz
2	2406MHz
3	2407MHz
4	2408MHz
5	2409 MHz	48	2452MHz
.....	49	2453MHz
.....	50	2454MHz
.....		
.....		

2.6. Block Diagram of Test Setup

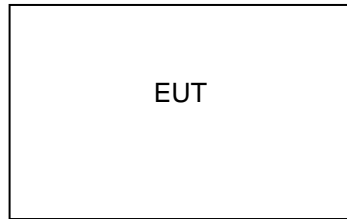

2.7. Special Accessories

Manufacturer	Description	Model	Serial Number	Certificate
N/A	N/A	N/A	N/A	N/A

2.8. Related Submittal(s) / Grant (s)

This submittal(s) (test report) is intended for **FCC ID:2AKUCMKFC05A** filing to comply with Section 15.249 of the FCC Part 15, Subpart C Rules.

2.9. Modifications

No modifications were implemented to meet testing criteria.

3. TEST ENVIRONMENT

3.1. Address of the test laboratory

Shenzhen Global Test Service Co.,Ltd.

No.7-101 and 8A-104, Building 7 and 8, DCC Cultural and Creative Garden, No.98, Pingxin North Road, Shangmugu Community, Pinghu Street, Longgang District, Shenzhen, Guangdong

3.2. Test Facility

The test facility is recognized, certified, or accredited by the following organizations:

CNAS (No. CNAS L8169)

Shenzhen Global Test Service Co., Ltd. has been assessed and proved to be in compliance with CNAS-CL01 Accreditation Criteria for Testing and Calibration Laboratories (identical to ISO/IEC 17025: 2017 General Requirements) for the Competence of Testing and Calibration Laboratories.

A2LA (Certificate No. 4758.01)

Shenzhen Global Test Service Co., Ltd. has been assessed by the American Association for Laboratory Accreditation (A2LA). Certificate No. 4758.01.

3.3. Environmental conditions

During the measurement the environmental conditions were within the listed ranges:

Temperature:	15-35 ° C
Humidity:	30-60 %
Atmospheric pressure:	950-1050mbar

3.4. Test Description

Test Items	Test Requirement	Result
Conducted Emissions	15.207	N/A
Radiated Emissions	15.205(a)/15.209/15.249(d)	PASS
Bandwidth	15.249	PASS
Emissions from out of band	15.249	PASS
Antenna Requirement	15.203	PASS

ReAprk:

1. The measurement uncertainty is not included in the test result.
2. NA = Not Applicable; NP = Not Performed

Preliminary tests were performed in different data rate to find the worst radiated emission. The data rate shown in the table below is the worst-case rate with respect to the specific test item. Investigation has been done on all the possible configurations for searching the worst cases. The following table is a list of the test modes shown in this test report.

3.5. Statement of the measurement uncertainty

The data and results referenced in this document are true and accurate. The reader is cautioned that there may be errors within the calibration limits of the equipment and facilities. The measurement uncertainty was calculated for all measurements listed in this test report acc. to CISPR 16 - 4 „Specification for radio disturbance and immunity measuring apparatus and methods – Part 4: Uncertainty in EMC Measurements“ and is documented in the Shenzhen Global Test Service Co.,Ltd quality system acc. to DIN EN ISO/IEC 17025. Furthermore, component and process variability of devices similar to that tested may result in additional deviation. The manufacturer has the sole responsibility of continued compliance of the device.

Hereafter the best measurement capability for Shenzhen GTS laboratory is reported:

Test	Range	Measurement Uncertainty	Notes
Radiated Emission	30~1000MHz	4.10 dB	(1)
Radiated Emission	1~18GHz	4.32 dB	(1)
Radiated Emission	18-40GHz	5.54 dB	(1)
Conducted Disturbance	0.15~30MHz	3.12 dB	(1)

- (1) This uncertainty represents an expanded uncertainty expressed at approximately the 95% confidence level using a coverage factor of k=2.

3.6. Equipments Used during the Test

Test Equipment	Manufacturer	Model No.	Serial No.	Calibration Date	Calibration Due Date
LISN	R&S	ENV216	3560.6550.08	2018/09/28	2019/09/27
LISN	R&S	ESH2-Z5	893606/008	2018/09/27	2019/09/26
By-log Antenna	SCHWARZBECK	VULB9163	000976	2018/09/29	2019/09/28
EMI Test Receiver	R&S	ESCI	101102	2018/09/26	2019/09/25
Spectrum Analyzer	Agilent	N9020A	MY48010425	2018/09/17	2019/09/16
Spectrum Analyzer	R&S	FSV40-N	101800	2018/09/17	2019/09/16
Controller	EM Electronics	Controller EM 1000	N/A	2018/09/21	2019/09/20
Double Ridged Horn Antenna (1~18GHz)	SCHWARZBECK	BBHA 9120D	01622	2018/09/19	2019/09/18
Double Ridged Horn Antenna	Rohde&Schwarz	HF907	100265	2018/09/19	2019/09/18
Active Loop Antenna	SCHWARZBECK	FMZB1519	1519-037	2018/09/19	2019/09/18
Horn Antenna (18GHz~40GHz)	ETS	3116	00086467	2018/12/29	2019/12/28
Amplifier (26.5GHz~40GHz)	EMCI	EMC2654045	980028	2018/09/18	2019/09/17
Amplifier (0.1GHz~26.5GHz)	EMCI	EMC012645SE	980355	2018/09/19	2019/09/18
Temperature/Humidity Meter	Gangxing	CTH-608	02	2018/09/20	2019/09/19
High-Pass Filter	K&L	9SH10-2700/X12750-O/O	N/A	2018/09/20	2019/09/19
High-Pass Filter	K&L	41H10-1375/U12750-O/O	N/A	2018/09/20	2019/09/19
Data acquisition card	Agilent	U2531A	TW53323507	2018/09/20	2019/09/19
Power Sensor	Agilent	U2021XA	MY5365004	2018/09/20	2019/09/19
RF Cable	HUBER+SUHNER	RG214	N/A	2018/09/20	2019/09/19
Broadband Antenna	SCHWARZBECK	VULB 9163	00976	2018//9/29	2018//9/28
Conducted Emission	ES-K1	V1.71	N/A	N/A	N/A
Radiated Emission	JS32-RE	V2.5.0.9	N/A	N/A	N/A

Note: The Cal.Interval was one year.

4. TEST CONDITIONS AND RESULTS

4.1. AC Power Conducted Emission

TEST CONFIGURATION

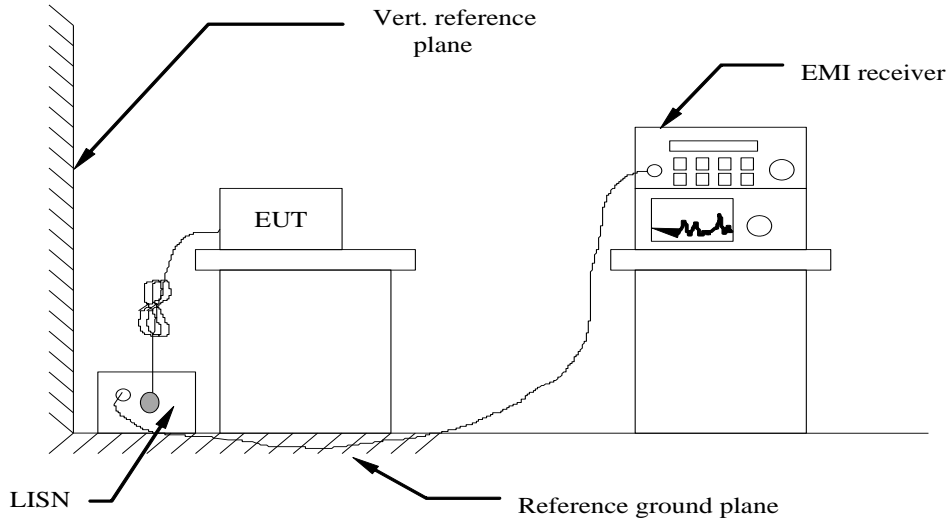

TEST PROCEDURE

- 1 The equipment was set up as per the test configuration to simulate typical actual usage per the user's manual. The EUT is a tabletop system, a wooden table with a height of 0.8 meters is used and is placed on the ground plane as per ANSI C63.10-2013.
- 2 Support equipment, if needed, was placed as per ANSI C63.10-2013
- 3 All I/O cables were positioned to simulate typical actual usage as per ANSI C63.10-2013
- 4 The EUT received DC 5V power from adapter, the adapter received AC120V/60Hz and AC 240V/60Hz power through a Line Impedance Stabilization Network (LISN) which supplied power source and was grounded to the ground plane.
- 5 All support equipments received AC power from a second LISN, if any.
- 6 The EUT test program was started. Emissions were measured on each current carrying line of the EUT using a spectrum Analyzer / Receiver connected to the LISN powering the EUT. The LISN has two monitoring points: Line 1 (Hot Side) and Line 2 (Neutral Side). Two scans were taken: one with Line 1 connected to Analyzer / Receiver and Line 2 connected to a 50 ohm load; the second scan had Line 1 connected to a 50 ohm load and Line 2 connected to the Analyzer / Receiver.
- 7 Analyzer / Receiver scanned from 150 KHz to 30MHz for emissions in each of the test modes.
- 8 During the above scans, the emissions were maximized by cable manipulation.

AC Power Conducted Emission Limit

For intentional device, according to § 15.207(a) AC Power Conducted Emission Limits is as following :

Frequency range (MHz)	Limit (dBuV)	
	Quasi-peak	Average
0.15-0.5	66 to 56*	56 to 46*
0.5-5	56	46
5-30	60	50

* Decreases with the logarithm of the frequency.

TEST RESULTS

There is no need for conduction emissions test, because the power supply of the EUT is battery only.

4.2. Radiated Emission

TEST CONFIGURATION

Frequency range 9 KHz – 30MHz

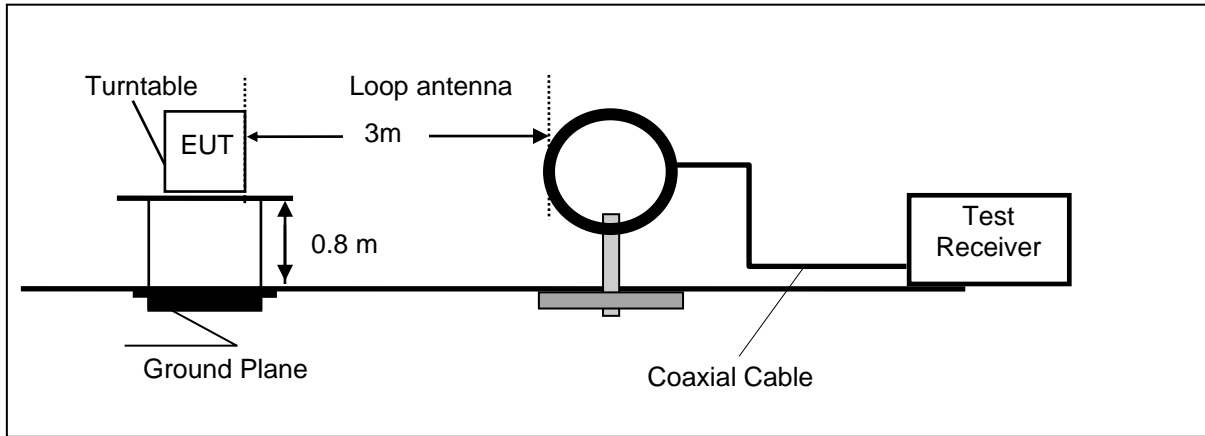

Frequency range 30MHz – 1000MHz

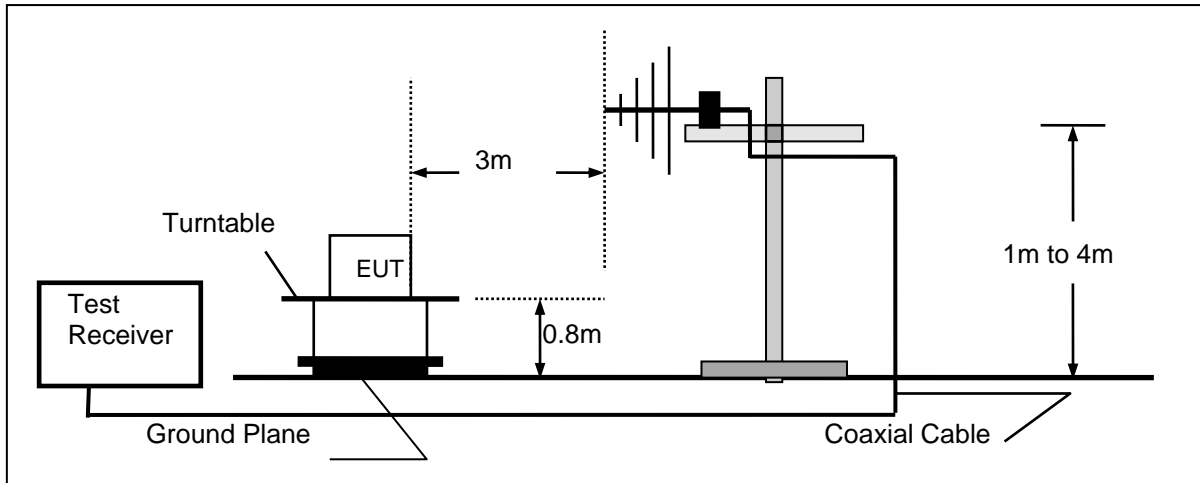

Frequency range above 1GHz-25GHz

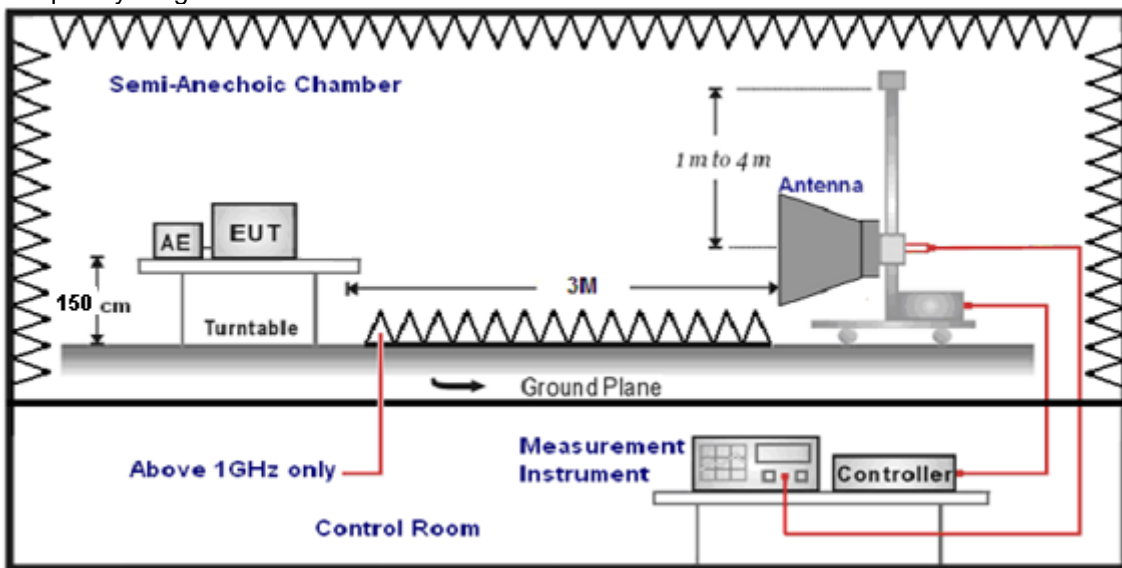

TEST PROCEDURE

1. The EUT was placed on a turn table which is 0.8m above ground plane when testing frequency range 9 KHz –1GHz;the EUT was placed on a turn table which is 1.5m above ground plane when testing frequency range 1GHz – 25GHz.
2. Maximum procedure was performed by raising the receiving antenna from 1m to 4m and rotating the turn table from 0° to 360° to acquire the highest emissions from EUT.
3. And also, each emission was to be maximized by changing the polarization of receiving antenna both horizontal and vertical.
4. Repeat above procedures until all frequency measurements have been completed.
5. Radiated emission test frequency band from 9KHz to 25GHz.
6. The distance between test antenna and EUT as following table states:

Test Frequency range	Test Antenna Type	Test Distance
9KHz-30MHz	Active Loop Antenna	3
30MHz-1GHz	Ultra-Broadband Antenna	3
1GHz-18GHz	Double Ridged Horn Antenna	3
18GHz-25GHz	Horn Antenna	1

7. Setting test receiver/spectrum as following table states:

Test Frequency range	Test Receiver/Spectrum Setting	Detector
9KHz-150KHz	RBW=200Hz/VBW=3KHz,Sweep time=Auto	QP
150KHz-30MHz	RBW=9KHz/VBW=100KHz,Sweep time=Auto	QP
30MHz-1GHz	RBW=120KHz/VBW=1000KHz,Sweep time=Auto	QP
1GHz-40GHz	Peak Value: RBW=1MHz/VBW=3MHz, Sweep time=Auto Average Value: RBW=1MHz/VBW=10Hz, Sweep time=Auto	Peak

Field Strength Calculation

The field strength is calculated by adding the Antenna Factor and Cable Factor and subtracting the Amplifier Gain and Duty Cycle Correction Factor(if any) from the measured reading. The basic equation with a sample calculation is as follows:

$$FS = RA + AF + CL - AG$$

Where FS = Field Strength	CL = Cable Attenuation Factor (Cable Loss)
RA = Reading Amplitude	AG = Amplifier Gain
AF = Antenna Factor	

$$Transd=AF +CL-AG$$

RADIATION LIMIT

For intentional device, according to § 15.209(a), the general requirement of field strength of radiated emission from intentional radiators at a distance of 3 meters shall not exceed the following table. According to § 15.247(d), in any 100kHz bandwidth outside the frequency band in which the EUT is operating, the radio frequency power that is produced by the intentional radiator shall be at least 20dB below that in the100kHz bandwidth within the band that contains the highest level of desired power.

The pre-test have done for the EUT in three axes and found the worst emission at position shown in test setup photos.

Frequency (MHz)	Distance (Meters)	Radiated (dBµV/m)	Radiated (µV/m)
0.009-0.49	3	20log(2400/F(KHz))+40log(300/3)	2400/F(KHz)
0.49-1.705	3	20log(24000/F(KHz))+ 40log(30/3)	24000/F(KHz)
1.705-30	3	20log(30)+ 40log(30/3)	30
30-88	3	40.0	100
88-216	3	43.5	150
216-960	3	46.0	200
Above 960	3	54.0	500

TEST RESULTS

For 30MHz-1GHz

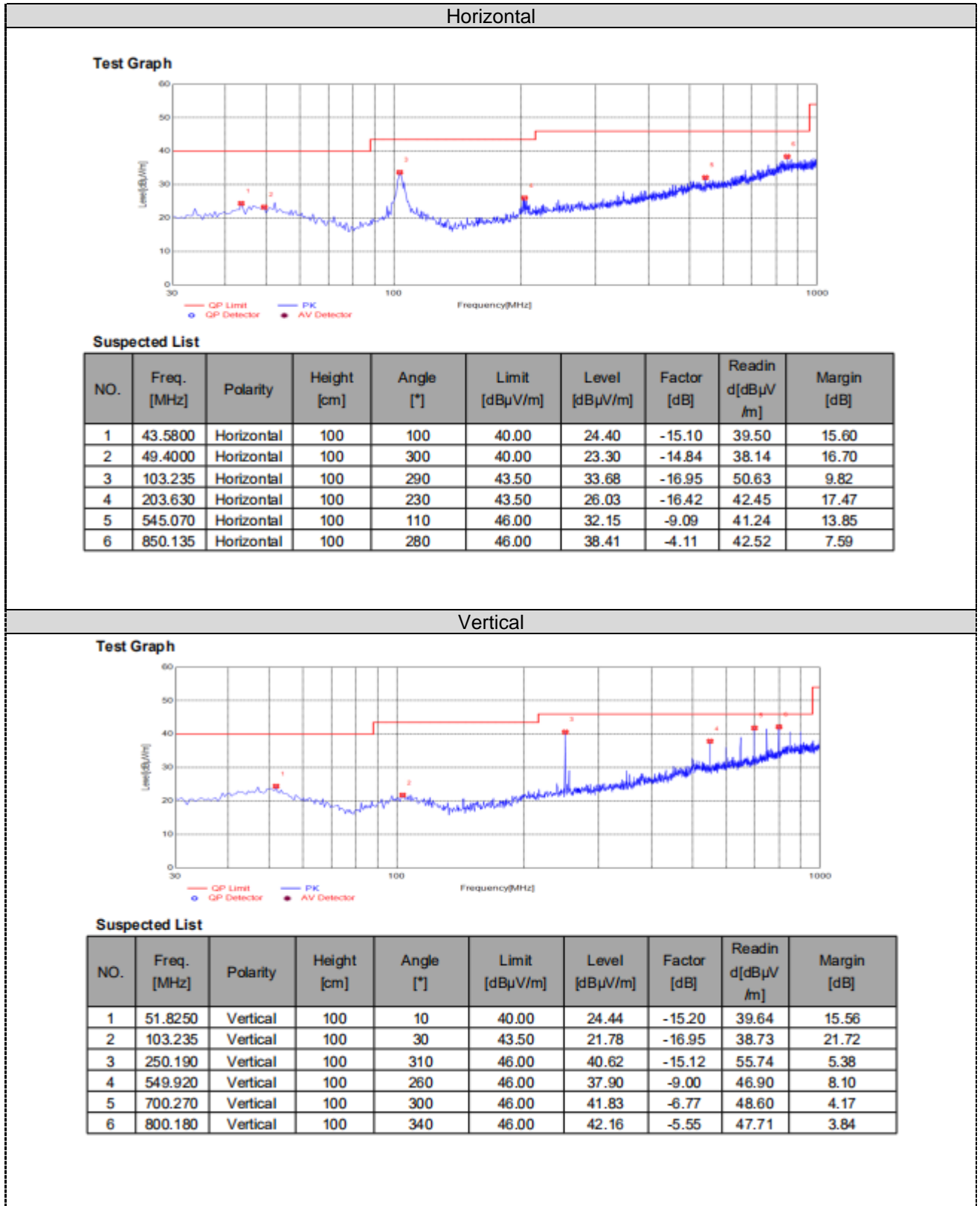

Note:

1. Pre-scan all modes and recorded the worst case results in this report.
2. Emission level (dBuV/m) = Meter Reading+ antenna Factor+ cable loss- preamp factor
3. Margin value = Emission level-Limits

For 1GHz to 25GHz

Frequency (MHz)	Reading (dB μ V)	Antenna Factor (dB)	Preamp factor (dB)	cable loss (dB)	Corrected Amplitude (dB μ V/m)	Limit (dB μ V/m)	Aprgin (dB)	ReAprk	Polar (H/V)
Low channel(2405MHz)									
2405	83.97	38.01	30.61	5.62	96.99	114	-17.01	Pk	Vertical
2405	73.78	38.01	30.61	5.62	86.80	94	-7.2	AV	Vertical
4810	45.63	32.42	30.25	7.95	55.75	74	-18.25	Pk	Vertical
4810	35.86	32.42	30.25	7.95	45.98	54	-8.02	AV	Vertical
2405	79.48	38.01	30.61	5.62	92.50	114	-21.5	Pk	Horizontal
2405	68.37	38.01	30.61	5.62	81.39	94	-12.61	AV	Horizontal
4810	40.38	32.42	30.25	7.95	50.50	74	-23.5	Pk	Horizontal
4810	31.49	32.42	30.25	7.95	41.61	54	-12.39	AV	Horizontal
Middle channel(2425MHz)									
2425	83.81	37.84	30.54	5.73	96.84	114	-17.16	Pk	Vertical
2425	73.12	37.84	30.54	5.73	86.15	94	-7.85	AV	Vertical
4850	47.27	32.48	30.31	8.12	57.56	74	-16.44	Pk	Vertical
4850	34.58	32.48	30.31	8.12	44.87	54	-9.13	AV	Vertical
2425	78.39	37.84	30.54	5.73	91.42	114	-22.58	Pk	Horizontal
2425	68.9	37.84	30.54	5.73	81.93	94	-12.07	AV	Horizontal
4850	40.65	32.48	30.31	8.12	50.94	74	-23.06	Pk	Horizontal
4850	30.02	32.48	30.31	8.12	40.31	54	-13.69	AV	Horizontal
High channel(2452MHz)									
2454	84.68	37.62	30.49	5.84	97.65	114	-16.35	Pk	Vertical
2454	74.79	37.62	30.49	5.84	87.76	94	-6.24	AV	Vertical
4908	45.32	32.64	30.27	7.88	55.57	74	-18.43	Pk	Vertical
4908	34.68	32.64	30.27	7.88	44.93	54	-9.07	AV	Vertical
2454	79.77	37.62	30.49	5.84	92.74	114	-21.26	Pk	Horizontal
2454	69.75	37.62	30.49	5.84	82.72	94	-11.28	AV	Horizontal
4908	39.72	32.64	30.27	7.88	49.97	74	-24.03	Pk	Horizontal
4908	31.07	32.64	30.27	7.88	41.32	54	-12.68	AV	Horizontal

NOTE:

Corrected Amplitude=Reading+ Antenna Factor+cable loss-Preamp factor

Aprgin= Absolute Level – Limit

The amplitude of spurious emissions which are attenuated by more than 20dB below the permissible value has not to be reported.

4.3. Bandwidth test

TEST PROCEDURE

- a. The EUT was directly connected to the spectru analyzer and antenna output port as show in the block diagram below.
- b. Spectrum Setting: RBW=100KHz, VBW ≥ RBW, Sweep=Auto.

Test setup



Test data:

Channel Frequency (MHz)	20dB Bandwidth (MHz)	Result
2405	4.7450	Pass
2425	5.1535	Pass
2454	4.8983	Pass

Test plot as follows:





4.4. Band Edge Compliance Test

Limits

In any 100 kHz bandwidth outside the frequency band in which the spread spectrum or digitally modulated intentional radiator is operating, the radio frequency power that is produced by the intentional radiator shall be at least 20 dB below that in the 100 kHz bandwidth within the band that contains the highest level of the desired power, based on either an RF conducted or a radiated measurement.

Test setup

The EUT was placed on a turn table which was 1.5 m above the ground. The turn table can rotate 360 degrees to determine the position of the maximum emission level. The EUT was set 3 m away from the receiving antenna which was mounted on an antenna tower. The measuring antenna moved up and down to find out the maximum emission level. It moved from 1 m to 4 m for both horizontal and vertical polarizations.

Set to span from the lowest frequency generated in the device up to and including the tenth harmonic of the highest fundamental frequency

The bandwidth of the Spectrum's VBW is set at 3MHz and RBW is set at 1MHz for peak emissions measurement above 1GHz and 1MHz RBW, 10Hz VBW for average emissions measure. For all test, used peak detector.

Note: If the PK measured levels comply with average limit, then the average level were deemed to comply with average limit.

For radiated test as follows:

EUT :	Programming building block drone	Model Name :	Ghost II-MC-1
Temperature :	25 °C	Relative Humidity :	54%
Pressure :	1010hPa	Test Voltage :	DC 11.1V
Test Mode :	GFSK		

Frequency	Meter Reading	Antenna Factor	Preamp factor	cable loss	Emission Level	Limits	Aprgin	Detector Type	Comment
(MHz)	(dBμV)	(dB)	(dB)	(dB)	(dBμV/m)	(dBμV/m)	(dB)		
2390	35.86	37.88	30.45	5.63	48.92	74	-25.08	peak	Vertical
2390	36.97	37.88	30.45	5.63	50.03	74	-23.97	peak	Horizontal
2483.5	37.66	37.45	30.38	5.71	50.44	74	-23.56	peak	Vertical
2483.5	36.95	37.45	30.38	5.71	49.73	74	-24.27	peak	Horizontal
hopping									
2390	36.63	37.88	30.45	5.63	49.69	74	-24.31	peak	Vertical
2390	38.71	37.88	30.45	5.63	51.77	74	-22.23	peak	Horizontal
2483.5	38.35	37.45	30.38	5.71	51.13	74	-22.87	peak	Vertical
2483.5	36.18	37.45	30.38	5.71	48.96	74	-25.04	peak	Horizontal

If the PK measured levels comply with average limit, then the average level were deemed to comply with average limit.

4.5. Antenna Requirements

Limits

For intentional device, according to FCC 47 CFR Section 15.203, an intentional radiator shall be designed to ensure that no antenna other than that furnished by the responsible party shall be used with the device. And according to FCC 47 CFR Section 15.247 (b), if transmitting antennas of directional gain greater than 6dBi are used, the power shall be reduced by the amount in dB that the directional gain of the antenna exceeds 6dBi.

Result

The antenna used for this product is FPC antenna and that no antenna other than that furnished by the responsible party shall be used with the device, the maximum peak gain of the transmit antenna is only 2.1dBi.

5. Test Setup Photos of the EUT

Radiated Emission Test

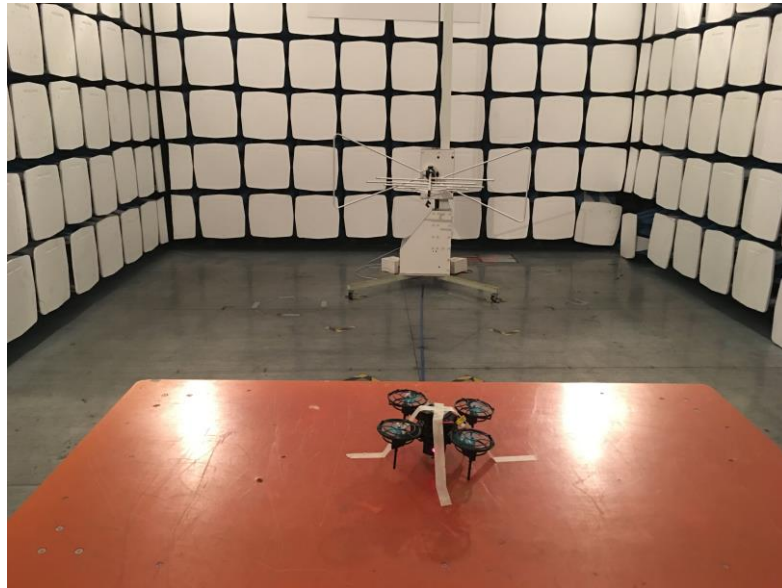

6. External and Internal Photos of the EUT

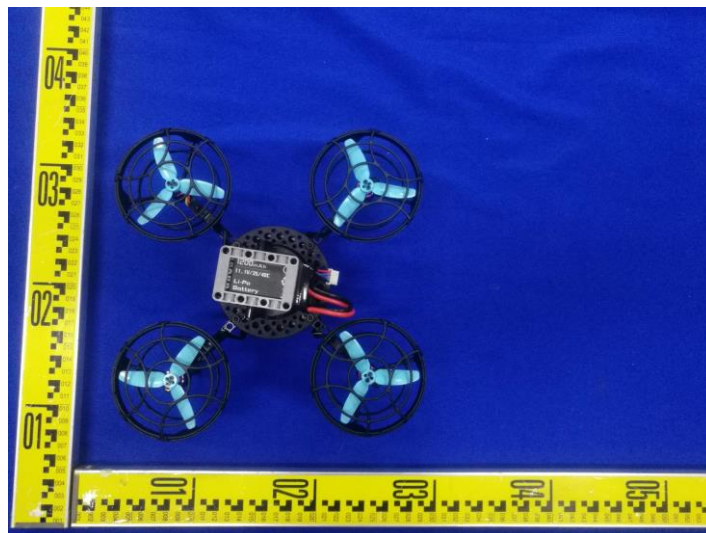

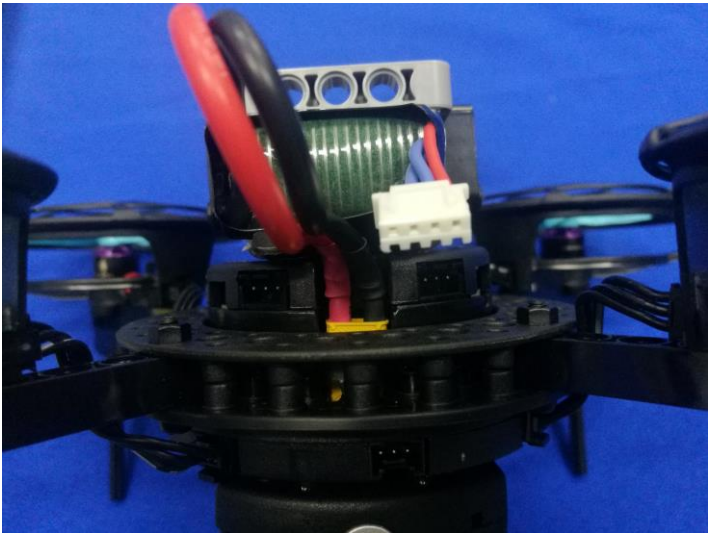
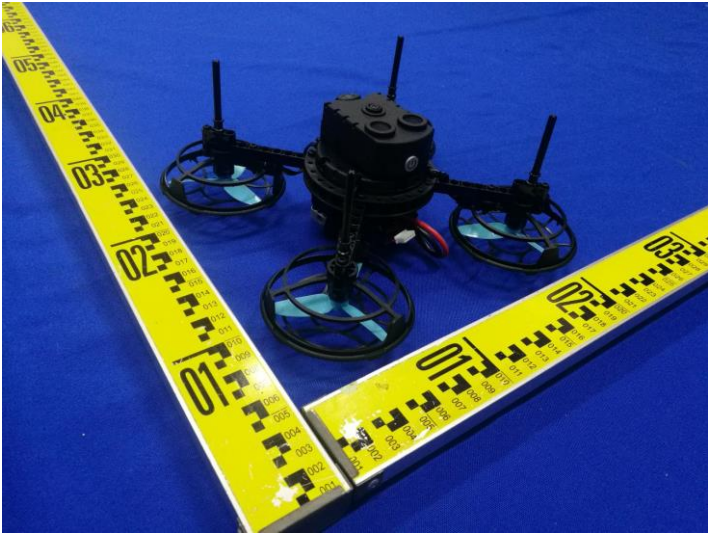



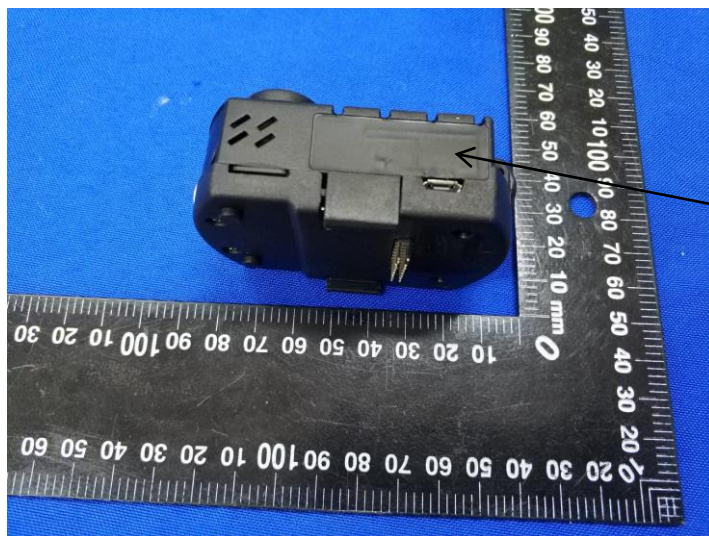

WIFI ANT

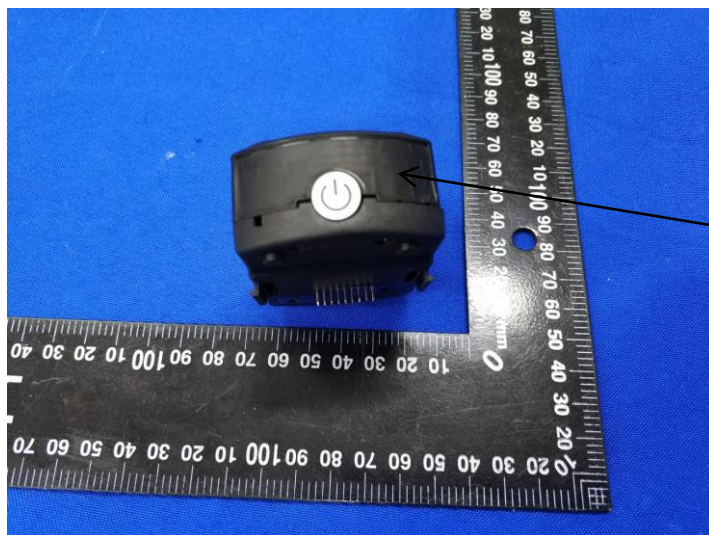

2.4G ANT

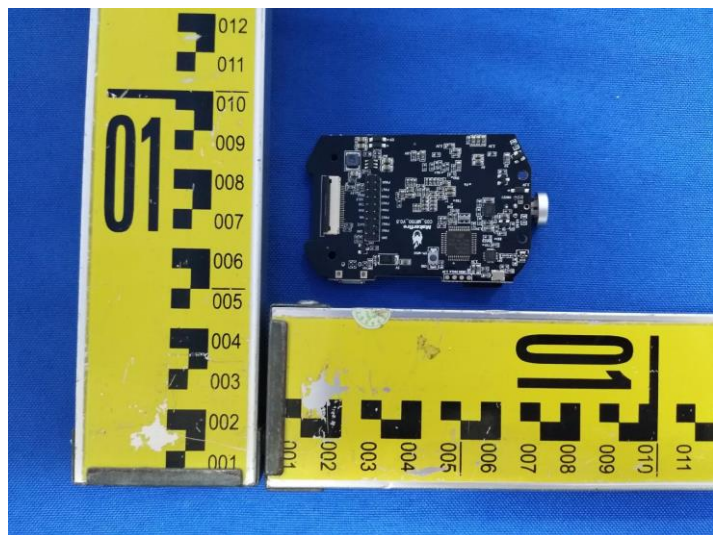
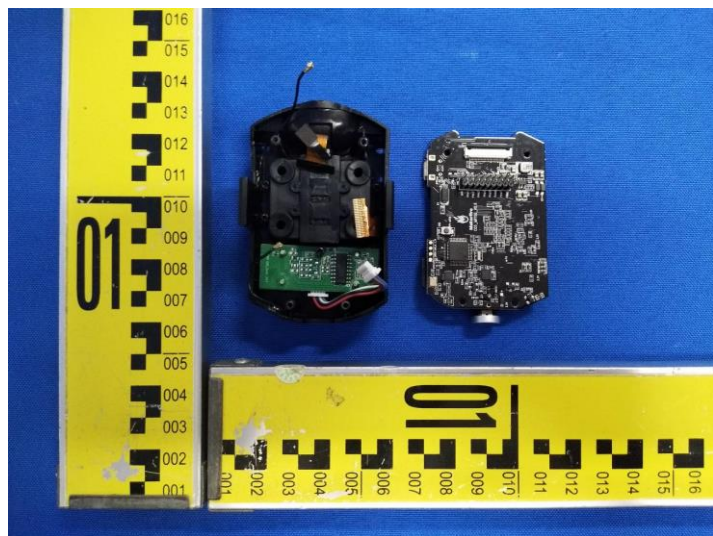
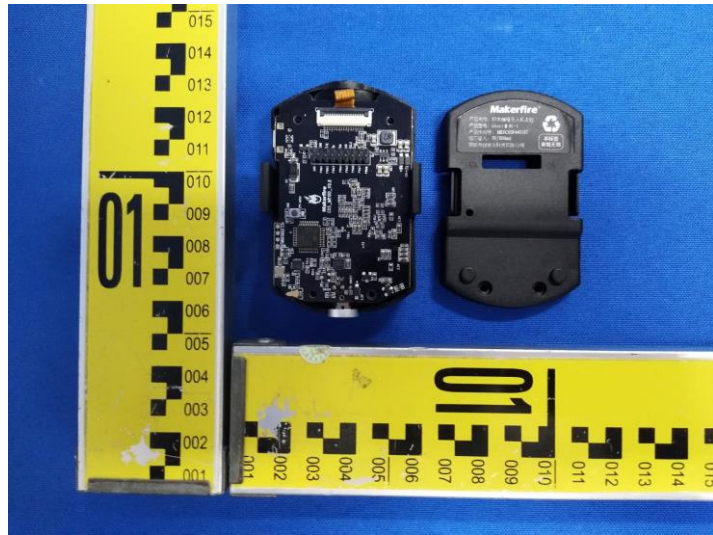

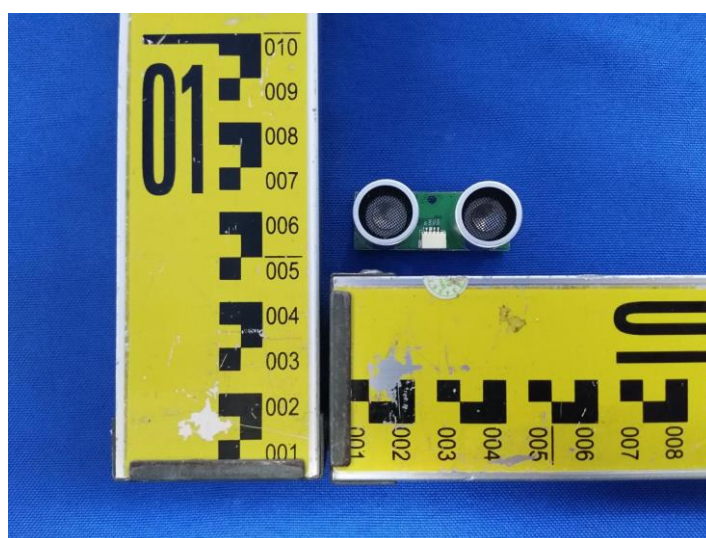
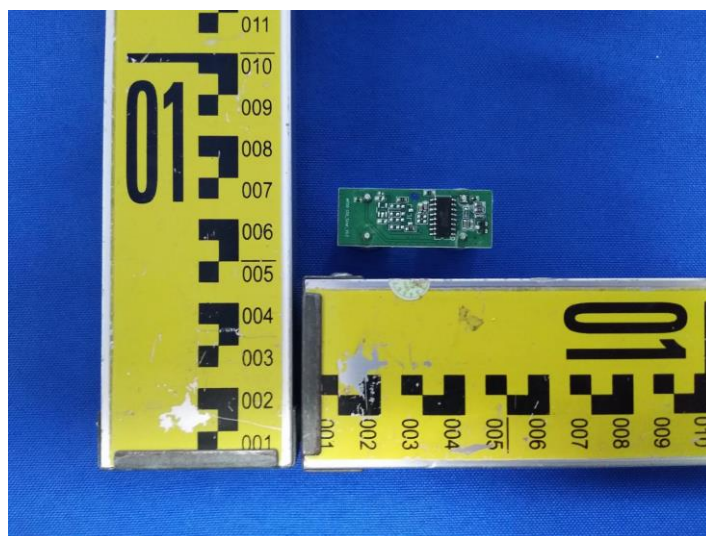
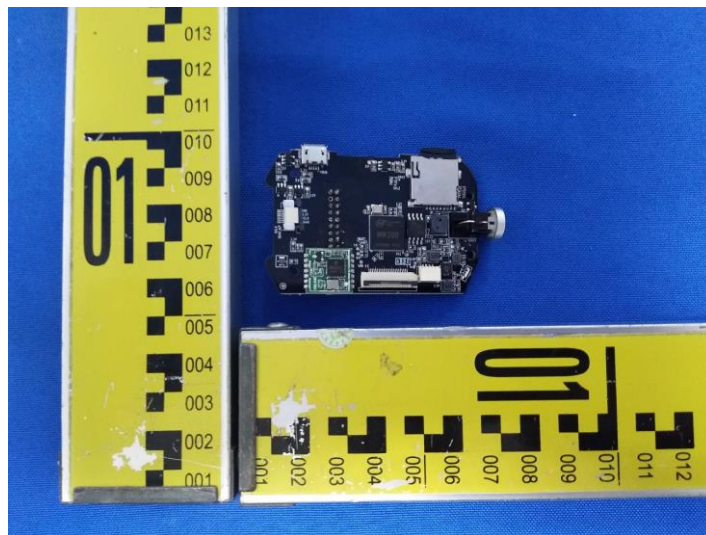

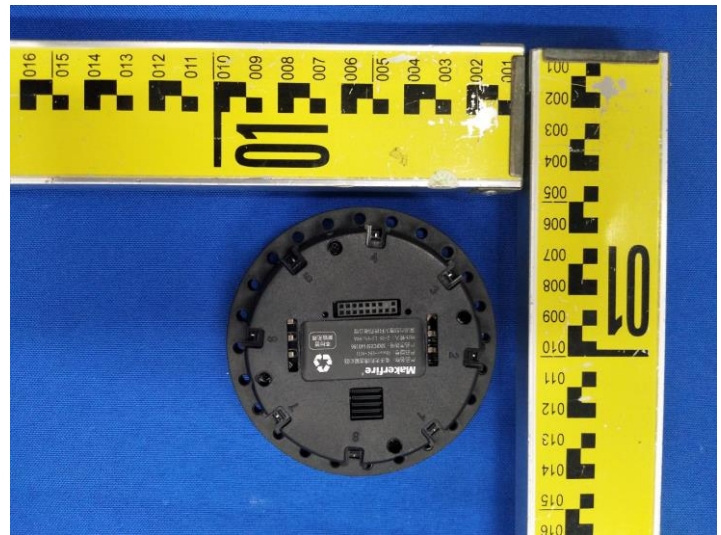
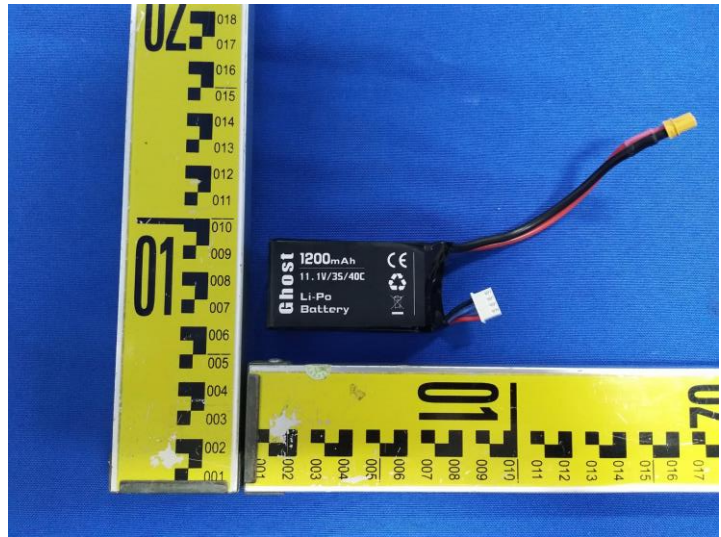

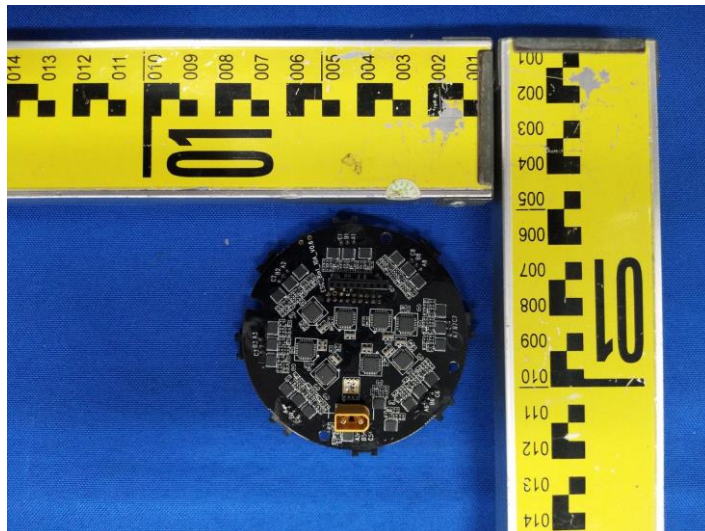

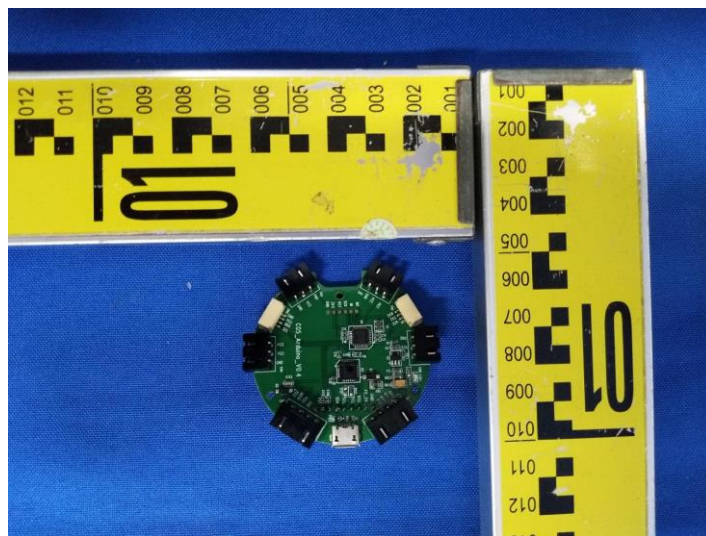
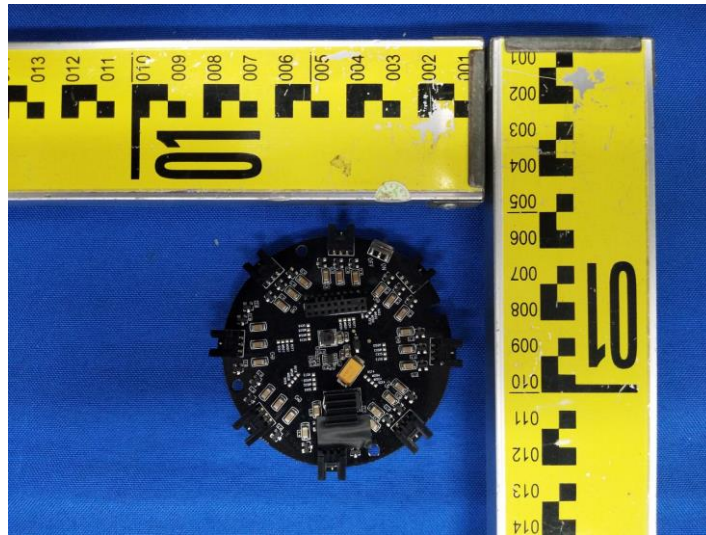

.....End of Report.....