

FCC Radio Test Report

FCC ID: 2AKSOH1001

This report concerns: Original Grant

Project No. : 2107C053
Equipment : H10 Low Latency Headband
Brand Name : AIAIAI
Test Model : H10
Series Model : N/A
Applicant : AIAIAI ApS
Address : Studiestræde 31,DK-1455 Copenhagen K,Denmark
Manufacturer : AIAIAI ApS
Address : Studiestræde 31,DK-1455 Copenhagen K,Denmark
Factory : OSM HUIZHOU LIMITED
Address : A02, Taixiang Road, High-tech Industrial Park, Sandong Town, Huicheng District, Huizhou City, Guangdong Province, P.R.C
Date of Receipt : Jul. 09, 2021
Date of Test : Jul. 14, 2021 ~ Nov. 02, 2021
Issued Date : Nov. 02, 2021
Report Version : R01
Test Sample : Engineering Sample No.: DG20210712160 for conducted, DG20210712162 for radiated.
Standard(s) : FCC CFR Title 47, Part 15, Subpart C
FCC KDB 558074 D01 15.247 Meas Guidance v05r02
ANSI C63.10-2013

The above equipment has been tested and found compliance with the requirement of the relative standards by BTL Inc.

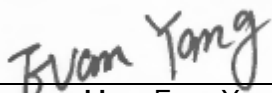
Prepared by : Evan Yang

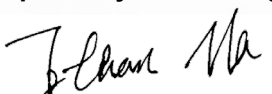
Approved by : Ethan Ma



TESTING CERT #5123.02

Add: No. 3 Jinshagang 1st Rd. Shixia, Dalang Town, Dongguan City, Guangdong, People's Republic of China

Tel: +86-769-8318-3000

Web: www.newbtl.com

Declaration

BTL represents to the client that testing is done in accordance with standard procedures as applicable and that test instruments used has been calibrated with standards traceable to international standard(s) and/or national standard(s).

BTL's reports apply only to the specific samples tested under conditions. It is manufacture's responsibility to ensure that additional production units of this model are manufactured with the identical electrical and mechanical components. **BTL** shall have no liability for any declarations, inferences or generalizations drawn by the client or others from **BTL** issued reports.

The report must not be used by the client to claim product certification, approval, or endorsement by NVLAP, NIST, A2LA, or any agency of the U.S. Government.

This report is the confidential property of the client. As a mutual protection to the clients, the public and ourselves, the test report shall not be reproduced, except in full, without our written approval.

BTL's laboratory quality assurance procedures are in compliance with the **ISO/IEC 17025** requirements, and accredited by the conformity assessment authorities listed in this test report.

BTL is not responsible for the sampling stage, so the results only apply to the sample as received.

The information, data and test plan are provided by manufacturer which may affect the validity of results, so it is manufacturer's responsibility to ensure that the apparatus meets the essential requirements of applied standards and in all the possible configurations as representative of its intended use.

Limitation

For the use of the authority's logo is limited unless the Test Standard(s)/Scope(s)/Item(s) mentioned in this test report is (are) included in the conformity assessment authorities acceptance respective.

Please note that the measurement uncertainty is provided for informational purpose only and are not use in determining the Pass/Fail results.

Table of Contents	Page
REPORT ISSUED HISTORY	6
1 . SUMMARY OF TEST RESULTS	7
1.1 TEST FACILITY	8
1.2 MEASUREMENT UNCERTAINTY	8
1.3 TEST ENVIRONMENT CONDITIONS	8
2 . GENERAL INFORMATION	9
2.1 GENERAL DESCRIPTION OF EUT	9
2.2 DESCRIPTION OF TEST MODES	11
2.3 PARAMETERS OF TEST SOFTWARE	11
2.4 BLOCK DIAGRAM SHOWING THE CONFIGURATION OF SYSTEM TESTED	12
2.5 SUPPORT UNITS	12
3 . AC POWER LINE CONDUCTED EMISSIONS	13
3.1 LIMIT	13
3.2 TEST PROCEDURE	13
3.3 DEVIATION FROM TEST STANDARD	13
3.4 TEST SETUP	14
3.5 EUT OPERATING CONDITIONS	14
3.6 TEST RESULTS	14
4 . RADIATED EMISSIONS	15
4.1 LIMIT	15
4.2 TEST PROCEDURE	16
4.3 DEVIATION FROM TEST STANDARD	17
4.4 TEST SETUP	17
4.5 EUT OPERATING CONDITIONS	18
4.6 TEST RESULT - 9 KHZ TO 30 MHZ	18
4.7 TEST RESULT - 30 MHZ TO 1000 MHZ	18
4.8 TEST RESULT - ABOVE 1000 MHZ	18
5 . BANDWIDTH	19
5.1 LIMIT	19
5.2 TEST PROCEDURE	19
5.3 DEVIATION FROM STANDARD	19
5.4 TEST SETUP	19

Table of Contents	Page
5.5 EUT OPERATION CONDITIONS	19
5.6 TEST RESULTS	19
6 . MAXIMUM OUTPUT POWER	20
6.1 LIMIT	20
6.2 TEST PROCEDURE	20
6.3 DEVIATION FROM STANDARD	20
6.4 TEST SETUP	20
6.5 EUT OPERATION CONDITIONS	20
6.6 TEST RESULTS	20
7 . CONDUCTED SPURIOUS EMISSION	21
7.1 LIMIT	21
7.2 TEST PROCEDURE	21
7.3 DEVIATION FROM STANDARD	21
7.4 TEST SETUP	21
7.5 EUT OPERATION CONDITIONS	21
7.6 TEST RESULTS	21
8 . POWER SPECTRAL DENSITY	22
8.1 LIMIT	22
8.2 TEST PROCEDURE	22
8.3 DEVIATION FROM STANDARD	22
8.4 TEST SETUP	22
8.5 EUT OPERATION CONDITIONS	22
8.6 TEST RESULTS	22
9 . MEASUREMENT INSTRUMENTS LIST	23
10 . EUT TEST PHOTO	25
APPENDIX A - AC POWER LINE CONDUCTED EMISSIONS	29
APPENDIX B - RADIATED EMISSION - 9 KHZ TO 30 MHZ	32
APPENDIX C - RADIATED EMISSION - 30 MHZ TO 1000 MHZ	37
APPENDIX D - RADIATED EMISSION - ABOVE 1000 MHZ	40
APPENDIX E - BANDWIDTH	65
APPENDIX F - MAXIMUM OUTPUT POWER	68

Table of Contents**Page****APPENDIX G - CONDUCTED SPURIOUS EMISSION****70****APPENDIX H - POWER SPECTRAL DENSITY****73**

REPORT ISSUED HISTORY

Report Version	Description	Issued Date
R00	Original Issue.	Oct. 26, 2021
R01	Revised report to address comments.	Nov. 02, 2021

1. SUMMARY OF TEST RESULTS

Test procedures according to the technical standard(s):

FCC CFR Title 47, Part 15, Subpart C				
Standard(s) Section	Test Item	Test Result	Judgment	Remark
15.207	AC Power Line Conducted Emissions	APPENDIX A	PASS	-----
15.247(d) 15.205(a) 15.209(a)	Radiated Emissions	APPENDIX B APPENDIX C APPENDIX D	PASS	-----
15.247(a)(2)	Bandwidth	APPENDIX E	PASS	-----
15.247(b)(3)	Maximum Output Power	APPENDIX F	PASS	-----
15.247(d)	Conducted Spurious Emission	APPENDIX G	PASS	-----
15.247(e)	Power Spectral Density	APPENDIX H	PASS	-----
15.203	Antenna Requirement	-----	PASS	Note(2)

Note:

- (1) "N/A" denotes test is not applicable to this device.
- (2) The device what use a permanently attached antenna were considered sufficient to comply with the provisions of 15.203.

1.1 TEST FACILITY

The test facilities used to collect the test data in this report is at the location of No. 3 Jinshagang 1st Rd. Shixia, Dalang Town, Dongguan City, Guangdong, People's Republic of China.

BTL's Test Firm Registration Number for FCC: 357015

BTL's Designation Number for FCC: CN1240

1.2 MEASUREMENT UNCERTAINTY

ISO/IEC 17025 requires that an estimate of the measurement uncertainties associated with the emissions test results be included in the report. The measurement uncertainties given below are based on a 95% confidence level (based on a coverage factor (k=2))

The BTL measurement uncertainty as below table:

A. AC power line conducted emissions test:

Test Site	Method	Measurement Frequency Range	U, (dB)
DG-C02	CISPR	150kHz ~ 30MHz	2.68

B. Radiated emissions Measurement:

Test Site	Method	Measurement Frequency Range	Ant. H / V	U, (dB)
DG-CB03	CISPR	9kHz ~ 30MHz	-	3.02
		30MHz ~ 200MHz	V	4.36
		30MHz ~ 200MHz	H	3.32
		200MHz ~ 1,000MHz	V	4.08
		200MHz ~ 1,000MHz	H	3.96
		1GHz ~ 6GHz	-	3.80
		6GHz ~ 18GHz	-	4.82
		18GHz ~ 26.5GHz	-	3.62
		26.5GHz ~ 40GHz	-	4.00

C. Other Measurement:

Test Item	Uncertainty
Bandwidth	±3.8 %
Maximum Output Power	±0.95 dB
Conducted Spurious Emission	±2.71 dB
Power Spectral Density	±0.86 dB
Temperature	±0.08 °C
Humidity	±1.5%

Note: Unless specifically mentioned, the uncertainty of measurement has not been taken into account to declare the compliance or non-compliance to the specification.

1.3 TEST ENVIRONMENT CONDITIONS

Test Item	Temperature	Humidity	Test Voltage	Tested By
AC Power Line Conducted Emissions	25°C	53%	AC 120V/60Hz	Laughing Zhang
Radiated Emissions-9 kHz to 30 MHz	25°C	60%	DC 5V	Hayden Chen
Radiated Emissions-30 MHz to 1000 MHz	26°C	52%	DC 5V	Hayden Chen
Radiated Emissions-Above 1000 MHz	26°C	52%	DC 5V	Jakyri Wen
Bandwidth	25°C	50%	DC 5V	Jesse Wang
Maximum Output Power	25°C	50%	DC 5V	Laughing Zhang
Conducted Spurious Emission	25°C	50%	DC 5V	Jesse Wang
Power Spectral Density	25°C	50%	DC 5V	Jesse Wang

2. GENERAL INFORMATION

2.1 GENERAL DESCRIPTION OF EUT

Equipment	H10 Low Latency Headband
Brand Name	AIAIAI
Test Model	H10
Series Model	N/A
Model Difference(s)	N/A
Software Version	H10_210823_01
Hardware Version	R1.4A
Power Source	1# DC Voltage supplied from AC adapter (support unit). 2# Supplied from battery. Model: 722640
Power Rating	1# I/P: 100-240V~ 50/60Hz O/P: 5V \equiv 2.0A 2# 3.8V 970mAh 3.686Wh
Operation Frequency	2402 MHz ~ 2480 MHz
Modulation Type	GFSK
Bit Rate of Transmitter	1Mbps, 2Mbps
Max. Output Power	2Mbps: 4.95 dBm (0.0031 W)

Note:

- For a more detailed features description, please refer to the manufacturer's specifications or the user's manual.

2. Channel List:

Channel	Frequency (MHz)	Channel	Frequency (MHz)
00	2402	20	2442
01	2404	21	2444
02	2406	22	2446
03	2408	23	2448
04	2410	24	2450
05	2412	25	2452
06	2414	26	2454
07	2416	27	2456
08	2418	28	2458
09	2420	29	2460
10	2422	30	2462
11	2424	31	2464
12	2426	32	2466
13	2428	33	2468
14	2430	34	2470
15	2432	35	2472
16	2434	36	2474
17	2436	37	2476
18	2438	38	2478
19	2440	39	2480

3. Table for Filed Antenna:

Ant.	Brand	Model Name	Antenna Type	Connector	Gain (dBi)
1	 OSM GROUP	H10 2.45GH BT ANT	IFA PCB	N/A	-1.8

Note: The antenna gain is provided by the manufacturer.

2.2 DESCRIPTION OF TEST MODES

The test system was pre-tested based on the consideration of all possible combinations of EUT operation mode.

Pretest Mode	Description
Mode 1	TX Mode_1Mbps Channel 00/19/39
Mode 2	TX Mode_2Mbps Channel 00/19/39
Mode 3	TX Mode_2Mbps Channel 00

Following mode(s) was (were) found to be the worst case(s) and selected for the final test.

AC power line conducted emissions test	
Final Test Mode	Description
Mode 3	TX Mode_2Mbps Channel 00

Radiated emissions test - Below 1GHz	
Final Test Mode	Description
Mode 3	TX Mode_2Mbps Channel 00

Radiated emissions test - Above 1GHz	
Final Test Mode	Description
Mode 1	TX Mode_1Mbps Channel 00/19/39
Mode 2	TX Mode_2Mbps Channel 00/19/39

Conducted test	
Final Test Mode	Description
Mode 1	TX Mode_1Mbps Channel 00/19/39
Mode 2	TX Mode_2Mbps Channel 00/19/39

Note:

- (1) For radiated emission above 1 GHz test, the spurious points of 1GHz~26.5GHz have been pre-tested and in this report only recorded the worst case. The remaining spurious points are all below the limit value of 20dB.
- (2) For AC power line conducted emissions and radiated emissions below 1 GHz test, the 2Mbps Channel 00 is found to be the worst case and recorded.

2.3 PARAMETERS OF TEST SOFTWARE

During testing channel & power controlling software provided by the customer was used to control the operating channel as well as the output power level.

Test Software Version	BlueTest3.3.5		
Frequency (MHz)	2402	2440	2480
1Mbps	N/A	N/A	N/A
2Mbps	N/A	N/A	N/A

2.4 BLOCK DIAGRAM SHOWING THE CONFIGURATION OF SYSTEM TESTED

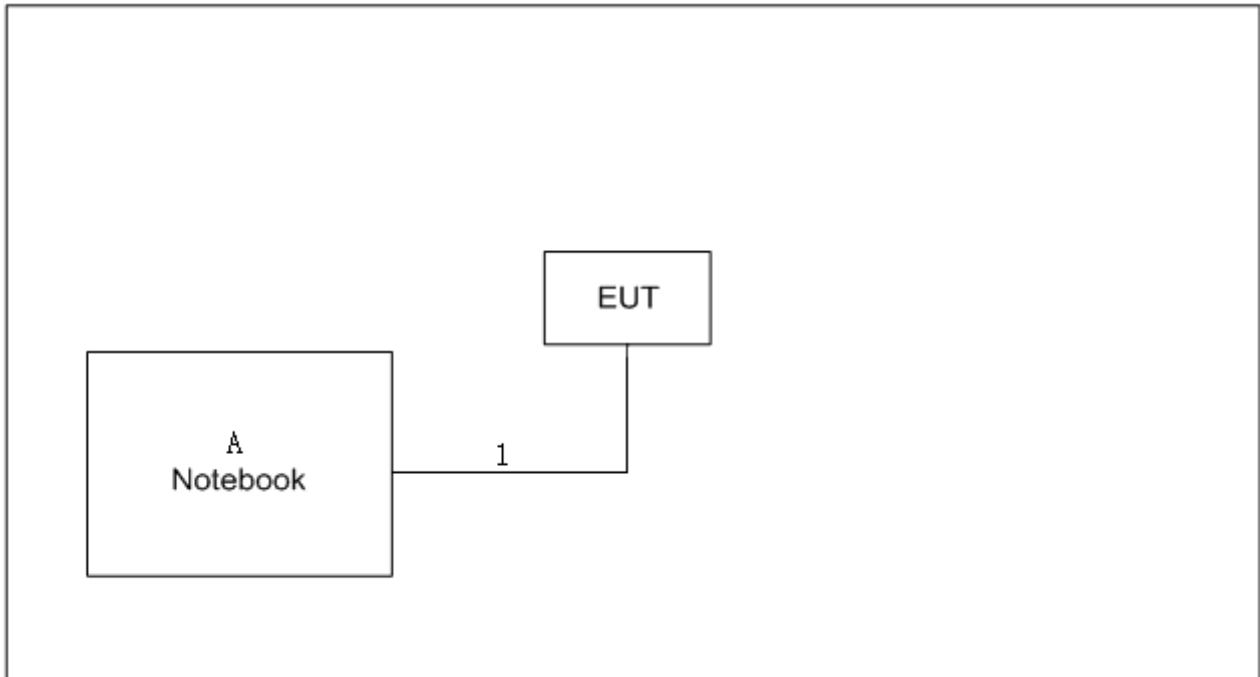

2.5 SUPPORT UNITS

Item	Equipment	Brand	Model No.	Series No.
A	Notebook	Lenovo	V310-14ISK	LR07GZNB

Item	Cable Type	Shielded Type	Ferrite Core	Length
1	USB Cable	NO	NO	0.8m

3. AC POWER LINE CONDUCTED EMISSIONS

3.1 LIMIT

Frequency of Emission (MHz)	Limit (dB μ V)	
	Quasi-peak	Average
0.15 - 0.5	66 to 56*	56 to 46*
0.5 - 5.0	56	46
5.0 - 30.0	60	50

Note:

- (1) The tighter limit applies at the band edges.
- (2) The limit of " * " marked band means the limitation decreases linearly with the logarithm of the frequency in the range.

3.2 TEST PROCEDURE

- a. The EUT was placed 0.8 meters from the horizontal ground plane with EUT being connected to the power mains through a line impedance stabilization network (LISN). All other support equipment powered from additional LISN(s). The LISN provide 50 Ohm/ 50uH of coupling impedance for the measuring instrument.
- b. Interconnecting cables that hang closer than 40 cm to the ground plane shall be folded back and forth in the center forming a bundle 30 to 40 cm long.
- c. I/O cables that are not connected to a peripheral shall be bundled in the center. The end of the cable may be terminated, if required, using the correct terminating impedance. The overall length shall not exceed 1 m.
- d. LISN at least 80 cm from nearest part of EUT chassis.
- e. For the actual test configuration, please refer to the related Item –EUT Test Photos.

The following table is the setting of the receiver:

Receiver Parameters	Setting
Start Frequency	0.15 MHz
Stop Frequency	30 MHz
IF Bandwidth	9 kHz

3.3 DEVIATION FROM TEST STANDARD

No deviation.

3.4 TEST SETUP

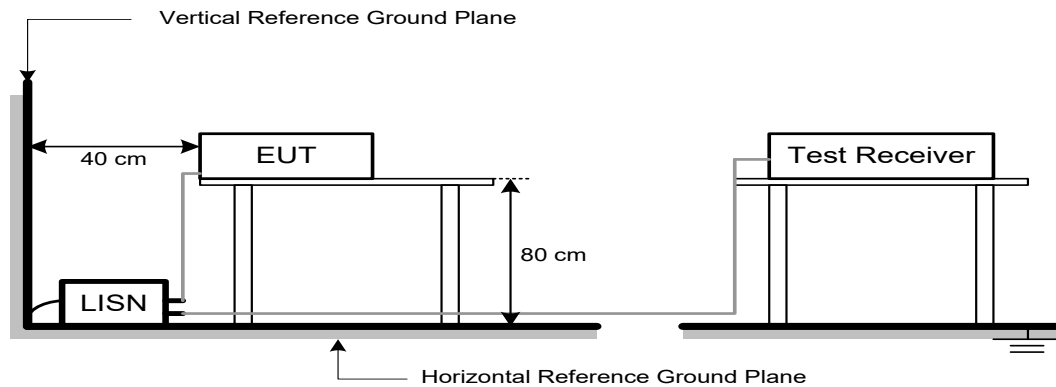

3.5 EUT OPERATING CONDITIONS

The EUT was configured for testing in a typical fashion (as a customer would normally use it). The EUT has been programmed to continuously transmit during test. This operating condition was tested and used to collect the included data.

3.6 TEST RESULTS

Please refer to the APPENDIX A.

Remark:

- (1) All readings are QP Mode value unless otherwise stated AVG in column of 『Note』 . If the QP Mode Measured value compliance with the QP Limits and lower than AVG Limits, the EUT shall be deemed to meet both QP & AVG Limits and then only QP Mode was measured, but AVG Mode didn't perform. In this case, a “ * ” marked in AVG Mode column of Interference Voltage Measured.
- (2) Measuring frequency range from 150 kHz to 30 MHz.

4. RADIATED EMISSIONS

4.1 LIMIT

In case the emission fall within the restricted band specified on 15.205(a) , then the 15.209(a) limit in the table below has to be followed.

LIMITS OF RADIATED EMISSION MEASUREMENT (9 kHz-1000 MHz)

Frequency (MHz)	Field Strength (microvolts/meter)	Measurement Distance (meters)
0.009-0.490	2400/F(kHz)	300
0.490-1.705	24000/F(kHz)	30
1.705-30.0	30	30
30-88	100	3
88-216	150	3
216-960	200	3
Above 960	500	3

LIMITS OF RADIATED EMISSION MEASUREMENT (Above 1000 MHz)

Frequency (MHz)	(dBuV/m at 3 m)	
	Peak	Average
Above 1000	74	54

Note:

- (1) The limit for radiated test was performed according to FCC CFR Title 47, Part 15, Subpart C.
- (2) The tighter limit applies at the band edges.
- (3) Emission level (dBuV/m)=20log Emission level (uV/m).

4.2 TEST PROCEDURE

- a. The measuring distance of 3 m shall be used for measurements. The EUT was placed on the top of a rotating table 0.8 meter above the ground at a 3 meter semi-anechoic chamber. The table was rotated 360 degrees to determine the position of the highest radiation.(below 1 GHz)
- b. The measuring distance of 3 m shall be used for measurements. The EUT was placed on the top of a rotating table 1.5 meter above the ground at a 3 meter semi-anechoic chamber. The table was rotated 360 degrees to determine the position of the highest radiation.(above 1 GHz)
- c. The height of the equipment or of the substitution antenna shall be 0.8m or 1.5m; the height of the test antenna shall vary between 1 m to 4 m. Both horizontal and vertical polarizations of the antenna are set to make the measurement.
- d. For each suspected emission, the EUT was arranged to its worst case and then the antenna was tuned to heights find the maximum reading (used Bore sight function).
- e. The receiver system was set to peak and average detect function and specified bandwidth with maximum hold mode when the test frequency is above 1 GHz.
- f. The initial step in collecting radiated emission data is a receiver peak detector mode pre-scanning the measurement frequency range. Significant peaks are then marked and then Quasi Peak detector mode re-measured.
- g. All readings are Peak unless otherwise stated QP in column of Note. Peak denotes that the Peak reading compliance with the QP Limits and then QP Mode measurement didn't perform. (below 1 GHz)
- h. All readings are Peak Mode value unless otherwise stated AVG in column of Note. If the Peak Mode Measured value compliance with the Peak Limits and lower than AVG Limits, the EUT shall be deemed to meet both Peak & AVG Limits and then only Peak Mode was measured, but AVG Mode didn't perform. (above 1 GHz)
- i. For the actual test configuration, please refer to the related Item –EUT Test Photos.

The following table is the setting of the receiver:

Spectrum Parameters	Setting
Start ~ Stop Frequency	9 kHz~150 kHz for RBW 200 Hz
Start ~ Stop Frequency	0.15 MHz~30 MHz for RBW 9 kHz
Start ~ Stop Frequency	30 MHz~1000 MHz for RBW 100 kHz

Spectrum Parameters	Setting
Start Frequency	1000 MHz
Stop Frequency	10th carrier harmonic
RBW / VBW (Emission in restricted band)	1 MHz / 3 MHz for PK value 1 MHz / 1/T Hz for AVG value

Spectrum Parameters	Setting
Start ~ Stop Frequency	9 kHz~90 kHz for PK/AVG detector
Start ~ Stop Frequency	90 kHz~110 kHz for QP detector
Start ~ Stop Frequency	110 kHz~490 kHz for PK/AVG detector
Start ~ Stop Frequency	490 kHz~30 MHz for QP detector
Start ~ Stop Frequency	30 MHz~1000 MHz for QP detector
Start ~ Stop Frequency	1 GHz~26.5 GHz for PK/AVG detector

4.3 DEVIATION FROM TEST STANDARD

No deviation.

4.4 TEST SETUP

9 kHz to 30 MHz

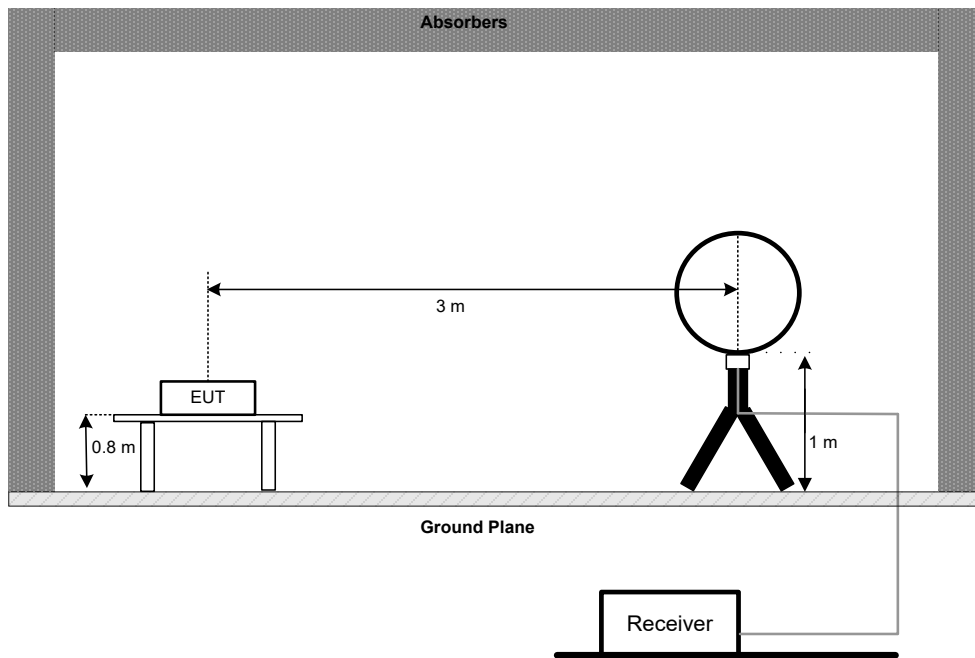

30 MHz to 1 GHz

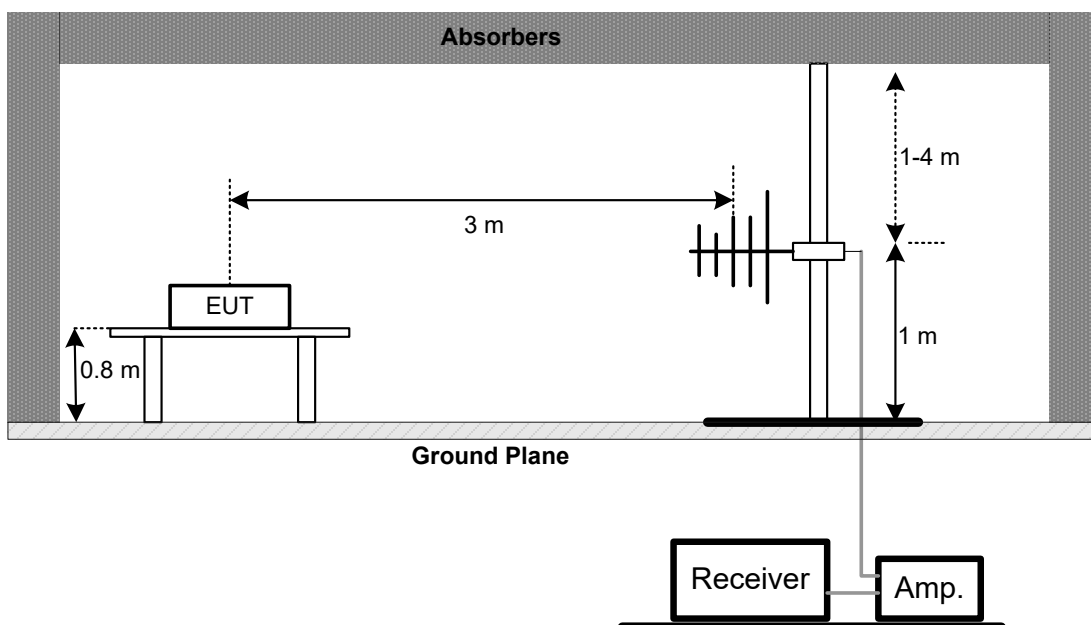

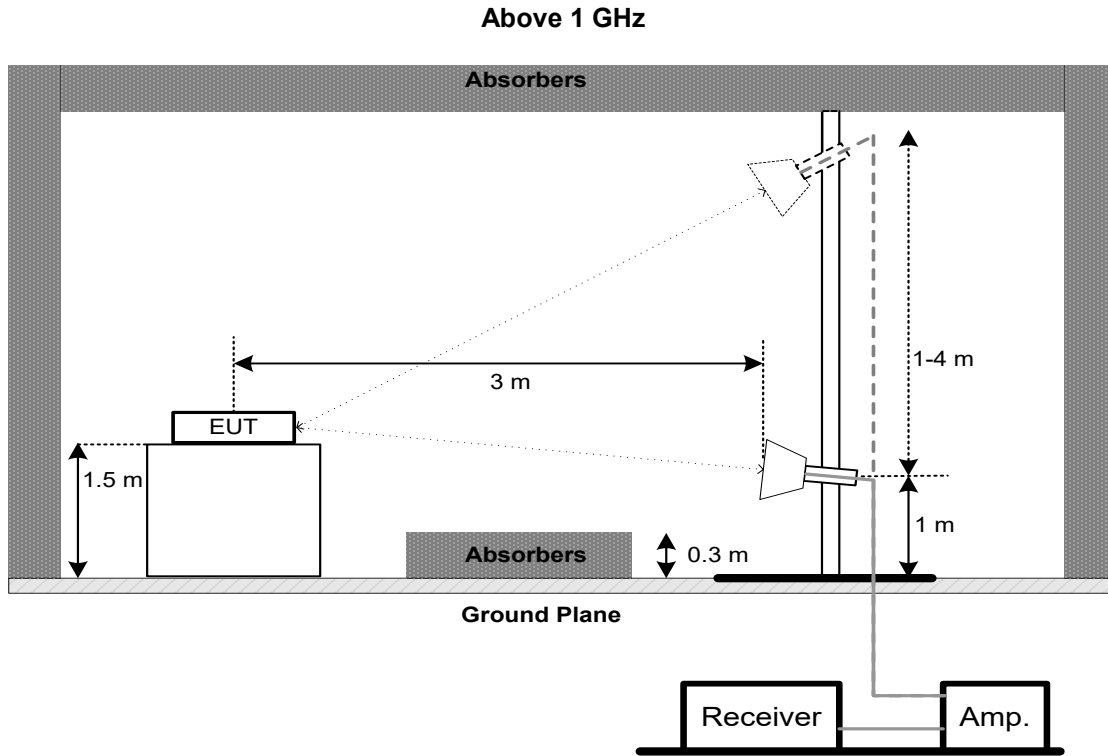

4.5 EUT OPERATING CONDITIONS

The EUT was programmed to be in continuously transmitting mode.

4.6 TEST RESULT - 9 kHz TO 30 MHz

Please refer to the APPENDIX B.

Remark:

- (1) Distance extrapolation factor = $40 \log(\text{specific distance} / \text{test distance})$ (dB).
- (2) Limit line = specific limits (dBuV) + distance extrapolation factor.

4.7 TEST RESULT - 30 MHz TO 1000 MHz

Please refer to the APPENDIX C.

4.8 TEST RESULT - ABOVE 1000 MHz

Please refer to the APPENDIX D.

Remark:

- (1) No limit: This is fundamental signal, the judgment is not applicable.
For fundamental signal judgment was referred to Peak output test.

5. BANDWIDTH

5.1 LIMIT

Section	Test Item	Limit
FCC 15.247(a)(2)	6 dB Bandwidth	≥ 500 kHz
	99% Emission Bandwidth	-

5.2 TEST PROCEDURE

- The EUT was directly connected to the spectrum analyzer and antenna output port as show in the block diagram below.
- The following table is the setting of the spectrum analyzer:

For 6 dB Bandwidth:

Spectrum Parameters	Setting
Span Frequency	$>$ Measurement Bandwidth
RBW	100 kHz
VBW	300 kHz
Detector	Peak
Trace	Max Hold
Sweep Time	Auto

For 99% Emission Bandwidth:

Spectrum Parameters	Setting
Span Frequency	Between 1.5 times and 5.0 times the OBW
RBW	30 kHz
VBW	100 kHz
Detector	Peak
Trace	Max Hold
Sweep Time	Auto

5.3 DEVIATION FROM STANDARD

No deviation.

5.4 TEST SETUP



5.5 EUT OPERATION CONDITIONS

The EUT was programmed to be in continuously transmitting mode.

5.6 TEST RESULTS

Please refer to the APPENDIX E.

6. MAXIMUM OUTPUT POWER**6.1 LIMIT**

Section	Test Item	Limit
FCC 15.247(b)(3)	Maximum Output Power	1.0000 watt or 30.00 dBm

6.2 TEST PROCEDURE

- a. The EUT was directly connected to the spectrum analyzer and antenna output port as show in the block diagram below.
- b. The following table is the setting of the spectrum analyzer:

Spectrum Parameters	Setting
Span Frequency	$\geq 3 \times \text{RBW}$
RBW	3 MHz
VBW	3 MHz
Detector	Peak
Trace	Max Hold
Sweep Time	Auto

6.3 DEVIATION FROM STANDARD

No deviation.

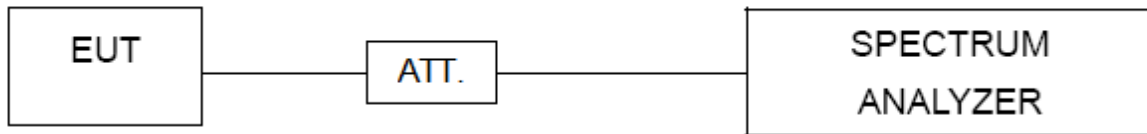
6.4 TEST SETUP**6.5 EUT OPERATION CONDITIONS**

The EUT was programmed to be in continuously transmitting mode.

6.6 TEST RESULTS

Please refer to the APPENDIX F.

7. CONDUCTED SPURIOUS EMISSION

7.1 LIMIT

In any 100 kHz bandwidth outside the frequency band in which the spread spectrum or digitally modulated intentional radiator is operating, the radio frequency power that is produced by the intentional radiator shall be at least 20 dB below that in the 100 kHz bandwidth within the band that contains the highest level of the desired power, based on either an RF conducted or a radiated measurement, provided the transmitter demonstrates compliance with the peak Output Power limits. If the transmitter complies with the Output Power limits based on the use of RMS averaging over a time interval, as permitted under paragraph (b)(3) of this section, the attenuation required under this paragraph shall be 30 dB instead of 20 dB. Attenuation below the general limits specified in Section 15.209(a) is not required.

7.2 TEST PROCEDURE

- a. The EUT was directly connected to the spectrum analyzer and antenna output port as show in the block diagram below.
- b. The following table is the setting of the spectrum analyzer:

Spectrum Parameters	Setting
Start Frequency	30 MHz
Stop Frequency	26.5 GHz
RBW	100 kHz
VBW	300 kHz
Detector	Peak
Trace	Max Hold
Sweep Time	Auto

7.3 DEVIATION FROM STANDARD

No deviation.

7.4 TEST SETUP

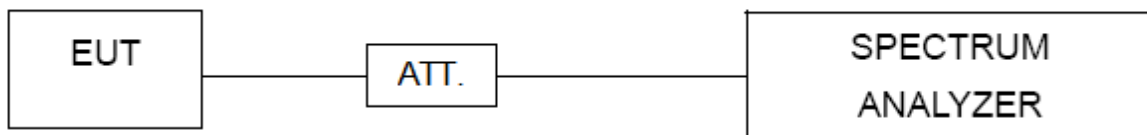

7.5 EUT OPERATION CONDITIONS

The EUT was programmed to be in continuously transmitting mode.

7.6 TEST RESULTS

Please refer to the APPENDIX G.

8. POWER SPECTRAL DENSITY

8.1 LIMIT

Section	Test Item	Limit
FCC 15.247(e)	Power Spectral Density	8 dBm (in any 3 kHz)

8.2 TEST PROCEDURE

- a. The EUT was directly connected to the spectrum analyzer and antenna output port as show in the block diagram below.
- b. The following table is the setting of the spectrum analyzer:

Spectrum Parameters	Setting
Span Frequency	2 MHz (1 Mbps) / 4 MHz (2 Mbps)
RBW	3 kHz
VBW	10 kHz
Detector	Peak
Trace	Max Hold
Sweep Time	Auto

8.3 DEVIATION FROM STANDARD

No deviation.

8.4 TEST SETUP

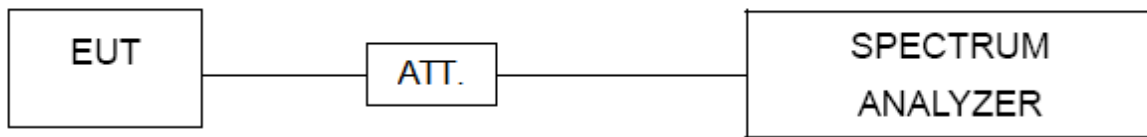

8.5 EUT OPERATION CONDITIONS

The EUT was programmed to be in continuously transmitting mode.

8.6 TEST RESULTS

Please refer to the APPENDIX H.

9. MEASUREMENT INSTRUMENTS LIST

AC Power Line Conducted Emissions					
Item	Kind of Equipment	Manufacturer	Type No.	Serial No.	Calibrated until
1	EMI Test Receiver	R&S	ESCI	100382	Feb. 28, 2022
2	LISN	EMCO	3816/2	52765	Feb. 27, 2022
3	TWO-LINE V-NETWORK	R&S	ENV216	101447	Feb. 27, 2022
4	50Ω Terminator	SHX	TF5-3	15041305	Feb. 27, 2022
5	Measurement Software	Farad	EZ-EMC Ver.NB-03A1-01	N/A	N/A
6	Cable	N/A	RG223	12m	Mar. 09, 2022
7	643 Shield Room	ETS	6*4*3m	N/A	N/A

Radiated Emissions - 9 kHz to 30 MHz					
Item	Kind of Equipment	Manufacturer	Type No.	Serial No.	Calibrated until
1	Loop Antenna	EM	EM-6876-1	230	Apr. 28, 2022
2	Cable	N/A	RG 213/U	N/A	May 27, 2022
3	EMI Test Receiver	R&S	ESCI	100895	Feb. 27, 2022
4	Measurement Software	Farad	EZ-EMC Ver.NB-03A1-01	N/A	N/A
5	966 Chambe Room	RM	9*6*6m	N/A	Jul. 26, 2021 Jul. 26, 2022

Radiated Emissions - 30 MHz to 1 GHz					
Item	Kind of Equipment	Manufacturer	Type No.	Serial No.	Calibrated until
1	Antenna	Schwarzbeck	VULB9160	9160-3232	Mar. 15, 2022
2	Amplifier	HP	8447D	2944A08742	Feb. 28, 2022
3	Receiver	Agilent	N9038A	MY52130039	Mar. 19, 2022
4	Cable	emci	LMR-400(30MHz-1 GHz)(8m+5m)	N/A	May 20, 2022
5	Controller	CT	SC100	N/A	N/A
6	Controller	MF	MF-7802	MF780208416	N/A
7	Measurement Software	Farad	EZ-EMC Ver.NB-03A1-01	N/A	N/A
8	966 Chambe Room	RM	9*6*6m	N/A	Jul. 26, 2021 Jul. 26, 2022

Radiated Emissions - Above 1 GHz					
Item	Kind of Equipment	Manufacturer	Type No.	Serial No.	Calibrated until
1	Double Ridged Guide Antenna	ETS	3115	75789	May 10, 2022
2	Broad-Band Horn Antenna	Schwarzbeck	BBHA 9170	9170319	Jun. 30, 2022
3	Amplifier	Agilent	8449B	3008A02584	Jul. 10, 2022
4	Microwave Preampifier With Adaptor	EMC INSTRUMENT	EMC2654045	980039 & HA01	Feb. 28, 2022
5	Receiver	Agilent	N9038A	MY52130039	Mar. 19, 2022
6	Controller	CT	SC100	N/A	N/A
7	Controller	MF	MF-7802	MF780208416	N/A
8	Cable	N/A	EMC104-SM-SM-6000	N/A	Oct. 16, 2021 Oct. 15, 2022
9	Measurement Software	Farad	EZ-EMC Ver.NB-03A1-01	N/A	N/A
10	Filter	STI	STI15-9912	N/A	Jul. 10, 2022
11	966 Chambe Room	RM	9*6*6m	N/A	Jul. 26, 2021 Jul. 26, 2022

**Bandwidth &
Maximum Output Power &
Power Spectral Density &
Conducted Spurious Emission**

Item	Kind of Equipment	Manufacturer	Type No.	Serial No.	Calibrated until
1	Spectrum Analyzer	R&S	FSP40	100185	Jul. 10, 2022
2	Attenuator	WOKEN	6SM3502	VAS1214NL	Feb. 07, 2022
3	RF Cable	Tongkaichuan	N/A	N/A	N/A
4	DC Block	Mini	N/A	N/A	N/A

Remark: "N/A" denotes no model name, serial no. or calibration specified.
All calibration period of equipment list is one year.

10. EUT TEST PHOTO**AC Power Line Conducted Emissions Test Photos**

Radiated Emissions Test Photos

9 kHz to 30 MHz

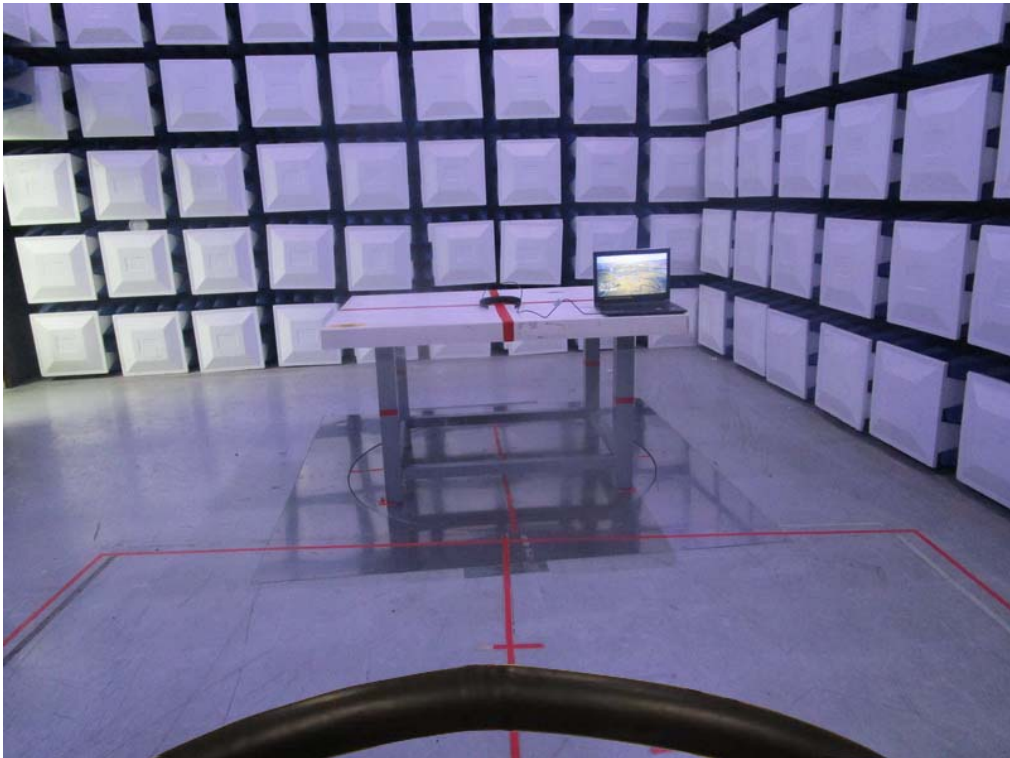

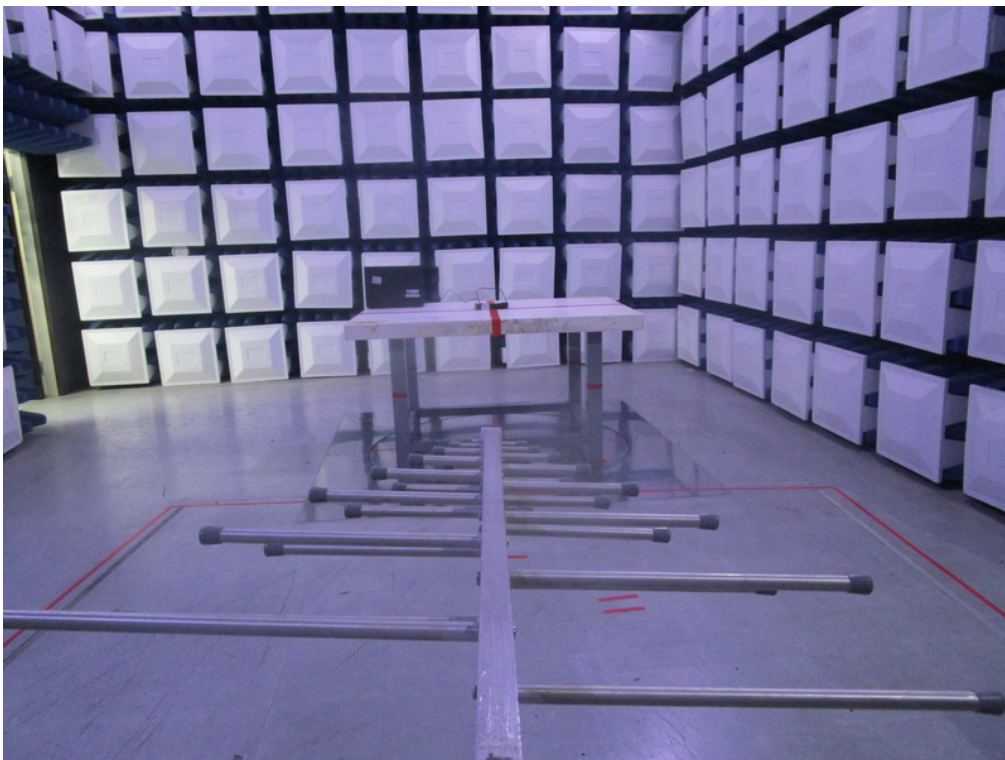
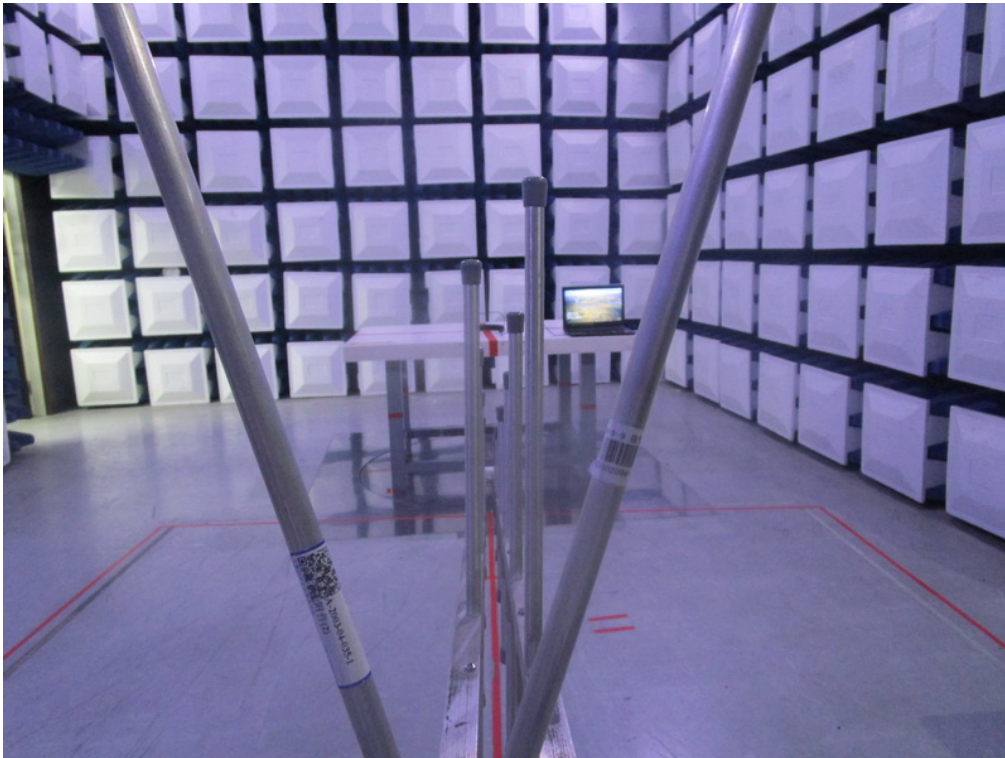
Radiated Emissions Test Photos**30 MHz to 1000 MHz**

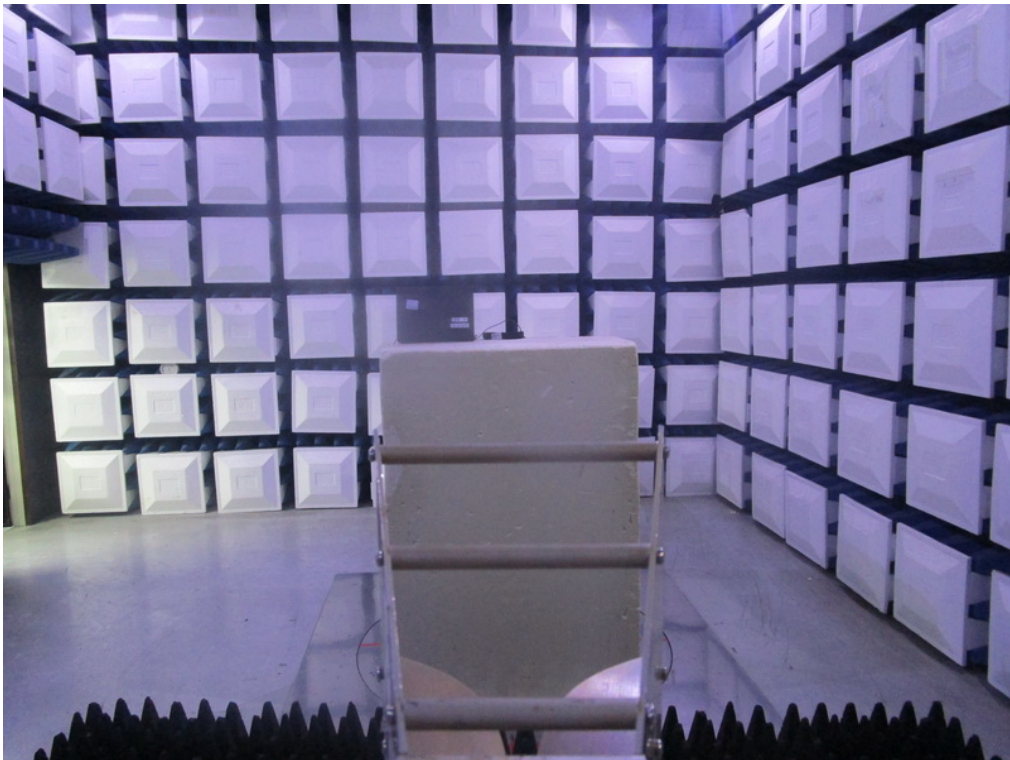
Radiated Emissions Test Photos**Above 1 GHz**

APPENDIX A - AC POWER LINE CONDUCTED EMISSIONS

Test Mode	TX Mode_2Mbps Channel 00	Phase	Line
-----------	--------------------------	-------	------

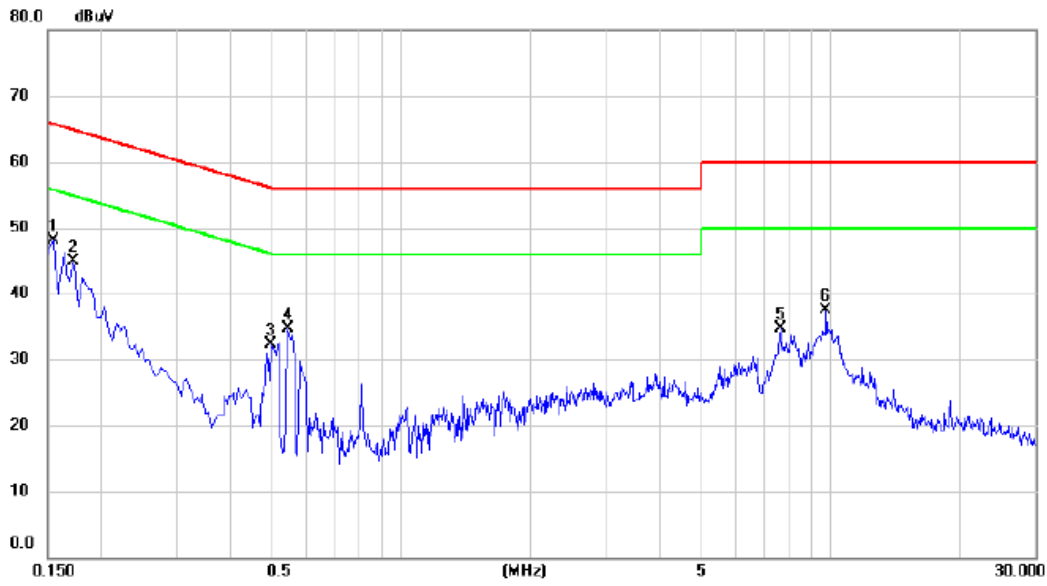

No. Mk.	Freq. MHz	Reading Level dBuV	Correct Factor dB	Measurement dBuV	Limit dBuV	Margin dB	Detector	Comment
1 *	0.1545	38.38	9.70	48.08	65.75	-17.67	peak	
2	0.1725	35.04	9.83	44.87	64.84	-19.97	peak	
3	0.4965	22.41	9.93	32.34	56.06	-23.72	peak	
4	0.5460	24.74	9.93	34.67	56.00	-21.33	peak	
5	7.6200	24.26	10.48	34.74	60.00	-25.26	peak	
6	9.7485	26.81	10.63	37.44	60.00	-22.56	peak	

REMARKS:

- (1) Measurement Value = Reading Level + Correct Factor.
- (2) Margin Level = Measurement Value - Limit Value.

Test Mode	TX Mode_2Mbps Channel 00	Phase	Neutral
-----------	--------------------------	-------	---------

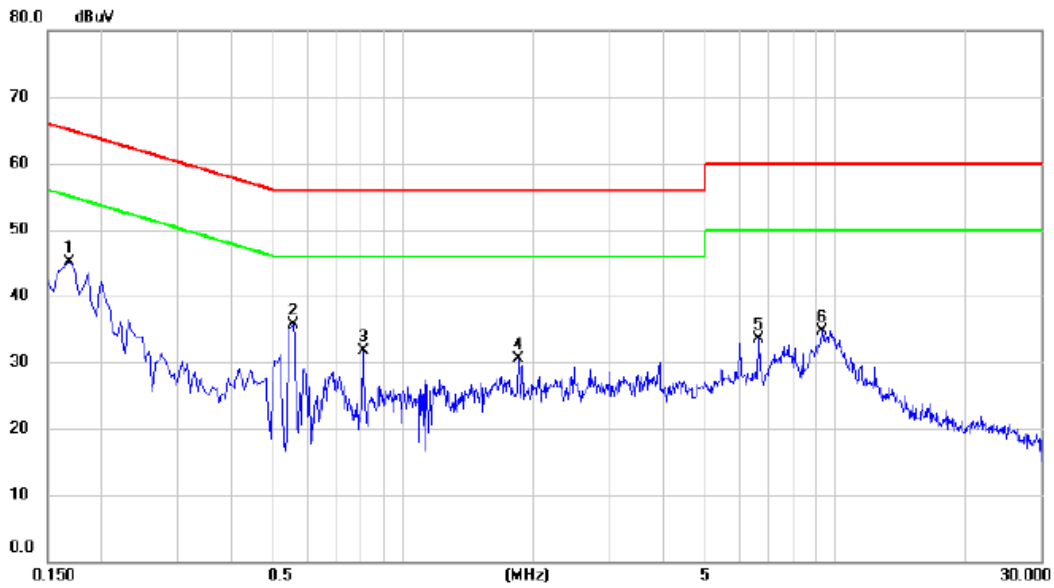

No.	Mk.	Freq. MHz	Reading Level dBuV	Correct Factor dB	Measure- ment dBuV	Limit dBuV	Margin dB	Detector	Comment
1	*	0.1680	35.26	9.88	45.14	65.06	-19.92	peak	
2		0.5550	25.50	10.15	35.65	56.00	-20.35	peak	
3		0.8070	21.39	10.22	31.61	56.00	-24.39	peak	
4		1.8420	20.06	10.36	30.42	56.00	-25.58	peak	
5		6.6345	22.85	10.75	33.60	60.00	-26.40	peak	
6		9.3120	23.84	10.96	34.80	60.00	-25.20	peak	

REMARKS:

- (1) Measurement Value = Reading Level + Correct Factor.
- (2) Margin Level = Measurement Value - Limit Value.

APPENDIX B - RADIATED EMISSION - 9 KHZ TO 30 MHZ

Test Mode	TX Mode_2Mbps Channel 00	Polarization	Ant 0°
-----------	--------------------------	--------------	--------

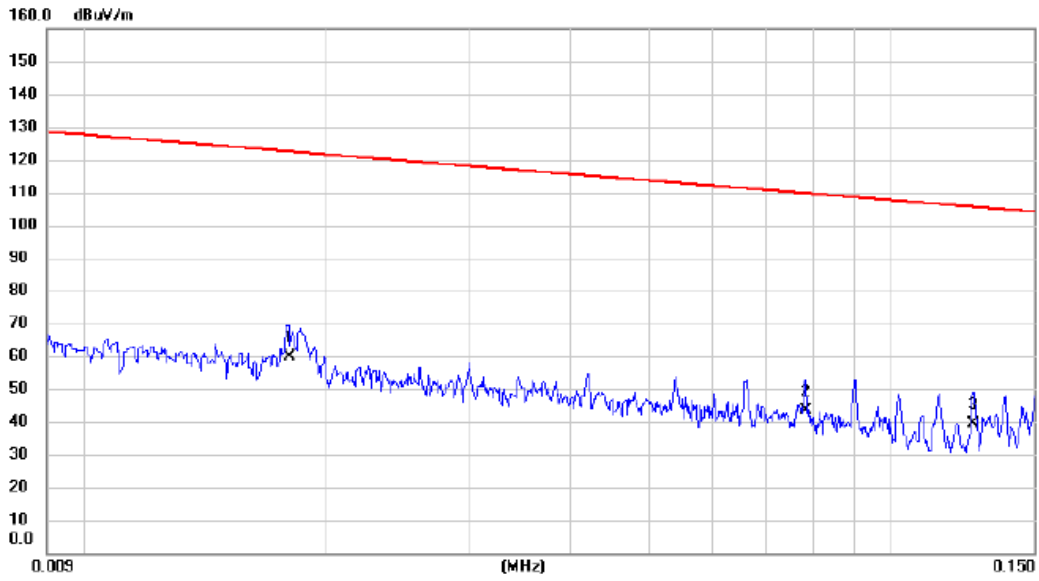

No.	Mk.	Freq.	Reading Level	Correct Factor	Measurement	Limit	Margin	Antenna Height	Table Degree	
		MHz	dBuV	dB	dBuV/m	dBuV/m	dB	cm	degree	Comment
1	*	0.0180	44.86	15.04	59.90	122.50	-62.60	AVG		
2		0.0783	29.67	13.75	43.42	109.73	-66.31	AVG		
3		0.1260	25.49	13.78	39.27	105.60	-66.33	AVG		

REMARKS:

- (1) Measurement Value = Reading Level + Correct Factor.
- (2) Margin Level = Measurement Value - Limit Value.

Test Mode	TX Mode_2Mbps Channel 00	Polarization	Ant 0°
-----------	--------------------------	--------------	--------

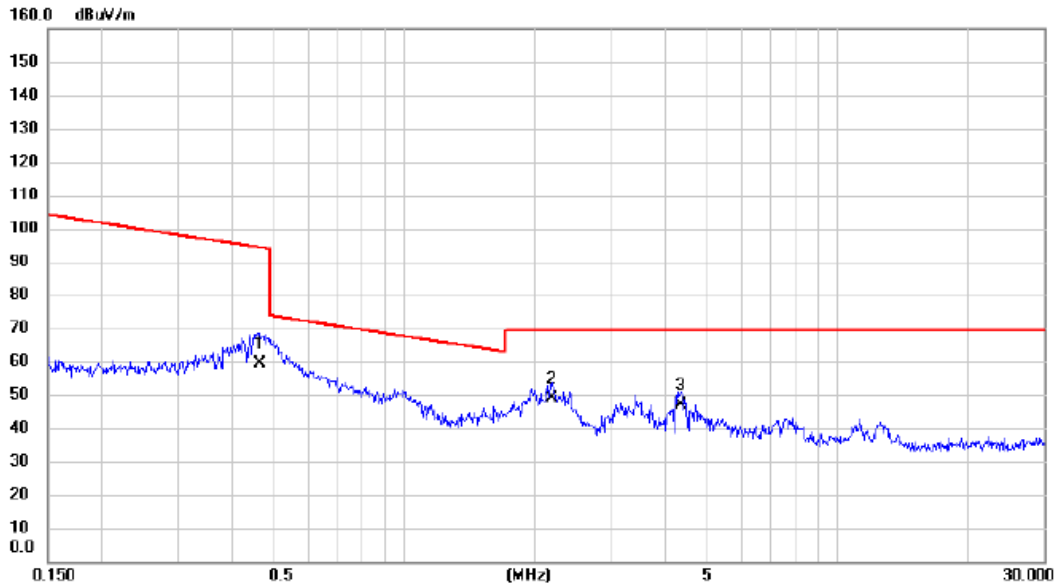

No.	Mk.	Freq.	Reading Level	Correct Factor	Measurement	Limit	Margin	Antenna Height	Table Degree	
		MHz	dBuV	dB	dBuV/m	dBuV/m	dB	cm	degree	Comment
1		0.4637	45.63	13.59	59.22	94.28	-35.06			AVG
2	*	2.1898	36.74	12.19	48.93	69.54	-20.61			QP
3		4.3606	34.83	12.06	46.89	69.54	-22.65			QP

REMARKS:

- (1) Measurement Value = Reading Level + Correct Factor.
- (2) Margin Level = Measurement Value - Limit Value.

Test Mode	TX Mode_2Mbps Channel 00	Polarization	Ant 90°
-----------	--------------------------	--------------	---------

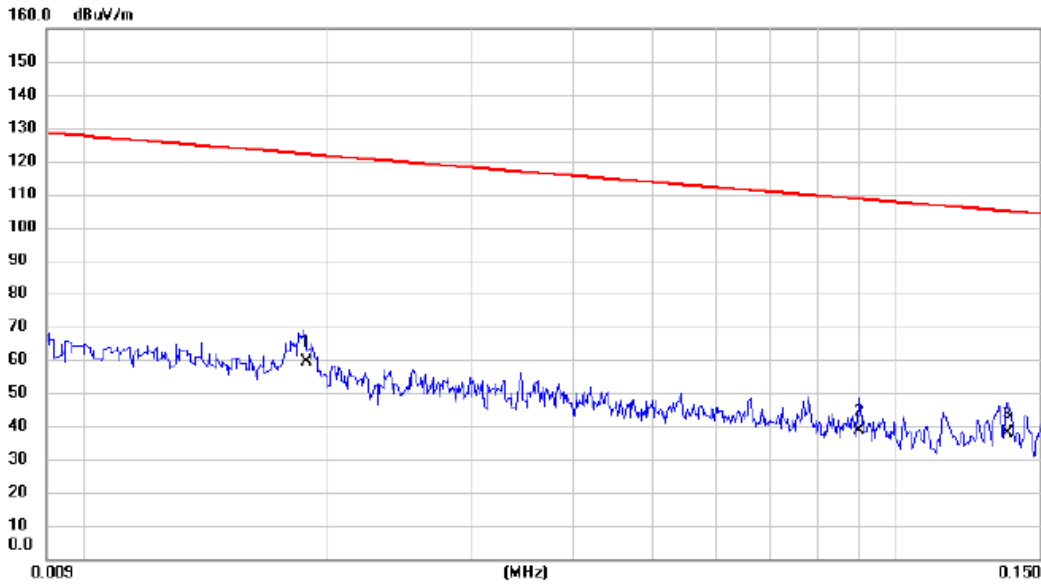

No.	Mk.	Freq.	Reading Level	Correct Factor	Measurement	Limit	Margin	Antenna Height	Table Degree	
		MHz	dBuV	dB	dBuV/m	dBuV/m	dB	cm	degree	Comment
1	*	0.0188	44.63	14.79	59.42	122.12	-62.70	AVG		
2		0.0900	24.76	13.77	38.53	108.52	-69.99	AVG		
3		0.1367	23.85	13.77	37.62	104.89	-67.27	AVG		

REMARKS:

- (1) Measurement Value = Reading Level + Correct Factor.
- (2) Margin Level = Measurement Value - Limit Value.

Test Mode	TX Mode_2Mbps Channel 00	Polarization	Ant 90°
-----------	--------------------------	--------------	---------

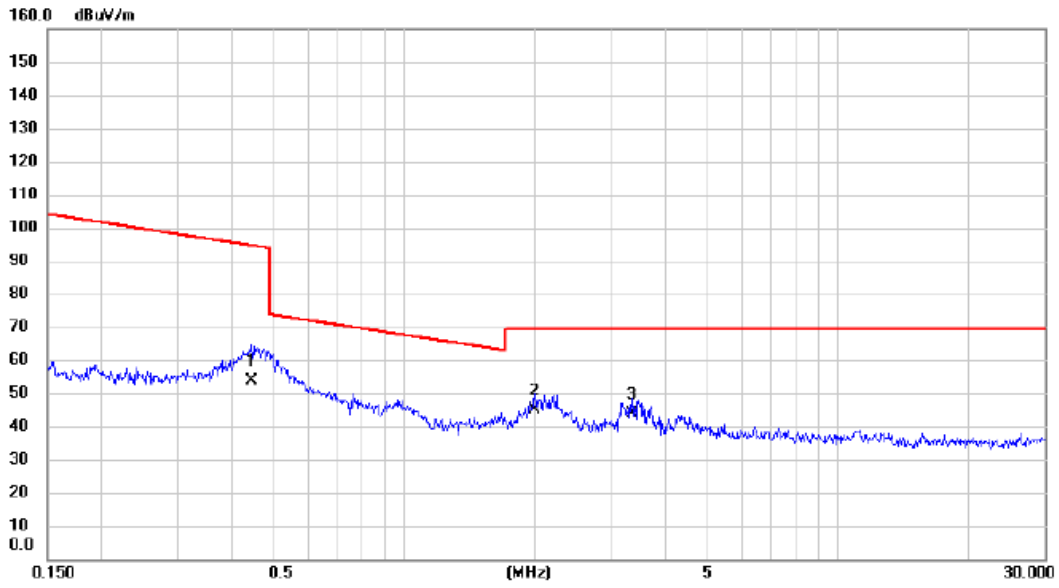

No. Mk.	Freq. MHz	Reading Level dBuV	Correct Factor dB	Measure- ment dBuV/m	Limit dBuV/m	Margin dB	Detector	Antenna Height cm	Table Degree degree	Comment
1	0.4444	40.29	13.60	53.89	94.65	-40.76	AVG			
2 *	2.0011	32.74	12.24	44.98	69.54	-24.56	QP			
3	3.3458	31.68	11.98	43.66	69.54	-25.88	QP			

REMARKS:

- (1) Measurement Value = Reading Level + Correct Factor.
- (2) Margin Level = Measurement Value - Limit Value.

APPENDIX C - RADIATED EMISSION - 30 MHZ TO 1000 MHZ

Test Mode	TX Mode_2Mbps Channel 00	Polarization	Vertical
-----------	--------------------------	--------------	----------

80 dBuV/m

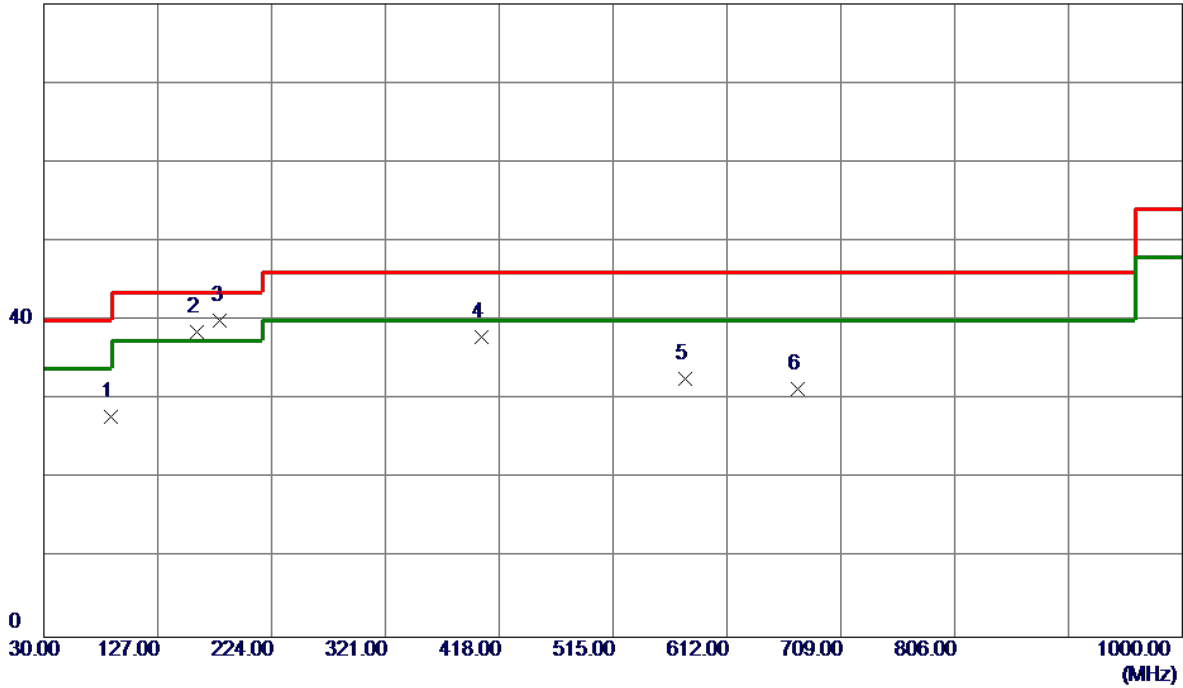

No.	Freq. MHz	Reading Level dBuV/m	Correct Factor dB	Measure ment dBuV/m	Limit dBuV/m	Margin dB	Detector	Comment
1	87.2300	46.45	-18.59	27.86	40.00	-12.14	Peak	
2	159.9800	50.90	-12.37	38.53	43.50	-4.97	Peak	
3 *	180.3500	53.71	-13.68	40.03	43.50	-3.47	Peak	
4	402.4800	46.57	-8.71	37.86	46.00	-8.14	Peak	
5	576.1100	37.86	-5.19	32.67	46.00	-13.33	Peak	
6	672.1400	34.84	-3.44	31.40	46.00	-14.60	Peak	

REMARKS:

- (1) Measurement Value = Reading Level + Correct Factor.
- (2) Margin Level = Measurement Value - Limit Value.

Test Mode	TX Mode_2Mbps Channel 00	Polarization	Horizontal
-----------	--------------------------	--------------	------------

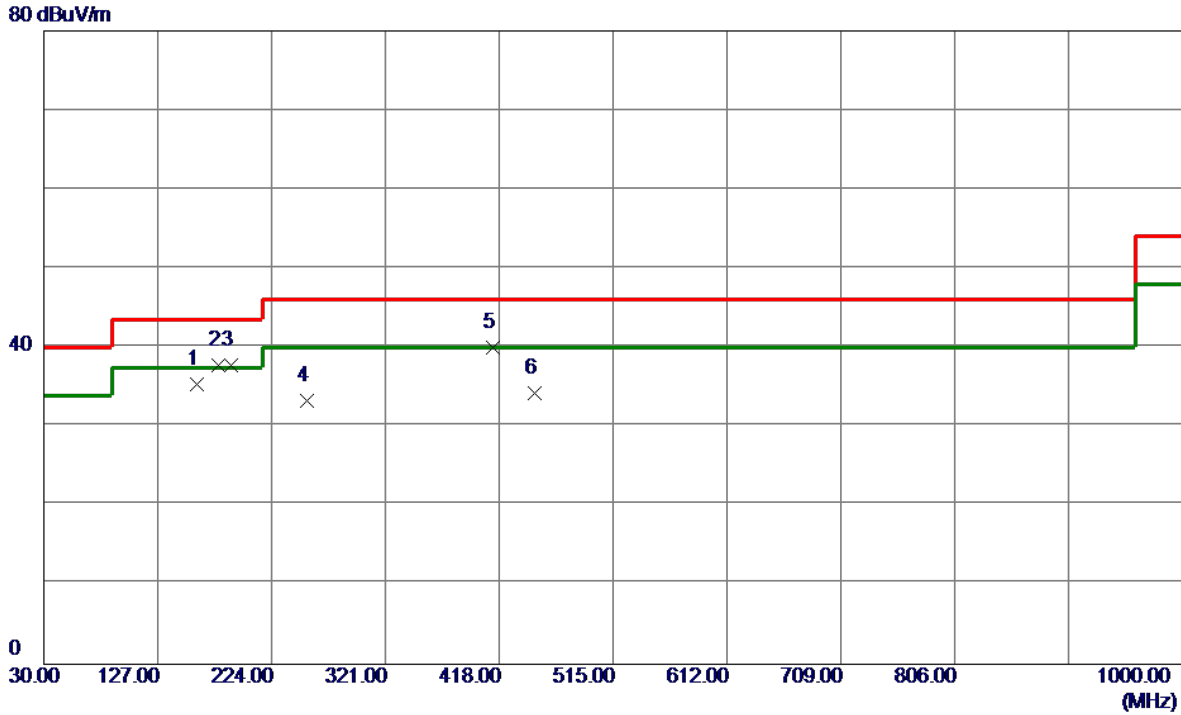

No.	Freq. MHz	Reading Level dBuV/m	Correct Factor dB	Measure ment dBuV/m	Limit dBuV/m	Margin dB	Detector	Comment
1	159.9800	47.77	-12.37	35.40	43.50	-8.10	Peak	
2 *	178.4100	51.27	-13.47	37.80	43.50	-5.70	Peak	
3	189.0800	52.59	-14.82	37.77	43.50	-5.73	Peak	
4	254.0700	46.01	-12.78	33.23	46.00	-12.77	Peak	
5	412.1800	48.41	-8.44	39.97	46.00	-6.03	Peak	
6	448.0700	41.63	-7.46	34.17	46.00	-11.83	Peak	

REMARKS:

- (1) Measurement Value = Reading Level + Correct Factor.
- (2) Margin Level = Measurement Value - Limit Value.

APPENDIX D - RADIATED EMISSION - ABOVE 1000 MHZ

Test Mode	TX 2402 MHz _CH00_1Mbps	Polarization	Vertical
-----------	-------------------------	--------------	----------

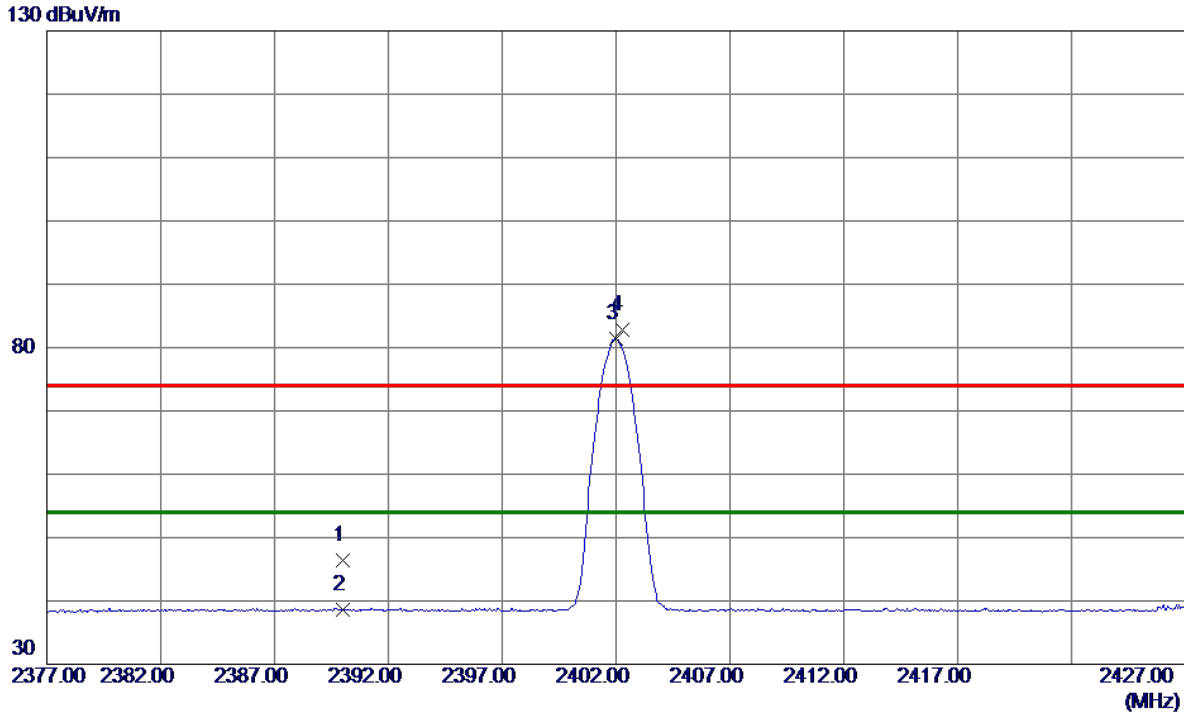

No.	Freq. MHz	Reading Level dBuV/m	Correct Factor dB	Measure ment dBuV/m	Limit dBuV/m	Margin dB	Detector	Comment
1	2390.0000	38.08	8.31	46.39	74.00	-27.61	Peak	
2	2390.0000	30.24	8.31	38.55	54.00	-15.45	AVG	
3 *	2402.0000	73.05	8.32	81.37	54.00	27.37	AVG	No Limit
4	2402.2500	74.56	8.32	82.88	74.00	8.88	Peak	No Limit

REMARKS:
 (1) Measurement Value = Reading Level + Correct Factor.
 (2) Margin Level = Measurement Value - Limit Value.

Test Mode	TX 2402 MHz _CH00_1Mbps	Polarization	Vertical
-----------	-------------------------	--------------	----------

80 dBuV/m

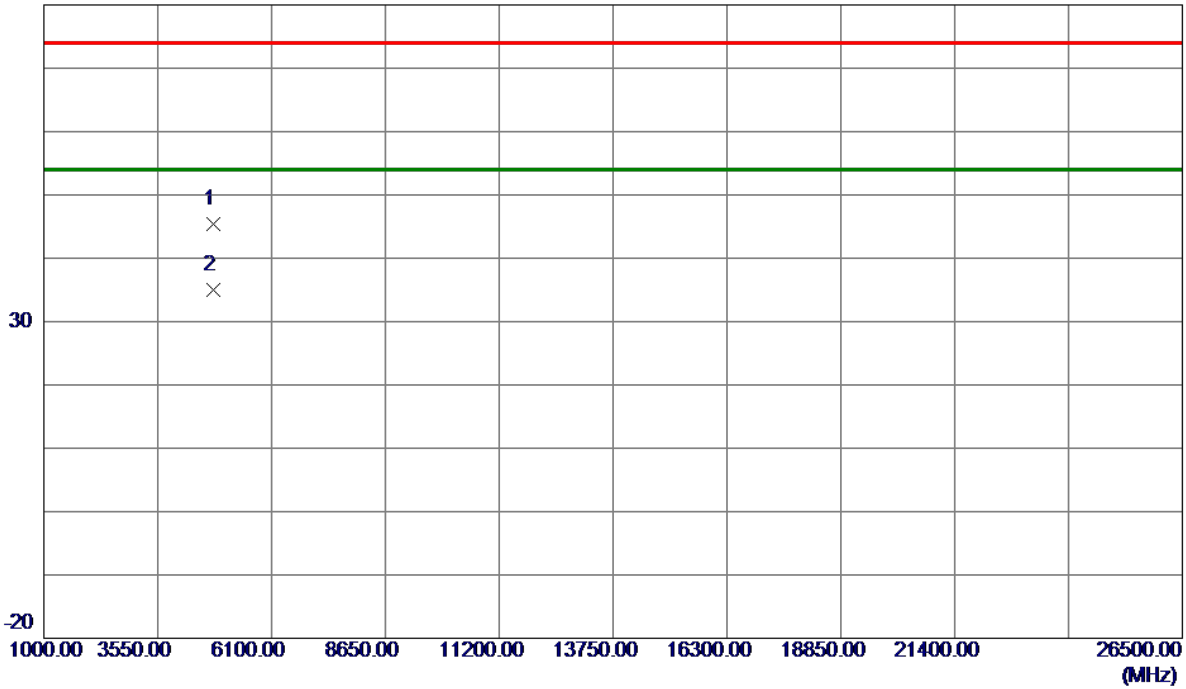

No.	Freq. MHz	Reading Level dBuV/m	Correct Factor dB	Measure ment dBuV/m	Limit dBuV/m	Margin dB	Detector	Comment
1	4803.3980	40.37	5.12	45.49	74.00	-28.51	Peak	
2 *	4803.7430	29.86	5.12	34.98	54.00	-19.02	AVG	

REMARKS:

- (1) Measurement Value = Reading Level + Correct Factor.
- (2) Margin Level = Measurement Value - Limit Value.

Test Mode	TX 2402 MHz _CH00_1Mbps	Polarization	Horizontal
-----------	-------------------------	--------------	------------

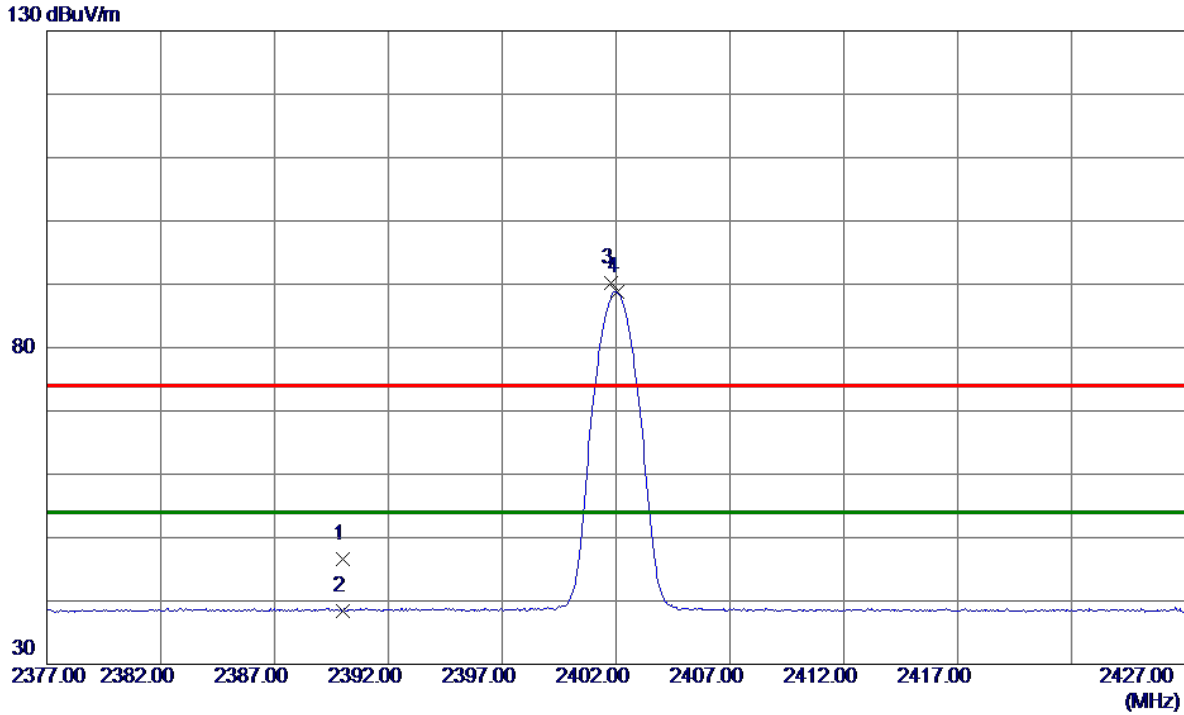

No.	Freq. MHz	Reading Level dBuV/m	Correct Factor dB	Measure ment dBuV/m	Limit dBuV/m	Margin dB	Detector	Comment
1	2390.0000	38.33	8.31	46.64	74.00	-27.36	Peak	
2	2390.0000	30.08	8.31	38.39	54.00	-15.61	AVG	
3	2401.8000	81.89	8.32	90.21	74.00	16.21	Peak	No Limit
4 *	2402.0500	80.47	8.32	88.79	54.00	34.79	AVG	No Limit

REMARKS:
 (1) Measurement Value = Reading Level + Correct Factor.
 (2) Margin Level = Measurement Value - Limit Value.

Test Mode	TX 2402 MHz _CH00_1Mbps	Polarization	Horizontal
-----------	-------------------------	--------------	------------

80 dBuV/m

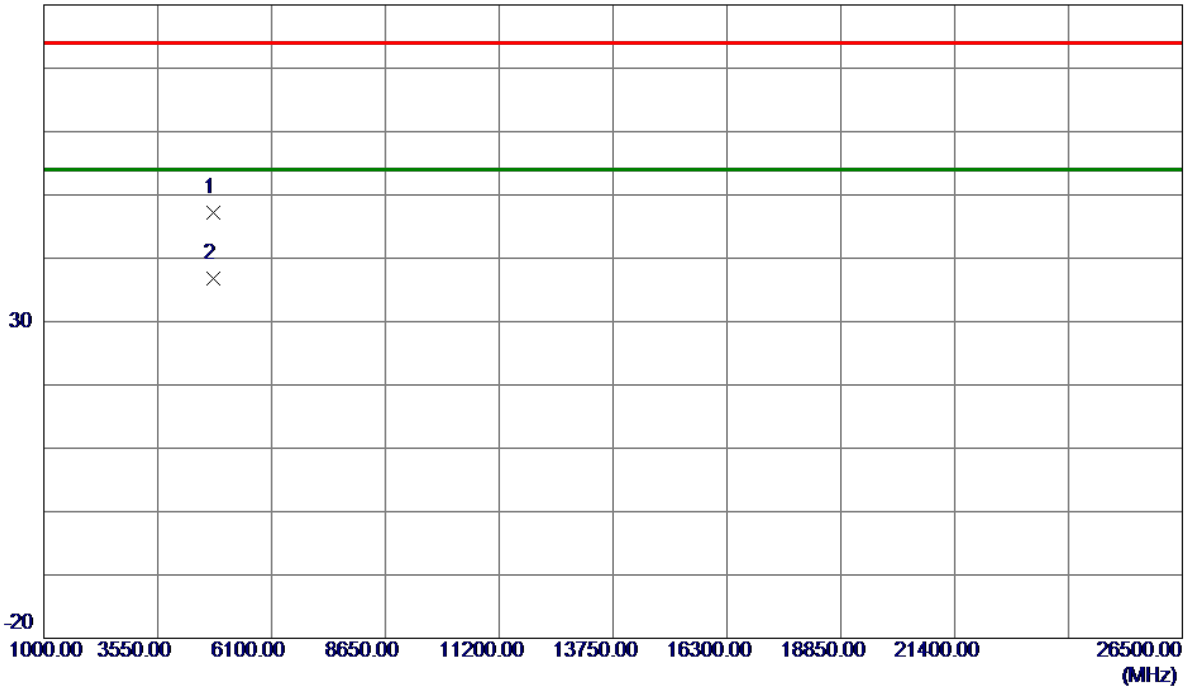

No.	Freq. MHz	Reading Level dBuV/m	Correct Factor dB	Measure ment dBuV/m	Limit dBuV/m	Margin dB	Detector	Comment
1	4803.4129	42.02	5.12	47.14	74.00	-26.86	Peak	
2 *	4803.9100	31.74	5.13	36.87	54.00	-17.13	AVG	

REMARKS:

- (1) Measurement Value = Reading Level + Correct Factor.
- (2) Margin Level = Measurement Value - Limit Value.

Test Mode	TX 2440 MHz _CH19_1Mbps	Polarization	Vertical
-----------	-------------------------	--------------	----------

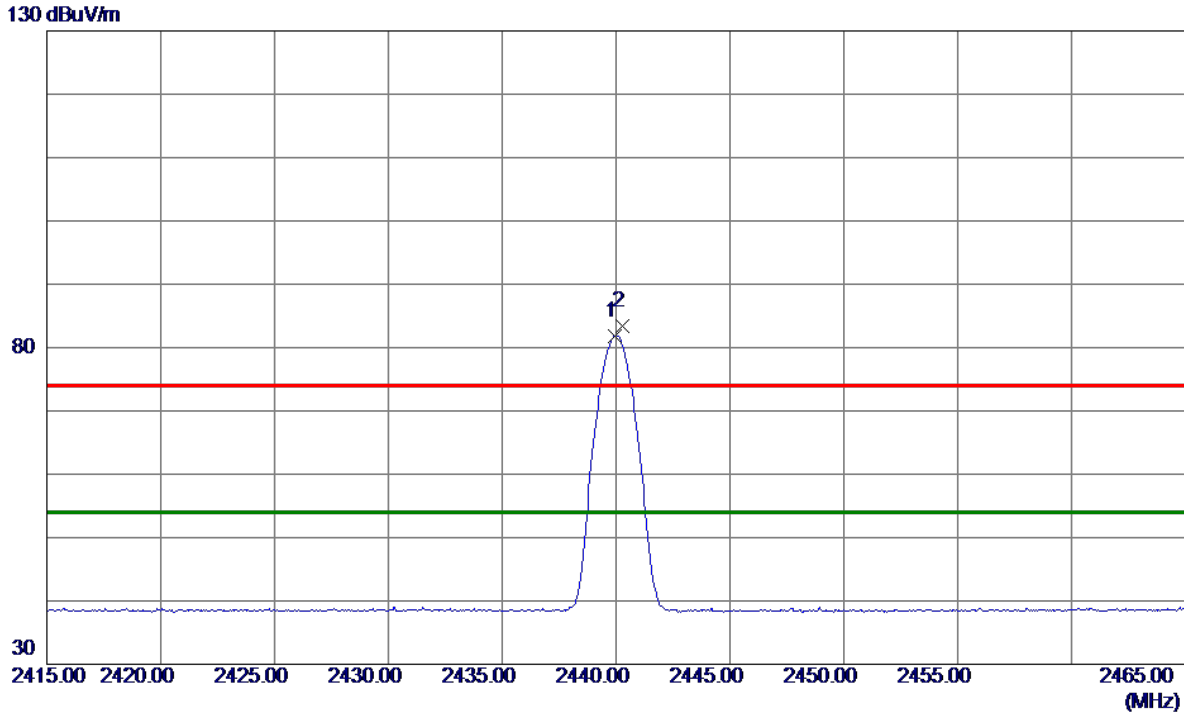

No.	Freq. MHz	Reading Level dBuV/m	Correct Factor dB	Measure ment dBuV/m	Limit dBuV/m	Margin dB	Detector	Comment
1 *	2439.9500	73.50	8.37	81.87	54.00	27.87	AVG	No Limit
2	2440.3000	75.00	8.37	83.37	74.00	9.37	Peak	No Limit

REMARKS:

- (1) Measurement Value = Reading Level + Correct Factor.
- (2) Margin Level = Measurement Value - Limit Value.

Test Mode	TX 2440 MHz _CH19_1Mbps	Polarization	Vertical
-----------	-------------------------	--------------	----------

80 dBuV/m

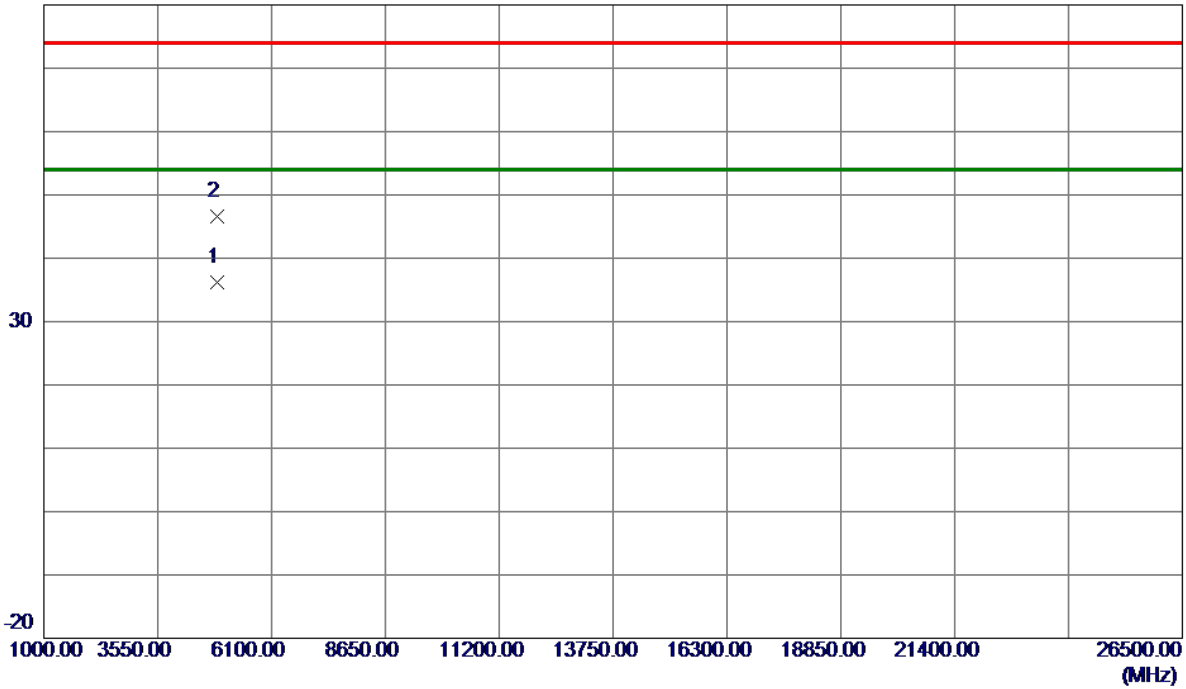

No.	Freq. MHz	Reading Level dBuV/m	Correct Factor dB	Measure ment dBuV/m	Limit dBuV/m	Margin dB	Detector	Comment
1 *	4879.6900	30.74	5.51	36.25	54.00	-17.75	AVG	
2	4879.8370	41.18	5.51	46.69	74.00	-27.31	Peak	

REMARKS:

- (1) Measurement Value = Reading Level + Correct Factor.
- (2) Margin Level = Measurement Value - Limit Value.

Test Mode	TX 2440 MHz _CH19_1Mbps	Polarization	Horizontal
-----------	-------------------------	--------------	------------

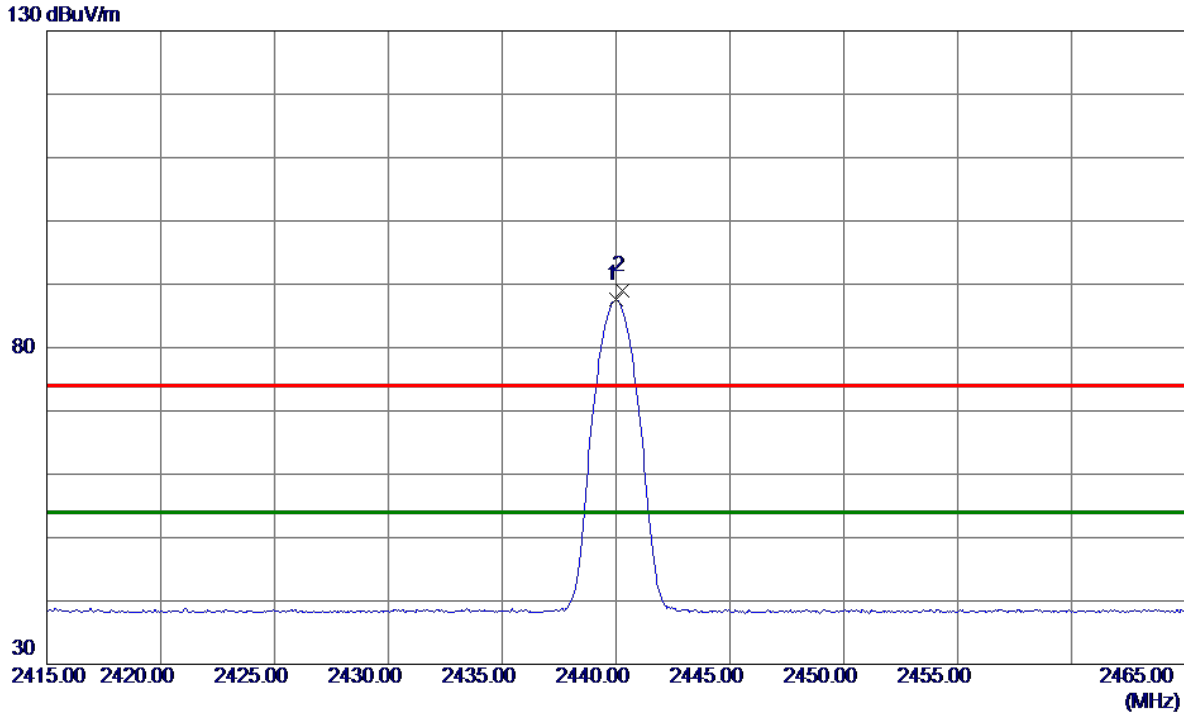

No.	Freq. MHz	Reading Level dBuV/m	Correct Factor dB	Measure ment dBuV/m	Limit dBuV/m	Margin dB	Detector	Comment
1 *	2440.0000	79.16	8.37	87.53	54.00	33.53	AVG	No Limit
2	2440.3000	80.57	8.37	88.94	74.00	14.94	Peak	No Limit

REMARKS:

- (1) Measurement Value = Reading Level + Correct Factor.
- (2) Margin Level = Measurement Value - Limit Value.

Test Mode	TX 2440 MHz _CH19_1Mbps	Polarization	Horizontal
-----------	-------------------------	--------------	------------

80 dBuV/m

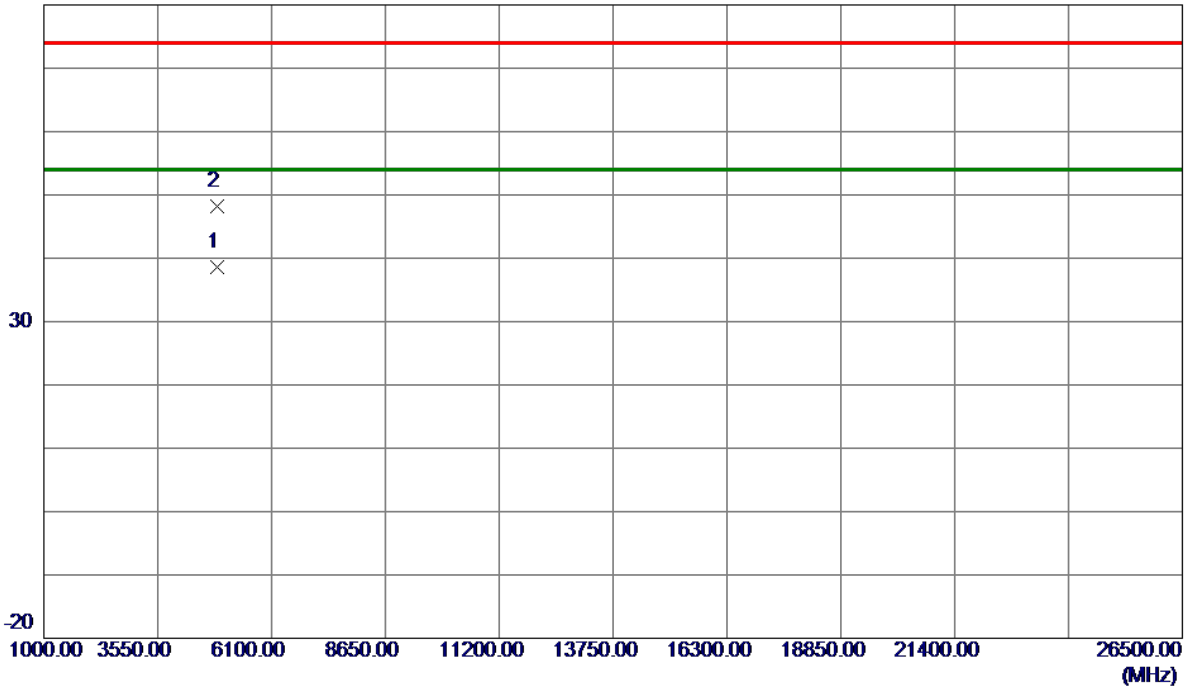

No.	Freq. MHz	Reading Level dBuV/m	Correct Factor dB	Measure ment dBuV/m	Limit dBuV/m	Margin dB	Detector	Comment
1 *	4879.8200	33.15	5.51	38.66	54.00	-15.34	AVG	
2	4880.0019	42.73	5.51	48.24	74.00	-25.76	Peak	

REMARKS:

- (1) Measurement Value = Reading Level + Correct Factor.
- (2) Margin Level = Measurement Value - Limit Value.

Test Mode	TX 2480 MHz _CH39_1Mbps	Polarization	Vertical
-----------	-------------------------	--------------	----------

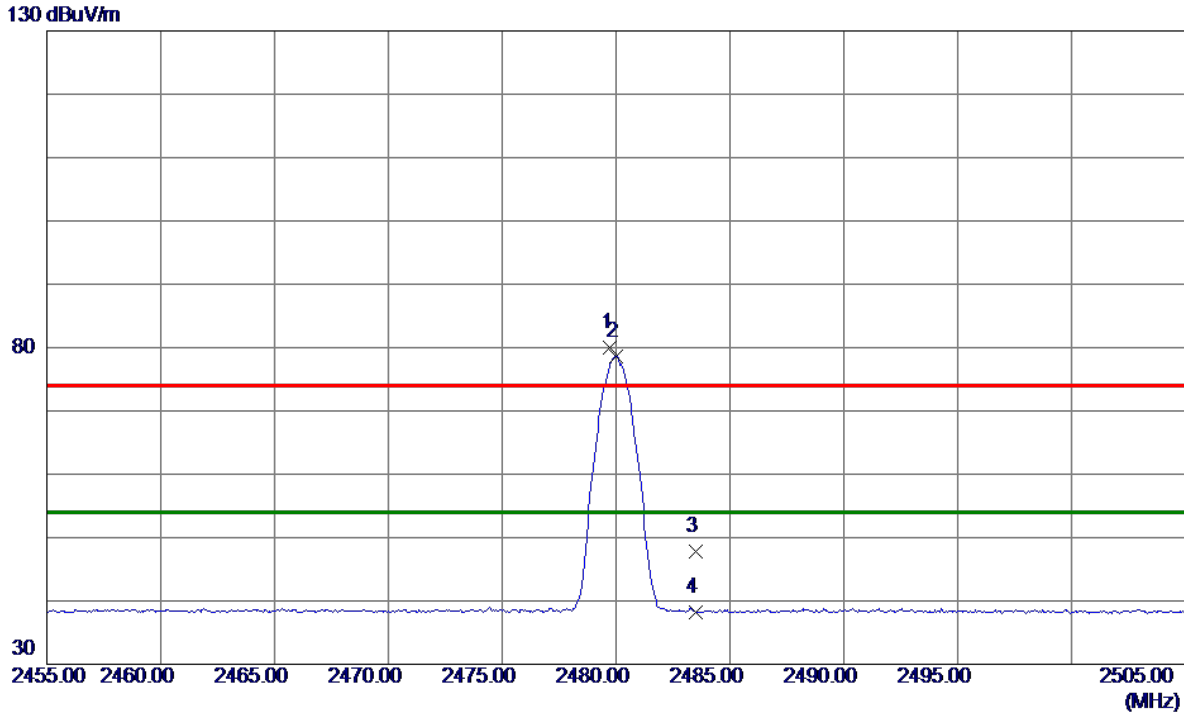

No.	Freq. MHz	Reading Level dBuV/m	Correct Factor dB	Measure ment dBuV/m	Limit dBuV/m	Margin dB	Detector	Comment
1	2479.7500	71.67	8.42	80.09	74.00	6.09	Peak	No Limit
2 *	2480.0000	70.22	8.42	78.64	54.00	24.64	AVG	No Limit
3	2483.5000	39.44	8.42	47.86	74.00	-26.14	Peak	
4	2483.5000	29.87	8.42	38.29	54.00	-15.71	AVG	

REMARKS:
 (1) Measurement Value = Reading Level + Correct Factor.
 (2) Margin Level = Measurement Value - Limit Value.

Test Mode	TX 2480 MHz _CH39_1Mbps	Polarization	Vertical
-----------	-------------------------	--------------	----------

80 dBuV/m

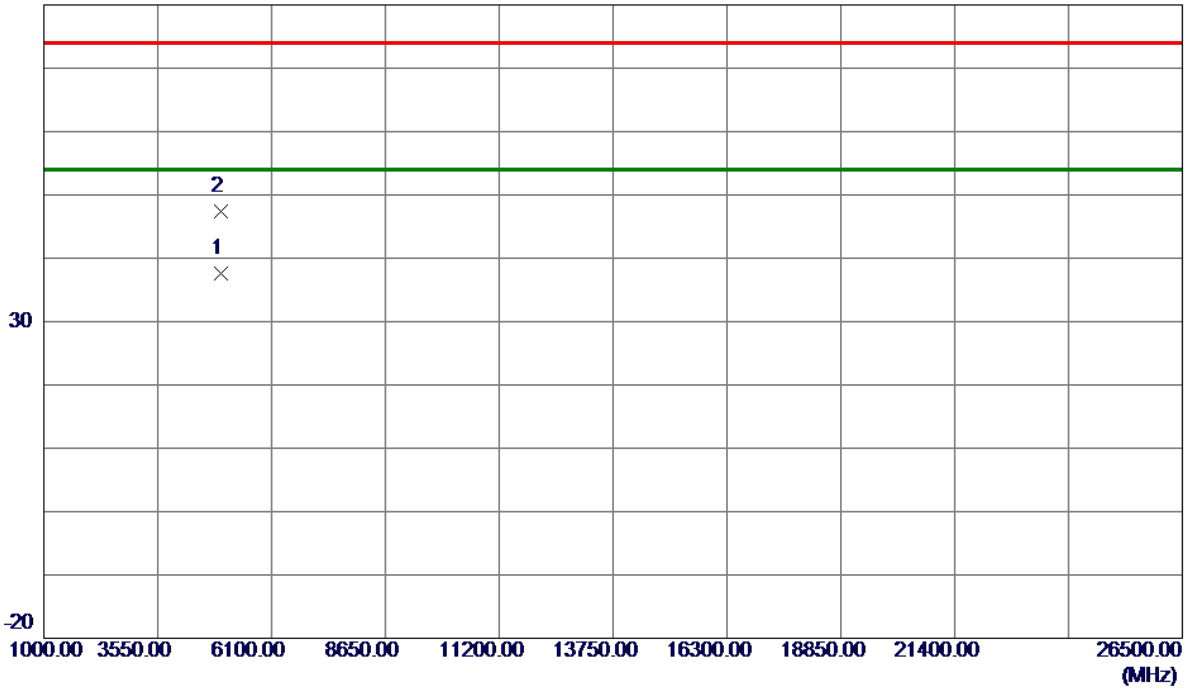

No.	Freq. MHz	Reading Level dBuV/m	Correct Factor dB	Measure ment dBuV/m	Limit dBuV/m	Margin dB	Detector	Comment
1 *	4959.9100	31.61	5.92	37.53	54.00	-16.47	AVG	
2	4960.4750	41.48	5.92	47.40	74.00	-26.60	Peak	

REMARKS:

- (1) Measurement Value = Reading Level + Correct Factor.
- (2) Margin Level = Measurement Value - Limit Value.

Test Mode	TX 2480 MHz _CH39_1Mbps	Polarization	Horizontal
-----------	-------------------------	--------------	------------

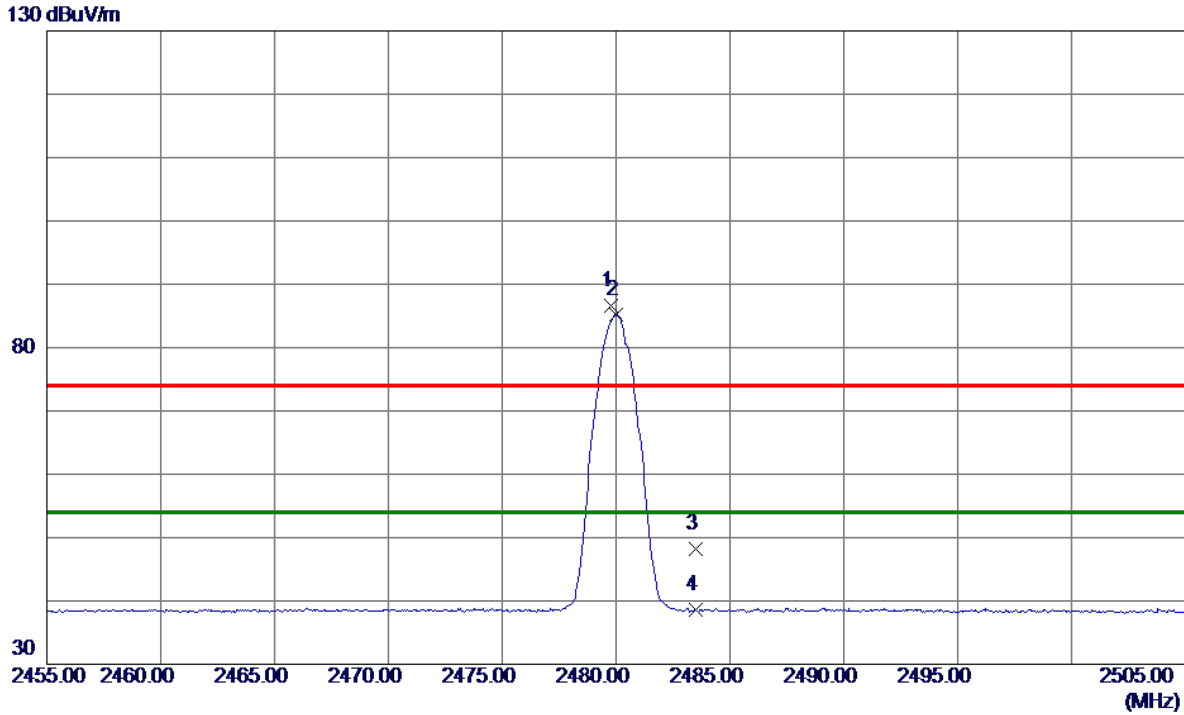

No.	Freq. MHz	Reading Level dBuV/m	Correct Factor dB	Measure ment dBuV/m	Limit dBuV/m	Margin dB	Detector	Comment
1	2479.8000	78.17	8.42	86.59	74.00	12.59	Peak	No Limit
2 *	2480.0000	76.80	8.42	85.22	54.00	31.22	AVG	No Limit
3	2483.5000	39.75	8.42	48.17	74.00	-25.83	Peak	
4	2483.5000	30.23	8.42	38.65	54.00	-15.35	AVG	

REMARKS:
 (1) Measurement Value = Reading Level + Correct Factor.
 (2) Margin Level = Measurement Value - Limit Value.

Test Mode	TX 2480 MHz _CH39_1Mbps	Polarization	Horizontal
-----------	-------------------------	--------------	------------

80 dBuV/m

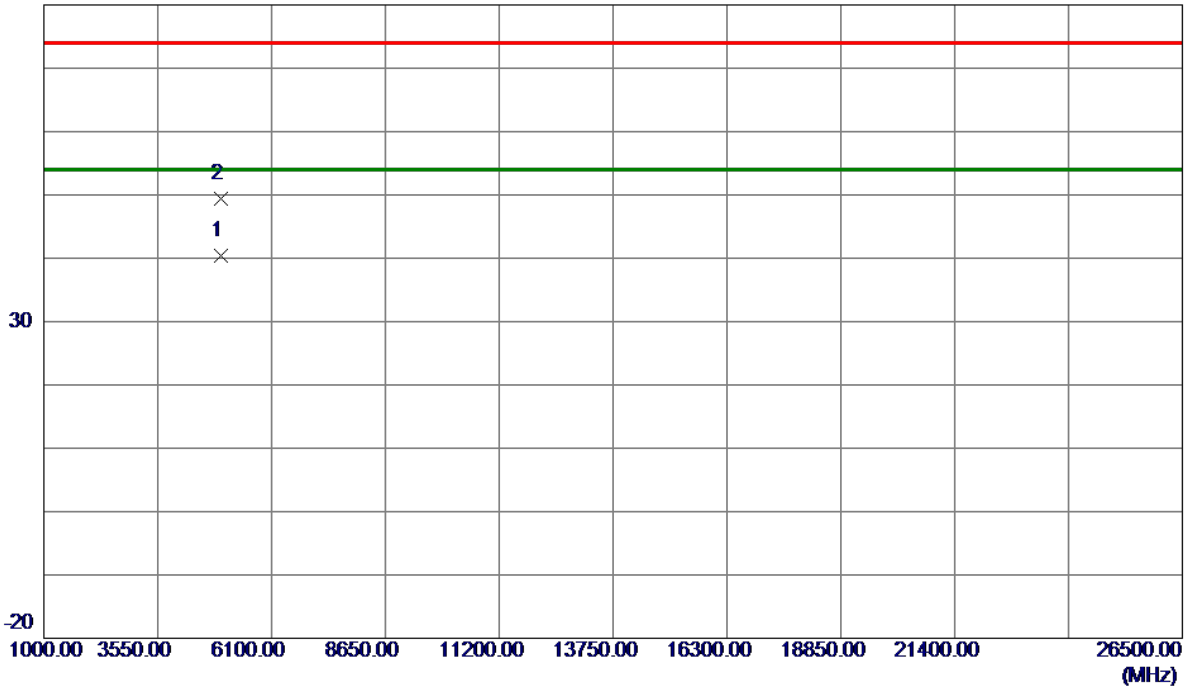

No.	Freq. MHz	Reading Level dBuV/m	Correct Factor dB	Measure ment dBuV/m	Limit dBuV/m	Margin dB	Detector	Comment
1 *	4959.7799	34.50	5.92	40.42	54.00	-13.58	AVG	
2	4959.9900	43.51	5.92	49.43	74.00	-24.57	Peak	

REMARKS:

- (1) Measurement Value = Reading Level + Correct Factor.
- (2) Margin Level = Measurement Value - Limit Value.

Test Mode	TX 2402 MHz _CH00_2Mbps	Polarization	Vertical
-----------	-------------------------	--------------	----------

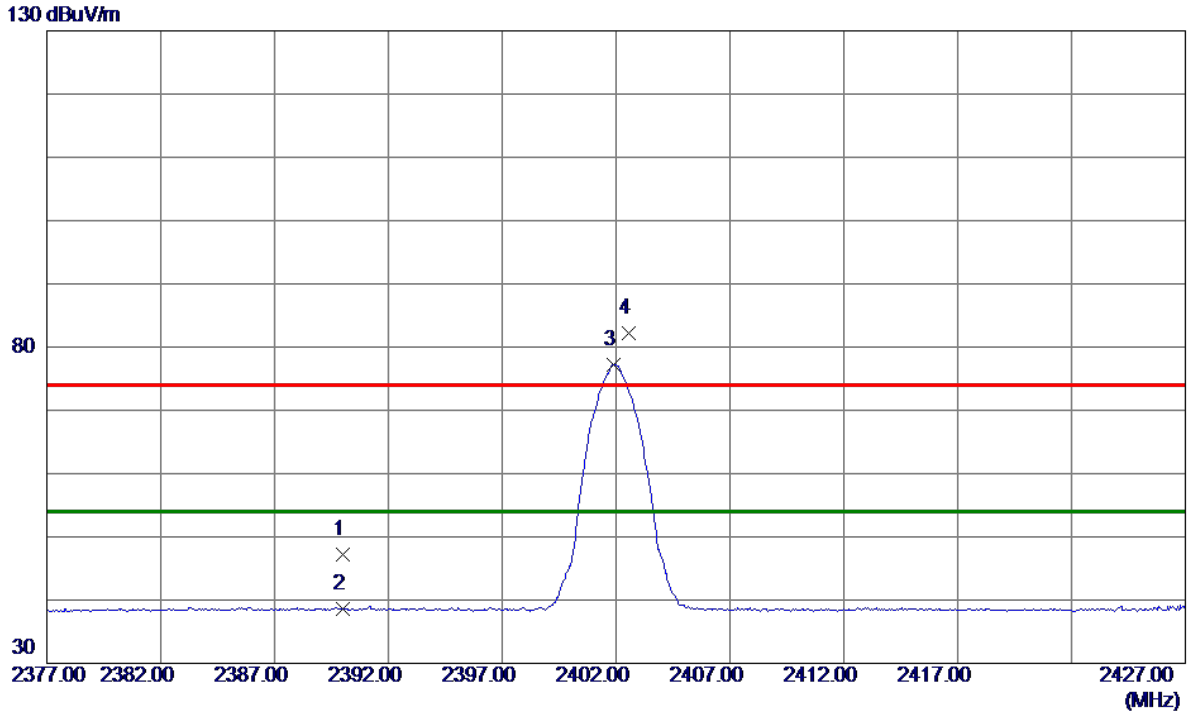

No.	Freq. MHz	Reading Level dBuV/m	Correct Factor dB	Measure ment dBuV/m	Limit dBuV/m	Margin dB	Detector	Comment
1	2390.0000	38.95	8.31	47.26	74.00	-26.74	Peak	
2	2390.0000	30.28	8.31	38.59	54.00	-15.41	AVG	
3 *	2401.9000	68.91	8.32	77.23	54.00	23.23	AVG	No Limit
4	2402.5500	73.93	8.32	82.25	74.00	8.25	Peak	No Limit

REMARKS:

- (1) Measurement Value = Reading Level + Correct Factor.
- (2) Margin Level = Measurement Value - Limit Value.

Test Mode	TX 2402 MHz _CH00_2Mbps	Polarization	Vertical
-----------	-------------------------	--------------	----------

80 dBuV/m

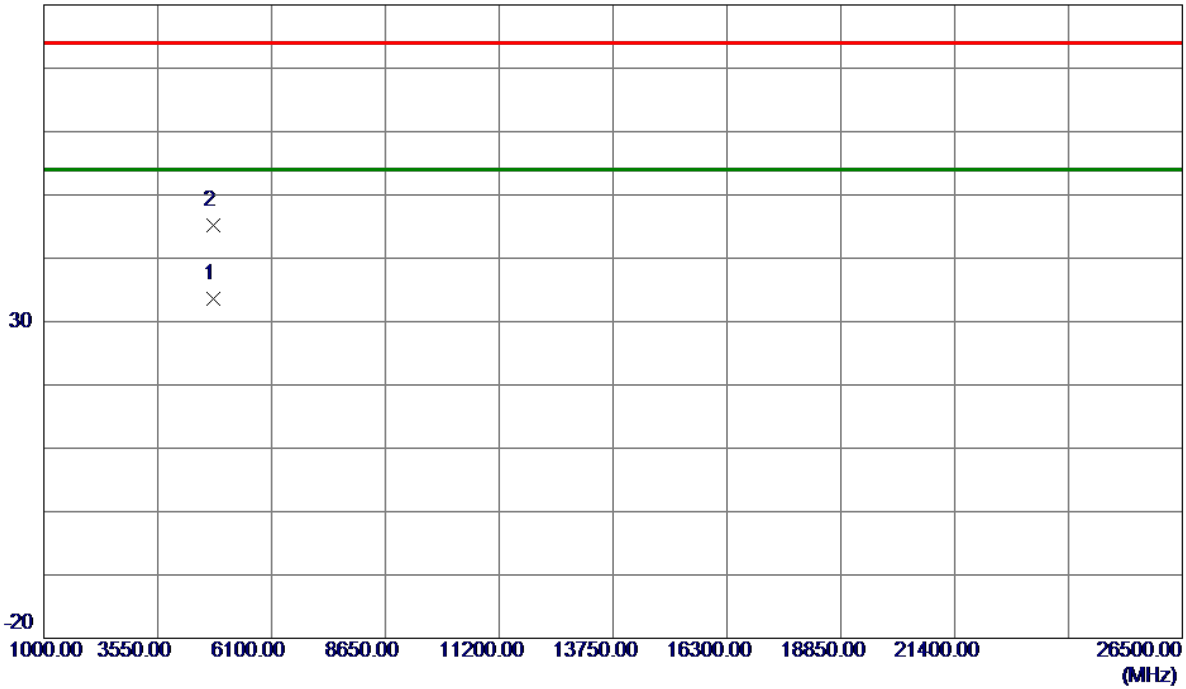

No.	Freq. MHz	Reading Level dBuV/m	Correct Factor dB	Measure ment dBuV/m	Limit dBuV/m	Margin dB	Detector	Comment
1 *	4803.1450	28.43	5.12	33.55	54.00	-20.45	AVG	
2	4805.0550	40.03	5.13	45.16	74.00	-28.84	Peak	

REMARKS:

- (1) Measurement Value = Reading Level + Correct Factor.
- (2) Margin Level = Measurement Value - Limit Value.

Test Mode	TX 2402 MHz _CH00_2Mbps	Polarization	Horizontal
-----------	-------------------------	--------------	------------

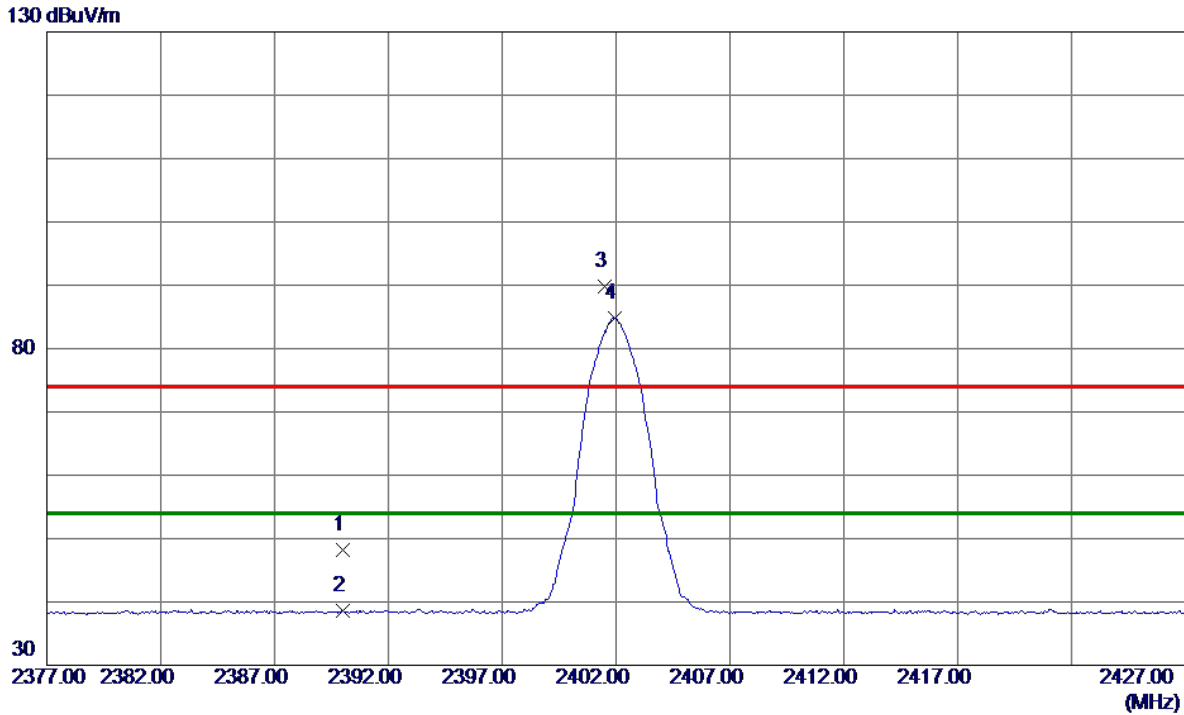

No.	Freq. MHz	Reading Level dBuV/m	Correct Factor dB	Measure ment dBuV/m	Limit dBuV/m	Margin dB	Detector	Comment
1	2390.0000	39.89	8.31	48.20	74.00	-25.80	Peak	
2	2390.0000	30.34	8.31	38.65	54.00	-15.35	AVG	
3	2401.5000	81.54	8.32	89.86	74.00	15.86	Peak	No Limit
4 *	2401.9500	76.50	8.32	84.82	54.00	30.82	AVG	No Limit

REMARKS:
 (1) Measurement Value = Reading Level + Correct Factor.
 (2) Margin Level = Measurement Value - Limit Value.

Test Mode	TX 2402 MHz _CH00_2Mbps	Polarization	Horizontal
-----------	-------------------------	--------------	------------

80 dBuV/m

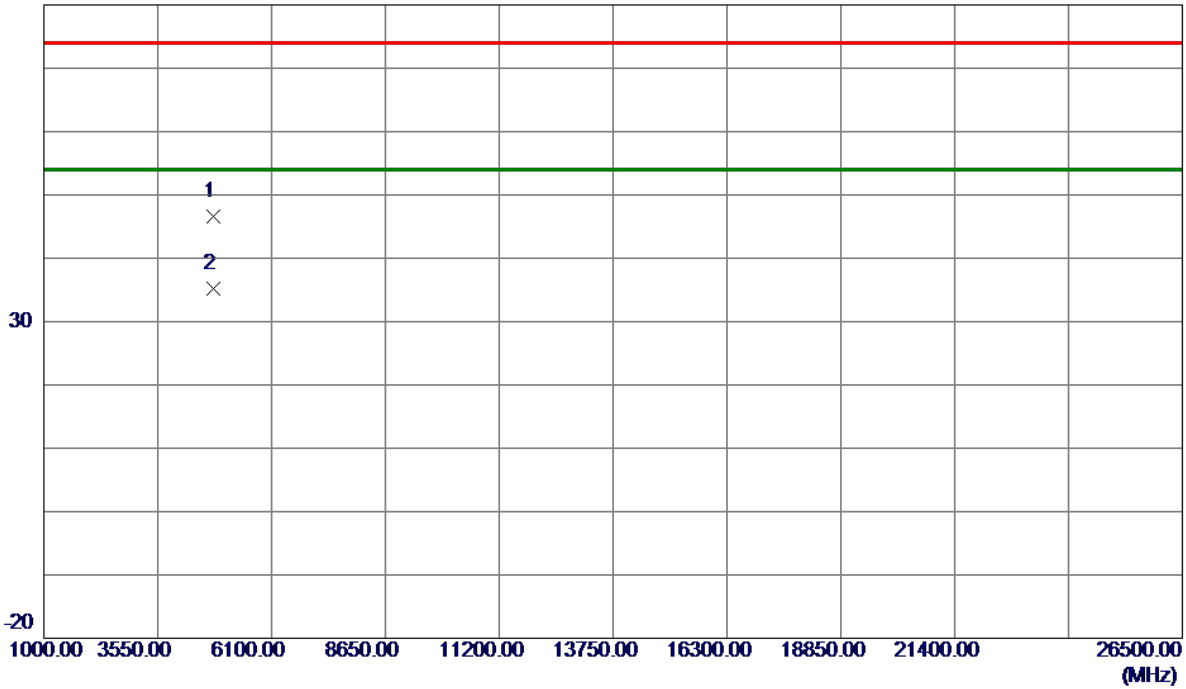

No.	Freq. MHz	Reading Level dBuV/m	Correct Factor dB	Measure ment dBuV/m	Limit dBuV/m	Margin dB	Detector	Comment
1	4802.8070	41.48	5.12	46.60	74.00	-27.40	Peak	
2 *	4804.9100	30.00	5.13	35.13	54.00	-18.87	AVG	

REMARKS:

- (1) Measurement Value = Reading Level + Correct Factor.
- (2) Margin Level = Measurement Value - Limit Value.

Test Mode	TX 2440 MHz _CH19_2Mbps	Polarization	Vertical
-----------	-------------------------	--------------	----------

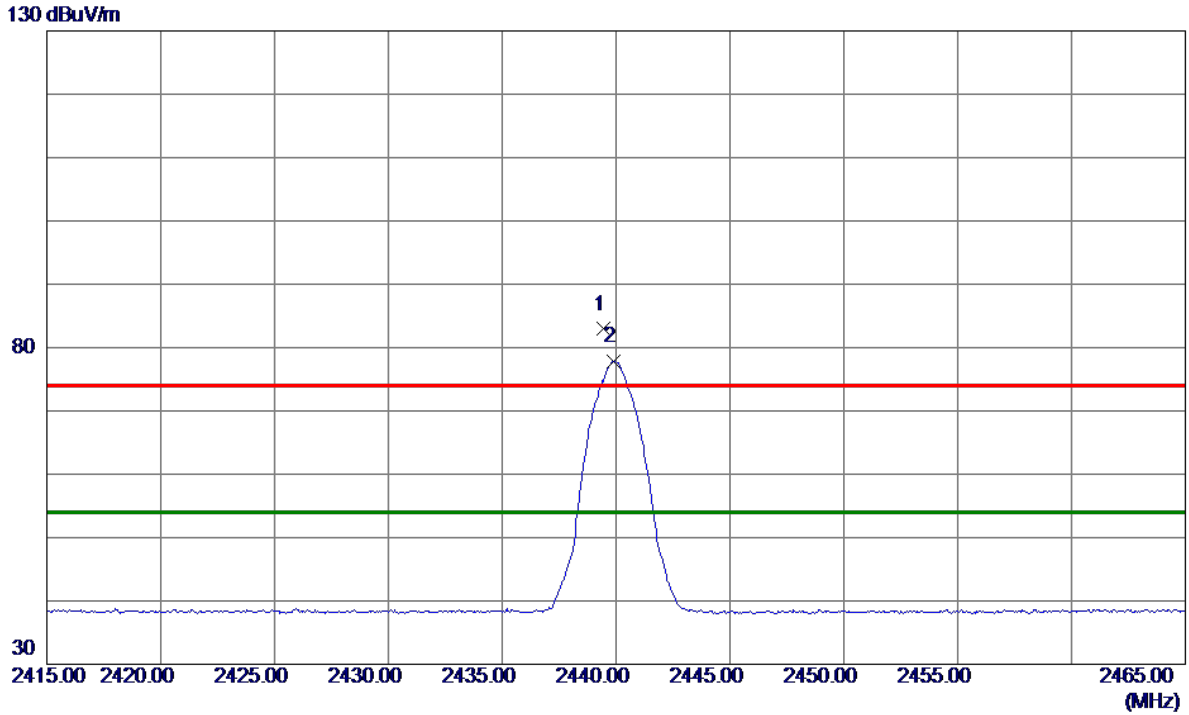

No.	Freq. MHz	Reading Level dBuV/m	Correct Factor dB	Measure ment dBuV/m	Limit dBuV/m	Margin dB	Detector	Comment
1	2439.4500	74.53	8.37	82.90	74.00	8.90	Peak	No Limit
2 *	2439.9000	69.47	8.37	77.84	54.00	23.84	AVG	No Limit

REMARKS:

- (1) Measurement Value = Reading Level + Correct Factor.
- (2) Margin Level = Measurement Value - Limit Value.

Test Mode	TX 2440 MHz _CH19_ 2Mbps	Polarization	Vertical
-----------	--------------------------	--------------	----------

80 dBuV/m

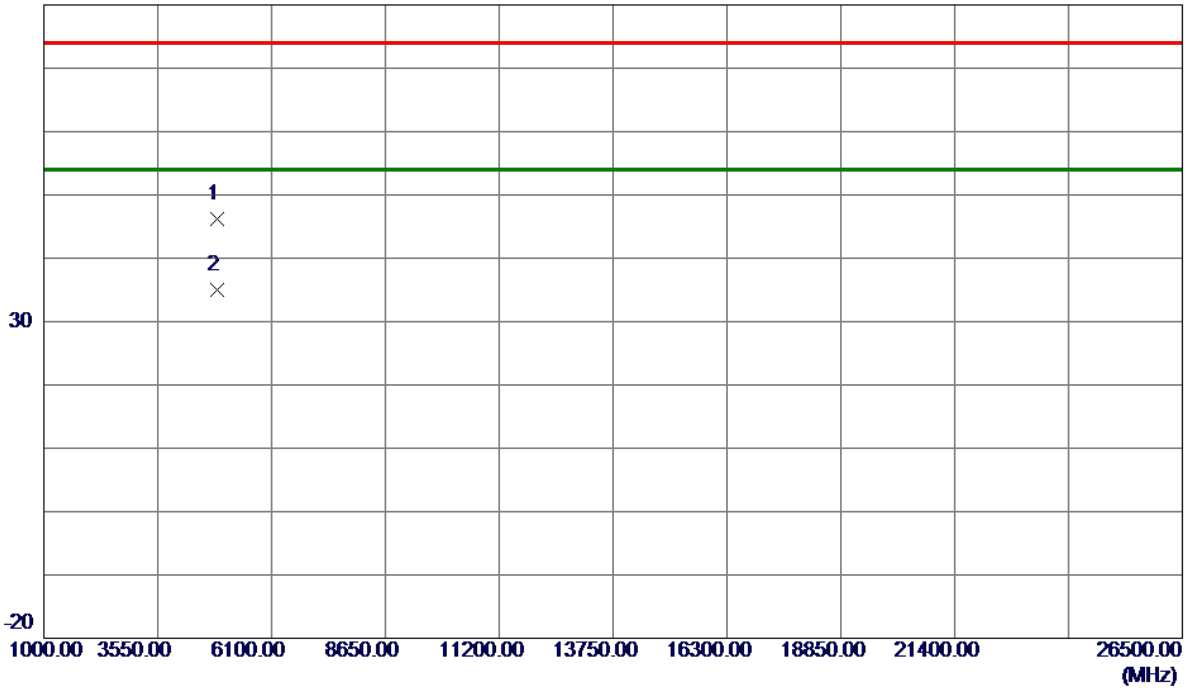

No.	Freq. MHz	Reading Level dBuV/m	Correct Factor dB	Measure ment dBuV/m	Limit dBuV/m	Margin dB	Detector	Comment
1	4880.8200	40.70	5.52	46.22	74.00	-27.78	Peak	
2 *	4881.0280	29.40	5.52	34.92	54.00	-19.08	AVG	

REMARKS:

- (1) Measurement Value = Reading Level + Correct Factor.
- (2) Margin Level = Measurement Value - Limit Value.

Test Mode	TX 2440 MHz _CH19_2Mbps	Polarization	Horizontal
-----------	-------------------------	--------------	------------

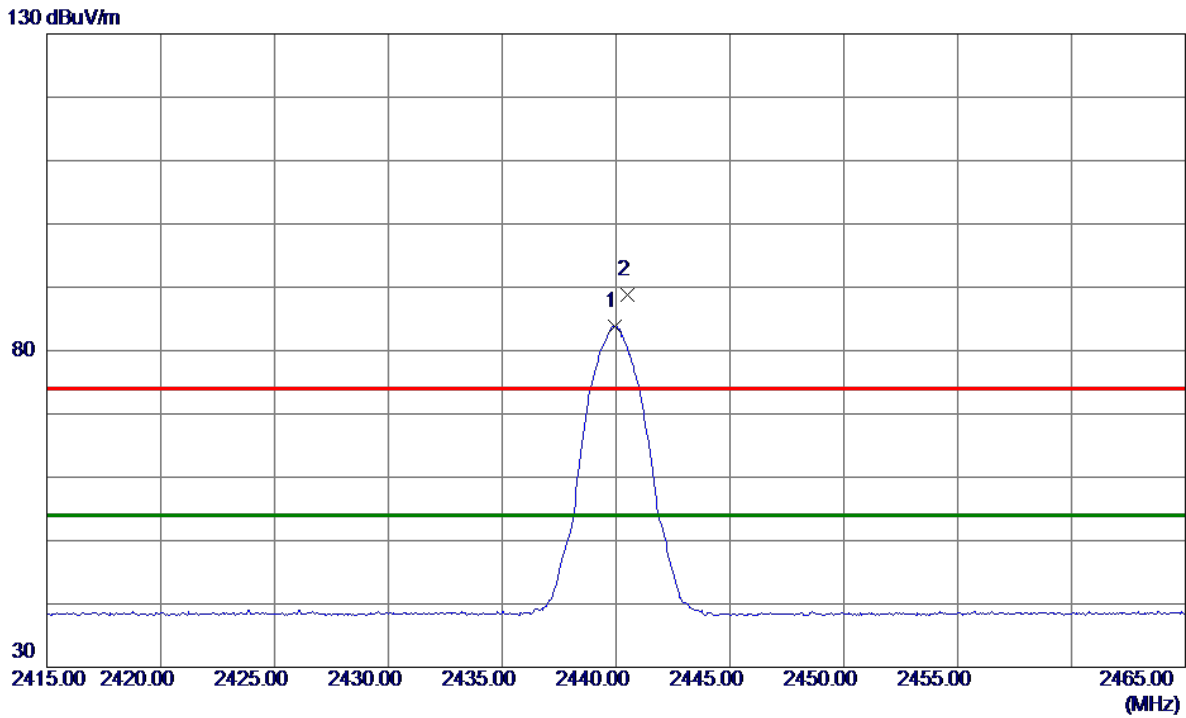

No.	Freq. MHz	Reading Level dBuV/m	Correct Factor dB	Measure ment dBuV/m	Limit dBuV/m	Margin dB	Detector	Comment
1 *	2439.9500	75.48	8.37	83.85	54.00	29.85	AVG	No Limit
2	2440.5000	80.48	8.37	88.85	74.00	14.85	Peak	No Limit

REMARKS:

- (1) Measurement Value = Reading Level + Correct Factor.
- (2) Margin Level = Measurement Value - Limit Value.

Test Mode	TX 2440 MHz _CH19_ 2Mbps	Polarization	Horizontal
-----------	--------------------------	--------------	------------

80 dBuV/m

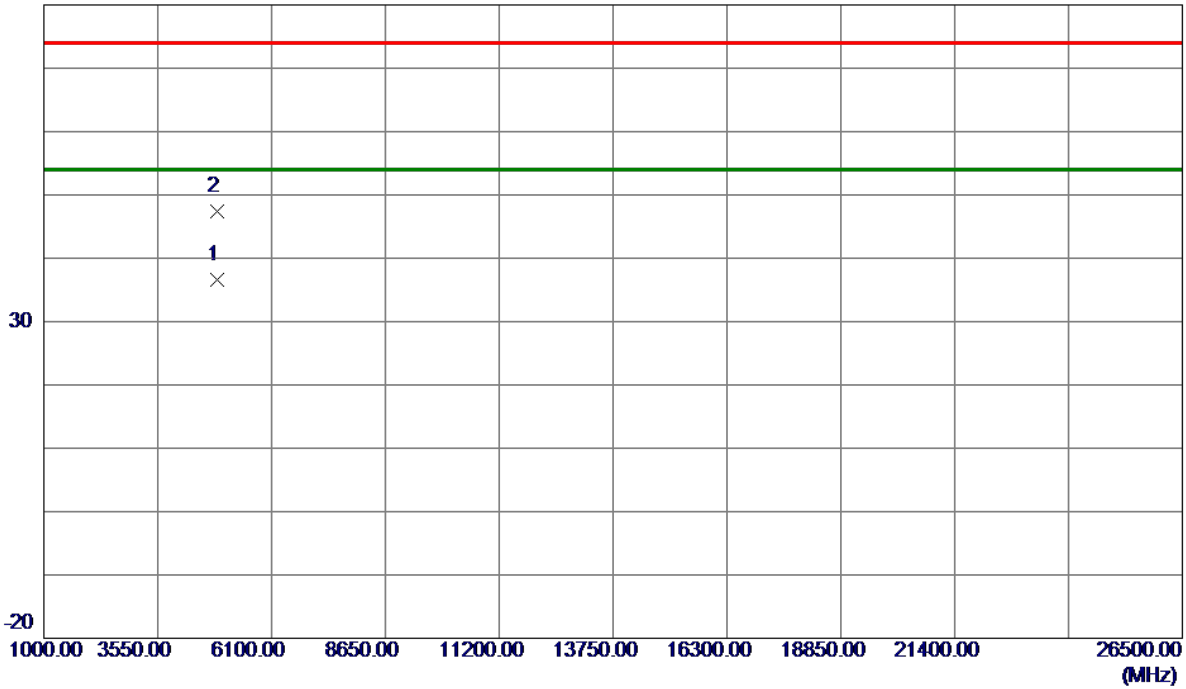

No.	Freq. MHz	Reading Level dBuV/m	Correct Factor dB	Measure ment dBuV/m	Limit dBuV/m	Margin dB	Detector	Comment
1 *	4879.0230	31.00	5.51	36.51	54.00	-17.49	AVG	
2	4880.1230	41.89	5.51	47.40	74.00	-26.60	Peak	

REMARKS:

- (1) Measurement Value = Reading Level + Correct Factor.
- (2) Margin Level = Measurement Value - Limit Value.

Test Mode	TX 2480 MHz _CH39_2Mbps	Polarization	Vertical
-----------	-------------------------	--------------	----------

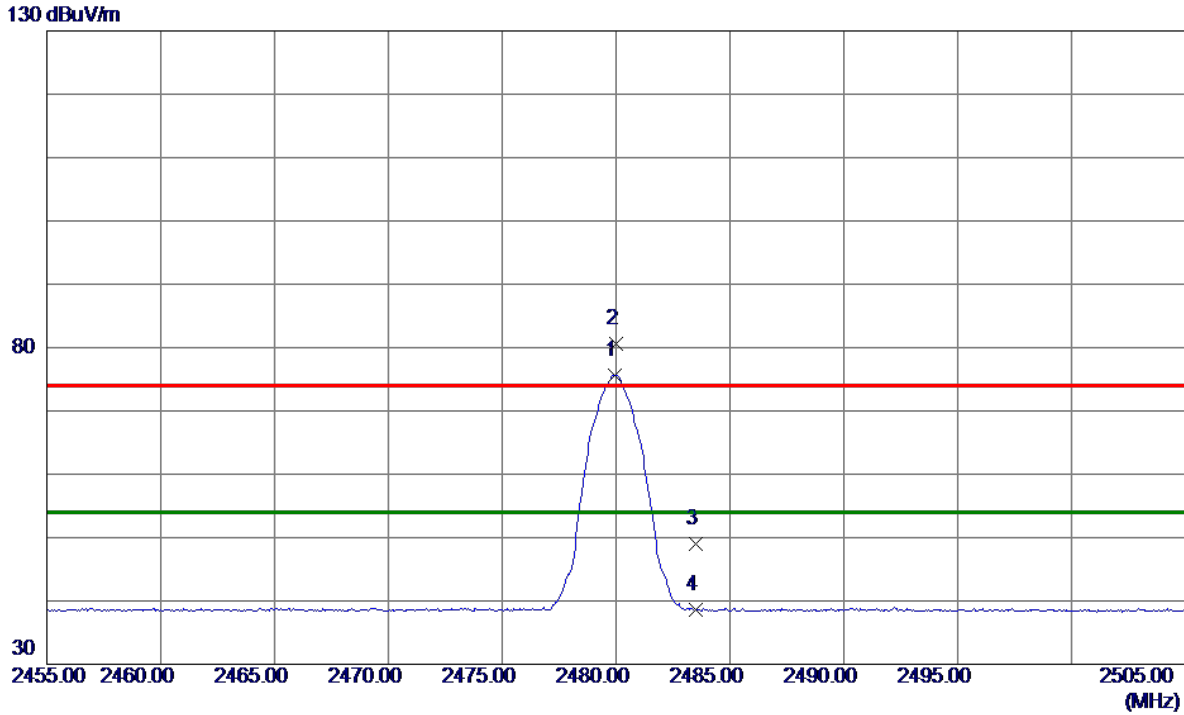

No.	Freq. MHz	Reading Level dBuV/m	Correct Factor dB	Measure ment dBuV/m	Limit dBuV/m	Margin dB	Detector	Comment
1 *	2479.9500	67.20	8.42	75.62	54.00	21.62	AVG	No Limit
2	2480.0000	72.20	8.42	80.62	74.00	6.62	Peak	No Limit
3	2483.5000	40.55	8.42	48.97	74.00	-25.03	Peak	
4	2483.5000	30.16	8.42	38.58	54.00	-15.42	AVG	

REMARKS:
 (1) Measurement Value = Reading Level + Correct Factor.
 (2) Margin Level = Measurement Value - Limit Value.

Test Mode	TX 2480 MHz _CH39_2Mbps	Polarization	Vertical
-----------	-------------------------	--------------	----------

80 dBuV/m

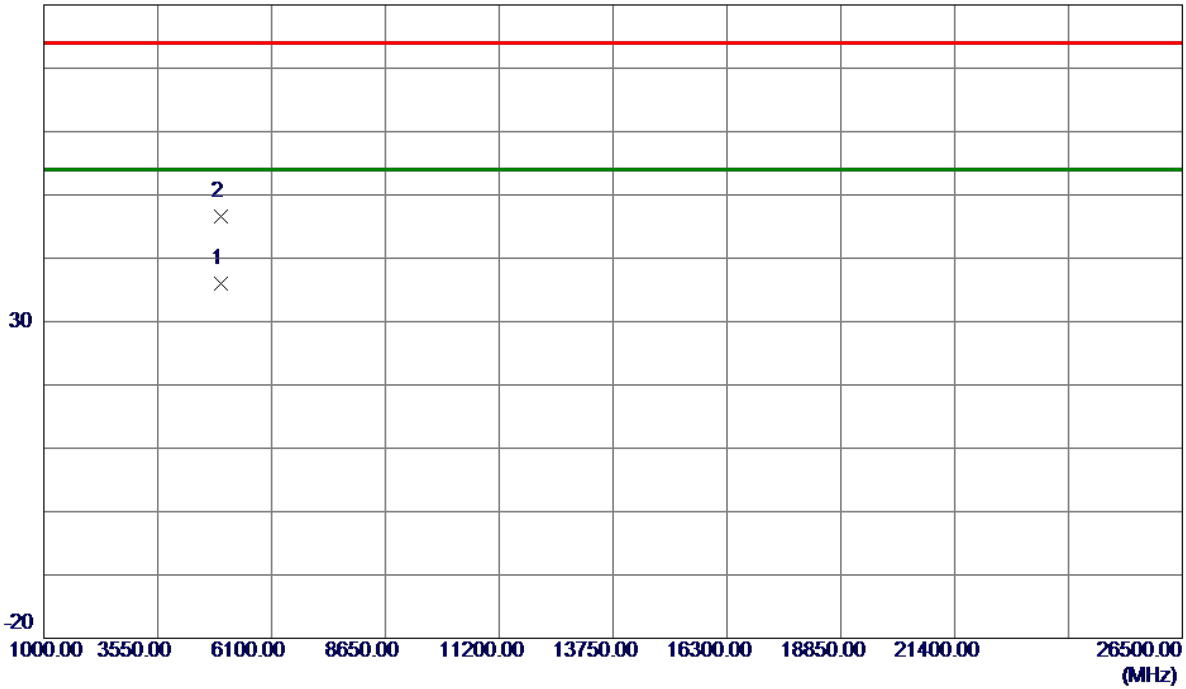

No.	Freq. MHz	Reading Level dBuV/m	Correct Factor dB	Measure ment dBuV/m	Limit dBuV/m	Margin dB	Detector	Comment
1 *	4958.9880	30.13	5.91	36.04	54.00	-17.96	AVG	
2	4961.0630	40.72	5.92	46.64	74.00	-27.36	Peak	

REMARKS:

- (1) Measurement Value = Reading Level + Correct Factor.
- (2) Margin Level = Measurement Value - Limit Value.

Test Mode	TX 2480 MHz _CH39_2Mbps	Polarization	Horizontal
-----------	-------------------------	--------------	------------

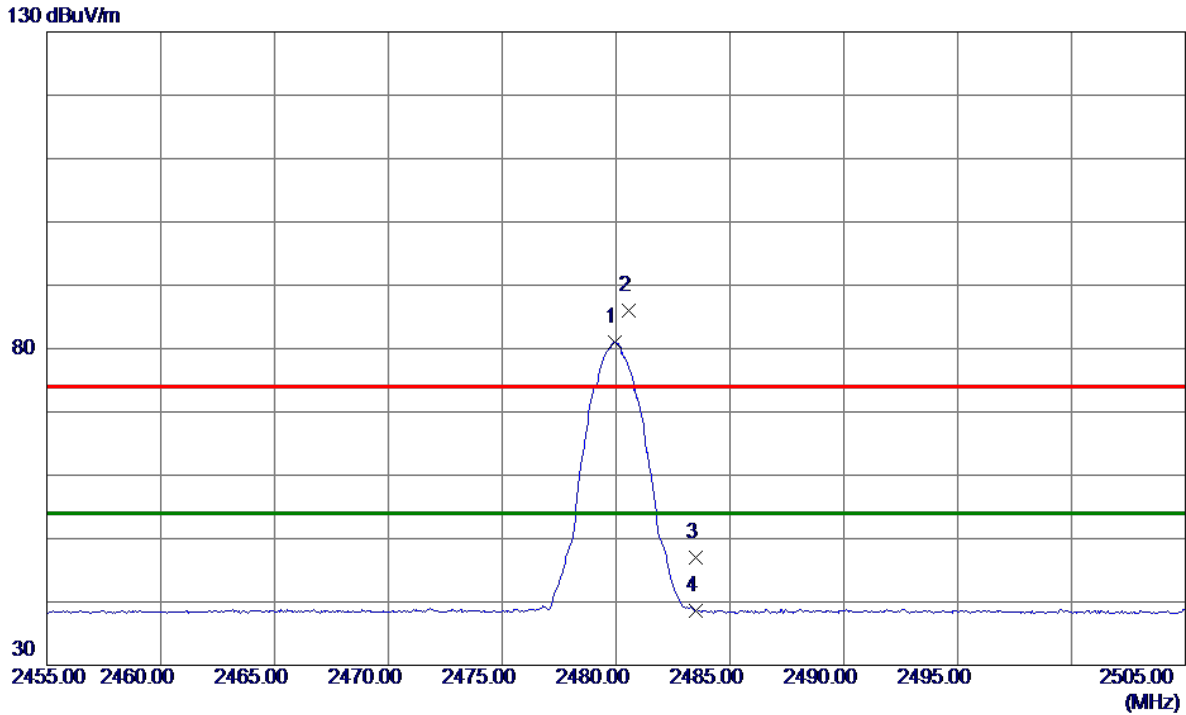

No.	Freq. MHz	Reading Level dBuV/m	Correct Factor dB	Measure ment dBuV/m	Limit dBuV/m	Margin dB	Detector	Comment
1 *	2479.9500	72.59	8.42	81.01	54.00	27.01	AVG	No Limit
2	2480.5500	77.60	8.42	86.02	74.00	12.02	Peak	No Limit
3	2483.5000	38.51	8.42	46.93	74.00	-27.07	Peak	
4	2483.5000	30.16	8.42	38.58	54.00	-15.42	AVG	

REMARKS:

- (1) Measurement Value = Reading Level + Correct Factor.
- (2) Margin Level = Measurement Value - Limit Value.

Test Mode	TX 2480 MHz _CH39_2Mbps	Polarization	Horizontal
-----------	-------------------------	--------------	------------

80 dBuV/m

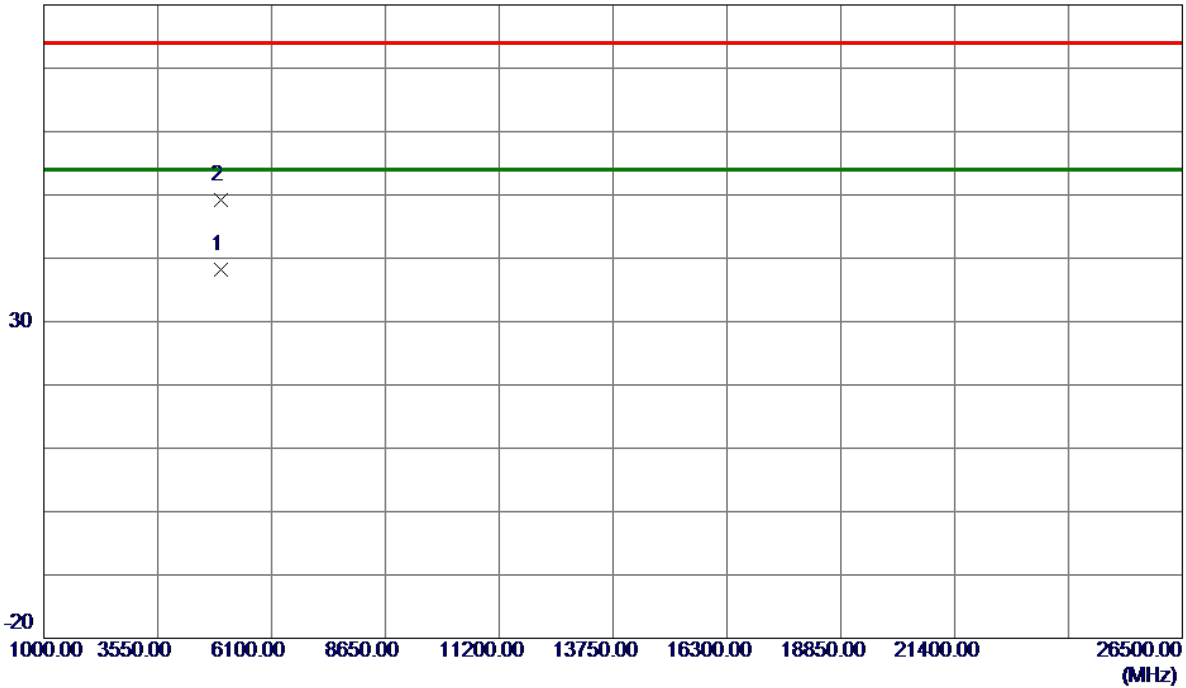

No.	Freq. MHz	Reading Level dBuV/m	Correct Factor dB	Measure ment dBuV/m	Limit dBuV/m	Margin dB	Detector	Comment
1 *	4958.9430	32.20	5.91	38.11	54.00	-15.89	AVG	
2	4961.0350	43.20	5.92	49.12	74.00	-24.88	Peak	

REMARKS:

- (1) Measurement Value = Reading Level + Correct Factor.
- (2) Margin Level = Measurement Value - Limit Value.

APPENDIX E - BANDWIDTH

Test Mode TX Mode_1Mbps

Channel	Frequency (MHz)	6 dB Bandwidth (MHz)	99 % Occupied Bandwidth (MHz)	6 dB Bandwidth Min. Limit (MHz)	Test Result
00	2402	0.706	1.040	0.5	Pass
19	2440	0.708	1.048	0.5	Pass
39	2480	0.722	1.040	0.5	Pass

CH00

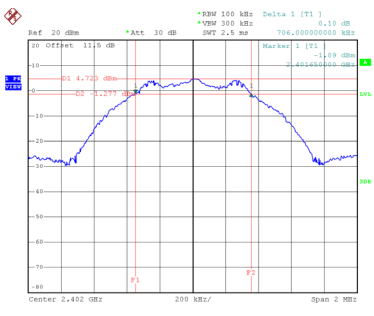

Date: 29.JUL.2021 14:58:41

CH19

6 dB Bandwidth

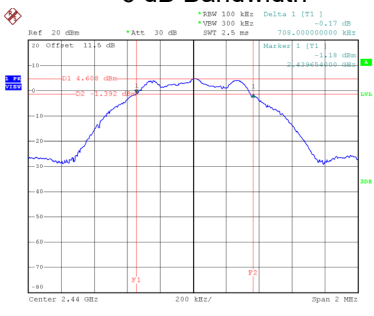

Date: 29.JUL.2021 15:00:41

CH39

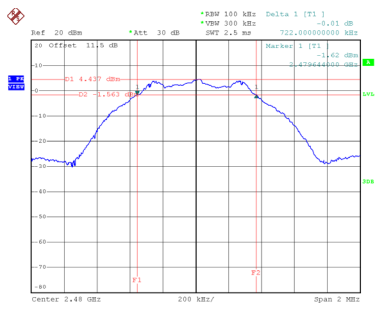

Date: 29.JUL.2021 15:03:07

99 % Occupied Bandwidth

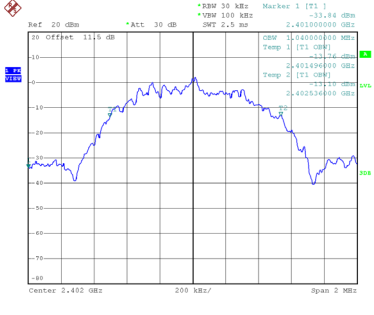

Date: 29.JUL.2021 14:57:42

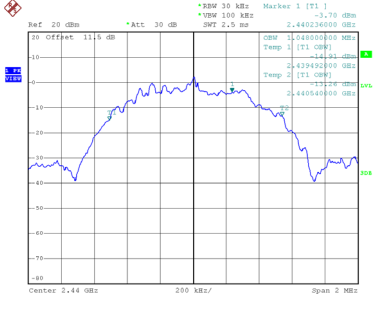

Date: 29.JUL.2021 15:00:49

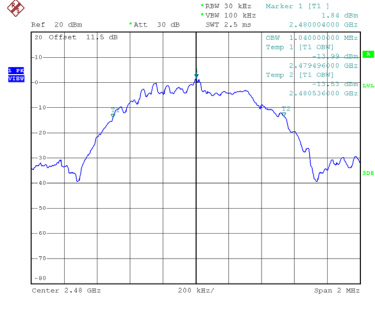

Date: 29.JUL.2021 15:03:14

Test Mode TX Mode _2Mbps

Channel	Frequency (MHz)	6 dB Bandwidth (MHz)	99 % Occupied Bandwidth (MHz)	6 dB Bandwidth Min. Limit (MHz)	Test Result
00	2402	1.180	2.056	0.5	Pass
19	2440	1.252	2.056	0.5	Pass
39	2480	1.266	2.040	0.5	Pass

CH00

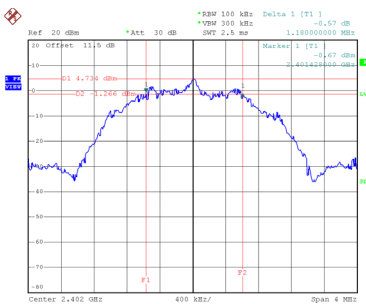

Date: 29.JUL.2021 15:05:37

CH19

6 dB Bandwidth

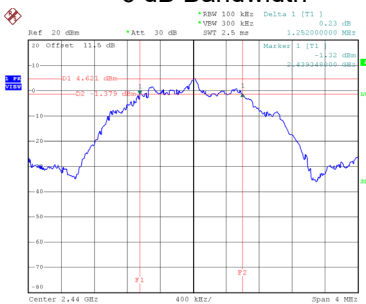

Date: 29.JUL.2021 15:07:42

CH39

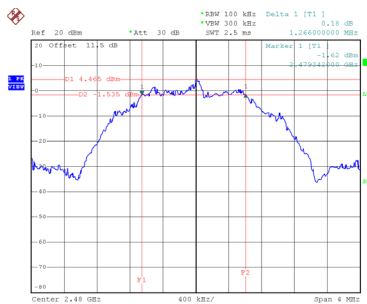

Date: 29.JUL.2021 15:09:58

99 % Occupied Bandwidth

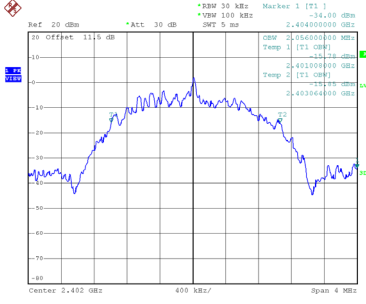

Date: 29.JUL.2021 15:04:30

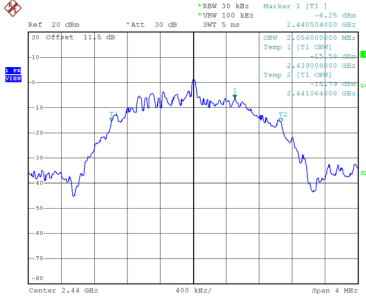

Date: 29.JUL.2021 15:07:49

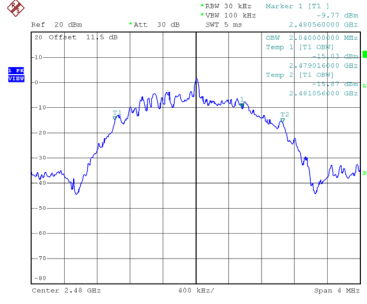

Date: 29.JUL.2021 15:10:05

APPENDIX F - MAXIMUM OUTPUT POWER

Test Mode	TX Mode _1Mbps
-----------	----------------

Frequency (MHz)	Output Power (dBm)	Output Power (W)	Max. Limit (dBm)	Max. Limit (W)	Test Result
2402	4.87	0.0031	30.00	1.0000	Pass
2440	4.78	0.0030	30.00	1.0000	Pass
2480	4.63	0.0029	30.00	1.0000	Pass

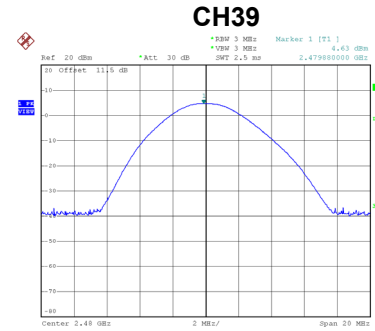
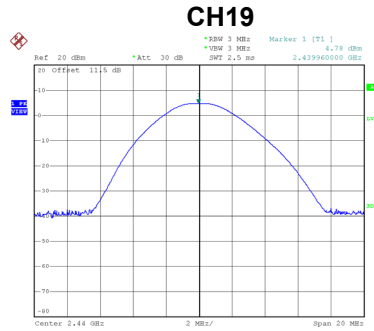
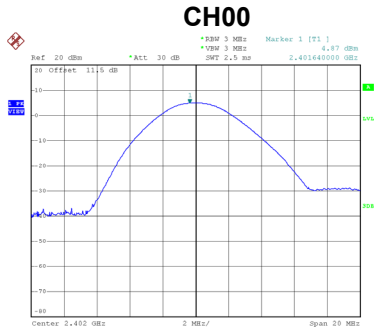

Test Mode	TX Mode _2Mbps
-----------	----------------

Frequency (MHz)	Output Power (dBm)	Output Power (W)	Max. Limit (dBm)	Max. Limit (W)	Test Result
2402	4.95	0.0031	30.00	1.0000	Pass
2440	4.80	0.0030	30.00	1.0000	Pass
2480	4.66	0.0029	30.00	1.0000	Pass

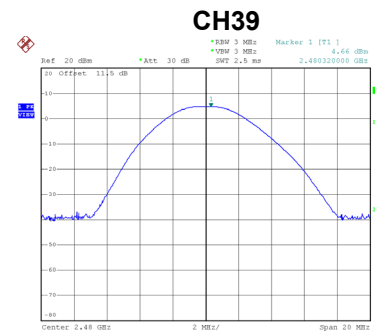
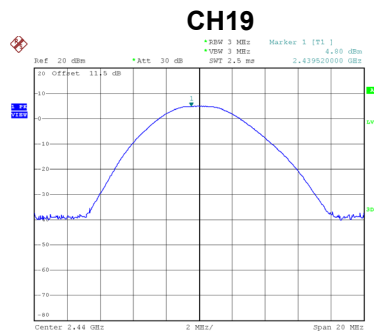
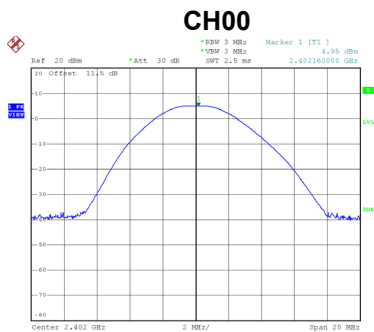

APPENDIX G - CONDUCTED SPURIOUS EMISSION

Test Mode TX Mode_1Mbps

Bandedge CH00 (Lower)

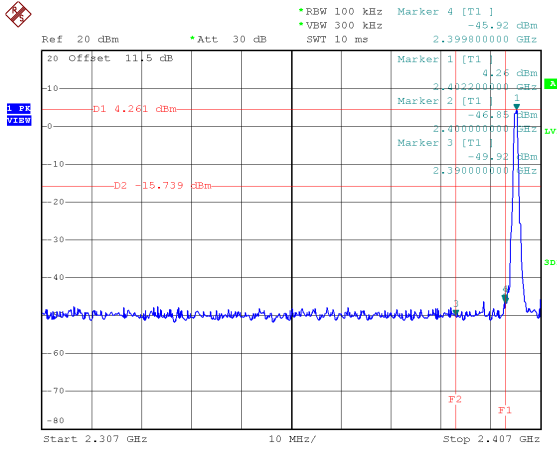

Bandedge CH39 (Upper)

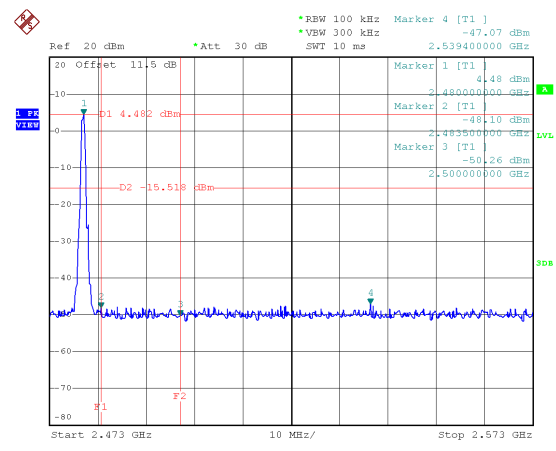

Date: 29.JUL.2021 14:58:50

Date: 29.JUL.2021 15:03:23

CH00 – 10th Harmonic of the fundamental frequency

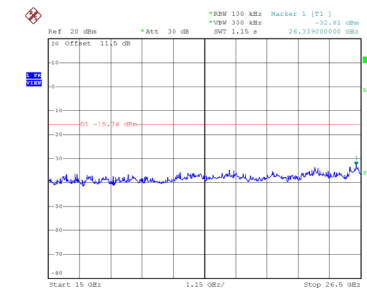
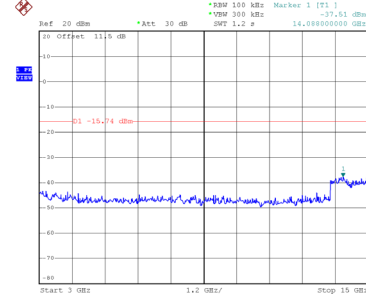
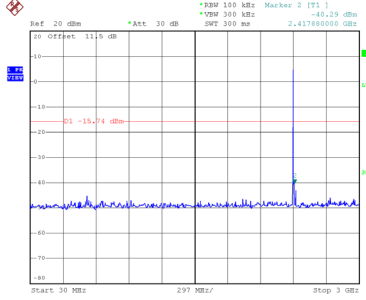

Date: 29.JUL.2021 14:59:04

Date: 29.JUL.2021 14:59:14

Date: 29.JUL.2021 14:59:23

CH19 – 10th Harmonic of the fundamental frequency

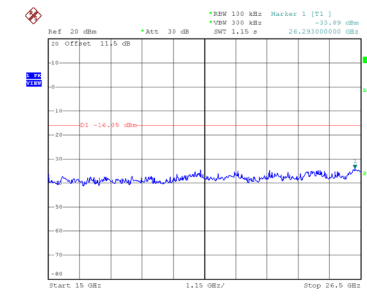
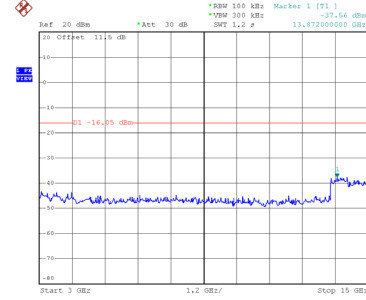
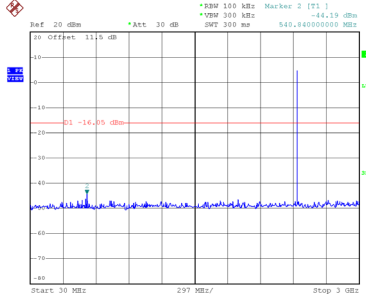

Date: 29.JUL.2021 15:01:29

Date: 29.JUL.2021 15:01:38

Date: 29.JUL.2021 15:01:47

CH39 – 10th Harmonic of the fundamental frequency

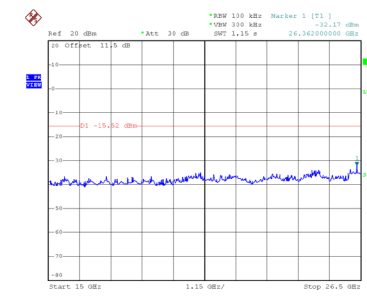
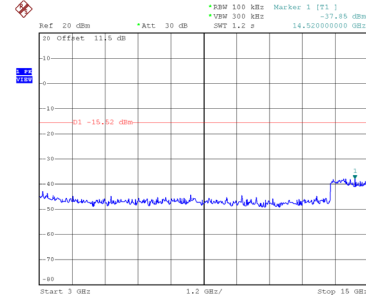
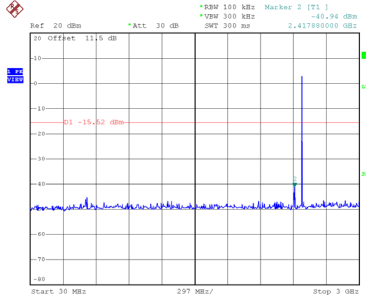

Date: 29.JUL.2021 15:03:38

Date: 29.JUL.2021 15:03:47

Date: 29.JUL.2021 15:03:56

Test Mode TX Mode_2Mbps

Bandedge CH00 (Lower)

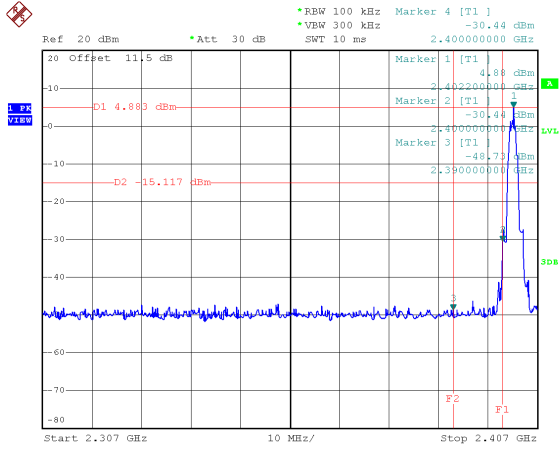

Bandedge CH39 (Upper)

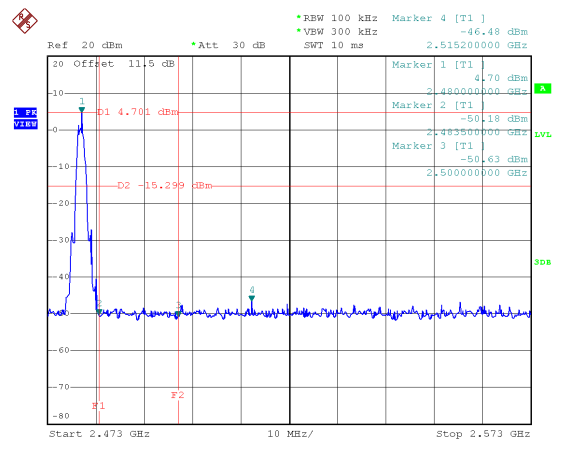

Date: 29.JUL.2021 15:05:46

Date: 29.JUL.2021 15:10:14

CH00 – 10th Harmonic of the fundamental frequency

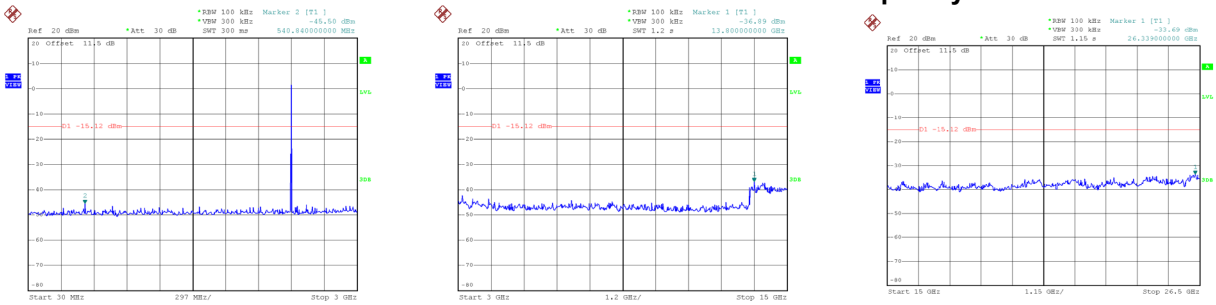

Date: 29.JUL.2021 15:06:01

Date: 29.JUL.2021 15:06:10

Date: 29.JUL.2021 15:06:19

CH19 – 10th Harmonic of the fundamental frequency

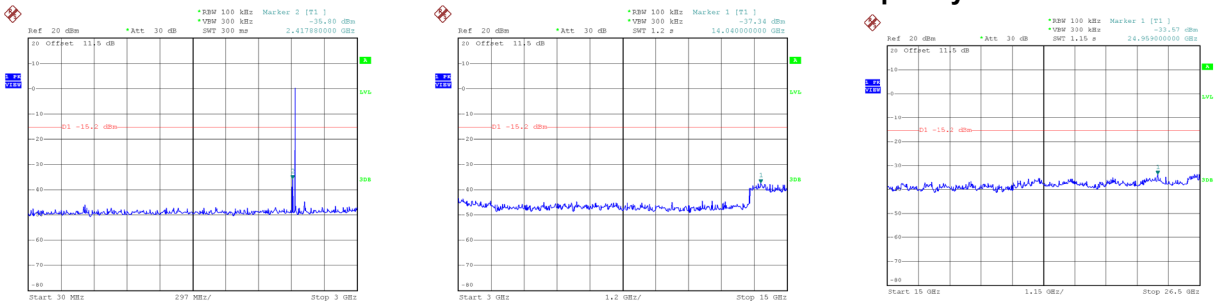

Date: 29.JUL.2021 15:08:13

Date: 29.JUL.2021 15:08:22

Date: 29.JUL.2021 15:08:31

CH39 – 10th Harmonic of the fundamental frequency

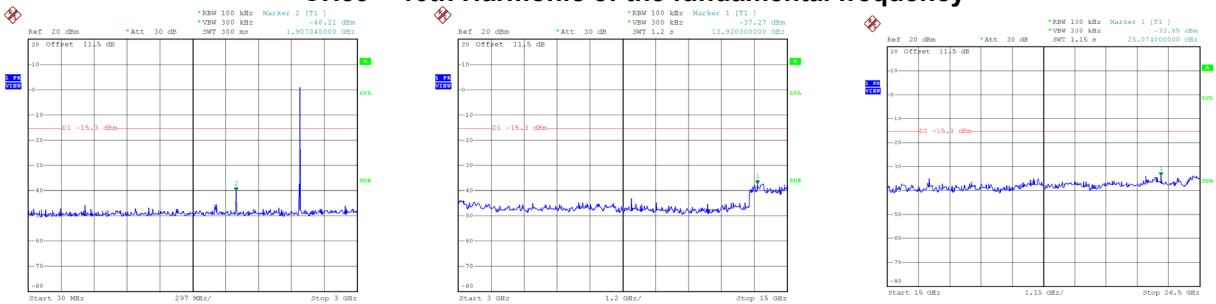

Date: 29.JUL.2021 15:10:29

Date: 29.JUL.2021 15:10:38

Date: 29.JUL.2021 15:10:47

APPENDIX H - POWER SPECTRAL DENSITY

Test Mode	TX Mode _1Mbps
-----------	----------------

Channel	Frequency (MHz)	Power Spectral Density (dBm/3 kHz)	Max. Limit (dBm/3 kHz)	Test Result
00	2402	-10.79	8.00	Pass
19	2440	-10.91	8.00	Pass
39	2480	-11.11	8.00	Pass

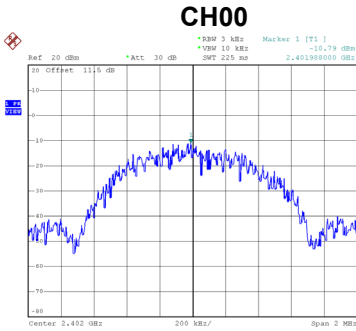

Date: 29.JUL.2021 14:59:30

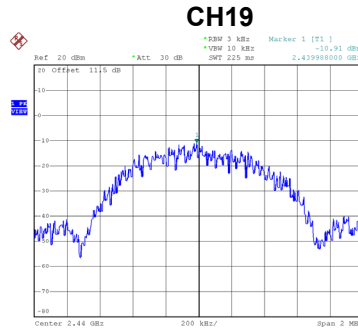

Date: 29.JUL.2021 15:01:55

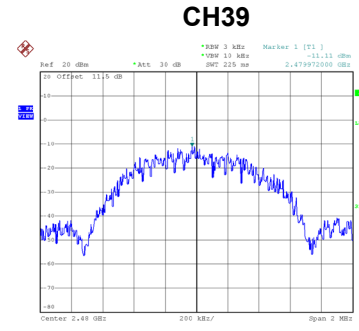

Date: 29.JUL.2021 15:04:03

Test Mode	TX Mode _2Mbps
-----------	----------------

Channel	Frequency (MHz)	Power Spectral Density (dBm/3 kHz)	Max. Limit (dBm/3 kHz)	Test Result
00	2402	-13.40	8.00	Pass
19	2440	-13.74	8.00	Pass
39	2480	-13.51	8.00	Pass

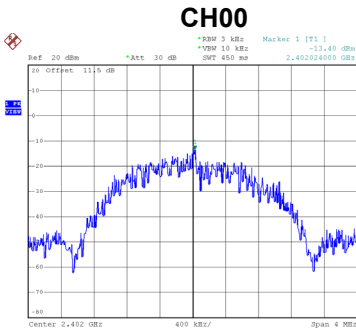

Date: 29.JUL.2021 15:06:26

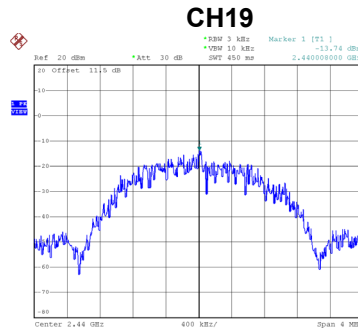

Date: 29.JUL.2021 15:08:39

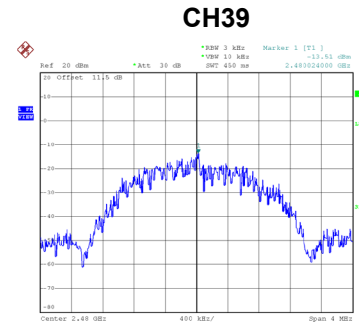

Date: 29.JUL.2021 15:10:54

End of Test Report