



# FCC TEST REPORT

**Test report  
On Behalf of  
Guangzhou AiXun Electronics Technology Co., Ltd.  
For  
Bluetooth Selfie Stick  
Model No.: Z07-11  
  
FCC ID: 2AKSK-Z0711**

**Prepared for :** Guangzhou AiXun Electronics Technology Co., Ltd.  
5th Floor, Building C, Shachong Industrial Area, NO. 613, Huawan Road, Liwan District, Guangzhou, Guangdong Province, China

**Prepared By :** Shenzhen HUAKE Testing Technology Co., Ltd.  
F1-008, Tai Yi Building, No.1, Haicheng West Road, Xixiang Street, Bao'an District, Shenzhen City, China

**Date of Test:** Dec. 23, 2016 ~ Dec. 29, 2016

**Date of Report:** Dec. 30, 2016

**Report Number:** HK1601223075-E



### TEST RESULT CERTIFICATION

**Applicant's name** ..... : Guangzhou AiXun Electronics Technology Co., Ltd.  
5th Floor, Building C, Shachong Industrial Area, NO. 613,  
**Address** ..... : Huawan Road, Liwan District, Guangzhou, Guangdong Province,  
China  
**Manufacture's Name**..... : Guangzhou AiXun Electronics Technology Co., Ltd.  
5th Floor, Building C, Shachong Industrial Area, NO. 613,  
**Address** ..... : Huawan Road, Liwan District, Guangzhou, Guangdong Province,  
China

**Product description**

**Trade Mark:** N/A  
**Product name** ..... : Bluetooth Selfie Stick  
**Model and/or type reference** : Z07-11  
**Standards** ..... : FCC Rules and Regulations Part 15 Subpart C Section 15.249  
ANSI C63.10: 2013

This publication may be reproduced in whole or in part for non-commercial purposes as long as the Shenzhen HUAK Testing Technology Co., Ltd. is acknowledged as copyright owner and source of the material. Shenzhen HUAK Testing Technology Co., Ltd. takes no responsibility for and will not assume liability for damages resulting from the reader's interpretation of the reproduced material due to its placement and context.

**Date of Test** ..... :  
**Date (s) of performance of tests** ..... : **Dec. 23, 2016 ~ Dec. 29, 2016**  
**Date of Issue**..... : **Dec. 30, 2016**  
**Test Result**..... : **Pass**

**Testing Engineer** :   
\_\_\_\_\_  
(Eric Xie)

**Technical Manager** :   
\_\_\_\_\_  
(Dora Qin)

**Authorized Signatory** :   
\_\_\_\_\_  
(Kait Chen)



<b>Table of Contents</b>	<b>Page</b>
1 . TEST SUMMARY	4
2 . GENERAL INFORMATION	5
2.1 GENERAL DESCRIPTION OF EUT	5
Operation of EUT during testing	6
2.2 DESCRIPTION OF TEST SETUP	6
2.3 MEASUREMENT INSTRUMENTS LIST	7
3 . CONDUCTED EMISSIONS TEST	8
3.1 Conducted Power Line Emission Limit	8
3.2 Test Setup	8
3.3 Test Procedure	8
3.4 Test Result	8
4 RADIATED EMISSION TEST	11
4.1 Radiation Limit	11
4.2 Test Setup	11
4.3 Test Procedure	12
4.4 Test Result	12
5 BAND EDGE	18
5.1 Limits	18
5.2 Test Procedure	18
5.3 Test Result	18
6 OCCUPIED BANDWIDTH MEASUREMENT	20
6.1 Test Setup	20
6.2 Test Procedure	20
6.3 Measurement Equipment Used	20
6.4 Test Result	20
7 ANTENNA REQUIREMENT	23
8 PHOTOGRAPH OF TEST	24
8.1 Radiated Emission	24
8.2 Conducted Emission	25



## 1. TEST SUMMARY

### 1.1 TEST PROCEDURES AND RESULTS

DESCRIPTION OF TEST	RESULT
CONDUCTED EMISSIONS TEST	COMPLIANT
RADIATED EMISSION TEST	COMPLIANT
BAND EDGE	COMPLIANT
OCCUPIED BANDWIDTH MEASUREMENT	COMPLIANT
ANTENNA REQUIREMENT	COMPLIANT

### 1.2 TEST FACILITY

Test Firm : Dongguan Dongdian Testing Service Co., Ltd  
Certificated by FCC, Registration No.: 270092

Address : No.17 Zongbu road 2, Songshan Lake Sci&Tech Park, DongGuan  
City, Guangdong province,523808 China

### 1.3 MEASUREMENT UNCERTAINTY

Measurement Uncertainty

Conducted Emission Expanded Uncertainty	= 2.23dB, k=2
Radiated emission expanded uncertainty(9kHz-30MHz)	= 3.08dB, k=2
Radiated emission expanded uncertainty(30MHz-1000MHz)	= 4.42dB, k=2
Radiated emission expanded uncertainty(Above 1GHz)	= 4.06dB, k=2



## 2. GENERAL INFORMATION

### 2.1 GENERAL DESCRIPTION OF EUT

Equipment	Bluetooth Selfie Stick
Model Name	Z07-11
Serial No	N/A
Model Difference	N/A
FCC ID	<b>2AKSK-Z0711</b>
Antenna Type	PCB Antenna
Antenna Gain	0dBi
Operation frequency	Bluetooth 4.0: 2402-2480MHz
Number of Channels	40CH
Modulation Type	GFSK
Power Source	N/A
Power Rating	DC 3.7V from battery or DC 5V from adapter



## 2.1.1 Carrier Frequency of Channels

Channel List							
Channel	Frequency (MHz)	Channel	Frequency (MHz)	Channel	Frequency (MHz)	Channel	Frequency (MHz)
01	2402	11	2422	21	2442	31	2462
02	2404	12	2424	22	2444	32	2464
03	2406	13	2426	23	2446	33	2466
04	2408	14	2428	24	2448	34	2468
05	2410	15	2430	25	2450	35	2470
06	2412	16	2432	26	2452	36	2472
07	2414	17	2434	27	2454	37	2474
08	2416	18	2436	28	2456	38	2476
09	2418	19	2438	29	2458	39	2478
10	2420	20	2440	30	2460	40	2480

## Operation of EUT during testing

## Operating Mode

The mode is used: **Transmitting mode for BT**

Low Channel: 2402MHz

Middle Channel: 2440MHz

High Channel: 2480MHz

## 2.2 DESCRIPTION OF TEST SETUP

## Operation of EUT during conducted testing:

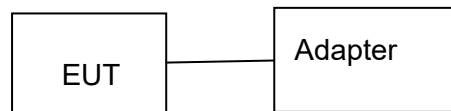

## Operation of EUT during Radiation testing:

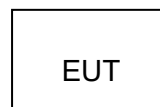



## 2.3 MEASUREMENT INSTRUMENTS LIST

Item	Equipment	Manufacturer	Model No.	Serial No.	Last Cal.	Cal. Interval
1.	EMI Receiver	Rohde & Schwarz	ESCI	100627	Feb. 19, 2016	1 Year
2.	LISN	SchwarzBeck	NSLK 8126	8126377	Feb. 19, 2016	1 Year
3.	RF Switching Unit	Compliance Direction	RSU-M2	38303	Feb. 19, 2016	1 Year
4.	EMI Test Software ES-K1	Rohde & Schwarz	N/A	N/A	N/A	N/A
5.	EMI Test Receiver	Rohde & Schwarz	ESCI	100627	Feb. 19, 2016	1 Year
6.	Trilog Broadband Antenna	Schwarzbeck	VULB9163	VULB 9163-289	Feb. 19, 2016	1 Year
7.	Pre-amplifier	Compliance Direction	PAP-0203	22008	Feb. 19, 2016	1 Year
8.	EMI Test Software EZ-EMC	SHURPLE	N/A	N/A	N/A	N/A
9.	EMI Receiver	Rohde & Schwarz	ESCI	100627	Feb. 19, 2016	1 Year
10.	LISN	SchwarzBeck	NSLK 8126	8126377	Feb. 19, 2016	1 Year
11.	RF Switching Unit	Compliance Direction	RSU-M2	38303	Feb. 19, 2016	1 Year
12.	EMI Test Software ES-K1	Rohde & Schwarz	N/A	N/A	N/A	N/A
13.	EMI Receiver	Rohde & Schwarz	ESCI	100627	Feb. 19, 2016	1 Year
14.	EMI Receiver	Rohde & Schwarz	ESCI	100627	Feb. 19, 2016	1 Year
15.	LISN	SchwarzBeck	NSLK 8126	8126377	Feb. 19, 2016	1 Year
16.	RF Switching Unit	Compliance Direction	RSU-M2	38303	Feb. 19, 2016	1 Year
17.	EMI Test Software ES-K1	Rohde & Schwarz	N/A	N/A	N/A	N/A
18.	Power Meter	R&S	NRVD	SEL0069	Feb. 19, 2016	1 Year
19.	Power Sensor	R&S	URV5-Z2	SEL0071	Feb. 19, 2016	1 Year
20.	Power Sensor	R&S	URV5-Z2	SEL0072	Feb. 19, 2016	1 Year
21.	Software EMC32	R&S	EMC32-S	SEL0082	N/A	N/A
22.	Log-periodic Antenna	Amplifier Reasearch	AZ07-1180	SEL0073	N/A	N/A
23.	Antenna Tripod	Amplifier Reasearch	TP1000A	SEL0074	N/A	N/A
24.	High Gain Horn Antenna(0.8-5GHz)	Amplifier Reasearch	AT4002A	SEL0075	N/A	N/A
25.	Spectrum analyzer	Agilent	N9020A	MY499110 048	Feb. 19, 2016	1 Year
26.	Spectrum Analyzer	R&S	FSP	SEL0177	Feb. 19, 2016	1 Year
27.	Spectrum analyzer	Agilent	E4407B	MY461843 26	Feb. 19, 2016	1 Year
28.	Audio Analyzer	R&S	UPL	SEL0136	Feb. 19, 2016	1 Year



### 3. CONDUCTED EMISSIONS TEST

#### 3.1 Conducted Power Line Emission Limit

For unintentional device, according to § 15.107(a) Line Conducted Emission Limits is as following

Frequency (MHz)	Maximum RF Line Voltage (dB $\mu$ V)			
	CLASS A		CLASS B	
	Q.P.	Ave.	Q.P.	Ave.
0.15 - 0.50	79	66	66-56*	56-46*
0.50 - 5.00	73	60	56	46
5.00 - 30.0	73	60	60	50

\* Decreasing linearly with the logarithm of the frequency

For intentional device, according to §15.207(a) Line Conducted Emission Limit is same as above table.

#### 3.2 Test Setup

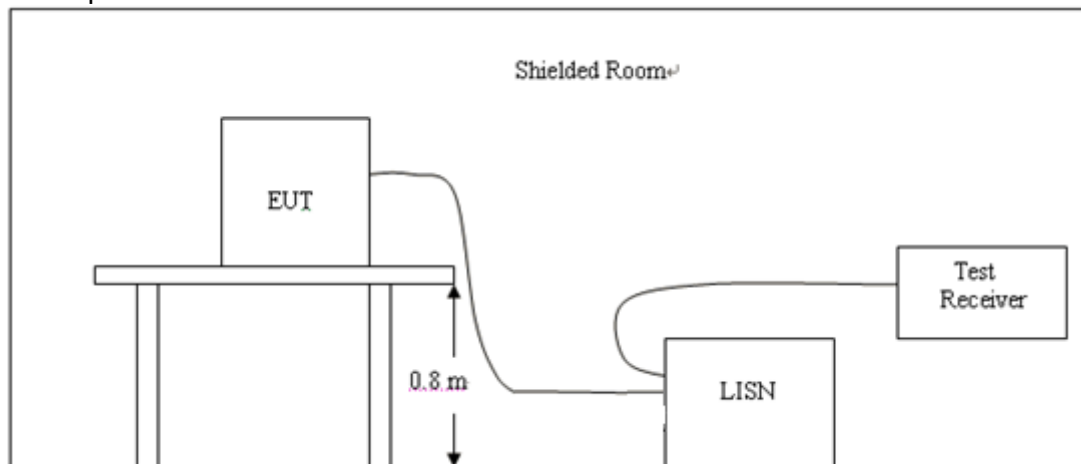

#### 3.3 Test Procedure

- 1, The equipment was set up as per the test configuration to simulate typical actual usage per the user's manual. The EUT is a tabletop system, a wooden table with a height of 0.8 meters is used and is placed on the ground plane as per ANSI C63.10.
- 2, Support equipment, if needed, was placed as per ANSI C63.10.
- 3, All I/O cables were positioned to simulate typical actual usage as per ANSI C63.10.
- 4, If a EUT received DC power from the USB Port of Notebook PC, the PC's adapter received AC120V/60Hz power through a Line Impedance Stabilization Network (LISN) which supplied power source and was grounded to the ground plane.
- 5, All support equipments received AC power from a second LISN, if any.
- 6, The EUT test program was started. Emissions were measured on each current carrying line of the EUT using a spectrum Analyzer / Receiver connected to the LISN powering the EUT. The LISN has two monitoring points: Line 1 (Hot Side) and Line 2 (Neutral Side). Two scans were taken: one with Line 1 connected to Analyzer / Receiver and Line 2 connected to a 50 ohm load; the second scan had Line 1 connected to a 50 ohm load and Line 2 connected to the Analyzer / Receiver.
- 7, Analyzer / Receiver scanned from 150 KHz to 30MHz for emissions in each of the test modes.

#### 3.4 Test Result

PASS

All the test modes completed for test.



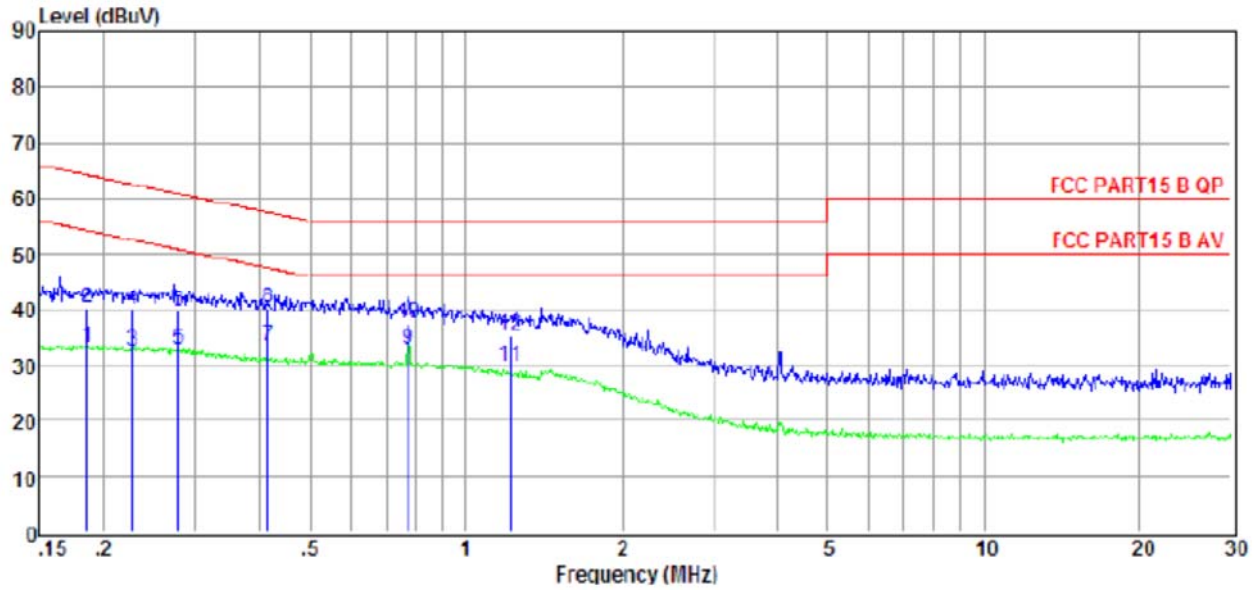

Item (Mark)	Freq. (MHz)	Read Level (dBuV)	LISN Factor (dB)	Cable Loss (dB)	Pulse Limiter Factor (dB)	Result Level (dBuV)	Limit Line (dBuV)	Over Limit (dB)	Detector	Phase
1	0.185	13.51	9.61	0.02	9.86	33.00	54.24	-21.24	Average	LINE
2	0.185	20.65	9.61	0.02	9.86	40.14	64.24	-24.10	QP	LINE
3	0.227	13.14	9.61	0.02	9.86	32.63	52.57	-19.94	Average	LINE
4	0.227	20.48	9.61	0.02	9.86	39.97	62.57	-22.60	QP	LINE
5	0.279	13.25	9.61	0.02	9.86	32.74	50.85	-18.11	Average	LINE
6	0.279	20.09	9.61	0.02	9.86	39.58	60.85	-21.27	QP	LINE
7	0.415	13.79	9.61	0.02	9.86	33.28	47.55	-14.27	Average	LINE
8	0.415	20.58	9.61	0.02	9.86	40.07	57.55	-17.48	QP	LINE
9	0.775	13.30	9.61	0.03	9.86	32.80	46.00	-13.20	Average	LINE
10	0.775	17.93	9.61	0.03	9.86	37.43	56.00	-18.57	QP	LINE
11	1.216	10.04	9.62	0.03	9.86	29.55	46.00	-16.45	Average	LINE
12	1.216	15.82	9.62	0.03	9.86	35.33	56.00	-20.67	QP	LINE

- Note: 1. Result Level = Read Level + LISN Factor + Pulse Limiter Factor + Cable loss.  
 2. If QP Result complies with AV limit, AV Result is deemed to comply with AV limit.  
 3. Test setup: RBW: 200 Hz (9 kHz—150 kHz), 9 kHz (150 kHz—30 MHz).  
 4. Step size: 80Hz (0.009MHz-0.15MHz), 4 kHz (0.15MHz-30MHz), Scan time: auto.

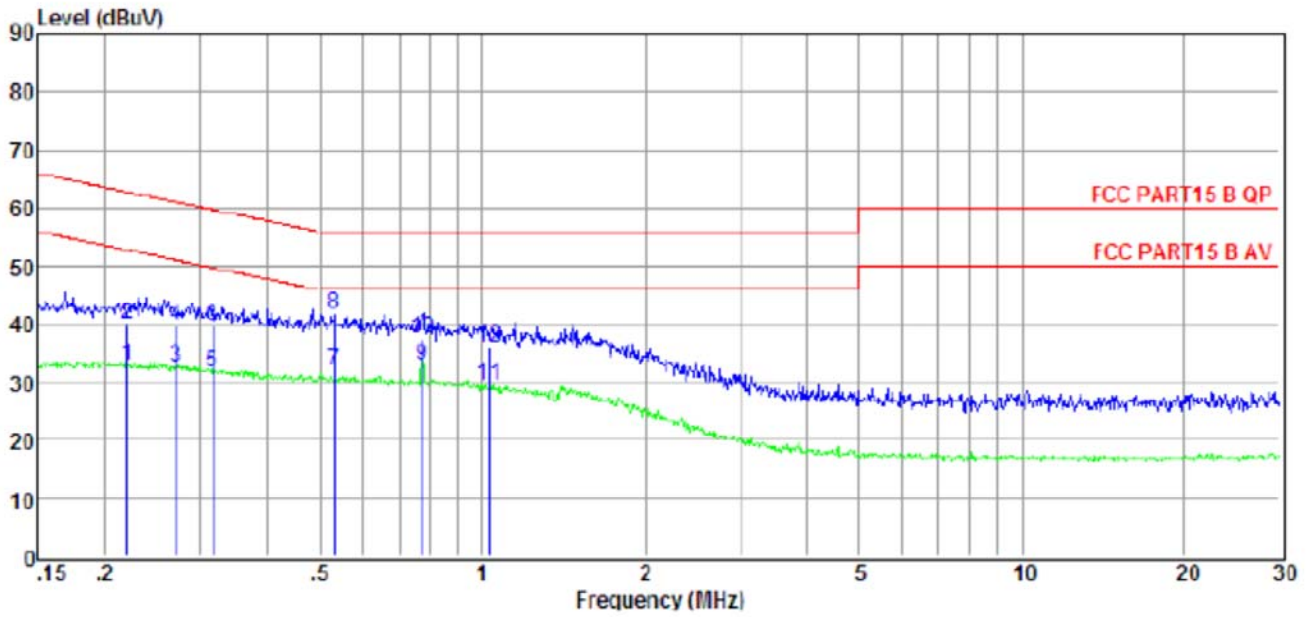

Item (Mark)	Freq. (MHz)	Read Level (dBuV)	LISN Factor (dB)	Cable Loss (dB)	Pulse Limiter Factor (dB)	Result Level (dBuV)	Limit Line (dBuV)	Over Limit (dB)	Detector	Phase
1	0.220	13.43	9.61	0.02	9.86	32.92	52.83	-19.91	Average	NEUTRAL
2	0.220	20.37	9.61	0.02	9.86	39.86	62.83	-22.97	QP	NEUTRAL
3	0.270	12.97	9.61	0.02	9.86	32.46	51.12	-18.66	Average	NEUTRAL
4	0.270	20.12	9.61	0.02	9.86	39.61	61.12	-21.51	QP	NEUTRAL
5	0.317	12.20	9.61	0.02	9.86	31.69	49.80	-18.11	Average	NEUTRAL
6	0.317	20.09	9.61	0.02	9.86	39.58	59.80	-20.22	QP	NEUTRAL
7	0.532	12.36	9.61	0.03	9.86	31.86	46.00	-14.14	Average	NEUTRAL
8	0.532	22.30	9.61	0.03	9.86	41.80	56.00	-14.20	QP	NEUTRAL
9	0.775	13.37	9.61	0.03	9.86	32.87	46.00	-13.13	Average	NEUTRAL
10	0.775	17.77	9.61	0.03	9.86	37.27	56.00	-18.73	QP	NEUTRAL
11	1.027	9.84	9.61	0.03	9.86	29.34	46.00	-16.66	Average	NEUTRAL
12	1.027	16.38	9.61	0.03	9.86	35.88	56.00	-20.12	QP	NEUTRAL

- Note: 1. Result Level = Read Level + LISN Factor + Pulse Limiter Factor + Cable loss.  
 2. If QP Result complies with AV limit, AV Result is deemed to comply with AV limit.  
 3. Test setup: RBW: 200 Hz (9 kHz—150 kHz), 9 kHz (150 kHz—30 MHz).  
 4. Step size: 80Hz (0.009MHz-0.15MHz), 4 kHz (0.15MHz-30MHz), Scan time: auto.

## 4 RADIATED EMISSION TEST

### 4.1 Radiation Limit

For unintentional device, according to § 15.109(a), except for Class A digital devices, the field strength of radiated emissions from unintentional radiators at a distance of 3 meters shall not exceed the following values:

Frequency (MHz)	Distance (Meters)	Radiated (dB $\mu$ V/m)	Radiated ( $\mu$ V/m)
30-88	3	40	100
88-216	3	43.5	150
216-960	3	46	200
Above 960	3	54	500

For intentional device, according to § 15.209(a), the general requirement of field strength of radiated emissions from intentional radiators at a distance of 3 meters shall not exceed the above table.

### 4.2 Test Setup

#### (1) Radiated Emission Test-Up Frequency Below 30MHz

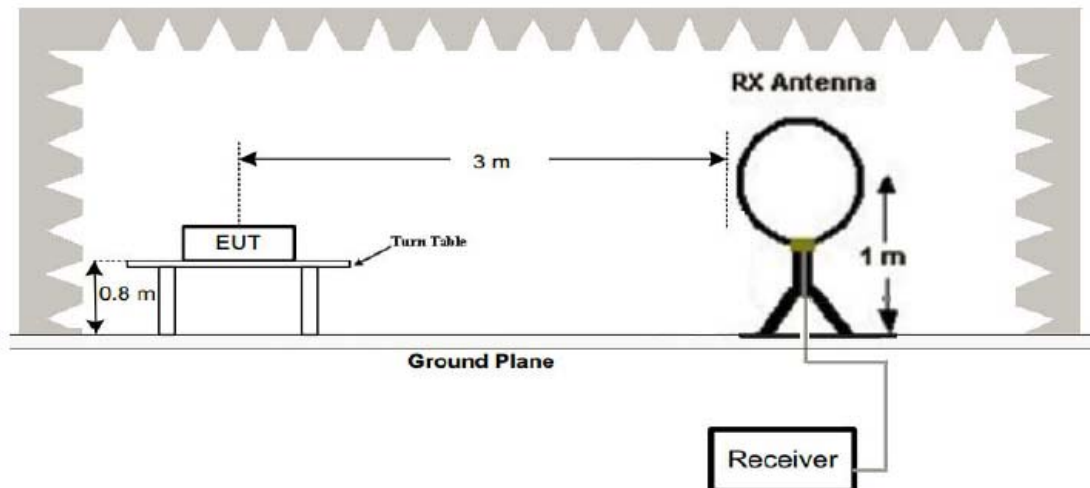

#### (2) Radiated Emission Test-Up Frequency 30MHz~1GHz

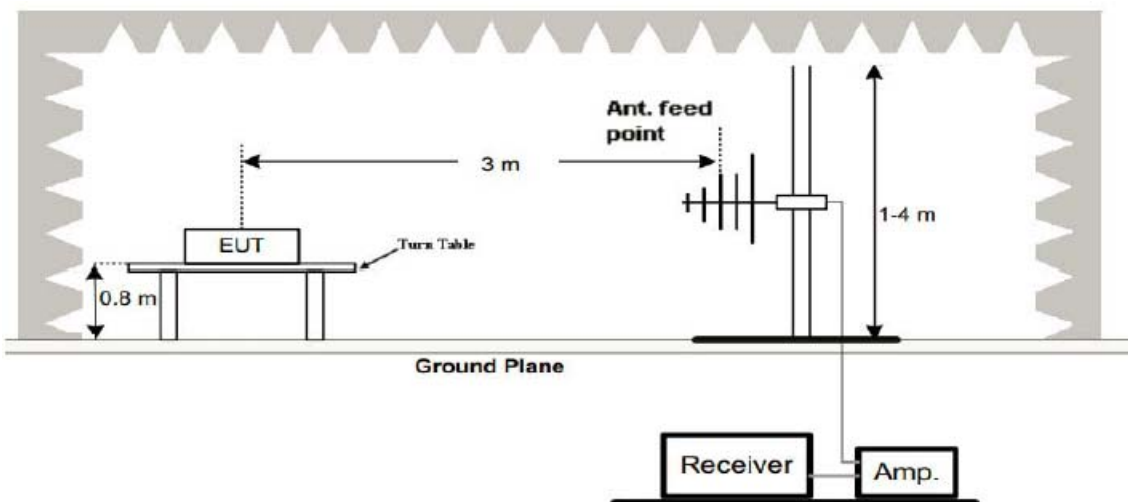

### (3) Radiated Emission Test-Up Frequency Above 1GHz

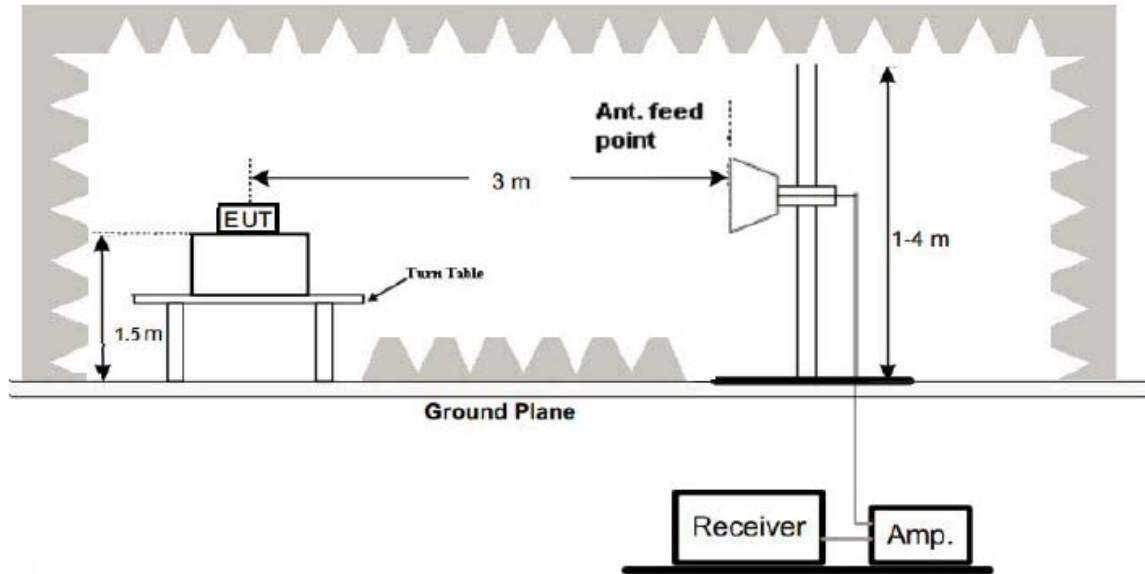

#### 4.3 Test Procedure

1. Below 1GHz measurement the EUT is placed on turntable which is 0.1m above ground plane. And above 1GHz measurement EUT was placed on low permittivity and low tangent turn table which is 1.5m above ground plane.
2. The turntable shall be rotated for 360 degrees to determine the position of maximum emission level.
3. EUT is set 3m away from the receiving antenna, which is varied from 1m to 4m to find out the highest emissions.
4. Maximum procedure was performed on the six highest emissions to ensure EUT compliance.
5. And also, each emission was to be maximized by changing the polarization of receiving antenna both horizontal and vertical.
6. Repeat above procedures until the measurements for all frequencies are complete.
7. The test frequency range from 9KHz to 25GHz per FCC PART 15.33(a).

#### Note:

For battery operated equipment, the equipment tests shall be performed using a new battery.

#### 4.4 Test Result

**PASS**

All the test modes completed for test. The worst case of Radiated Emission; the test data of this mode was reported.



Below 1GHz Test Results:  
Antenna polarity: H

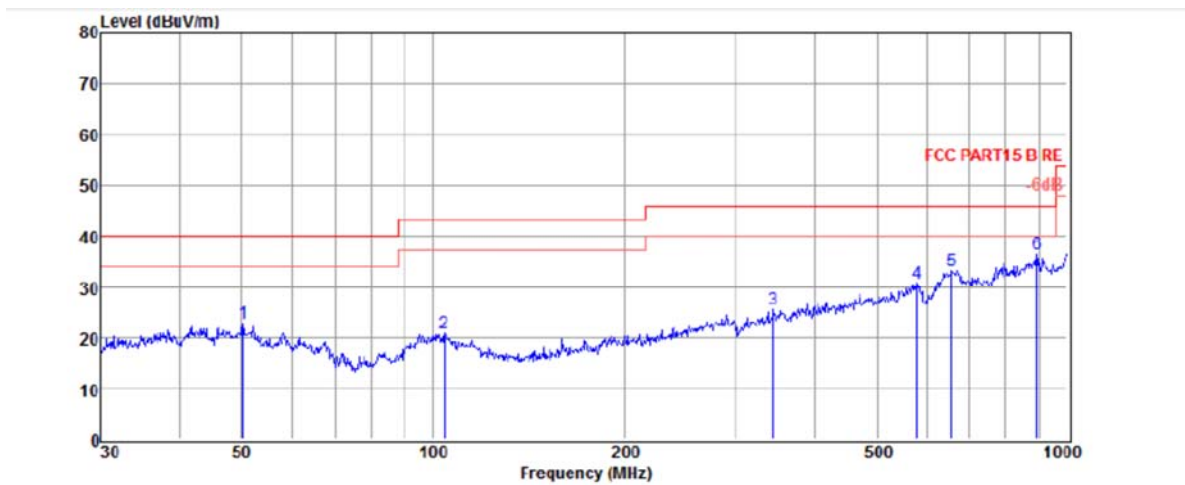

Item (Mark)	Freq. (MHz)	Read Level (dBuV)	Antenna Factor (dB/m)	Cable Loss dB	Result Level (dBuV/m)	Limit Line (dBuV/m)	Over Limit (dB)	Detector	Polarization
1	50.232	5.96	13.21	3.63	22.80	40.00	-17.20	Peak	HORIZONTAL
2	104.170	5.66	11.24	4.02	20.92	43.50	-22.58	Peak	HORIZONTAL
3	343.180	6.02	14.59	5.03	25.64	46.00	-20.36	Peak	HORIZONTAL
4	578.670	6.58	18.41	5.77	30.76	46.00	-15.24	Peak	HORIZONTAL
5	656.530	5.74	21.45	6.00	33.19	46.00	-12.81	Peak	HORIZONTAL
6	893.857	7.09	22.70	6.65	36.44	46.00	-9.56	Peak	HORIZONTAL

- Note: 1. Result Level = Read Level + Antenna Factor + Cable loss.  
 2. If Peak Result complies with QP limit, QP Result is deemed to comply with QP limit.  
 3. Test setup: RBW: 120 kHz, VBW: 300 kHz, Sweep time: auto.



Antenna polarity: V

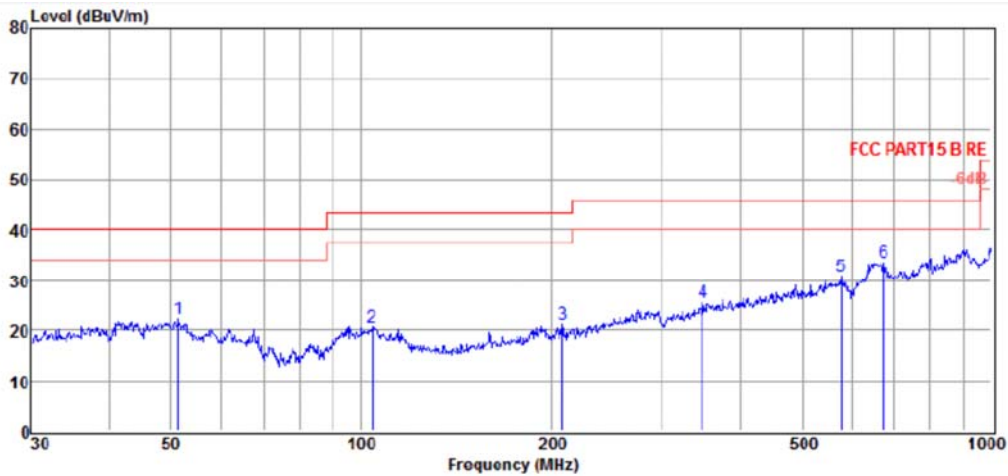

Item (Mark)	Freq. (MHz)	Read Level (dBuV)	Antenna Factor (dB/m)	Cable Loss (dB)	Result Level (dBuV/m)	Limit Line (dBuV/m)	Over Limit (dB)	Detector	Polarization
1	51.301	5.36	13.20	3.64	22.20	40.00	-17.80	Peak	VERTICAL
2	104.170	5.47	11.24	4.02	20.73	43.50	-22.77	Peak	VERTICAL
3	208.580	6.15	10.61	4.45	21.21	43.50	-22.29	Peak	VERTICAL
4	348.027	5.71	14.76	5.05	25.52	46.00	-20.48	Peak	VERTICAL
5	576.644	6.59	18.36	5.76	30.71	46.00	-15.29	Peak	VERTICAL
6	672.844	7.13	20.30	6.05	33.48	46.00	-12.52	Peak	VERTICAL

Note: 1. Result Level = Read Level + Antenna Factor + Cable loss.  
 2. If Peak Result complies with QP limit, QP Result is deemed to comply with QP limit.  
 3. Test setup: RBW: 120 kHz, VBW: 300 kHz, Sweep time: auto.

Remark:

- (1) Measuring frequencies from 9 KHz to the 1 GHz, Radiated emission test from 9KHz to 30MHz was verified, and no any emission was found except system noise floor.
- (2) \* denotes emission frequency which appearing within the Restricted Bands specified in provision of 15.205, then the general radiated emission limits in 15.209 apply.
- (3) The IF bandwidth of EMI Test Receiver between 30MHz to 1GHz was 120KHz, 1 MHz for measuring above 1 GHz, below 30MHz was 10KHz.



## Above 1 GHz Test Results:

CH Low (2402MHz)  
Horizontal:

Frequency	Meter Reading	Factor	Emission Level	Limits	Margin	Detector Type
(MHz)	(dB $\mu$ V)	(dB)	(dB $\mu$ V/m)	(dB $\mu$ V/m)	(dB)	
2402	113.28	-5.84	107.44	114	-6.56	peak
2402	85.25	-5.84	79.41	94	-14.59	AVG
4804	56.75	-3.64	53.11	74	-20.89	peak
4804	45.28	-3.64	41.64	54	-12.36	AVG
7206	54.67	-0.95	53.72	74	-20.28	peak
7206	39.63	-0.95	38.68	54	-15.32	AVG
---	---	---	---	---	---	---
---	---	---	---	---	---	---

Remark: Factor = Antenna Factor + Cable Loss – Pre-amplifier.

Vertical:

Frequency	Meter Reading	Factor	Emission Level	Limits	Margin	Detector Type
(MHz)	(dB $\mu$ V)	(dB)	(dB $\mu$ V/m)	(dB $\mu$ V/m)	(dB)	
2402	110.27	-5.84	104.43	114	-9.57	peak
2402	85.34	-5.84	79.50	94	-14.50	AVG
4804	57.28	-3.64	53.64	74	-20.36	peak
4804	44.13	-3.64	40.49	54	-13.51	AVG
7206	54.32	-0.95	53.37	74	-20.63	peak
7206	38.63	-0.95	37.68	54	-16.32	AVG
---	---	---	---	---	---	---
---	---	---	---	---	---	---

Remark: Factor = Antenna Factor + Cable Loss – Pre-amplifier.



CH Middle (2440MHz)  
Horizontal:

Frequency	Meter Reading	Factor	Emission Level	Limits	Margin	Detector Type
(MHz)	(dB $\mu$ V)	(dB)	(dB $\mu$ V/m)	(dB $\mu$ V/m)	(dB)	
2440	109.74	-5.71	104.03	114	-9.97	peak
2440	84.63	-5.71	78.92	94	-15.08	AVG
4880	57.73	-3.51	54.22	74	-19.78	peak
4880	45.38	-3.51	41.87	54	-12.13	AVG
7320	53.52	-0.82	52.70	74	-21.30	peak
7320	36.37	-0.82	35.55	54	-18.45	AVG
---	---	---	---	---	---	---
---	---	---	---	---	---	---

Remark: Factor = Antenna Factor + Cable Loss – Pre-amplifier.

Vertical:

Frequency	Meter Reading	Factor	Emission Level	Limits	Margin	Detector Type
(MHz)	(dB $\mu$ V)	(dB)	(dB $\mu$ V/m)	(dB $\mu$ V/m)	(dB)	
2440	108.28	-5.71	102.57	114	-11.43	peak
2440	83.62	-5.71	77.91	94	-16.09	AVG
4880	57.34	-3.51	53.83	74	-20.17	peak
4880	43.39	-3.51	39.88	54	-14.12	AVG
7320	54.27	-0.82	53.45	74	-20.55	peak
7320	39.31	-0.82	38.49	54	-15.51	AVG
---	---	---	---	---	---	---
---	---	---	---	---	---	---

Remark: Factor = Antenna Factor + Cable Loss – Pre-amplifier.





CH High (2480MHz)  
Horizontal:

Frequency	Meter Reading	Factor	Emission Level	Limits	Margin	Detector Type
(MHz)	(dB $\mu$ V)	(dB)	(dB $\mu$ V/m)	(dB $\mu$ V/m)	(dB)	
2480	108.53	-5.65	102.88	114	-11.12	peak
2480	84.18	-5.65	78.53	94	-15.47	AVG
4960	56.45	-3.43	53.02	74	-20.98	peak
4960	44.34	-3.43	40.91	54	-13.09	AVG
7440	51.42	-0.75	50.67	74	-23.33	peak
7440	39.84	-0.75	39.09	54	-14.91	AVG
---	---	---	---	---	---	---
---	---	---	---	---	---	---

Remark: Factor = Antenna Factor + Cable Loss – Pre-amplifier.

Vertical:

Frequency	Meter Reading	Factor	Emission Level	Limits	Margin	Detector Type
(MHz)	(dB $\mu$ V)	(dB)	(dB $\mu$ V/m)	(dB $\mu$ V/m)	(dB)	
2480	107.26	-5.65	101.61	114	-12.39	peak
2480	82.12	-5.65	76.47	94	-17.53	AVG
4960	56.17	-3.43	52.74	74	-21.26	peak
4960	44.38	-3.43	40.95	54	-13.05	AVG
7440	53.52	-0.75	52.77	74	-21.23	peak
7440	38.46	-0.75	37.71	54	-16.29	AVG
---	---	---	---	---	---	---
---	---	---	---	---	---	---

Remark: Factor = Antenna Factor + Cable Loss – Pre-amplifier.

Remark:

- (1) Measuring frequencies from 1 GHz to the 25 GHz.
- (2) "F" denotes fundamental frequency; "H" denotes spurious frequency. "E" denotes band edge frequency.
- (3) \* denotes emission frequency which appearing within the Restricted Bands specified in provision of 15.205, then the general radiated emission limits in 15.209 apply.
- (4) Data of measurement within this frequency range shown "----" in the table above means the reading of emissions are attenuated more than 20dB below the permissible limits or the field strength is too small to be measured.
- (5) The IF bandwidth of EMI Test Receiver between 30MHz to 1GHz was 120KHz, 1 MHz for measuring above 1 GHz, below 30MHz was 10KHz.
- (6) When the test results of Peak Detected below the limits of Average Detected, the Average Detected is not need completed. For example: Top Channel at Fundamental 73.16dBuV/m(PK Value) <93.98(AV Limit), at harmonic 53.20 dBuV/m(PK Value) <54 dBuV/m(AV Limit), the Average Detected not need to completed.



## 5 BAND EDGE

### 5.1 Limits

FCC PART 15.249(d) Emissions radiated outside of the specified frequency bands, except for harmonics, shall be attenuated by at least 50 dB below the level of the fundamental or to the general radiated emission limits in §15.209, whichever is the lesser attenuation.

### 5.2 Test Procedure

The band edge compliance of RF radiated emission should be measured by following the guidance in ANSI C63.10 with respect to maximizing the emission by rotating the EUT, measuring the emission while the EUT is situated in three orthogonal planes (if appropriate), adjusting the measurement antenna height and polarization etc. Set RBW to 100KHz and VBW to 300KHz to measure the peak field strength and set RBW to 1MHz and VBW to 10Hz to measure the average radiated field strength. The conducted RF band edge was measured by using a spectrum analyzer. Set span wide enough to capture the highest in-band emission and the emission at the band edge. Set RBW to 100 KHz and VBW to 300 KHz, to measure the conducted peak band edge.

### 5.3 Test Result

#### **PASS**

Radiated Band Edge Test:  
Operation Mode: TX CH Low (2402MHz)  
Horizontal

Frequency (MHz)	Meter Reading (dBμV)	Factor (dB)	Emission Level (dBμV/m)	Limits (dBμV/m)	Margin (dB)	Detector Type
2390	53.63	-5.81	47.82	74	-26.18	peak
2390	/	-5.81	/	54	/	AVG
2400	56.28	-5.84	50.44	74	-23.56	peak
2400	/	-5.84	/	54	/	AVG

Remark: Factor = Antenna Factor + Cable Loss – Pre-amplifier.

Vertical:

Frequency (MHz)	Meter Reading (dBμV)	Factor (dB)	Emission Level (dBμV/m)	Limits (dBμV/m)	Margin (dB)	Detector Type
2390	51.83	-5.81	46.02	74	-27.98	peak
2390	/	-5.81	/	54	/	AVG
2400	56.49	-5.84	50.65	74	-23.35	peak
2400	/	-5.84	/	54	/	AVG

Remark: Factor = Antenna Factor + Cable Loss – Pre-amplifier.



Operation Mode: TX CH High (2480MHz)  
Horizontal

Frequency	Meter Reading	Factor	Emission Level	Limits	Margin	Detector Type
(MHz)	(dB $\mu$ V)	(dB)	(dB $\mu$ V/m)	(dB $\mu$ V/m)	(dB)	
2483.5	53.24	-5.65	47.59	74	-26.41	peak
2483.5	/	-5.65	/	54	/	AVG

Remark: Factor = Antenna Factor + Cable Loss – Pre-amplifier.

Vertical:

Frequency	Meter Reading	Factor	Emission Level	Limits	Margin	Detector Type
(MHz)	(dB $\mu$ V)	(dB)	(dB $\mu$ V/m)	(dB $\mu$ V/m)	(dB)	
2483.5	53.18	-5.65	47.53	74	-26.47	peak
2483.5	/	-5.65	/	54	/	AVG

Remark: Factor = Antenna Factor + Cable Loss – Pre-amplifier.

Remark: All the other emissions not reported were too low to read and deemed to comply with FCC limit.



## 6 OCCUPIED BANDWIDTH MEASUREMENT

### 6.1 Test Setup

Same as Radiated Emission Measurement

### 6.2 Test Procedure

1. The EUT was placed on a turn table which is 0.8m above ground plane.
2. Set EUT as normal operation.
3. Based on FCC Part15 C Section 15.249(a): RBW= 100KHz. VBW= 300 KHz, Span=3MHz.
4. The useful radiated emission from the EUT was detected by the spectrum analyser with peak detector.

### 6.3 Measurement Equipment Used

Same as Radiated Emission Measurement

### 6.4 Test Result

**PASS**

Frequency	20dB Bandwidth (KHz)	Result
2402 MHz	1215	<b>PASS</b>
2440 MHz	1215	<b>PASS</b>
2480 MHz	1225	<b>PASS</b>



CH: 2402MHz

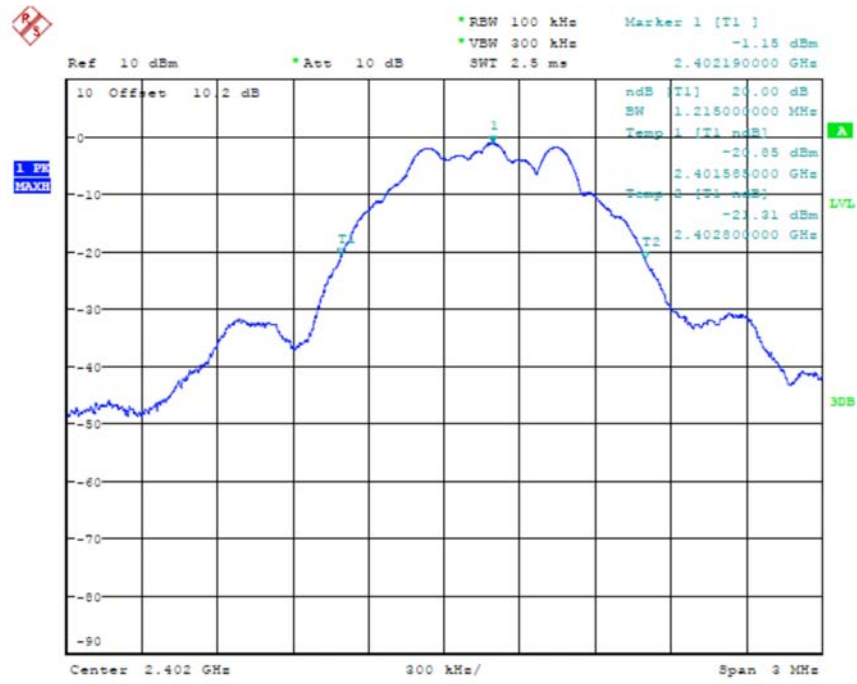



CH: 2440MHz

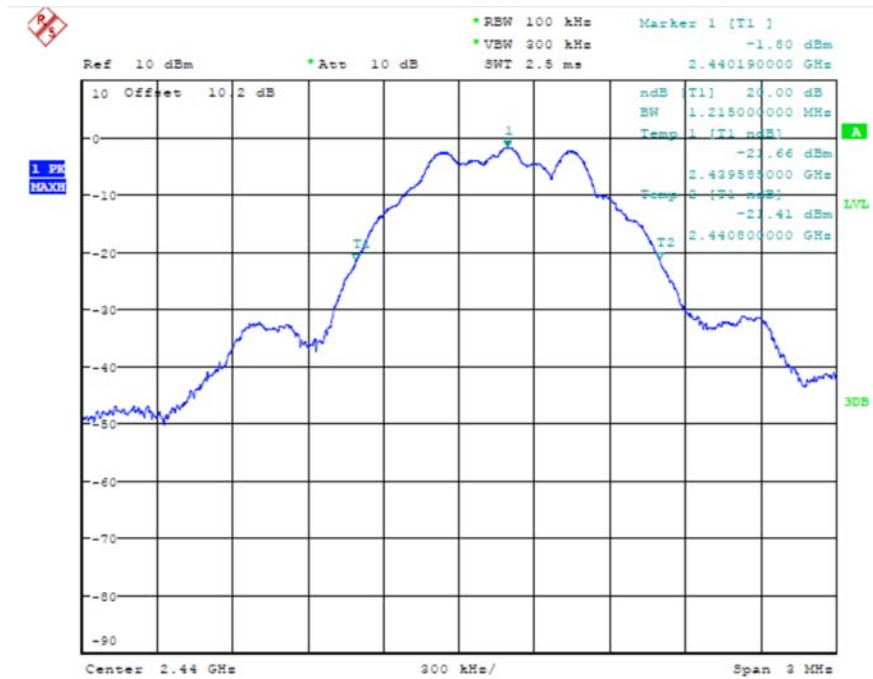

CH: 2480MHz

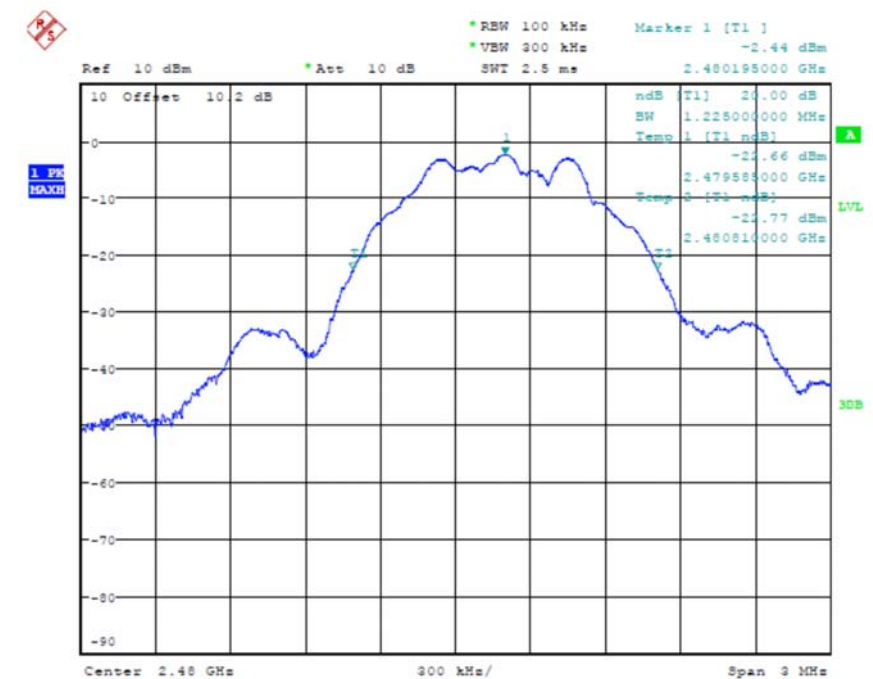

## 7 ANTENNA REQUIREMENT

### Standard Applicable

For intentional device, according to FCC 47 CFR Section 15.203, an intentional radiator shall be designed to ensure that no antenna other than that furnished by the responsible party shall be used with the device. And according to FCC 47 CFR Section 15.249, if transmitting antennas of directional gain greater than 6dBi are used, the power shall be reduced by the amount in dB that the directional gain of the antenna exceeds 6dBi.

### Refer to statement below for compliance.

The manufacturer may design the unit so that the user can replace a broken antenna, but the use of a standard antenna jack or electrical connector is prohibited. Further, this requirement does not apply to intentional radiators that must be professionally installed.

### Antenna Connected Construction

The antenna used in this product is a PCB Antenna for Bluetooth, The directional gains of antenna used for transmitting is 0dBi.

### Bluetooth ANTENNA

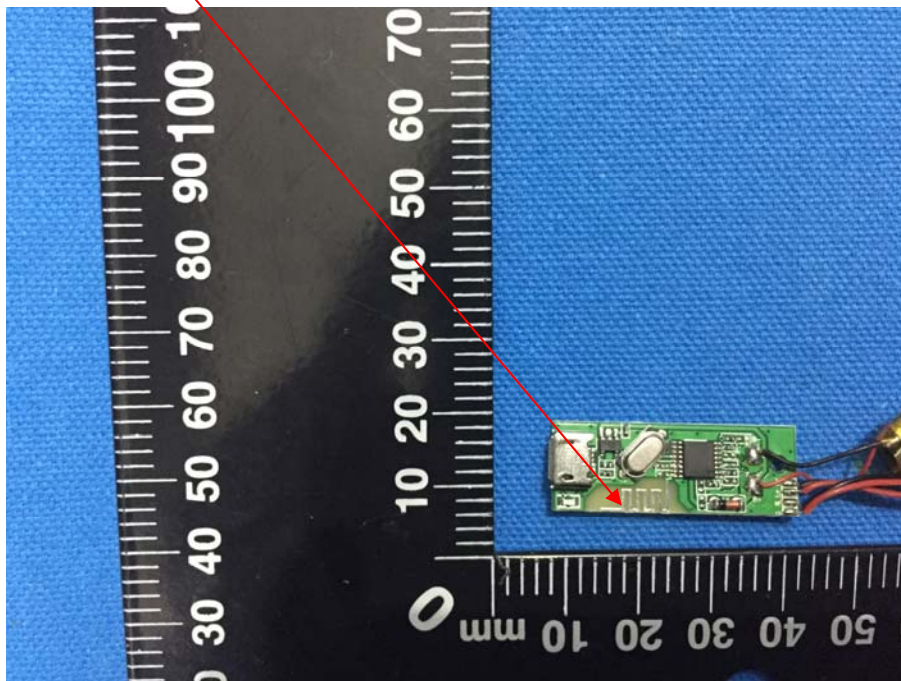

## 8 PHOTOGRAPH OF TEST

### 8.1 Radiated Emission





## 8.2 Conducted Emission

