

FCC Report (GSM&WCDMA)

Applicant: Shenzhen YLWD Technology Co.,Ltd
Address of Applicant: RM1002.A.Haisong BLD.RDTairan.FuTian District
Shenzhen,China
Manufacturer/Factory: Shenzhen YLWD Technology Co.,Ltd
Address of Manufacturer/Factory: RM1002.A.Haisong BLD.RDTairan.FuTian District
Shenzhen,China
Equipment Under Test (EUT)
Product Name: mobile phone
Model No.: E4001, E4002, E4003, E4004, E4005, E4501, E4502, E4503,
E4504, E4505, E5001, E5002, E5003, E5004, E5005, E5501,
E5502, E5503, E5504, E5505, E6001, E6002, E6003, E6004,
E6005
Trade mark: MOVIC
FCC ID: 2AKSAMOVIC-E
Applicable standards: FCC CFR Title 47 Part 2: 2017
FCC CFR Title 47 Part22 Subpart H: 2017
FCC CFR Title 47 Part24 Subpart E: 2017
Date of sample receipt: July 03, 2017
Date of Test: July 04-11, 2017
Date of report issued: July 12, 2017
Test Result : PASS *

* In the configuration tested, the EUT complied with the standards specified above.

Authorized Signature:



Robinson Lo

Laboratory Manager

This results shown in this test report refer only to the sample(s) tested, this test report cannot be reproduced, except in full, without prior written permission of the company. The report would be invalid without specific stamp of test institute and the signatures of compiler and approver.

1 Version

Version No.	Date	Description
00	July 12, 2017	Original

Prepared By:

Edward Pan

Date:

July 12, 2017

Project Engineer

Check By:

Andy Wu

Date:

July 12, 2017

Reviewer

2 Contents

	Page
1 VERSION	2
2 CONTENTS	3
3 TEST SUMMARY	4
4 GENERAL INFORMATION	5
4.1 GENERAL DESCRIPTION OF EUT	5
4.2 RELATED SUBMITTAL(S) / GRANT (S)	7
4.3 TEST METHODOLOGY.....	7
4.4 TEST FACILITY	7
4.5 TEST LOCATION.....	7
5 TEST INSTRUMENTS LIST	8
6 SYSTEM TEST CONFIGURATION	9
6.1 TEST MODE	9
6.2 CONFIGURATION OF TESTED SYSTEM	10
6.3 CONDUCTED PEAK OUTPUT POWER	11
6.4 PEAK-TO-AVERAGE RATIO	13
6.5 OCCUPY BANDWIDTH.....	15
6.6 MODULATION CHARACTERISTIC.....	25
6.7 OUT OF BAND EMISSION AT ANTENNA TERMINALS.....	25
6.8 ERP, EIRP MEASUREMENT	37
6.9 FIELD STRENGTH OF SPURIOUS RADIATION MEASUREMENT.....	47
6.10 FREQUENCY STABILITY V.S. TEMPERATURE MEASUREMENT.....	53
6.11 FREQUENCY STABILITY V.S. VOLTAGE MEASUREMENT.....	57
7 TEST SETUP PHOTO.....	61
8 EUT CONSTRUCTIONAL DETAILS	62

3 Test Summary

Test Item	Section in CFR 47	Result
RF Exposure (SAR)	Part 1.1307 Part 2.1093	Pass* (Please refer to SAR Report)
RF Output Power	Part 2.1046 Part 22.913 (a)(2) Part 24.232 (c)	Pass
Peak-to-Average Ratio	Part 2.1046 Part 24.232 (d)	Pass
Modulation Characteristics	Part 2.1047	Pass
99% & -26 dB Occupied Bandwidth	Part 2.1049 Part 22.917 Part 24.238	Pass
Spurious Emissions at Antenna Terminal	Part 2.1051 Part 22.917 (a) Part 24.238 (a)	Pass
Field Strength of Spurious Radiation	Part 2.1053 Part 22.917 (a) Part 24.238 (a)	Pass
Out of band emission, Band Edge	Part 22.917 (a) Part 24.238 (a)	Pass
Frequency stability vs. temperature	Part 2.1055(a)(1)(b)	Pass
Frequency stability vs. voltage	Part 2.1055(d)(1)(2)	Pass

Pass: The EUT complies with the essential requirements in the standard.

4 General Information

4.1 General Description of EUT

Product Name:	mobile phone
Model No.:	E4001, E4002, E4003, E4004, E4005, E4501, E4502, E4503, E4504, E4505, E5001, E5002, E5003, E5004, E5005, E5501, E5502, E5503, E5504, E5505, E6001, E6002, E6003, E6004, E6005
Test Model No.:	E4001
Support Networks:	GSM, GPRS, EGPRS, WCDMA
Support Bands:	GSM850, PCS1900, WCDMA Band V, WCDMA Band II
TX Frequency:	GSM850: 824.20MHz-848.80MHz PCS1900: 1850.20MHz-1909.80MHz WCDMA Band V: 826.40MHz -846.60MHz WCDMA Band II: 1852.40MHz -1907.60MHz
GPRS Class:	12
EGPRS Class	10
Modulation type:	GSM/GPRS: GMSK EGPRS: GMSK/8PSK WCDMA Band II/V: QPSK
Antenna type:	PIFA antenna
Antenna gain:	1.0dBi
Power supply:	Adapter Model No.: R400-A Input: AC 100-240V, 50/60Hz, 0.15A Output: DC 5.0V, 500mA or DC 3.7V 1400mAh Li-ion Battery

Operation Frequency List:

GSM 850		PCS1900		WCDMA Band V		WCDMA Band II	
Channel	Frequency (MHz)	Channel	Frequency (MHz)	Channel	Frequency (MHz)	Channel	Frequency (MHz)
128	824.20	512	1850.20	4132	826.40	9262	1852.40
129	824.40	513	1850.40	4133	826.60	9263	1852.60
· ∴	· ∴	· ∴	· ∴	· ∴	· ∴	· ∴	· ∴
189	836.40	660	1879.80	4181	836.20	9399	1879.80
190	836.60	661	1880.00	4182	836.40	9400	1880.00
191	836.80	662	1880.20	4183	836.60	9401	1880.20
· ∴	· ∴	· ∴	· ∴	· ∴	· ∴	· ∴	· ∴
250	848.60	809	1909.60	4232	846.40	9537	1907.40
251	848.80	810	1909.80	4233	846.60	9538	1907.60

Regards to the operating frequency range over 10 MHz, the Lowest frequency, the middle frequency, and the highest frequency of channel were selected to perform the test, and the selected channel see below:

Final test channel:

GSM 850		PCS1900		WCDMA Band V		WCDMA Band II	
Channel	Frequency (MHz)	Channel	Frequency (MHz)	Channel	Frequency (MHz)	Channel	Frequency (MHz)
128	824.20	512	1850.20	4132	826.40	9262	1852.40
190	836.60	661	1880.00	4183	836.60	9400	1880.00
251	848.80	810	1909.80	4233	846.60	9538	1907.60

4.2 Related Submittal(s) / Grant (s)

This submittal(s) (test report) is filing to comply with Section Part 22 subpart H and Part 24 subpart E of the FCC CFR 47 Rules.

4.3 Test Methodology

Both conducted and radiated testing were performed according to the procedures document on TIA/EIA 603 and FCC CFR 47.1046, 2.1047, 2.1049, 2.1051, 2.1053, 2.1055 and 2.1057

4.4 Test Facility

The test facility is recognized, certified, or accredited by the following organizations:

- **FCC —Registration No.: 600491**

Global United Technology Services Co., Ltd., Shenzhen EMC Laboratory has been registered and fully described in a report filed with the (FCC) Federal Communications Commission. The acceptance letter from the FCC is maintained in files. Registration 600491, June 22, 2016.

- **Industry Canada (IC) —Registration No.: 9079A-2**

The 3m Semi-anechoic chamber of Global United Technology Services Co., Ltd. has been registered by Certification and Engineering Bureau of Industry Canada for radio equipment testing with Registration No.: 9079A-2, August 15, 2016.

4.5 Test Location

All tests were performed at:

Global United Technology Services Co., Ltd.

Address: No. 301-309, 3/F., Jinyuan Business Building, No.2, Laodong Industrial Zone, Xixiang Road, Baoan District, Shenzhen, Guangdong, China 518102

Tel: 0755-27798480

Fax: 0755-27798960

5 Test Instruments list

Item	Test Equipment	Manufacturer	Model No.	Inventory No.	Cal.Date (mm-dd-yy)	Cal.Due date (mm-dd-yy)
1	3m Semi- Anechoic Chamber	ZhongYu Electron	9.2(L)*6.2(W)* 6.4(H)	GTS250	July. 03 2015	July. 02 2020
2	Control Room	ZhongYu Electron	6.2(L)*2.5(W)* 2.4(H)	GTS251	N/A	N/A
3	EMI Test Receiver	Rohde & Schwarz	ESU26	GTS203	June 29 2017	June 28 2018
4	BiConiLog Antenna	SCHWARZBECK MESS-ELEKTRONIK	VULB9163	GTS214	June 29 2017	June 28 2018
5	Double -ridged waveguide horn	SCHWARZBECK MESS-ELEKTRONIK	9120D-829	GTS208	June 29 2017	June 28 2018
6	Horn Antenna	ETS-LINDGREN	3160	GTS217	June 29 2017	June 28 2018
7	EMI Test Software	AUDIX	E3	N/A	N/A	N/A
8	Coaxial Cable	GTS	N/A	GTS213	June 29 2017	June 28 2018
9	Coaxial Cable	GTS	N/A	GTS211	June 29 2017	June 28 2018
10	Coaxial cable	GTS	N/A	GTS210	June 29 2017	June 28 2018
11	Coaxial Cable	GTS	N/A	GTS212	June 29 2017	June 28 2018
12	Amplifier(100kHz-3GHz)	HP	8347A	GTS204	June 29 2017	June 28 2018
13	Amplifier(2GHz-20GHz)	HP	8349B	GTS206	June 29 2017	June 28 2018
14	Amplifier (18-26GHz)	Rohde & Schwarz	AFS33-18002 650-30-8P-44	GTS218	June 29 2017	June 28 2018
15	Band filter	Amindeon	82346	GTS219	June 29 2017	June 28 2018
16	Universal radio communication tester	Rohde & Schwarz	CMU200	GTS235	June 29 2017	June 28 2018
17	Signal Generator	Rohde & Schwarz	SML03	GTS236	June 29 2017	June 28 2018
18	Temp. Humidity/ Barometer	Oregon Scientific	BA-888	GTS248	June 29 2017	June 28 2018
19	D.C. Power Supply	Instek	PS-3030	GTS232	NA	NA
20	Splitter	Agilent	11636B	GTS237	June 29 2017	June 28 2018
21	Power meter	Rohde & Schwarz	NRVS	GTS238	June 29 2017	June 28 2018
22	Spectrum Analyzer	Agilent	E4440A	GTS533	June 29 2017	June 28 2018
23	Temp.&Humidity chamber	Chuang wei	GDS-225	GTS005-1	June 29 2017	June 28 2018
24	Highpass filter	Micro-Tronics	HPM50108	GTS549	June 29 2017	June 28 2018
25	Highpass filter	Micro-Tronics	HPM50111	GTS550	June 29 2017	June 28 2018

6 System test configuration

6.1 Test mode

During all testing, EUT is in link mode with base station emulator at maximum power level. The spurious emission measurements were carried out in semi-anechoic chamber with 3-meter test range, and EUT is rotated on three test planes to find out the worst emission.

Test modes		
Band	Radiated	Conducted
GSM 850	<ul style="list-style-type: none"> ■ GSM link ■ GPRS 1 link ■ EPRS 1 link 	<ul style="list-style-type: none"> ■ GSM link ■ GPRS 1 link ■ EGPRS 1 link
PCS 1900	<ul style="list-style-type: none"> ■ GSM link ■ GPRS 1 link ■ EGPRS 1 link 	<ul style="list-style-type: none"> ■ GSM link ■ GPRS 1 link ■ EGPRS 1 link
WCDMA II	<ul style="list-style-type: none"> ■ RMC 12.2Kbps link 	<ul style="list-style-type: none"> ■ RMC 12.2Kbps link
WCDMA Band V	<ul style="list-style-type: none"> ■ RMC 12.2Kbps link 	<ul style="list-style-type: none"> ■ RMC 12.2Kbps link

Note: The maximum power levels are GSM mode for GMSK link, GPRS multi-slot class 8 mode for GMSK link, EGPRS multi-slot class 8 mode for 8PSK link, RMC12.2Kbps mode for WCDMA Band V/II. only these modes were used for all tests.

The conducted power tables are as follows:

Conducted Power (dBm)						
Band	GSM850			PCS1900		
Channel	128	190	251	512	661	810
Frequency	824.20	836.60	848.80	1850.20	1880.00	1909.80
GSM (GMSK, 1 TX slot)	32.46	32.58	32.51	28.78	28.67	28.65
GPRS (GMSK, 1 TX slot)	32.45	32.56	32.51	28.72	28.68	28.64
GPRS (GMSK, 2 TX slot)	31.51	31.52	31.46	27.62	27.59	27.56
GPRS (GMSK, 3 TX slot)	30.53	30.45	30.43	26.64	26.46	26.55
GPRS (GMSK, 4 TX slot)	29.45	29.38	29.56	25.65	25.58	25.43
EGPRS (8PSK, 1 TX slot)	27.59	27.65	27.52	25.68	25.65	25.47
EGPRS (8PSK, 2 TX slot)	26.55	26.57	26.53	24.57	24.54	24.35

Conducted Power (dBm)						
Band	WCDMA Band II			WCDMA Band V		
Channel	9262	9400	9538	4132	4183	4233
Frequency	1852.4	1880.0	1907.6	826.4	836.6	846.6
RMC 12.2Kbps	23.12	23.24	23.17	23.24	23.28	23.31
HSDPA Subtest-1	22.24	22.35	22.21	22.36	22.43	22.38
HSDPA Subtest-2	22.12	22.23	22.20	22.21	22.24	22.26
HSDPA Subtest-3	22.04	22.08	22.10	22.14	22.15	22.18
HSDPA Subtest-4	21.95	21.88	21.94	22.03	22.05	22.01
HSUPA Subtest-1	22.25	22.31	22.24	22.35	22.28	22.30
HSUPA Subtest-2	22.15	22.23	22.16	22.23	22.18	22.16
HSUPA Subtest-3	22.03	22.09	22.05	22.11	22.06	22.08
HSUPA Subtest-4	21.97	21.95	21.94	21.89	21.76	21.75
HSUPA Subtest-5	21.85	21.83	21.79	21.72	21.69	21.67
AMR	22.33	22.42	22.35	22.26	22.42	22.35

6.2 Configuration of Tested System

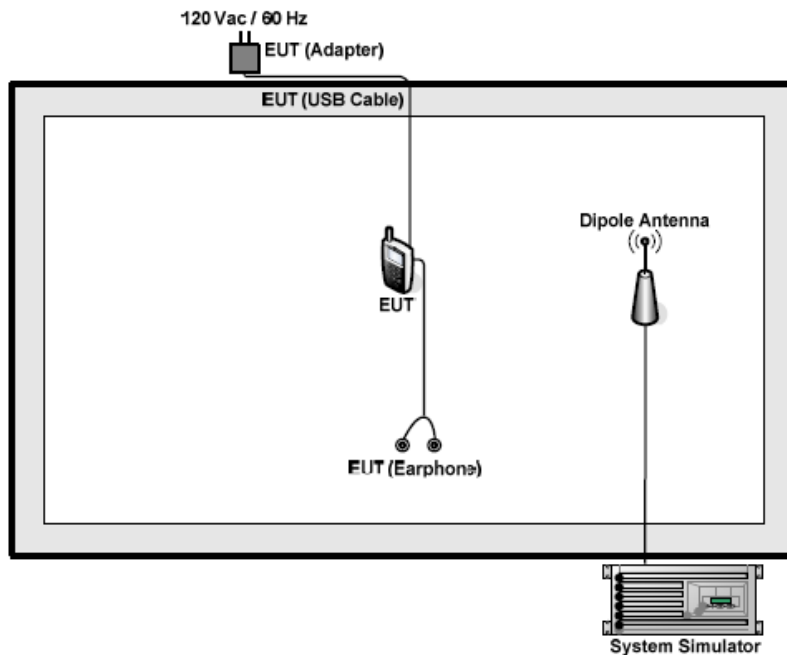

6.3 Conducted Peak Output Power

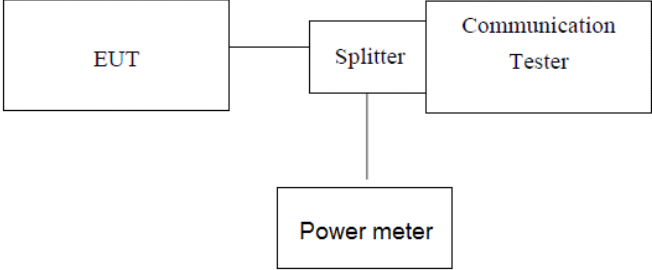
Test Requirement:	FCC part22.913(a) and FCC part24.232(b)
Test Method:	FCC part2.1046
Limit:	GSM850, WCDMA Band V: 7W PCS1900, WCDMA Band II: 2W
Test setup:	 <p style="text-align: center;"><i>Note: Measurement setup for testing on Antenna connector</i></p>
Test Procedure:	<ol style="list-style-type: none"> 1. The transmitter output port was connected to base station. 2. The RF output of EUT was connected to the power meter by RF cable and attenuator, the path loss was compensated to the results for each measurement. 3. Set EUT at maximum power through base station. 4. Select lowest, middle, and highest channels for each band and different modulation. 5. Measure the maximum burst average power.
Test Instruments:	Refer to section 6.0 for details
Test mode:	Refer to section 7.1 for details
Test results:	Pass

Measurement Data

EUT Mode	Channel	Frequency (MHz)	PK power (dBm)	Limit (dBm)	Result
GSM 850 (GSM link)	128	824.20	32.46	38.45	Pass
	190	836.60	32.58		
	251	848.80	32.51		
GSM 850 (GPRS 1 link)	128	824.20	32.45	38.45	Pass
	190	836.60	32.56		
	251	848.80	32.51		
GSM 850 (EGPRS 1 link)	128	824.20	27.59	38.45	Pass
	190	836.60	27.65		
	251	848.80	27.52		
PCS 1900 (GSM link)	512	1850.20	28.78	33.01	Pass
	661	1880.00	28.67		
	810	1909.80	28.65		
PCS 1900 (GPRS 1 link)	512	1850.20	28.72	33.01	Pass
	661	1880.00	28.68		
	810	1909.80	28.64		
PCS 1900 (EGPRS 1 link)	512	1850.20	25.68	33.01	Pass
	661	1880.00	25.65		
	810	1909.80	25.47		
WCDMA Band V (RMC 12.2Kbps link)	4132	826.40	23.24	38.45	Pass
	4183	836.60	23.28		
	4233	846.60	23.31		
WCDMA Band II (RMC 12.2Kbps link)	9262	1852.4	23.12	33.01	Pass
	9400	1880.0	23.24		
	9538	1907.6	23.17		

6.4 Peak-to-Average Ratio

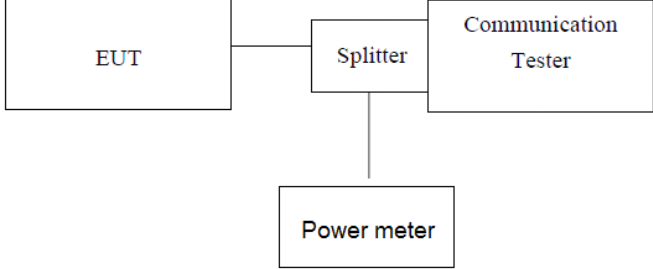
Test Requirement:	FCC part24.232(d)
Test Method:	FCC part2.1046
Limit:	13db
Test setup:	 <p><i>Note: Measurement setup for testing on Antenna connector</i></p>
Test Procedure:	<ol style="list-style-type: none"> 1. The transmitter output port was connected to base station. 2. The RF output of EUT was connected to the power meter by RF cable and attenuator, the path loss was compensated to the results for each measurement. 3. Set EUT at maximum power through base station. 4. Select lowest, middle, and highest channels for each band and different modulation. 5. Measure the maximum burst average power. 6. Record the maximum peak-to-average ratio value.
Test Instruments:	Refer to section 6.0 for details
Test mode:	Refer to section 7.1 for details
Test results:	Pass

Test mode	Peak to Average Ratio (dB)			Limit (dB)	Result
	Low Ch.	Middle Ch.	High Ch.		
WCDMA	5.06	4.91	4.87	13	PASS
GSM	0.73	0.81	0.89	13	PASS
EDGE	0.58	0.54	0.64	13	PASS

6.5 Occupancy Bandwidth

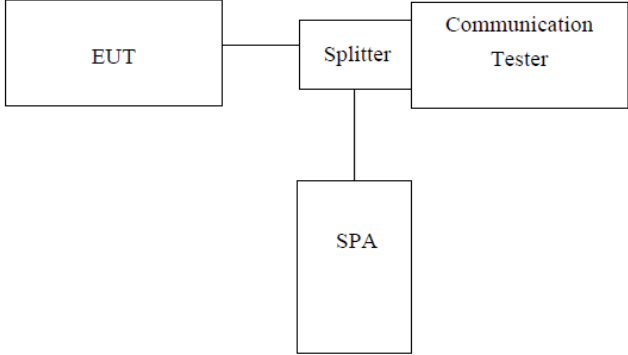
Test Requirement:	FCC part22.913(a) and FCC part24.232(b)
Test Method:	FCC part2.1049
Test setup:	 <p style="text-align: center;"><i>Note: Measurement setup for testing on Antenna connector</i></p>
Test Procedure:	<ol style="list-style-type: none"> 1. The EUT's output RF connector was connected with a short cable to the spectrum analyzer 2. RBW was set to about 1% of emission BW, VBW= 3 times RBW. 3. -26dBc display line was placed on the screen (or 99% bandwidth), the occupied bandwidth is the delta frequency between the two points where the display line intersects the signal trace.
Test Instruments:	Refer to section 6.0 for details
Test mode:	Refer to section 7.1 for details
Test results:	Pass

Measurement Data

EUT Mode	Channel	Frequency (MHz)	99% Occupy bandwidth (KHz)	-26dB bandwidth (KHz)
GSM 850 (GSM link)	128	824.20	243.930	309.634
	190	836.60	241.944	314.092
	251	848.80	243.890	315.698
GSM 850 (GPRS 1 link)	128	824.20	248.911	314.895
	190	836.60	245.740	319.971
	251	848.80	248.901	322.164
GSM 850 (EGPRS 1 link)	128	824.20	244.525	319.412
	190	836.60	244.932	321.198
	251	848.80	245.690	322.337
PCS 1900 (GSM link)	512	1850.20	242.328	311.128
	661	1880.00	244.390	312.062
	810	1909.80	249.769	313.984
PCS 1900 (GPRS 1 link)	512	1850.20	246.210	321.210
	661	1880.00	243.567	315.821
	810	1909.80	243.663	311.303
PCS 1900 (EGPRS 1 link)	512	1850.20	247.308	321.750
	661	1880.00	247.936	320.962
	810	1909.80	247.303	316.544
WCDMA Band V (RMC 12.2Kbps link)	4132	826.40	4153.10	4679.00
	4183	836.60	4164.20	4665.00
	4233	846.60	4141.60	4687.00
WCDMA Band II (RMC 12.2Kbps link)	9262	1852.4	4147.50	4701.00
	9400	1880.0	4154.50	4730.00
	9538	1907.6	4152.10	4725.00

Test plot as follows:

Test band: GSM 850 (GSM link)

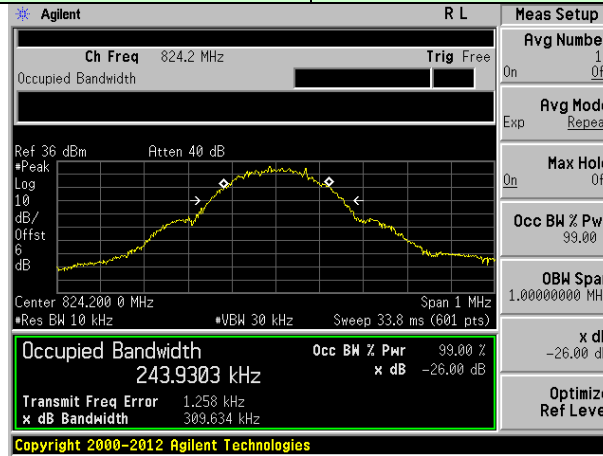

Lowest channel

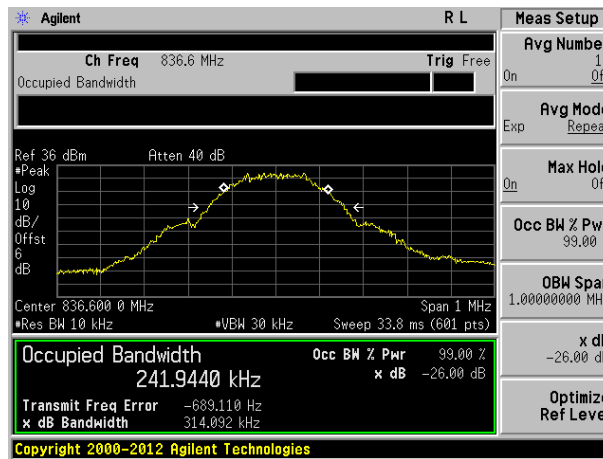

Middle channel

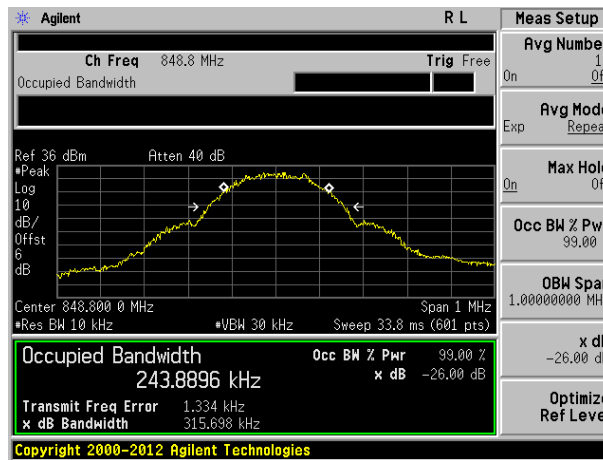

Highest channel

Test band: GSM 850 (GPRS 1 link)

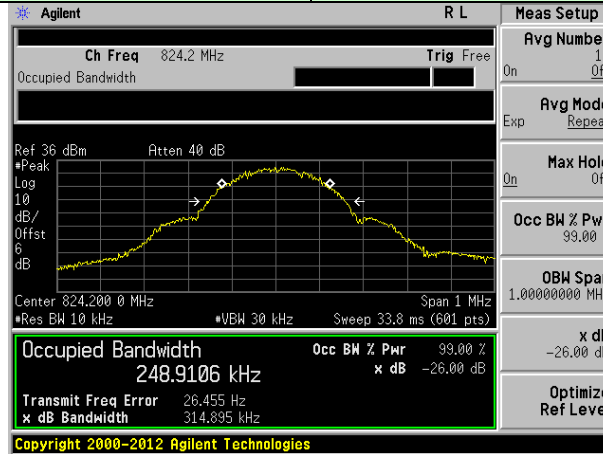

Lowest channel

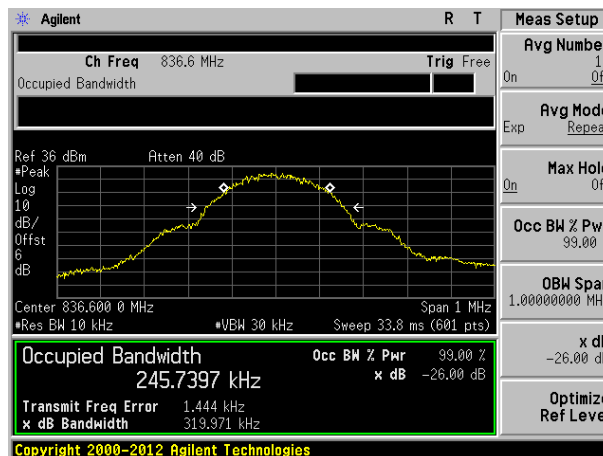

Middle channel

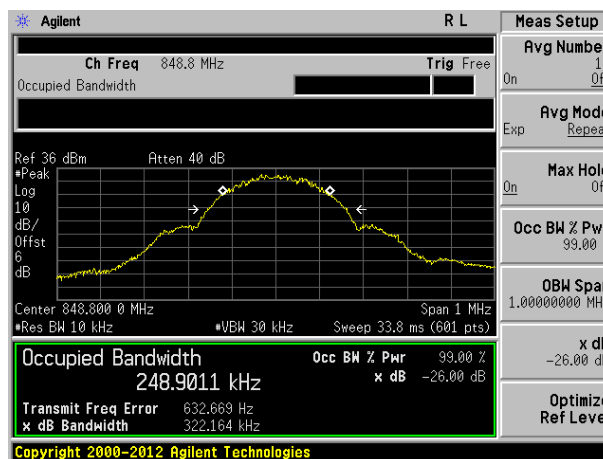

Highest channel

Test band: GSM 850 (EGPRS 1 link)

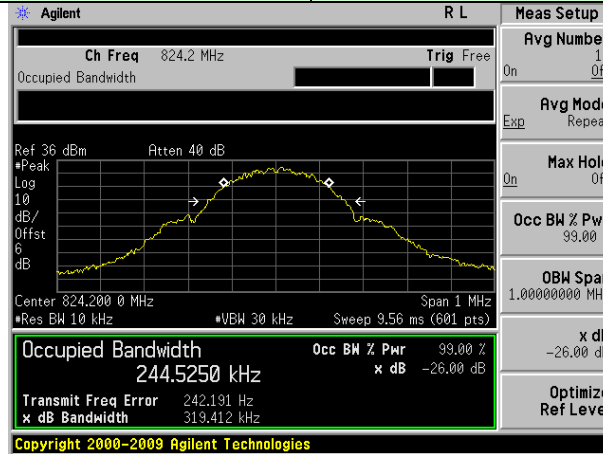

Lowest channel

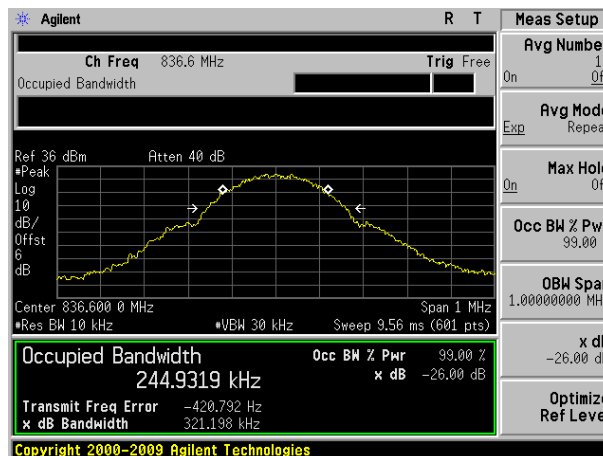

Middle channel

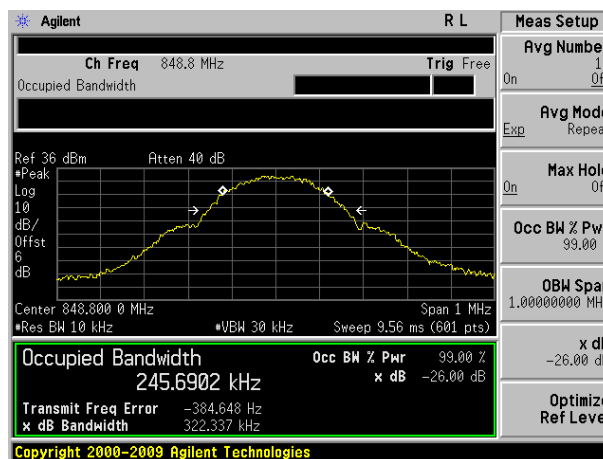

Highest channel

Test band: PCS 1900 (GSM link)

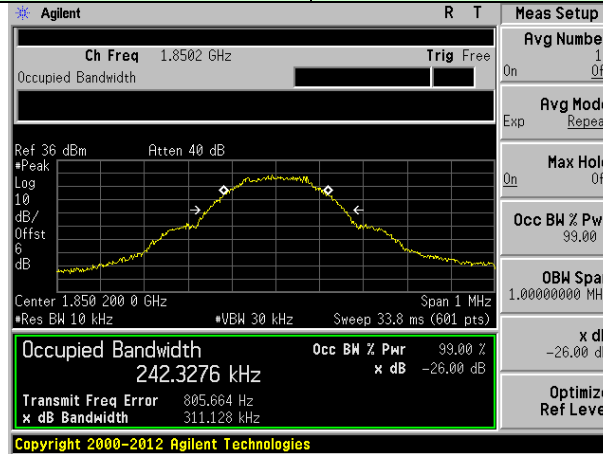

Lowest channel

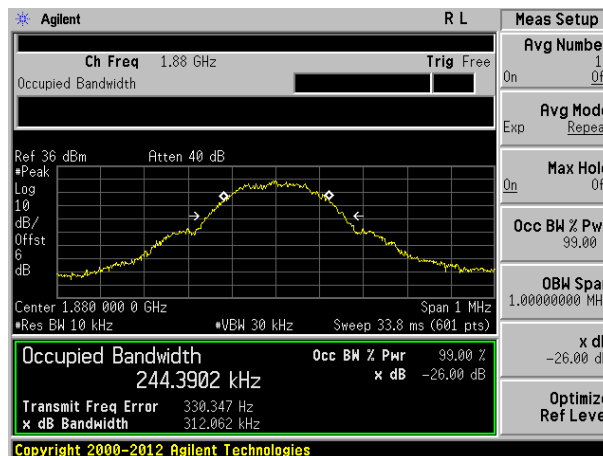

Middle channel

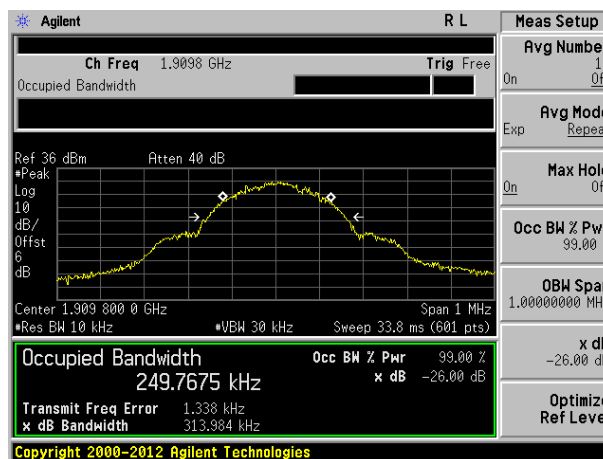

Highest channel

Test band: PCS 1900 (GPRS 1 link)

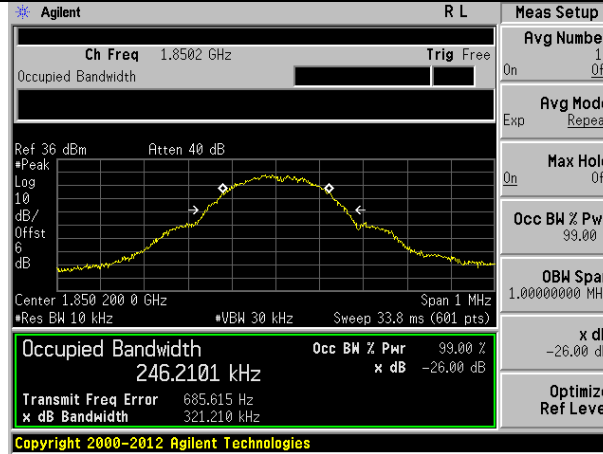

Lowest channel

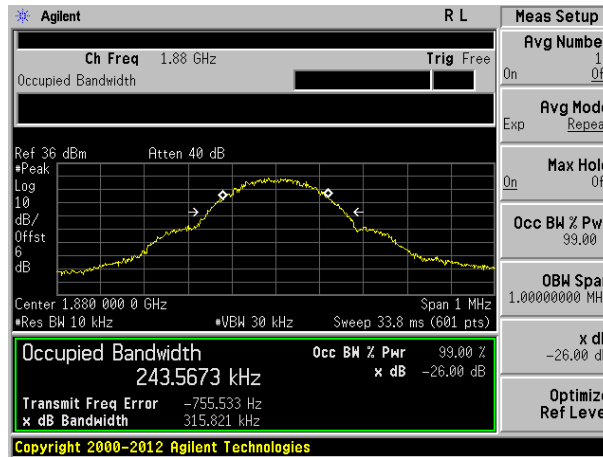

Middle channel

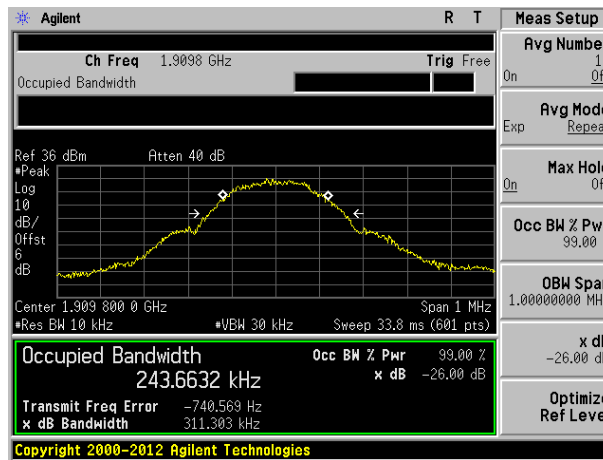

Highest channel

Test band: PCS 1900 (EGPRS 1 link)

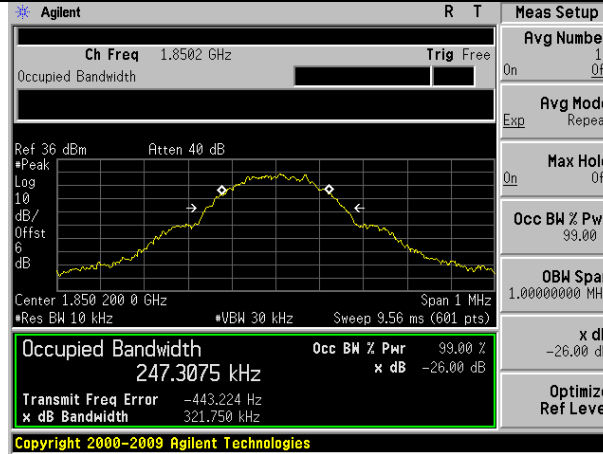

Lowest channel

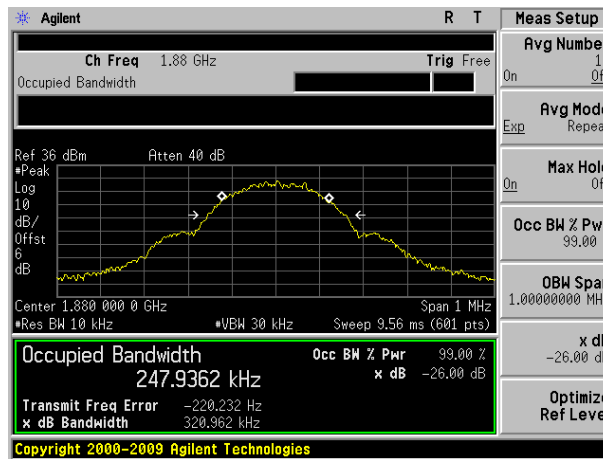

Middle channel

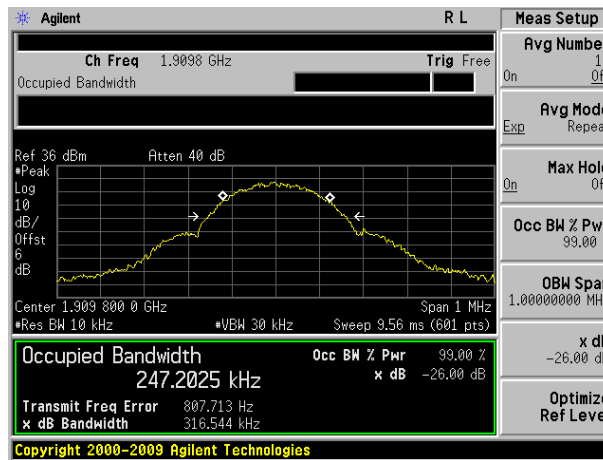

Highest channel

Test band:	WCDMA Band V (RMC 12.2Kbps link)
------------	----------------------------------

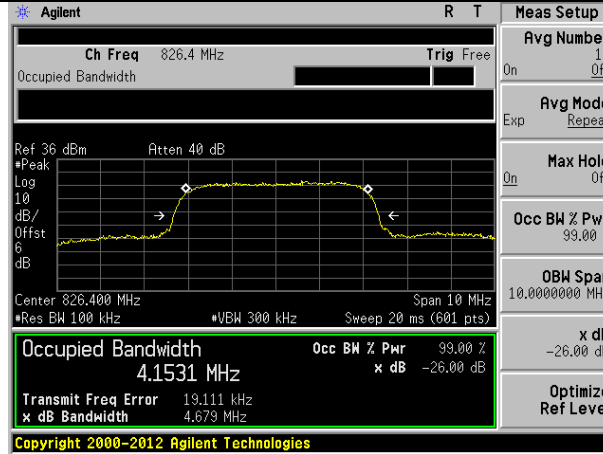

Lowest channel

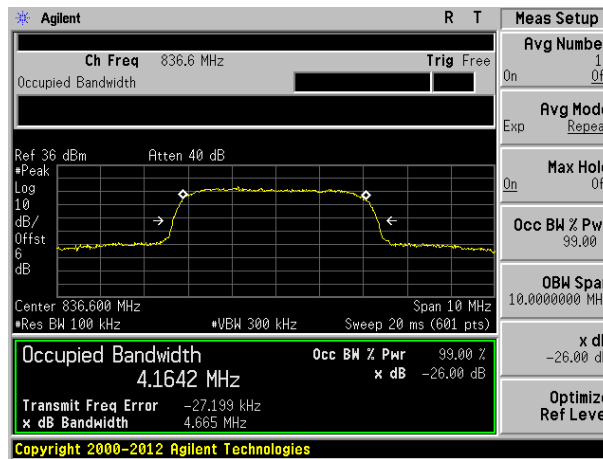

Middle channel

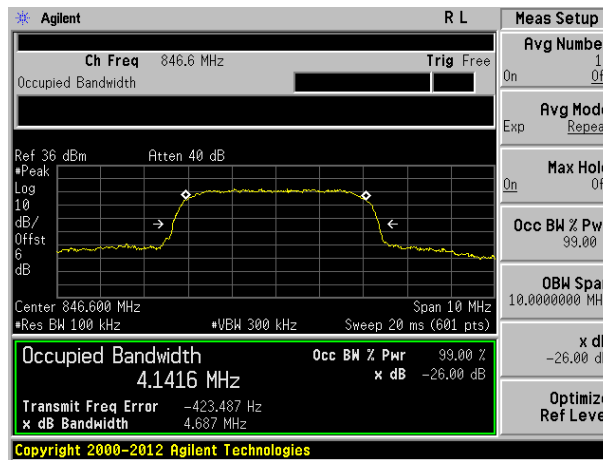

Highest channel

Test band: WCDMA Band II (RMC 12.2Kbps link)

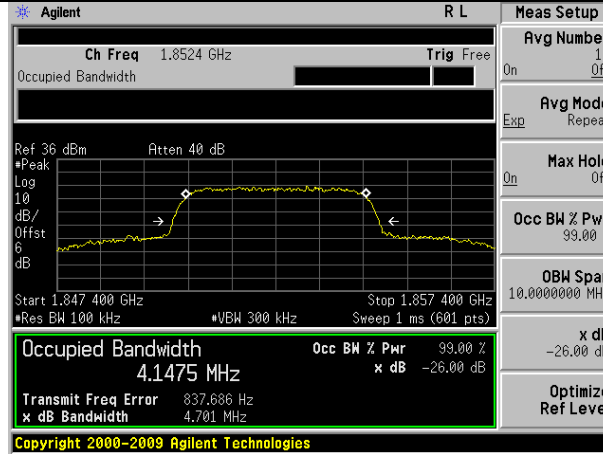

Lowest channel

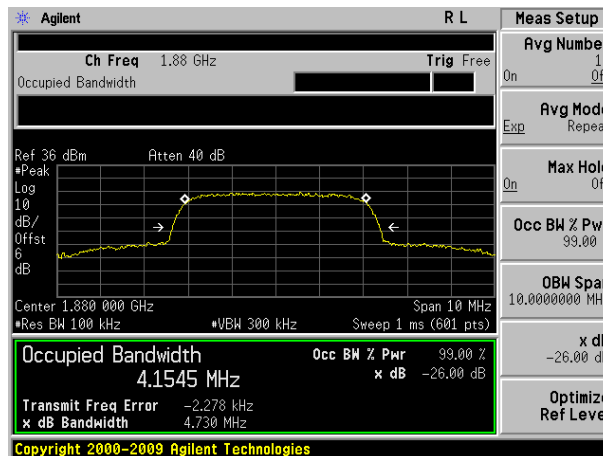

Middle channel

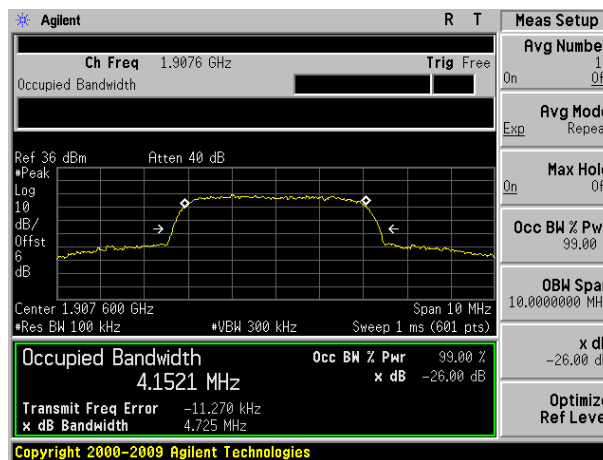

Highest channel

6.6 MODULATION CHARACTERISTIC

According to FCC § 2.1047(d), Part 22H & 24E there is no specific requirement for digital modulation, therefore modulation characteristic is not presented.

6.7 Out of band emission at antenna terminals

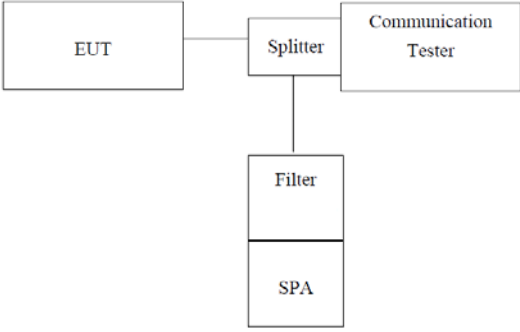
Test Requirement:	FCC part22.917(a) and FCC part24.238(a)
Test Method:	FCC part2.1051
Limit:	-13dBm
Test setup:	 <p><i>Note: Measurement setup for testing on Antenna connector</i></p>
Test Procedure:	<ol style="list-style-type: none"> 1 The RF output of the transceiver was connected to a spectrum analyzer through appropriate attenuation. 2 The resolution bandwidth of the spectrum analyzer was set at 1MHz, sufficient scans were taken to show the out of band Emissions if any up to 10th harmonic. 3 For the out of band: Set the RBW, VBW = 1MHz, Start=30MHz, Stop= 10th harmonic. 4 Band Edge Requirements: In the 1 MHz bands immediately outside and adjacent to the frequency block, a resolution bandwidth of at least 1 percent of the emission bandwidth of the fundamental emission of the transmitter may be employed to measure the out of band Emissions.
Test Instruments:	Refer to section 6.0 for details
Test mode:	Refer to section 7.1 for details
Test results:	Pass

Test plot as follows:

Note: During the conducted spurious emission test, a band filter was used. The information of the filter is reported at section 6.0 (refer to item 24, 25).

Test Mode: Traffic mode GSM 850 (GSM link)

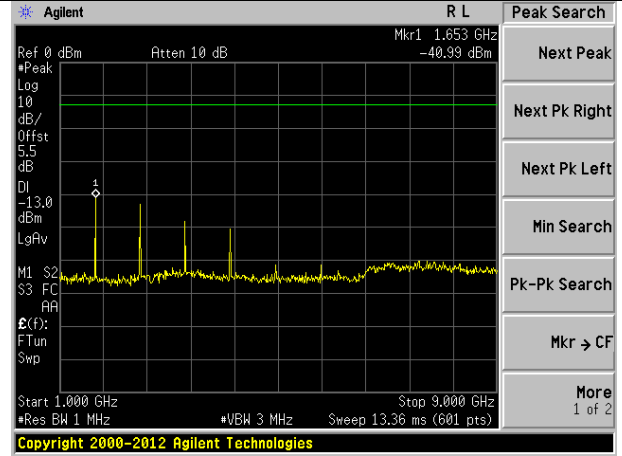
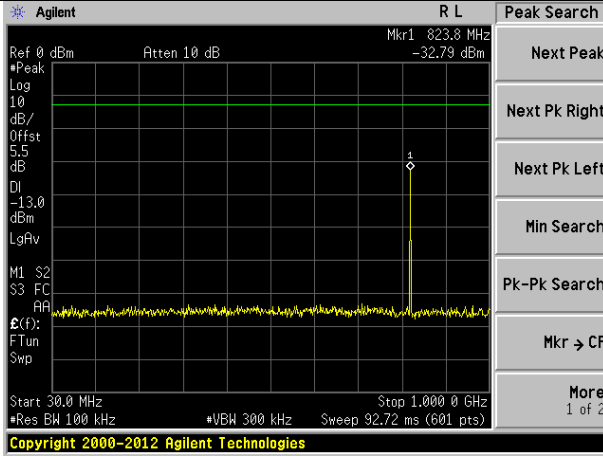

Lowest channel

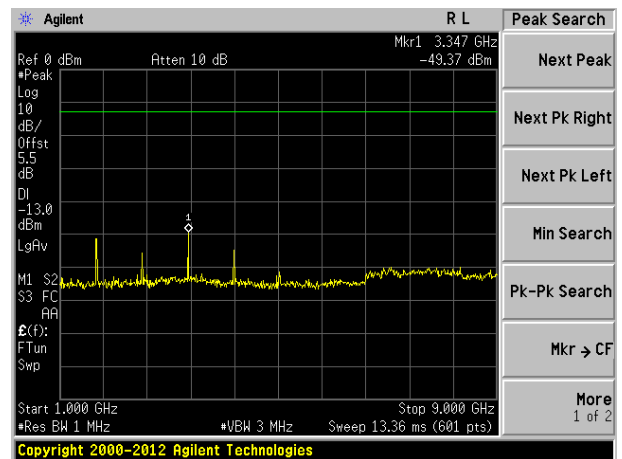
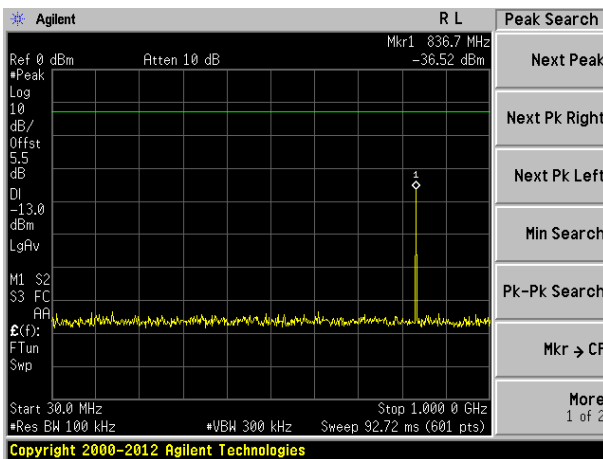

Middle channel

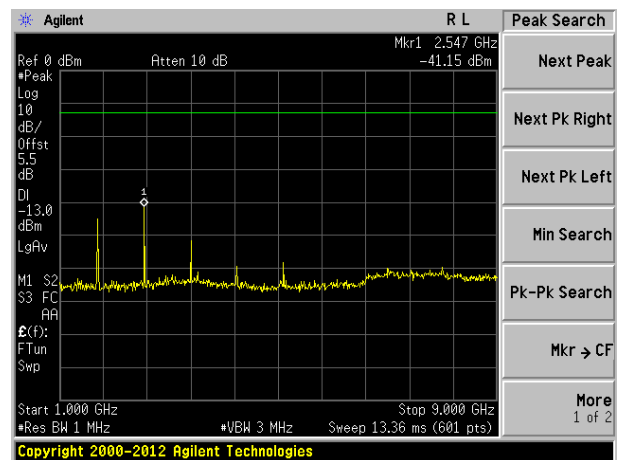
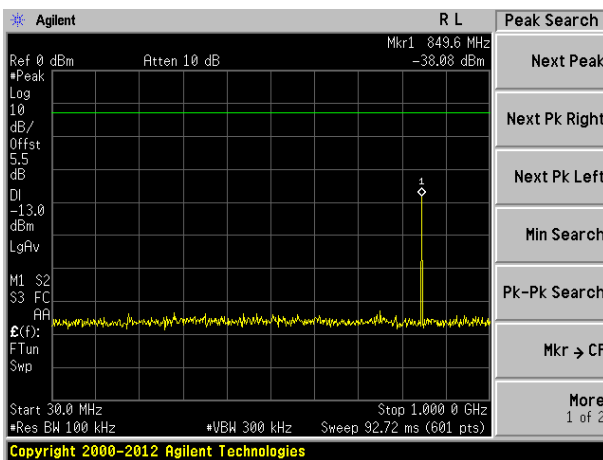

Highest channel

Test Mode: Traffic mode GSM 850 (GPRS 1 link)

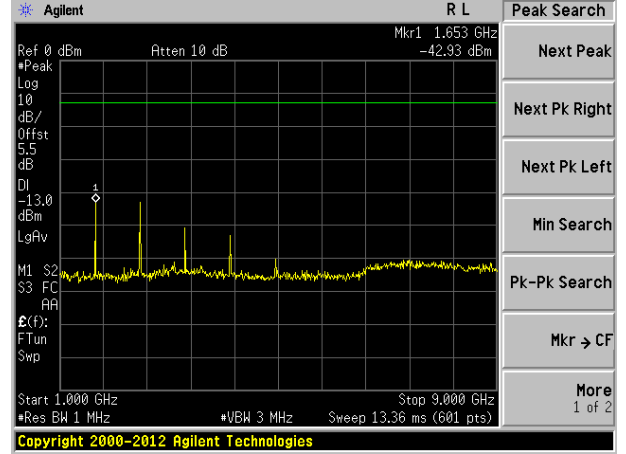
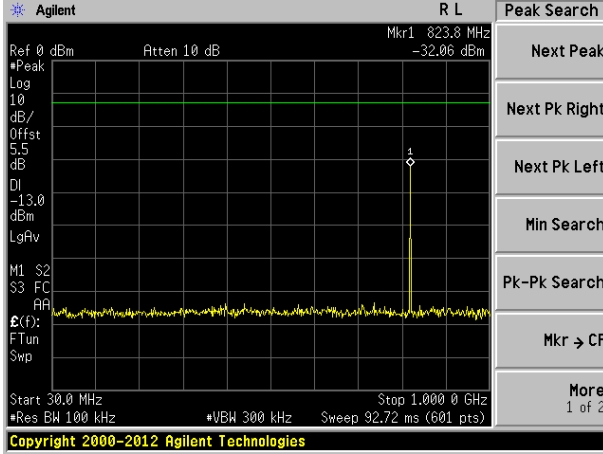

Lowest channel

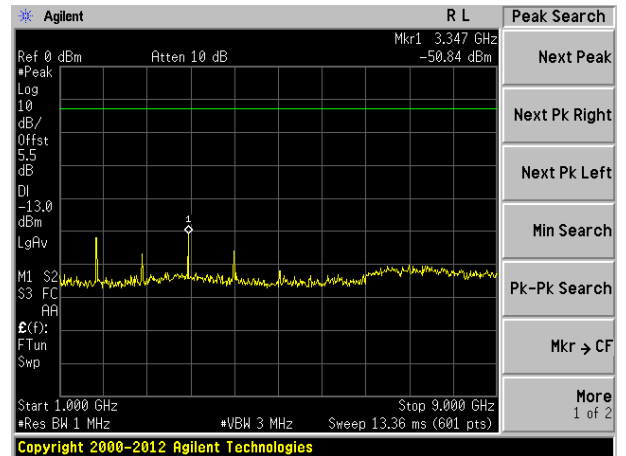
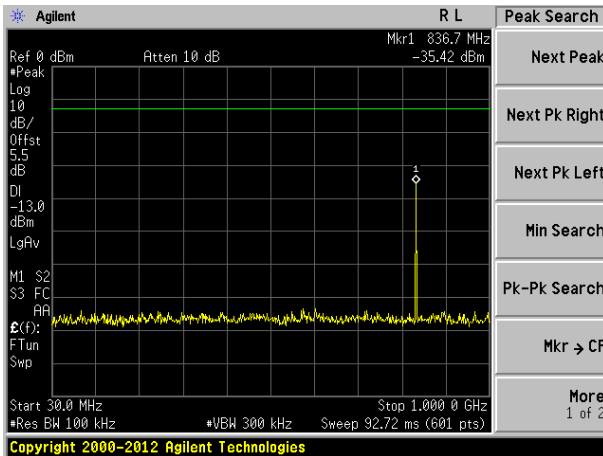

Middle channel

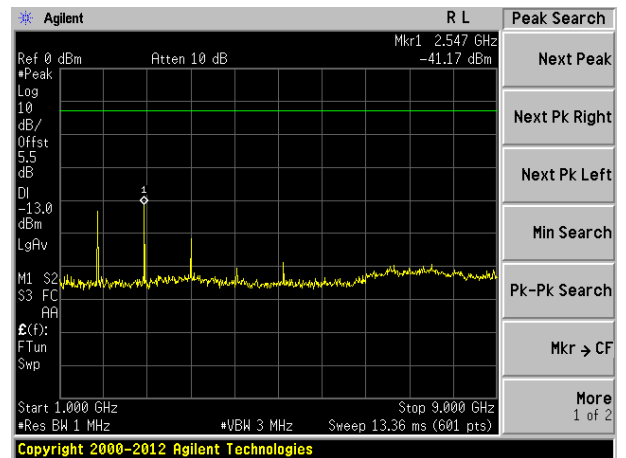
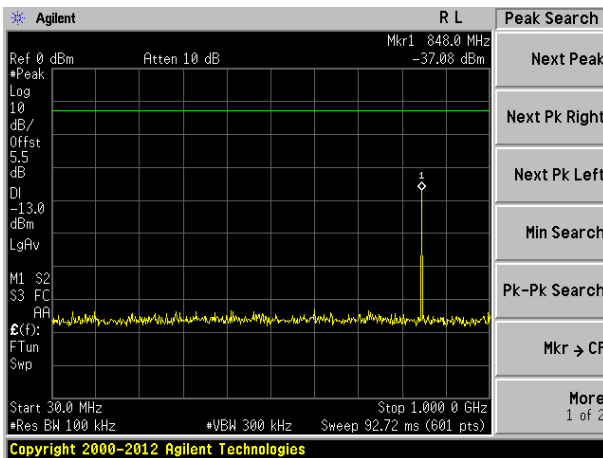

Highest channel

Test Mode: Traffic mode GSM 850 (EGPRS 1 link)

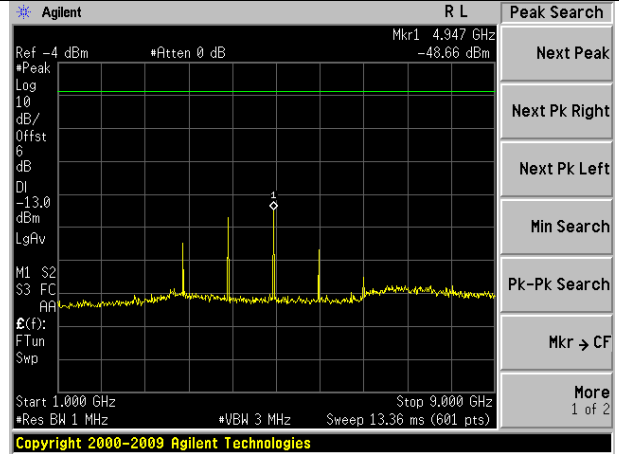
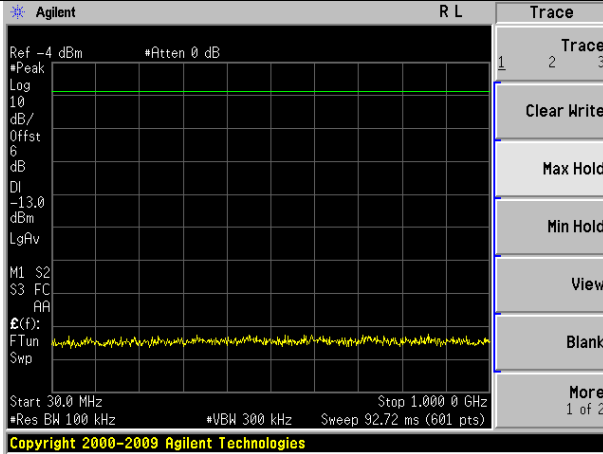

Lowest channel

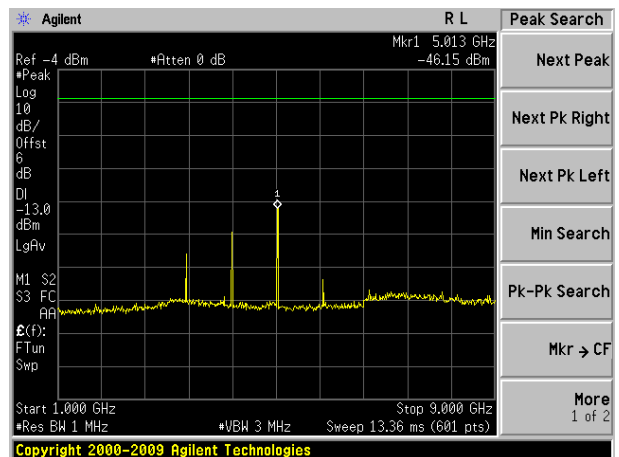
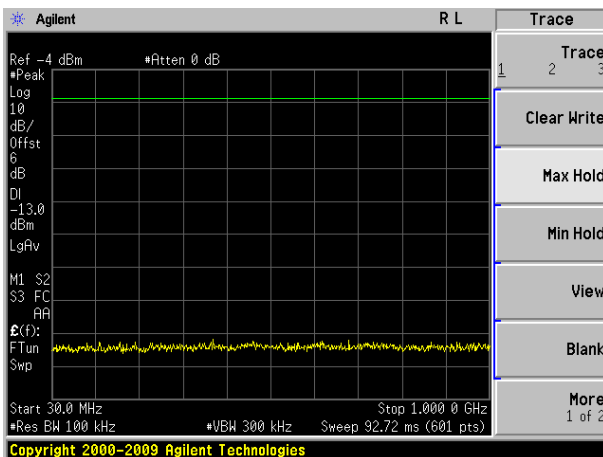

Middle channel

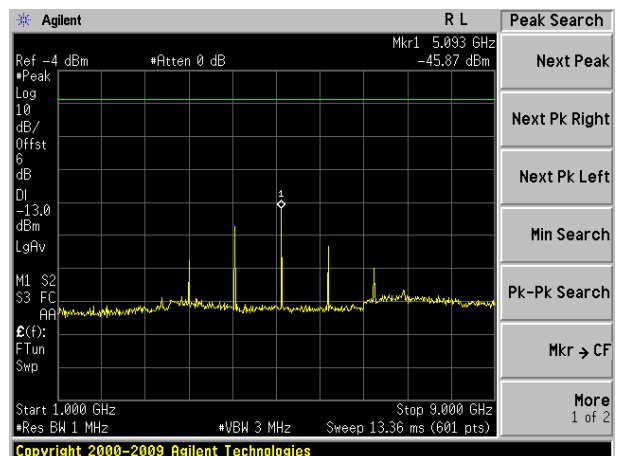
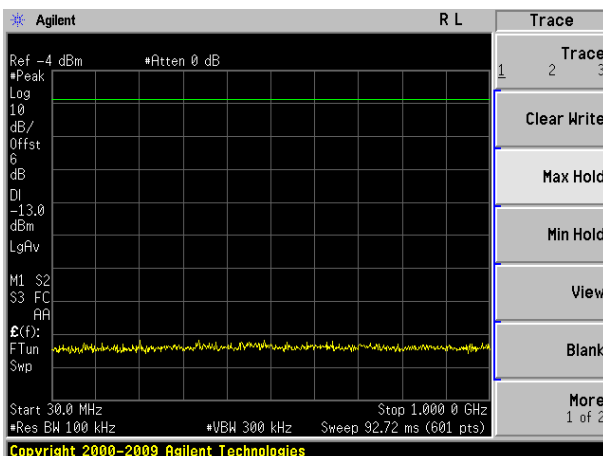

Highest channel

Test Mode: Traffic mode PCS1900 (GSM link)

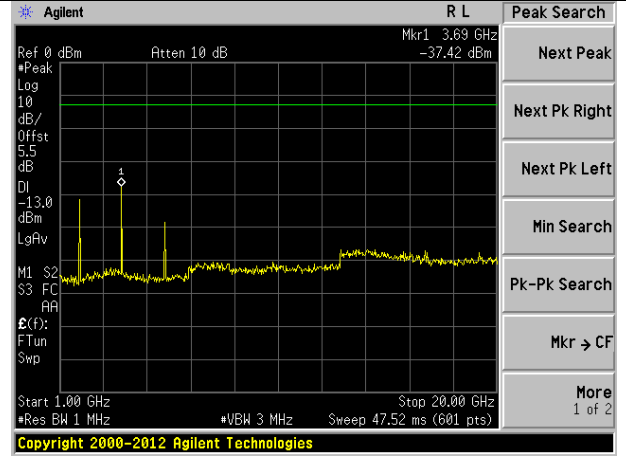
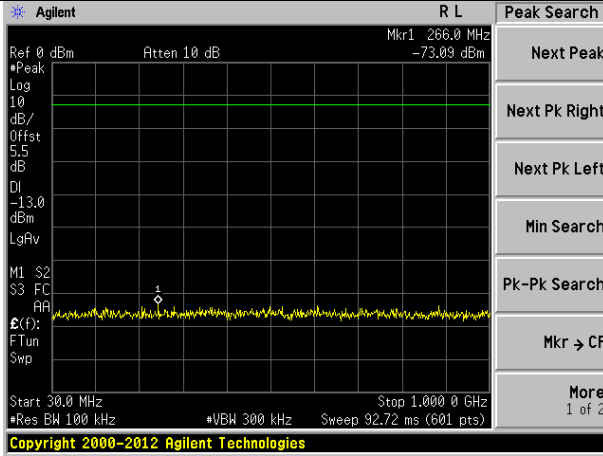

Lowest channel

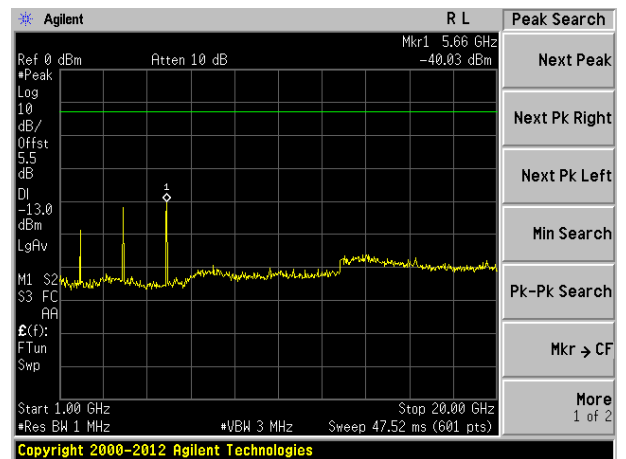
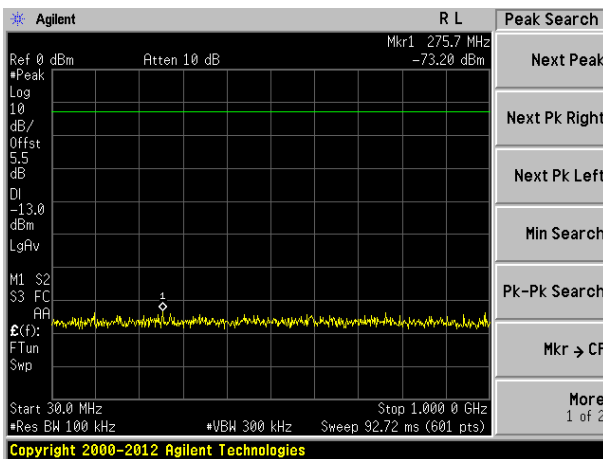

Middle channel

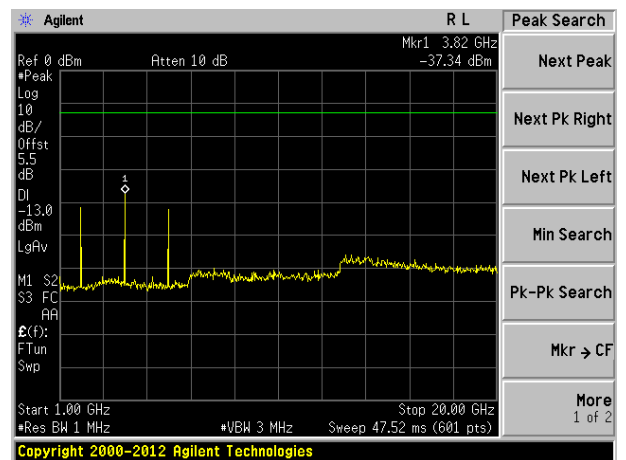
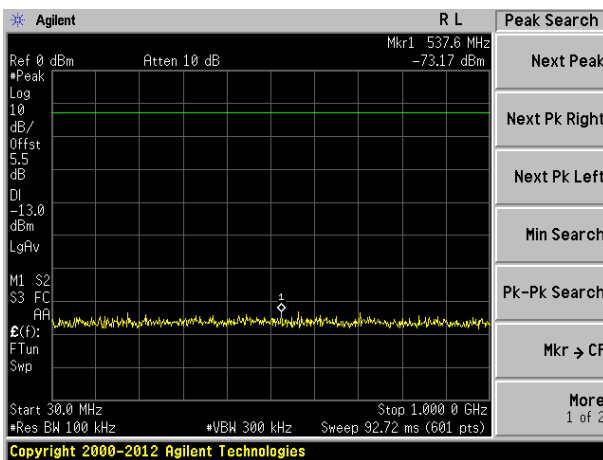

Highest channel

Test Mode: Traffic mode PCS1900 (GPRS 1 link)

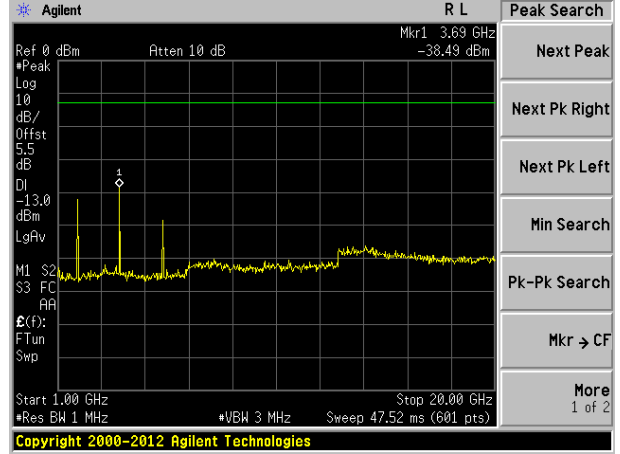
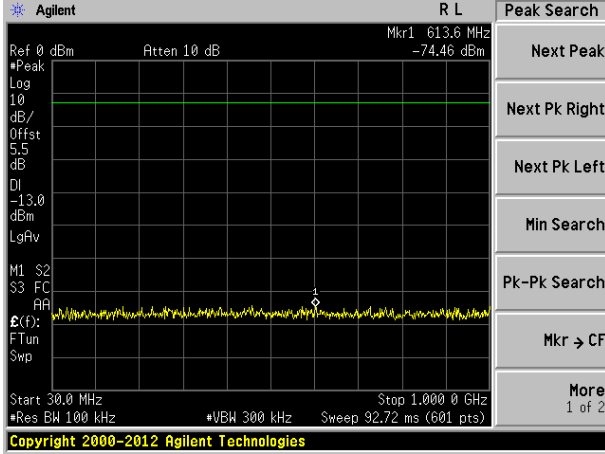

Lowest channel

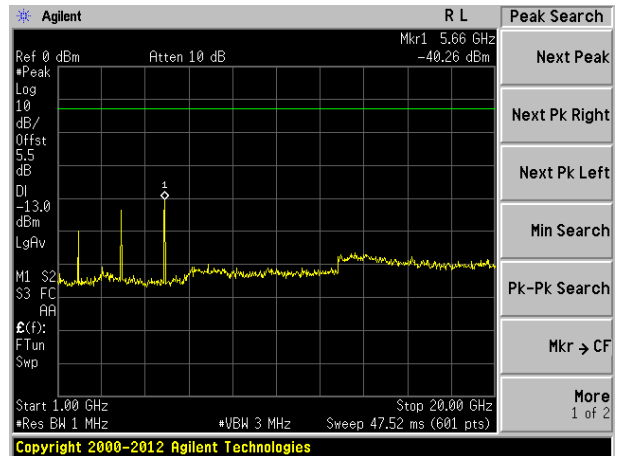
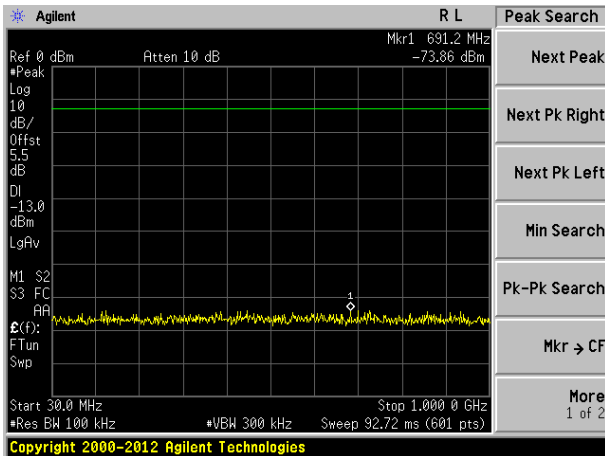

Middle channel

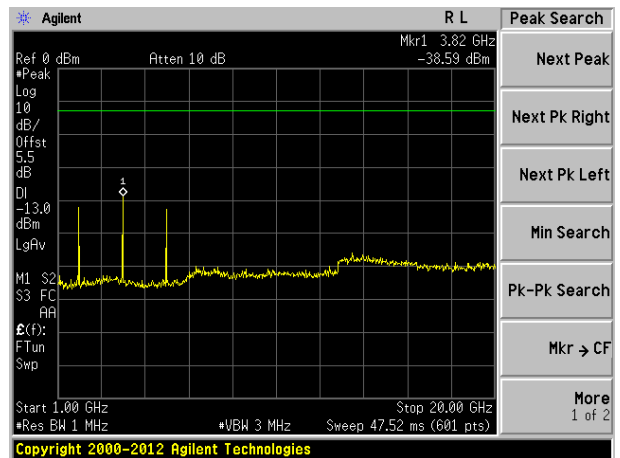
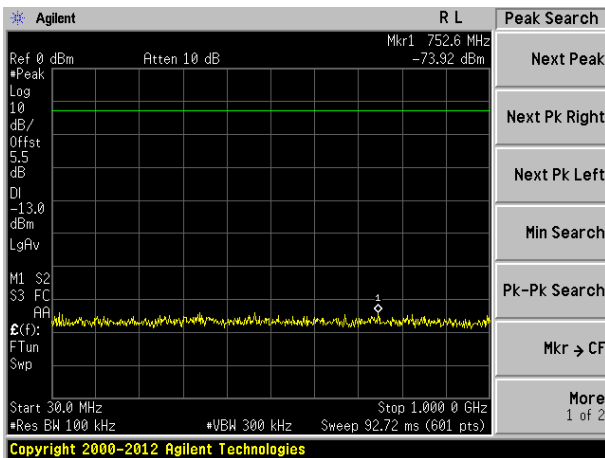

Highest channel

Test Mode: Traffic mode PCS1900 (EGPRS 1 link)

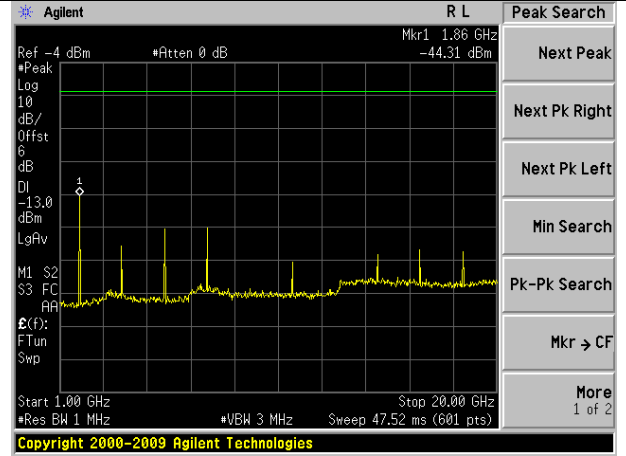
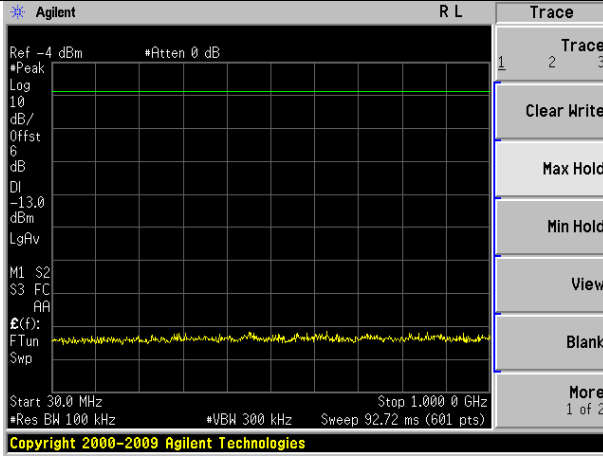

Lowest channel

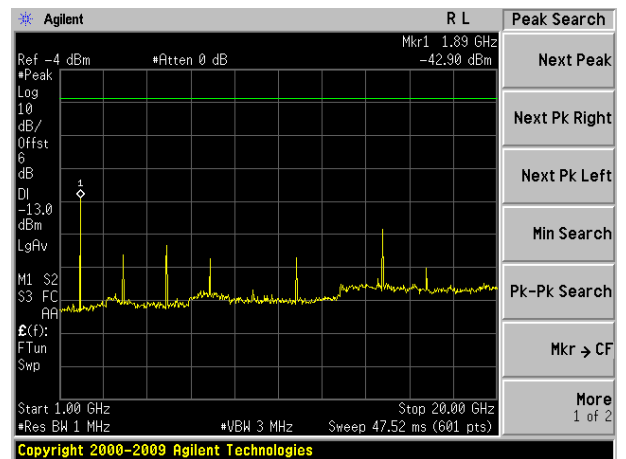
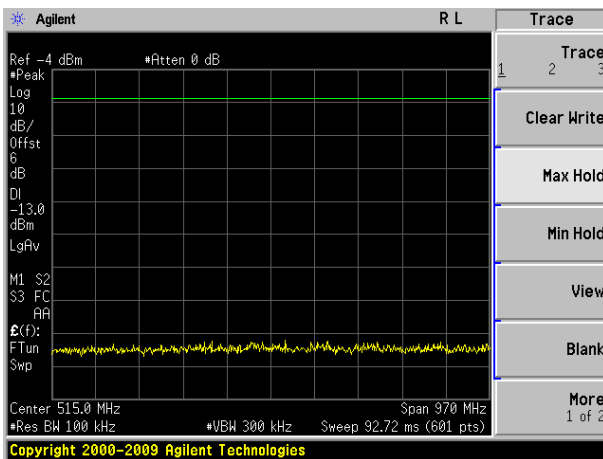

Middle channel

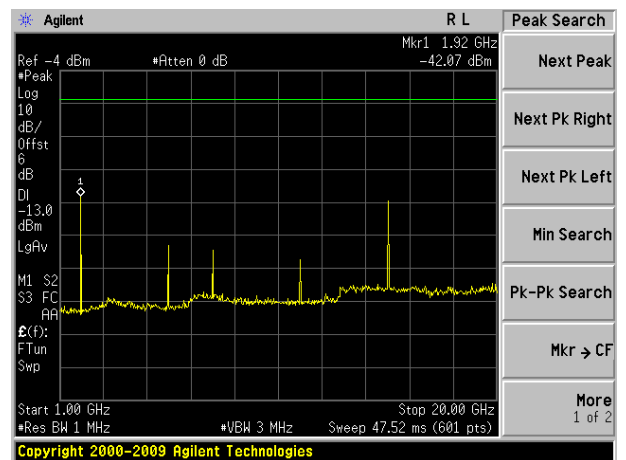
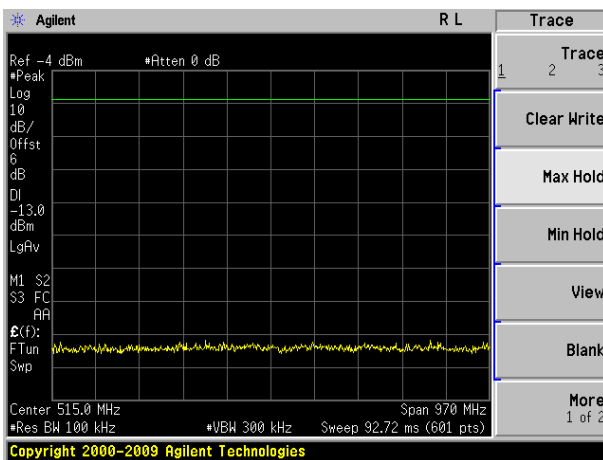

Highest channel

Test Mode: Traffic mode WCDMA Band V (RMC 12.2Kbps link)

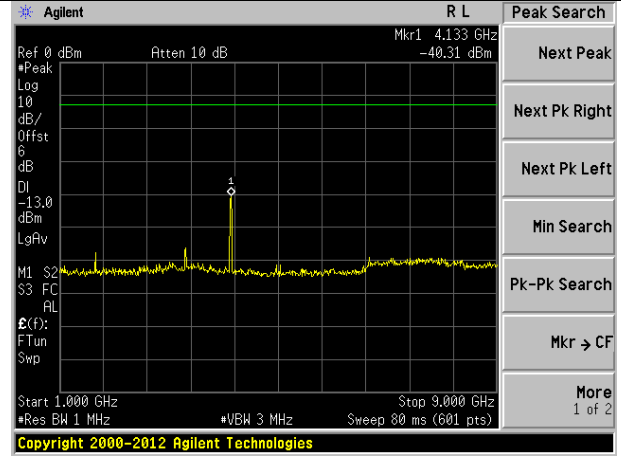
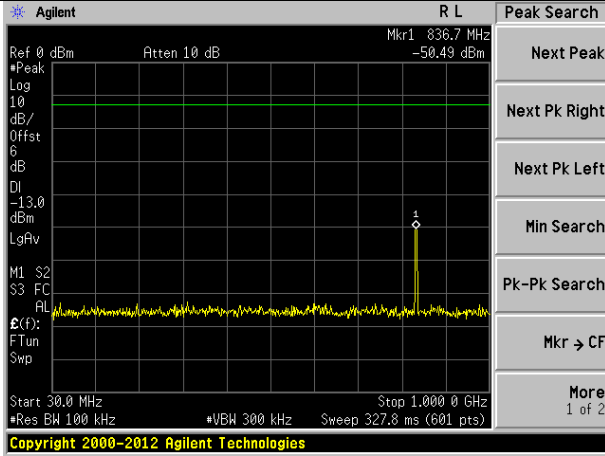

Lowest channel

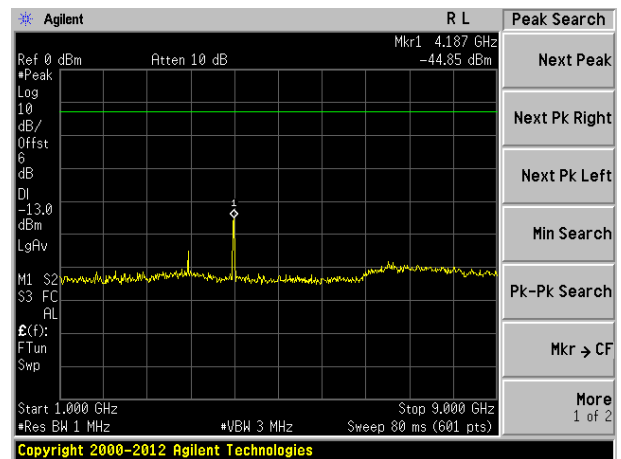
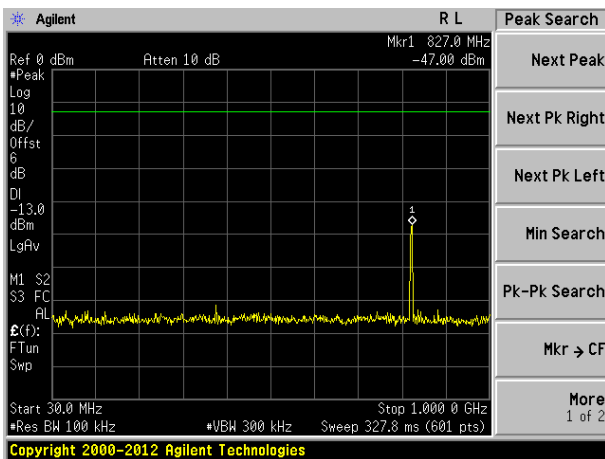

Middle channel

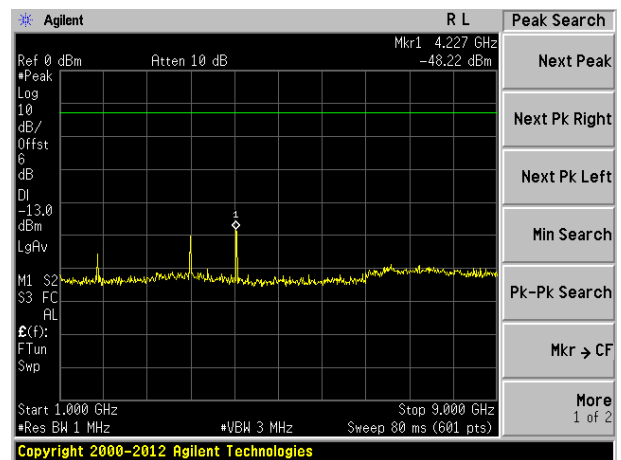
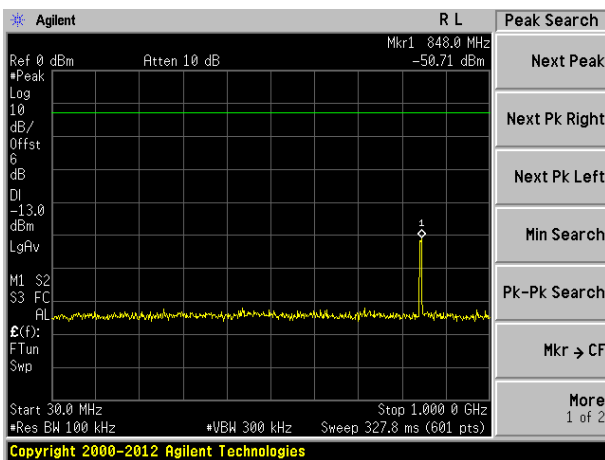

Highest channel

Test Mode: Traffic mode WCDMA Band II (RMC 12.2Kbps link)

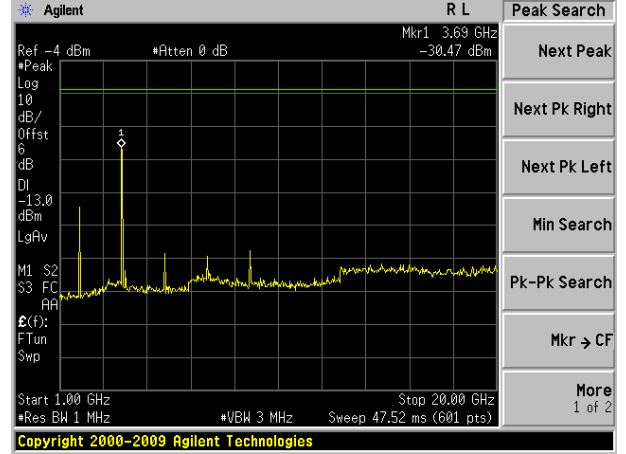
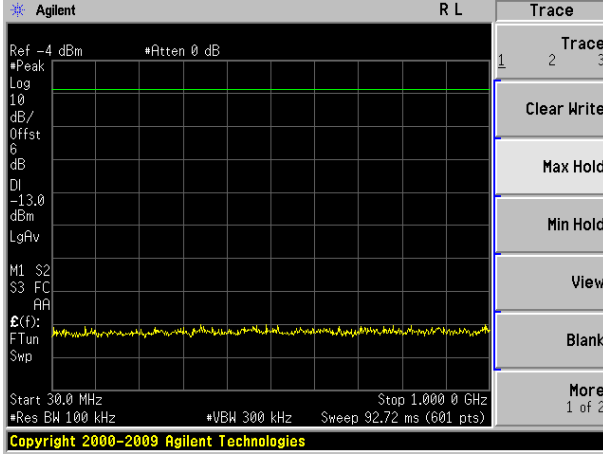

Lowest channel

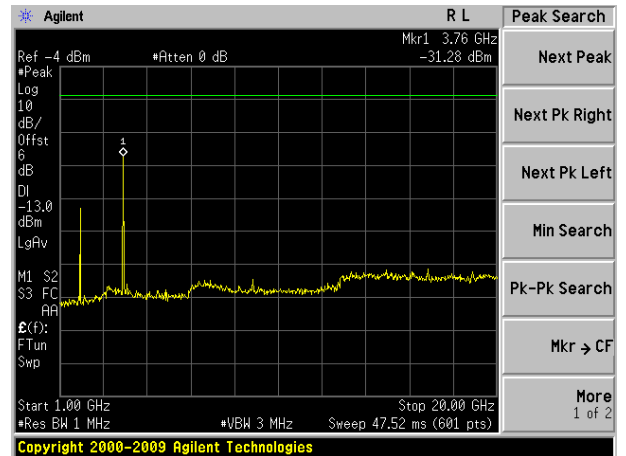
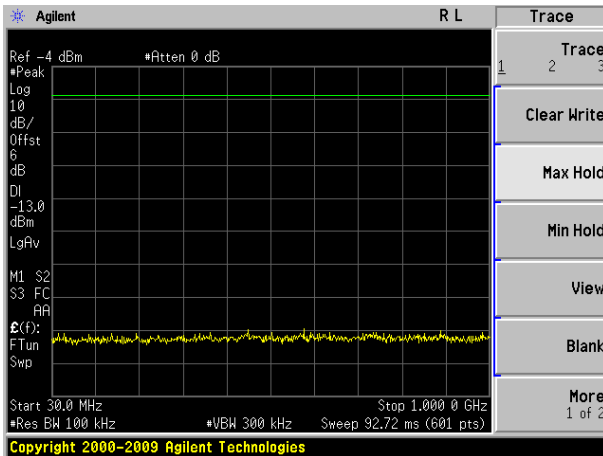

Middle channel

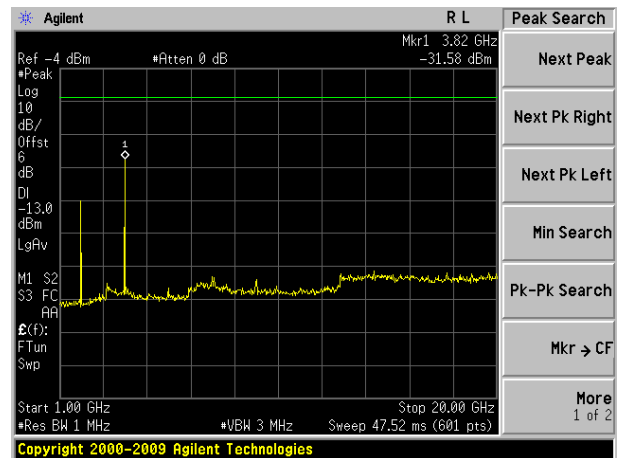
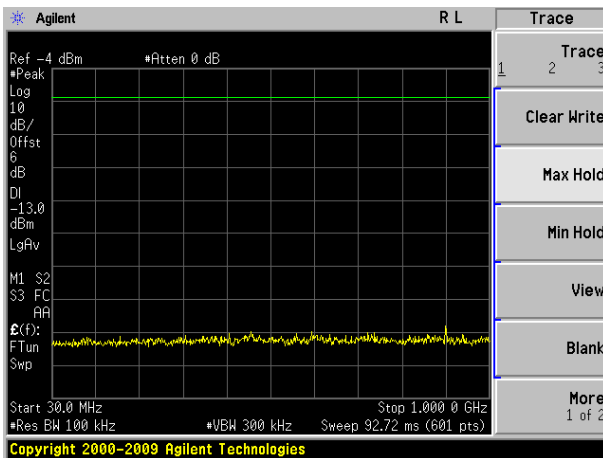

Highest channel

Band Edge:

Test Mode: Traffic mode GSM850 (GSM link)

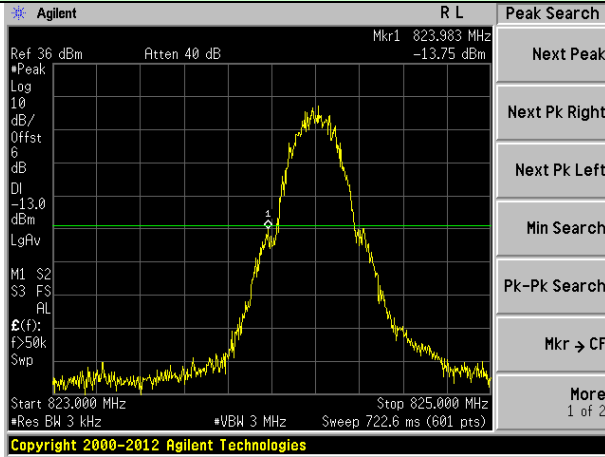

Lowest channel

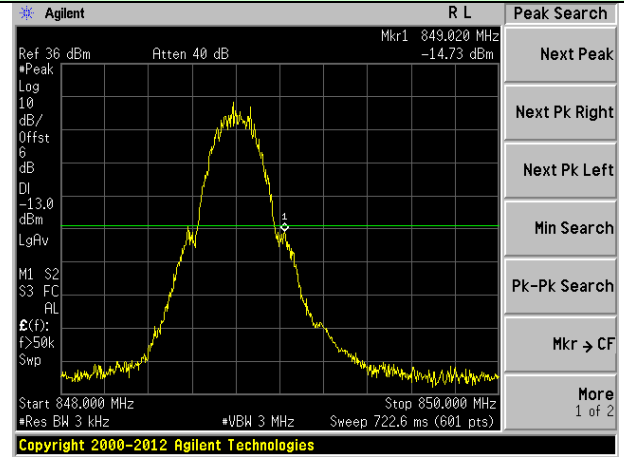

Highest channel

Test Mode: Traffic mode GSM850 (GPRS 1 link)

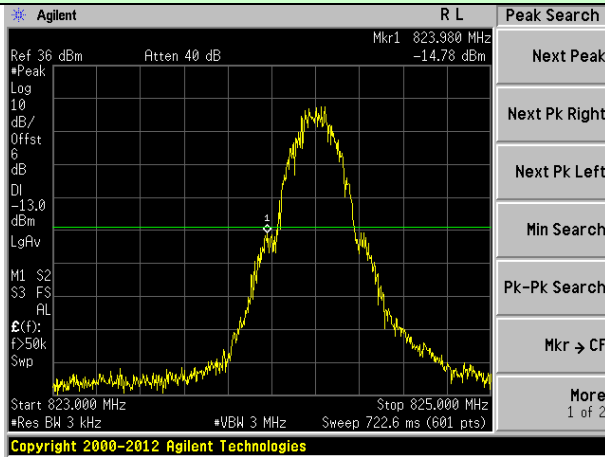

Lowest channel

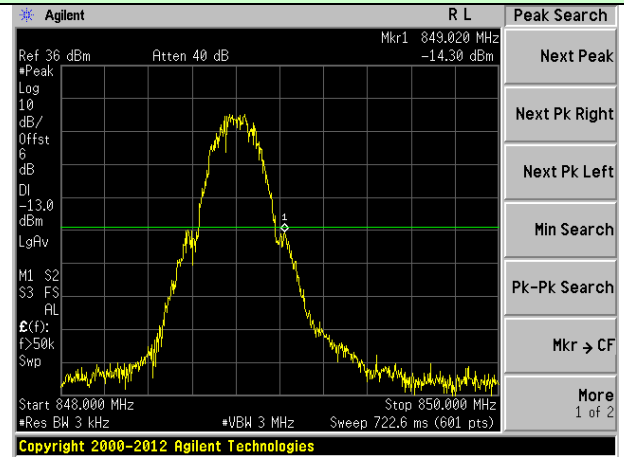

Highest channel

Test Mode: Traffic mode GSM850 (EGPRS 1 link)

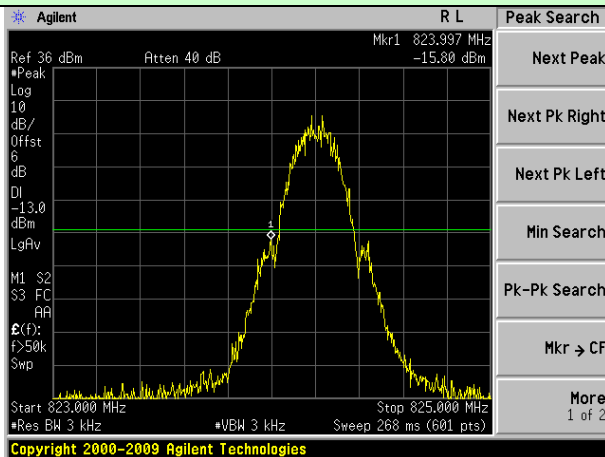

Lowest channel

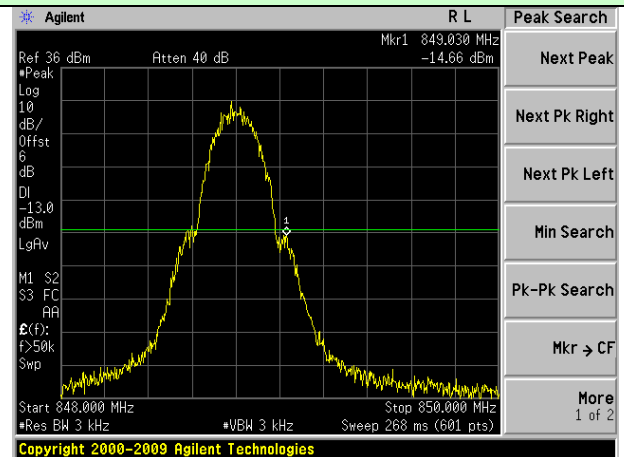

Highest channel

Test Mode: Traffic mode **PCS1900 (GSM link)**

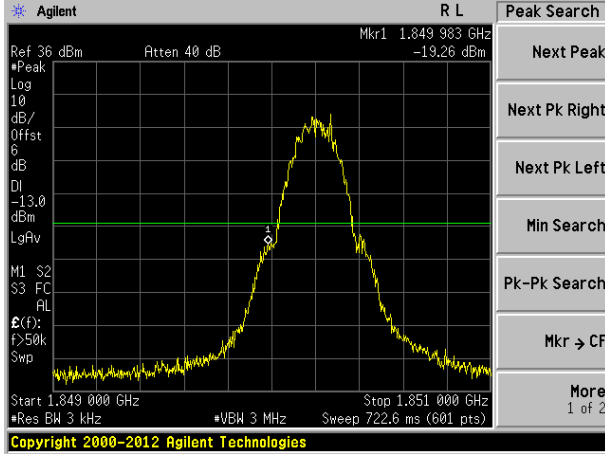

Lowest channel

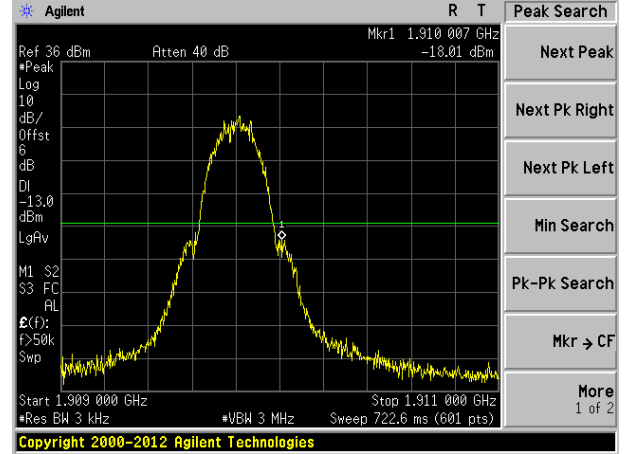

Highest channel

Test Mode: Traffic mode **PCS1900 (GPRS 1 link)**

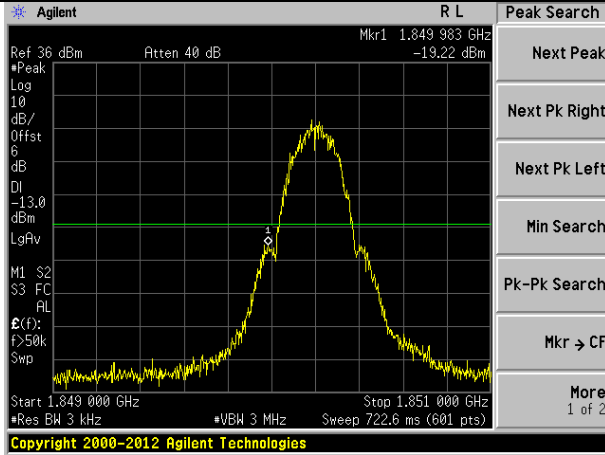

Lowest channel

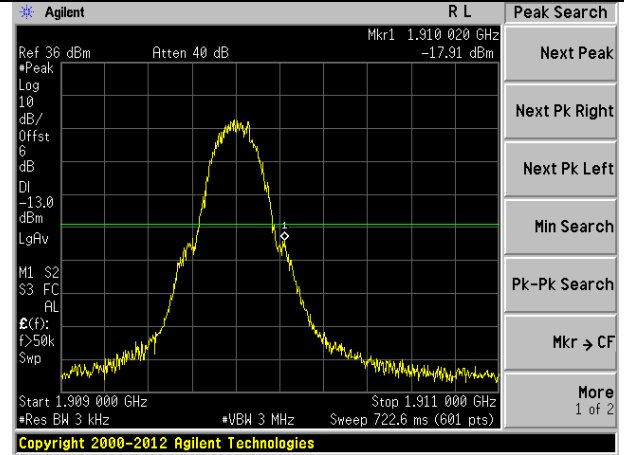

Highest channel

Test Mode: Traffic mode **PCS1900 (EGPRS 1 link)**

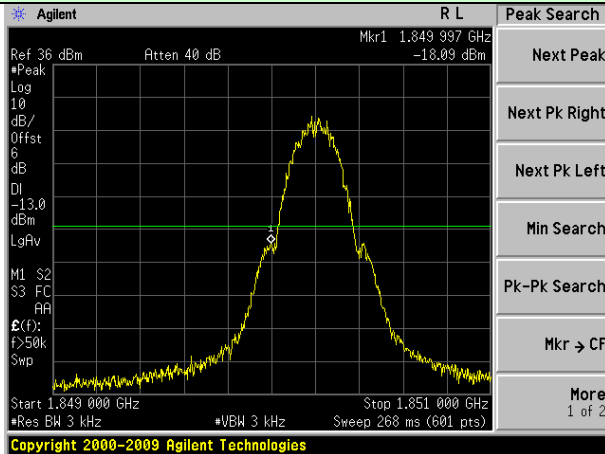

Lowest channel

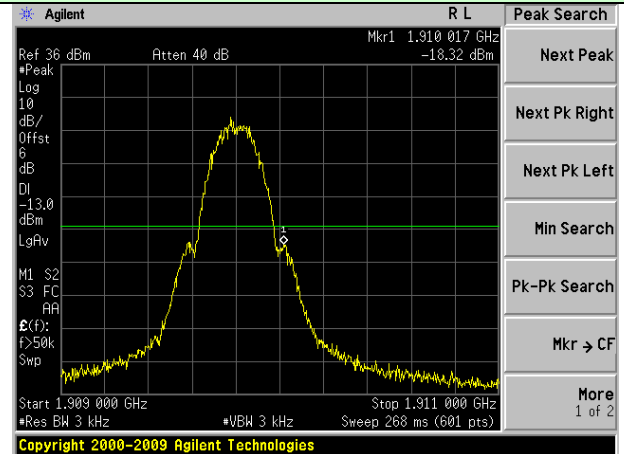

Highest channel

Test Mode: Traffic mode WCDMA Band V (RMC 12.2Kbps link)

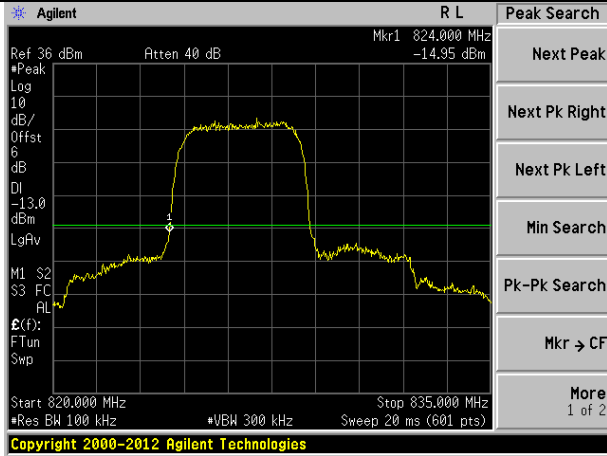

Lowest channel

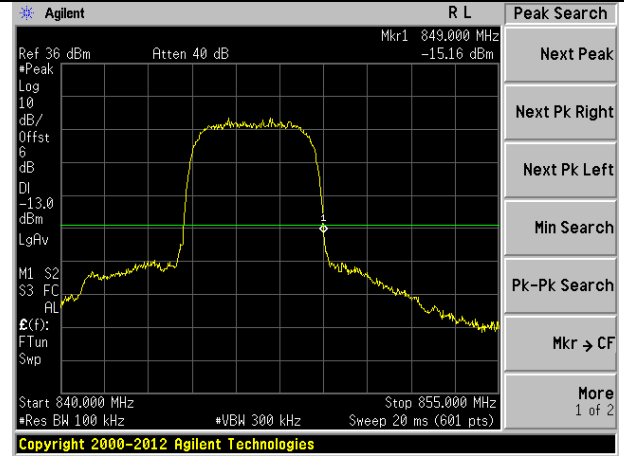

Highest channel

Test Mode: Traffic mode WCDMA Band II (RMC 12.2Kbps link)

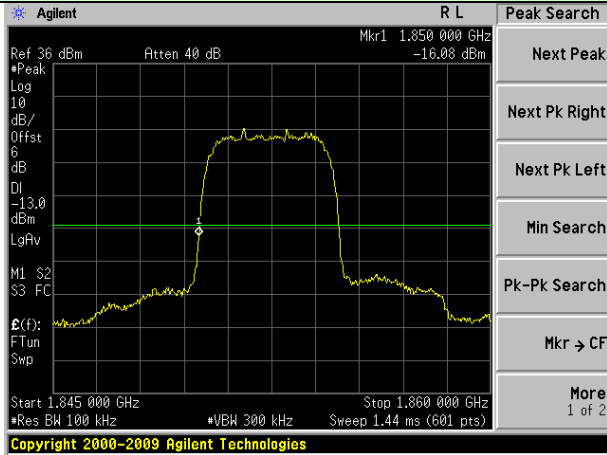

Lowest channel

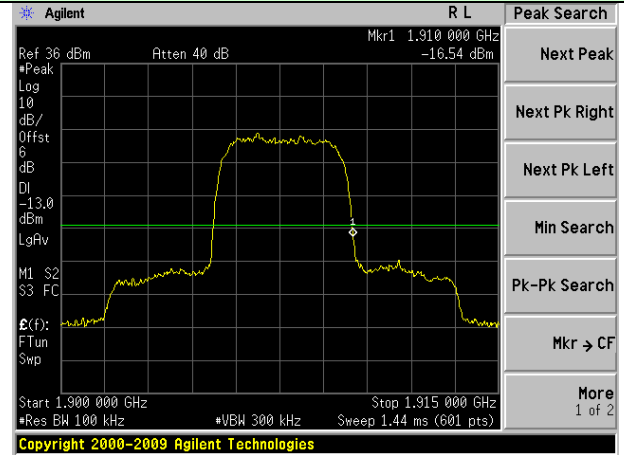

Highest channel

6.8 ERP, EIRP Measurement

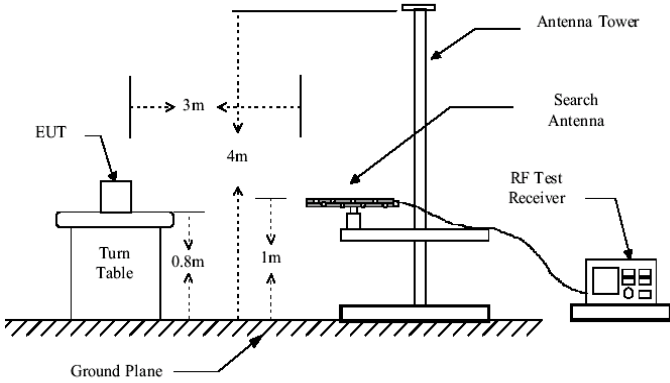
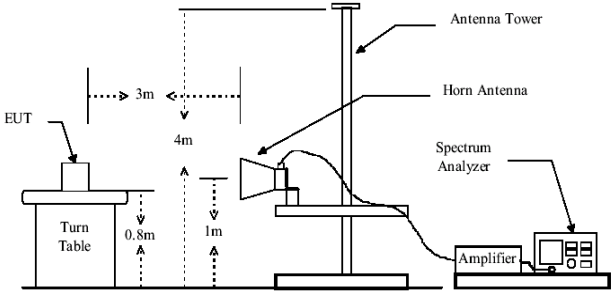
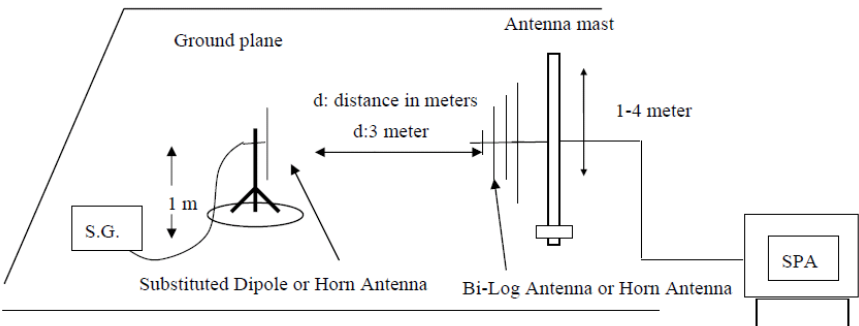
Test Requirement:	FCC part22.913(a) and FCC part24.232(b)
Test Method:	FCC part2.1046
Limit:	GSM850, WCDMA Band V: 7W PCS1900, WCDMA Band II: 2W WCDMA Band IV: 1W
Test setup:	<p>Below 1GHz</p>  <p>Above 1GHz</p>  <p>Substituted method:</p> 

<p>Test Procedure:</p>	<ol style="list-style-type: none"> 1. The EUT was placed on a non-conductive turntable using a non-conductive support. The radiated emission at the fundamental frequency was measured at 3 m with a test antenna and EMI spectrum analyzer. 2. During the measurement, the EUT was in communication with the station. The highest emission was recorded with the rotation of the turntable and the lowering of the test antenna from 4m to 1m. The reading was recorded and the field strength (E in dBuV/m) was calculated. 3. ERP in frequency band 824.2 –848.80.8MHz were measured using a substitution method. The EUT was replaced by a dipole antenna connected, the S.G. output was recorded and ERP was calculated as follows: $\text{ERP} = \text{S.G. output (dBm)} + \text{Antenna Gain (dBd)} - \text{Cable Loss (dB)}$ 4. EIRP in frequency band 1850.2 –1909.8MHz were measured using a substitution method. The EUT was replaced by a horn antenna connected, the S.G. output was recorded and EIRP was calculated as follows: $\text{EIRP} = \text{S.G. output (dBm)} + \text{Antenna Gain (dBi)} - \text{Cable Loss (dB)}$
<p>Test Instruments:</p>	<p>Refer to section 6.0 for details</p>
<p>Test mode:</p>	<p>Refer to section 7.1 for details</p>
<p>Test results:</p>	<p>Pass</p>

Measurement Data

EUT mode	Channel	EUT Pol.	Antenna Pol.	ERP(dBm)	Limit (dBm)	Result
GSM850 (GSM link)	Lowest	H	V	32.36	38.45	Pass
			H	29.30		
		E1	V	23.99		
			H	29.57		
		E2	V	23.16		
			H	27.30		
	Middle	H	V	32.42	38.45	Pass
			H	29.39		
		E1	V	24.18		
			H	29.80		
		E2	V	24.85		
			H	27.91		
	Highest	H	V	32.83	38.45	Pass
			H	29.13		
		E1	V	24.12		
			H	28.69		
		E2	V	22.94		
			H	28.37		

EUT mode	Channel	EUT Pol.	Antenna Pol.	ERP(dBm)	Limit (dBm)	Result
GSM850 (GPRS 1 link)	Lowest	H	V	32.04	38.45	Pass
			H	28.95		
		E1	V	23.62		
			H	29.19		
		E2	V	22.75		
			H	26.87		
	Middle	H	V	32.03	38.45	Pass
			H	28.95		
		E1	V	23.71		
			H	29.31		
		E2	V	24.41		
			H	27.46		
	Highest	H	V	32.44	38.45	Pass
			H	28.71		
		E1	V	23.69		
			H	28.24		
		E2	V	22.58		
			H	27.99		

EUT mode	Channel	EUT Pol.	Antenna Pol.	ERP(dBm)	Limit (dBm)	Result
GSM850 (EGPRS 1 link)	Lowest	H	V	27.44	38.45	Pass
			H	24.39		
		E1	V	19.01		
			H	24.88		
		E2	V	18.36		
			H	22.75		
	Middle	H	V	27.68	38.45	Pass
			H	24.78		
		E1	V	19.54		
			H	25.46		
		E2	V	20.08		
			H	23.34		
	Highest	H	V	27.89	38.45	Pass
			H	24.17		
		E1	V	19.11		
			H	23.94		
		E2	V	17.52		
			H	23.24		

EUT mode	Channel	EUT Pol.	Antenna Pol.	EIRP (dBm)	Limit (dBm)	Result
PCS1900 (GSM link)	Lowest	H	V	28.35	33.01	Pass
			H	25.57		
		E1	V	20.79		
			H	25.77		
		E2	V	19.98		
			H	23.67		
	Middle	H	V	28.36	33.01	Pass
			H	25.57		
		E1	V	20.87		
			H	25.88		
		E2	V	21.52		
			H	24.23		
	Highest	H	V	28.83	33.01	Pass
			H	25.48		
		E1	V	20.97		
			H	25.03		
		E2	V	20.01		
			H	24.85		

EUT mode	Channel	EUT Pol.	Antenna Pol.	EIRP (dBm)	Limit (dBm)	Result
PCS1900 (GPRS 1 link)	Lowest	H	V	27.86	33.01	Pass
			H	25.04		
		E1	V	20.21		
			H	25.16		
		E2	V	19.33		
			H	22.97		
	Middle	H	V	27.73	33.01	Pass
			H	24.85		
		E1	V	20.09		
			H	25.06		
		E2	V	20.80		
			H	23.47		
	Highest	H	V	28.21	33.01	Pass
			H	24.81		
		E1	V	20.26		
			H	24.29		
		E2	V	19.45		
			H	24.25		

EUT mode	Channel	EUT Pol.	Antenna Pol.	EIRP (dBm)	Limit (dBm)	Result
PCS1900 (EGPRS 1 link)	Lowest	H	V	24.65	33.01	Pass
			H	20.30		
		E1	V	14.52		
			H	20.47		
		E2	V	13.50		
			H	17.90		
	Middle	H	V	23.47	33.01	Pass
			H	20.06		
		E1	V	14.39		
			H	20.36		
		E2	V	15.20		
			H	18.43		
	Highest	H	V	23.87	33.01	Pass
			H	19.82		
		E1	V	14.38		
			H	19.24		
		E2	V	13.33		
			H	19.11		

EUT mode	Channel	EUT Pol.	Antenna Pol.	ERP(dBm)	Limit (dBm)	Result
WCDMA Band V	Lowest	H	V	22.05	38.45	Pass
			H	19.74		
		E1	V	15.98		
			H	19.19		
		E2	V	14.73		
			H	17.03		
	Middle	H	V	20.98	38.45	Pass
			H	18.23		
		E1	V	14.45		
			H	17.68		
		E2	V	15.41		
			H	17.01		
	Highest	H	V	19.94	38.45	Pass
			H	17.21		
		E1	V	13.64		
			H	16.22		
		E2	V	14.15		
			H	17.26		

EUT mode	Channel	EUT Pol.	Antenna Pol.	EIRP(dBm)	Limit (dBm)	Result
WCDMA Band II	Lowest	H	V	22.27	33.01	Pass
			H	19.98		
		E1	V	16.25		
			H	19.49		
		E2	V	15.06		
			H	17.38		
	Middle	H	V	21.29	33.01	Pass
			H	18.61		
		E1	V	14.87		
			H	18.13		
		E2	V	15.78		
			H	17.42		
	Highest	H	V	20.25	33.01	Pass
			H	17.55		
		E1	V	14.01		
			H	16.61		
		E2	V	14.42		
			H	17.56		

6.9 Field strength of spurious radiation measurement

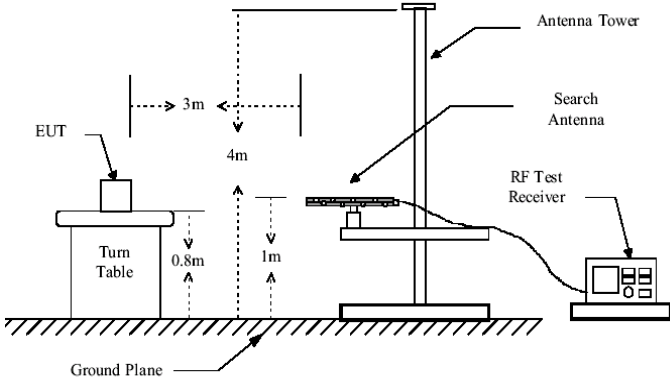
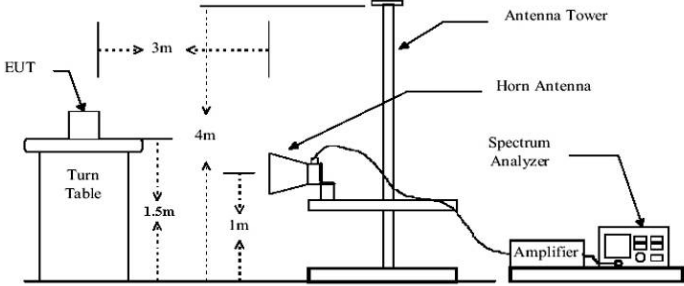
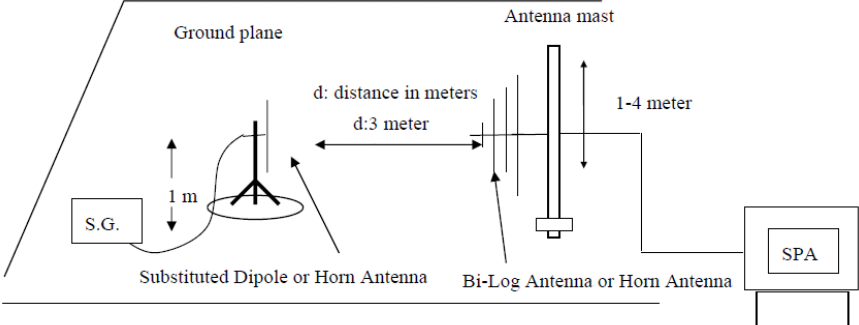
Test Requirement:	FCC part22.917(a) and FCC part24.238(a)
Test Method:	FCC part2.1053
Limit:	-13dBm
Test setup:	<p>Below 1GHz</p>  <p>Above 1GHz</p>  <p>Substituted method:</p> 

<p>Test Procedure:</p>	<ol style="list-style-type: none"> 1. The EUT was placed on a non-conductive turntable using a non-conductive support. The radiated emission at the fundamental frequency was measured at 3 m with a test antenna and EMI spectrum analyzer. 2. During the tests, the antenna height and the EUT azimuth were varied in order to identify the maximum level of emissions from the EUT. This maximization process was repeated with the EUT positioned in each of its three orthogonal orientations. 3. The frequency range up to tenth harmonic was investigated for each of three fundamental frequency (low, middle and high channels). Once spurious emission was identified, the power of the emission was determined using the substitution method. 4. The spurious emissions attenuation was calculated as the difference between radiated power at the fundamental frequency and the spurious emissions frequency. $\text{ERP / EIRP} = \text{S.G. output (dBm)} + \text{Antenna Gain(dB/dBi)} - \text{Cable Loss (dB)}$
<p>Test Instruments:</p>	<p>Refer to section 6.0 for details</p>
<p>Test mode:</p>	<p>Refer to section 7.1 for details</p>
<p>Test results:</p>	<p>Pass</p>

Measurement Data

Test mode:	GSM850		Test channel:	Lowest
Frequency (MHz)	Spurious Emission		Limit (dBm)	Result
	Polarization	Level (dBm)		
1648.40	Vertical	-35.88	-13.00	Pass
2472.60	V	-38.62		
3296.80	V	-40.89		
4121.00	V	-43.05		
4945.20	V	---		
1648.40	Horizontal	-41.13	-13.00	Pass
2472.60	H	-45.00		
3296.80	H	-46.57		
4121.00	H	-49.31		
4945.20	H	---		
Test mode:	GSM850		Test channel:	Middle
Frequency (MHz)	Spurious Emission		Limit (dBm)	Result
	Polarization	Level (dBm)		
1673.20	Vertical	-37.26	-13.00	Pass
2509.80	V	-39.54		
3346.40	V	-41.43		
4183.00	V	-43.24		
5019.60	V	---		
1673.20	Horizontal	-41.63	-13.00	Pass
2509.80	H	-44.86		
3346.40	H	-46.17		
4183.00	H	-48.45		
5019.60	H	---		
Test mode:	GSM850		Test channel:	Highest
Frequency (MHz)	Spurious Emission		Limit (dBm)	Result
	Polarization	Level (dBm)		
1697.60	Vertical	-37.50	-13.00	Pass
2546.40	V	-39.54		
3395.20	V	-41.21		
4244.00	V	-42.82		
5092.80	V	---		
1697.60	Horizontal	-41.40	-13.00	Pass
2546.40	H	-44.27		
3395.20	H	-45.43		
4244.00	H	-47.46		
5092.80	H	---		

Remark :

1. The emission behaviour belongs to narrowband spurious emission.
2. Remark"---" means that the emission level is too low to be measured
3. The emission levels of below 1 GHz are very lower than the limit and not show in test report.

Test mode:	PCS1900		Test channel:	Lowest
Frequency (MHz)	Spurious Emission		Limit (dBm)	Result
	Polarization	Level (dBm)		
3700.40	Vertical	-37.16	-13.00	Pass
5550.60	V	-39.53		
7400.80	V	-41.50		
9251.00	V	-43.39		
11101.20	V	---		
3700.40	Horizontal	-41.73	-13.00	Pass
5550.60	H	-45.09		
7400.80	H	-46.44		
9251.00	H	-48.80		
11101.20	H	---		
Test mode:	PCS1900		Test channel:	Middle
Frequency (MHz)	Spurious Emission		Limit (dBm)	Result
	Polarization	Level (dBm)		
3760.00	Vertical	-34.95	-13.00	Pass
5640.00	V	-37.40		
7520.00	V	-39.42		
9400.00	V	-41.39		
11280.00	V	---		
3760.00	Horizontal	-39.66	-13.00	Pass
5640.00	H	-43.13		
7520.00	H	-44.54		
9400.00	H	-46.98		
11280.00	H	---		
Test mode:	PCS1900		Test channel:	Highest
Frequency (MHz)	Spurious Emission		Limit (dBm)	Result
	Polarization	Level (dBm)		
3819.60	Vertical	-36.09	-13.00	Pass
5729.40	V	-38.46		
7639.20	V	-40.43		
9549.00	V	-42.33		
11458.80	V	---		
3819.60	Horizontal	-40.66	-13.00	Pass
5729.40	H	-44.03		
7639.20	H	-45.38		
9549.00	H	-47.75		
11458.80	H	---		

Remark:

1. The emission behaviour belongs to narrowband spurious emission.
2. Remark"---" means that the emission level is too low to be measured
3. The emission levels of below 1 GHz are very lower than the limit and not show in test report.

Test mode:	WCDMA Band V		Test channel:	Lowest
Frequency (MHz)	Spurious Emission		Limit (dBm)	Result
	Polarization	Level (dBm)		
1652.80	Vertical	-37.41	-13.00	Pass
2479.20	V	-41.15		
3305.60	V	-43.88		
4132.00	V	-41.41		
4958.40	V	---		
1652.80	Horizontal	-40.21	-13.00	Pass
2479.20	H	-42.90		
3305.60	H	-48.31		
4132.00	H	-51.93		
4958.40	H	---		
Test mode:	WCDMA Band V		Test channel:	Middle
Frequency (MHz)	Spurious Emission		Limit (dBm)	Result
	Polarization	Level (dBm)		
1672.80	Vertical	-39.43	-13.00	Pass
2509.20	V	-40.74		
3345.60	V	-44.36		
4182.00	V	-46.83		
5018.40	V	---		
1672.80	Horizontal	-41.89	-13.00	Pass
2509.20	H	-43.79		
3345.60	H	-48.48		
4182.00	H	-50.87		
5018.40	H	---		
Test mode:	WCDMA Band V		Test channel:	Highest
Frequency (MHz)	Spurious Emission		Limit (dBm)	Result
	Polarization	Level (dBm)		
1693.20	Vertical	-37.93	-13.00	Pass
2539.80	V	-40.37		
3386.40	V	-42.99		
4233.00	V	-45.89		
5079.60	V	---		
1693.20	Horizontal	-41.28	-13.00	Pass
2539.80	H	-43.70		
3386.40	H	-45.07		
4233.00	H	-51.26		
5079.60	H	---		

Remark :

1. The emission behaviour belongs to narrowband spurious emission.
2. Remark"---" means that the emission level is too low to be measured
3. The emission levels of below 1 GHz are very lower than the limit and not show in test report.

Test mode:	WCDMA Band II		Test channel:	Lowest
Frequency (MHz)	Spurious Emission		Limit (dBm)	Result
	Polarization	Level (dBm)		
3704.46	Vertical	-38.79	-13.00	Pass
5556.86	V	-41.87		
7409.26	V	-44.42		
9261.66	V	-46.87		
11114.40	V	---		
3704.46	Horizontal	-44.70	-13.00	Pass
5556.86	H	-49.06		
7409.26	H	-50.82		
9261.66	H	-53.89		
11114.40	H	---		
Test mode:	WCDMA Band II		Test channel:	Middle
Frequency (MHz)	Spurious Emission		Limit (dBm)	Result
	Polarization	Level (dBm)		
3759.83	Vertical	-39.55	-13.00	Pass
5639.83	V	-42.47		
7519.83	V	-44.88		
9399.83	V	-47.21		
11280.00	V	---		
3759.83	Horizontal	-45.16	-13.00	Pass
5639.83	H	-49.29		
7519.83	H	-50.96		
9399.83	H	-53.86		
11280.00	H	---		
Test mode:	WCDMA Band II		Test channel:	Highest
Frequency (MHz)	Spurious Emission		Limit (dBm)	Result
	Polarization	Level (dBm)		
3815.03	Vertical	-38.80	-13.00	Pass
5722.63	V	-41.52		
7630.23	V	-43.76		
9537.83	V	-45.94		
11445.60	V	---		
3815.03	Horizontal	-44.02	-13.00	Pass
5722.63	H	-47.88		
7630.23	H	-49.43		
9537.83	H	-52.14		
11445.60	H	---		

Remark:

1. The emission behaviour belongs to narrowband spurious emission.
2. Remark"---" means that the emission level is too low to be measured
3. The emission levels of below 1 GHz are very lower than the limit and not show in test report.

6.10 Frequency stability V.S. Temperature measurement

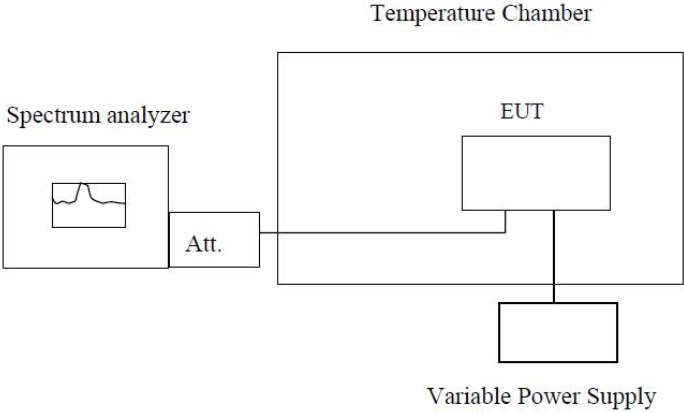
Test Requirement:	FCC Part2.1055(a)(1)(b)
Test Method:	FCC Part2.1055(a)(1)(b)
Limit:	2.5ppm
Test setup:	 <p>Note : Measurement setup for testing on Antenna connector</p>
Test procedure:	<ol style="list-style-type: none"> 1. The equipment under test was connected to an external DC power supply and input rated voltage. 2. RF output was connected to a frequency counter or spectrum analyzer via feed through attenuators. 3. The EUT was placed inside the temperature chamber. 4. Set the spectrum analyzer RBW low enough to obtain the desired frequency resolution and measure EUT 25°C operating frequency as reference frequency. 5. Turn EUT off and set the chamber temperature to -20°C. After the temperature stabilized for approximately 30 minutes recorded the frequency. 6. Repeat step measure with 10°C increased per stage until the highest temperature of +50°C reached.
Test Instruments:	Refer to section 6.0 for details
Test mode:	Refer to section 7.1 for details
Test results:	Pass

Measurement Data

Reference Frequency: GSM850 (GSM link) Middle channel=190 channel=836.6MHz					
Power supplied (Vdc)	Temperature (°C)	Frequency error		Limit (ppm)	Result
		Hz	ppm		
3.70	-30	33	0.0400	2.5	Pass
	-20	37	0.0443		
	-10	32	0.0386		
	0	28	0.0329		
	10	31	0.0372		
	20	28	0.0329		
	30	42	0.0500		
	40	38	0.0457		
	50	37	0.0443		
Reference Frequency: GSM850 (GPRS 1 link) Middle channel=190 channel=836.6MHz					
Power supplied (Vdc)	Temperature (°C)	Frequency error		Limit (ppm)	Result
		Hz	ppm		
3.70	-30	28	0.0330	2.5	Pass
	-20	30	0.0356		
	-10	27	0.0317		
	0	24	0.0292		
	10	25	0.0305		
	20	23	0.0279		
	30	35	0.0421		
	40	31	0.0369		
	50	30	0.0356		
Reference Frequency: GSM850 (EGPRS 1 link) Middle channel=190 channel=836.6MHz					
Power supplied (Vdc)	Temperature (°C)	Frequency error		Limit (ppm)	Result
		Hz	ppm		
3.70	-30	55	0.0653	2.5	Pass
	-20	64	0.0763		
	-10	53	0.0631		
	0	45	0.0542		
	10	51	0.0613		
	20	44	0.0527		
	30	77	0.0924		
	40	67	0.0798		
	50	63	0.0753		

Reference Frequency: PCS1900 (GSM link) Middle channel=661 channel=1880MHz					
Power supplied (Vdc)	Temperature (°C)	Frequency error			Result
		Hz	ppm		
3.70	-30	23	0.0121	2.5	Pass
	-20	29	0.0155		
	-10	23	0.0121		
	0	17	0.0093		
	10	23	0.0121		
	20	18	0.0098		
	30	37	0.0194		
	40	30	0.0160		
	50	28	0.0149		
Reference Frequency: PCS1900 (GPRS 1 link) Middle channel=661 channel=1880MHz					
Power supplied (Vdc)	Temperature (°C)	Frequency error			Result
		Hz	ppm		
3.70	-30	34	0.0179	2.5	Pass
	-20	40	0.0213		
	-10	31	0.0166		
	0	25	0.0132		
	10	32	0.0172		
	20	25	0.0132		
	30	46	0.0247		
	40	37	0.0199		
	50	40	0.0213		
Reference Frequency: PCS1900 (EGPRS 1 link) Middle channel=661 channel=1880MHz					
Power supplied (Vdc)	Temperature (°C)	Frequency error			Result
		Hz	ppm		
3.70	-30	74	0.0396	2.5	Pass
	-20	88	0.0470		
	-10	71	0.0379		
	0	58	0.0308		
	10	72	0.0384		
	20	60	0.0318		
	30	100	0.0530		
	40	83	0.0440		
	50	87	0.0463		

Reference Frequency: WCDMA Band V Middle channel=4183 channel=836.6MHz					
Power supplied (Vdc)	Temperature (°C)	Frequency error		Limit (ppm)	Result
		Hz	ppm		
3.70	-30	35	0.0422	2.5	Pass
	-20	49	0.0588		
	-10	55	0.0663		
	0	26	0.0317		
	10	39	0.0467		
	20	43	0.0512		
	30	63	0.0753		
	40	59	0.0708		
	50	71	0.0844		
Reference Frequency: WCDMA Band II Middle channel=9400 channel=1880.0MHz					
Power supplied (Vdc)	Temperature (°C)	Frequency error		Limit (ppm)	Result
		Hz	ppm		
3.70	-30	109	0.0579	2.5	Pass
	-20	97	0.0514		
	-10	83	0.0443		
	0	78	0.0414		
	10	71	0.0378		
	20	62	0.0328		
	30	78	0.0414		
	40	87	0.0464		
	50	83	0.0443		

6.11 Frequency stability V.S. Voltage measurement

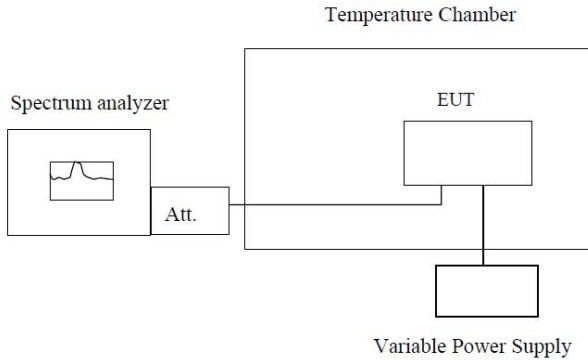
Test Requirement:	FCC Part2.1055(d)(1)(2)
Test Method:	FCC Part2.1055(d)(1)(2)
Limit:	2.5ppm
Test setup:	 <p style="text-align: center;">Temperature Chamber</p> <p style="text-align: center;">Spectrum analyzer</p> <p style="text-align: center;">Att.</p> <p style="text-align: center;">EUT</p> <p style="text-align: center;">Variable Power Supply</p> <p>Note : Measurement setup for testing on Antenna connector</p>
Test procedure:	<ol style="list-style-type: none"> 1. Set chamber temperature to 25°C. Use a variable DC power source to power the EUT and set the voltage to rated voltage. 2. Set the spectrum analyzer RBW low enough to obtain the desired frequency resolution and recorded the frequency. 3. Reduce the input voltage to specified extreme voltage variation (+/- 15%) and endpoint, record the maximum frequency change.
Test Instruments:	Refer to section 6.0 for details
Test mode:	Refer to section 7.1 for details
Test results:	Pass

Measurement Data

Reference Frequency: GSM850 (GSM link) Middle channel=190 channel=836.6MHz					
Temperature (°C)	Power supplied (Vdc)	Frequency error		Limit (ppm)	Result
		Hz	ppm		
25	4.25	20	0.0244	2.5	Pass
	3.7	23	0.0274		
	3.4	25	0.0304		
Reference Frequency: GSM850 (GPRS 1 link) Middle channel=190 channel=836.6MHz					
Temperature (°C)	Power supplied (Vdc)	Frequency error		Limit (ppm)	Result
		Hz	ppm		
25	4.25	23	0.0281	2.5	Pass
	3.7	15	0.0181		
	3.4	18	0.0214		
Reference Frequency: GSM850 (EGPRS 1 link) Middle channel=190 channel=836.6MHz					
Temperature (°C)	Power supplied (Vdc)	Frequency error		Limit (ppm)	Result
		Hz	ppm		
25	4.25	33	0.0389	2.5	Pass
	3.7	38	0.0450		
	3.4	43	0.0510		

Reference Frequency: PCS1900 (GSM link) Middle channel=661 channel=1880MHz					
Temperature (°C)	Power supplied (Vdc)	Frequency error		Limit (ppm)	Result
		Hz	ppm		
25	4.25	13	0.0071	2.5	Pass
	3.7	20	0.0104		
	3.4	20	0.0104		
Reference Frequency: PCS1900 (GPRS 1 link) Middle channel=661 channel=1880MHz					
Temperature (°C)	Power supplied (Vdc)	Frequency error		Limit (ppm)	Result
		Hz	ppm		
25	4.25	55	0.0292	2.5	Pass
	3.7	43	0.0227		
	3.4	45	0.0240		
Reference Frequency: PCS1900 (EGPRS 1 link) Middle channel=661 channel=1880MHz					
Temperature (°C)	Power supplied (Vdc)	Frequency error		Limit (ppm)	Result
		Hz	ppm		
25	4.25	75	0.0397	2.5	Pass
	3.7	85	0.0451		
	3.4	85	0.0453		

Reference Frequency: WCDMA Band V Middle channel=4183 channel=836.6MHz					
Temperature (°C)	Power supplied (Vdc)	Frequency error		Limit (ppm)	Result
		Hz	ppm		
25	4.25	37	0.0440	2.5	Pass
	3.7	48	0.0570		
	3.4	26	0.0309		
Reference Frequency: WCDMA Band II Middle channel=940 channel=1880.0MHz					
Temperature (°C)	Power supplied (Vdc)	Frequency error		Limit (ppm)	Result
		Hz	ppm		
25	4.25	46	0.0243	2.5	Pass
	3.7	37	0.0197		
	3.4	42	0.0223		

7 Test Setup Photo

Radiated Emission

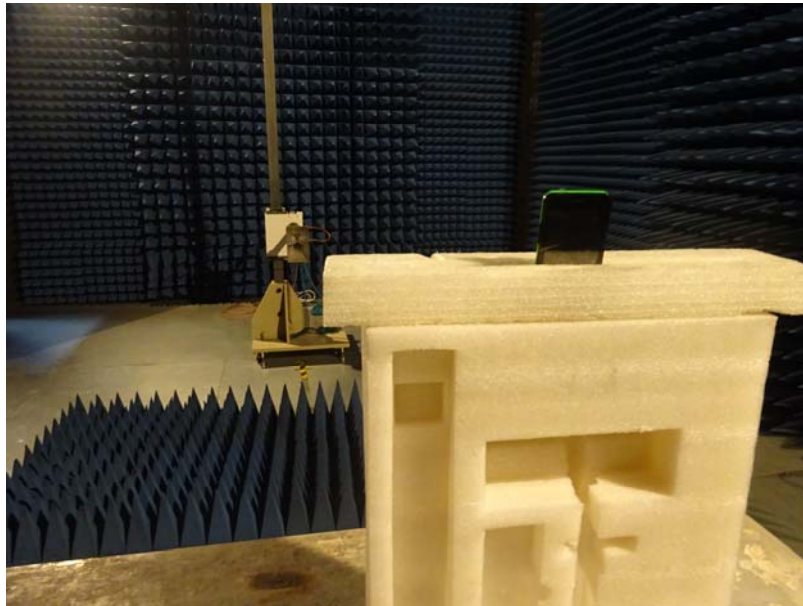
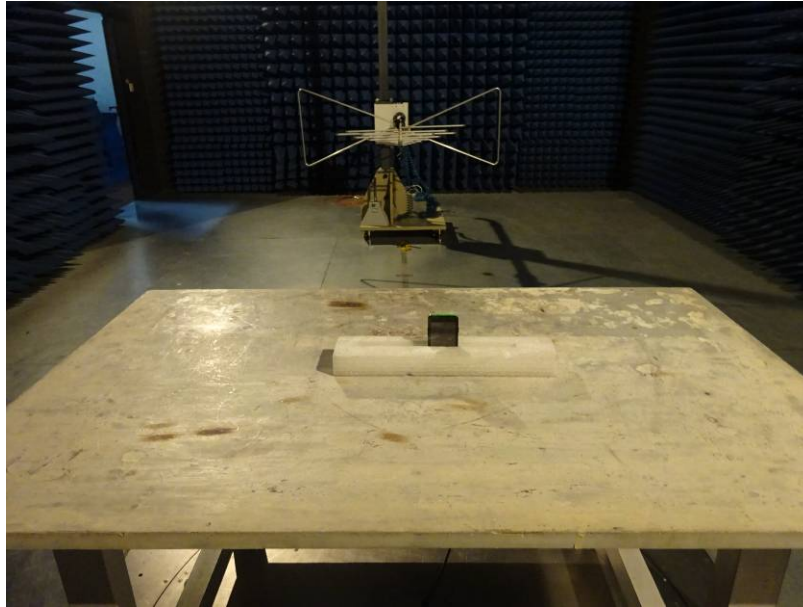

8 EUT Constructional Details













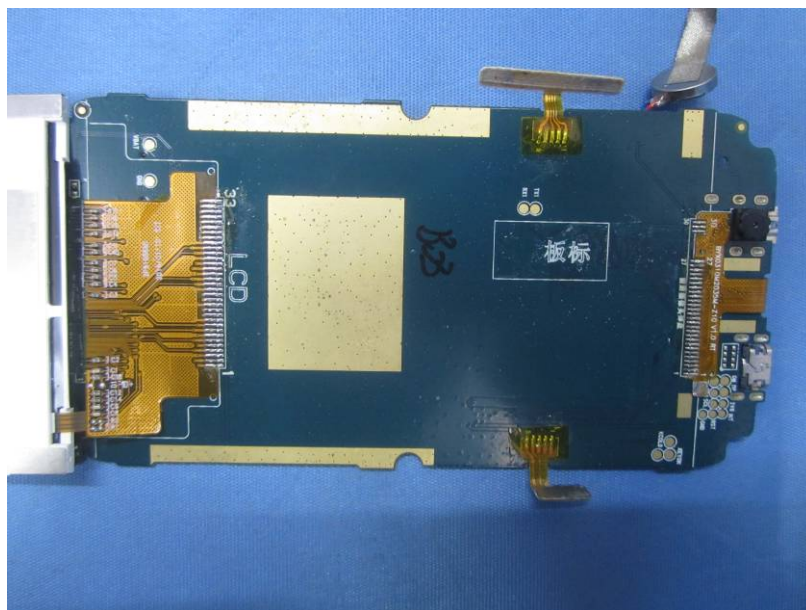
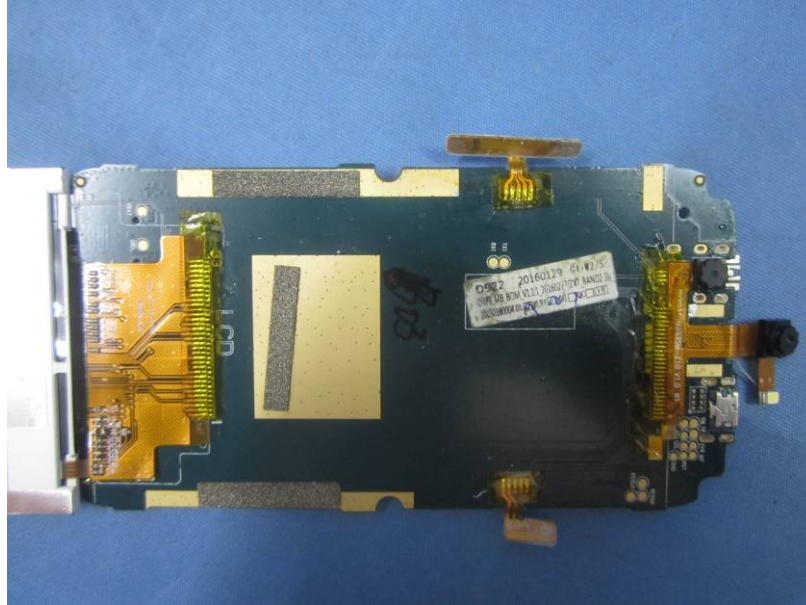





-----End-----