

TEST REPORT

Report No.: BCTC2307405493E

Applicant: SHENZHEN BVSION TECHNOLOGY CO.,LTD

Product Name: TOUCH AIO PC

Model/Type
reference: VR215

Tested Date: 2023-07-03 to 2023-08-11

Issued Date: 2023-08-11

Shenzhen BCTC Testing Co., Ltd.



SHENZHEN

FCC ID:2AKRP-VR215

Product Name: TOUCH AIO PC

Trademark: 

Model/Type reference: VR215
Series Models Ref. The 4.1.

Prepared For: SHENZHEN BVSION TECHNOLOGY CO.,LTD

Address: No.9, 502 Huafeng Industrial Park, Fengtong Road, Tangwei Community, Fuhai Street, Bao'an District, Shenzhen City, China.

Manufacturer: SHENZHEN BVSION TECHNOLOGY CO.,LTD

Address: No.9, 502 Huafeng Industrial Park, Fengtong Road, Tangwei Community, Fuhai Street, Bao'an District, Shenzhen City, China.

Prepared By: Shenzhen BCTC Testing Co., Ltd.

Address: 1-2/F., Building B, Pengzhou Industrial Park, No.158, Fuyuan 1st Road, Tangwei, Fuhai Subdistrict, Bao'an District, Shenzhen, Guangdong, China

Sample Received Date: 2023-07-03

Sample tested Date: 2023-07-03 to 2023-08-11

Issue Date: 2023-08-11

Report No.: BCTC2307405493E

Test Standards: FCC Part15.247
ANSI C63.10-2013

Test Results: PASS

Remark: This is WIFI-2.4GHz band radio test report.

Tested by:



Jeff.Fu/Project Handler

Approved by:



Zero Zhou/Reviewer

The test report is effective only with both signature and specialized stamp. This result(s) shown in this report refer only to the sample(s) tested. Without written approval of Shenzhen BCTC Testing Co., Ltd, this report can't be reproduced except in full. The tested sample(s) and the sample information are provided by the client.

Table Of Content

Test Report Declaration	Page
1. Version	5
2. Test Summary	6
3. Measurement Uncertainty	7
4. Product Information And Test Setup	8
4.1 Product Information.....	8
4.2 Test Setup Configuration	8
4.3 Support Equipment.....	9
4.4 Channel List	9
4.5 Test Mode	10
4.6 Table Of Parameters Of Text Software Setting.....	10
5. Test Facility And Test Instrument Used.....	11
5.1 Test Facility.....	11
5.2 Test Instrument Used.....	11
6. Conducted Emissions.....	13
6.1 Block Diagram Of Test Setup.....	13
6.2 Limit	13
6.3 Test Procedure	13
6.4 EUT Operating Conditions	13
6.5 Test Result.....	14
7. Radiated Emissions.....	16
7.1 Block Diagram Of Test Setup.....	16
7.2 Limit	17
7.3 Test Procedure	18
7.4 EUT Operating Conditions	19
7.5 Test Result.....	19
8. Radiated Band Emission Measurement And Restricted Bands Of Operation	25
8.1 Block Diagram Of Test Setup.....	25
8.2 Limit	25
8.3 Test Procedure	26
8.4 EUT Operating Conditions	26
8.5 Test Result.....	27
9. Power Spectral Density Test	29
9.1 Block Diagram Of Test Setup.....	29
9.2 Limit	29
9.3 Test Procedure	29
9.4 EUT Operating Conditions	29
9.5 Test Result.....	30
10. Bandwidth Test.....	36
10.1 Block Diagram Of Test Setup.....	36
10.2 Limit	36
10.3 Test Procedure	36
10.4 EUT Operating Conditions	36
10.5 Test Result.....	37

BCTC
 3C
 PPR
 检测

11. Peak Output Power Test	43
11.1 Block Diagram Of Test Setup.....	43
11.2 Limit	43
11.3 Test Procedure	43
11.4 EUT Operating Conditions	43
11.5 Test Result.....	44
12. 100 KHz Bandwidth Of Frequency Band Edge.....	45
12.1 Block Diagram Of Test Setup.....	45
12.2 Limit	45
12.3 Test Procedure	45
12.4 EUT Operating Conditions	45
12.5 Test Result.....	46
13. Duty Cycle Of Test Signal	61
13.1 Standard Requirement.....	61
13.2 Formula.....	61
13.3 Test Procedure	61
13.4 Test Result.....	61
14. Antenna Requirement	67
14.1 Limit	67
14.2 Test Result.....	67
15. EUT Photographs.....	68
16. EUT Test Setup Photographs.....	69

(Note: N/A Means Not Applicable)

1. Version

Report No.	Issue Date	Description	Approved
BCTC2307405493E	2023-08-11	Original	Valid

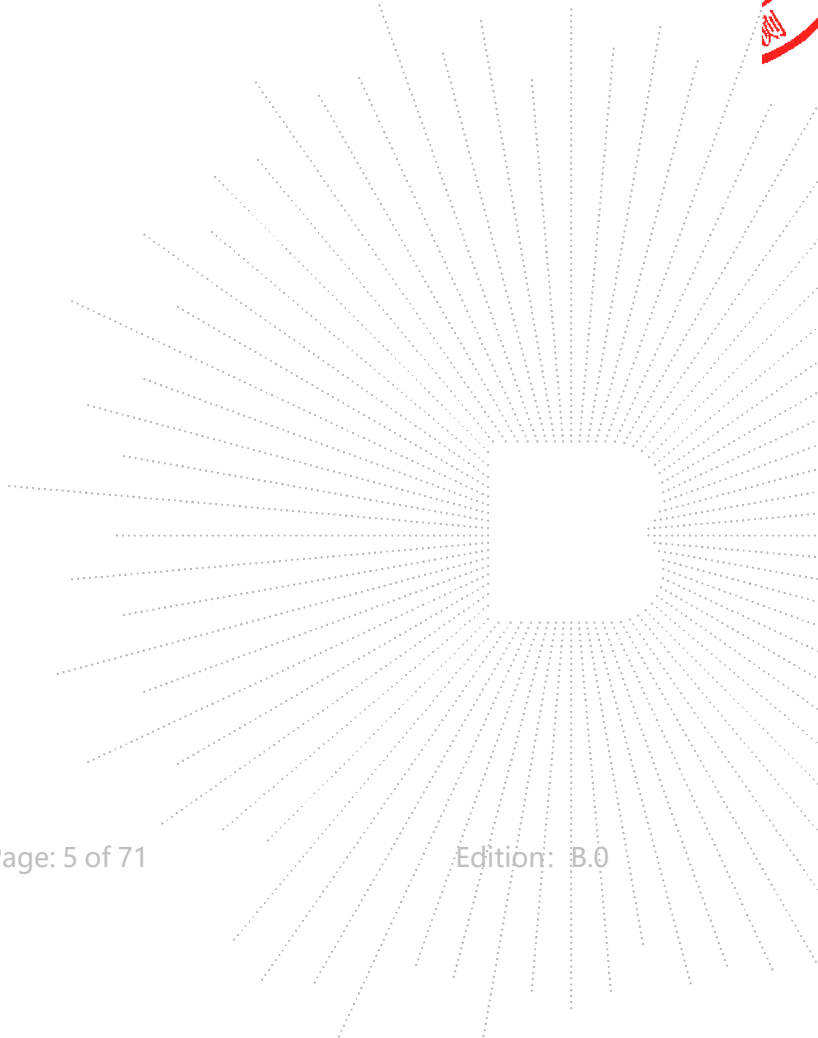

2. Test Summary

The Product has been tested according to the following specifications:

No.	Test Parameter	Clause No	Results
1	Conducted Emission	15.207	PASS
2	6dB Bandwidth	15.247 (a)(2)	PASS
3	Peak Output Power	15.247 (b)	PASS
4	Radiated Spurious Emission	15.247 (d)	PASS
5	Power Spectral Density	15.247 (e)	PASS
6	Restricted Band of Operation	15.205	PASS
7	Band Edge (Out of Band Emissions)	15.247 (d)	PASS
8	Antenna Requirement	15.203	PASS



CO. LTD

3. Measurement Uncertainty

Where relevant, the following measurement uncertainty levels have been estimated for tests performed on the Product as specified in CISPR 16-4-2. This uncertainty represents an expanded uncertainty expressed at approximately the 95% confidence level using a coverage factor of k=2.

No.	Item	Uncertainty
1	3m chamber Radiated spurious emission(9kHz-30MHz)	U=3.7dB
2	3m chamber Radiated spurious emission(30MHz-1GHz)	U=4.3dB
3	3m chamber Radiated spurious emission(1GHz-18GHz)	U=4.5dB
4	3m chamber Radiated spurious emission(18GHz-40GHz)	U=3.34dB
5	Conducted Emission(150kHz-30MHz)	U=3.20dB
6	Conducted Adjacent channel power	U=1.38dB
7	Conducted output power uncertainty Above 1G	U=1.576dB
8	Conducted output power uncertainty below 1G	U=1.28dB
9	humidity uncertainty	U=5.3%
10	Temperature uncertainty	U=0.59°C

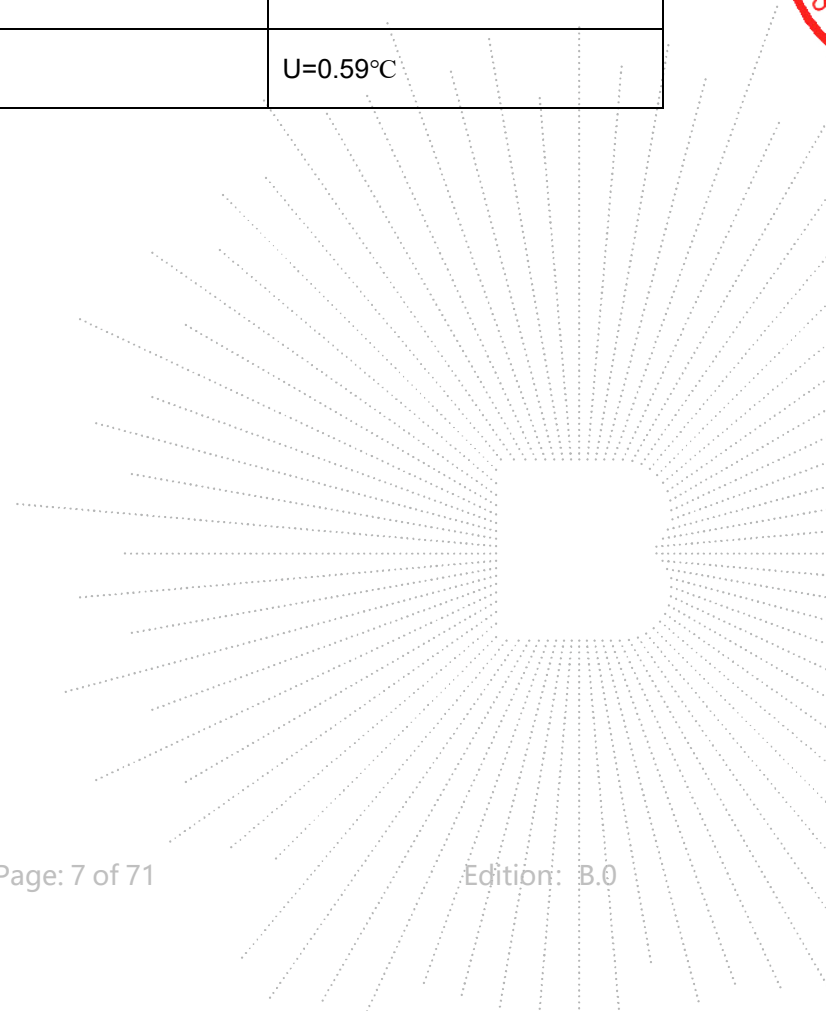
4. Product Information And Test Setup

4.1 Product Information

Model/Type reference:	VR215 VR156, VR101, XC156, XC150, XC170, XC215, QR101, QG104, QG121, QG150, QG156, QG170, QG185, QG190, QG215, QW104, QW121, QW156, QW185, HY101-R, HY101-A, YR101, YA101, YL101, YL156, YL215, YRM156, ZR140, ZR156, ZR185, ZR215, ZR236, ZR238, ZR270, ZR320, ZR430, BVS-SW156T1, BVS-SW156T2, BVS-SW1506R, BVS-SW1501, BVS-SW1502, BVS-SW156U1, BVS-SW156U2, BVS-SW1701, BVS-SW1702, BVS-SW1401, BVS-SW1402, BVS-SW238, BVS-SJ156-16E, BVS-SJ156-26E, BVS-SJ156-U6, BVS-SJ15601-S1, BVS-140M2, BVS-140M2T, BVS-156M2, BVS-156M2T, BVS-166M2, BVS-166M2T, BVS-173M2, BVS-173M2T, BVS-185M2, BVS-185M2T, BVS-101M5T, BVS-150M5T, BVS-170M5T, BVS-190M5T, BVS-215M5T, BVS-220M5T, BVS-230M5T, BVS-236M5T, BVS-270M5T, BVS-320M5T, BVS-430M5T, GW-A, GW-B
Model differences:	All the model are the same circuit and RF module, except model names and appearance color.
Operation Frequency:	802.11b/g/n20MHz:2412~2462 MHz
Bit Rate of Transmitter	802.11b:11/5.5/2/1 Mbps 802.11g:54/48/36/24/18/12/9/6Mbps 802.11n Up to 75Mbps
Type of Modulation:	OFDM/DSSS
Number Of Channel	802.11b/g/n20MHz:11 CH
Antenna installation:	FPCB antenna
Antenna Gain:	5.18 dBi
Ratings:	DC 12V From Adapter Model No.: BSG-1203000
Adapter Information:	Input:100-240V~ 50/60Hz 0.8A Max Output: DC 12V 3A

4.2 Test Setup Configuration

See test photographs attached in *EUT TEST SETUP PHOTOGRAPHS* for the actual connections between Product and support equipment.

Conducted Emission:

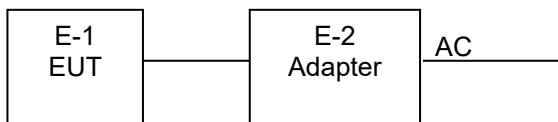

Radiated Spurious Emission

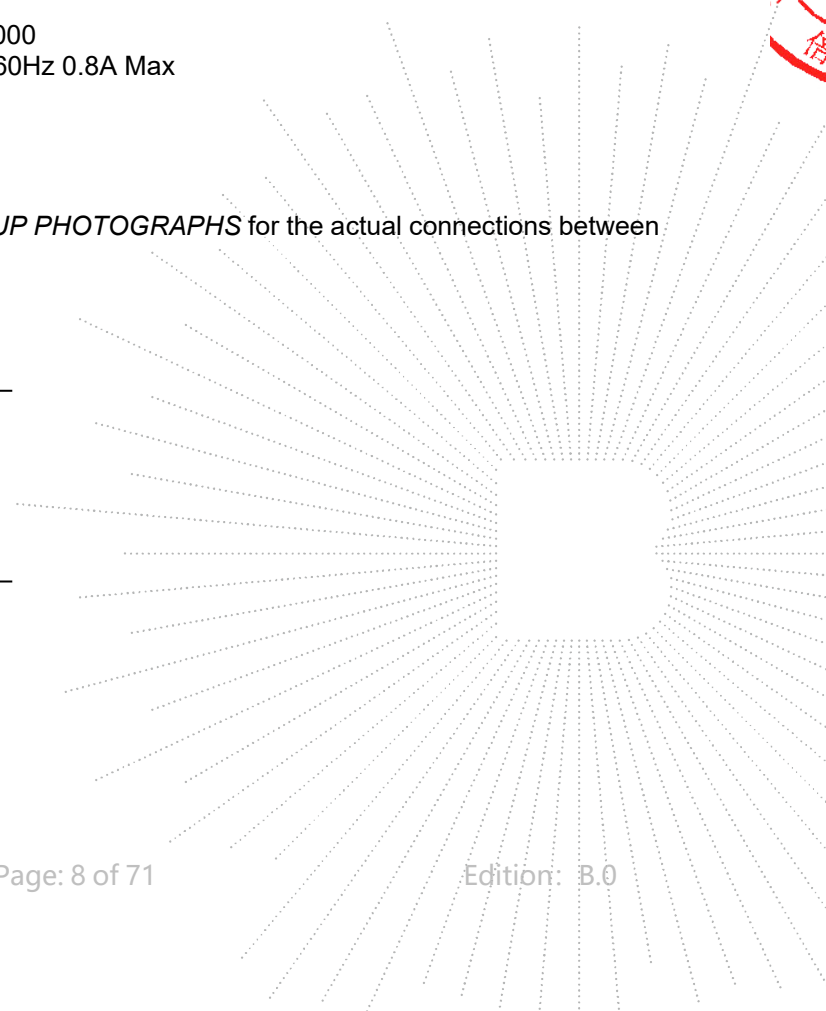
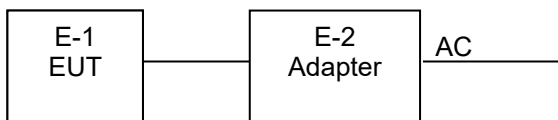

4.3 Support Equipment

No.	Device Type	Brand	Model	Series No.	Note
E-1	TOUCH AIO PC		VR215	N/A	EUT
E-2	Adapter	N/A	ADP-60E12	N/A	Auxiliary

Item	Shielded Type	Ferrite Core	Length	Note
C-1	NO	NO	0.5M	DC cable unshielded

Notes:

1. All the equipment/cables were placed in the worst-case configuration to maximize the emission during the test.
2. Grounding was established in accordance with the manufacturer's requirements and conditions for the intended use.

4.4 Channel List

Channel List for 802.11b/g/n(20)					
Channel	Frequency (MHz)	Channel	Frequency (MHz)	Channel	Frequency (MHz)
01	2412	02	2417	03	2422
04	2427	05	2432	06	2437
07	2442	08	2447	09	2452
10	2457	11	2462		

TC
3C
PPR
測

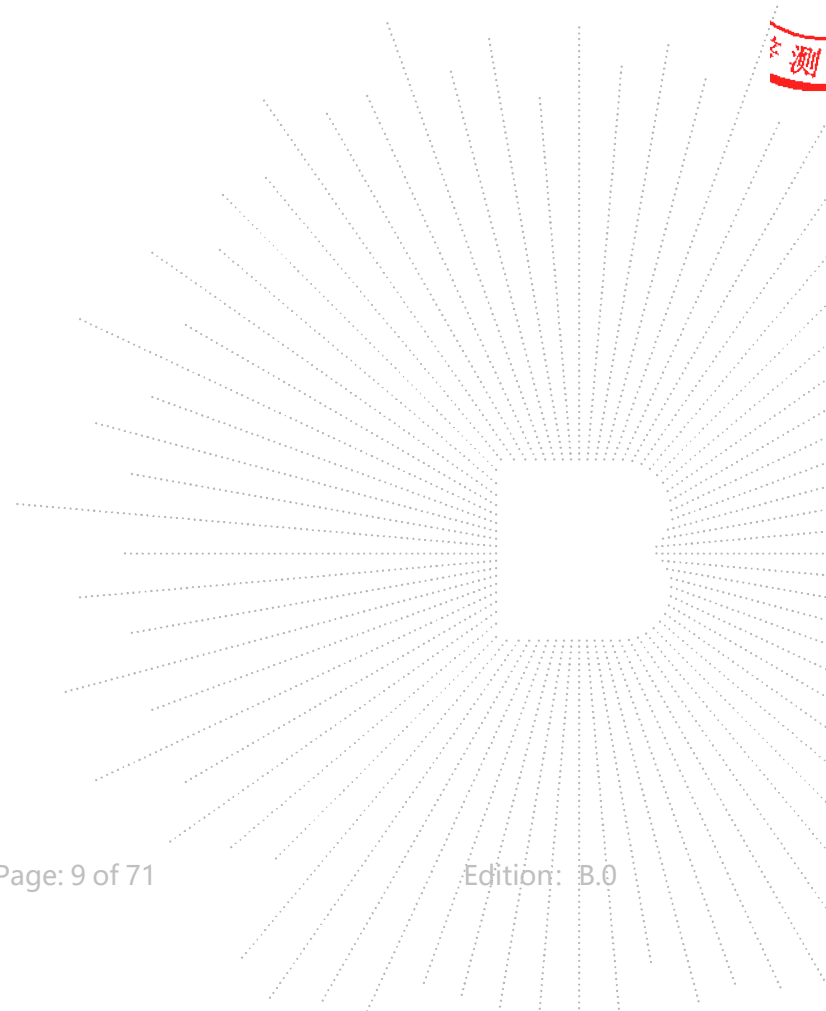

4.5 Test Mode

To investigate the maximum EMI emission characteristics generates from EUT, the test system was pre-scanning tested base on the consideration of following EUT operation mode or test configuration mode which possible have effect on EMI emission level. Each of these EUT operation mode(s) or test configuration mode(s) mentioned above was evaluated respectively.

Pretest Mode	Description
Mode 1	802.11b CH1/ CH6/ CH11
Mode 2	802.11g CH1/ CH6/ CH11
Mode 3	802.11n20 CH1/ CH6/ CH11
Mode 4	Link Mode

Radiated Emission	
Final Test Mode	Description
Mode 4	Link Mode

For Radiated Emission	
Final Test Mode	Description
Mode 1	802.11b CH1/ CH6/ CH11
Mode 2	802.11g CH1/ CH6/ CH11
Mode 3	802.11n20 CH1/ CH6/ CH11

Note:

(1) The measurements are performed at all Bit Rate of Transmitter, the worst data was reported.

4.6 Table Of Parameters Of Text Software Setting

During testing channel & power controlling software provided by the customer was used to control the operating channel as well as the output power level. The RF output power selection is for the setting of RF output power expected by the customer and is going to be fixed on the firmware of the final end product power parameters

Test software Version	CMD		
Frequency	2412 MHz	2437 MHz	2462 MHz
Parameters	DEF	DEF	DEF

TE
TC
OV
检

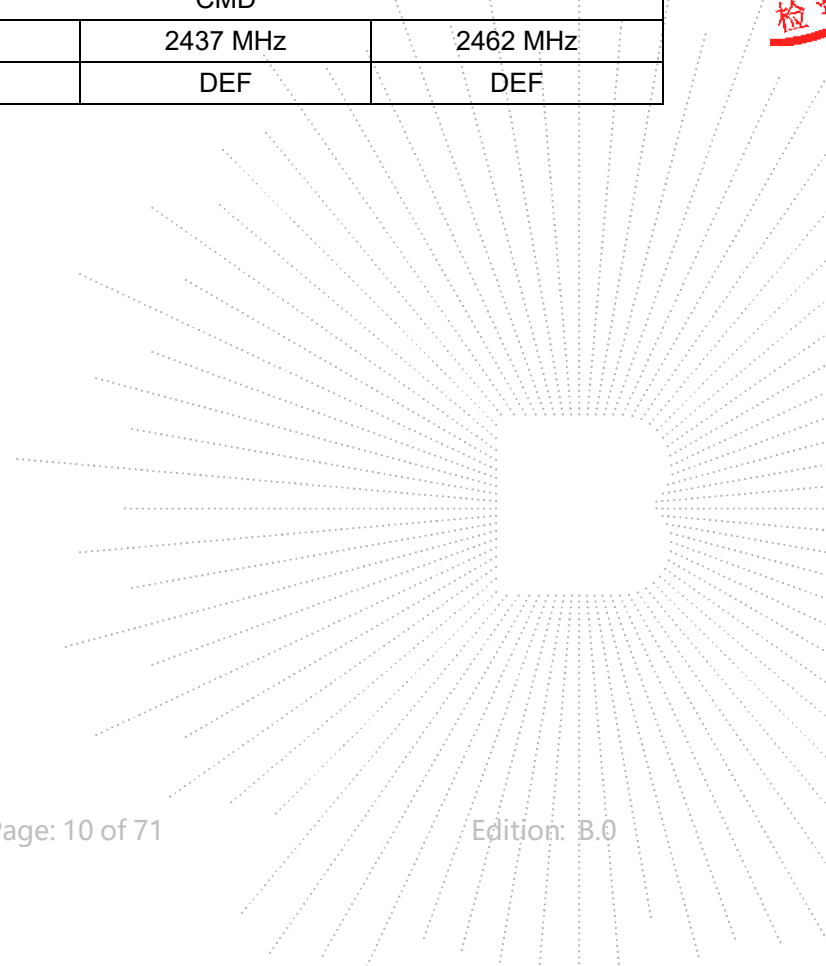

5. Test Facility And Test Instrument Used

5.1 Test Facility

All measurement facilities used to collect the measurement data are located at Shenzhen BCTC Testing Co., Ltd. Address: 1-2/F., Building B, Pengzhou Industrial Park, No.158, Fuyuan 1st Road, Tangwei, Fuhai Subdistrict, Bao'an District, Shenzhen, Guangdong, China. The site and apparatus are constructed in conformance with the requirements of ANSI C63.4 and CISPR 16-1-1 other equivalent standards.

FCC Test Firm Registration Number: 712850

A2LA certificate registration number is: CN1212

ISED Registered No.: 23583

ISED CAB identifier: CN0017

5.2 Test Instrument Used

Conducted Emissions Test					
Equipment	Manufacturer	Model#	Serial#	Last Cal.	Next Cal.
Receiver	R&S	ESR3	102075	May 15, 2023	May 14, 2024
LISN	R&S	ENV216	101375	May 15, 2023	May 14, 2024
Software	Frad	EZ-EMC	EMC-CON 3A1	\	\
Attenuator	\	10dB DC-6GHz	1650	May 15, 2023	May 14, 2024

RF Conducted Test					
Equipment	Manufacturer	Model#	Serial#	Last Cal.	Next Cal.
Power Meter	Keysight	E4419	\	May 15, 2023	May 14, 2024
Power Sensor (AV)	Keysight	E9300A	\	May 15, 2023	May 14, 2024
Signal Analyzer20kHz- z-26.5GHz	Keysight	N9020A	MY49100060	May 15, 2023	May 14, 2024
Spectrum Analyzer9kHz- 40GHz	R&S	FSP40	100363	May 15, 2023	May 14, 2024
Radio frequency control box	MAIWEI	MW100-RFC B	\	\	\
Software	MAIWEI	MTS 8310	\	\	\

Radiated Emissions Test (966 Chamber01)					
Equipment	Manufacturer	Model#	Serial#	Last Cal.	Next Cal.
966 chamber	ChengYu	966 Room	966	May 15, 2023	May 14, 2026
Receiver	R&S	ESR3	102075	May 15, 2023	May 14, 2024
Receiver	R&S	ESRP	101154	May 15, 2023	May 14, 2024
Amplifier	Schwarzbeck	BBV9744	9744-0037	May 15, 2023	May 14, 2024
TRILOG Broadband Antenna	Schwarzbeck	VULB9163	942	May 29, 2023	May 28, 2024
Loop Antenna(9KHz -30MHz)	Schwarzbeck	FMZB1519B	00014	May 31, 2023	May 30, 2024
Amplifier	SKET	LAPA_01G18 G-45dB	\	May 15, 2023	May 14, 2024
Horn Antenna	Schwarzbeck	BBHA9120D	1541	May 31, 2023	May 30, 2024
Amplifier(18G Hz-40GHz)	MITEQ	TTA1840-35-HG	2034381	May 15, 2023	May 14, 2024
Horn Antenna(18G Hz-40GHz)	Schwarzbeck	BBHA9170	00822	May 31, 2023	May 30, 2024
Spectrum Analyzer9kHz-40GHz	R&S	FSP40	100363	May 15, 2023	May 14, 2024
Software	Frad	EZ-EMC	FA-03A2 RE	\	\

CO., LTD.

6. Conducted Emissions

6.1 Block Diagram Of Test Setup

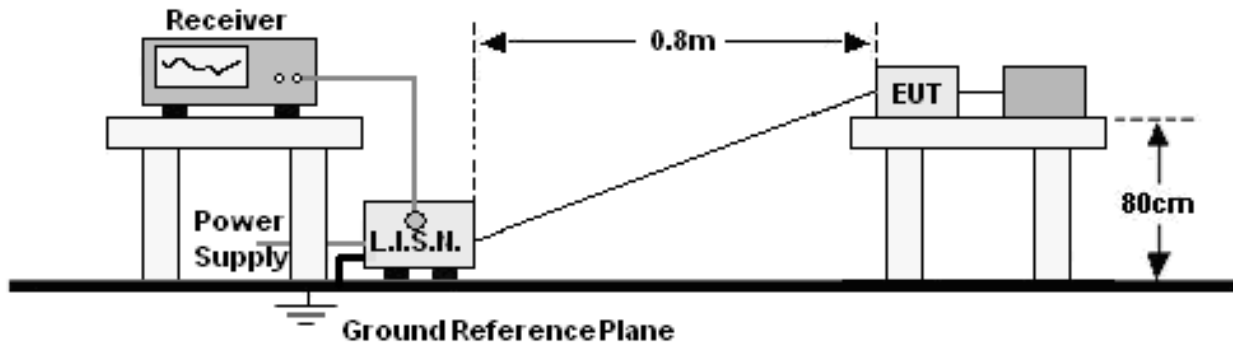

6.2 Limit

FREQUENCY (MHz)	Limit (dBuV)	
	Quas-peak	Average
0.15 -0.5	66 - 56 *	56 - 46 *
0.50 -5.0	56.00	46.00
5.0 -30.0	60.00	50.00

Notes:
 1. *Decreasing linearly with logarithm of frequency.
 2. The lower limit shall apply at the transition frequencies.

6.3 Test Procedure

Receiver Parameters	Setting
Attenuation	10 dB
Start Frequency	0.15 MHz
Stop Frequency	30 MHz
IF Bandwidth	9 kHz

- The Product was placed on a nonconductive table 0.8 m above the horizontal ground reference plane, and 0.4 m from the vertical ground reference plane, and connected to the main through Line Impedance Stability Network (L.I.S.N).
- The RBW of the receiver was set at 9 kHz in 150 kHz ~ 30MHz with Peak and AVG detector in Max Hold mode. Run the receiver's pre-scan to record the maximum disturbance generated from Product in all power lines in the full band.
- For each frequency whose maximum record was higher or close to limit, measure its QP and AVG values and record.

6.4 EUT Operating Conditions

The EUT was configured for testing in a typical fashion (as a customer would normally use it). The EUT has been programmed to continuously transmit during test. This operating condition was tested and used to collect the included data.

6.5 Test Result

Temperature:	26 °C	Relative Humidity:	54%
Pressure:	101kPa	Phase :	Line
Test Voltage :	AC 120V/60Hz	Test Mode:	Mode 4

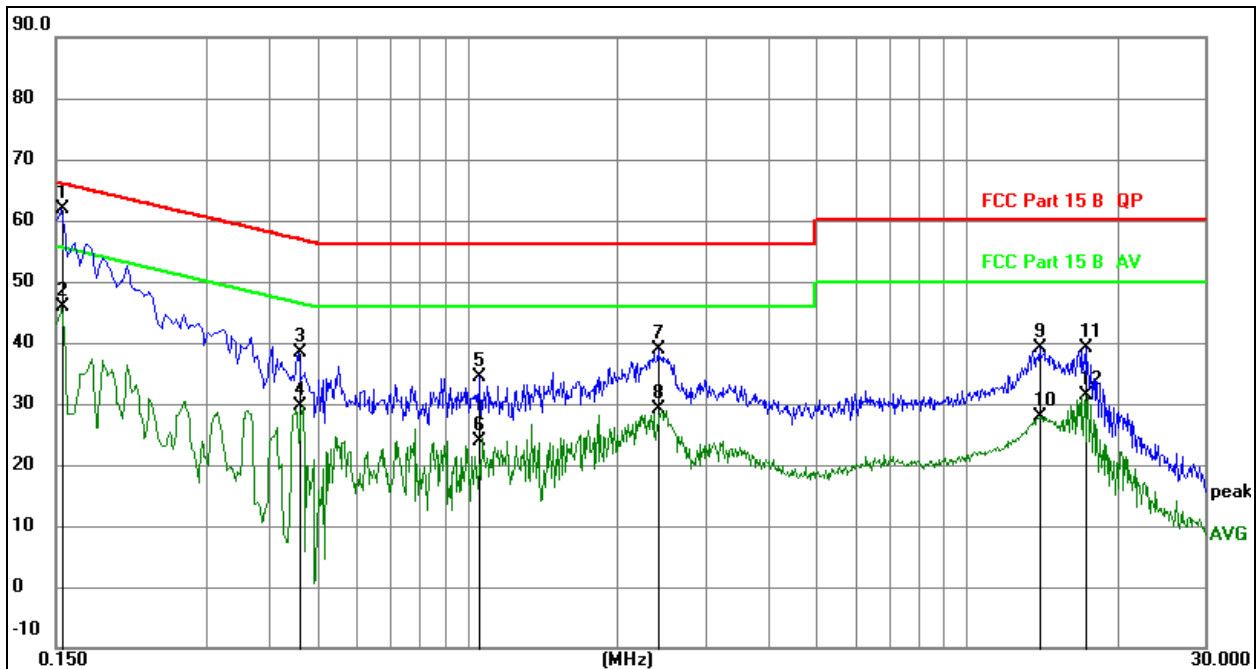

Remark:

1. All readings are Quasi-Peak and Average values.
2. Factor = Insertion Loss + Cable Loss.
3. Measurement=Reading Level+ Correct Factor
4. Over=Measurement-Limit

No.	Mk.	Freq. MHz	Reading Level	Correct Factor dB	Measure- ment dBuV	Limit dBuV	Over dB	Detector
1	*	0.1545	52.30	9.52	61.82	65.75	-3.93	QP
2		0.1545	36.26	9.52	45.78	55.75	-9.97	AVG
3		0.4605	28.69	9.62	38.31	56.68	-18.37	QP
4		0.4605	20.09	9.62	29.71	46.68	-16.97	AVG
5		1.0590	24.61	9.73	34.34	56.00	-21.66	QP
6		1.0590	14.05	9.73	23.78	46.00	-22.22	AVG
7		2.4090	29.21	9.75	38.96	56.00	-17.04	QP
8		2.4090	19.35	9.75	29.10	46.00	-16.90	AVG
9		14.0325	29.53	9.66	39.19	60.00	-20.81	QP
10		14.0325	18.32	9.66	27.98	50.00	-22.02	AVG
11		17.3805	29.31	9.72	39.03	60.00	-20.97	QP
12		17.3805	21.70	9.72	31.42	50.00	-18.58	AVG

Temperature:	26 °C	Relative Humidity:	54%
Pressure:	101kPa	Phase :	Neutral
Test Voltage :	AC 120V/60Hz	Test Mode:	Mode 4

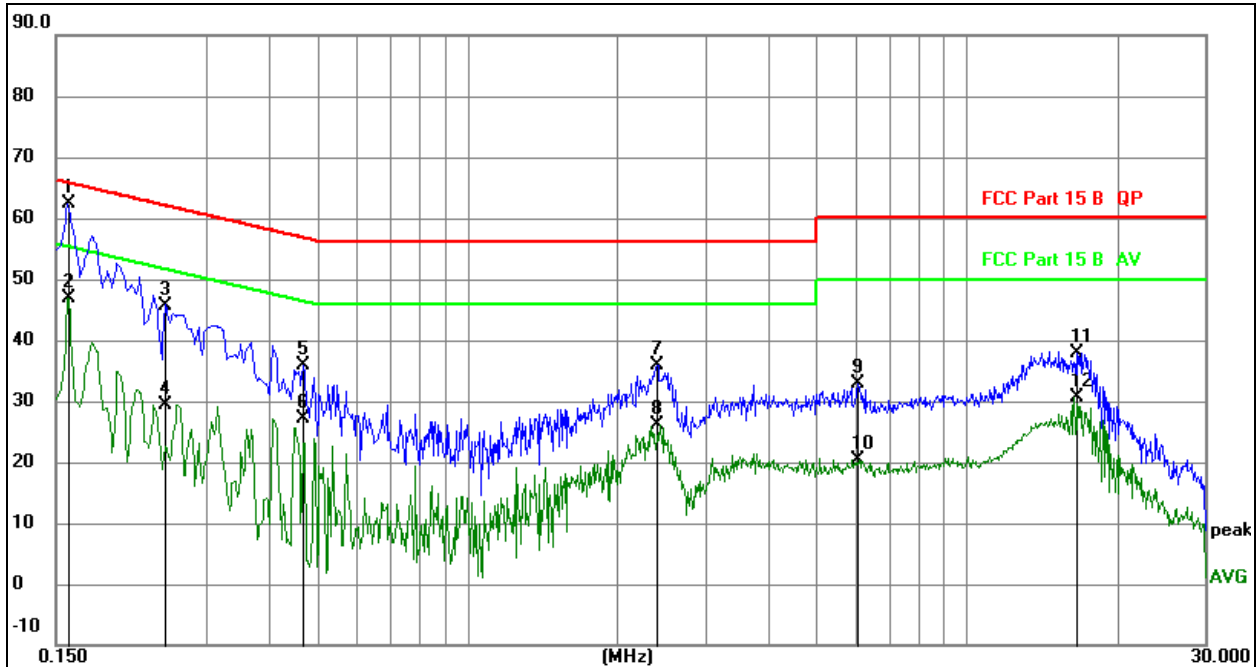
Remark:

1. All readings are Quasi-Peak and Average values.
2. Factor = Insertion Loss + Cable Loss.
3. Measurement=Reading Level+ Correct Factor
4. Over=Measurement-Limit

No.	Mk.	Freq. MHz	Reading Level	Correct Factor dB	Measure- ment dBuV	Limit dBuV	Over dB	Detector
1	*	0.1582	52.84	9.53	62.37	65.56	-3.19	QP
2		0.1582	37.35	9.53	46.88	55.56	-8.68	AVG
3		0.2481	36.14	9.61	45.75	61.82	-16.07	QP
4		0.2481	19.84	9.61	29.45	51.82	-22.37	AVG
5		0.4686	26.18	9.62	35.80	56.54	-20.74	QP
6		0.4686	17.42	9.62	27.04	46.54	-19.50	AVG
7		2.3962	26.23	9.75	35.98	56.00	-20.02	QP
8		2.3962	16.26	9.75	26.01	46.00	-19.99	AVG
9		6.0562	23.11	9.77	32.88	60.00	-27.12	QP
10		6.0562	10.73	9.77	20.50	50.00	-29.50	AVG
11		16.5732	28.22	9.70	37.92	60.00	-22.08	QP
12		16.5732	20.93	9.70	30.63	50.00	-19.37	AVG

7. Radiated Emissions

7.1 Block Diagram Of Test Setup

(A) Radiated Emission Test-Up Frequency Below 30MHz

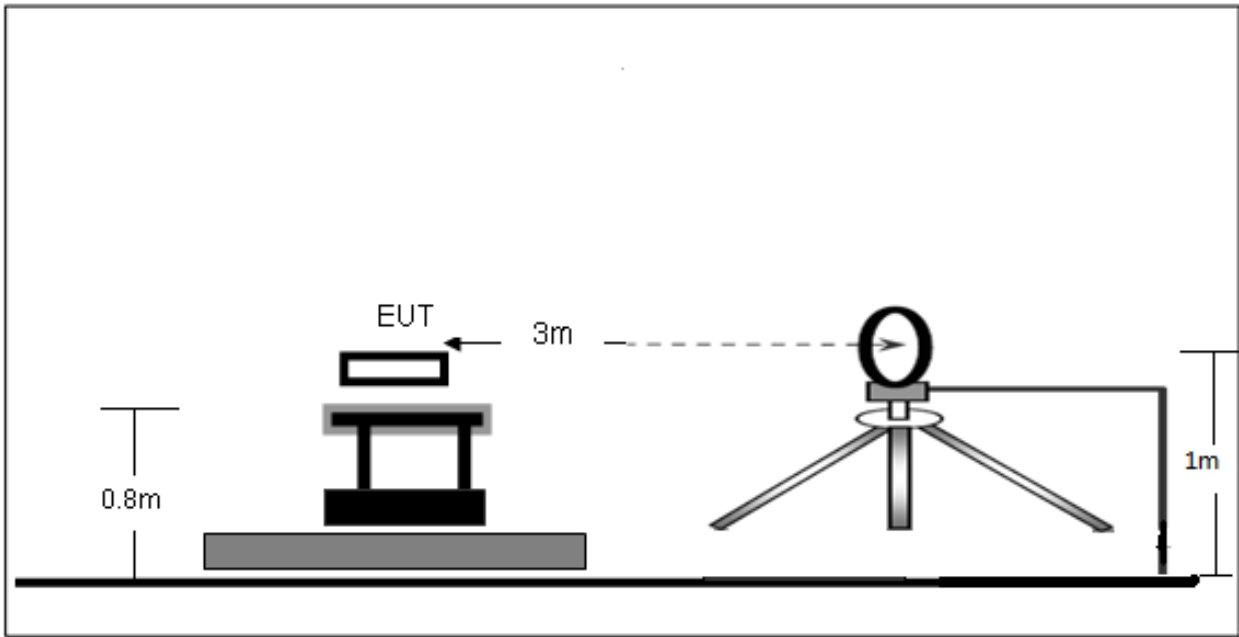

(B) Radiated Emission Test-Up Frequency 30MHz~1GHz

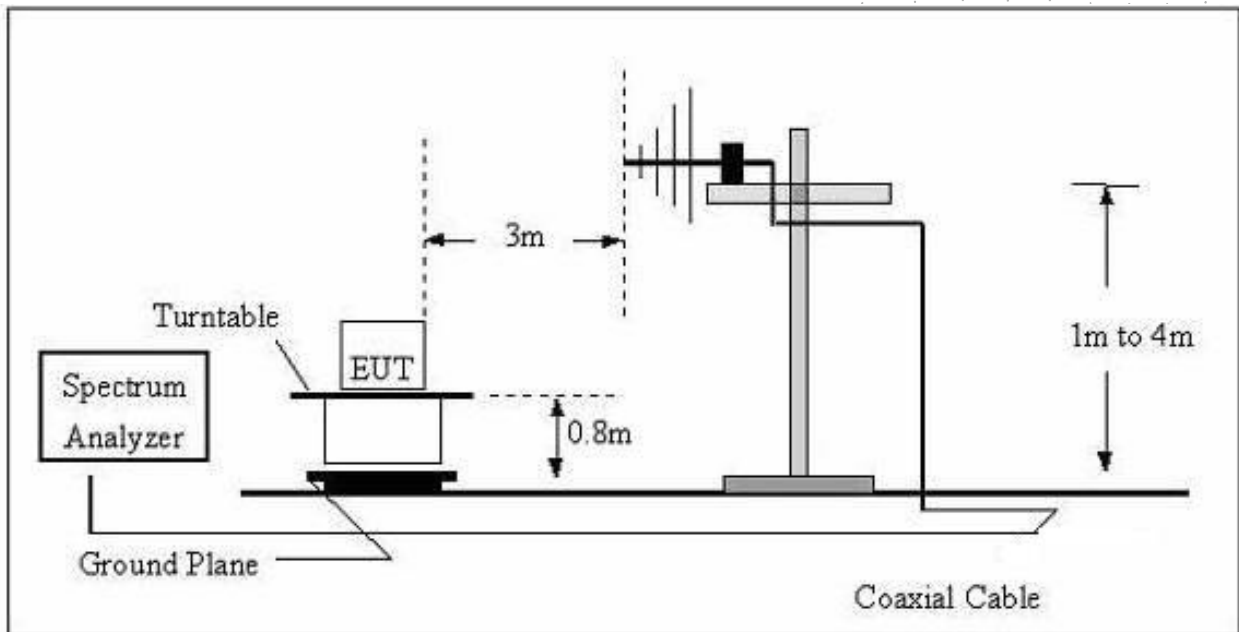

TEC
TC
OVB
检

(C) Radiated Emission Test-Up Frequency Above 1GHz

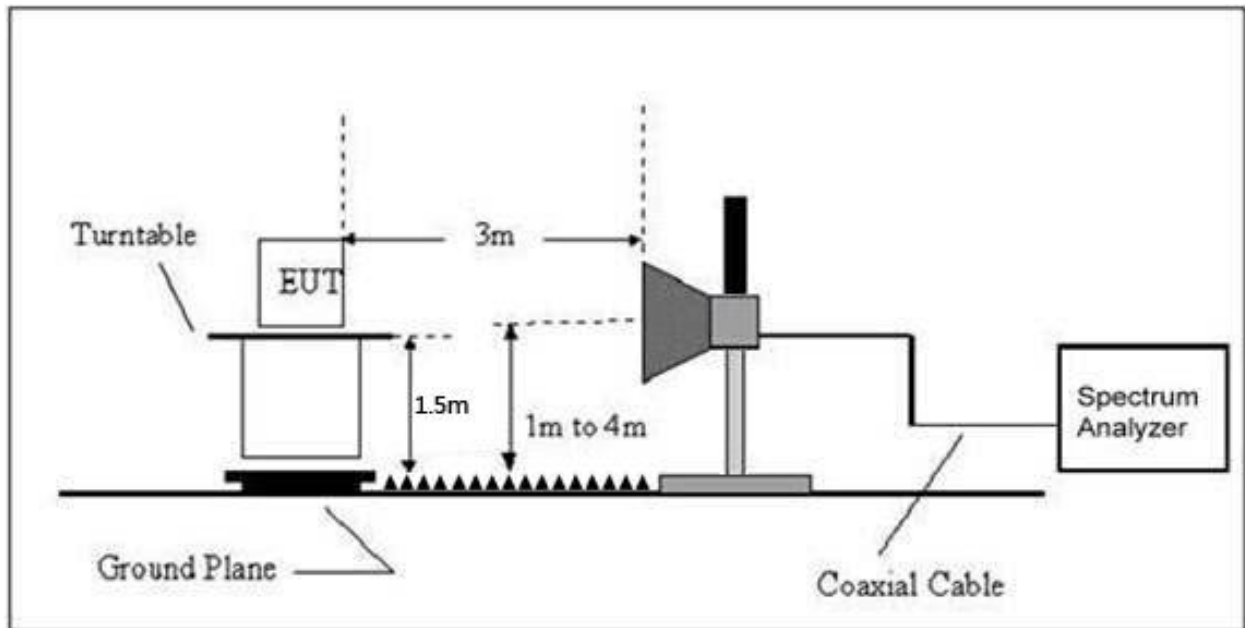

7.2 Limit

20dBc in any 100 kHz bandwidth outside the operating frequency band. In case the emission fall within the restricted band specified on 15.205(a), then the 15.209(a) limit in the table below has to be followed.

Frequency (MHz)	Field Strength uV/m	Distance (m)	Field Strength Limit at 3m Distance	
			uV/m	dBuV/m
0.009 ~ 0.490	2400/F(kHz)	300	10000 * 2400/F(kHz)	$20\log^{(2400/F(kHz))} + 80$
0.490 ~ 1.705	24000/F(kHz)	30	100 * 24000/F(kHz)	$20\log^{(24000/F(kHz))} + 40$
1.705 ~ 30	30	30	100 * 30	$20\log^{(30)} + 40$
30 ~ 88	100	3	100	$20\log^{(100)}$
88 ~ 216	150	3	150	$20\log^{(150)}$
216 ~ 960	200	3	200	$20\log^{(200)}$
Above 960	500	3	500	$20\log^{(500)}$

LIMITS OF RADIATED EMISSION MEASUREMENT (Above 1000MHz)

FREQUENCY (MHz)	Limit (dBuV/m) (at 3M)	
	PEAK	AVERAGE
Above 1000	74	54

Notes:

- (1)The limit for radiated test was performed according to FCC PART 15C.
- (2)The tighter limit applies at the band edges.
- (3) Emission level (dBuV/m)=20log Emission level (uV/m).

FREQUENCY RANGE OF RADIATED MEASUREMENT (For unintentional radiators)

Highest frequency generated or Upper frequency of measurement used in the device or on which the device operates or tunes (MHz)	Range (MHz)
Below 1.705	30
1.705 – 108	1000
108 – 500	2000
500 – 1000	5000
Above 1000	5 th harmonic of the highest frequency or 40 GHz, whichever is lower

7.3 Test Procedure

Receiver Parameter	Setting
Attenuation	Auto
9kHz~150kHz	RBW 200Hz for QP
150kHz~30MHz	RBW 9kHz for QP
30MHz~1000MHz	RBW 120kHz for QP

Spectrum Parameter	Setting
1-25GHz	RBW 1 MHz /VBW 1 MHz for Peak, RBW 1 MHz / VBW 10Hz for Average

Below 1GHz test procedure as below:

- a. The EUT was placed on the top of a rotating table 0.8 meters above the ground at a 3 meter semi-anechoic chamber. The table was rotated 360 degrees to determine the position of the highest radiation.
- b. The EUT was set 3 meters away from the interference-receiving antenna, which was mounted on the top of a variable-height antenna tower.
- c. The antenna height is varied from one meter to four meters above the ground to determine the maximum value of the field strength. Both horizontal and vertical polarizations of the antenna are set to make the measurement.
- d. For each suspected emission, the EUT was arranged to its worst case and then the antenna was tuned to heights from 1 meter to 4 meters (for the test frequency of below 30MHz, the antenna was tuned to heights 1 meter) and the rotatable table was turned from 0 degrees to 360 degrees to find the maximum reading.
- e. The test-receiver system was set to Peak Detect Function and Specified Bandwidth with Maximum Hold Mode.
- f. If the emission level of the EUT in peak mode was 10dB lower than the limit specified, then testing could be stopped and the peak values of the EUT would be reported. Otherwise the emissions that did not have 10dB margin would be re-tested one by one using peak, quasi-peak or average method as specified and then reported in a data sheet.

Above 1GHz test procedure as below:

- g. Different between above is the test site, change from Semi- Anechoic Chamber to fully Anechoic Chamber and change form table 0.8 metre to 1.5 metre(Above 18GHz the distance is 1 meter and table is 1.5 metre).
- h. Test the EUT in the lowest channel ,the middle channel ,the Highest channel.

Note:

Both horizontal and vertical antenna polarities were tested and performed pretest to three orthogonal axis. The worst case emissions were reported.

Above 1GHz test procedure as below:

- a. The EUT was placed on the top of a rotating table 1.5 meters above the ground at a 3 meter chamber. The table was rotated 360 degrees to determine the position of the highest radiation.
- b. The EUT was set 3 meters away from the interference-receiving antenna, which was mounted on the top of a variable-height antenna tower.
- c. The antenna height is varied from one meter to four meters above the ground to determine the maximum value of the field strength. Both horizontal and vertical polarizations of the antenna are set to make the measurement.
- d. For each suspected emission, the EUT was arranged to its worst case and then the antenna was tuned to heights from 1 meter to 4 meters and the rota table was turned from 0 degrees to 360 degrees to find the maximum reading.
- e. The test-receiver system was set to Peak Detect Function and Specified Bandwidth with Maximum Hold Mode.
- f. If the emission level of the EUT in peak mode was 10dB lower than the limit specified, then testing could be stopped and the peak values of the EUT would be reported. Otherwise the emissions that did not have 10dB margin would be re-tested one by one using peak, quasi-peak or average method as specified and then reported in a data sheet.
- g. Test the EUT in the lowest channel, the Highest channel.

Note:

Both horizontal and vertical antenna polarities were tested and performed pretest to three orthogonal axis. The worst case emissions were reported.

7.4 EUT Operating Conditions

The EUT was configured for testing in a typical fashion (as a customer would normally use it). The EUT has been programmed to continuously transmit during test. This operating condition was tested and used to collect the included data.

7.5 Test Result

Below 30MHz

Temperature:	26°C	Relative Humidity:	24%
Pressure:	101 kPa	Test Voltage :	AC 120V/60Hz
Test Mode :	Mode 4	Polarization :	--

Freq. (MHz)	Reading (dBuV/m)	Limit (dBuV/m)	Margin (dB)	State P/F
--	--	--	--	PASS
--	--	--	--	PASS

Note:

The amplitude of spurious emissions which are attenuated by more than 20dB below the permissible value has no need to be reported.

Distance extrapolation factor = $40 \log(\text{specific distance}/\text{test distance})(\text{dB})$;

Limit line = specific limits(dBuv) + distance extrapolation factor.



Between 30MHz – 1GHz

Temperature:	26 °C	Relative Humidity:	54%
Pressure:	101KPa	Phase :	Horizontal
Test Mode:	Mode 4	Remark:	N/A

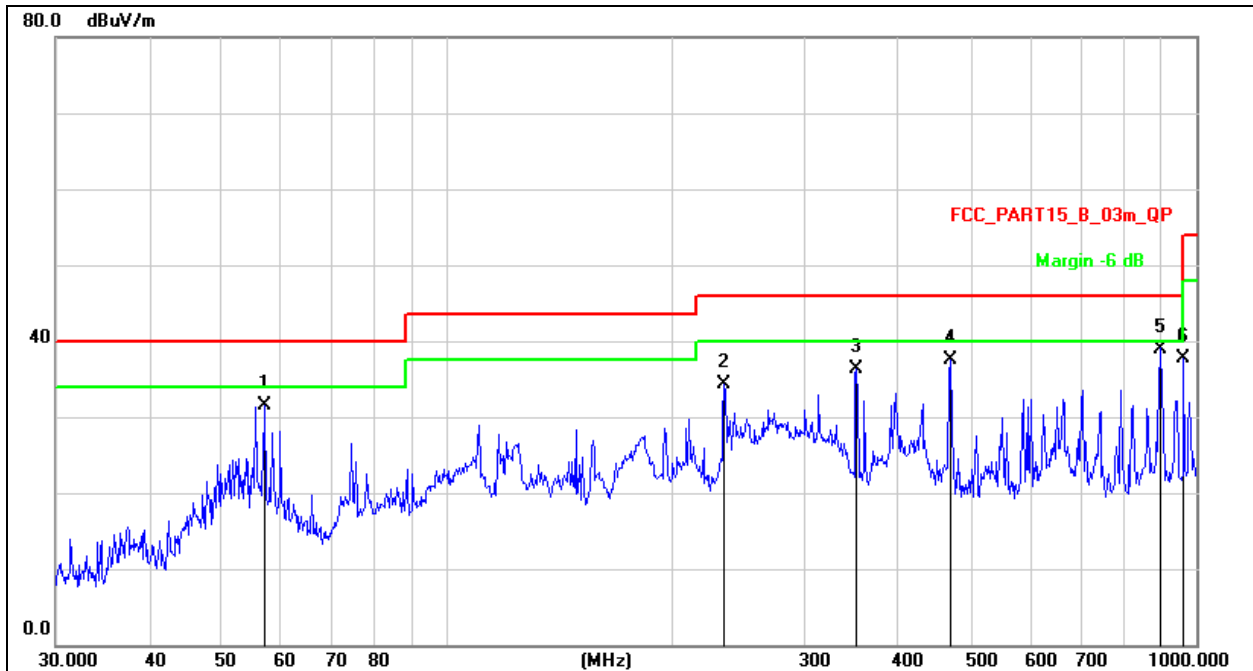

Remark:

1. Factor = Antenna Factor + Cable Loss – Pre-amplifier.
2. Measurement=Reading Level+ Correct Factor
3. Over=Measurement-Limit

No.	Mk.	Freq. MHz	Reading Level dBuV	Correct Factor dB	Measure- ment dBuV/m	Limit dB/m	Over dB	Detector
1		56.9912	48.13	-16.64	31.49	40.00	-8.51	QP
2		234.1684	50.65	-16.32	34.33	46.00	-11.67	QP
3		351.7079	49.07	-12.77	36.30	46.00	-9.70	QP
4		470.5232	48.47	-10.98	37.49	46.00	-8.51	QP
5	*	896.9965	43.62	-4.62	39.00	46.00	-7.00	QP
6		962.1623	41.72	-3.98	37.74	54.00	-16.26	QP

Temperature:	26 °C	Relative Humidity:	54%
Pressure:	101KPa	Phase :	Vertical
Test Mode:	Mode 4	Remark:	N/A

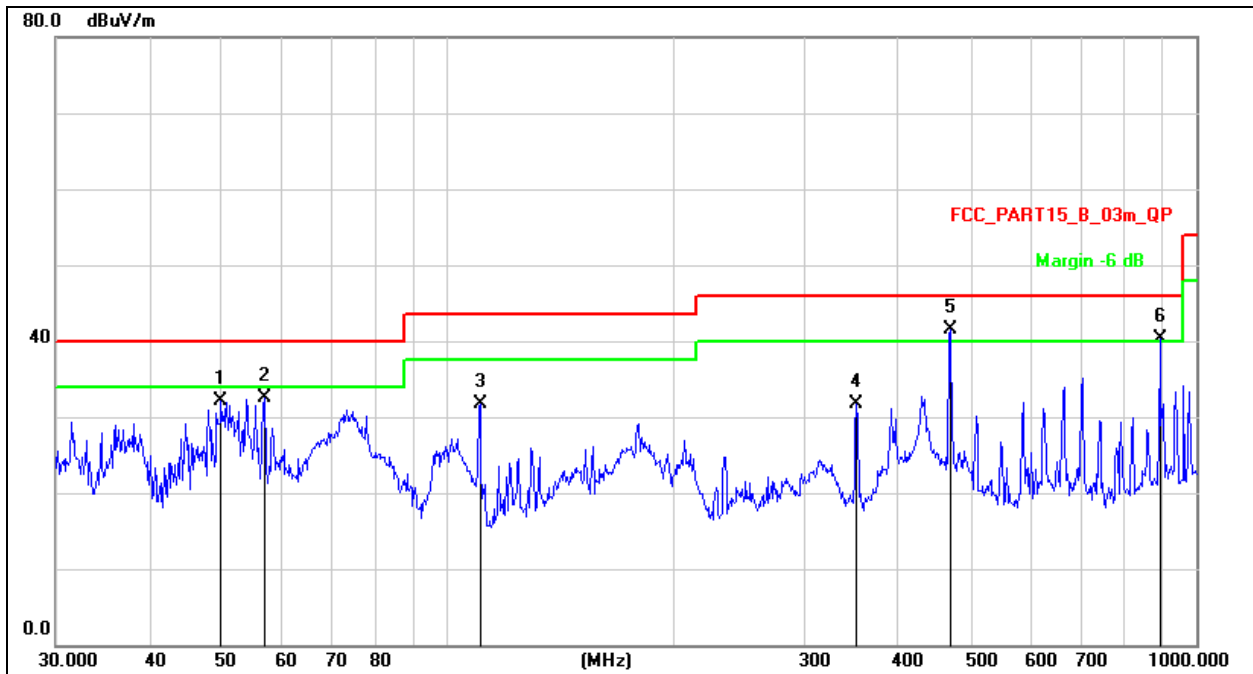

Remark:
 1. Factor = Antenna Factor + Cable Loss – Pre-amplifier.
 2. Measurement=Reading Level+ Correct Factor
 3. Over=Measurement-Limit

No.	Mk.	Freq. MHz	Reading Level dBuV	Correct Factor dB	Measure- ment dBuV/m	Limit dB/m	Over dB	Detector
1		49.8814	47.65	-15.60	32.05	40.00	-7.95	QP
2		56.9912	49.22	-16.64	32.58	40.00	-7.42	QP
3		110.5687	50.09	-18.46	31.63	43.50	-11.87	QP
4		351.7079	44.56	-12.77	31.79	46.00	-14.21	QP
5	*	468.8762	52.45	-11.02	41.43	46.00	-4.57	QP
6	!	893.8567	44.90	-4.66	40.24	46.00	-5.76	QP

BCTC
 3C
 PPR
 检测

Between 1GHz – 25GHz
802.11b

Polar (H/V)	Frequency	Reading Level	Correct Factor	Measure- ment	Limits	Over	Detector Type
	(MHz)	(dBuV/m)	(dB)	(dBuV/m)	(dBuV/ m)	(dB)	
Low channel:2412MHz							
V	4824.00	69.43	-19.95	49.48	74.00	-24.52	PK
V	4824.00	60.80	-19.95	40.85	54.00	-13.15	AV
V	7236.00	59.21	-14.14	45.07	74.00	-28.93	PK
V	7236.00	50.15	-14.14	36.01	54.00	-17.99	AV
H	4824.00	67.71	-19.95	47.76	74.00	-26.24	PK
H	4824.00	57.06	-19.95	37.11	54.00	-16.89	AV
H	7236.00	57.71	-14.14	43.57	74.00	-30.43	PK
H	7236.00	50.46	-14.14	36.32	54.00	-17.68	AV
Middle channel:2437MHz							
V	4874.00	66.18	-19.85	46.33	74.00	-27.67	PK
V	4874.00	57.59	-19.85	37.74	54.00	-16.26	AV
V	7311.00	56.36	-13.93	42.43	74.00	-31.57	PK
V	7311.00	47.54	-13.93	33.61	54.00	-20.39	AV
H	4874.00	63.22	-19.85	43.37	74.00	-30.63	PK
H	4874.00	53.56	-19.85	33.71	54.00	-20.29	AV
H	7311.00	54.55	-13.93	40.62	74.00	-33.38	PK
H	7311.00	45.82	-13.93	31.89	54.00	-22.11	AV
High channel:2462MHz							
V	4924.00	68.93	-19.75	49.18	74.00	-24.82	PK
V	4924.00	60.58	-19.75	40.83	54.00	-13.17	AV
V	7386.00	60.79	-13.72	47.07	74.00	-26.93	PK
V	7386.00	51.64	-13.72	37.92	54.00	-16.08	AV
H	4924.00	66.97	-19.75	47.22	74.00	-26.78	PK
H	4924.00	57.92	-19.75	38.17	54.00	-15.83	AV
H	7386.00	57.83	-13.72	44.11	74.00	-29.89	PK
H	7386.00	50.54	-13.72	36.82	54.00	-17.18	AV

Remark:

1. Emission Level = Meter Reading + Factor,
Factor = Antenna Factor + Cable Loss – Pre-amplifier.
Over = Emission Level - Limit
2. If peak below the average limit, the average emission was no test.
3. In restricted bands of operation, The spurious emissions below the permissible value more than 20dB
4. The amplitude of spurious emissions which are attenuated by more than 20dB below the permissible value has no need to be reported.
5. All the Modulation are test, the worst mode is 802.11b; the data recording in the report.

 TE
 TC
 OV
 检

802.11g

Polar (H/V)	Frequency	Reading Level	Correct Factor	Measure- ment	Limits	Over	Detector Type
	(MHz)	(dBuV/m)	(dB)	(dBuV/m)	(dBuV/ m)	(dB)	
Low channel:2412MHz							
V	4824.00	68.93	-19.95	48.98	74.00	-25.02	PK
V	4824.00	59.76	-19.95	39.81	54.00	-14.19	AV
V	7236.00	59.11	-14.14	44.97	74.00	-29.03	PK
V	7236.00	48.20	-14.14	34.06	54.00	-19.94	AV
H	4824.00	67.76	-19.95	47.81	74.00	-26.19	PK
H	4824.00	57.55	-19.95	37.60	54.00	-16.40	AV
H	7236.00	57.36	-14.14	43.22	74.00	-30.78	PK
H	7236.00	48.57	-14.14	34.43	54.00	-19.57	AV
Middle channel:2437MHz							
V	4874.00	66.94	-19.85	47.09	74.00	-26.91	PK
V	4874.00	58.50	-19.85	38.65	54.00	-15.35	AV
V	7311.00	57.76	-13.93	43.83	74.00	-30.17	PK
V	7311.00	49.30	-13.93	35.37	54.00	-18.63	AV
H	4874.00	65.70	-19.85	45.85	74.00	-28.15	PK
H	4874.00	55.36	-19.85	35.51	54.00	-18.49	AV
H	7311.00	56.36	-13.93	42.43	74.00	-31.57	PK
H	7311.00	48.43	-13.93	34.50	54.00	-19.50	AV
High channel:2462MHz							
V	4924.00	69.62	-19.75	49.87	74.00	-24.13	PK
V	4924.00	59.16	-19.75	39.41	54.00	-14.59	AV
V	7386.00	61.21	-13.72	47.49	74.00	-26.51	PK
V	7386.00	52.04	-13.72	38.32	54.00	-15.68	AV
H	4924.00	67.17	-19.75	47.42	74.00	-26.58	PK
H	4924.00	56.85	-19.75	37.10	54.00	-16.90	AV
H	7386.00	60.10	-13.72	46.38	74.00	-27.62	PK
H	7386.00	52.04	-13.72	38.32	54.00	-15.68	AV

Remark:

1. Emission Level = Meter Reading + Factor,
Factor = Antenna Factor + Cable Loss – Pre-amplifier.
Over = Emission Level - Limit
2. If peak below the average limit, the average emission was no test.
3. In restricted bands of operation, The spurious emissions below the permissible value more than 20dB
4. The amplitude of spurious emissions which are attenuated by more than 20dB below the permissible value has no need to be reported.
5. All the Modulation are test, the worst mode is 802.11b, the data recording in the report.



802.11n20

Polar (H/V)	Frequency	Reading Level	Correct Factor	Measure- ment	Limits	Over	Detector Type
	(MHz)	(dBuV/m)	(dB)	(dBuV/m)	(dBuV/ m)	(dB)	
Low channel:2412MHz							
V	4824.00	68.20	-19.95	48.25	74.00	-25.75	PK
V	4824.00	60.09	-19.95	40.14	54.00	-13.86	AV
V	7236.00	58.82	-14.14	44.68	74.00	-29.32	PK
V	7236.00	49.73	-14.14	35.59	54.00	-18.41	AV
H	4824.00	66.39	-19.95	46.44	74.00	-27.56	PK
H	4824.00	56.48	-19.95	36.53	54.00	-17.47	AV
H	7236.00	56.83	-14.14	42.69	74.00	-31.31	PK
H	7236.00	48.80	-14.14	34.66	54.00	-19.34	AV
Middle channel:2437MHz							
V	4874.00	66.60	-19.85	46.75	74.00	-27.25	PK
V	4874.00	59.48	-19.85	39.63	54.00	-14.37	AV
V	7311.00	56.21	-13.93	42.28	74.00	-31.72	PK
V	7311.00	46.92	-13.93	32.99	54.00	-21.01	AV
H	4874.00	64.01	-19.85	44.16	74.00	-29.84	PK
H	4874.00	53.05	-19.85	33.20	54.00	-20.80	AV
H	7311.00	55.14	-13.93	41.21	74.00	-32.79	PK
H	7311.00	47.00	-13.93	33.07	54.00	-20.93	AV
High channel:2462MHz							
V	4924.00	68.07	-19.75	48.32	74.00	-25.68	PK
V	4924.00	58.57	-19.75	38.82	54.00	-15.18	AV
V	7386.00	59.91	-13.72	46.19	74.00	-27.81	PK
V	7386.00	49.59	-13.72	35.87	54.00	-18.13	AV
H	4924.00	66.18	-19.75	46.43	74.00	-27.57	PK
H	4924.00	55.23	-19.75	35.48	54.00	-18.52	AV
H	7386.00	58.16	-13.72	44.44	74.00	-29.56	PK
H	7386.00	49.52	-13.72	35.80	54.00	-18.20	AV

Remark:

1. Emission Level = Meter Reading + Factor,
Factor = Antenna Factor + Cable Loss – Pre-amplifier.
Over = Emission Level - Limit
2. If peak below the average limit, the average emission was no test.
3. In restricted bands of operation, The spurious emissions below the permissible value more than 20dB
4. The amplitude of spurious emissions which are attenuated by more than 20dB below the permissible value has no need to be reported.
5. All the Modulation are test, the worst mode is 802.11b, the data recording in the report.

8. Radiated Band Emission Measurement And Restricted Bands Of Operation

8.1 Block Diagram Of Test Setup

Radiated Emission Test-Up Frequency Above 1GHz

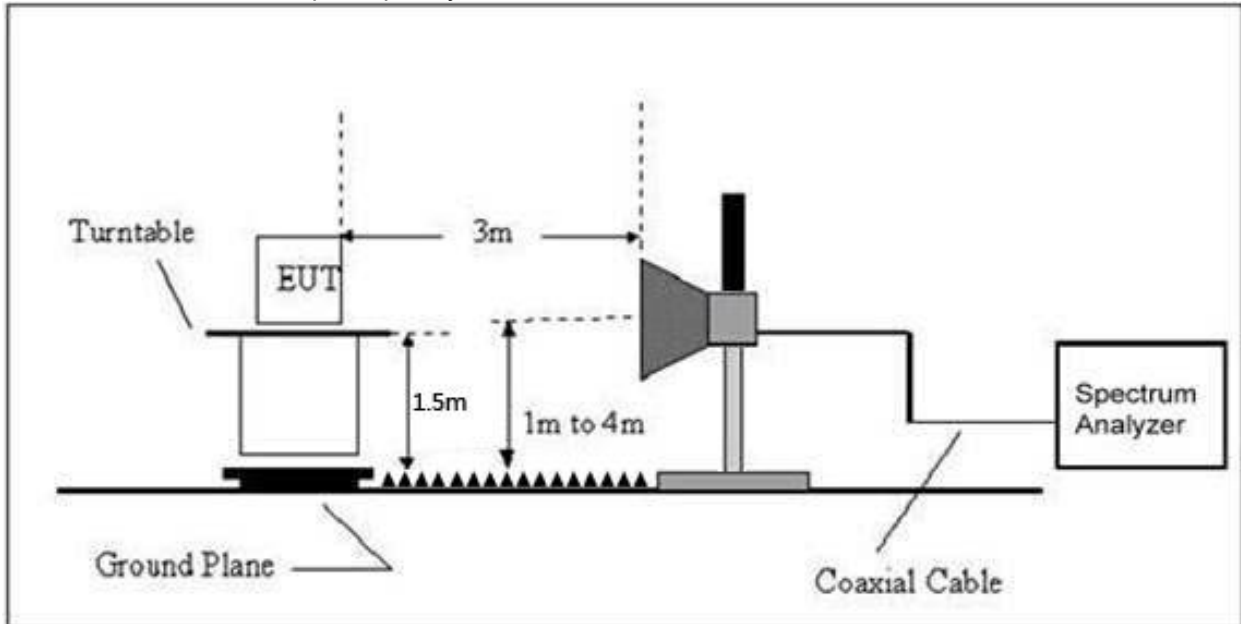

8.2 Limit

FCC Part15 C Section 15.209 and 15.205

(a) Except as shown in paragraph (d) of this section, only spurious emissions are permitted in any of the frequency bands listed below:

MHz	MHz	MHz	GHz
0.090-0.110	16.42-16.423	399.9-410	4.5-5.15
0.495-0.505	16.69475-16.69525	608-614	5.35-5.46
2.1735-2.1905	16.80425-16.80475	960-1240	7.25-7.75
4.125-4.128	25.5-25.67	1300-1427	8.025-8.5
4.17725-4.17775	37.5-38.25	1435-1626.5	9.0-9.2
4.20725-4.20775	73-74.6	1645.5-1646.5	9.3-9.5
6.215-6.218	74.8-75.2	1660-1710	10.6-12.7
6.26775-6.26825	108-121.94	1718.8-1722.2	13.25-13.4
6.31175-6.31225	123-138	2200-2300	14.47-14.5
8.291-8.294	149.9-150.05	2310-2390	15.35-16.2
8.362-8.366	156.52475-156.52525	2483.5-2500	17.7-21.4
8.37625-8.38675	156.7-156.9	2690-2900	22.01-23.12
8.41425-8.41475	162.0125-167.17	3260-3267	23.6-24.0
12.29-12.293	167.72-173.2	3332-3339	31.2-31.8
12.51975-12.52025	240-285	3345.8-3358	36.43-36.5
12.57675-12.57725	322-335.4	3600-4400	(²)
13.36-13.41			

LIMITS OF RADIATED EMISSION MEASUREMENT (Above 1000MHz)

FREQUENCY (MHz)	Limit (dBuV/m) (at 3M)	
	PEAK	AVERAGE
Above 1000	74	54

Notes:

- (1)The limit for radiated test was performed according to FCC PART 15C.
- (2)The tighter limit applies at the band edges.
- (3)Emission level (dBuV/m)=20log Emission level (uV/m).

8.3 Test Procedure

Receiver Parameter	Setting
Attenuation	Auto
Start Frequency	2300MHz
Stop Frequency	2520
RB / VB (emission in restricted band)	1 MHz / 1 MHz for Peak, 1 MHz / 10Hz for Average

Above 1GHz test procedure as below:

- a. The EUT was placed on the top of a rotating table 1.5 meters above the ground at a 3 meter chamber. The table was rotated 360 degrees to determine the position of the highest radiation.
- b. The EUT was set 3 meters away from the interference-receiving antenna, which was mounted on the top of a variable-height antenna tower.
- c. The antenna height is varied from one meter to four meters above the ground to determine the maximum value of the field strength. Both horizontal and vertical polarizations of the antenna are set to make the measurement.
- d. For each suspected emission, the EUT was arranged to its worst case and then the antenna was tuned to heights from 1 meter to 4 meters and the rota table was turned from 0 degrees to 360 degrees to find the maximum reading.
- e. The test-receiver system was set to Peak Detect Function and Specified Bandwidth with Maximum Hold Mode.
- f. If the emission level of the EUT in peak mode was 10dB lower than the limit specified, then testing could be stopped and the peak values of the EUT would be reported. Otherwise the emissions that did not have 10dB margin would be re-tested one by one using peak, quasi-peak or average method as specified and then reported in a data sheet.
- g. Test the EUT in the lowest channel, the Highest channel.

Note:

Both horizontal and vertical antenna polarities were tested and performed pretest to three orthogonal axis. The worst case emissions were reported.

8.4 EUT Operating Conditions

The EUT was configured for testing in a typical fashion (as a customer would normally use it). The EUT has been programmed to continuously transmit during test. This operating condition was tested and used to collect the included data.



8.5 Test Result

	Polar (H/V)	Frequency (MHz)	Reading Level (dBuV/m)	Correct Factor (dB)	Measurement (dBuV/m)	Limits (dBuV/m)		Result
					PK	PK	AV	
802.11b	Low Channel 2412MHz							
	H	2390.00	70.77	-25.43	45.34	74.00	54.00	PASS
	H	2400.00	77.05	-25.40	51.65	74.00	54.00	PASS
	V	2390.00	71.47	-25.43	46.04	74.00	54.00	PASS
	V	2400.00	76.60	-25.40	51.20	74.00	54.00	PASS
	High Channel 2462MHz							
	H	2483.50	70.98	-25.15	45.83	74.00	54.00	PASS
	H	2500.00	62.71	-25.10	37.61	74.00	54.00	PASS
	V	2483.50	71.86	-25.15	46.71	74.00	54.00	PASS
	V	2500.00	63.99	-25.10	38.89	74.00	54.00	PASS
802.11g	Low Channel 2412MHz							
	H	2390.00	64.44	-25.43	39.01	74.00	54.00	PASS
	H	2400.00	75.15	-25.40	49.75	74.00	54.00	PASS
	V	2390.00	65.03	-25.43	39.60	74.00	54.00	PASS
	V	2400.00	74.65	-25.40	49.25	74.00	54.00	PASS
	High Channel 2462MHz							
	H	2483.50	64.35	-25.15	39.20	74.00	54.00	PASS
	H	2500.00	60.81	-25.10	35.71	74.00	54.00	PASS
	V	2483.50	64.97	-25.15	39.82	74.00	54.00	PASS
	V	2500.00	61.14	-25.10	36.04	74.00	54.00	PASS

Remark:

- Emission Level = Meter Reading + Factor,
Factor = Antenna Factor + Cable Loss – Pre-amplifier.
Over= Emission Level – Limit
- If the PK measured levels comply with average limit, then the average level were deemed to comply with average limit.
- In restricted bands of operation, The spurious emissions below the permissible value more than 20dB
- The amplitude of spurious emissions which are attenuated by more than 20dB below the permissible value has no need to be reported.

BCTC
 3C
 PPR
 检测

	Polar (H/V)	Frequency (MHz)	Reading Level (dBuV/m)	Correct Factor (dB)	Measurement (dBuV/m)	Limits (dBuV/m)		Result
					PK	PK	AV	
802.11 n20	Low Channel 2412MHz							
	H	2390.00	70.76	-25.43	45.33	74.00	54.00	PASS
	H	2400.00	77.32	-25.40	51.92	74.00	54.00	PASS
	V	2390.00	70.36	-25.43	44.93	74.00	54.00	PASS
	V	2400.00	75.88	-25.40	50.48	74.00	54.00	PASS
	High Channel 2462MHz							
	H	2483.50	71.20	-25.15	46.05	74.00	54.00	PASS
	H	2500.00	62.62	-25.10	37.52	74.00	54.00	PASS
	V	2483.50	68.65	-25.15	43.50	74.00	54.00	PASS
	V	2500.00	60.94	-25.10	35.84	74.00	54.00	PASS

Remark:

1. Emission Level = Meter Reading + Factor,
Factor = Antenna Factor + Cable Loss – Pre-amplifier.
Over= Emission Level – Limit
2. If the PK measured levels comply with average limit, then the average level were deemed to comply with average limit.
- 3 In restricted bands of operation, The spurious emissions below the permissible value more than 20dB
4. The amplitude of spurious emissions which are attenuated by more than 20dB below the permissible value has no need to be reported.

TEST
 TO
 OVER
 検

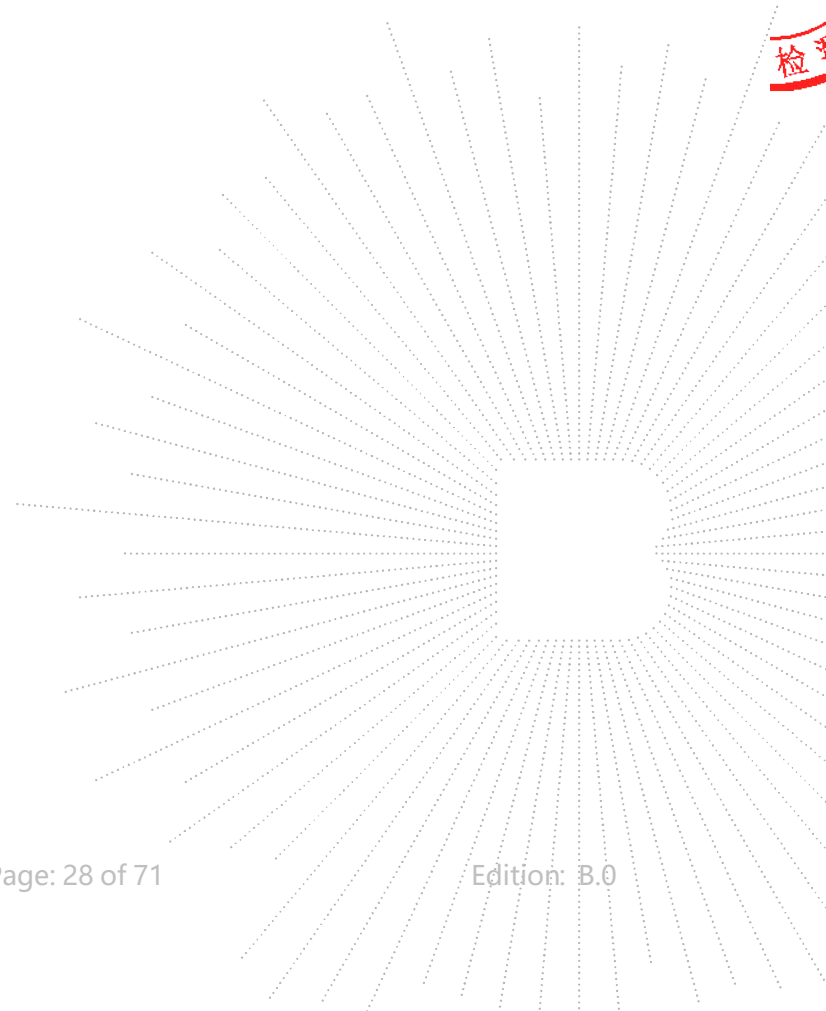

9. Power Spectral Density Test

9.1 Block Diagram Of Test Setup



9.2 Limit

FCC Part15 (15.247) , Subpart C				
Section	Test Item	Limit	Frequency Range (MHz)	Result
15.247	Power Spectral Density	8 dBm (in any 3KHz)	2400-2483.5	PASS

LIMITS OF RADIATED EMISSION MEASUREMENT (Above 1000MHz)

9.3 Test Procedure

1. Set analyzer center frequency to DTS channel center frequency.
2. Set the span to 1.5 times the DTS bandwidth.
3. Set the RBW to: 3 kHz
4. Set the VBW $\geq 3 \times$ RBW.
5. Detector = peak.
6. Sweep time = auto couple.
7. Trace mode = max hold.
8. Allow trace to fully stabilize.
9. Use the peak marker function to determine the maximum amplitude level within the RBW.
10. If measured value exceeds limit, reduce RBW (no less than 3 kHz) and repeat.

9.4 EUT Operating Conditions

The EUT tested system was configured as the statements of 4.6 Unless otherwise a special operating condition is specified in the follows during the testing.

Note: Power Spectral Density(dBm)=Reading+Cable Loss

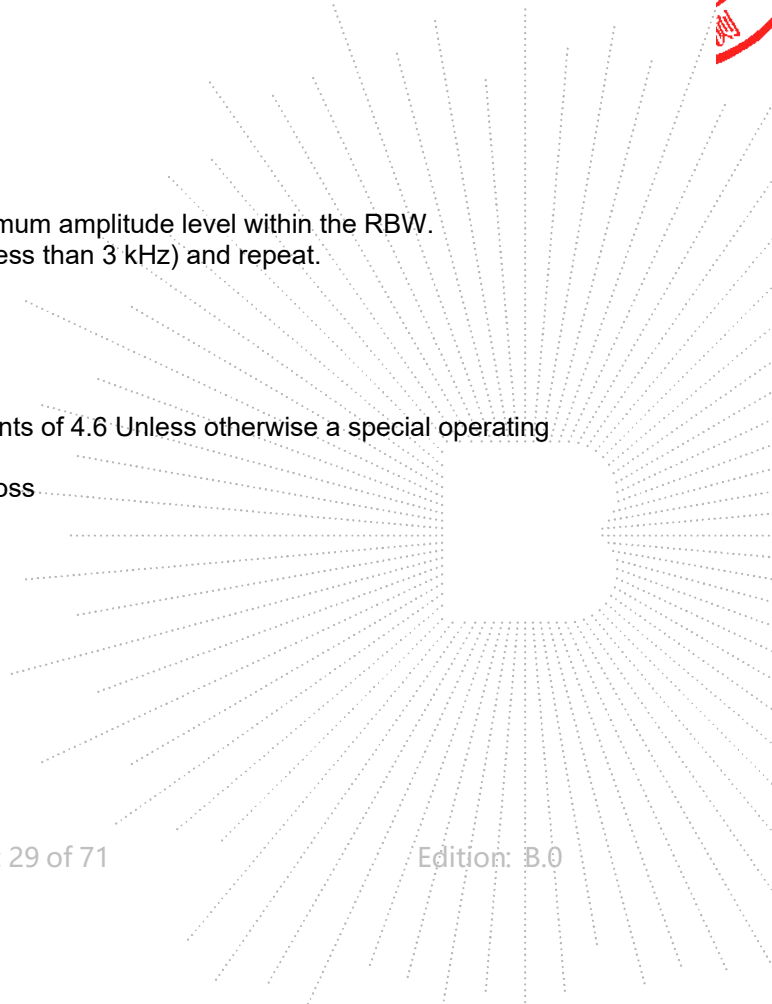

9.5 Test Result

Temperature :	26°C	Relative Humidity :	54%
Pressure :	101kPa	Test Voltage :	DC 12V

Mode	Frequency	Power Spectral Density (dBm/10kHz)	Power Spectral Density (dBm/3kHz)	Limit (dBm/3kHz)	Result
b	2412 MHz	-5.38	-10.61	8	PASS
	2437 MHz	-4.27	-9.50	8	PASS
	2462 MHz	-4.37	-9.60	8	PASS
g	2412 MHz	-8.98	-14.21	8	PASS
	2437 MHz	-7.75	-12.98	8	PASS
	2462 MHz	-7.95	-13.18	8	PASS
N 20	2412 MHz	-9.86	-15.09	8	PASS
	2437 MHz	-8.64	-13.87	8	PASS
	2462 MHz	-9.12	-14.35	8	PASS

Note: Correction Factor = $10\log(3\text{KHz}/\text{RBW in measurement}) = -5.23$

CO., LTD.

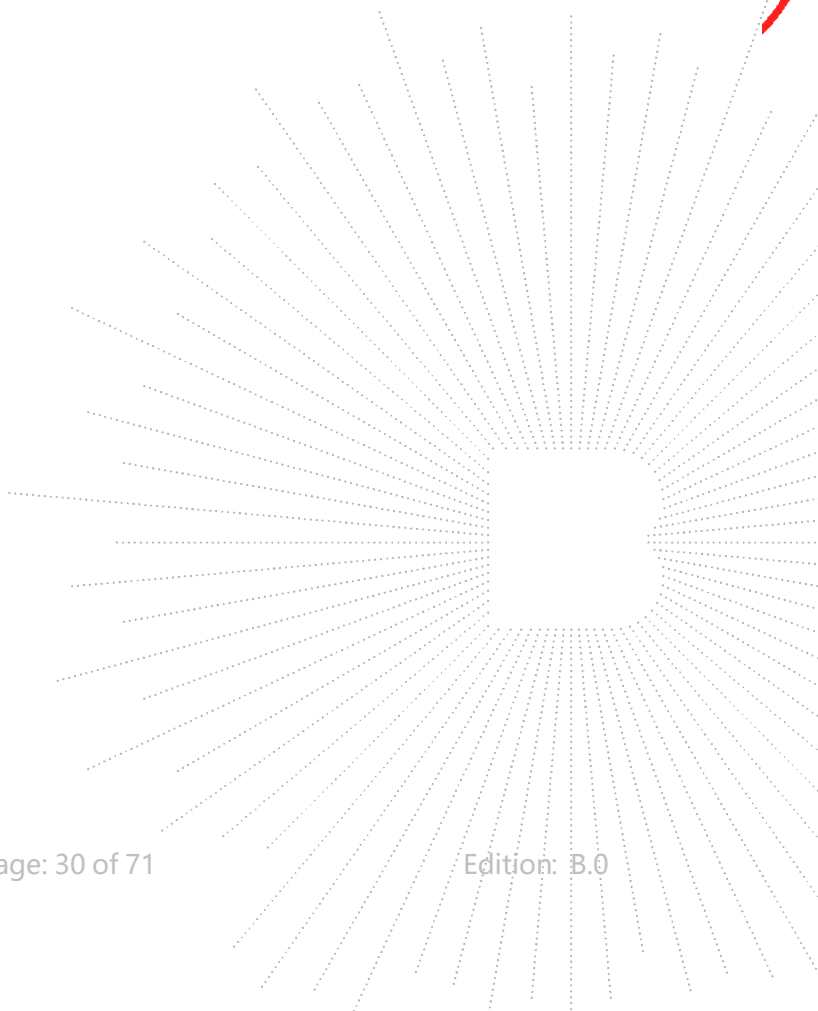

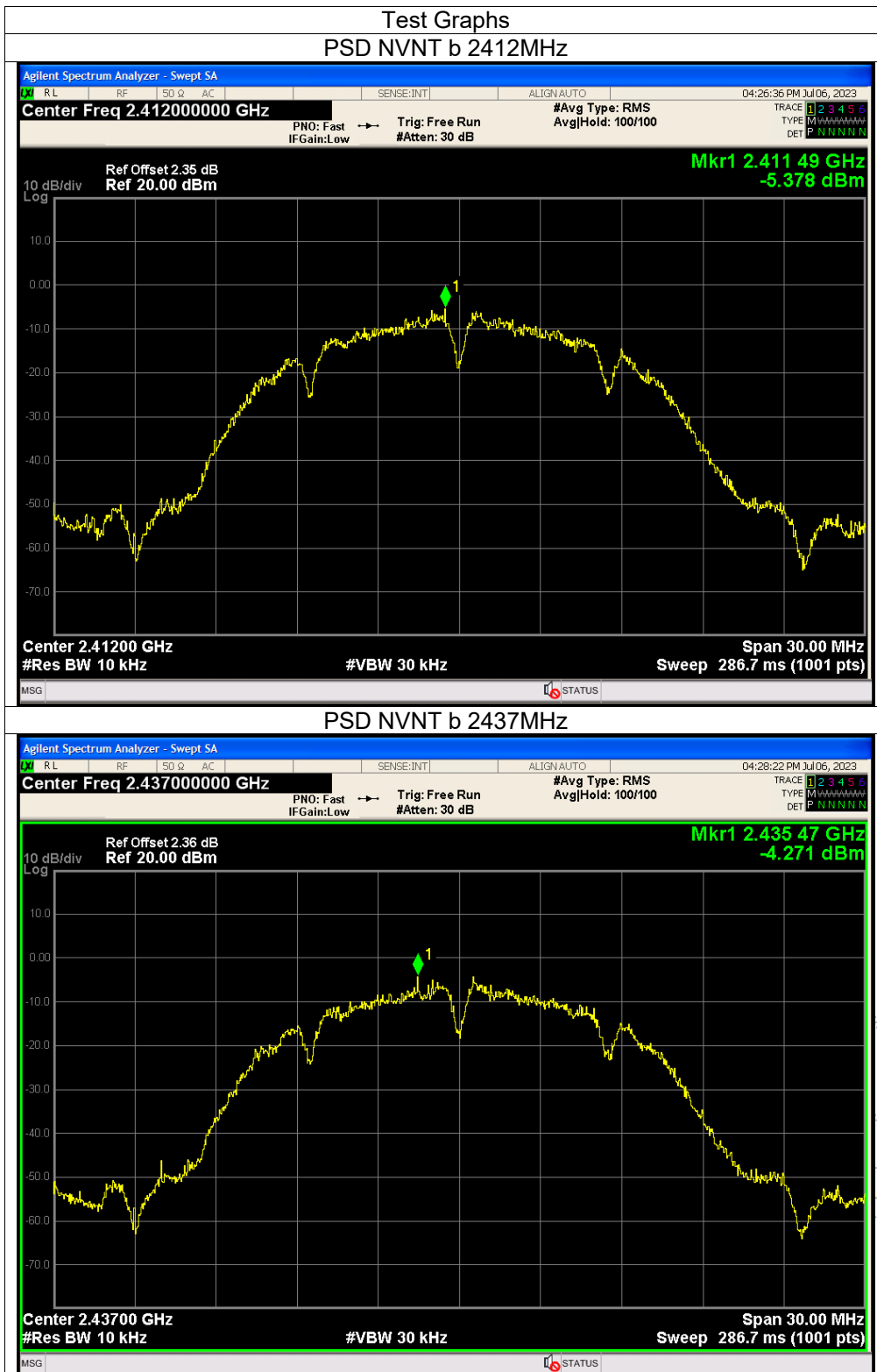

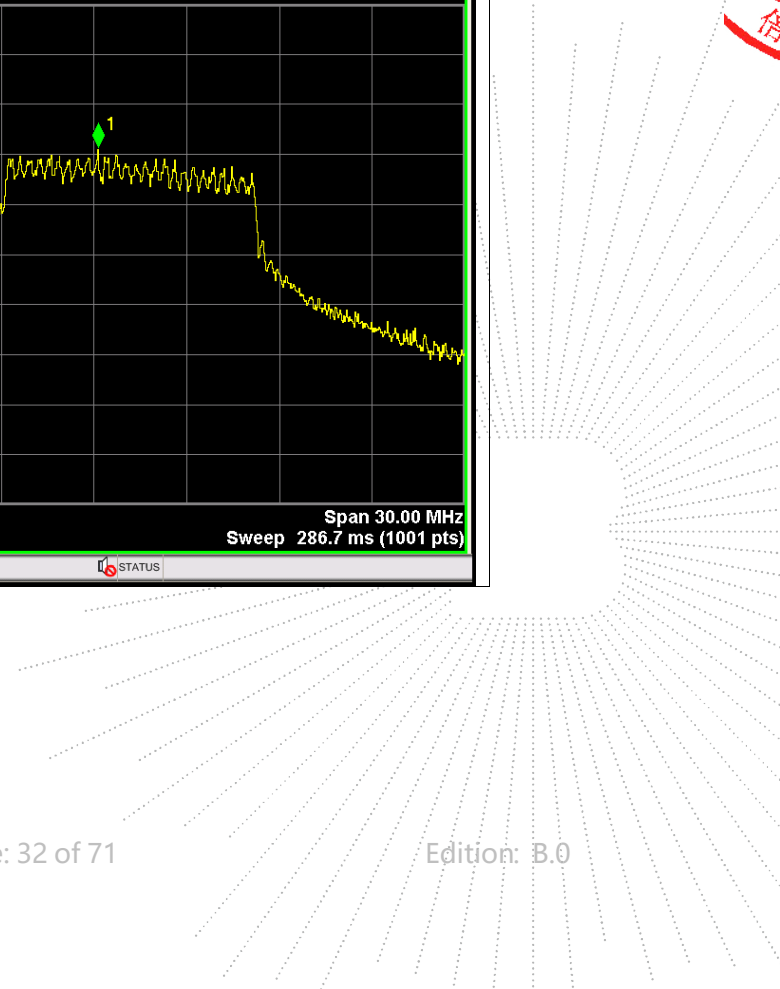
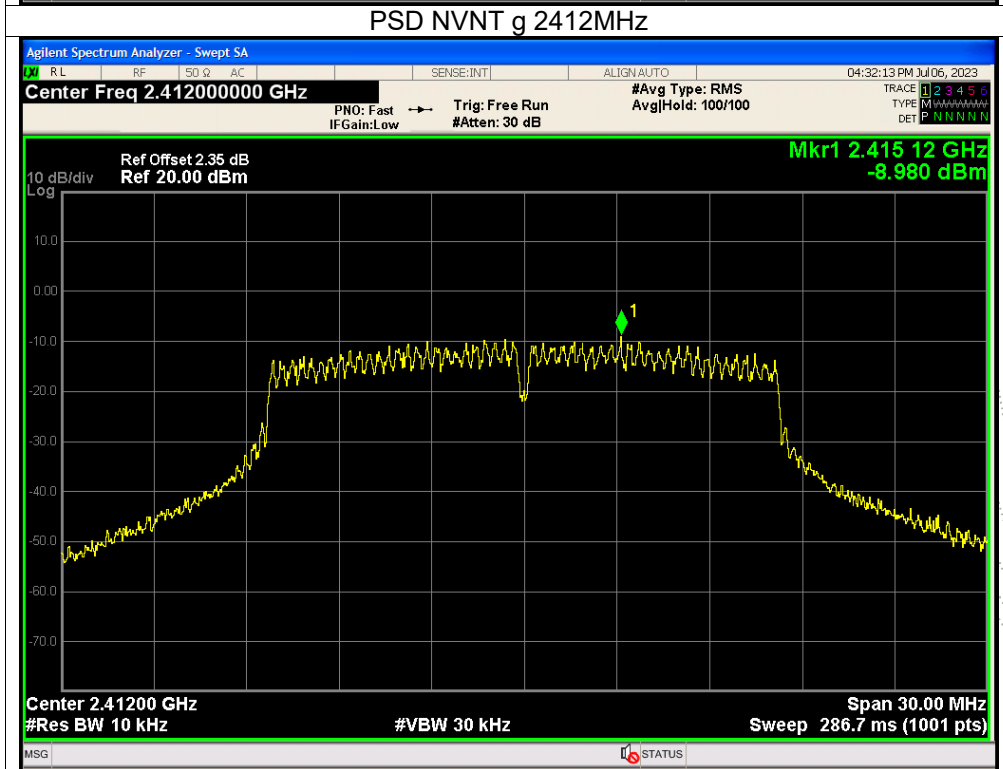
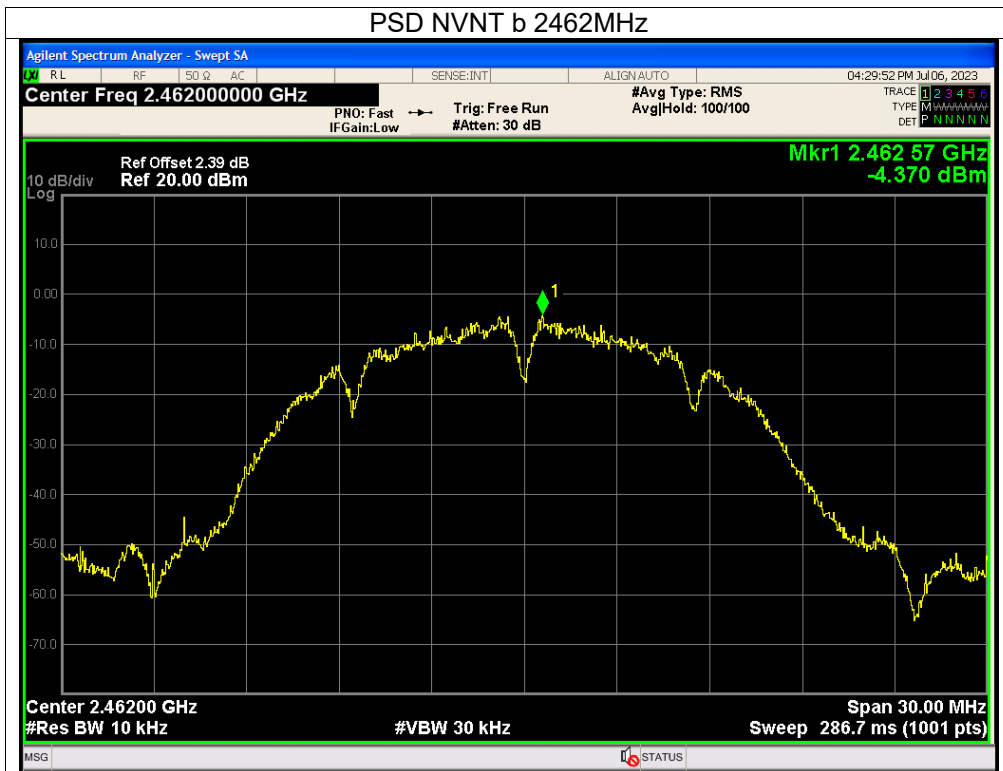

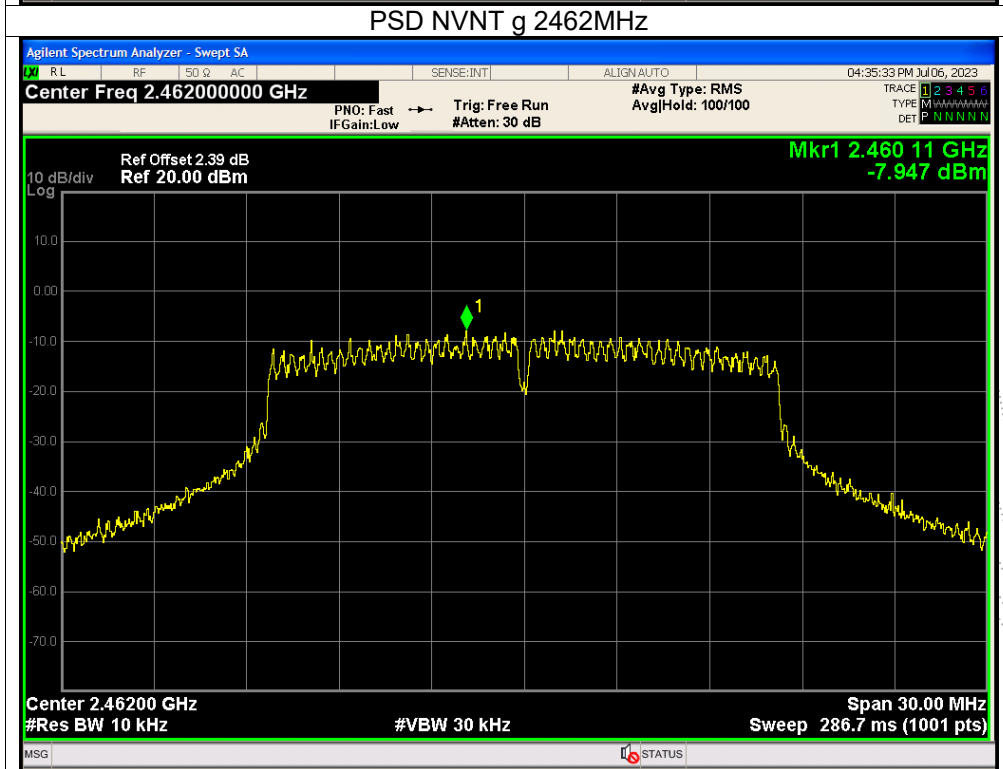
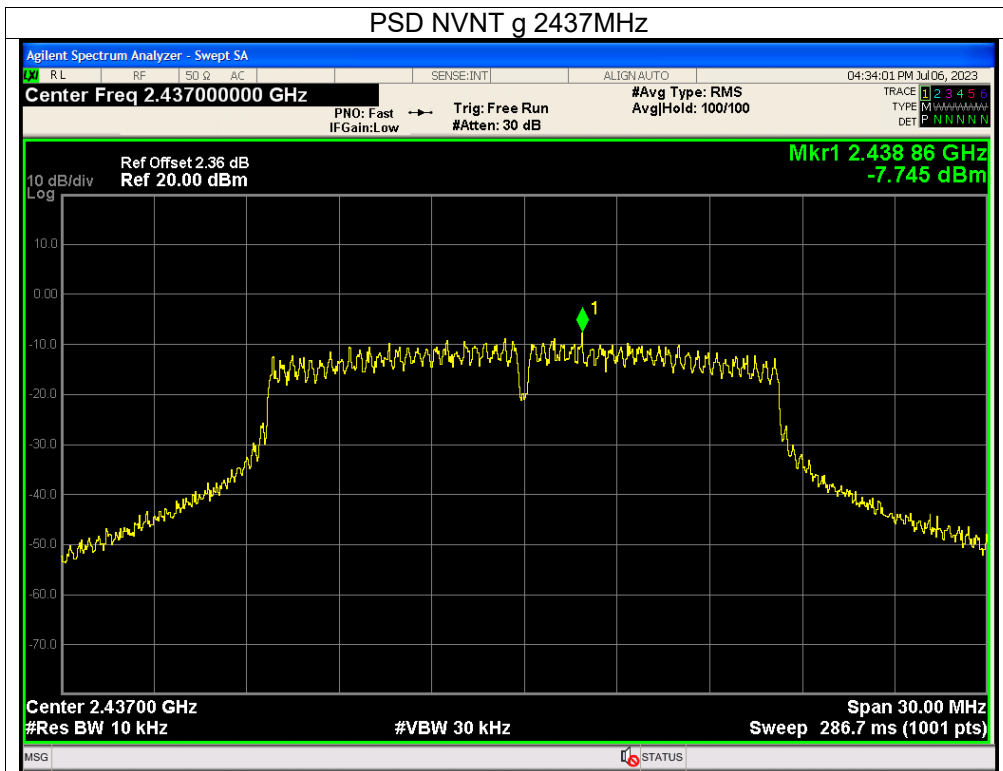

TC
3C
PPR
測

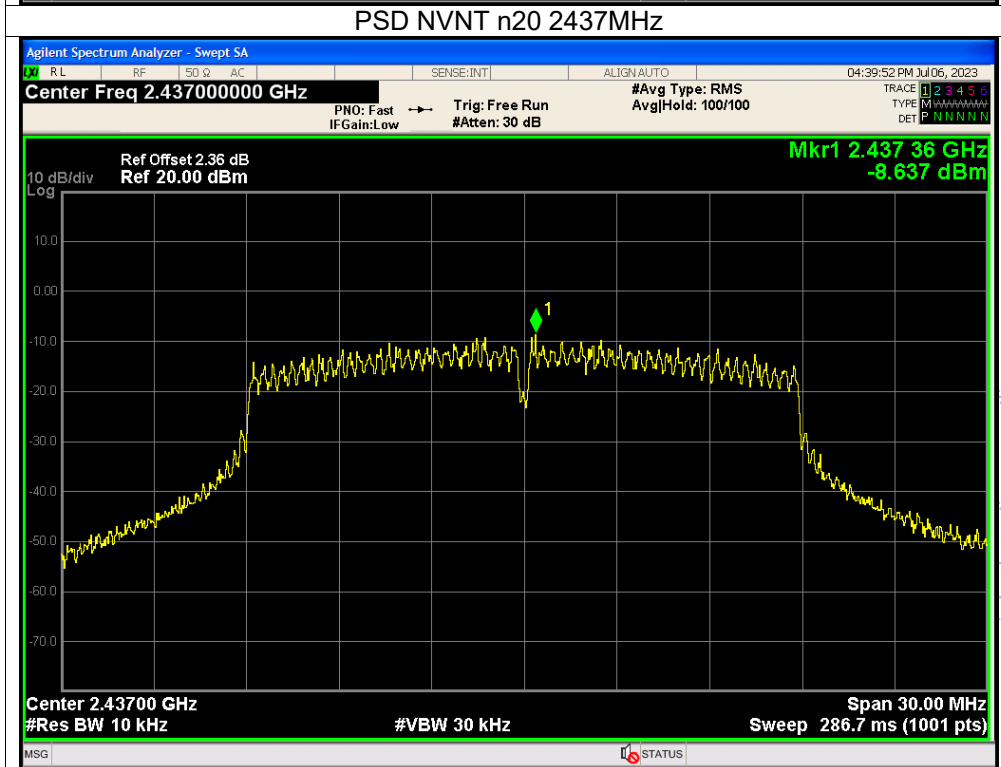
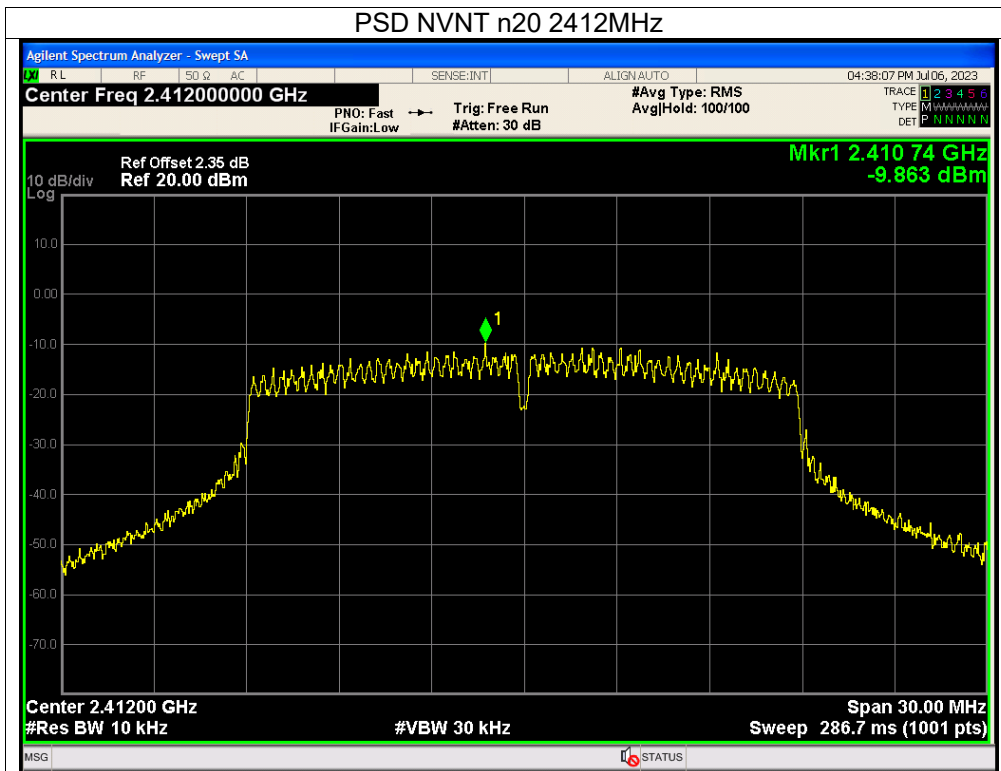

TEC
TC
OVER
检

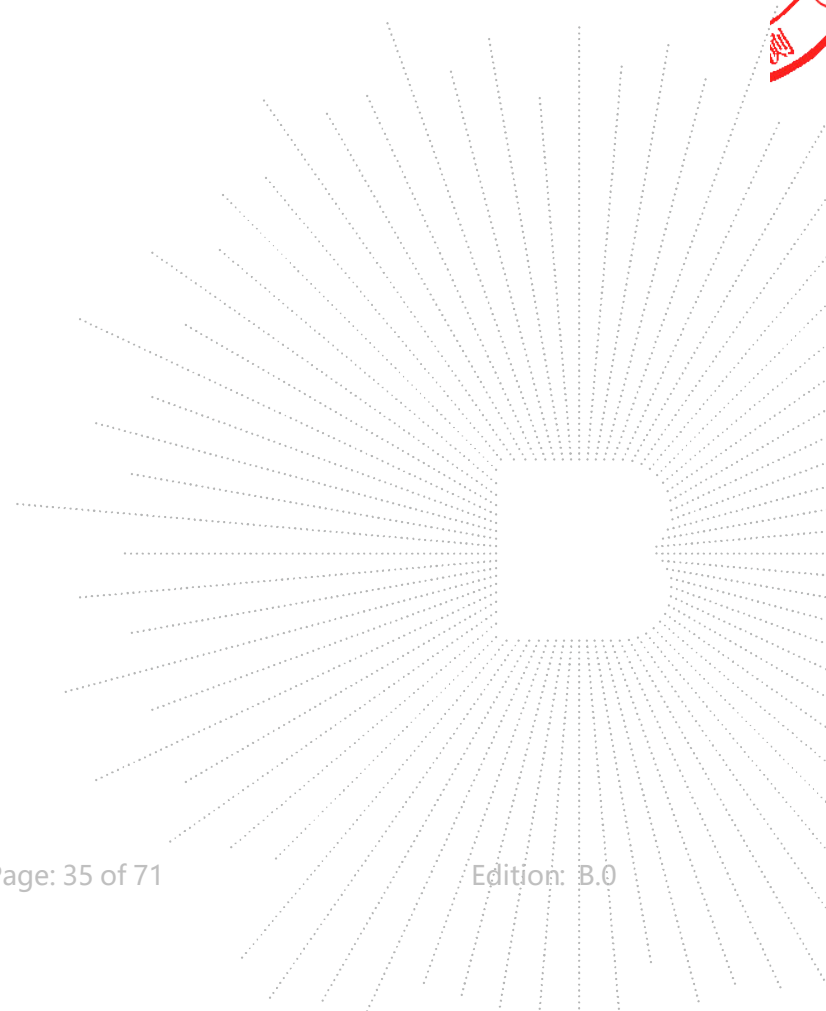
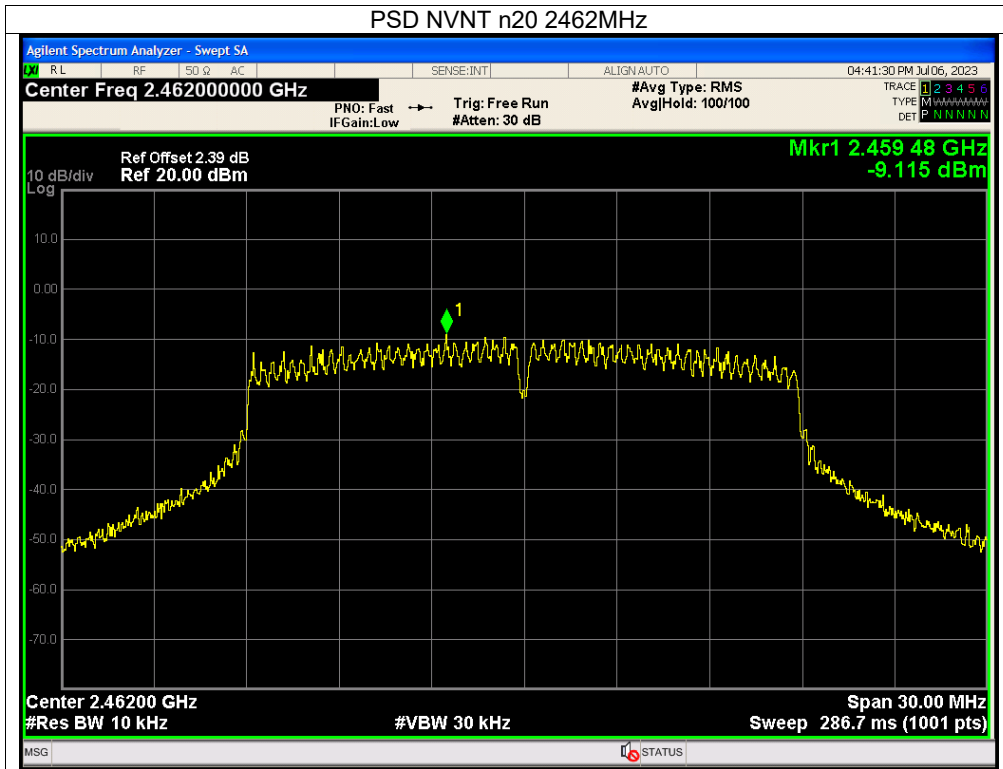

10. Bandwidth Test

10.1 Block Diagram Of Test Setup

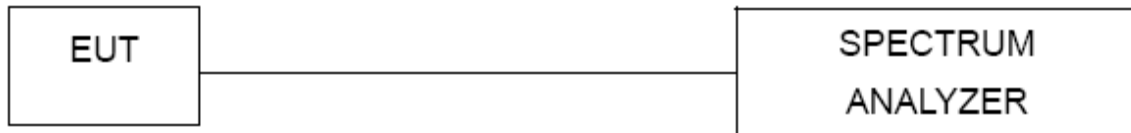

10.2 Limit

FCC Part15 (15.247) , Subpart C				
Section	Test Item	Limit	Frequency Range (MHz)	Result
15.247(a)(2)	Bandwidth	$\geq 500\text{KHz}$ (6dB bandwidth)	2400-2483.5	PASS

10.3 Test Procedure

1. Set RBW = 100 kHz.
2. Set the video bandwidth (VBW) $\geq 3 \times$ RBW.
3. Detector = Peak.
4. Trace mode = max hold.
5. Sweep = auto couple.
6. Allow the trace to stabilize.
7. Measure the maximum width of the emission that is constrained by the frequencies associated with the two outermost amplitude points (upper and lower frequencies) that are attenuated by 6 dB relative to the maximum level measured in the fundamental emission.

10.4 EUT Operating Conditions

The EUT tested system was configured as the statements of 4.6 Unless otherwise a special operating condition is specified in the follows during the testing.

Note: Power Spectral Density(dBm)=Reading+Cable Loss

10.5 Test Result

Temperature :	26°C	Relative Humidity :	54%
Pressure :	101kPa	Test Voltage :	DC 12V

Mode	Frequency (MHz)	6dB bandwidth (MHz)	Limit (kHz)	Result
b	2412	8.54	500	Pass
	2437	8.498	500	Pass
	2462	8.514	500	Pass
g	2412	14.997	500	Pass
	2437	13.81	500	Pass
	2462	15.07	500	Pass
N 20	2412	14.469	500	Pass
	2437	14.808	500	Pass
	2462	15.15	500	Pass

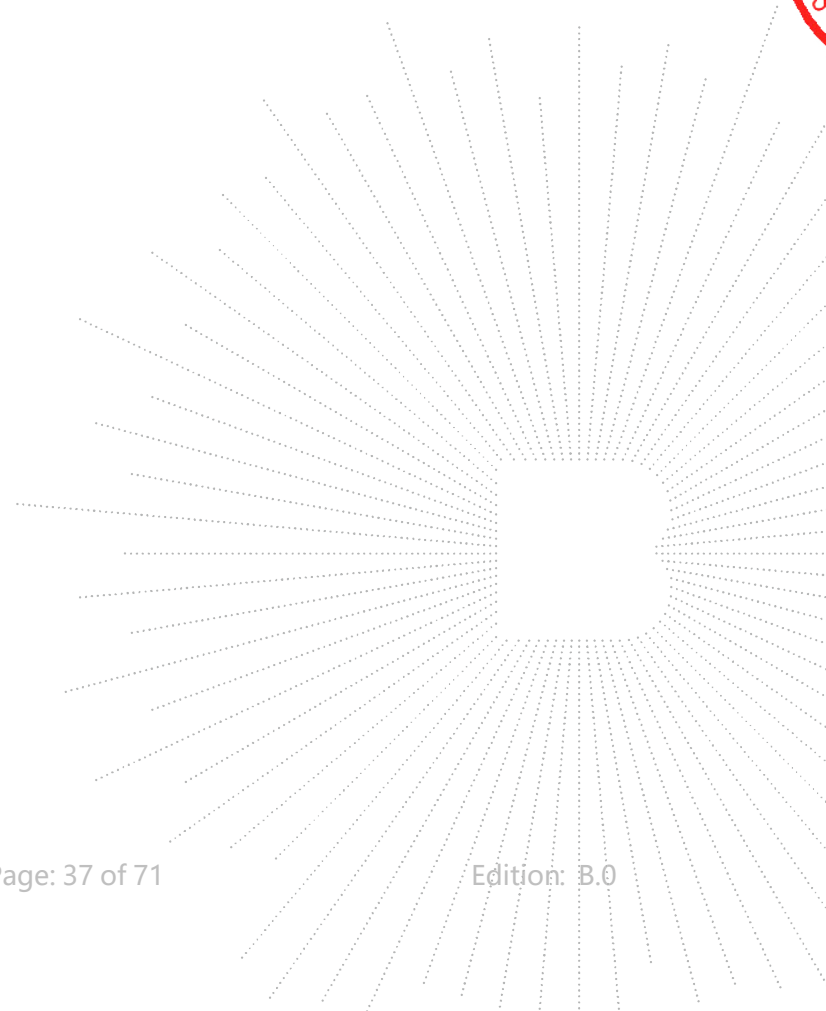

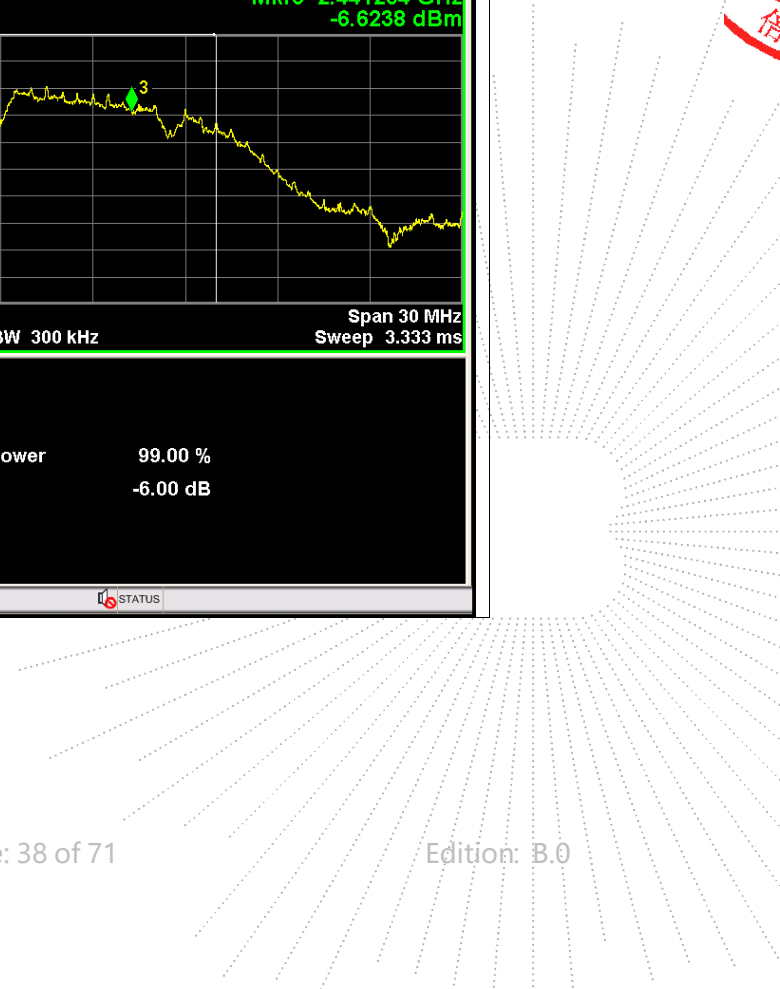
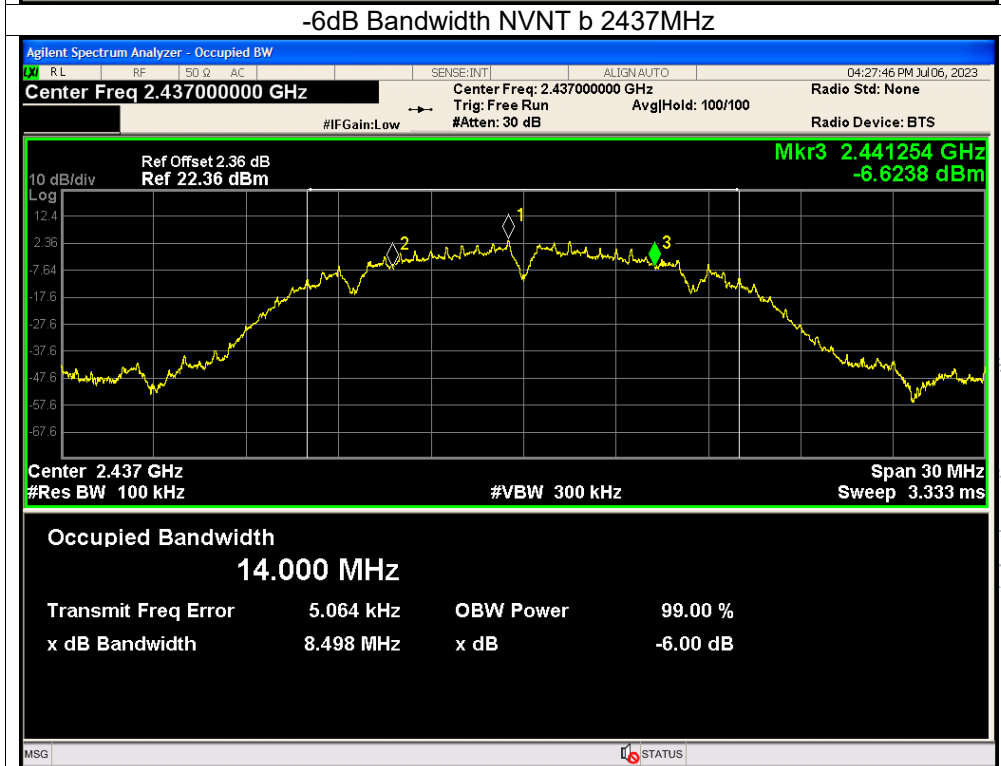
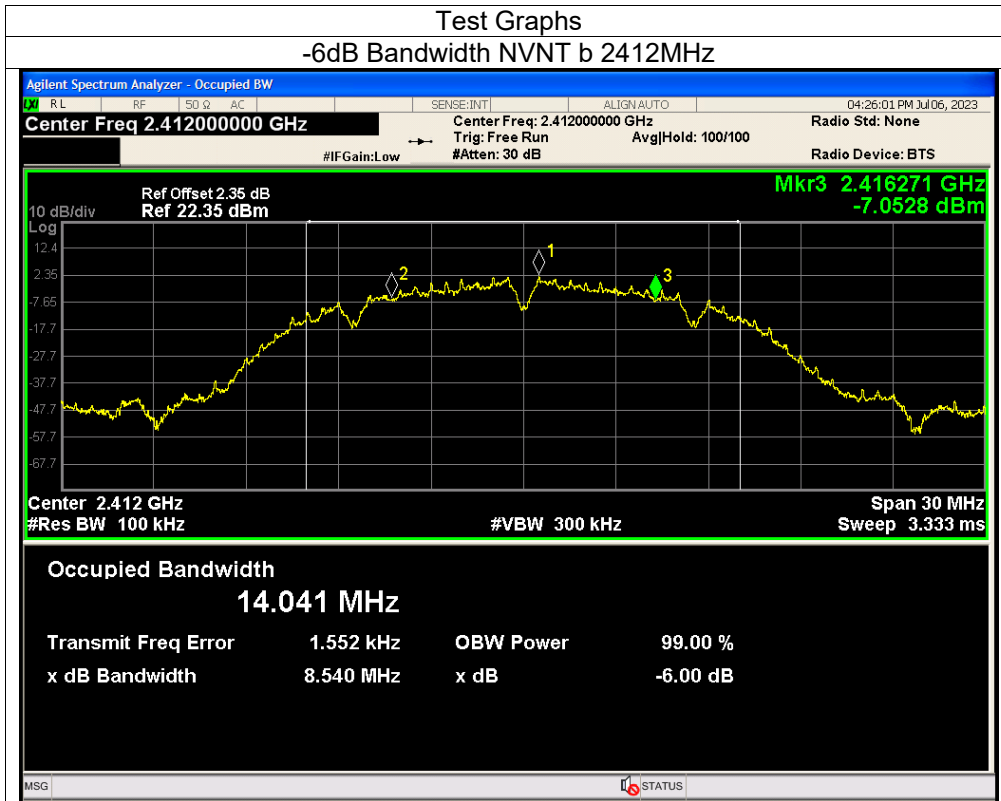

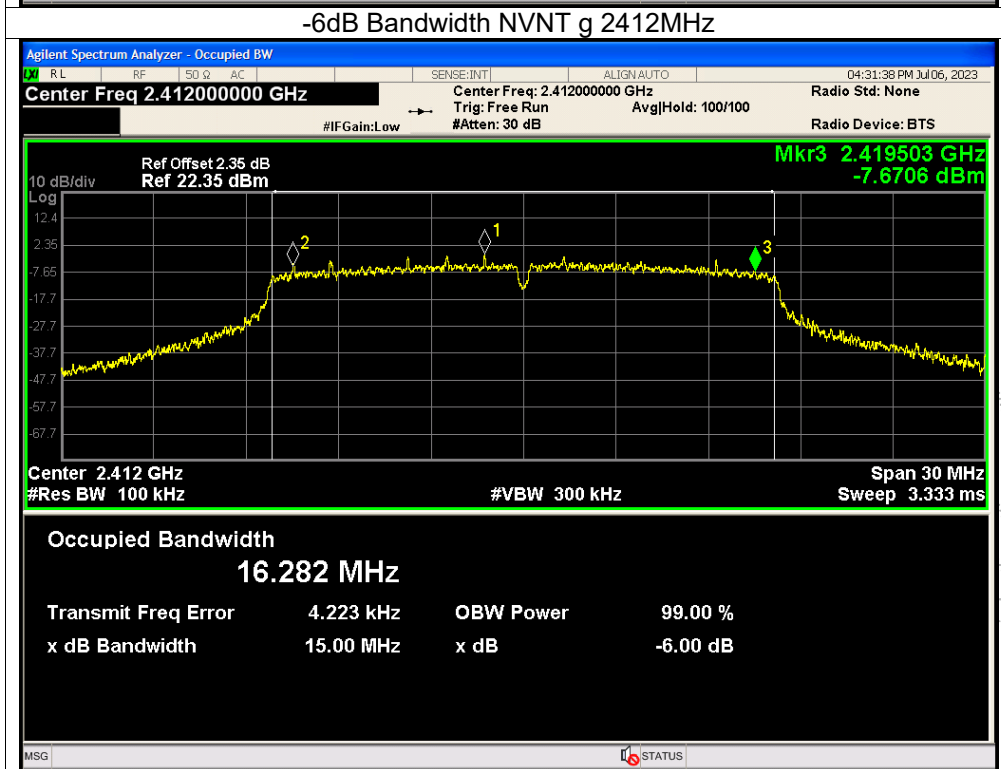
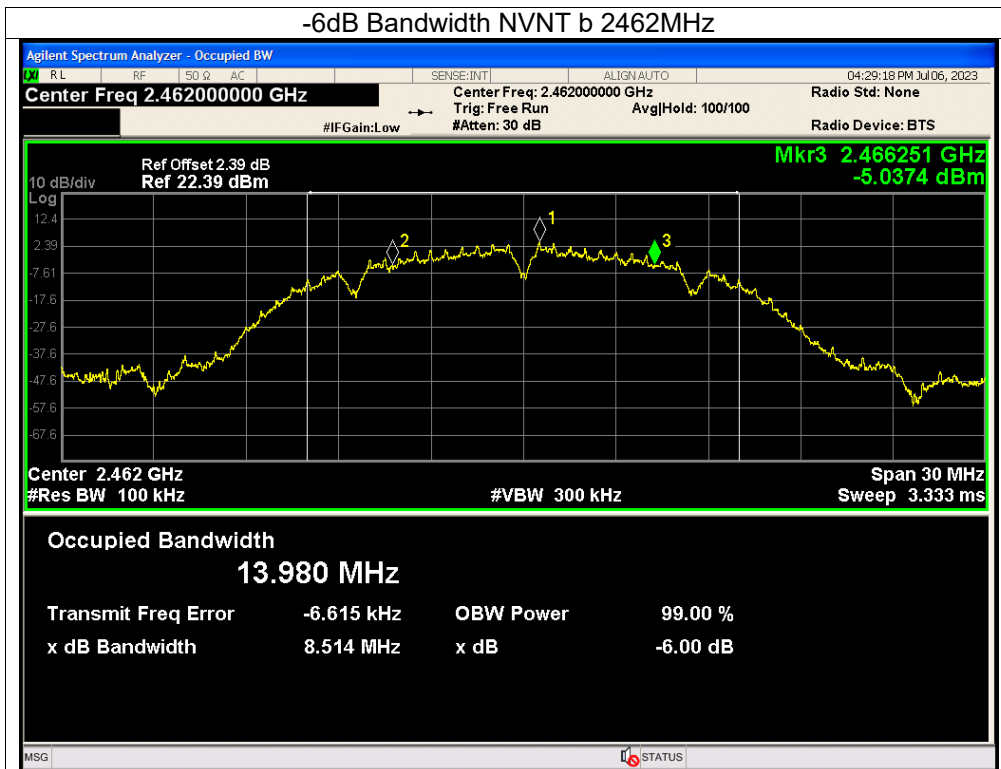

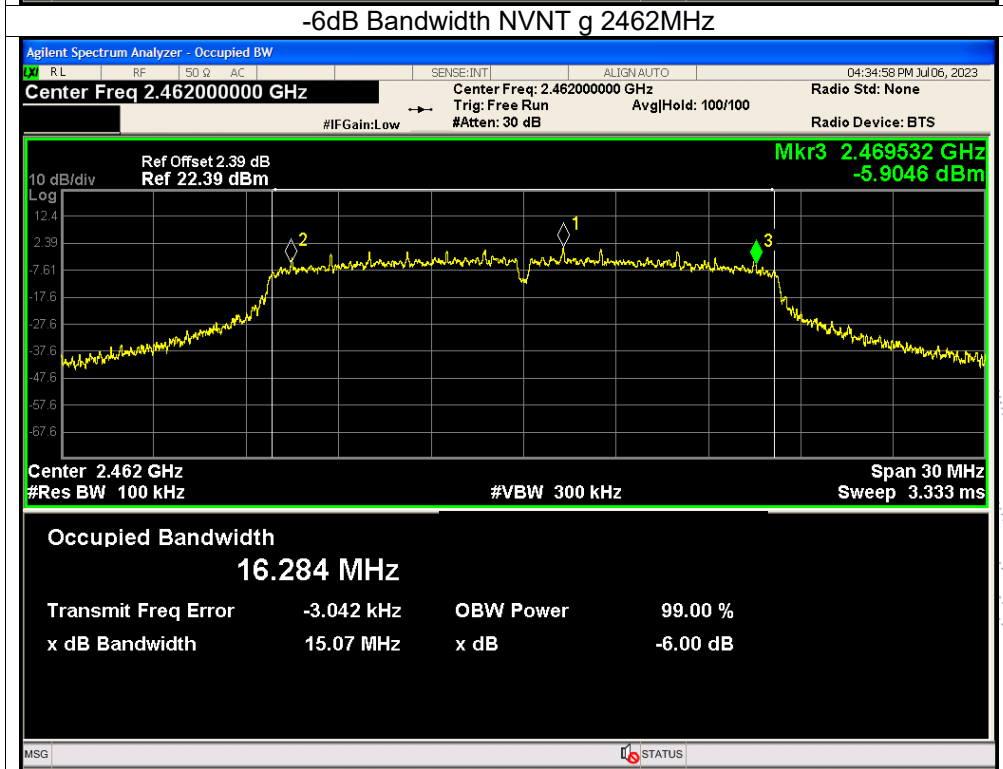
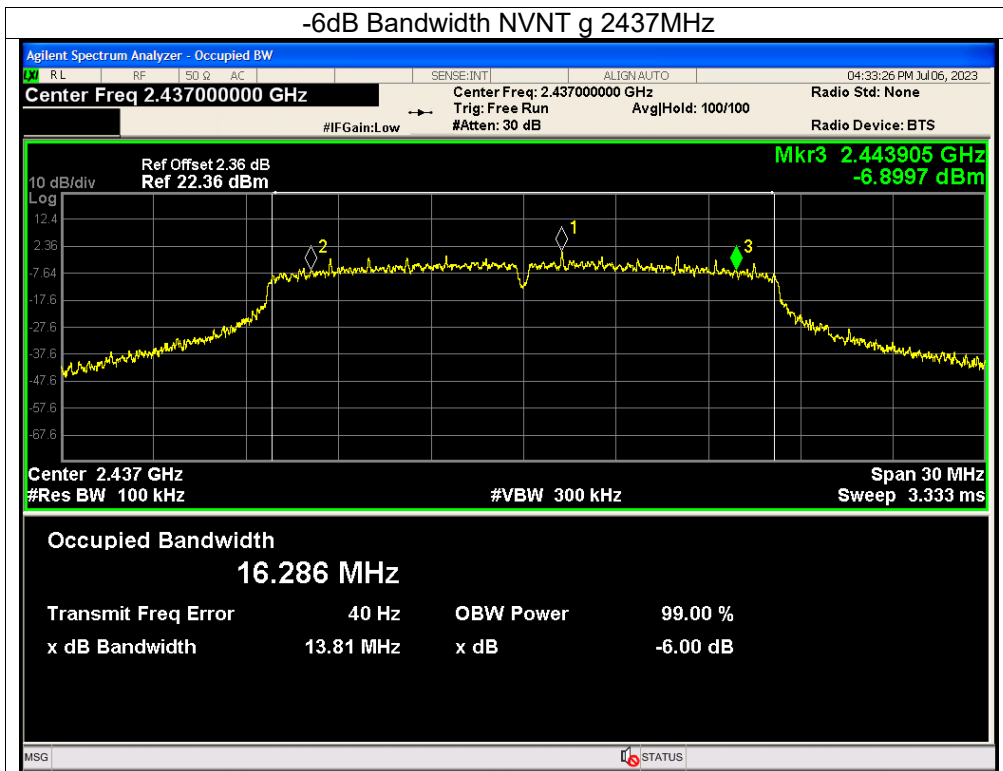

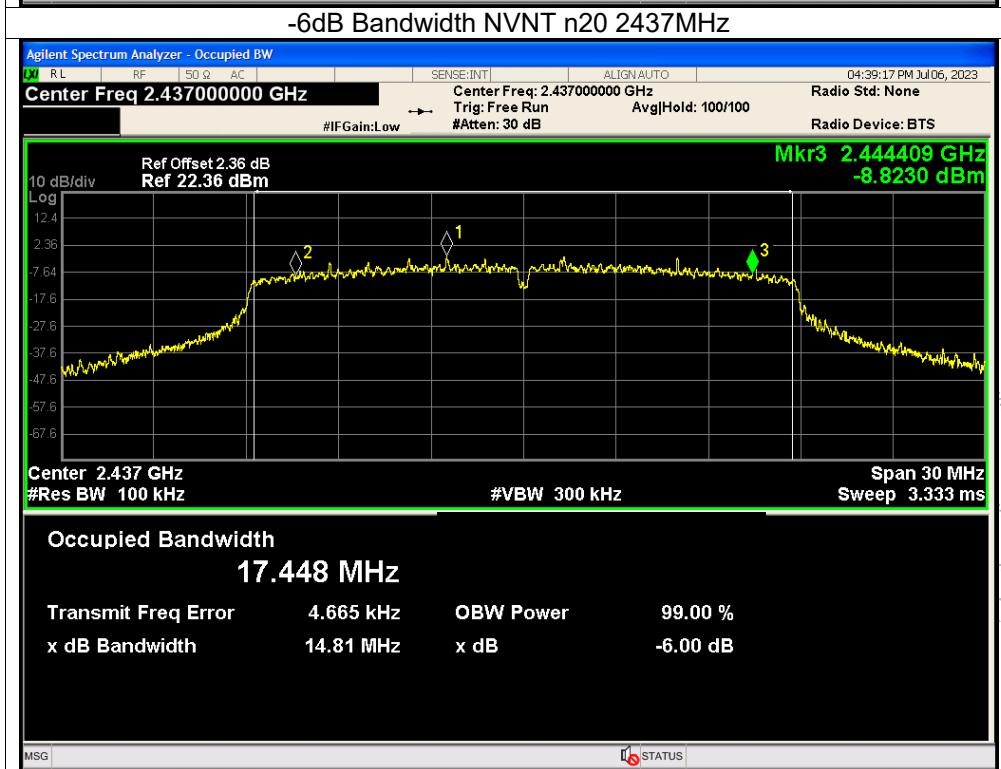
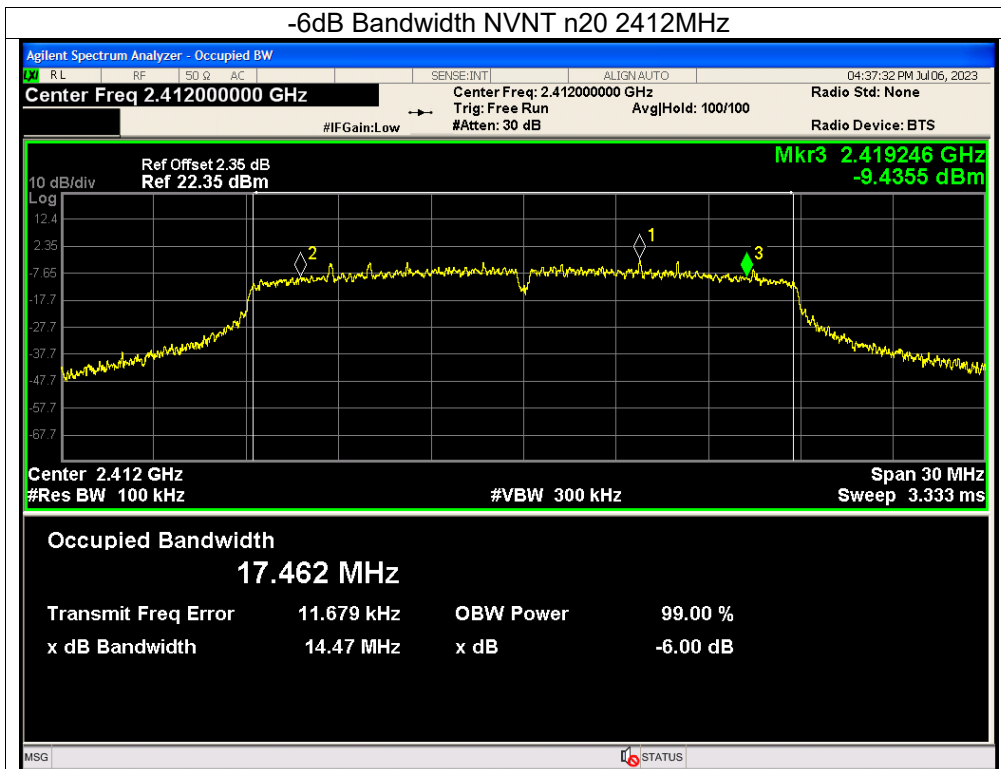

TEC
 TC
 OVE
 检



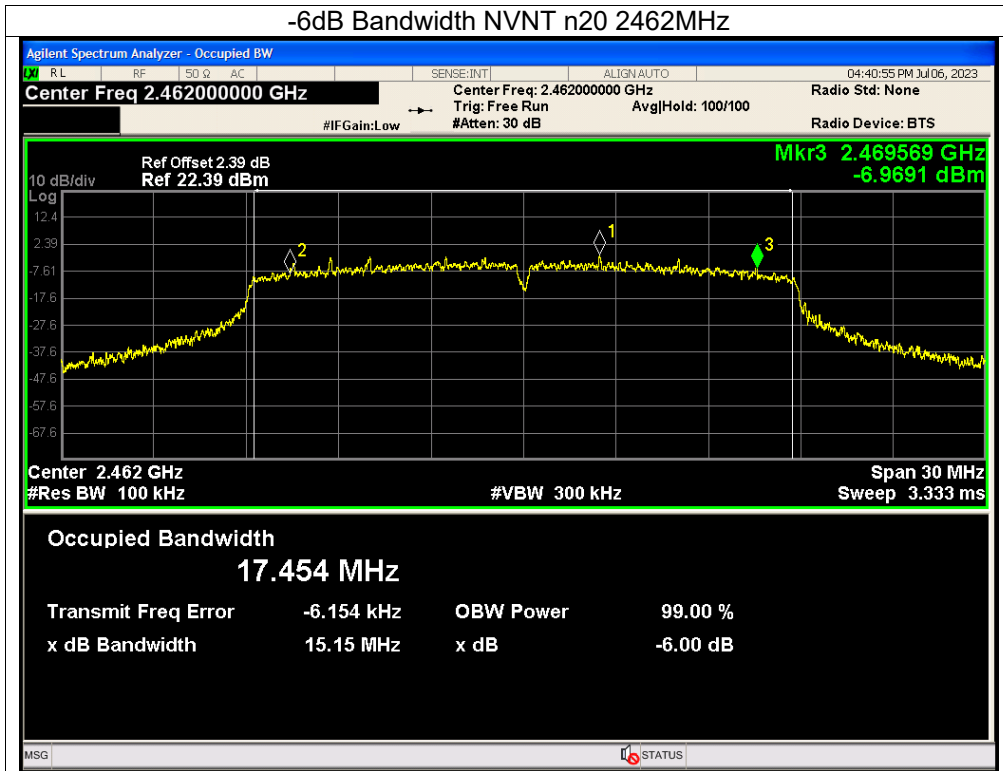

CO., LTD.

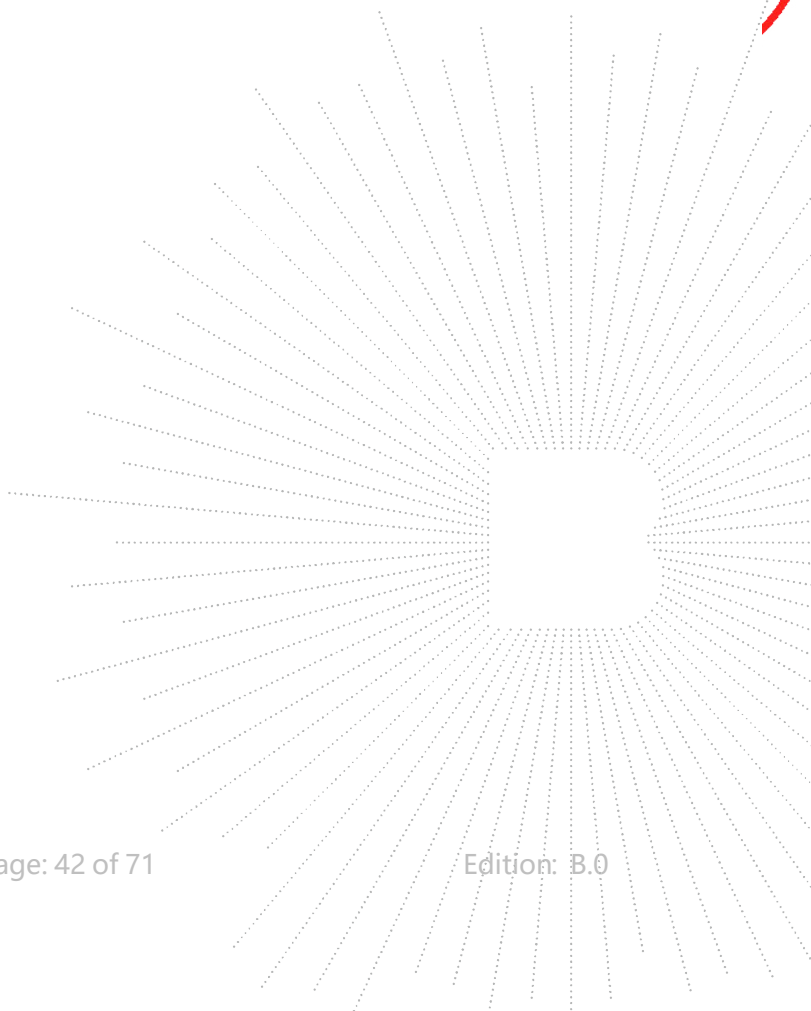

11. Peak Output Power Test

11.1 Block Diagram Of Test Setup



11.2 Limit

FCC Part15 (15.247) , Subpart C				
Section	Test Item	Limit	Frequency Range (MHz)	Result
15.247(b)(3)	Peak Output Power	1 watt or 30dBm	2400-2483.5	PASS

11.3 Test Procedure

- a. The EUT was directly connected to the Power meter

11.4 EUT Operating Conditions

The EUT tested system was configured as the statements of 4.6 Unless otherwise a special operating condition is specified in the follows during the testing.

Note: Power Spectral Density(dBm)=Reading+Cable Loss

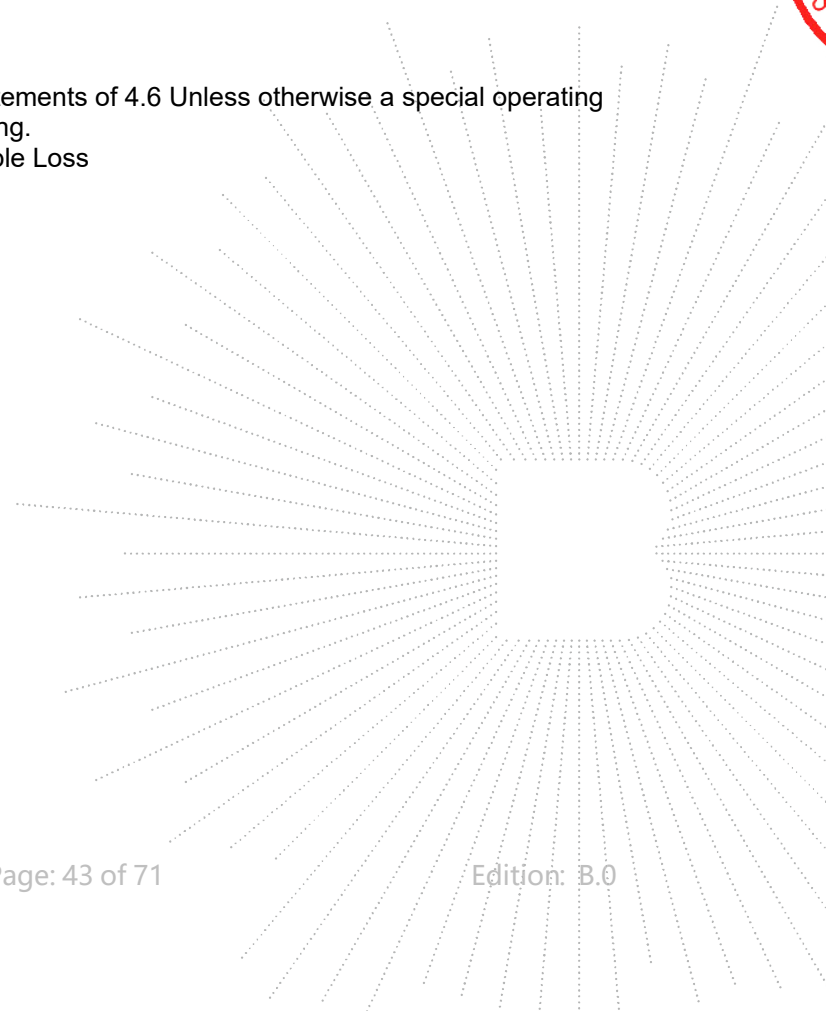

11.5 Test Result

Temperature :	26°C	Relative Humidity :	54%
Pressure :	101kPa	Test Voltage :	DC 12V

	Frequency	Maximum Conducted Output Power(PK)	LIMIT
	(MHz)	(dBm)	dBm
802.11b	2412	10.70	30
	2437	11.47	30
	2462	12.06	30
802.11g	2412	9.57	30
	2437	10.38	30
	2462	10.9	30
802.11n20	2412	8.31	30
	2437	9.25	30
	2462	9.67	30

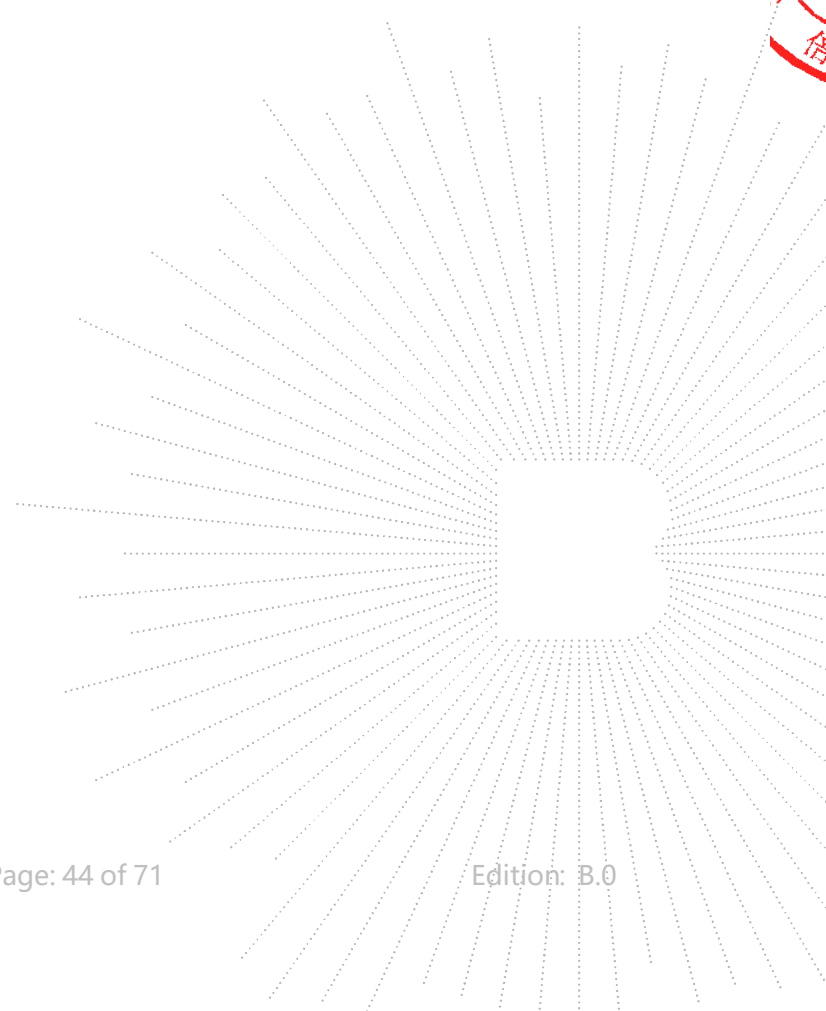

12. 100 KHz Bandwidth Of Frequency Band Edge

12.1 Block Diagram Of Test Setup



12.2 Limit

In any 100 kHz bandwidth outside the frequency band in which the spread spectrum intentional radiator is operating, the radio frequency power that is produced by the intentional radiator shall be at least 20 dB below that in the 100 kHz bandwidth within the band that contains the highest level of the desired power, based on either an RF conducted or a radiated measurement.

12.3 Test Procedure

Using the following spectrum analyzer setting:

- Set the RBW = 100KHz.
- Set the VBW = 300KHz.
- Sweep time = auto couple.
- Detector function = peak.
- Trace mode = max hold.
- Allow trace to fully stabilize..

12.4 EUT Operating Conditions

The EUT tested system was configured as the statements of 4.6 Unless otherwise a special operating condition is specified in the follows during the testing.

Note: Power Spectral Density(dBm)=Reading+Cable Loss

12.5 Test Result

Temperature :	26°C	Relative Humidity :	54%
Pressure :	101kPa	Test Voltage :	DC 12V

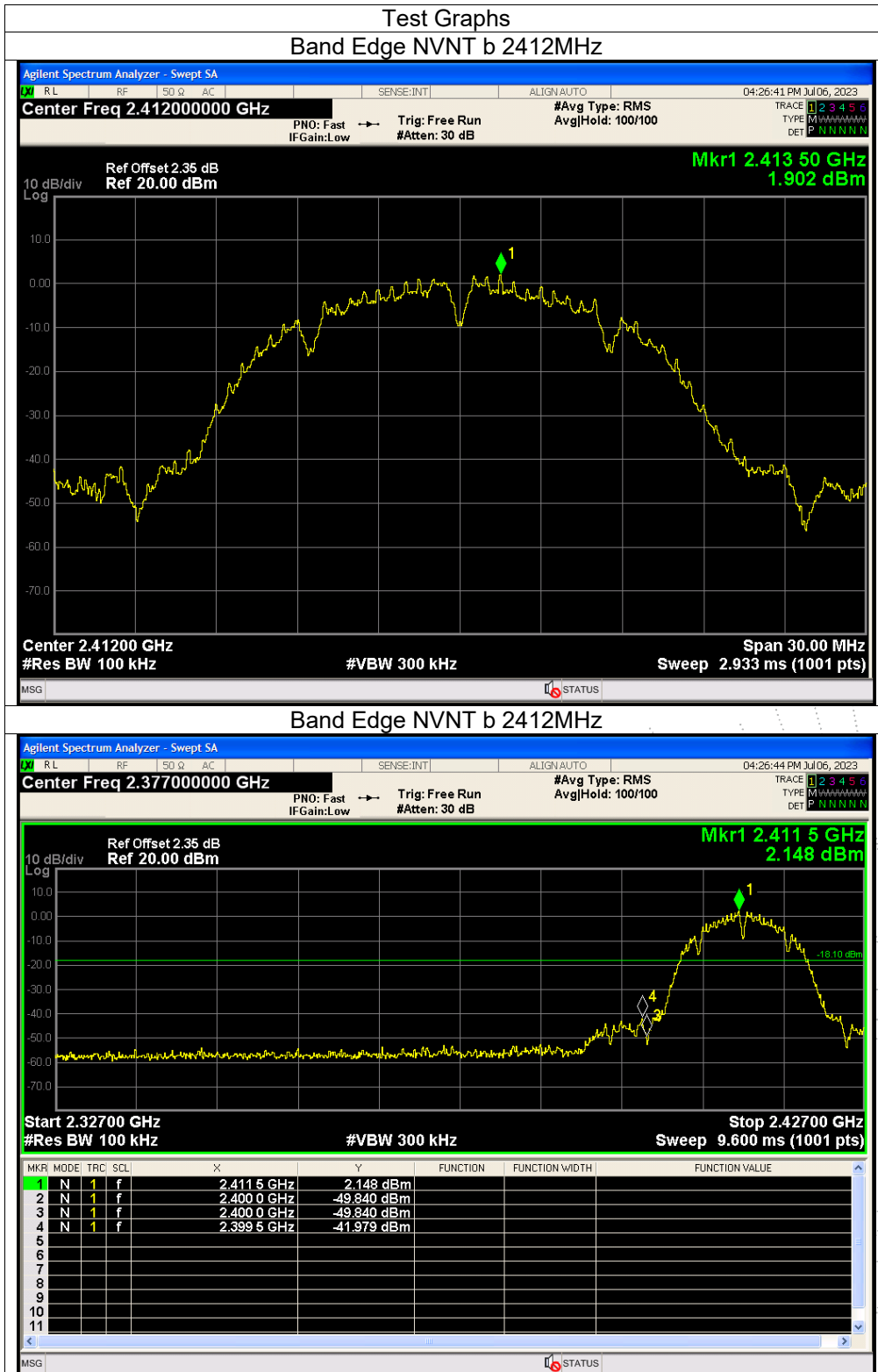

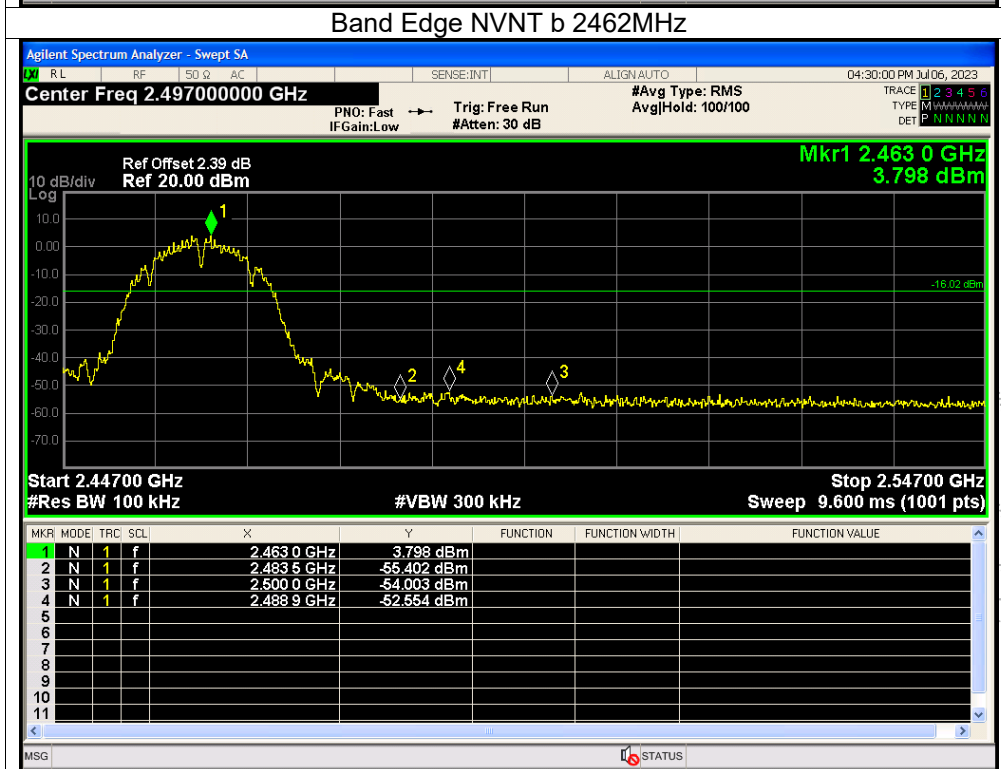
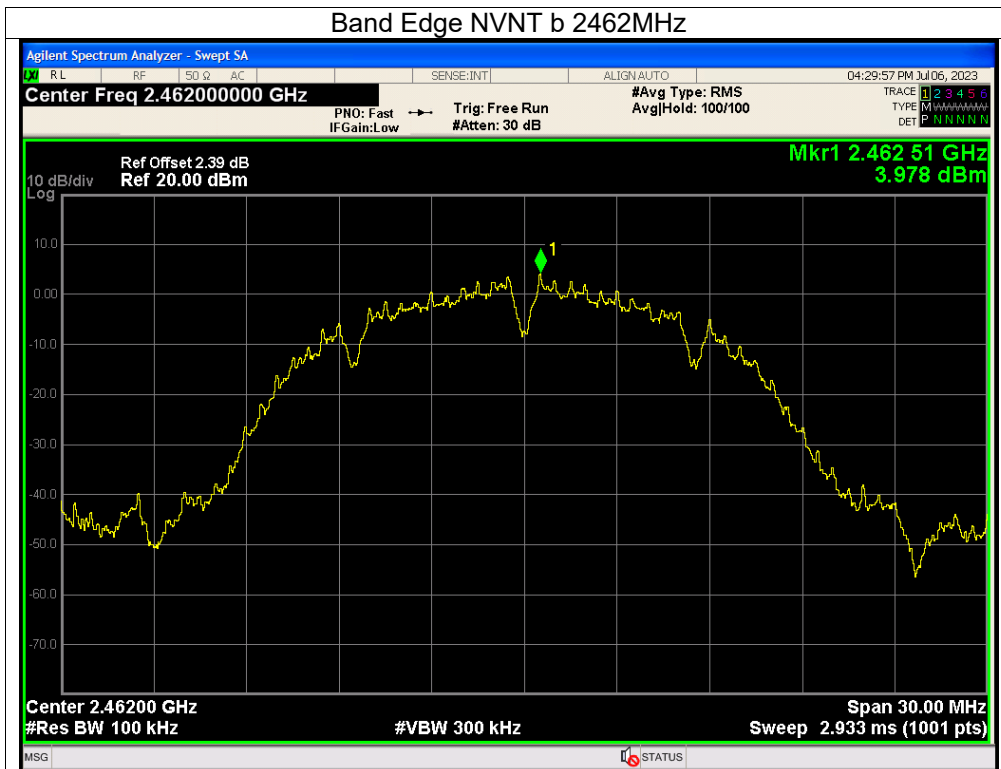

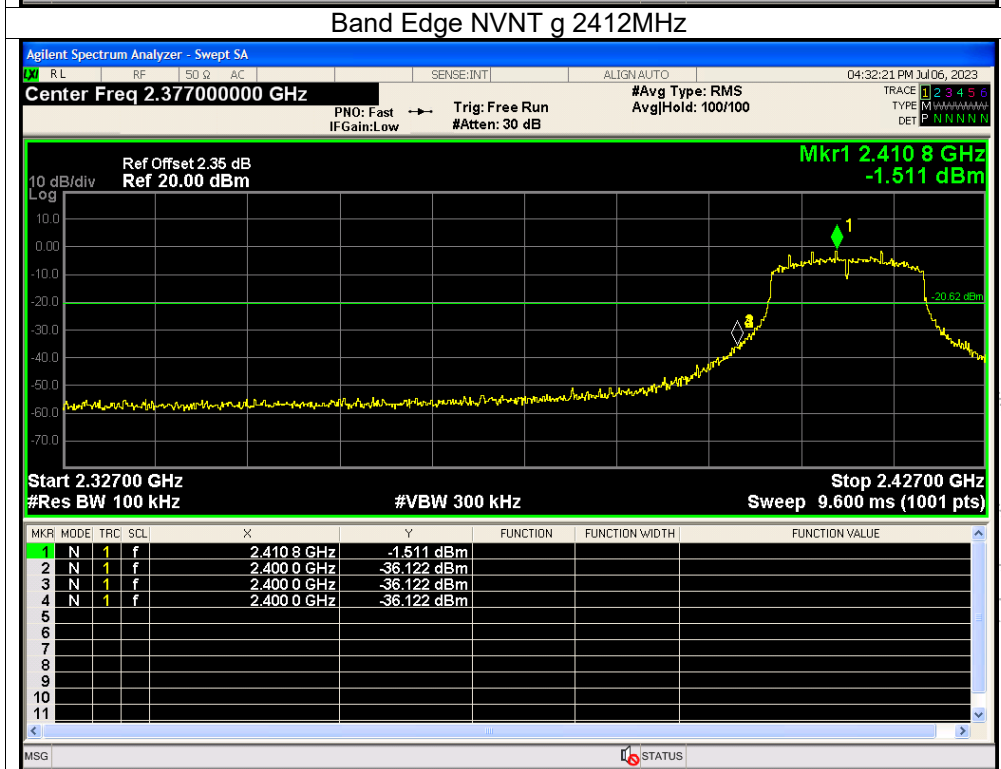
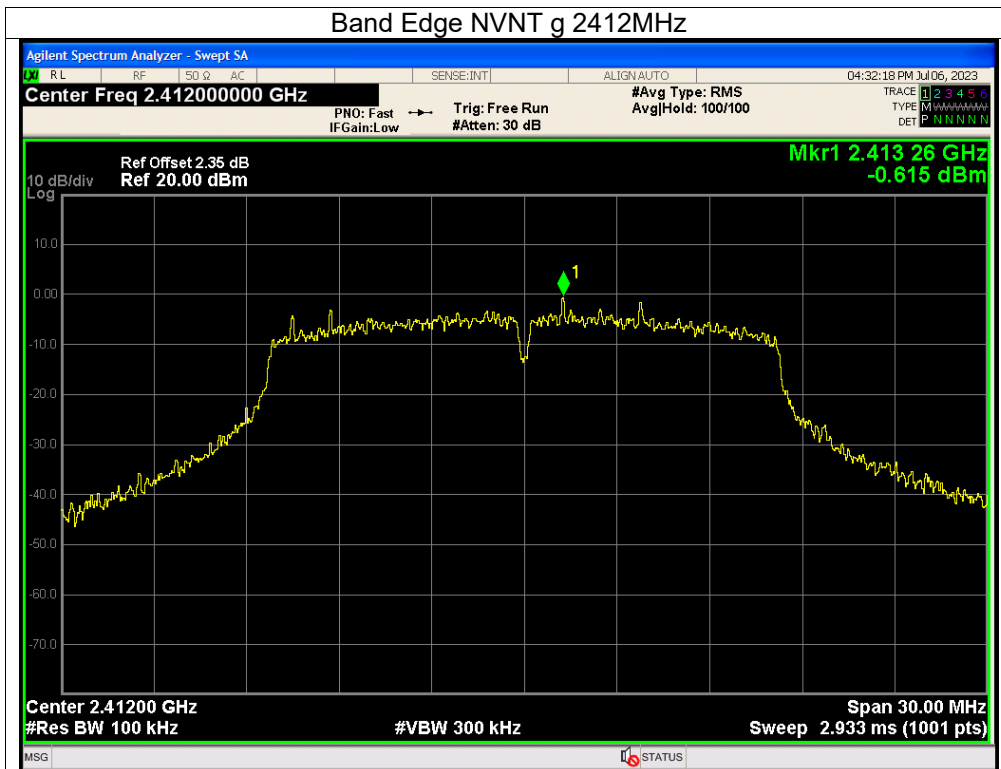

CO. LTD.

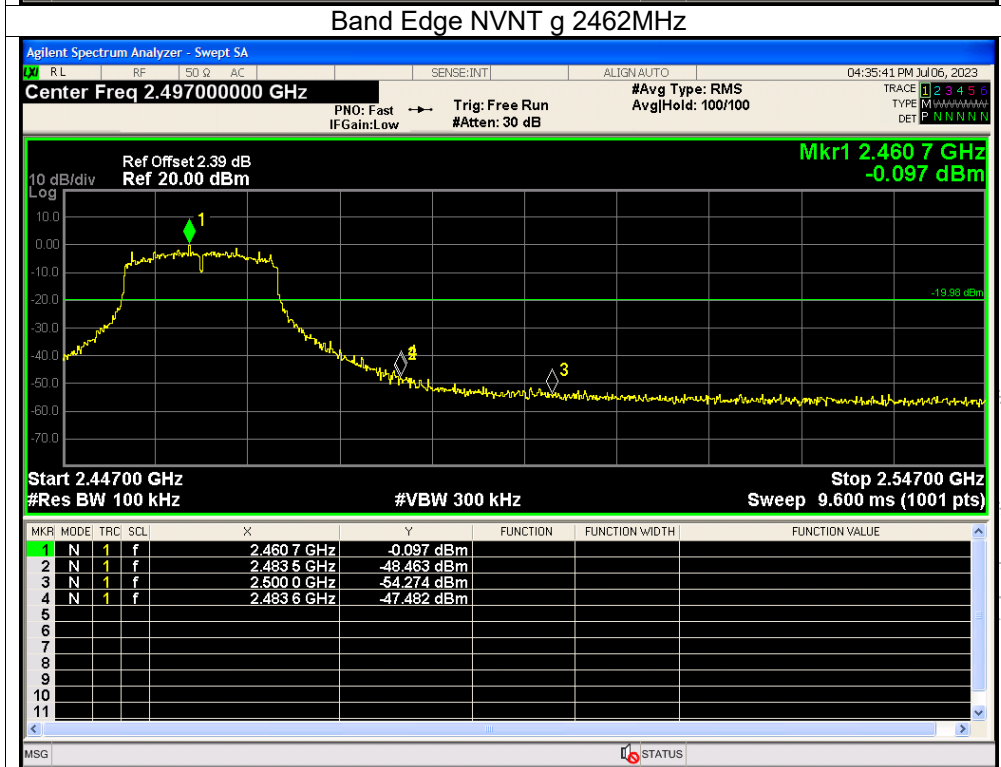
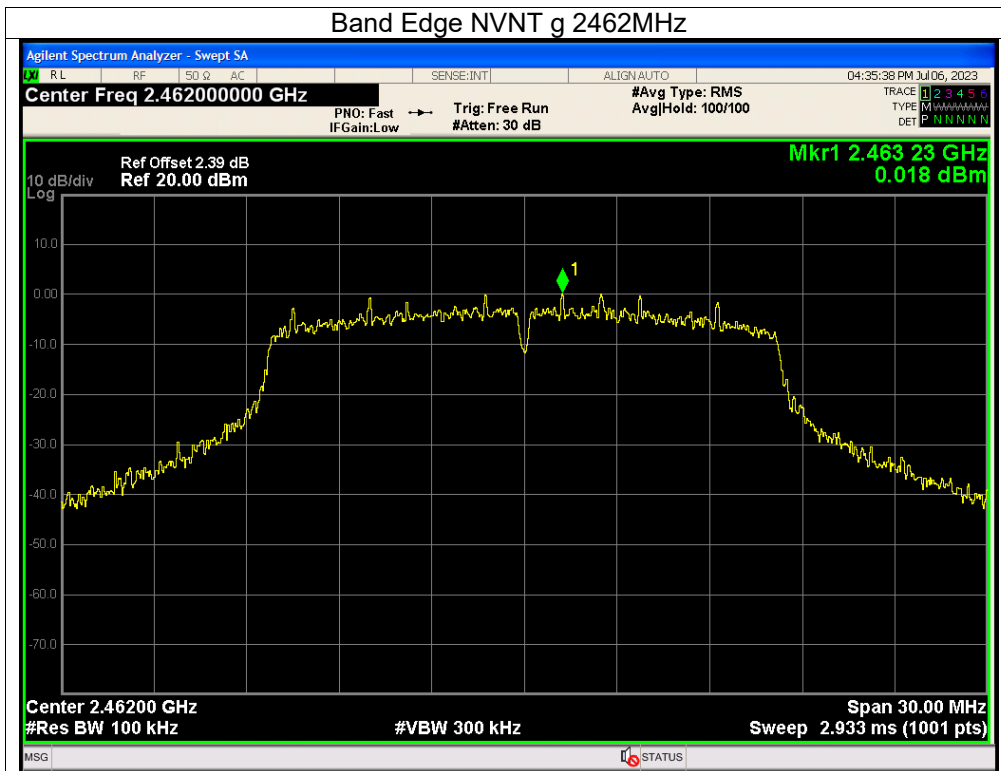

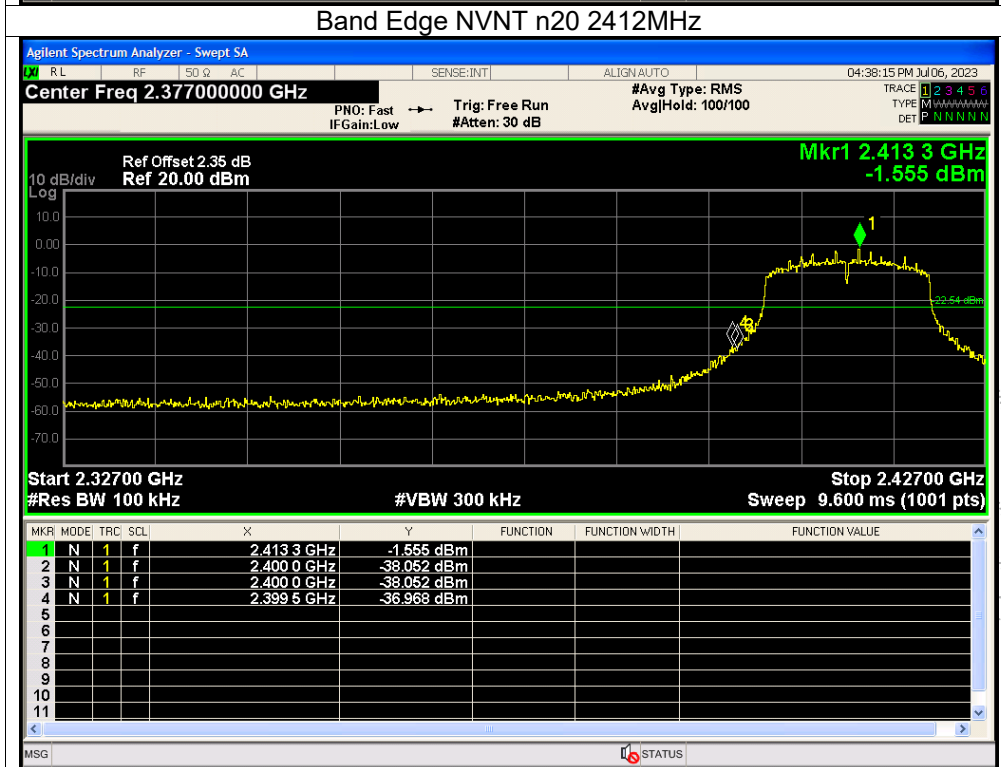
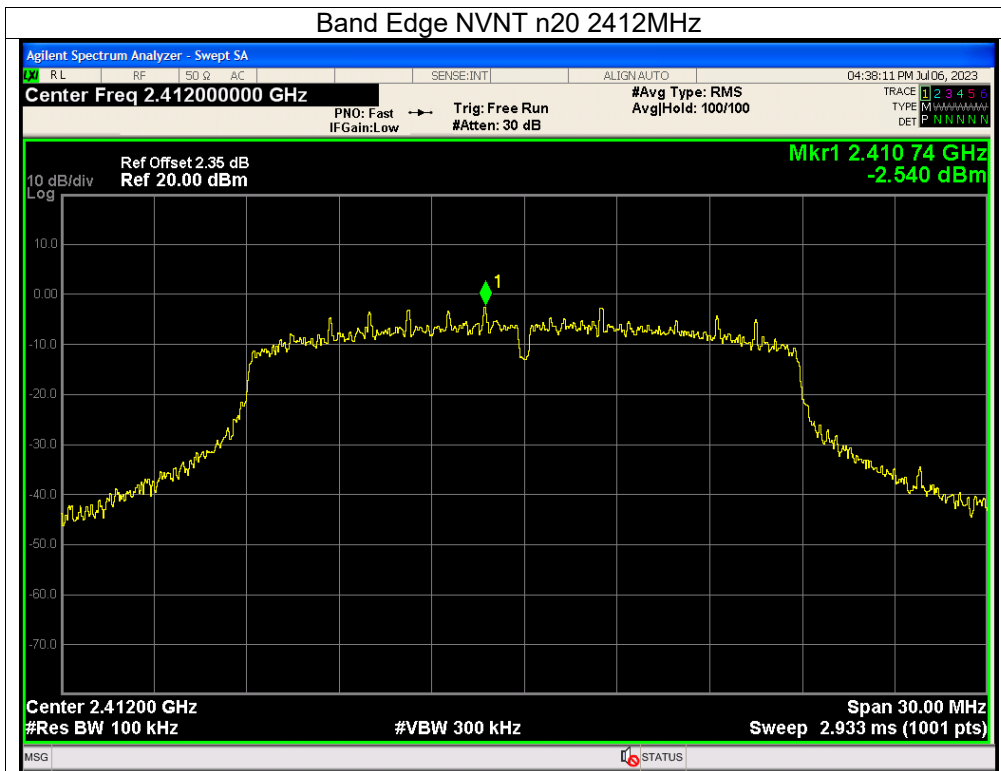

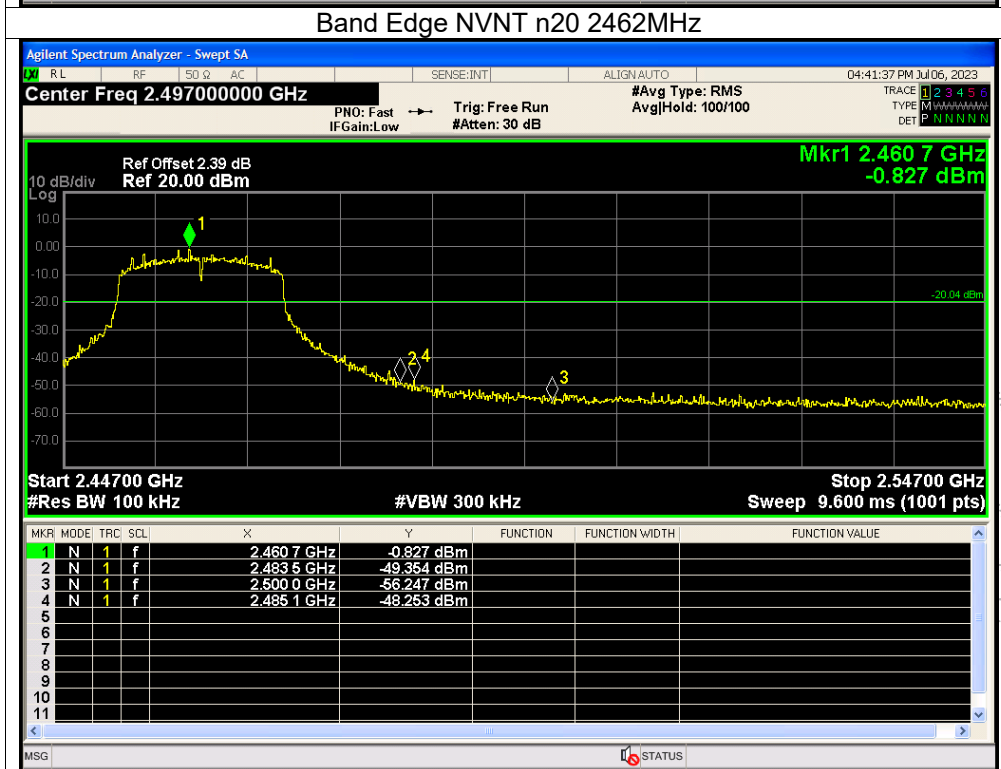
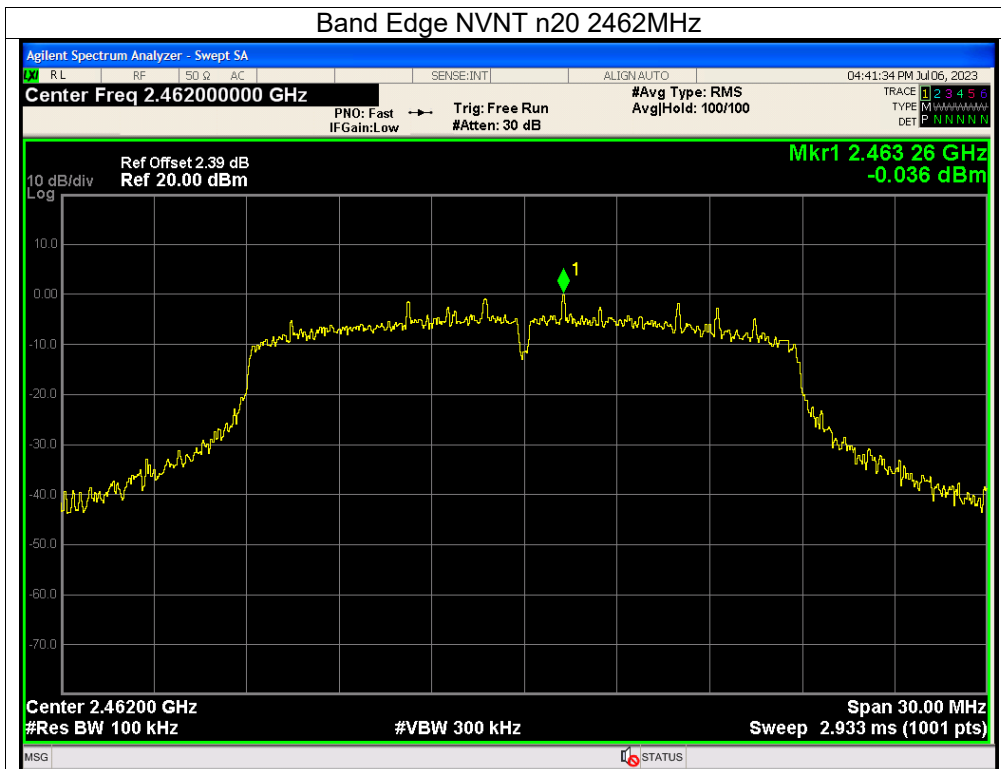

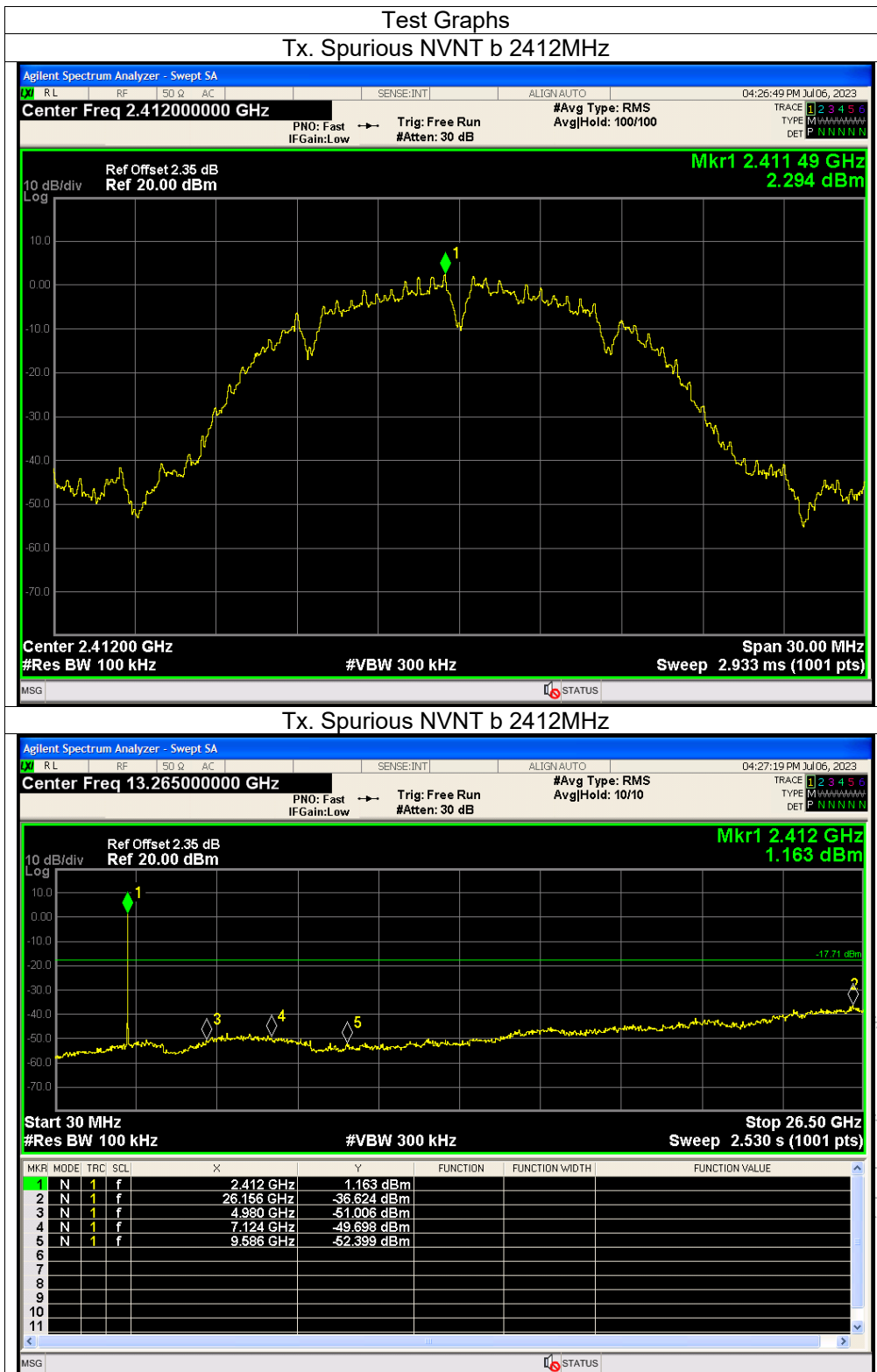

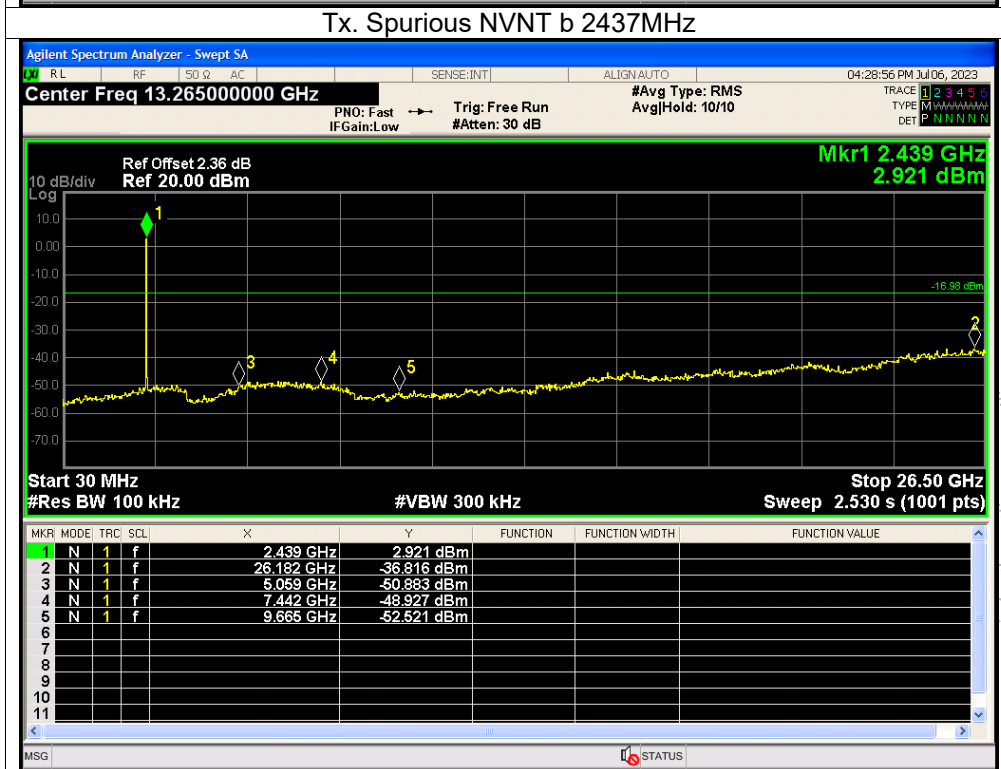
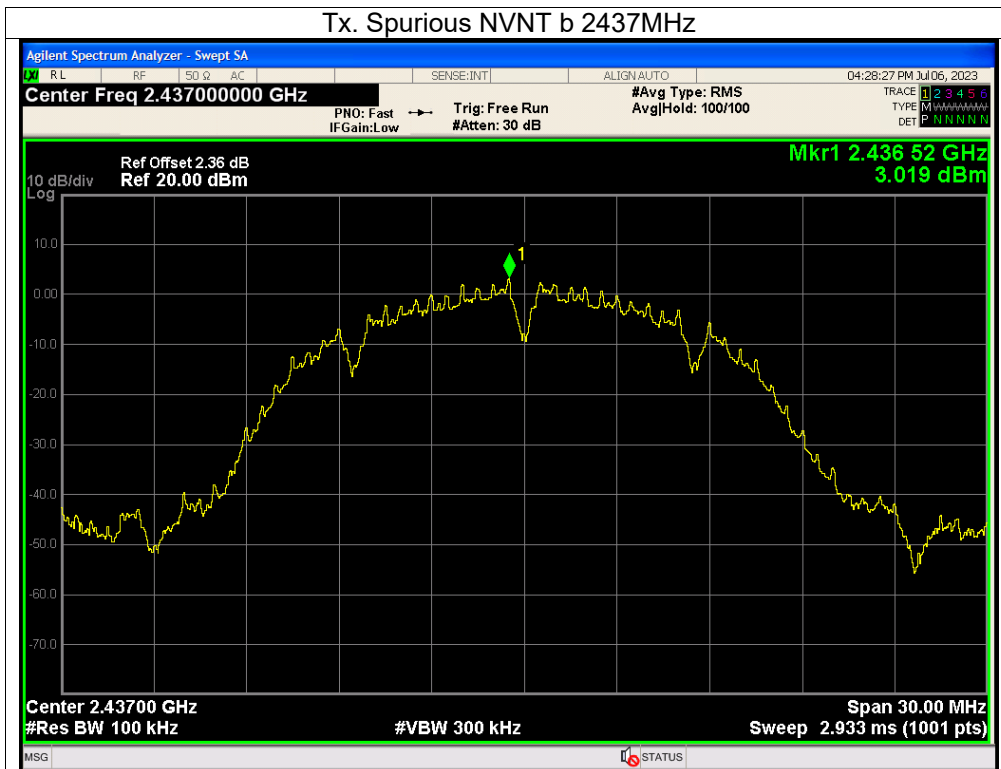

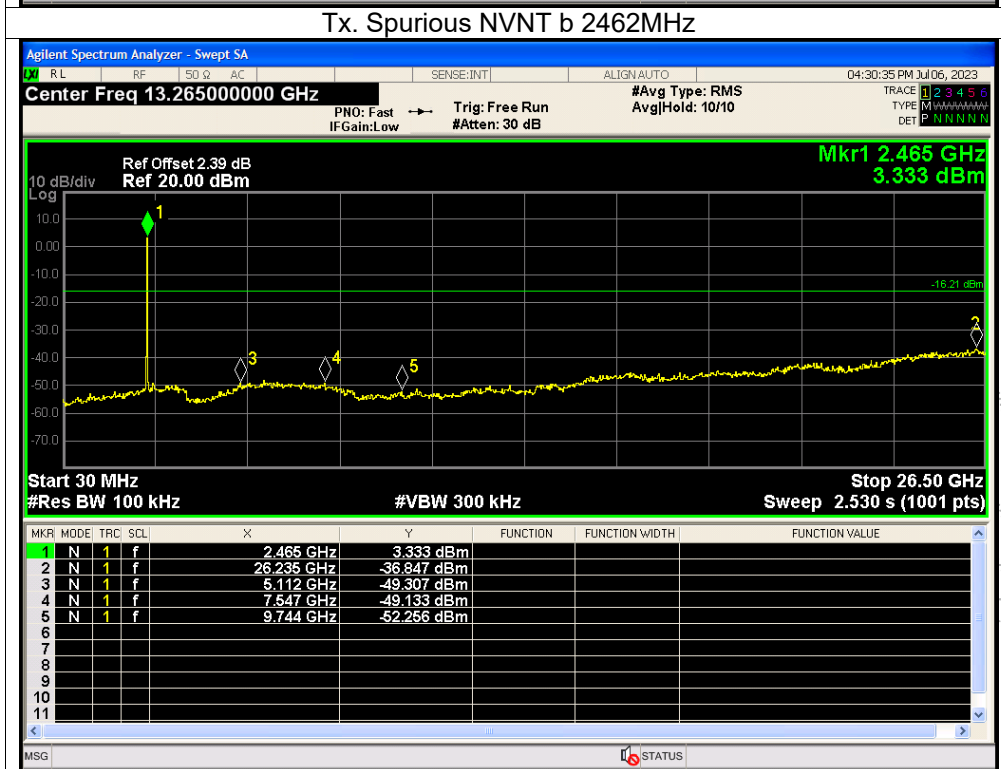
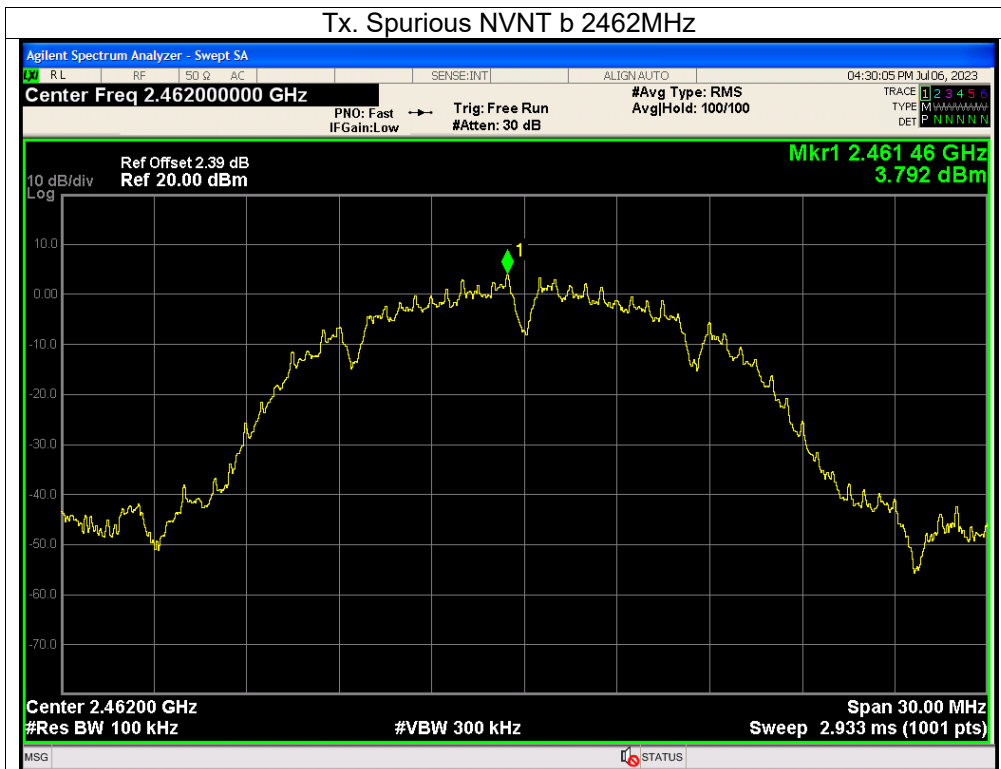

CO.LTD



Tx. Spurious NVNT g 2412MHz

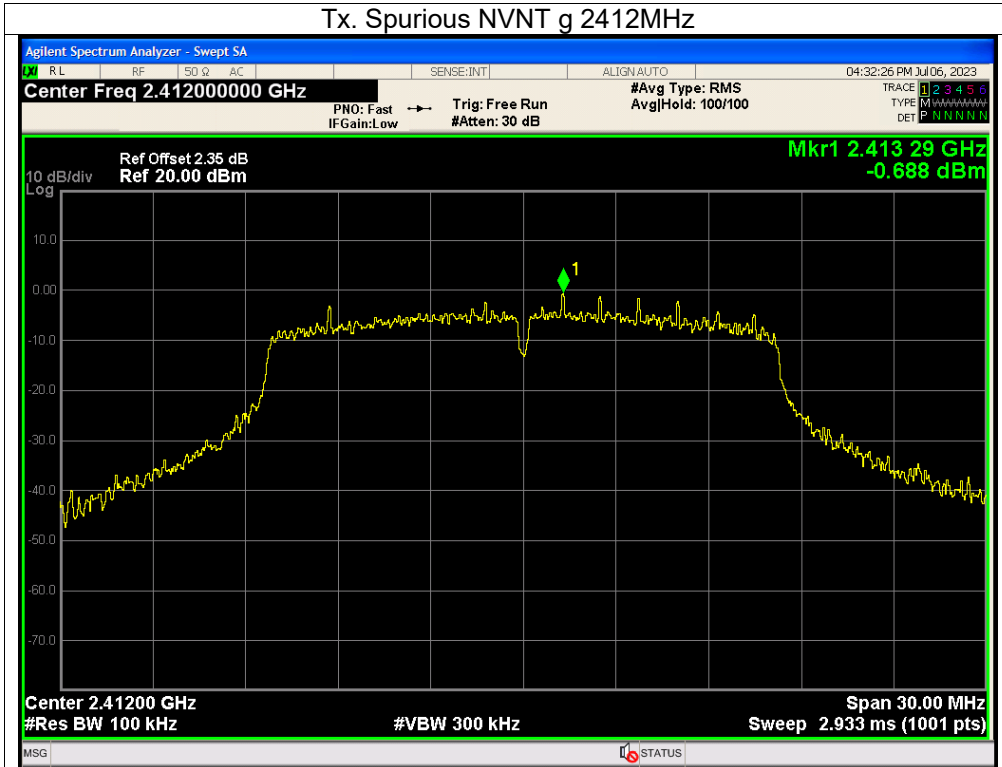

Tx. Spurious NVNT g 2412MHz

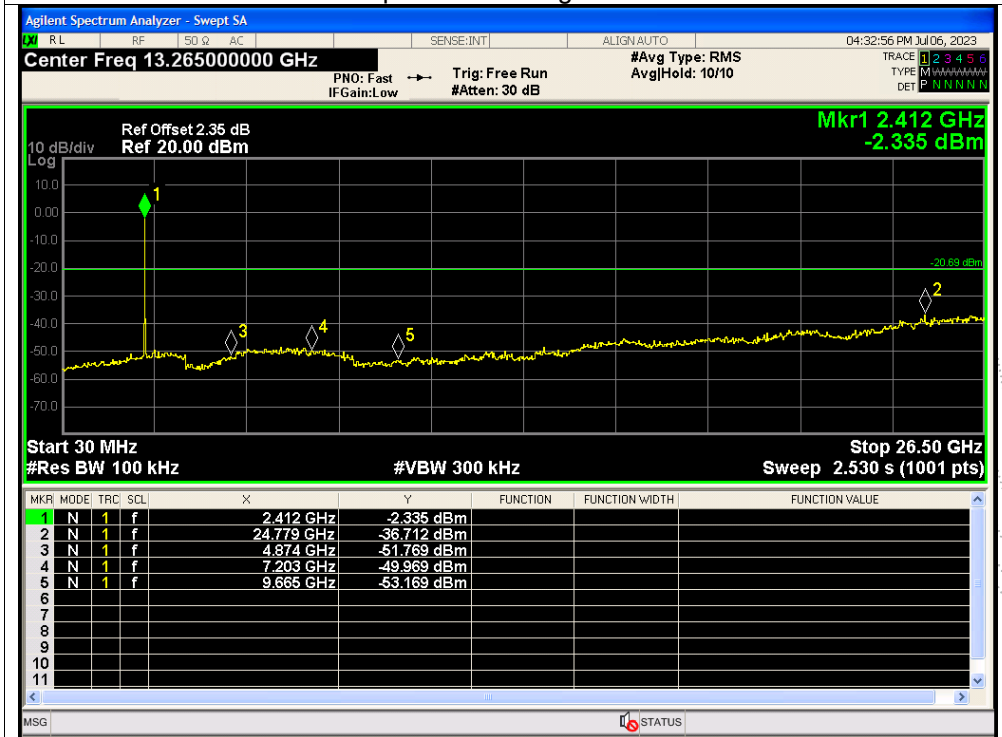

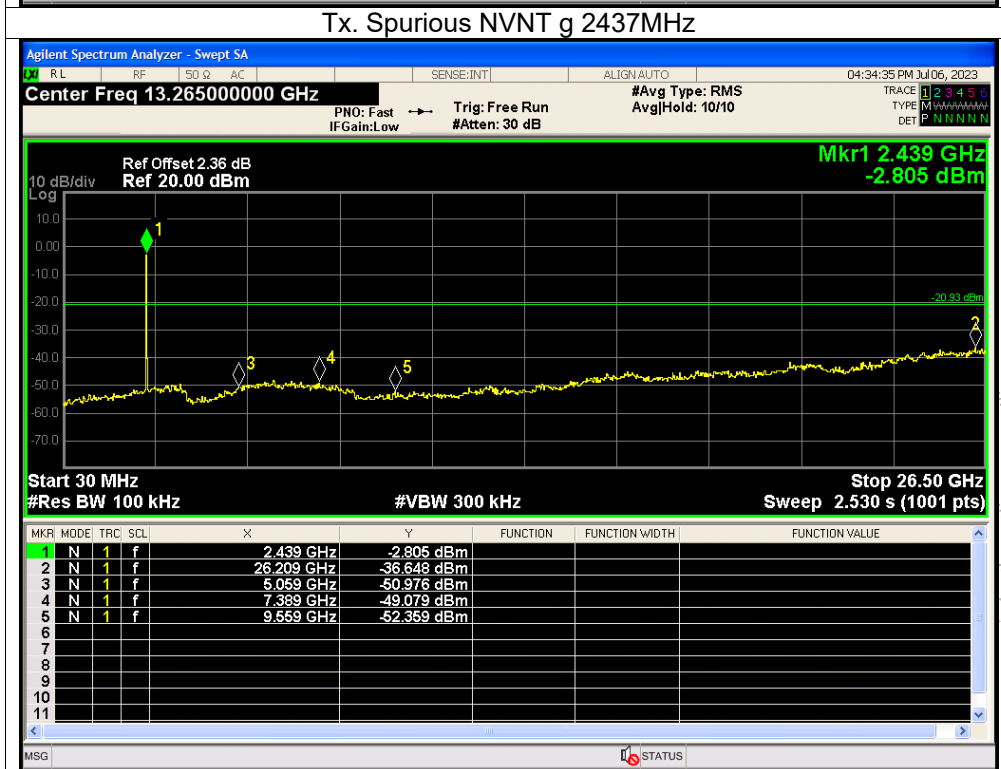
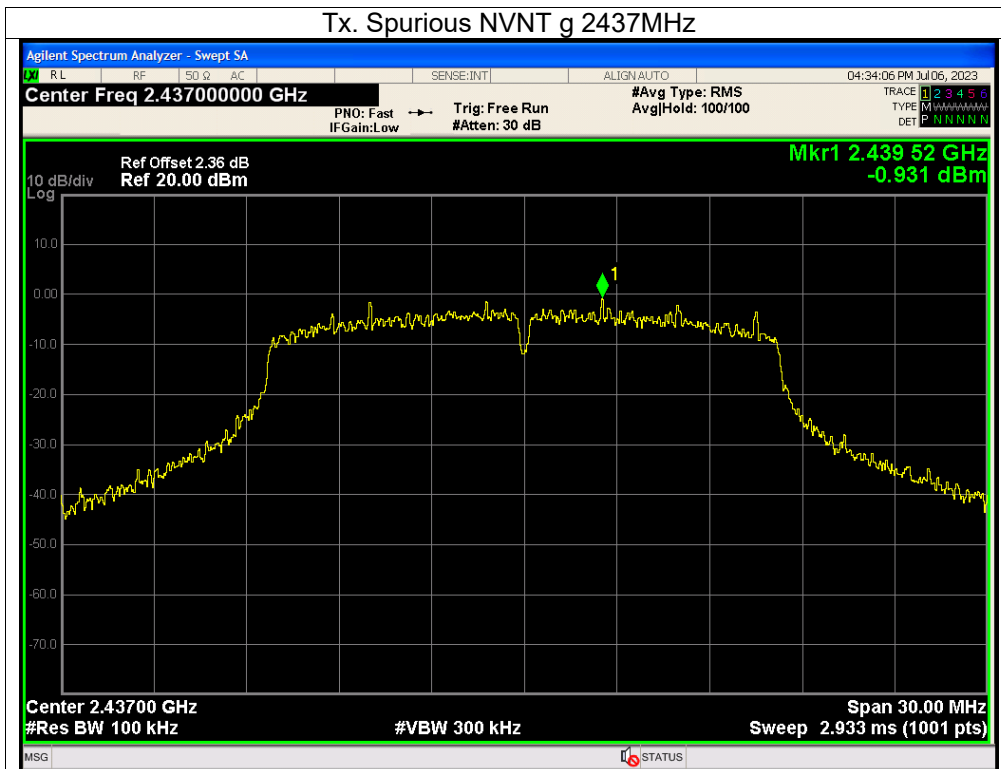

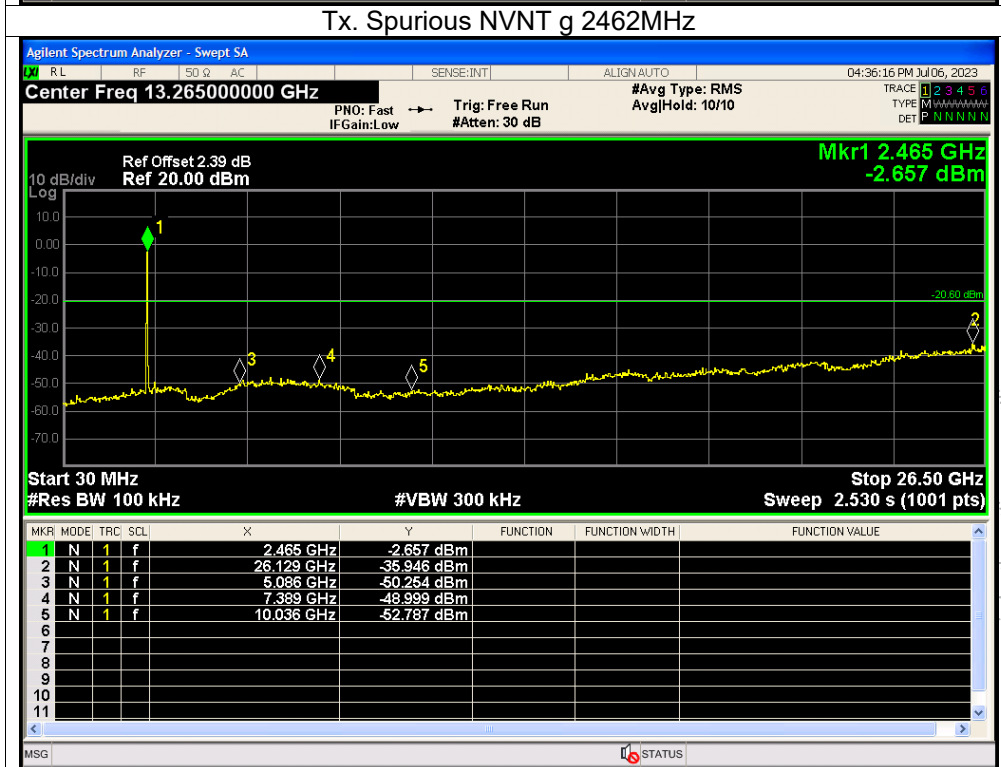
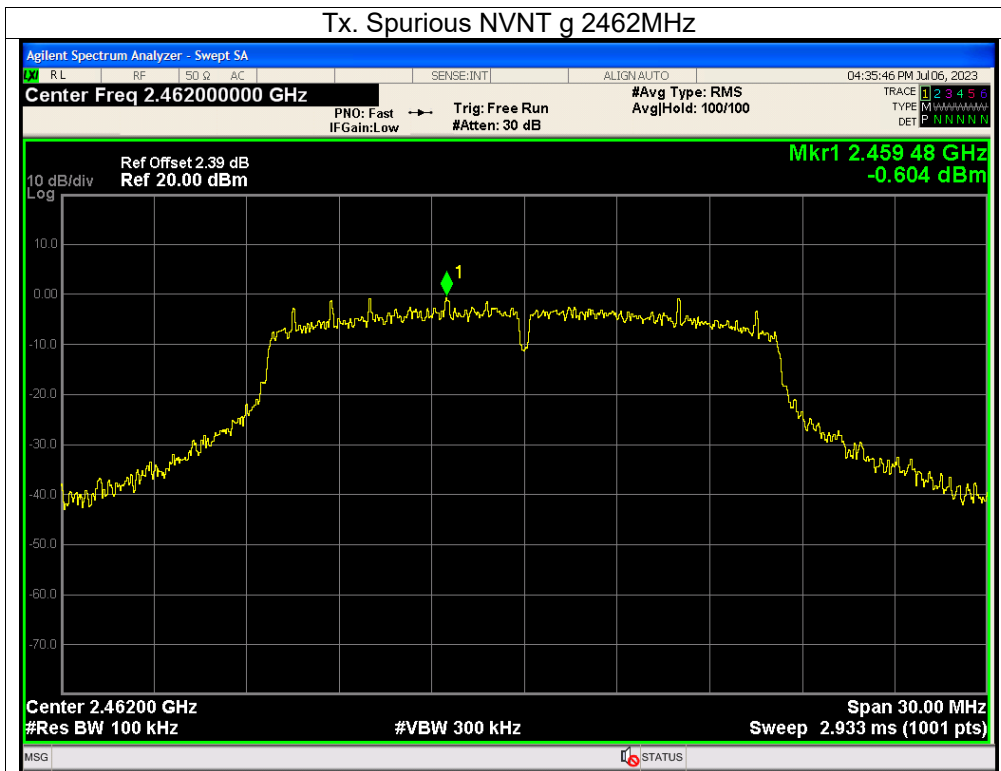

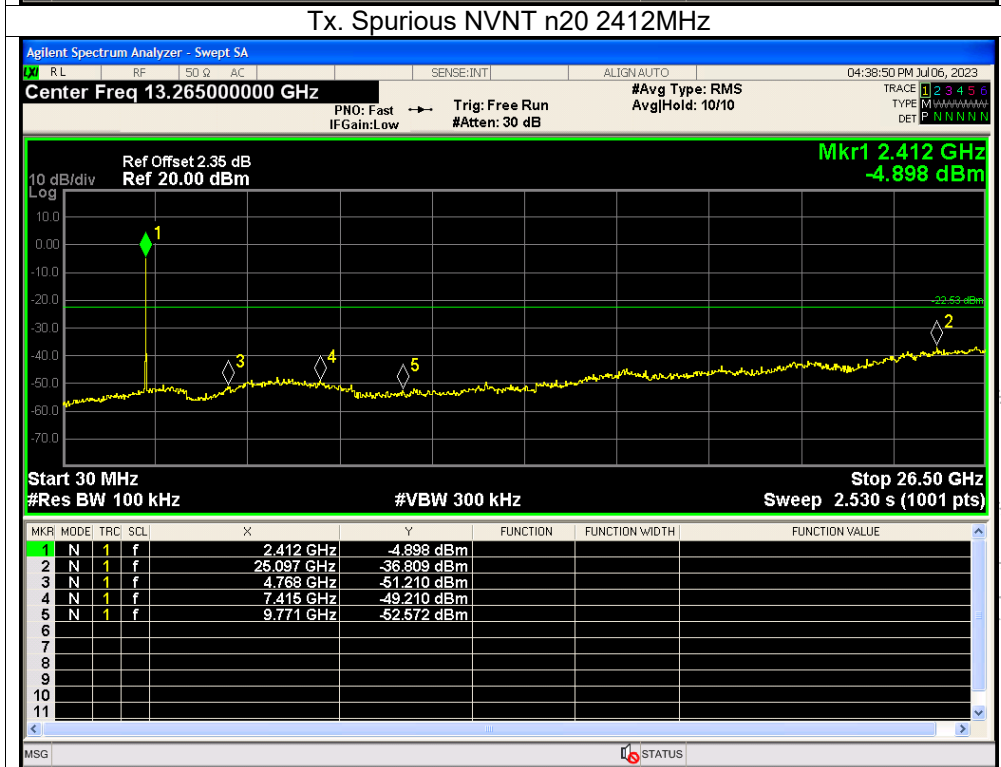
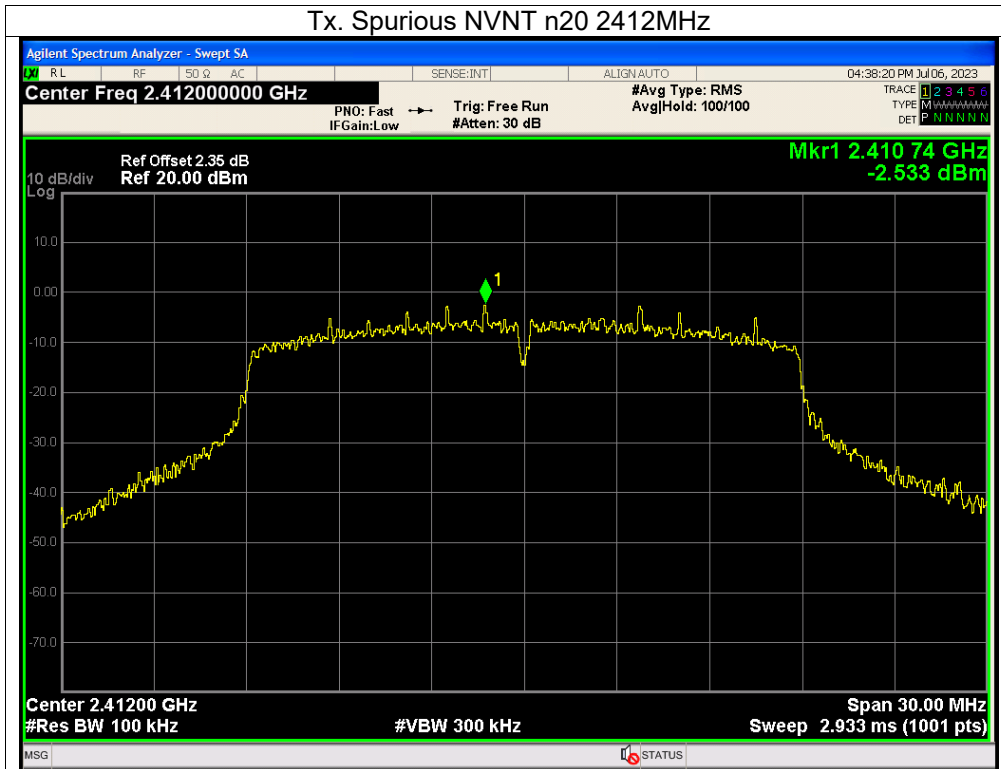

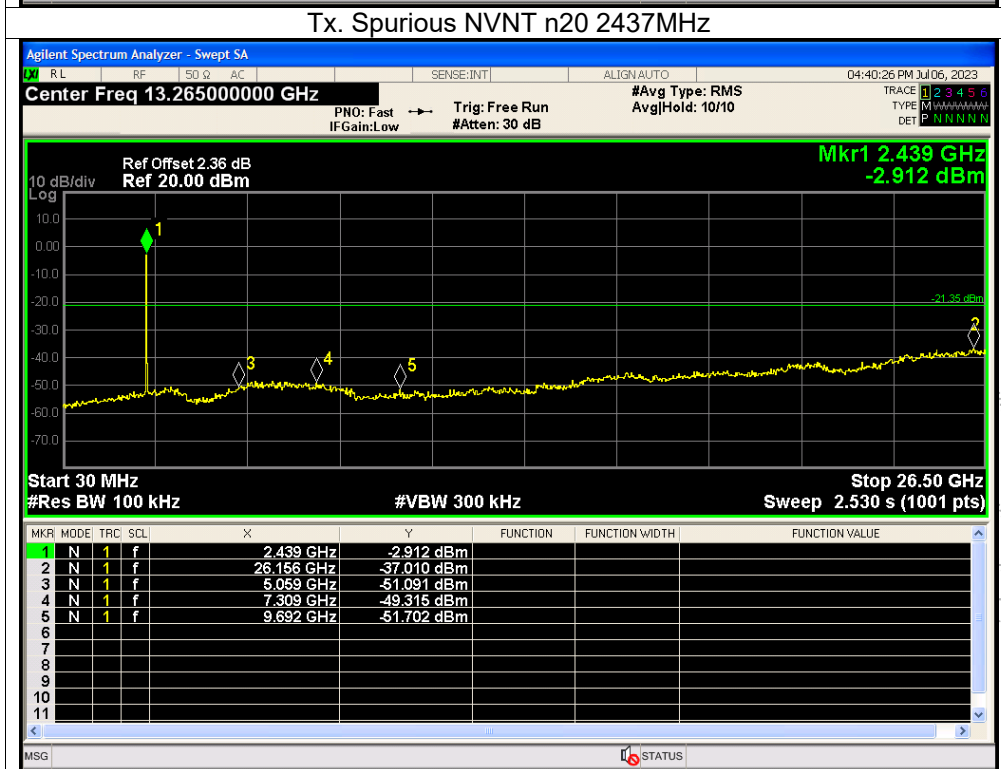
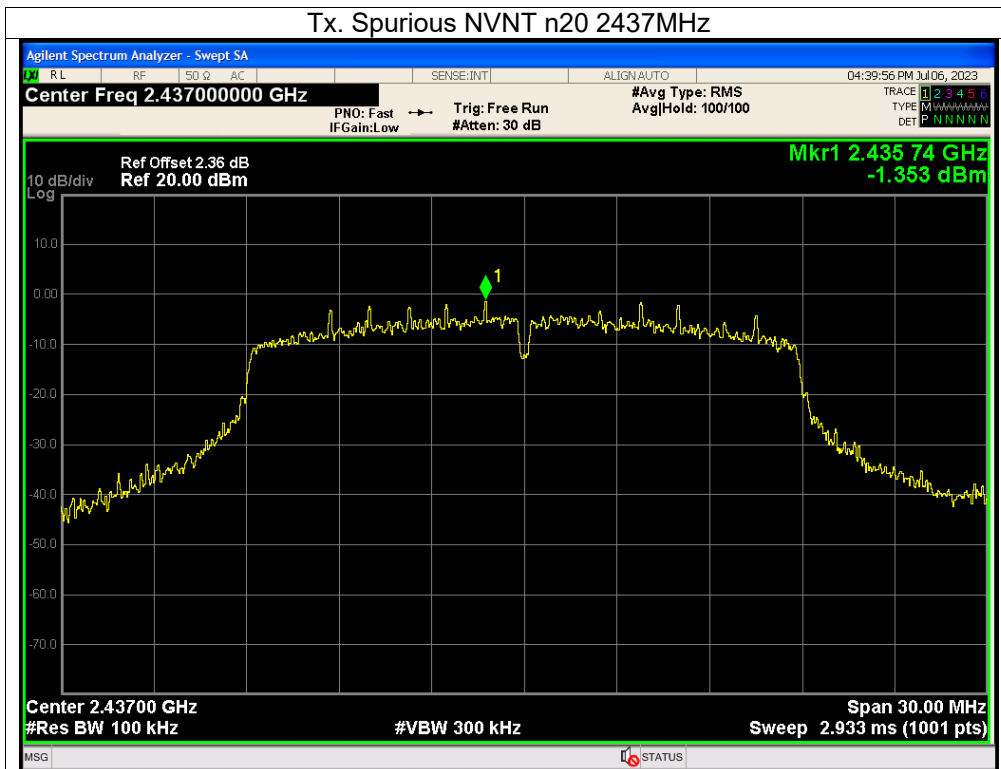

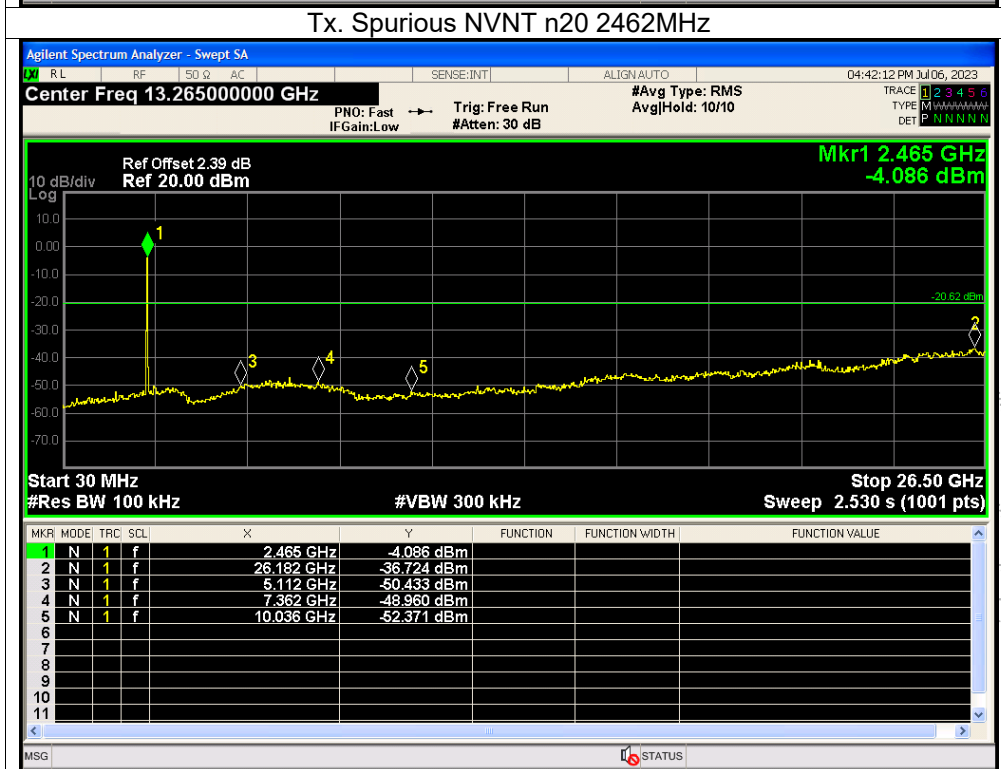
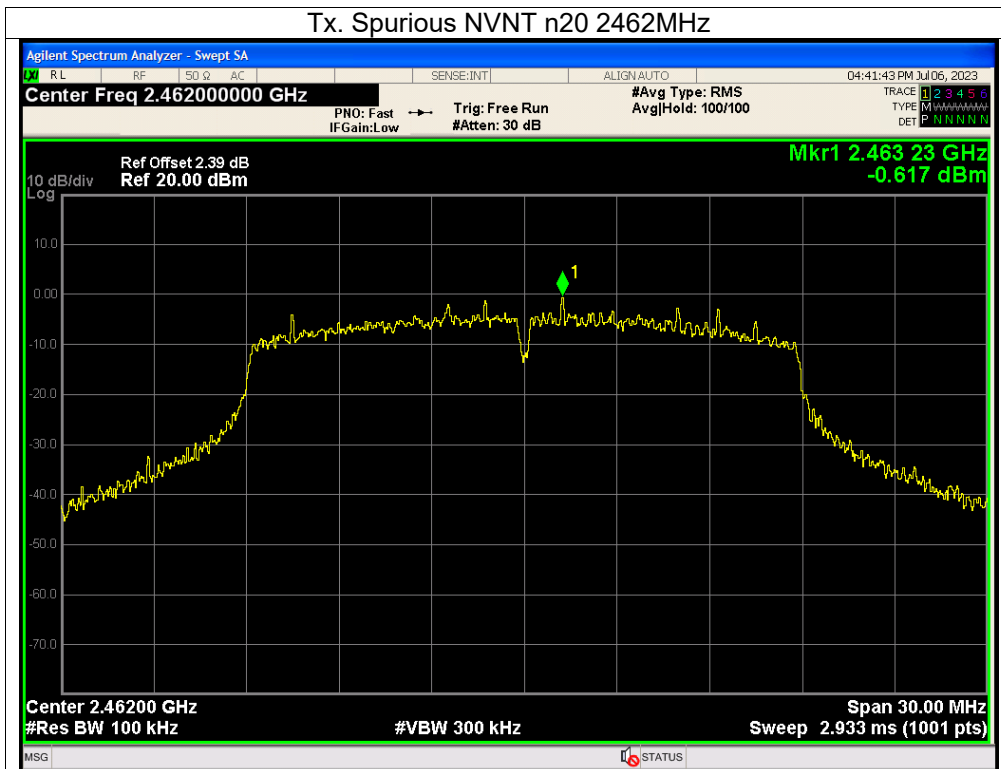

CO.LTD

13. Duty Cycle Of Test Signal

13.1 Standard Requirement

Pre-analysis Check: While conducting average power measurement, duty cycle of each mode shall be checked to ensure its duty cycle in order to compensate for the loss due to insufficient ratio of duty cycle. All duty cycle is pre-scanned, and result as obtained below shows only the most representative ones where duty cycle is conducted as the given transmission with given virtual operation that expresses the percentage.

13.2 Formula

$$\text{Duty Cycle} = \text{Ton} / (\text{Ton} + \text{Toff})$$

13.3 Test Procedure

1. Set span = Zero
2. RBW = 8MHz
3. VBW = 8MHz,
4. Detector = Peak

13.4 Test Result

Condition	Mode	Frequency (MHz)	Duty Cycle (%)	Correction Factor (dB)	1/T (kHz)
NVNT	b	2412	100	0	0
NVNT	b	2437	100	0	0
NVNT	b	2462	100	0	0
NVNT	g	2412	100	0	0
NVNT	g	2437	100	0	0
NVNT	g	2462	100	0	0
NVNT	n20	2412	100	0	0
NVNT	n20	2437	100	0	0
NVNT	n20	2462	100	0	0

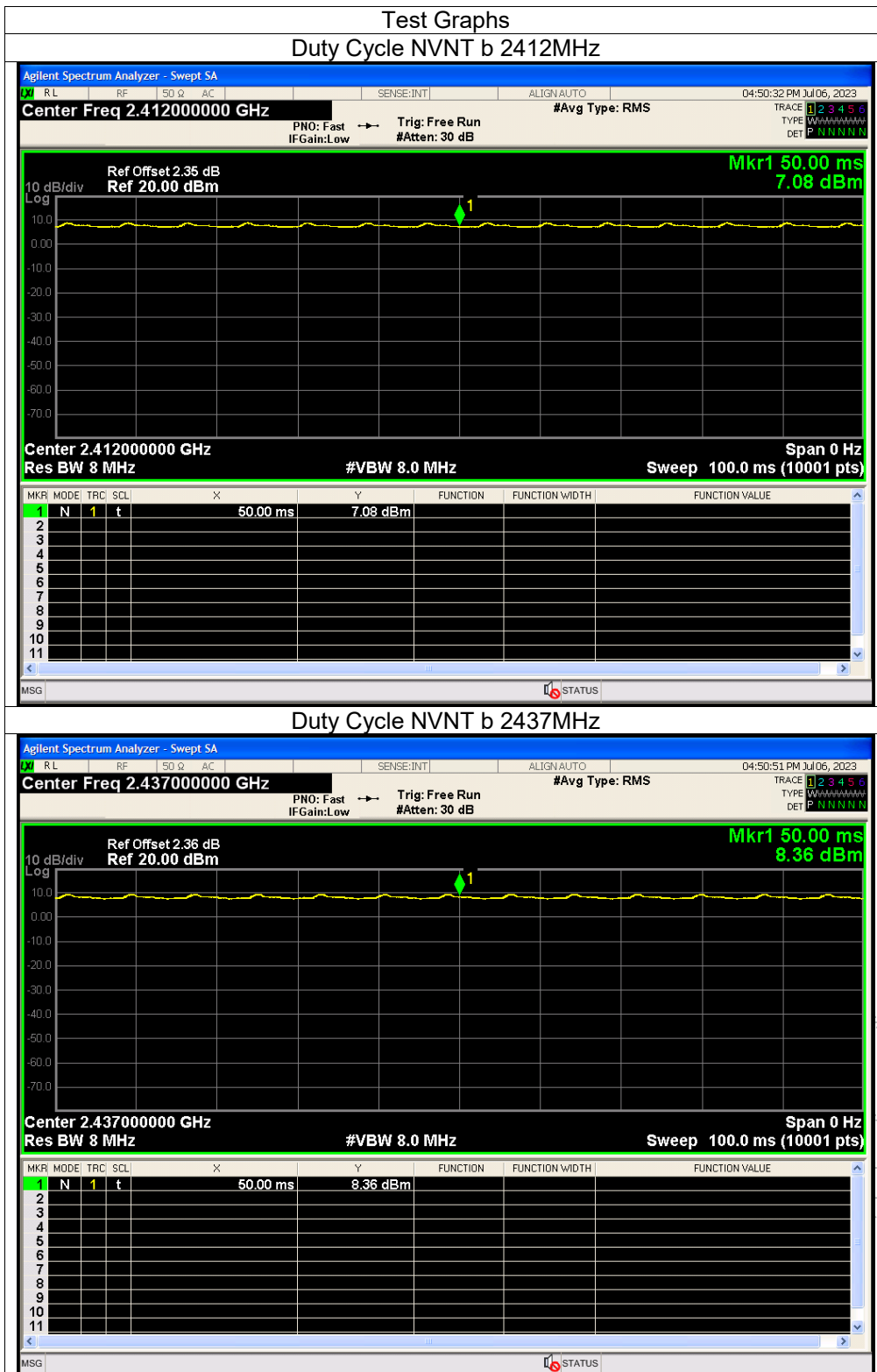

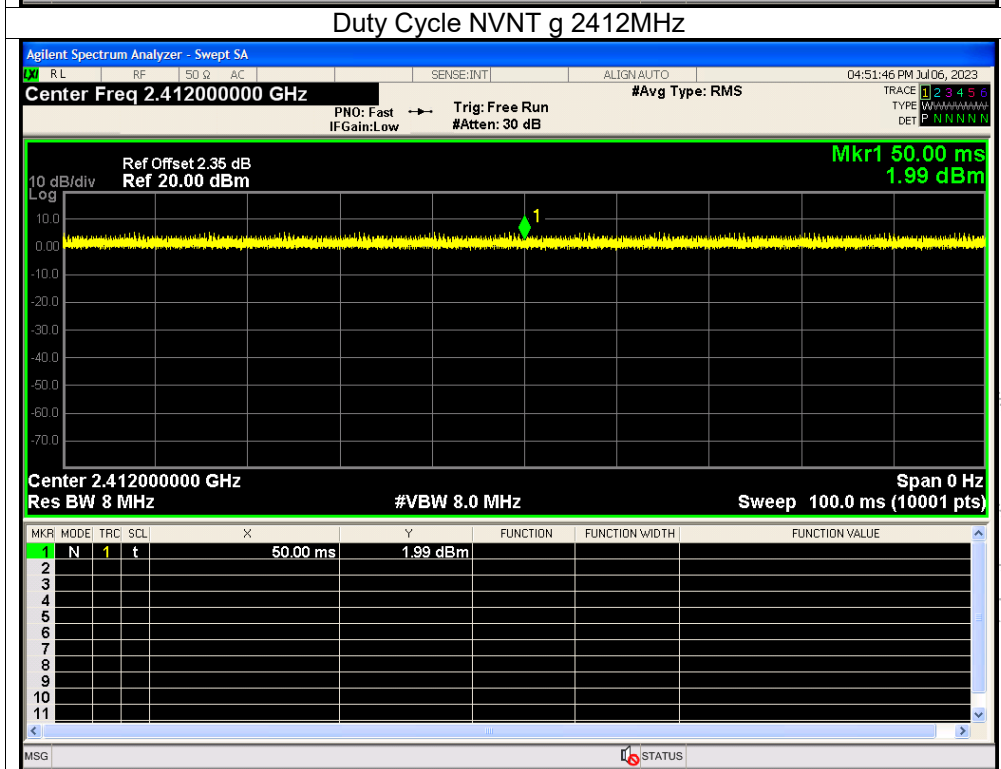
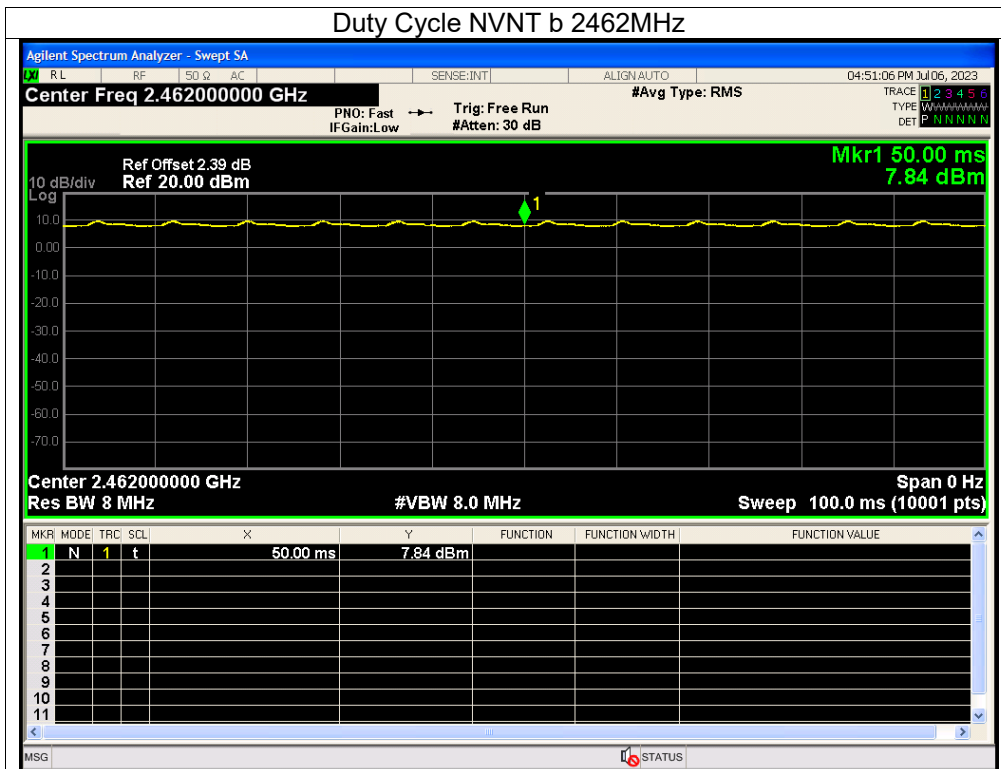

TC
 BC
 PPR
 測

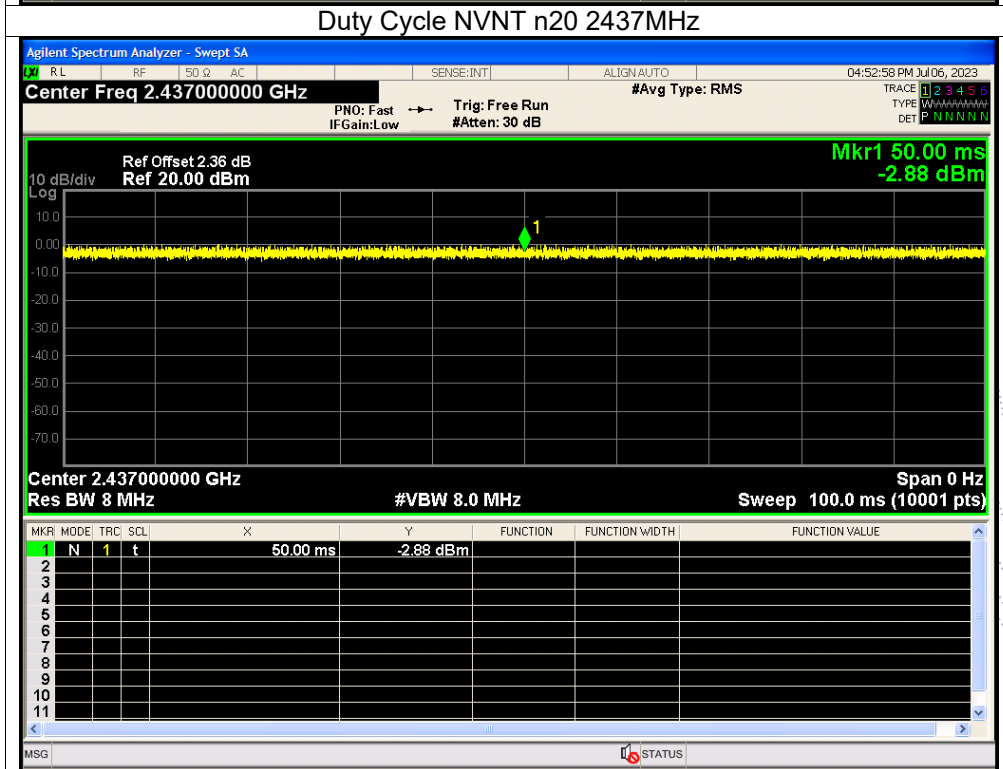
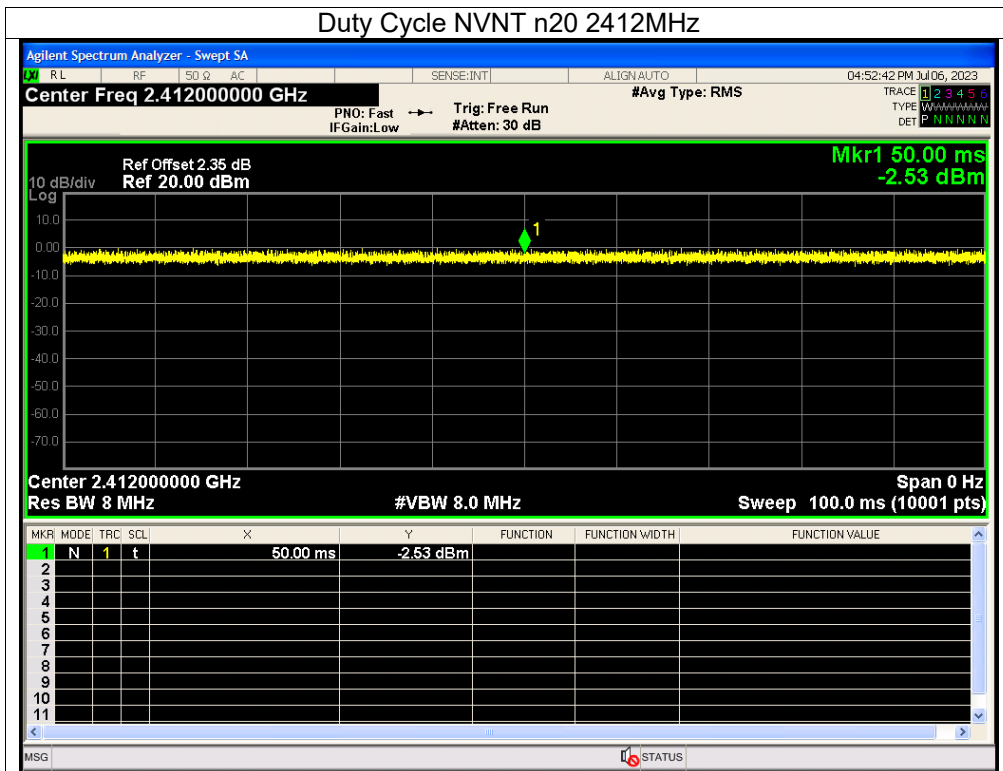

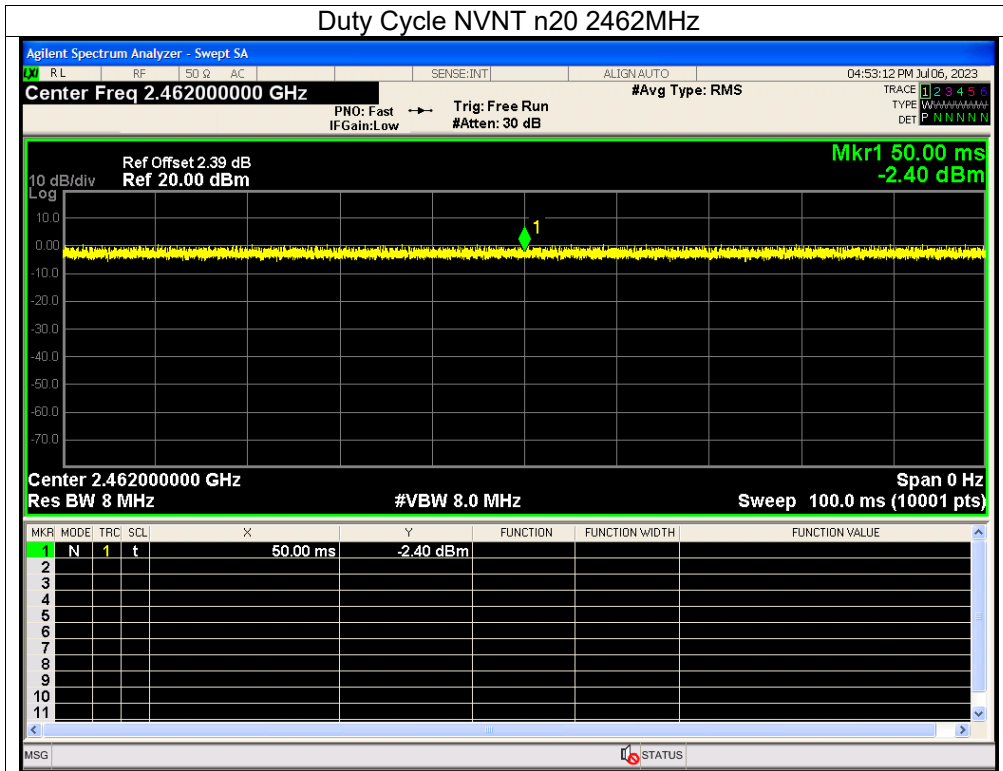

CO., LTD.

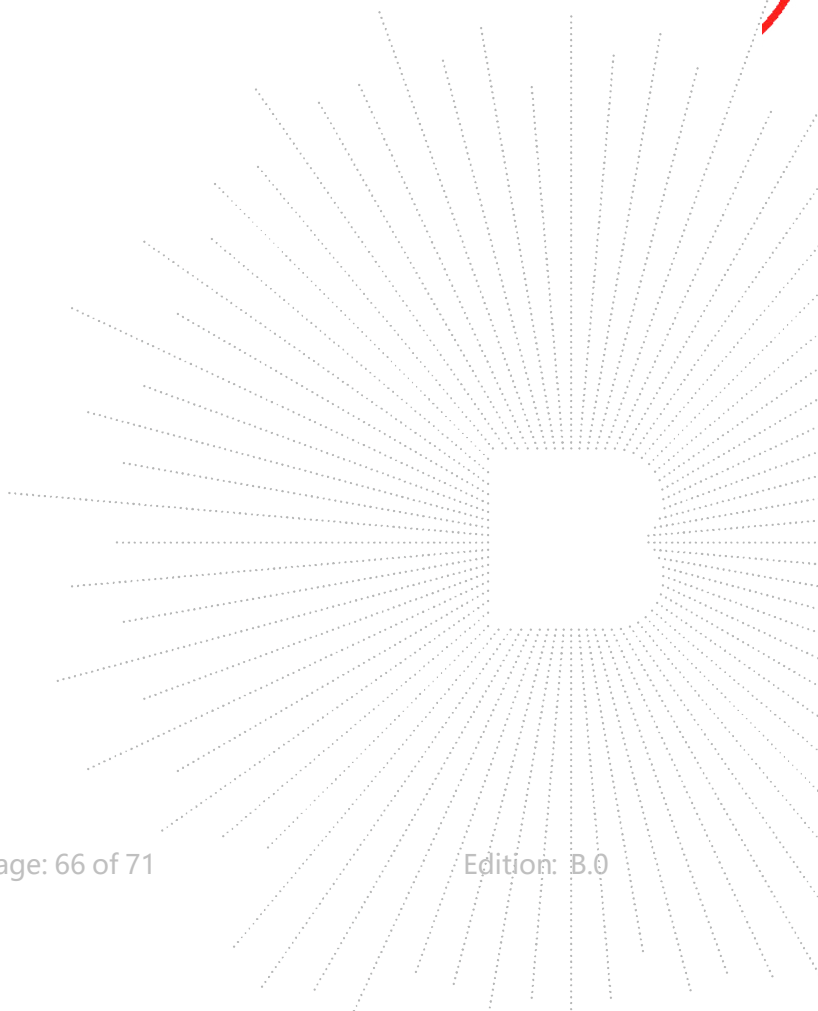

14. Antenna Requirement

14.1 Limit

15.203 requirement: For intentional device, according to 15.203: an intentional radiator shall be designed to ensure that no antenna other than that furnished by the responsible party shall be used with the device.

14.2 Test Result

The EUT antenna is FPCB antenna, The antenna gain is 5.18 dBi, fulfill the requirement of this section.

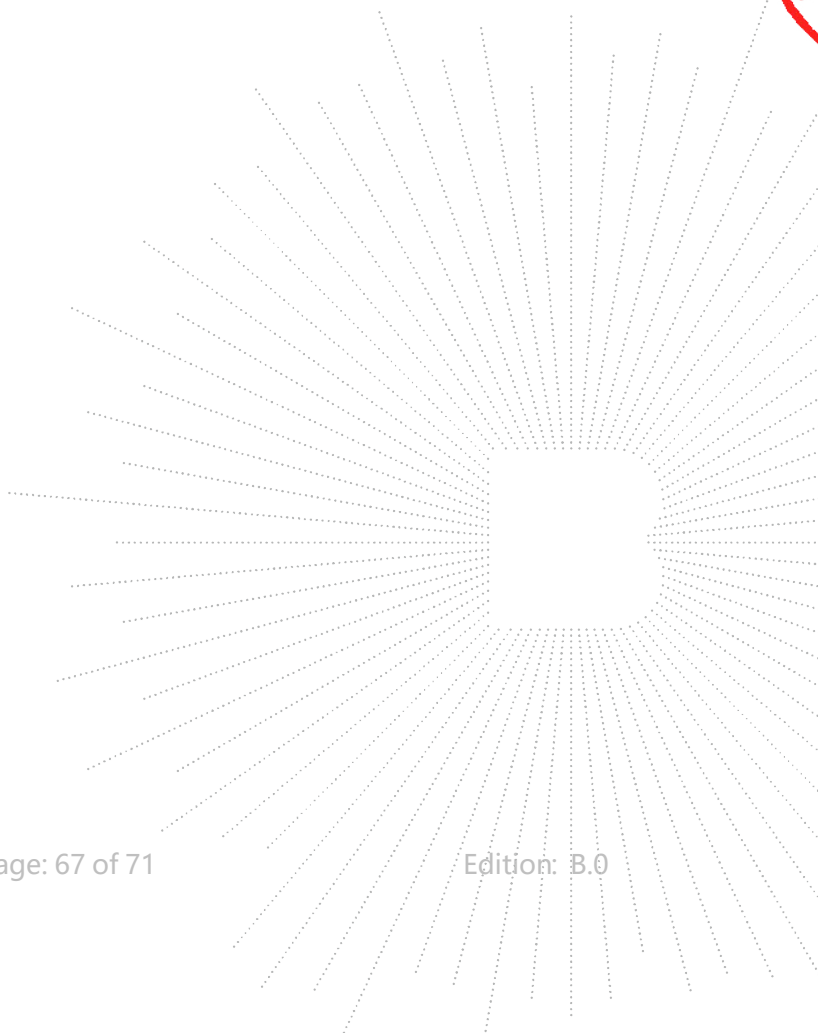

15. EUT Photographs

EUT Photo 1



EUT Photo 2



16. EUT Test Setup Photographs

Conducted Measurement Photo



Radiated Measurement Photos



C T
CT
PRO
测检

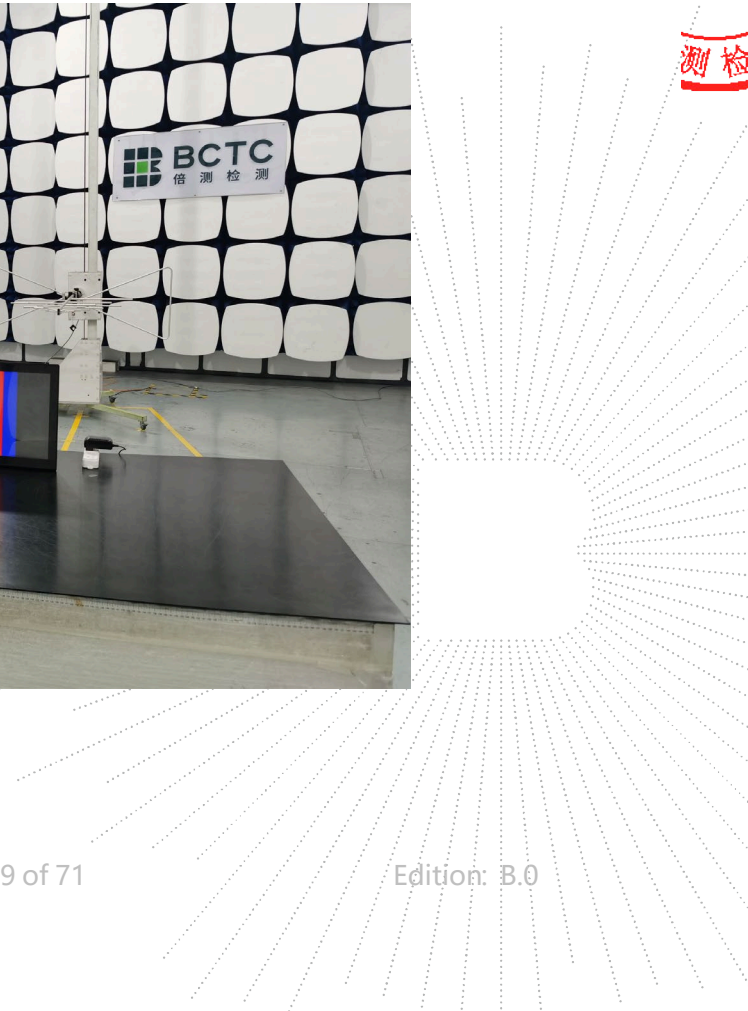

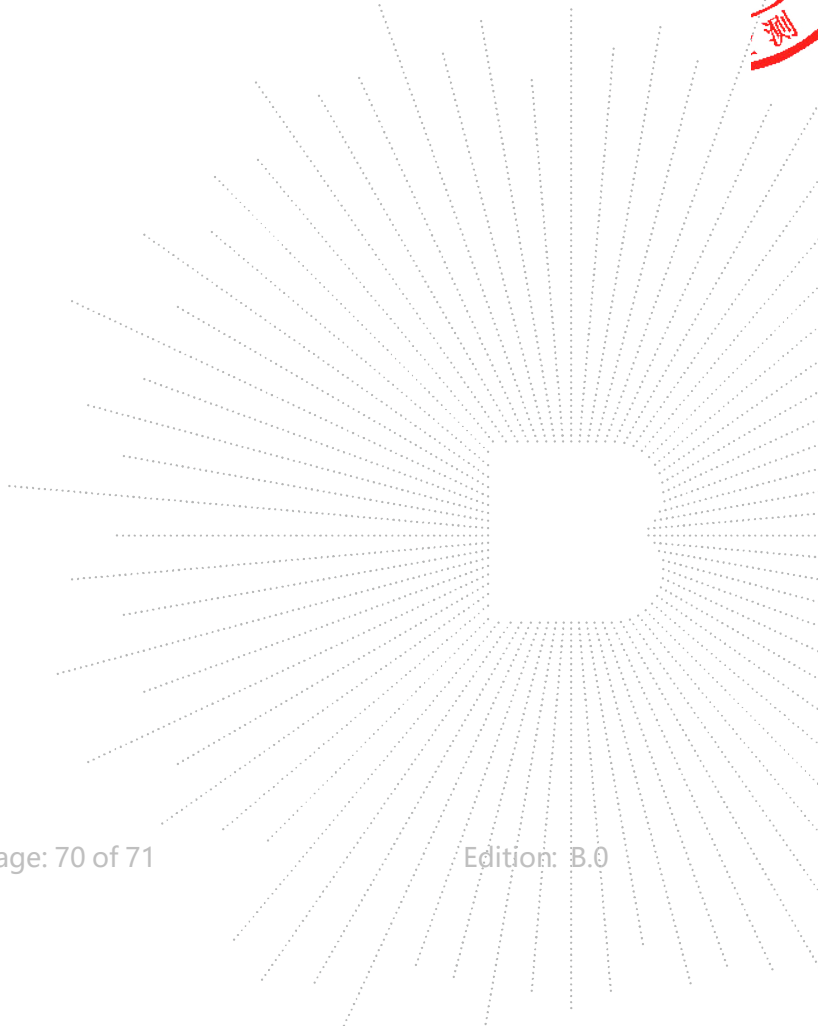

STATEMENT

1. The equipment lists are traceable to the national reference standards.
2. The test report can not be partially copied unless prior written approval is issued from our lab.
3. The test report is invalid without the "special seal for inspection and testing".
4. The test report is invalid without the signature of the approver.
5. The test process and test result is only related to the Unit Under Test.
6. Sample information is provided by the client and the laboratory is not responsible for its authenticity.
7. The quality system of our laboratory is in accordance with ISO/IEC17025.
8. If there is any objection to this test report, the client should inform issuing laboratory within 15 days from the date of receiving test report.

Address:

1-2/F., Building B, Pengzhou Industrial Park, No.158, Fuyuan 1st Road, Zhancheng, Fuhai Subdistrict, Bao'an District, Shenzhen, Guangdong, China

TEL: 400-788-9558

P.C.: 518103

FAX: 0755-33229357

Website: <http://www.chnbctc.com>

E-Mail: bctc@bctc-lab.com.cn

***** **END** *****

