



# FCC TEST REPORT

**Test report  
On Behalf of  
Guangzhou Smamao Electronic Technology Co., Ltd  
For  
Wireless charger  
Model No.: Q600;  
Series models please see page 2  
FCC ID: 2AKQO-Q600**

**Prepared for :** Guangzhou Smamao Electronic Technology Co., Ltd  
Room 811, Building 8, No.315, Central City Middle Road, Yuexiu District,  
Guangzhou, China

**Prepared By :** Shenzhen HUAKE Testing Technology Co., Ltd.  
1F, B2 Building, Junfeng Zhongcheng Zhizao Innovation Park, Fuhai Street,  
Bao'an District, Shenzhen City, China

**Date of Test:** Oct. 22, 2019 ~Oct. 28, 2019

**Date of Report:** Oct. 28, 2019

**Report Number:** HK1910162593-2E



### TEST RESULT CERTIFICATION

**Applicant's name** ..... : Guangzhou Smamao Electronic Technology Co., Ltd  
 Address ..... : Room 811, Building 8, No.315, Central City Middle Road,  
 Yuexiu District, Guangzhou, China

**Manufacture's Name** ..... : Shenzhen Smacat Electronic Technology Co., Ltd.  
 Address ..... : 6th Floor, Building A1, Yangbei Industrial Zone, Huangtian  
 Hangcheng, Baoan, Shenzhen, Guangdong, China

**Product description**

Trade Mark: N/A

Product name ..... : Wireless charger

Model and/or type reference : Q600, Q100, Q200, Q300, Q400, Q500, Q600, Q700, Q800,  
 Q900, Q110, Q220, Q330, Q440, Q550, Q660, Q770, Q880,  
 Q990, Q810, Q820, Q830, Q840, Q850, Q860, Q870, Q880,  
 Q890, Q10, Q20, Q30, Q40, Q50, Q60, Q70, Q80, Q90, Q11,  
 Q22, Q33, Q44, Q55, Q66, Q77, Q88, Q99, F610, F620, F630,  
 F640, F650, F660, F670, F680, F690, F780, F890, F310, F320,  
 F330, F340, F350, F360, F370, F380, F390, F410, F420, F430,  
 F440, F450, F460, F470, F480, F490, PA191A

**Standards** ..... : FCC Rules and Regulations Part 15 Subpart C (Section 15.209),  
 ANSI C63.10: 2013

This publication may be reproduced in whole or in part for non-commercial purposes as long as the Shenzhen HUAKE Testing Technology Co., Ltd. is acknowledged as copyright owner and source of the material. Shenzhen HUAKE Testing Technology Co., Ltd. takes no responsibility for and will not assume liability for damages resulting from the reader's interpretation of the reproduced material due to its placement and context.

**Date of Test** .....

Date (s) of performance of tests ..... : Oct. 22, 2019 ~Oct. 28, 2019

Date of Issue..... : Oct. 28, 2019

Test Result..... : **Pass**

Testing Engineer :   
 \_\_\_\_\_  
 (Gary Qian)

Technical Manager :   
 \_\_\_\_\_  
 (Eden Hu)

Authorized Signatory :   
 \_\_\_\_\_  
 (Jason Zhou)



<b>Table of Contents</b>	<b>Page</b>
1 . TEST SUMMARY	4
1.1 TEST PROCEDURES AND RESULTS	4
1.2 TEST FACILITY	4
1.3 MEASUREMENT UNCERTAINTY	4
2. GENERAL INFORMATION	5
2.1 General Description of EUT	5
2.2. Carrier Frequency of Channels	6
2.3 Operation of EUT during testing	6
2.4 Description of Test Setup	6
2.5 Measurement Instruments List	7
3. CONDUCTED EMISSION TEST	8
3.1 Block Diagram of Test Setup	8
3.2 Conducted Power Line Emission Limit	8
3.3 Test Procedure	8
3.4 Test Result	8
4. Occupied Bandwidth	11
4.1 Block Diagram of Test Setup	11
4.2 Rules and specifications	11
4.3 Test Procedure	11
4.4 Test Result	11
5. RADIA TED EMISSIONS	13
5.1 Block Diagram of Test Setup	13
5.2 Rules and specifications	14
5.3 Test Procedure	15
5.4 Test Result	15
6 ANTENNA REQUIREMENT	18
7. PHOTOGRAPH OF TEST	19
7.1 Radiated Emission	19
7.2 Conducted Emission	20
8. PHOTOGRAPH OF TEST	20



## 1. TEST SUMMARY

### 1.1 TEST PROCEDURES AND RESULTS

DESCRIPTION OF TEST	RESULT
CONDUCTED EMISSIONS TEST	COMPLIANT
RADIATED EMISSION TEST	COMPLIANT
OCCUPIED BANDWIDTH MEASUREMENT	COMPLIANT
ANTENNA REQUIREMENT	COMPLIANT

### 1.2 TEST FACILITY

Test Firm : Shenzhen HUAKE Testing Technology Co., Ltd.

Address : 1F, B2 Building, Junfeng Zhongcheng Zhizao Innovation Park, Fuhai Street, Bao'an District, Shenzhen City, China

### 1.3 MEASUREMENT UNCERTAINTY

Measurement Uncertainty	
Conducted Emission Expanded Uncertainty	= 2.23dB, k=2
Radiated emission expanded uncertainty(9kHz-30MHz)	= 3.08dB, k=2
Radiated emission expanded uncertainty(30MHz-1000MHz)	= 4.42dB, k=2
Radiated emission expanded uncertainty(Above 1GHz)	= 4.06dB, k=2



## 2. GENERAL INFORMATION

### 2.1 General Description of EUT

Equipment	Wireless charger
Model Name	Q600
Serial No.	Q100, Q200, Q300, Q400, Q500, Q600, Q700, Q800, Q900, Q110, Q220, Q330, Q440, Q550, Q660, Q770, Q880, Q990, Q810, Q820, Q830, Q840, Q850, Q860, Q870, Q880, Q890, Q10, Q20, Q30, Q40, Q50, Q60, Q70, Q80, Q90, Q11, Q22, Q33, Q44, Q55, Q66, Q77, Q88, Q99, F610, F620, F630, F640, F650, F660, F670, F680, F690, F780, F890, F310, F320, F330, F340, F350, F360, F370, F380, F390, F410, F420, F430, F440, F450, F460, F470, F480, F490, PA191A
Model Difference	All model's the function, software and electric circuit are the same, only with a product color and model named different. Test sample model: Q600.
Trade Mark	N/A
FCC ID	2AKQO-Q600
Antenna Type	Coil Antenna
Antenna Gain	Antenna 1:0dBi Antenna 2:0dBi
Operation frequency	125KHz
Number of Channels	1
Modulation Type	ASK
Power Source	Wire charging Input voltage: DC5V, 1A Output voltage: DC5V, 1A(USB 1) Output voltage: DC5V, 0.5A(USB 2) Wireless charging Input voltage: DC5V, 2A or DC9V, 1.8A Output voltage: DC5, 1A or DC5, 1.5A or DC9V, 1.1A
Power Rating	Wire charging Input voltage: DC5V, 1A Output voltage: DC5V, 1A(USB 1) Output voltage: DC5V, 0.5A(USB 2) Wireless charging Input voltage: DC5V, 2A or DC9V, 1.8A Output voltage: DC5, 1A or DC5, 1.5A or DC9V, 1.1A



## 2.2. Carrier Frequency of Channels

Operation Frequency each of channel	
Channel	Frequency
1	125KHz

## 2.3 Operation of EUT during testing

Operating Mode

The mode is used: Transmitting mode

## 2.4 Description of Test Setup

Operation of EUT during testing

```
graph LR; ACPlug[AC Plug] --- Adapter[Adapter]; Adapter --- EUT[EUT]; EUT --- MobilePhones[Mobile phones];
```

Setup: Transmission mode

- Adapter information  
Model: UP0920  
Input: AC100-240V~, 50/60Hz, 0.5A  
Output: 5VDC, 5V/9V, 2A
- Mobile phones information  
Model: S6  
Input: 5VDC  
Output: DC5V, 2A

The sample was placed 0.8m height above the ground plane of 3m chamber. Measurements in both horizontal and vertical polarities were performed. During the test, each emission was maximized by: having the EUT continuously working, investigated all operating modes, rotated about all 3 axis (X, Y & Z) and considered typical configuration to obtain worst position, manipulating interconnecting cables, rotating the turntable, varying antenna height from 1m to 4m in both horizontal and vertical polarizations. The emissions worst-case are shown in Test Results of the following pages. The worst case is X position



## 2.5 Measurement Instruments List

Item	Equipment	Manufacturer	Model No.	Serial No.	Last Cal.	Cal. Interval
1.	L.I.S.N. Artificial Mains Network	R&S	ENV216	HKE-002	Dec. 27, 2018	1 Year
2.	Receiver	R&S	ESCI 7	HKE-010	Dec. 27, 2018	1 Year
3.	RF automatic control unit	Tonscend	JS0806-2	HKE-060	Dec. 27, 2018	1 Year
4.	Spectrum analyzer	R&S	FSP40	HKE-025	Dec. 27, 2018	1 Year
5.	Spectrum analyzer	Agilent	N9020A	HKE-048	Dec. 27, 2018	1 Year
6.	Preamplifier	Schwarzbeck	BBV 9743	HKE-006	Dec. 27, 2018	1 Year
7.	EMI Test Receiver	Rohde & Schwarz	ESCI 7	HKE-010	Dec. 27, 2018	1 Year
8.	Bilog Broadband Antenna	Schwarzbeck	VULB9163	HKE-012	Dec. 27, 2018	1 Year
9.	Loop Antenna	Schwarzbeck	FMZB 1519 B	HKE-014	Dec. 27, 2018	1 Year
10.	Horn Antenna	Schwarzbeck	9120D	HKE-013	Dec. 27, 2018	1 Year
11.	Pre-amplifier	EMCI	EMC051845 SE	HKE-015	Dec. 27, 2018	1 Year
12.	Pre-amplifier	Agilent	83051A	HKE-016	Dec. 27, 2018	1 Year
13.	EMI Test Software EZ-EMC	Tonscend	JS1120-B Version	HKE-083	Dec. 27, 2018	N/A
14.	Power Sensor	Agilent	E9300A	HKE-086	Dec. 27, 2018	1 Year
15.	Spectrum analyzer	Agilent	N9020A	HKE-048	Dec. 27, 2018	1 Year
16.	Signal generator	Agilent	N5182A	HKE-029	Dec. 27, 2018	1 Year
17.	Signal Generator	Agilent	83630A	HKE-028	Dec. 27, 2018	1 Year
18.	Shielded room	Shiel Hong	4*3*3	HKE-039	Dec. 27, 2017	3 Year



### 3. CONDUCTED EMISSION TEST

#### 3.1 Block Diagram of Test Setup

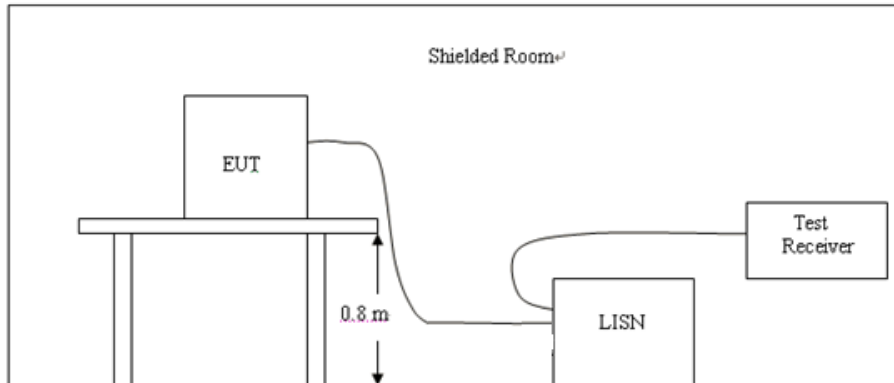

#### 3.2 Conducted Power Line Emission Limit

According to FCC Part 15.207(a)

Frequency (MHz)	Maximum RF Line Voltage (dBμV)			
	CLASS A		CLASS B	
	Q.P.	Ave.	Q.P.	Ave.
0.15 - 0.50	79	66	66-56*	56-46*
0.50 - 5.00	73	60	56	46
5.00 - 30.0	73	60	60	50

\* Decreasing linearly with the logarithm of the frequency

For intentional device, according to §15.207 Line Conducted Emission Limit is same as above table.

#### 3.3 Test Procedure

- 1, The equipment was set up as per the test configuration to simulate typical actual usage per the user's manual. The EUT is a tabletop system, a wooden table with a height of 0.8 meters is used and is placed on the ground plane as per ANSI C63.10.
- 2, Support equipment, if needed, was placed as per ANSI C63.10.
- 3, All I/O cables were positioned to simulate typical actual usage as per ANSI C63.10.
- 4, If a EUT received DC power from the USB Port of Notebook PC, the PC's adapter received AC120V/60Hz power through a Line Impedance Stabilization Network (LISN) which supplied power source and was grounded to the ground plane.
- 5, All support equipments received AC power from a second LISN, if any.
- 6, The EUT test program was started. Emissions were measured on each current carrying line of the EUT using a spectrum Analyzer / Receiver connected to the LISN powering the EUT. The LISN has two monitoring points: Line 1 (Hot Side) and Line 2 (Neutral Side). Two scans were taken: one with Line 1 connected to Analyzer / Receiver and Line 2 connected to a 50 ohm load; the second scan had Line 1 connected to a 50 ohm load and Line 2 connected to the Analyzer / Receiver.
- 7, Analyzer / Receiver scanned from 150 KHz to 30MHz for emissions in each of the test modes

#### 3.4 Test Result

PASS





**Remark: We tested the voltage in 5V/9V DC,  
worst case ANTENNA 1(Wireless charging output 9V DC) was recorded.**

**Please refer to following diagram for individual**

Test Specification: Line

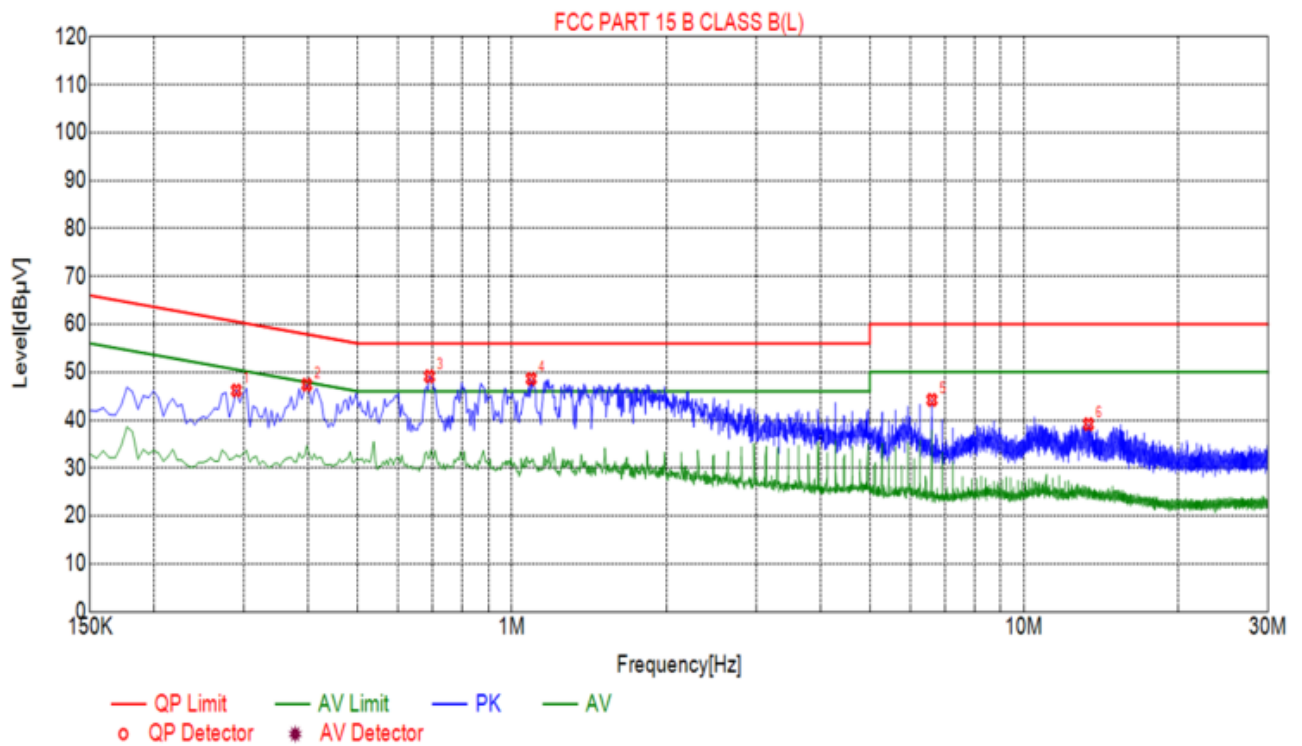

Suspected List						
NO.	Freq. [MHz]	Level [dBµV]	Factor [dB]	Limit [dBµV]	Margin [dB]	Detector
1	0.2895	46.19	10.03	60.54	14.35	PK
2	0.3975	47.38	10.04	57.91	10.53	PK
3	0.6900	49.12	10.05	56.00	6.88	PK
4	1.0905	48.62	10.07	56.00	7.38	PK
5	6.6120	44.22	10.21	60.00	15.78	PK
6	13.3710	39.14	9.96	60.00	20.86	PK

Remark: Factor = Cable lose + LISN factor; Margin = Limit – Level



Test Specification: Neutral

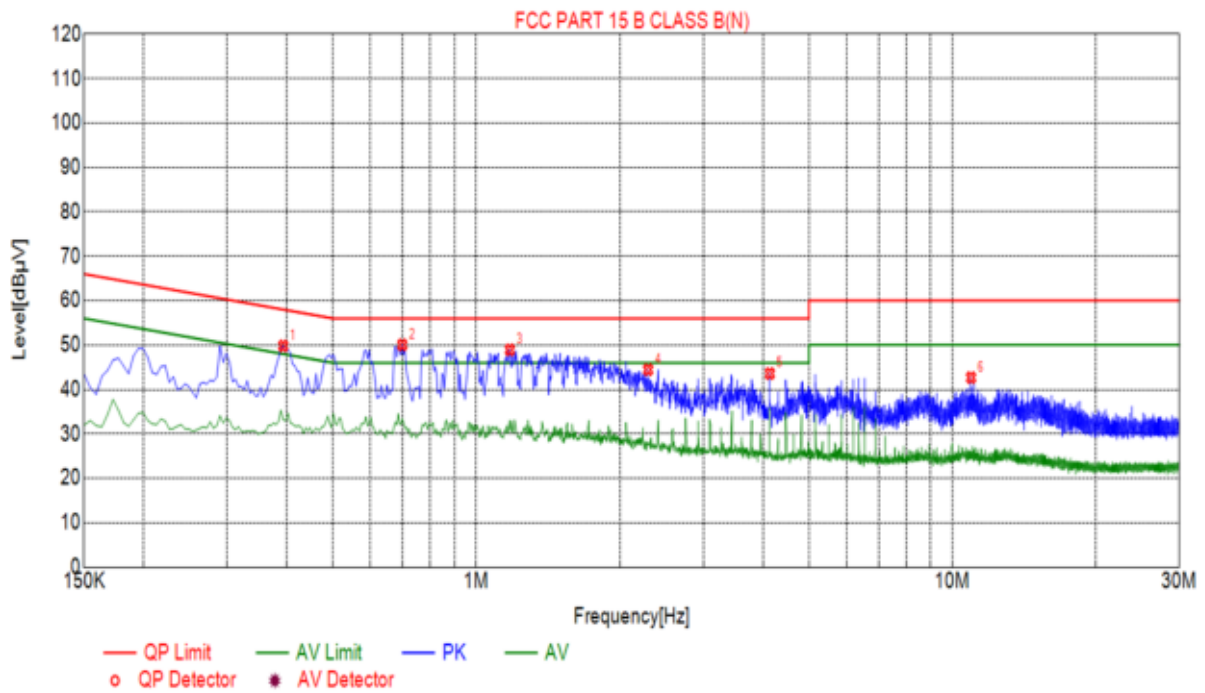

Suspected List						
NO.	Freq. [MHz]	Level [dBµV]	Factor [dB]	Limit [dBµV]	Margin [dB]	Detector
1	0.3930	49.83	10.04	58.00	8.17	PK
2	0.6990	50.06	10.05	56.00	5.94	PK
3	1.1760	48.94	10.09	56.00	7.06	PK
4	2.2965	44.46	10.18	56.00	11.54	PK
5	4.1370	43.60	10.25	56.00	12.40	PK
6	10.9500	42.68	10.02	60.00	17.32	PK

Remark: Factor = Cable lose + LISN factor; Margin = Limit – Level



#### 4. Occupied Bandwidth

##### 4.1 Block Diagram of Test Setup

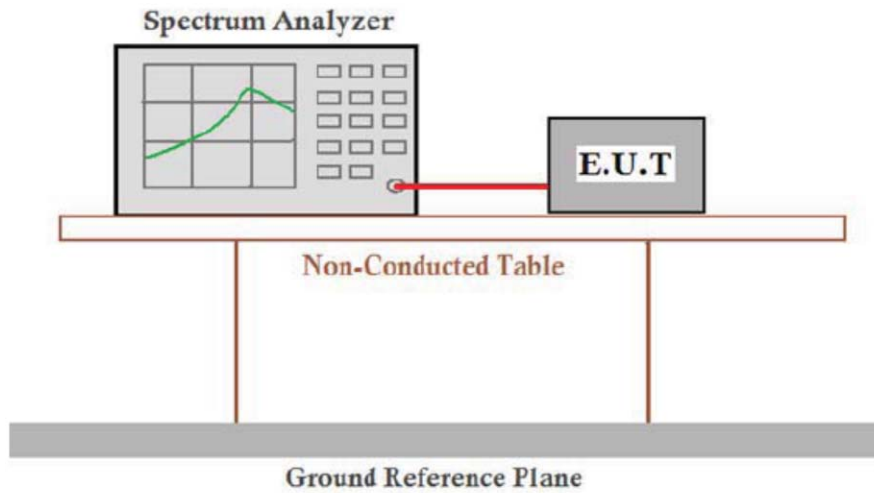

##### 4.2 Rules and specifications

CFR 47 Part 15.215(c)

ANSI C63.10-2013

##### 4.3 Test Procedure

Intentional radiators operating under the alternative provisions to the general emission limits, as contained in §§15.217 through 15.257 and in subpart E of this part, must be designed to ensure that 20dB bandwidth of the emission, or whatever bandwidth may otherwise be specified in the specific rule section under which the equip compliance with the 20dB attenuation specification may base on measurement at the intentional radiator's antenna output terminal unless the intentional radiator uses a permanently attached antenna, in which case compliance shall be demonstrated by measuring the radiated emissions.

##### 4.4 Test Result

PASS

Mode	Freq (KHz)	20dB Bandwidth (KHz)	Limit (kHz)	Conclusion
Tx Mode	125	2.702	/	PASS

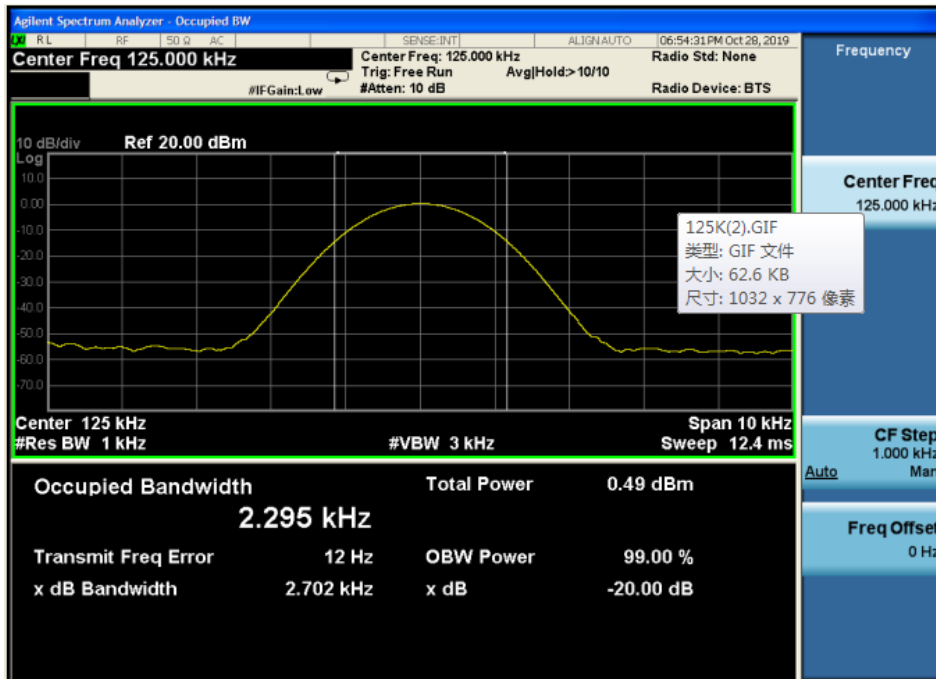

## 5. RADIA TED EMISSIONS

### 5.1 Block Diagram of Test Setup

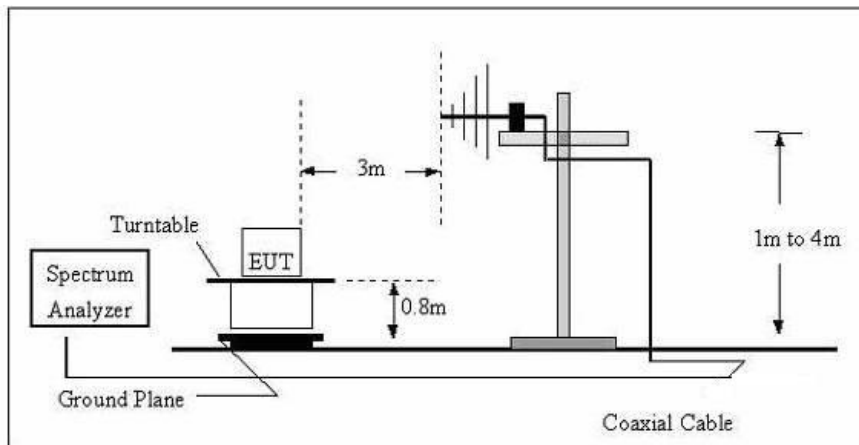
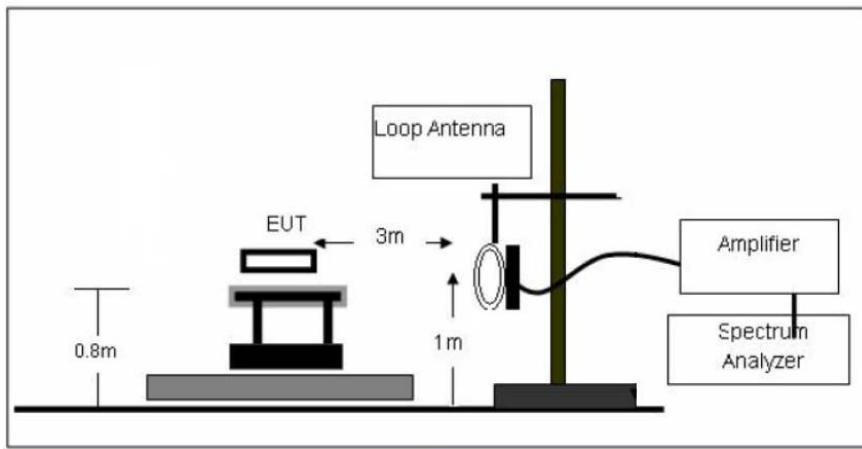



### 5.2 Rules and specifications

CFR 47 Part 15, section 15.205

Only spurious emissions are permitted in any of the frequency bands listed the tables in these sections.

MHz	MHz	MHz	GHz
0.090-0.110	16.42-16.423	399.9-410	4.5-5.15
1\ 0.495-0.505	16.69475-16.69525	608-614	5.35-5.46
2.1735-2.1905	16.80425-16.80475	960-1240	7.25-7.75
4.125-4.128	25.5-25.67	1300-1427	8.025-8.5
4.17725-4.17775	37.5-38.25	1435-1626.5	9.0-9.2
4.20725-4.20775	73-74.6	1645.5-1646.5	9.3-9.5
6.215-6.218	74.8-75.2	1660-1710	10.6-12.7
6.26775-6.26825	108-121.94	1718.8-1722.2	13.25-13.4
6.31175-6.31225	123-138	2200-2300	14.47-14.5
8.291-8.294	149.9-150.05	2310-2390	15.35-16.2
8.362-8.366	156.52475-156.52525	2483.5-2500	17.7-21.4
8.37625-8.38675	156.7-156.9	2690-2900	22.01-23.12
8.41425-8.41475	162.0125-167.17	3260-3267	23.6-24.0
12.29-12.293	167.72-173.2	3332-3339	31.2-31.8
12.51975-12.52025	240-285	3345.8-3358	36.43-36.5
12.57675-12.57725	322-335.4	3600-4400	(2)
13.36-13.41			

CFR 47 Part 15, section 15.209

The emissions from an intentional radiator shall not exceed the limits in the tables in these sections using an average detector

Frequency (MHz)	Field strength (microvolts/meter)	Measurement distance (meters)
0.009-0.490	2400/F (kHz)	300
0.490-1.705	24000/F (kHz)	30
1.705-30.0	30	30
30-88	100**	3
88-216	150**	3
216-960	200**	3
Above 960	500	3

Limit calculation and transfer to 3m distance as showed in the following table:

Frequency (MHz)	Limit (dBuV/m)	Distance (m)
0.009-0.490	$20\log(2400/F(KHz))+40\log(300/3)$	3
0.490-1.705	$20\log(24000/F(KHz))+40\log(30/3)$	3
1.705-30.0	69.5	3
30-88	40.0	3
88-216	43.5	3
216-960	46.0	3
Above 960	54.0	3

CFR 47 Part 15, section 15.35

When average radiated emission measurements are specified, the limit on the peak level of the radio Frequency emission is 20dB above the maximum permitted average emission limit.

Transmitter Spurious Emissions 9KHz-30MHz			
	9-150KHz	150-490KHz	490KHz-30MHz
Resolution Bandwidth	200Hz	9KHz	9KHz
Video Bandwidth	2KHz	100KHz	100KHz
Detector	Peak	Peak	Peak
Trace Mode	Max Hold	Max Hold	Max Hold
Sweep Time	Auto	Auto	Auto



### 5.3 Test Procedure

Measurement distance 3m

For the measurement range up to 30MHz in the following plots the field strength result from 3m Distance measurement are extrapolated to 300m and 30m distance respectively, by 40dB/decade, According to part 15.31(f)(2), per antenna factor scaling.

Measurements below 1000MHz are performed with a peak detector and compared to average limits, Measurements with an average detector are not required.

Note:

For battery operated equipment, the equipment tests shall be performed using a new battery.

### 5.4 Test Result

PASS

For 9KHz-30MHz

Freq. (MHz)	Detector Mode (PK/QP/AV)	Reading (dBuV)	Factor (dB)	Actual FS (dBuV/m)	Limits 3m (dBuV/m)	Margin (dBuV/m)
0.110	AV	23.77	24.80	48.57	106.78	58.21
0.125	AV	47.17	24.80	71.97	105.67	33.70
0.486	AV	27.85	25.03	52.88	93.87	40.99
0.500	Peak	26.26	25.03	51.29	73.62	22.33



For 30MHz-1GHz

Remark: We tested the voltage in 5V/9V DC, worst case ANTENNA 1(Wireless charging output 9V DC) was recorded.

Antenna polarity: H

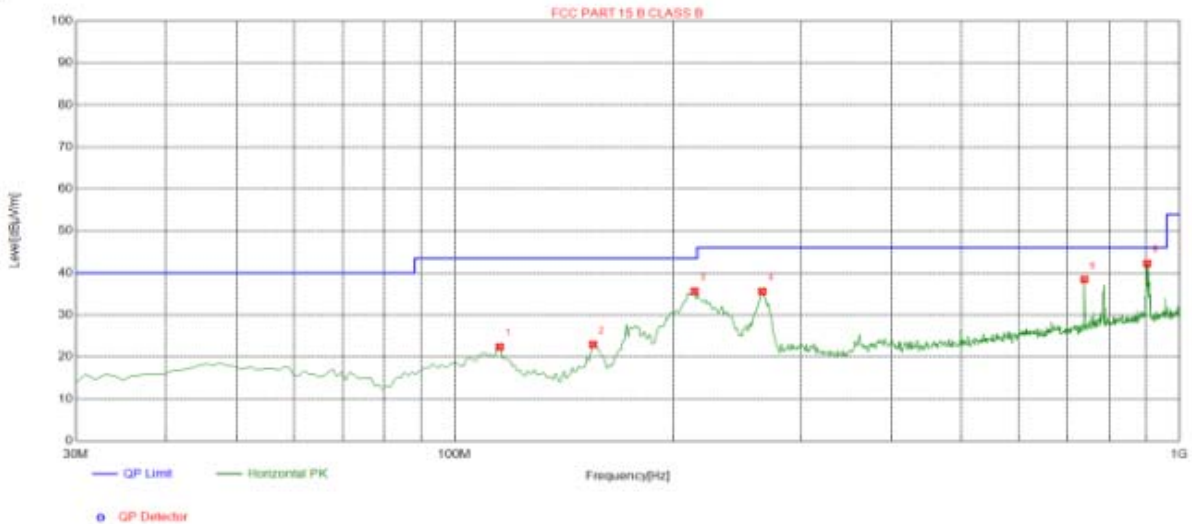

Suspected List								
NO.	Freq. [MHz]	Level [dBµV/m]	Factor [dB]	Limit [dBµV/m]	Margin [dB]	Height [cm]	Angle [°]	Polarity
1	115.360	22.45	-16.33	43.50	21.05	100	32	Horizontal
2	155.130	23.03	-18.57	43.50	20.47	100	284	Horizontal
3	214.300	35.65	-14.70	43.50	7.85	100	278	Horizontal
4	265.710	35.59	-13.60	46.00	10.41	100	177	Horizontal
5	739.070	38.45	-4.17	46.00	7.55	100	32	Horizontal
6	903.000	42.29	-1.77	46.00	3.71	100	32	Horizontal

Remark: Factor = Cable lose + Antenna factor - Pre-amplifier; Margin = Limit – Level





Antenna polarity: V

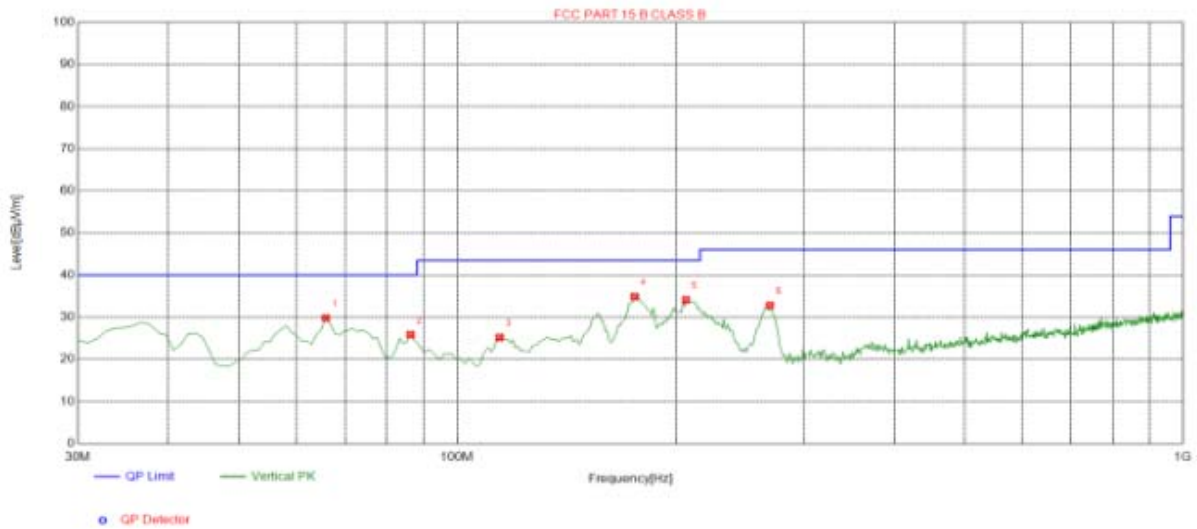

Suspected List								
NO.	Freq. [MHz]	Level [dBµV/m]	Factor [dB]	Limit [dBµV/m]	Margin [dB]	Height [cm]	Angle [°]	Polarity
1	65.8900	29.80	-16.64	40.00	10.20	100	47	Vertical
2	86.2600	25.86	-17.97	40.00	14.14	100	123	Vertical
3	114.390	25.19	-16.16	43.50	18.31	100	195	Vertical
4	175.500	34.90	-17.06	43.50	8.60	100	186	Vertical
5	206.540	34.13	-14.89	43.50	9.37	100	220	Vertical
6	269.590	32.84	-13.65	46.00	13.16	100	12	Vertical

Remark: Factor = Cable lose + Antenna factor - Pre-amplifier; Margin = Limit – Level

## 6 ANTENNA REQUIREMENT

### Standard Applicable

For intentional device, according to FCC 47 CFR Section 15.203, an intentional radiator shall be designed to ensure that no antenna other than that furnished by the responsible party shall be used with the device.

### Refer to statement below for compliance.

The manufacturer may design the unit so that the user can replace a broken antenna, but the use of a standard antenna jack or electrical connector is prohibited. Further, this requirement does not apply to intentional radiators that must be professionally installed.

### Antenna Connected Construction

The antenna used in this product is a Coil Antenna, the best case gain of the antenna is Antenna port 1:0dBi and Antenna port 2:0dBi.

Antenna 1 and Antenna 2 cannot transmit simultaneously.

ANTENNA 1

ANTENNA 2

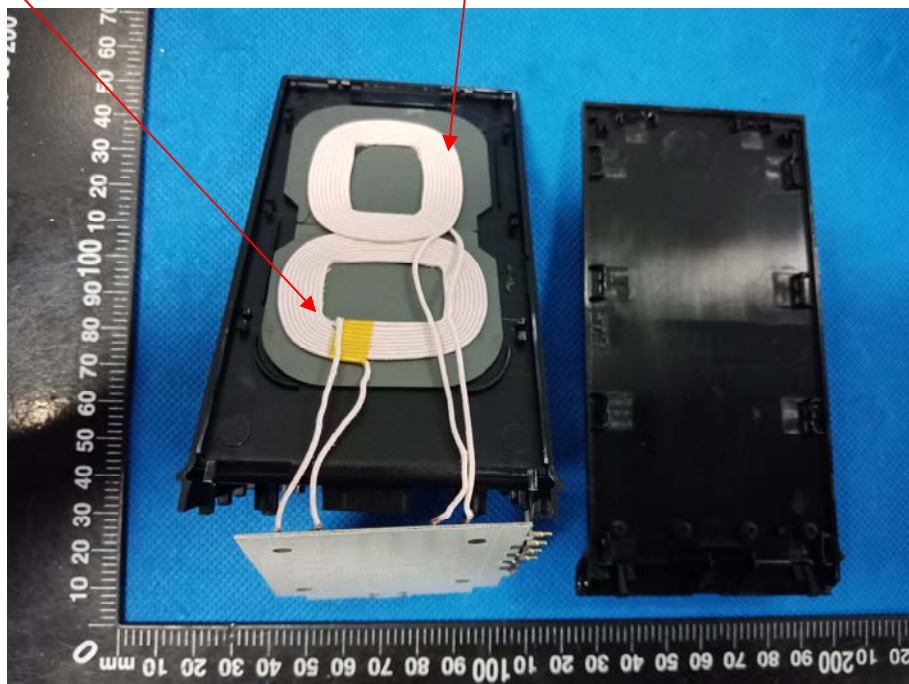

## 7. PHOTOGRAPH OF TEST

### 7.1 Radiated Emission





## 7.2 Conducted Emission

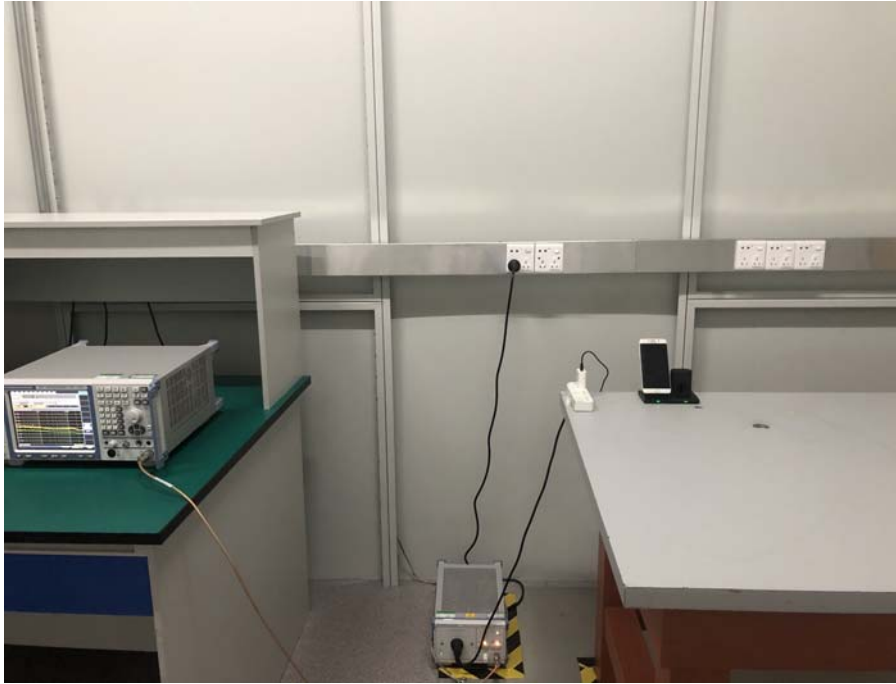

## 8. PHOTOGRAPH OF TEST

Reference to the reporter : ANNEX A of external photos and ANNEX B of internal photos

-----End of test report-----