

Interactive Touch Screen INSTRUCTION MANUAL



**Before connecting, operating or adjusting this product, please read the manual completely.
Please keep this manual for future reference.**

Contents

Important Information	1
Important Safety Precautions	2
Important Notice	4
Identification of Controls	5
Remote Control	6
Setting Up	7
Connections	8
Basic Operations	10
Device Settings	12
Network Settings	13
Menu List	19
Using USB Multi Media Player	21
Troubleshooting	24
Specifications	25

IMPORTANT INFORMATION

If the screen is not positioned in a stable location, it can be potentially hazardous due to falling. Many injuries, particularly to children, can be avoided by taking simple precautions such as:

- Use cabinets or stands recommended by the manufacturer of the screen.
- Only use furniture that can safely support the screen .
- Ensure the screen is not hanging over the edge of the supporting furniture.
- Do not place the screen on tall furniture (for example, cupboards or bookcases) without anchoring both the furniture and the screen to a suitable support.
- Do not position the screen on cloth or place any material between the screen and supporting furniture.
- Increase children's awareness of danger caused by falling down of the screen, or being hurt by bumping into the screen.
- Do not use immediately after moving from a low temperature to high temperature environment, as this causes condensation, which may result in fire, electric shock, or other hazards.
- To avoid possible condensation it is recommended to not use the device within 24 hours after its arrival, to avoid possible condensation.

Warning :

To prevent the spread of fire, keep candles or other open flames away from the screen all the times.

Important Safety Precautions

Electricity may cause personal injuries and property damage if improperly handled. The screen has been engineered and manufactured with the highest priority on safety. But **IMPROPER USE CAN RESULT IN POTENTIAL ELECTRIC SHOCK OR FIRE HAZARD**. In order to prevent potential danger, please observe the following instructions when installing, operating and cleaning the product. To ensure your safety and prolong the service life of your screen, please read the following precautions carefully before using the product.

- 1. Read these instructions**---All operating instructions must be read and understood before the product is operated.
 - 2. Keep these instructions**---These safety and operating instructions must be kept in a safe place for future reference.
 - 3. Note all warnings**---All warnings on the product and in the instruction manual must be observed closely.
 - 4. Follow all instructions**---All operating instructions must be followed.
 - 5. Attachments**---Only use attachments/accessories specified by the manufacturer. Do not use attachments which are not recommended by the manufacturer. Use of improper attachments can result in accidents.
 - 6. Power source**---This product is intended to be supplied with a listed power supply indicated on the marking label. If you are not sure of the type of power supply to your home, consult your product dealer or local power company. For added protection for this product during a lightning storm, or when it is left unattended and unused for a long period of time, unplug it from the wall outlet and disconnect the cable system.
 - 7. Power cord protection**---Protect the power cord from being walked on or pinched particularly at plugs, convenience receptacles, and the point where they exit from the apparatus.
- NOTE:** Where the mains plug or an appliance coupler is used as the disconnected device, the disconnected device shall remain readily operable.
- 8. Overloading**---Do not overload wall outlets, extension cords, or convenience receptacles on other equipment as this can result in a risk of fire or electric shock.
 - 9. Entering of objects and liquids**---Never insert an object into the product through vents or openings. High voltages are present in the product and inserting an object can cause electric shock and/or short internal parts. For the same reason, do not spill water or liquid on the product.

10. Servicing---Refer all servicing to qualified service personnel. Servicing is required when the apparatus has been damaged in any way, such as the power-supply cord or plug is damaged, liquid has been spilled or objects have fallen into the apparatus, the apparatus has been exposed to rain or moisture, does not operate normally or has been dropped.

11. Damage requiring service---If any of the following conditions occurs, unplug the power cord from the AC outlet and request a qualified service technician to perform repairs.

- When the power cord or plug is damaged.
- When liquid is spilled on the product or when objects have fallen into the product.
- When the product has been exposed to rain or water.
- When the product does not operate properly as described in the operating instructions.
- If the product has been dropped or the cabinet has been damaged in any way.
- When the product displays an abnormal condition or exhibits a distinct change in performance. Any noticeable abnormality in the product indicates that the product needs servicing.

12. Replacement parts---In case the product needs replacement parts, make sure that the service person uses replacement parts specified by the manufacturer, or those with the same characteristics and performance as the original parts. Use of unauthorized parts can result in fire, electric shock and/or other danger.

13. Safety checks---Upon completion of service or repair work, request the service technician to perform safety checks to ensure that the product is in proper operating condition.

14. Wall or ceiling mounting---When mounting the product on a wall or ceiling, be sure to install the product according to the method recommended by the manufacturer. This is a safety issue.

15. Stand---Use only with the trolley stand or wall mount specified by the manufacturer, or sold with the apparatus. Do not place the product on an unstable trolley stand or wall mount. Placing the product on an unstable base can cause the product to fall, resulting in possible serious injuries as well as damage to the product. When mounting the product on a wall, be sure to follow the manufacturer's instructions. Use only the mounting hardware recommended by the manufacturer.

16. Careful move---When a trolley is used, be cautious when moving the trolley/apparatus combination to avoid injury from the product tipping over. Sudden stops, excessive force and uneven floor surfaces can cause the product to fall from the trolley.

Never attempt to move the screen unless the AC Power cord has been disconnected.

Important Safety Precautions (Continued)

- 17. Lightning**---Unplug this apparatus during a thunder storm or when unused for long periods of time.

For added protection during a thunder storm, or when the screen is left unattended and unused for long periods of time, unplug it from the wall outlet and disconnect the antenna. This will prevent damage to the equipment due to lightning and power-line surges.

- 18. Do not use this apparatus near water**---for example, near a bathtub, washbowl, kitchen sink, laundry tub, in a wet basement or near a swimming pool, and the like. The apparatus should not be exposed to dripping or splashing liquids and that no objects filled with liquids, such as vases, shall be placed on the apparatus.

Do not use immediately after moving from a low temperature to high temperature environment, as this causes condensation, which may result in fire, electric shock, or other hazards.

- 19. Clean only with dry cloth**---Unplug this product from the wall outlet before cleaning. Do not use liquid cleaners or aerosol cleaners. Use a soft cloth for cleaning.

- 20. Ventilation**---Do not block any ventilation openings. Install the screen in accordance with the manufacturer instructions. The vents and other openings in the cabinet are designed for ventilation. Do not cover or block these vents and openings since insufficient ventilation can cause overheating and/or shorten the life of the product. Do not place the product on a bed, sofa, rug or other similar surface, since they can block ventilation openings. This product is not designed for built-in installation; therefore do not place the product in an enclosed space such as a bookcase or rack, unless proper ventilation is provided or the manufacturer's instructions are followed.

- 21. Heat sources**---Do not install near any heat sources such as radiators, heat registers, stoves, or other apparatus (including amplifiers) that produce heat.

- 22. Panel protection**---The display panel used in this product is made of glass. Therefore, it can break when the product is dropped or impacted upon by other objects. Be careful not to be injured by broken glass pieces in case the display panel breaks.

- 23. Pixel defect**---The display panel is a very high technology product, giving you finely detailed pictures. Occasionally, a few non-active pixels may appear on the screen as a fixed point of blue, green or red. Please note that this does not affect the performance of your product.

WARNING: For continued safety, apparatus with class I construction shall be connected to a mains socket outlet with a protective earthing connection.

Legal notices

FCC Statement

1. This device complies with Part 15 of the FCC Rules. Operation is subject to the following two conditions:
 - (1) This device may not cause harmful interference.
 - (2) This device must accept any interference received, including interference that may cause undesired operation.
2. Changes or modifications not expressly approved by the party responsible for compliance could void the user's authority to operate the equipment.

NOTE: This equipment has been tested and found to comply with the limits for a Class B digital device, pursuant to Part 15 of the FCC Rules. These limits are designed to provide reasonable protection against harmful interference in a residential installation.

This equipment generates uses and can radiate radio frequency energy and, if not installed and used in accordance with the instructions, may cause harmful interference to radio communications. However, there is no guarantee that interference will not occur in a particular installation. If this equipment does cause harmful interference to radio or television reception, which can be determined by turning the equipment off and on, the user is encouraged to try to correct the interference by one or more of the following measures:

Reorient or relocate the receiving antenna.

Increase the separation between the equipment and receiver.

Connect the equipment into an outlet on a circuit different from that to which the receiver is connected.

Consult the dealer or an experienced radio/TV technician for help.

FCC Radiation Exposure Statement:

This equipment complies with FCC radiation exposure limits set forth for an uncontrolled environment. In order to avoid the possibility of exceeding the FCC radio frequency exposure limits, Human proximity to the antenna shall not be less than 20cm (8 inches) during normal operation.

Important Notice

About Location/ Environment

Do not use in hot and cold rooms (locations)

- When the unit is used in rooms (locations) with low temperature, the picture may leave trails or appear slightly delayed. This is not a malfunction, and the unit will recover when the temperature returns to normal.
- Do not leave the unit in a hot or cold location. Also, do not leave the unit in a location exposed to direct sunlight or near a heater, or in high humidity, as this may cause the cabinet to deform and the screen to malfunction, and affect the screen's performance .
- **Environment condition:**
 - Operating temperature: 5°C – 35°C
 - Operating humidity: 20 – 80 % (no moisture condensation)
 - Storage temperature: -15°C – 45°C
 - Storage humidity: 10 – 80 %
 - Atmospheric pressure: 86 kPa ~106 kPa

About After-Image

The extended use of fixed image program material can cause a permanent after-image on the screen.

This background image is viewable on normal programs in the form of a stationary fixed image. This type of irreversible screen deterioration can be limited by observing the following steps:

- A. Reduce the brightness/contrast setting to a minimum viewing level.
- B. Do not display the fixed image for extended periods of time.
- C. Turn the power off when not in actual use.

Important Information Regarding Use of Video Games, Computers, Captions or Other Fixed Image Displays.

- Do not allow a still picture to be displayed for an extended period, as this can cause a permanent after-image to remain on the screen.
Examples of still pictures include logos, video games, computer images, teletext and images displayed in 4:3 mode.

CAUTIONS:

- The permanent after-image on the screen resulting from fixed image use is not an operating defect and as such is not covered by the warranty.
- This product is not designed to display fixed images for extended periods of time.

Cleaning and Maintenance

To clean this unit, wipe with a soft, dry cloth.

Clean the cabinet with a soft, lint-free cloth, If the cabinet is especially dirty, moisten a soft, lint-free cloth in a weak detergent solution, squeeze the excess moisture from the cloth, then wipe the cabinet with the cloth. Use a clean cloth to dry the cabinet.

- Clean the screen with a soft, lint-free cloth.
- Use eyeglass cleaner to remove stubborn dirt from the screen.
- Never use alcohol, paint thinner or benzine to clean this unit.

Carrying or Moving the screen

- When you move the screen , hold the frame of the screen .
- Be aware of the danger or harm which may caused by carrying or moving the screen , as the bezel is very thin.
- When transporting, do not subject the unit to shocks or vibration, or excessive force.

Environmental Protection

Waste electrical products should not be disposed of with household waste. Please recycle where facilities exist. Check with your Local Authority or retailer for recycling advice.



Identification of Controls

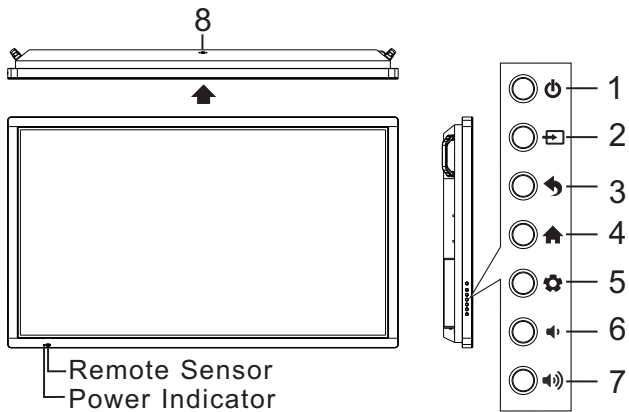

1. : Switch the screen power on or standby.
2. : Press the button to display input source menu or exit the menu screen.
3. : Press the button to return to previous menu.
4. : Press the button to display desktop (Home page) on the screen.
5. : Press the button to open the setting menu.
6. : Press the button to turn down the volume.
7. : Press the button to turn up the volume.
8. USB(2.0)(for camera): This port is connected to PC (internal OPS) , but is changed to Android if current source is AV, USB or in Home page.

Notes: 1. Please open the dust cover before being used.
2. It can perfectly support up to the 720p of camera.

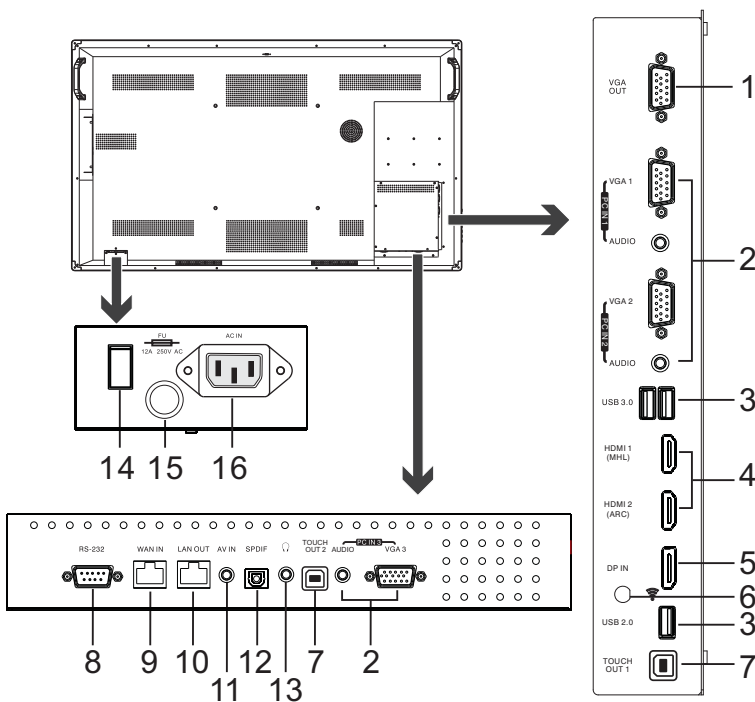

6. WIFI antenna for transmitting or receiving network signal.
7. TOUCH1/2 OUT
Output the touch for external devices connected to PCx or HDMIx port which support touch system.
Note: TOUCH OUT 2 takes precedence over TOUCH OUT 1 in default. You can define it in Lock menu.
8. RS232
For service, software upgrades and the other uses.
9. WAN IN
The built-in router input port. Connect to the external network.
10. LAN OUT
The built-in router output port. Connection to another computer or other Internet enabled devices.
11. AV IN
Connect an AV device to this jack.
12. S/PDIF digital audio output
Connect a digital sound system to this jack.
13. Connect headphones to this jack. The screen is the current audio output.
14. Power Switch
Push to (I) to connect the power, push to (O) to cut off.
15. Fuse (12A 250V)
16. AC IN
Plug the AC cord into this jack and into a power outlet.(~100-240V 50Hz/60Hz)

1. VGA OUT
The currently selected PC IN 1/2/3 signal output.
2. PC IN1/2/3
Enable connection to PC or other external devices with VGA/AUDIO ports.
3. USB2.0/3.0
Connect USB devices to these ports.
4. HDMI1/2 Input
To connect with those equipments with HDMI or DVI interface.
HDMI1(MHL): Connect an MHL - enabled device such as a cell phone to this jack to view the external device's screen on your screen.
HDMI2(ARC): Connect an ARC-enabled home theater receiver to this jack.
5. DP(DisplayPort) Input
Connect an external device to DP out jack.

Remote Control

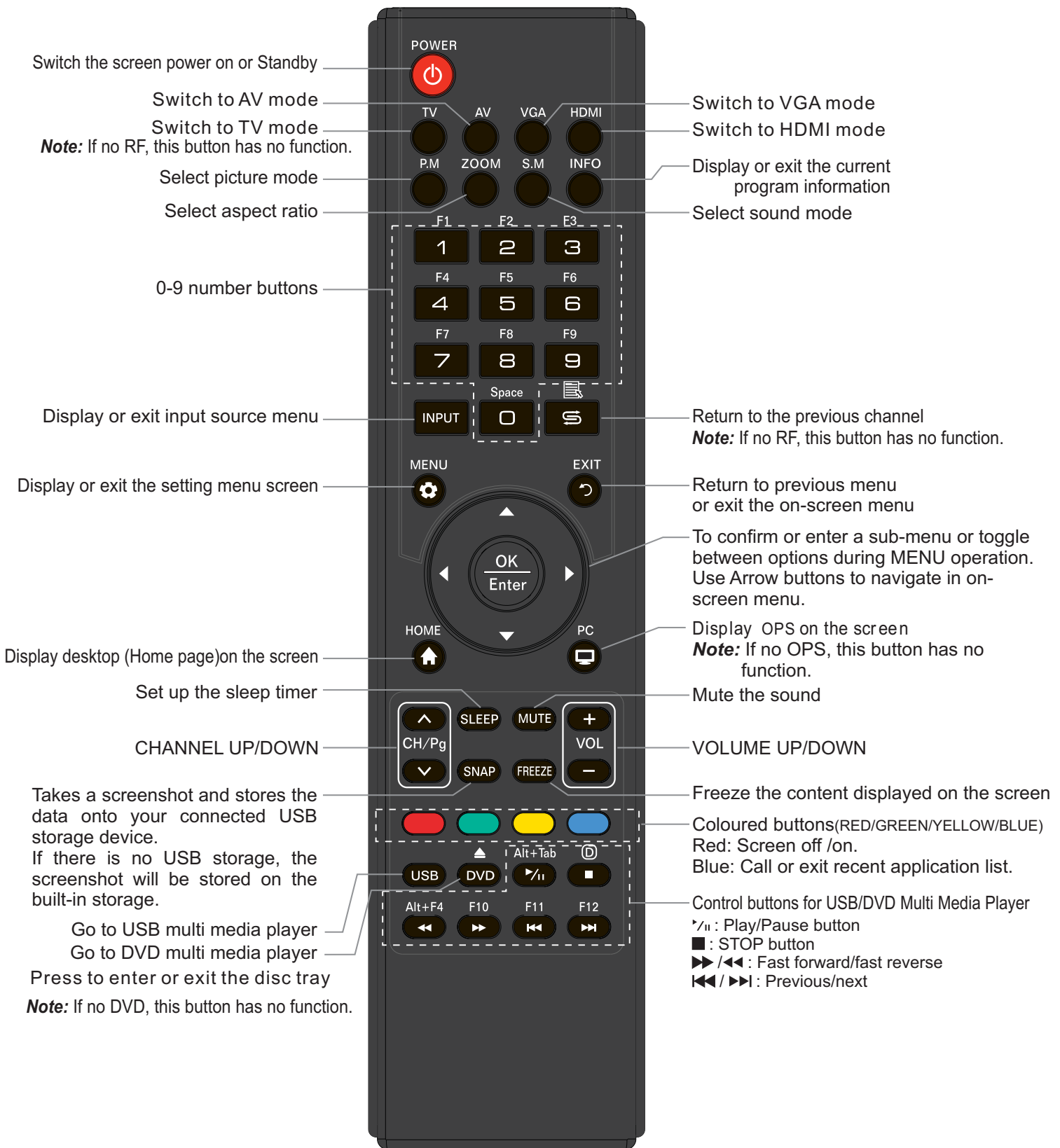

Notes:

- This operation manual provides a description based on operating functions with the remote control.
- In different mode, some buttons may have different function.

Setting Up

Installing remote control Batteries

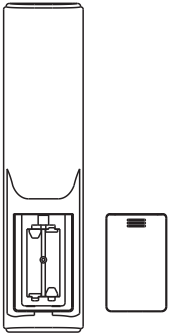

To install remote control batteries:

- 1 Open the battery cover.
- 2 Insert two AAA batteries into the battery compartment. Make sure that the + and – symbols on the batteries match the + and – symbols in the battery compartment.
- 3 Replace the cover.

Battery precautions:

Improper use of batteries can result in a leakage of chemicals and/or explosion. Be sure to follow the instructions below.

- Place batteries with their terminals corresponding to the (+) and (–) indications.
- Different types of batteries have different characteristics. Do not mix batteries of different types.
- Do not mix old and new batteries. Mixing old and new batteries can shorten the life of new batteries and/or cause old batteries to leak chemicals.
- Remove batteries as soon as they are non-operable. Chemicals that leak from batteries can cause a rash. If chemical leakage is found, wipe with a cloth.
- Dispose of batteries in a proper manner.
- If the remote control is not used for an extended period of time, remove the batteries.
- The batteries shall not be exposed to excessive heat such as sunshine, fire or the like.

Aiming the remote control

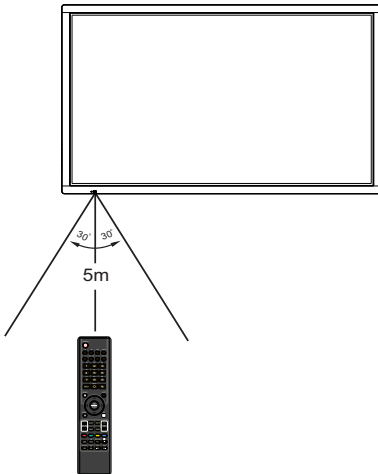

Use the remote control by pointing it towards the remote sensor on the front of your screen. Objects between the remote control and the remote sensor may prevent proper operation.

Cautions regarding use of remote control

- Do not expose the remote control to shock. In addition, do not expose the remote control to liquids, and do not place in an area with high humidity.
- Do not install or place the remote control under direct sunlight. The heat may cause deformation of the unit.
- The remote control may not work properly if the remote sensor window of the main unit is under direct sunlight or strong lighting. In such a case, change the angle of the lighting or the screen set, or operate the remote control closer to the remote sensor window.

Connections

Cautions Before Connecting

- When connecting an external device to the screen, make sure that the screen and the device are turned off.
- Check the plugs at the ends of cables to make sure that they are the correct type before you try plugging them into jacks on the screen.
- Make sure that all plugs are securely inserted into the jacks. Loose connections can result in image or color problems.
- The illustration of the external device may be different depending on your model.
- Refer to the operating manual of the external device as well.

1. Connect the female plug to the AC socket on the unit.
2. Connect the male plug to the wall outlet as illustrated.

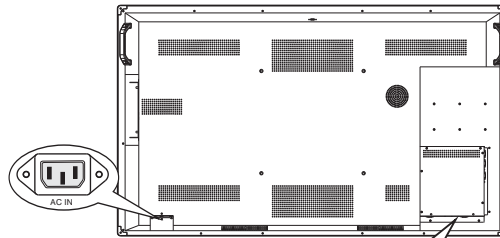

Notes:

- This product should be operated only from the type of power source indicated on the marking label.
- Always unplug the AC cord from power outlet when not using for a long period of time.

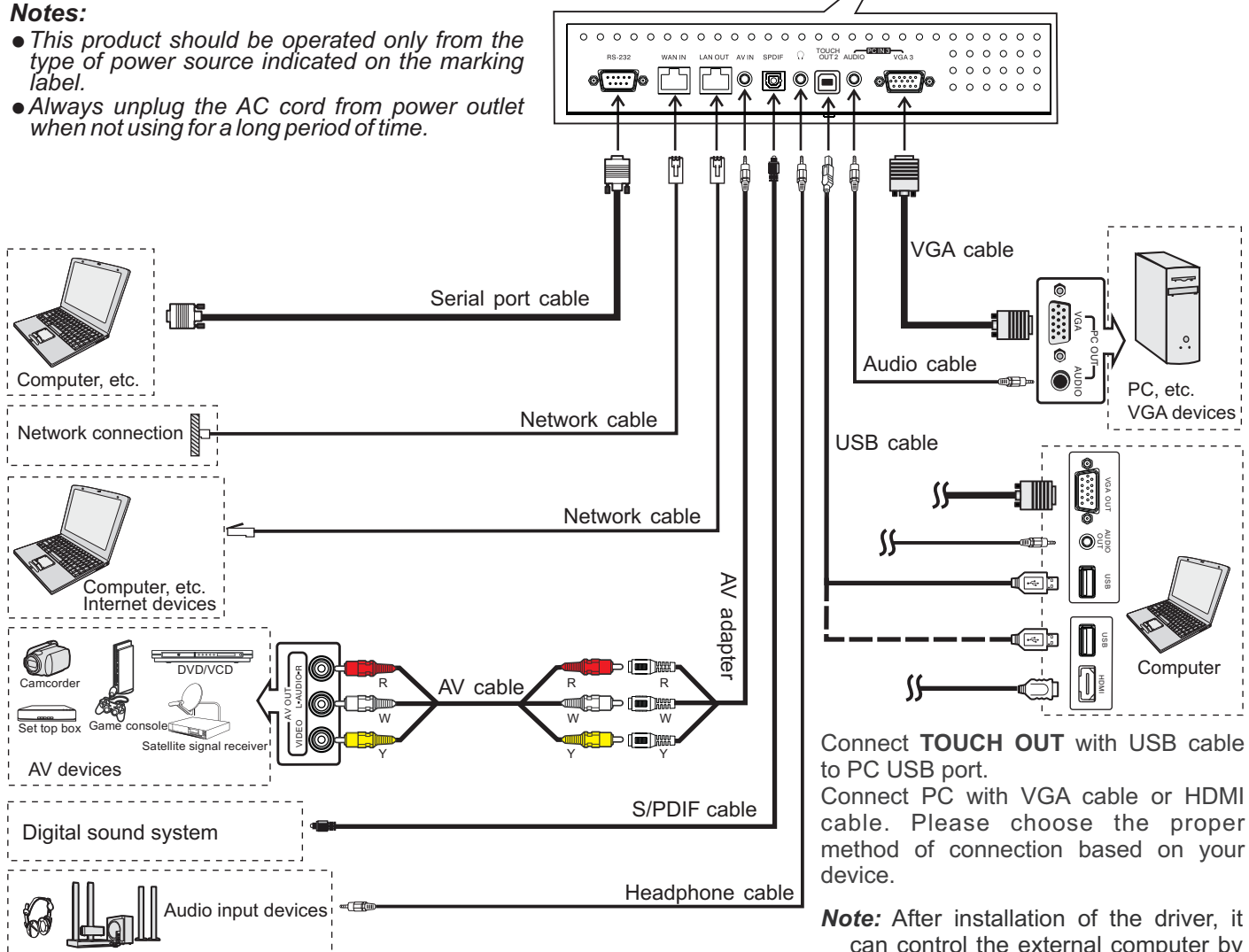

Connect **TOUCH OUT** with USB cable to PC USB port.
 Connect PC with VGA cable or HDMI cable. Please choose the proper method of connection based on your device.

Note: After installation of the driver, it can control the external computer by native touch control. (Only for PC, HDMI signal)
 TOUCH OUT 2 takes precedence over TOUCH OUT 1 in default. You can define it to in Lock menu.

Note: Before using headphones, adjust the device volume so as to avoid excessive levels, as hearing damage may result.

Connections

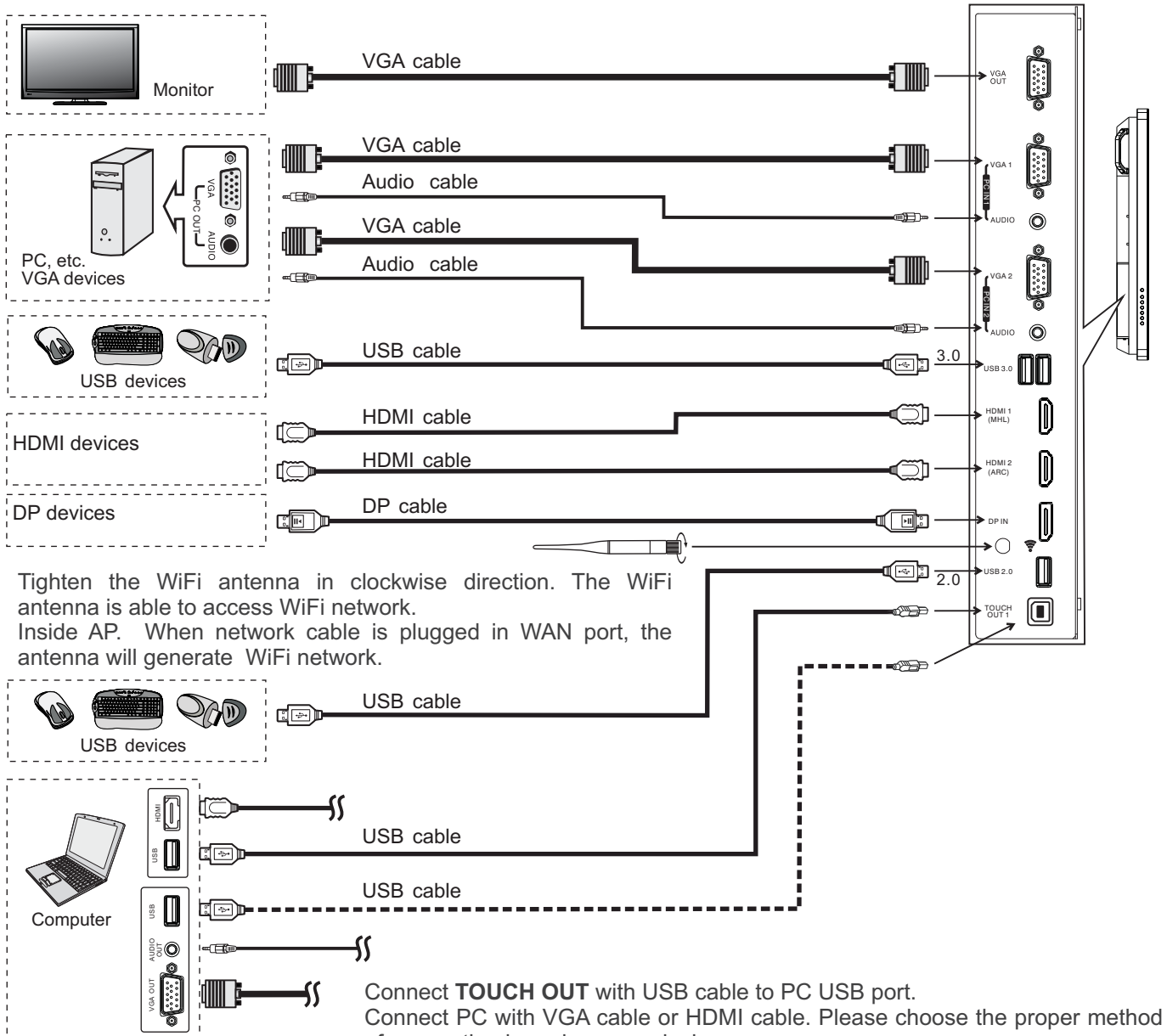



Note: After installation of the driver, it can control the external computer by native touch control. (Only for PC、HDMI signal)
TOUCH OUT 2 takes precedence over TOUCH OUT 1 in default. You can define it to in **Lock** menu

- ⚠ **Notes:** 1.The screen is multiple USB port designed(3.0, 2.0), when connect with USB device, please select the appropriate port.
2.The VGA output is signal of what has been currently selected from PC1/2/3.

Basic Operations

Turning the screen on or off

- 1 Plug the power cord into an AC Power outlet. Press **Power Switch** on the screen.
- 2 Now the screen is in standby mode. Wait a moment until the power indicator lights up, then press **POWER**  to turn on the screen. (Be sure to wait for a few seconds before pressing POWER button. If you promptly press POWER button then the screen may not respond or act wrongly.)
- 3 Press  button again to turn off the screen and put the screen in standby mode.
To cut off the power completely, press **Power Switch** on the screen.

Note: If the screen does not receive a displaying signal for a certain time, the screen goes into standby mode.

The first time installation

Connect to power source and turn on the screen, the below installation menu page will display on the screen.







Select desired menu language, then press **START** and go to next page.

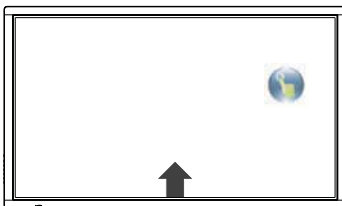

Select location and go to next page.

Operating the Float menu



1. Slide up from bottom of the screen center by two or more fingers to call  .
Press and drag  to any place of the screen.
2. Press  to take 2 seconds to be activated in VGA/HDMI/DP/PC mode.
3. When displaying at USB interface, touch once at the lower part of the screen, the display control menu will appear.

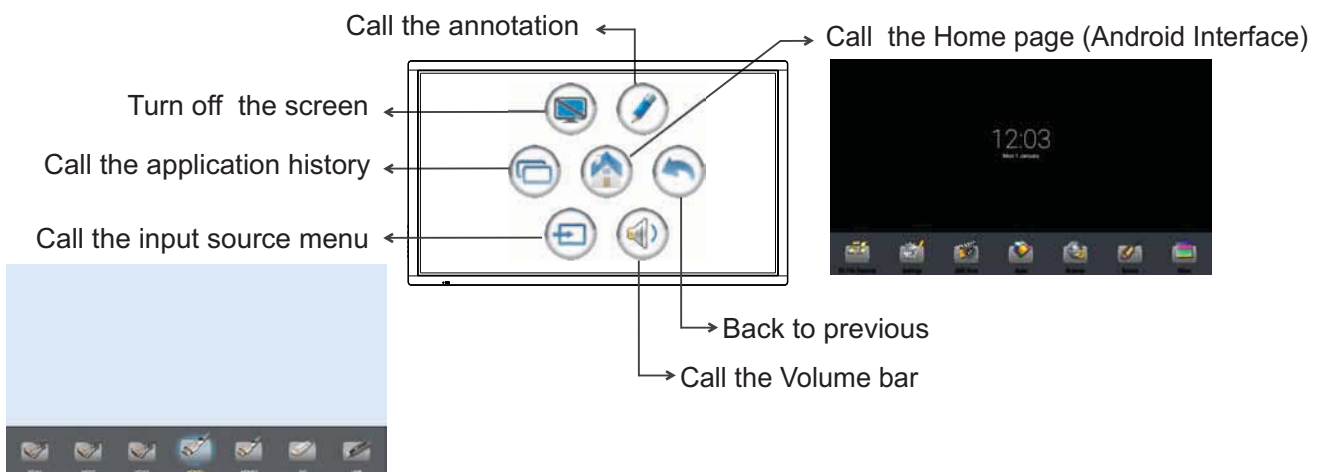

Basic Operations(Continued)

Home Menu Overview

In all applications, press and drag the icon to on Home page for shortcut created, press and drag the shortcut to **X** for shortcut deleted.

Shortcuts you created on Home page



Show all applications

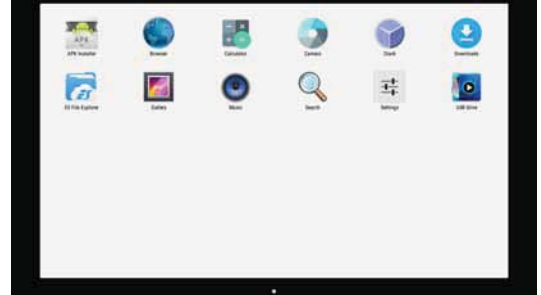

Note: When using the app Camera, store the data onto your connected USB device. If USB device is not connected, store the data onto the built-in storage.

ES File Explorer

Go to your **web Browser**

Call the device **Settings** menu

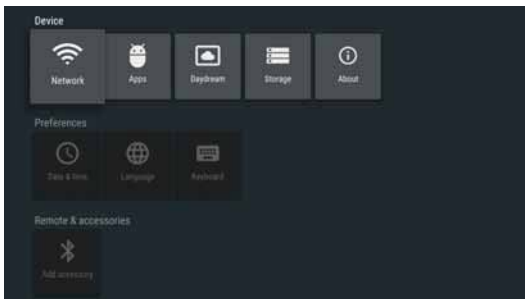

Long press on the screen will call the wallpapers and widgets menu.

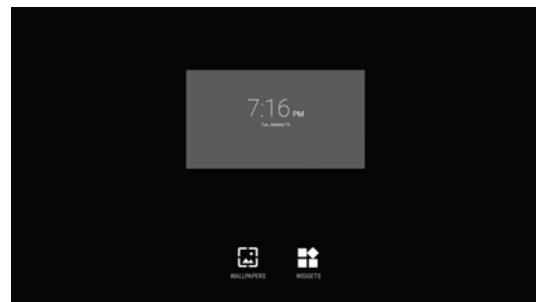

Go to your **USB Drive**.



Switch to the display menu screen



Switch to different input source, i.e. HDMI, VGA, etc.

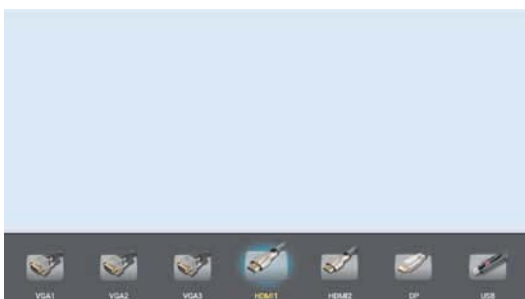

Note: The layout of menu may vary upon different models you purchased.

Device Settings



Network Setting

Show all apps

Daydream setting

Display system Storage

Display information of the unit

To set default input method
To set Android keyboard(AOSP)

To set on-screen language

To set Date and time

Note: To manually set date and time, you should toggle "Automatic Date & time" to OFF.

Automatic search for Bluetooth devices

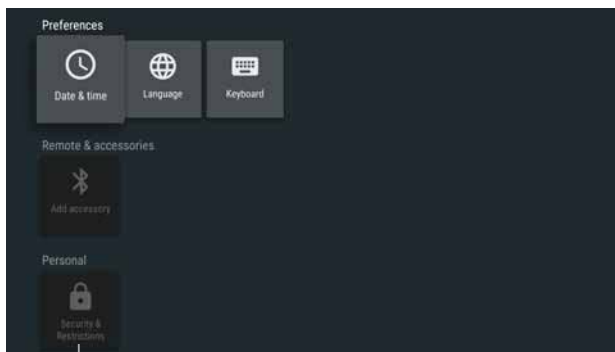

To set Security and Restrictions
Allow installation of apps from sources other than the Play Store.

Network Settings

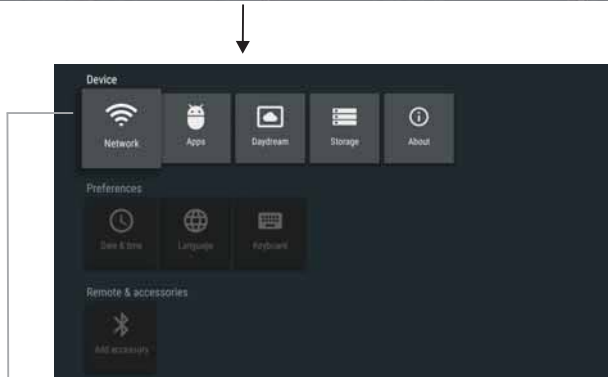

Set the Built-in WiFi



Ethernet setting



Internal routing setting



Reset Internal Router by hardware. Password is required for this operation and is the same password to access Lock menu. (The default password is 0000)

IP settings

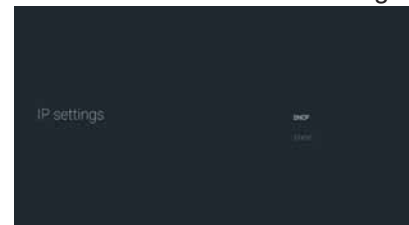

Input the default Username: **admin**, skip the default password setting as there is no default password, then press **Login** button.

Proxy settings

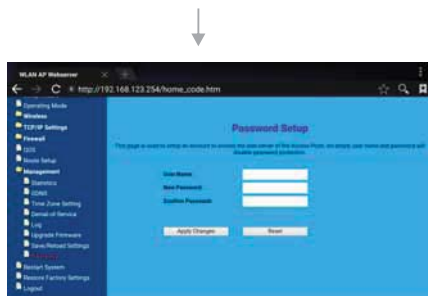
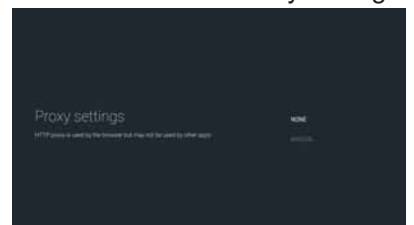

Change the Username and Password: Select **Management**, then **Password**.

Network Settings(Continued)

Wired Network Setting (Internal router)

Method 1: Easy Setup Wizard



Input the default Username: **admin**, skip the default password setting as there is no default password, then press **Login** button.



Select **Easy Setup Wizard**



Select **Gateway**

Next

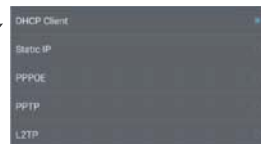

There are five methods to connect with network, choose your preferred one. Recommended to select the **DHCP Client** connection. Automatically obtain IP information from your ISP.

DHCP Client: Automatically obtain IP information from your ISP. If your ISP doesn't provide a designated IP for you, then choose DHCP Client.

Password Setting Format



Static IP: If all Internet IP information is provided by your ISP, then choose Static IP.

PPPOE: Ethernet Point to Protocol. Your ISP will provide you with Login ID and password. Usually this option is applicable to DSL service.

PPTP: Point to Point Tunneling Protocol. Your ISP will provide you with Login ID and password.

L2TP: Layer 2 Tunneling Protocol. Your ISP will provide you with Login ID and password. Usually this option is applicable to DSL service.

Finished

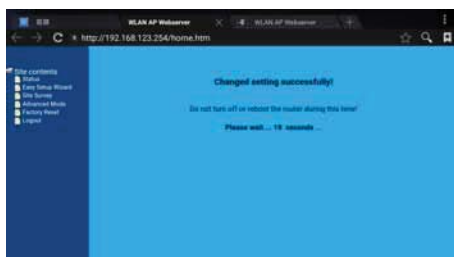

WiFi Password of Internal Router in the screen. (Password should be set at least 8 characters.)

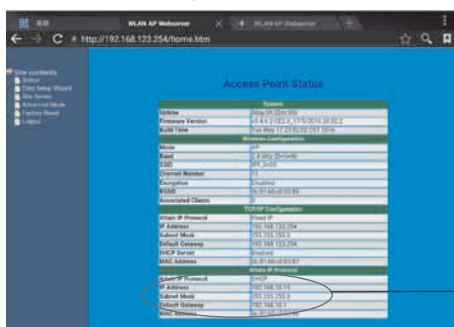

Get IP address Setting successfully

Network Settings(Continued)

Wired Network Setting (Internal router)

Method 2: Advanced Mode

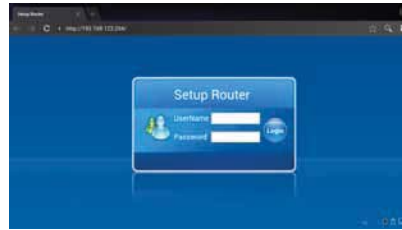

Input the default Username: **admin**, skip the default password setting as there is no default password, then press **Login** button.

Select **Setup Wizard**



Select **Advanced Mode**



Next



Select **Gateway**
Next



Next

Recommended to select **AP**



Next

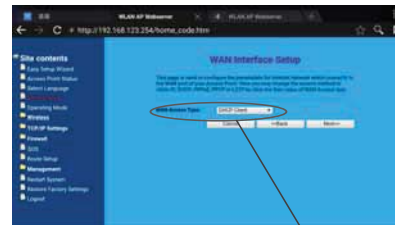

Next



Next



Password Setting Format



WiFi Password of Internal Router in the screen. (Password should be set at least 8 characters.)

There are five methods to connect with network, choose your preferred one. Recommended to select the **DHCP Client** connection. Automatically obtain IP information from your ISP.

Finished



Next

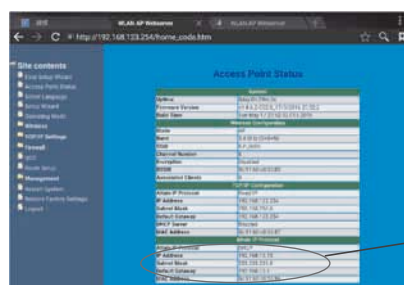

Get IP address Setting successfully

Network Settings(Continued)

Wireless Network Setting (Internal router)

Method 1: Easy Setup Wizard



Input the default Username: **admin**, skip the default password setting as there is no default password, then press **Login** button.

Select **Wireless ISP**
Next



Select **Easy Setup Wizard**

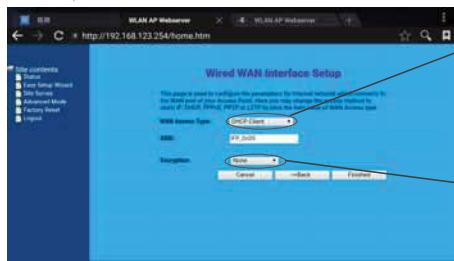

There are five methods to connect with network, choose your preferred one. Recommended to select the **DHCP Client** connection. Automatically obtain IP information from your ISP.

Password Setting Format



WiFi Password of Internal Router in the screen. (Password should be set at least 8 characters.)

Finished

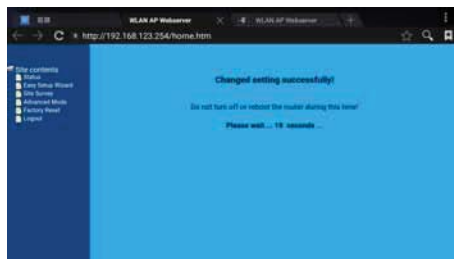

Successfully connected to return.
Select **Site Survey**

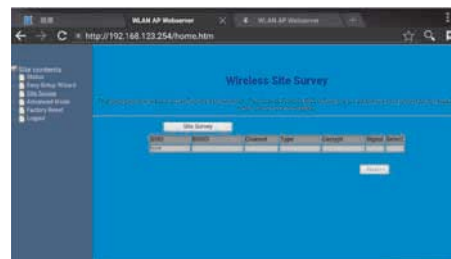

Confirm **Site Survey**

Input Password
Connect



Select your desired WiFi signal.

Next

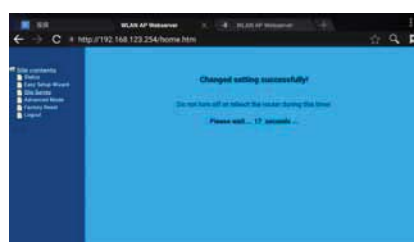

Get IP address
Setting successfully

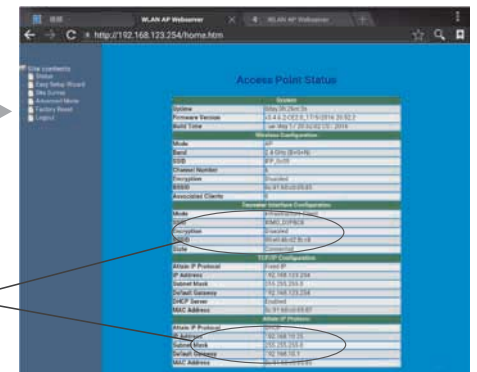

Network Settings(Continued)

Wireless Network Setting (Internal router)

Method 2: Advanced mode

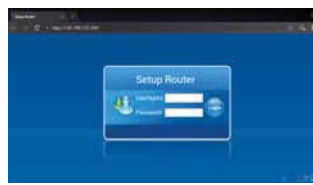

Input the default Username: **admin**, skip the default password setting as there is no default password, then press **Login** button.



Select Advanced Mode ↓

Select Wireless ISP



Next



Select Setup Wizard



Next



Next



Password Setting Format. Wi-Fi Password of Internal Router in the screen. (Password should be set at least 8 characters.)



There are five methods to connect with network, choose your preferred one. Recommended to select the **DHCP Client** connection. Automatically obtain IP information from your ISP.

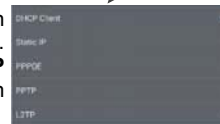

Next



Successfully connected, return to Site contents.

Finished



Next



Recommended to select **AP**



Select **Wireless**, then **Site Survey**.



Confirm Site Survey



Select your desired WiFi signal. ↓



Input Password Connect

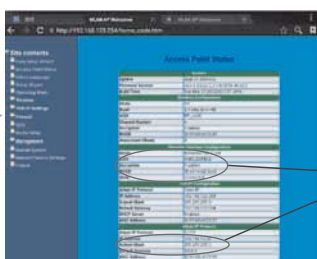
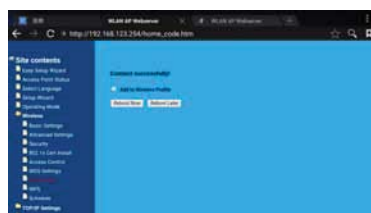

Get IP address Setting successfully

Network Settings(Continued)

Wireless Network Setting (Built-in WiFi card)

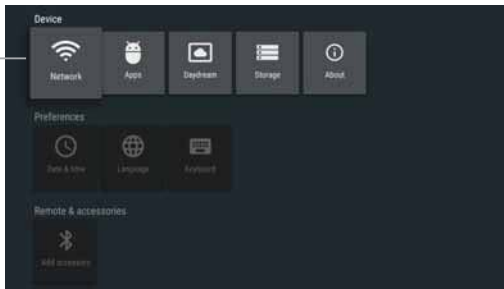

Turn on or off the built-in WiFi

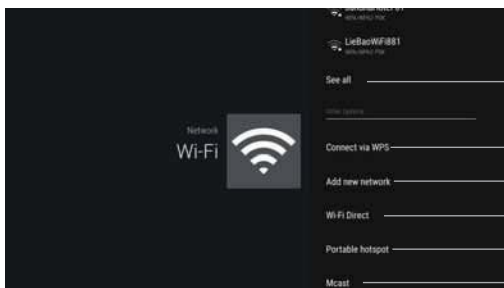

Display all of the WiFi sites available

Connect to WPS (WiFi Protected Setup) router

Add a new network manually

Scanning WiFi direct device

Setting Portable WiFi hotspot

Setting Mcast

Menu List

Adjusting Picture mode



Picture	Picture Mode	Select your favourite picture mode for each input [Standard] / [Soft] / [User] / [Game] / [Writing] / [Dynamic] .
	Contrast	Adjust the contrast.
	Brightness	Adjust the brightness.
	Hue	Adjust the image hue. (Only for NTSC system)
	Sharpness	Adjust the sharpness.
	Saturation	Adjust the color saturation.
	Backlight	Set up the overall brilliance of the screen.
	Energy Save	The backlight brightness is decreased.
Screen	Clock	Adjust the screen size.
	Phase	Adjust the focus of stable images.
	H-Position	Move the image right or left.
	V-Position	Move the image up or down.
	Auto Adjust	Automatically adjust the image settings such as position and phase.
Color Temperature	Select the color temperature. If you select User , you can set the level of the Red/Green/Blue as your desired.	
Zoom Mode	Select the aspect ratio (display proportions) according to your video signal type or personal preference.	
OverScan	Adjust the reproduction ratio, you may activate this function to obtain a cleaner picture.	
MFC	Frame rate up conversion. (Only for 4K model.)	
Image NR	Turn on/off the noise reduction mode to reduce picture noise.	

Adjusting Sound mode



Sound	Sound Mode	Select your favourite sound mode for each input [Standard] / [Music] / [Movie] / [Sports] / [User] .
	Bass	Adjust Bass (low sounds) .
	Treble	Adjust Treble (high sounds).
	Balance	Adjust volume level of right and left speakers.
	AVC	Select [On] to equalize overall volume levels across all channels. Select [Off] to turn off the auto volume control.
	Surround	Turn the Surround sound effect on or off.
	SPDIF Output (digital signal only)	Select the digital audio output mode for S/PDIF. Select [RAW] to output audio signal as its original format. Select [PCM] to output audio signal by PCM format.
	SPDIF Volume	Adjust SPDIF volume.
	Alone	Turn off the picture on your monitor and listen to the program audio only. Wake up by any key or touch with two or more fingers.

Menu List

Adjusting Setting menu



Setting	Source Auto Switch	Select On to automatically recognition source.
	Color Range	Select color range. (Only for HDMI mode)
	MHL Auto Switch	Select On to automatically switch to the MHL input when it connected.
	HDMI_ARC	Select On to turn on enable HDMI_ARC.
	Movie Mode	Turn on/off the movie mode.
	Menu Timeout	Select OSD menu display time.
	Date / Time	Display Date and Time.
	Off Timer	Set Off timer to switch the screen to standby at a specified time.
	On Timer	Set On timer to turn on the screen automatically to source at a certain time.
	Sleep Time	Set the duration of time until the screen automatically goes into Standby mode. [Off] / [10 Minutes] / [20 Minutes] / [30 Minutes] / [60 Minutes] / [90 Minutes] / [120 Minutes] / [180 Minutes] / [240 Minutes].

Adjusting Lock menu



The default password is 0000.

Lock	Lock System	Select Off to in the Lock System menu to unlock it. Select Lock Touch to disable the function of the touch panel.	
	Float Menu	Turn on/off the float menu display.	
	F.M Auto Off	Enable the float menu auto off if there is no activity for 15 secs or not.	
	Set Password	Password settings.	
	Change Logo	Set logo Note: Before setting the logo, save the logo picture (should be "JPEG" format and size <512KByte) you want to use on root of USB disk and named "boot0.jpg". Insert the USB disk into the USB port on the Android board.	
	Power on Source	Power on Source Setting, in MEMORY mode, when the totem powered on, it will automatically switch to the source when it powered off last time. otherwise, it is in setting mode.	
	Power on Volume	Power on Volume Setting. In Memory mode, when the totem powered on, volume will same as the power off.	
	Volume Settings	In Settings mode, every time the totem turns on, volume is the value of this setting.	
	InputLabel	Source	Select the input source you want to label.
		Label	Edit the label of the selected input source.
		Reset	Reset labels to defaults.
	TouchOut1 To	TouchOut is there to define which touch signal output belong to which input. E.g. If TouchOut1 is set to VGA1 it means the touch signal output from TouchOut1 belongs to the input from VGA1. When both ports are connected TouchOut2 has priority by default.	
	TouchOut2 To		
	Wake up by gesture	Select On to enable two or more fingers touch the bottom of the screen and drag upward to turn on the totem when the totem is in standby mode.	
	Restore To Default	Reset all settings to factory defaults.	

Using USB Multi Media Player

Using USB multi media player

You can connect a USB storage device to your screen to view compatible photo, movie or play compatible music so that the sound can be output from the screen's speaker.

To use USB multi media player, please go to USB source by pressing **USB** button. Or you can press **Home** button to display Home Page and then select **USBDrive** icon to access.

Notes:

- Never remove the USB storage device or turn off the screen while using the USB storage device.
- It is recommended that you back up your USB device data.
- Your screens USB menu may look different to the interface shown in this manual.
- If you want to pull out the USB device, please exit USB mode first. For instructions on using your USB device, refer to the user's manual of your USB device.
- Please name your files in English. Otherwise the file names can not be shown correctly.
- Certain types of USB device may not be compatible with this screen.

USB multi media interface introduction

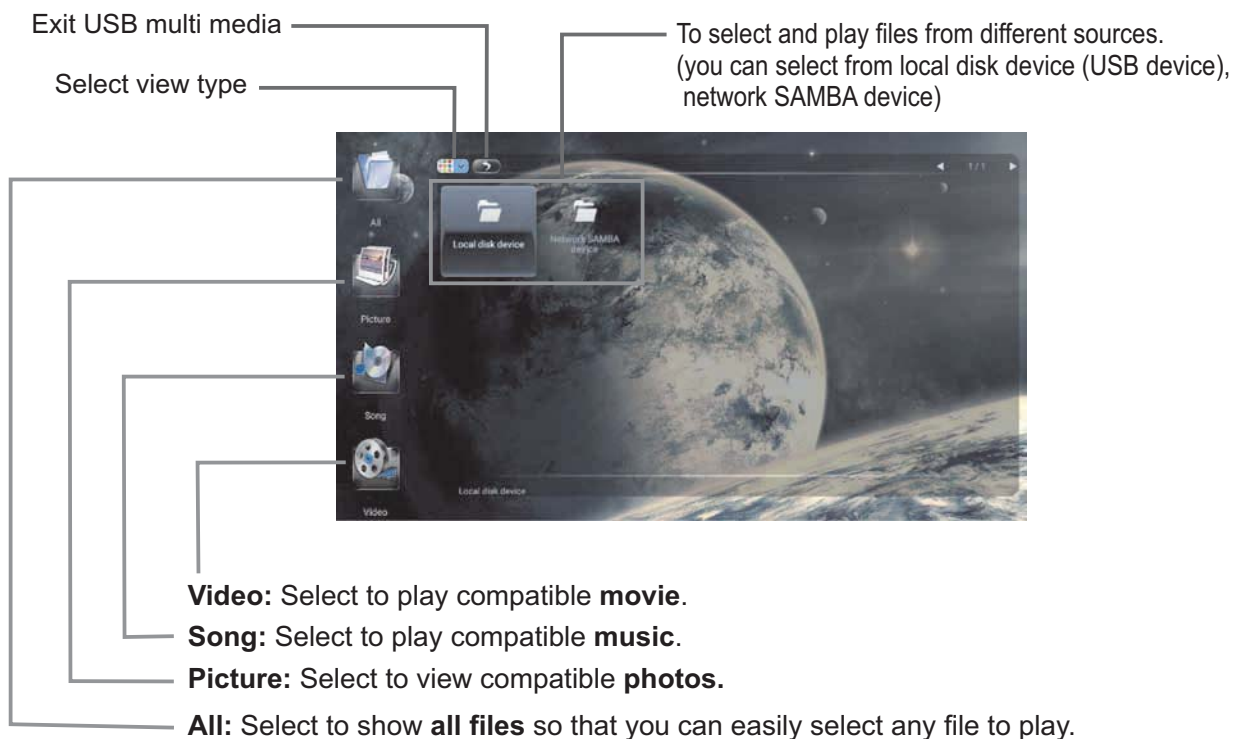

Using USB Multi Media Player

Playing Photo

With the photo viewer, you can view compatible photos (in JPG, BMP or PNG format). Also you can zoom, rotate photo, etc.



- Previous photo
- Play/pause
- Next photo
- Zoom in
- Zoom out
- Show information
- Rotate clockwise
- Rotate anti-clockwise

Note: You can also use $\blacktriangleleft/\text{II}$ (Play/Pause), \blacksquare (STOP), $\blacktriangleleft\blacktriangleleft$ (Previous), $\blacktriangleright\blacktriangleright$ (Next) on the remote control to operate.

Playing Music

With the USB music player, you can play compatible music (in MP3 or AAC format).



- Previous song
- Pause/Play
- Next song
- Repeat mode select
- Show information
- Show playlist

repeat to play single music, repeat to play all music files in current folder when it plays to the end, no repeat when it plays to the end.

Note: You can also use $\blacktriangleleft/\text{II}$ (Play/Pause), \blacksquare (STOP), $\blacktriangleleft\blacktriangleleft$ (Previous), $\blacktriangleright\blacktriangleright$ (Next) on the remote control to operate.

Using USB Multi Media Player

Playing Movie

With the USB movie player, you can play compatible movie (in AVI, MPG, MPEG, DAT, MP4, TS, RM/RMVB, or MKV/MOV format).

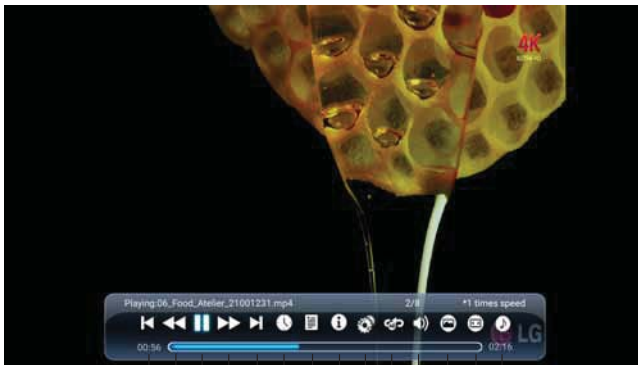

Previous movie

Fast reverse

Play/pause

Fast forward

Next movie

Skip to specific point
by input time

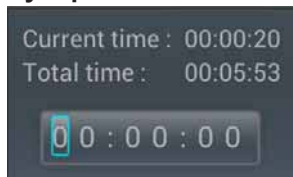

Show playlist

Show information

Select sound mode

Select aspect ratio

Select picture mode

Adjust the volume

AB Section repeat

Playing settings

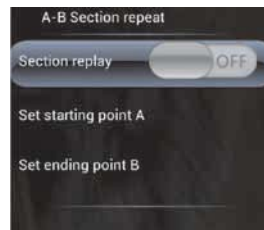

Now AB repeat starts. To cancel, highlight **Section replay** and toggle it to **OFF**.

Troubleshooting

If, after reading these operating instructions, you have additional questions related to the use of your screen, please call the services center in your local area.

Before calling service, please check the symptoms and follow suggested solutions.

Remote Control

<i>Problem</i>	<i>Possible Solutions</i>
Remote control does not operate	<ul style="list-style-type: none">• The batteries could be weak. Replace the batteries.• Check the orientation of the batteries.• Make sure the power cord is plugged in.

Video and Audio

<i>Problem</i>	<i>Possible Solutions</i>
No picture (screen not lit), No sound	<ul style="list-style-type: none">• Make sure the power cord is plugged in.• Press POWER on the screen or on the remote control.
Dark, poor or no picture (screen lit), good sound	<ul style="list-style-type: none">• Select a proper picture mode.• Adjust the brightness in the video setting.
No color/dark picture/abnormal color	<ul style="list-style-type: none">• Adjust the color saturation in the video setting.
Good picture, no sound	<ul style="list-style-type: none">• The sound may be muted. Press MUTE again to cancel.
Audio noise	<ul style="list-style-type: none">• Communication problems may occur if infrared communication equipment (e.g., infrared cordless headphones) is used near the screen. Move the infrared communication equipment away from the screen until the noise is eliminated.

General

<i>Problem</i>	<i>Possible Solutions</i>
Some items can't be accessed	<ul style="list-style-type: none">• If a setting option appears in gray, this indicates that the settings option is unavailable in current input mode.
Effect pressed on the remote control is not applied.	<ul style="list-style-type: none">• When the screen is detecting attached USB devices or when you initially plug in a USB device the screen may not respond to the remote control, please wait for a few moments then try again.
POWER button responds slowly after power is connected.	<ul style="list-style-type: none">• When you push POWER SWITCH to power on the screen, in about 3 seconds the POWER button starts to respond after pressed.

Note: If your problem is not solved, turn your unit off and then on again.

Cautions: Never attempt to repair a defective screen yourself.

Specifications

Power Source		AC 100-240 V, 50 / 60 Hz		
Power Consumption	Current Max.	2.8 A	5.2 A	6.5 A
	Standby condition*	< 0.5 W	< 0.5 W	< 0.5 W
Display panel	Number of pixels	1,920 (W) × 1,080 (H)	3,840 (W) × 2,160 (H)	3,840 (W) × 2,160 (H)
	Visible screen size	65 inches(diagonal)	75 inches(diagonal)	86 inches(diagonal)
Dimensions (W × D × H) Unit: mm		1527 X 113.7 X 903	1749 X 105.3 X 1029	2007 X 125 X 1179
Mass		54 kg Net	86 kg Net	115 kg Net
Operating conditions		Operating temperature: 5°C - 35°C , Storage temperature: -15°C - 45°C, Operating humidity: 20 % - 80 % (no moisture condensation), Storage humidity: 10% - 80%, Atmospheric pressure: 86kPa ~ 106kPa		
Connection terminals of the screen	AV IN	1	1	1
	PC IN	3	3	3
	VGA OUT	1	1	1
	HDMI Input	2	2	2
	DP Input	1	1	1
	USB	4	4	4
	WAN IN	1	1	1
	LAN OUT	1	1	1
	S/PDIF OUT	1	1	1
	Headphone	1	1	1
	RS232	1	1	1
TOUCH OUT	2	2	2	

Notes:

1. Design and specifications are subject to change without notice.
 2. Weight and dimensions shown are approximate.
 3. Specifications and external appearance may be changed for the sake of improvement.
- * Due to different standby conditions, the standby power consumption of some models could be higher than 0.5W.



The terms HDMI and HDMI High-Definition Multimedia Interface, and the HDMI Logo are trademarks or registered trademarks of HDMI Licensing LLC in the United States and other countries.